



# SHOW PROGRAMS 1982-1990

Duncan PAL Center appreciates  
the support of EST. Particular  
thanks to Curt Dempster, Creative  
Director and David Rosenak,  
Producing Director.

Special Thanks to Theresa  
Elwert, Laurie Hirschman and  
Nancy Lawrence who provided  
warm rehearsal space when  
Duncan PAL had none.

PAL

AT

EST  
II

December 22nd & 23rd, 1982

# "DANCES OF THE ANCIENT EARTH"

an Improvisational dance

Music by George Crumb  
Voices of Ancient Children

## The Cast

Kim Raccioppi	Raymond Ramos
Jennifer Flynn	Evelyn Hynes
Raquel Alexander	

Hernando Contreras  
Dance Instructor

## Technical Staff for Tonight's Performance

Director	Willie Reale
Asst. Director	Jane Perkins
Costume Designer	Suki Aronoff
Lighting Design	Geoffrey Dunbar
Lighting Technician	Paul Reale
Sound Design	Russell Fager
Sound Technician	Rob Reale
Sets and Props	Chris Cerascu
	Rachel Potash

# "CHRISTMAS DREAMS"

written and directed by  
WILLIE REALE

## The Players

Deneka Penniston  
Millard Corbett  
Carrie Grote  
Michelle Alvarez  
Rene Alvarez  
Marta Rojas  
Domingo Rojas  
Henry Rojas  
Kim Raccioppi  
Carla Buiza

Michelle Vargas  
Evelyn Hynes  
George Hynes  
Raymond Ramos  
Yohany Gonzalez  
Awilda Gonzalez  
Yolanda Gonzalez  
Jackie Mopango  
Tete Mopango  
Raquel Alexander

## Special Appearances by

JANE HOFFMAN  
CARLA MEADOWS  
SANTA CLAUS

We gratefully acknowledge the  
kind support of the following  
people:

Ben Fowler

Carol Bokun

Curt Dempster

Teresa Elwert

Judith Morgan

Nancy Lawrence

The Irish Arts Center

Sunny Bates

Scott Campbell

The Maverick Group

Sonny's Self-Service

Police Athletic League, Inc.

The Further  
Adventures  
of



Nick T. Maker

THE GROWNUPS

Writer/Director. . . . . Willie Reale  
\*Asst. Director. . . . . Amy Benesh  
Lighting Designer. . . . . Geoffrey Dunbar  
Costume Designer. . . . . Pam Penenberg  
Production Stage Manager. . . Peter Weicker  
Piano Player. . . . . Lee Lowenfish  
Set Graphics. . . . . Ralph Shultz  
Electrician. . . . . Matt Shanon  
Running Crew. . . . . Minna Rose  
  Milard Corbett  
  Jaime DeLorenzo  
Still Photographer. . . . . Gil Gilbert  
Program Cover. . . . . Geneva Kellam  
Press Agent. . . . . Bruce Cohen  
Flyers. . . . . Ken Ning Chin

\*Ms. Benesh was furnished through the generosity of the Youth Board and The Theater for the Forgotten.

THE KIDS

Nick T. Maker. . . . . George Hynes  
Muriel. . . . . Deneka Peniston  
Candy. . . . . Tanya Mosher  
Tootsie Foote. . . . . Cara Shultz  
Oil Can Harry. . . . . Robert Dugan  
Chuck Steak. . . . . Henry Rojas  
The Satin Latin. . . . . Domingo Rojas  
Rosie. . . . . Maria Rojas  
Amanda. . . . . Jackie Mapango  
Miranda. . . . . Tete Mapango  
Pete the Butcher. . . . . John Downey  
Knuckles. . . . . Osvaldo Fineo  
Della. . . . . Evelyn Hynes  
Bunny. . . . . April Milton  
Carmen. . . . . Awilda Gonzalez  
Brenda. . . . . Yohanny Gonzalez

PRODUCTION

Scenery by.....ANNE PATTERSON

Volunteers.....AMY BENESCH

MAUREEN GRADY

MARY GREY

LAURA HUGHES

JUDY PREMUS

Special thanks to.....BRUCE COHEN

JOHN COLE

DAVE SMITH

LIA VOLLACK

A NOTE

Funding for tonight's program has not yet been found. If you or anyone you know can help, please contact Willie after the show. Thank you.

MINI THON  
'84  
N

NO SUCH THING AS AN EASY OUT

Written and directed by WILLIE REALE

THE CAST

Bennie ..... GEORGE HYNES

Bennie's father ..... BILL WISE

Time: Now

Place: A suburban Little League field

RECESS

Written by CHRIS CERASO

Directed by CARLA MEADOWS

THE CAST

Girls against the wall.....JACKIE MAPANGO  
TETE MAPANGO

Karate Man .....SAMIR VURAL

Break Dancers.....JOHN DOWNEY  
EVELYN HYNES  
JACOB THOMAS  
JOHN THOMAS

Rope Jumpers.....KERRY MARSH  
PAULA MYRIE  
CARA SHULTZ

Time: Recess

Place: Schoolyard

THE TWILIGHT COWBOY

Written by KATHARINE LONG

Directed by WILLIE REALE

THE CAST

Brenda.....CARA SHULTZ

Nell.....PAULA MYRIE

Frankie.....JOSE SOTO

Marie.....RACHELLE ROMERO

Lorna.....KERRY MARSH

Ralph.....SAMIR VURAL

Joe.....JOHN THOMAS

Sam.....JACOB THOMAS

Billy.....DOMINGO ROJOS

Twilight Cowboy.....SCOTT HEID

Time: Unknown

Place: Your guess

FIRE AT GRACIE MANSION

Written and directed by WILLIE REALE

THE CAST

Chief.....GEORGE HYNES

Fireboys.....BRIAN DOWNEY  
JOHN DOWNEY

Firegirls.....EVELYN HYNES  
JACKIE MAPANGO  
TETE MAPANGO  
DENEKA PENISTON

A mayor.....SAMIR VURAL

Time: A week from next Tuesday

Place: New York City

This project is a cooperative between the PAL-ACD  
Afterschool Program and the Ensemble Studio Theatre.  
It is in its fourth year and runs on almost no  
money.

SPECIAL THANKS TO:

Paul, Ann, and Tom Reale, Ferco Inc., Marvin's Place,  
Ann Combs, Al Marbly, Gloria Searson, Marsue Cumming,  
Paul McCrane, Wayne Washington, Ted Altschuler, Neal  
Twitchell, Ennals Berl, Dave Smith, Bruce Cohen,  
Kathleen Von Schmid, Pat Hurley, Dave Marsh ...  
AND ESPECIALLY WESTERFIELD/QUITT PRODUCTIONS LTD.

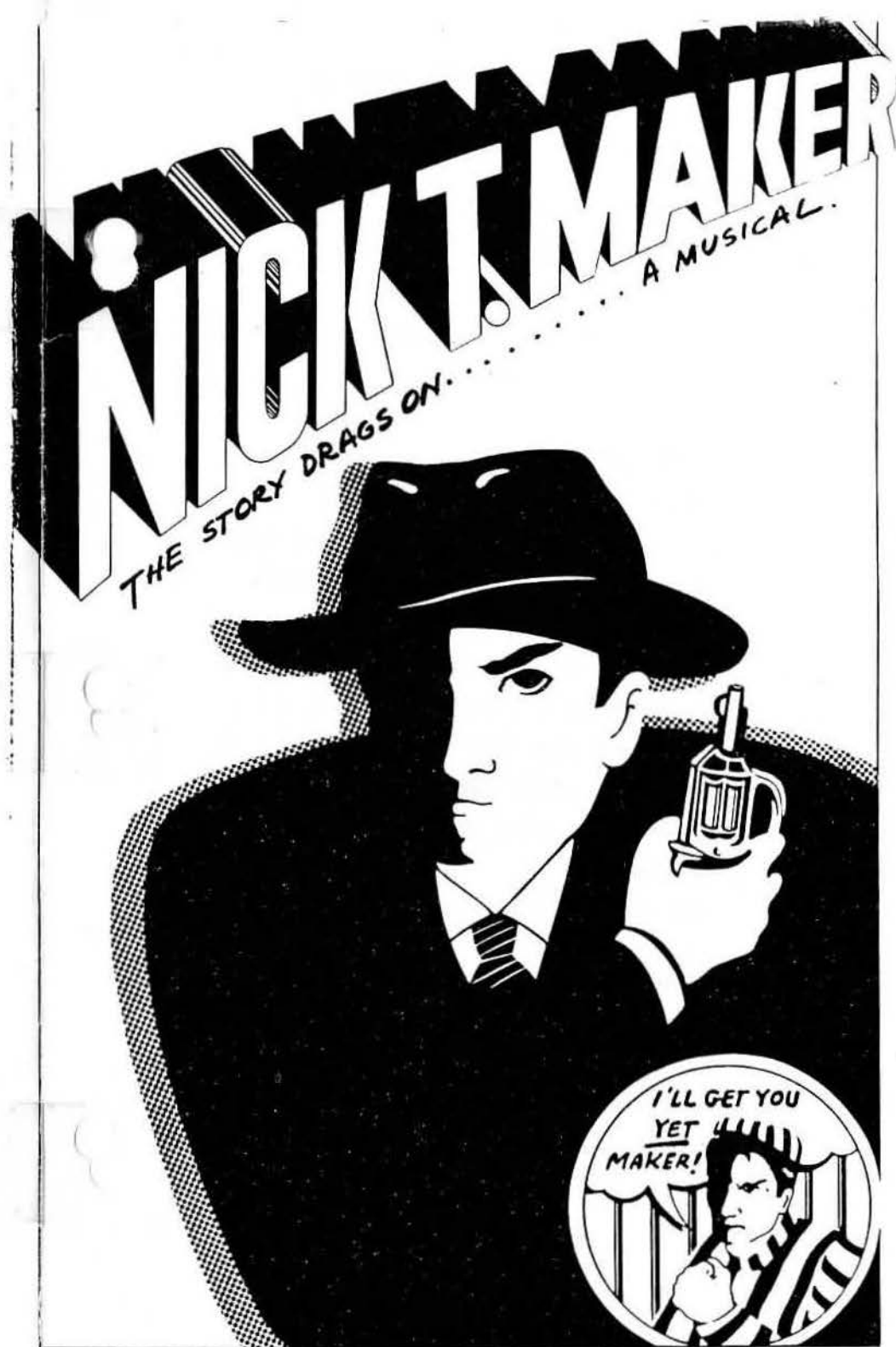



NICK T. MAKER ... ( THE STORY DRAGS ON)

Directed by

Willie Reale

Book and Lyrics by

Willie Reale

Composed and Arranged by

Rob Reale

Choreography ..... Margie Castleman  
Costumes ..... Pam Penenberg  
Sets ..... Anne Patterson  
Lighting ..... Jeoffrey Dunbar  
Graphic Design ..... Iris Brown  
Special Effects ..... Kevin O'Shea  
Stage Manager & G.P. .... Lee Costello  
Assistant Director ..... Janet Busser  
Assistant Stage Manager.. Dina Janis  
Production Assistant .... Joe Giardina  
Carpentry ..... Matt Palmieri  
Shooshers ..... Minna Rose, Anne  
Combs, Paul McCrane  
  
Piano ..... Tom Finklea  
Bass ..... Rick Vanloon  
Drums ..... Jim Harrington  
Guitar ..... Rob Reale

LIST OF MUSICAL NUMBERS

OVERTURE

DOING TIME

Waitresses, Cooks & Criminals

MAKE A BUCK MFDLEY

Chuck Steak, Pete the Butcher,  
Oil Can Harry, Doc Practise, Sam  
Clam, Satin Latin & Al Dente

WAITIN'

Waitresses

IT ISN'T YOU

Oil Can Harry

WIDOWS' SONG

Widows

LADY IN WAITING

Marta Tack

PRISON BREAK

Guards

(I'D LIKE TO LIKE) SOMEONE LIKE YOU  
Nick and Muriel

PICTURE PERFECT/CHANGE OF HEART

Oil Can Harry

FINALE

Company

CAST  
(in order of appearance)

Waitresses .....	Mandy Moresco
	Evelyn Hynes
	Stacy Mallay
Patsy Foote .....	Cara Shultz
<u>Cooks</u>	
Amanda .....	Melana Davis
Miranda .....	Cindy Davis
Lyn Guini .....	Carmen Torres
<u>Criminals</u>	
Pete the Butcher .....	John Downey
Chuck Steak .....	Brian Downey
Doctor Mel Practise .....	Raymond Ramos
Oil Can Harry .....	Robert Dugan
Al Dente .....	Elmer Torres
Satin Latin .....	Rene Alverez
Sam Clam .....	Gerard Brown
<u>Other</u>	
Nick T. Maker .....	George Hynes
His Assistant, Muriel ....	Deneka Peniston
Governor Ken B. Bought ...	Carl Winston
Referee .....	Nelson Delacruz
Widows .....	Henryetta Bowe
	Rachelle Romero
	Shannon Marsh
	Kerry Marsh
	Latanya Godfrey
	Angela Nigro
	Joann Nigro
	Melissa Davis
	Erika Funtow
	Michelle Lefebvre
Marta Tack .....	Paula Myrie
<u>Guards</u>	
Lieutenant .....	Ramik Nichols
Warden .....	Jose Soto
Captain .....	Scott Heid
Guard .....	Mike Padilla
Guard .....	Kwesi Thomas

DONORS:

Andre Bishop  
Mrs. Lorraine Brown  
John Stafford Lyons  
Jane Hoffman  
Francis N. Levy  
Barnard Hughes and Helen Stenborg  
Bruce and Mary Fiedorek  
Michael Moroney  
Walter and Donna Wick  
Dion S. Birney  
Heidi and Rocco Landesman  
Wendy Wasserstein  
Bobby Geisler  
Roger Peters  
Polly Adams  
Amy Introcaso  
The Altman Foundation  
The Ettingers  
The Reales  
John and Katherine Errett  
The Maverick Group  
Richard Grusin  
Peter Andrews and Special Teams  
Peter Gilbert

SPECIAL THANKS TO:

Shel Silverstein, Robert Tompkins, Wendy Ettinger,  
Barbara Ettinger, Carlos Sullivan, Iris Brown,  
Dave Smith, Kevin O'Shea, Tom Reale, Lucy Harrup,  
Russ Pennington, Patty Vamvoukakis, Eric Murkoff,  
Tracy Thorne, Jackie Reingold, Jim and all the guys  
at AVCOM, Gary Hartman, John Ryan, Jamie Landi,  
Pat Hurley, Arthur Bonnelle, Bruce Cohen, Rhonda, Ron,  
Kathleen von Schmid, Karen Rosa, Ronald and Phyllis  
Weiner, Laura Hughes, Billy Fritzky, Bobby Fritzky,  
Bill Murray (the one who is the printer) and the  
clam

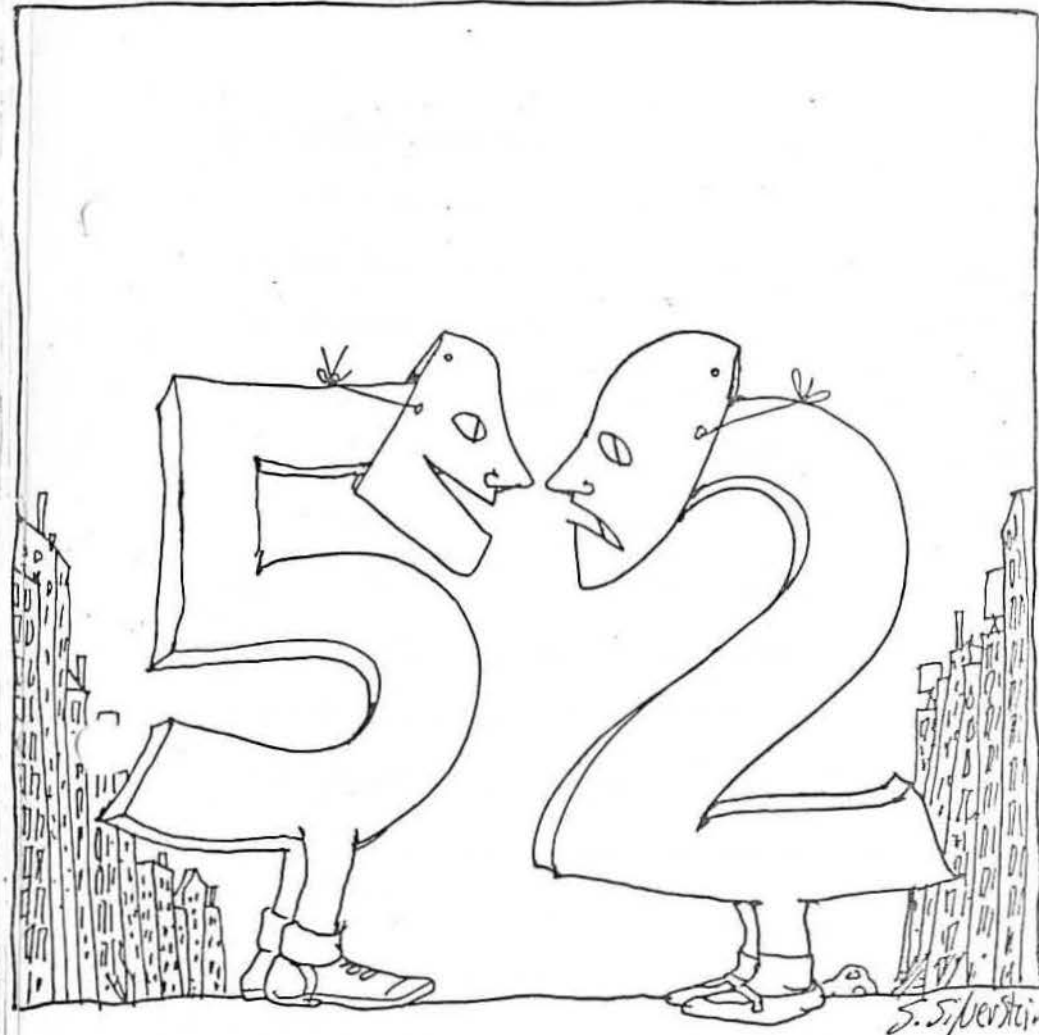

THE 52<sup>ND</sup> Street  
PROJECT

52nd Street Project

Artistic Director.....Willie Reale  
Musical Director.....Rob Reale  
Sets.....Ann Patterson  
Lighting.....Greg MacPherson  
Costumes.....Vicki Weiner  
Technical Director.....Alex Labianca  
Graphic Design.....Tracy Crowther  
Stage Manager.....Ginny Addison  
Assistant Director.....Lee Costello  
Assistant to the Set Designer.....Trip Kyle  
Light Board Operator.....Kathy Chaffee  
Best Boy.....Carl Winston  
Piano.....Tom Finklea  
Bass.....Rick VanLoon  
Drums.....Graham Hawthorne  
Guitar.....Rob Reale

June  
1986

THE WORLD IS GETTING TO BE A BAD NEIGHBORHOOD

Musical Numbers

The World Is Getting To Be A Bad Neighborhood  
Jose Soto, Ensemble  
  
The Cockroach Song  
Ensemble, Black Flag Dancers  
  
He Who Dies With The Most Stuff Wins  
Rejiem Nichols, Ramik Nichols, Ensemble  
  
Black Nightmare  
Paula Myrie  
  
Terrorist Fight Song  
Jose Soto, Danny Battle, Shamine Gibson,  
Dancing Camel  
  
Come-On Down  
Cara Shultz, Travelettes  
  
Pretty Little Heads Of State  
Latanya Godfrey, Paula Myrie, Deneka Peniston  
  
Innocent Questions  
Ensemble

DIG IT!

Book by

Katharine Long

Tag Team Direction by

Amy Birnbaum  
Lyn Greene

Fran McDormand  
Janet Zarish

Choreography by

Lee Costello

Music by

Rob Reale

CAST

Doctors

Dawn Jackson  
Michelle Lefrbvre

Karen Myrie  
Richard Myrie

Natives

Roshanda Coppedge  
Glenda Guzman

Jeanie Morales

Dancing Statues

Kathy Horvath - Queen Camillia  
Yalena Crespo  
Diane Morales

Misael Reyes  
Jessica Rivera  
Tina Vamvoukakis

Setting: A Clearing in a Foreign Land

Time: The Present

THE WORLD IS GETTING TO BE A BAD NEIGHBORHOOD

Music and Arrangements by

Rob Reale

Lyrics and Direction by

Willie Reale

Choreography by

Margie Castleman

CAST

Jose Soto - Rap Master

Ensemble

Danny Battle  
Shamine Gibson  
Latanya Godfrey  
Paula Myrie  
Ramik Nichols

Rejiem Nichols  
Deneka Peniston  
Jessica Soto  
Jose Soto  
Cara Shultz

Travelettes

Melissa Davis  
Henrietta Bowe  
Vanessa Francis  
Erika Funtow  
Kerry Marsh  
Georgette McCloud

Jade Payne  
Kisha Pettigrew  
Rockia Robertson  
Rachelle Romero  
Shannon Romero

Black Flag Dancers

Fredico Aquino  
Arlen Collier  
Kevin Cuevas  
Thomas Harrington

Michael Howe  
Raymond Ramos  
Nathan Stroman  
George Vamvoukakis

Dancing Camel

Terrence Bowe

Arlen Collier

Paul McCrane

# THE FIRST ONE-ON-ONES

## **T**HE FIRST ONE-ON-ONES

WERE PRESENTED BY THE 52ND STREET PROJECT AT ENSEMBLE STUDIO THEATRE, OCTOBER 13 AND 14, 1986 ✦ THE ARTISTIC DIRECTOR WAS WILLIE REALE ✦ THE MUSICAL DIRECTOR WAS ROBERT REALE ✦ THE CHOREOGRAPHER WAS MARGIE CASTLEMAN ✦ THE SET DESIGNER WAS ANNE C. PATTERSON ✦ THE LIGHTING DESIGNER WAS TRACY DEDRICKSON ✦ AND THE STAGE MANAGER WAS VIRGINIA ADDISON.

**THE FIRST ONE-ON-ONES** production was part of the One-on-One program which was conceived as a means to create an opportunity and environment in which a child would be the star in his or her own play. Over a week in the summer, a group of children and playwrights retreat to a country setting where the playwright is asked to mine his/her own child and imbue a fictional character with those traits. Care is taken by the writers to challenge, but not frustrate the child. By the end of the week, the plays are written, rehearsed and performed in a professional theatre in New York City. It is important that the theatre be intimate and the acoustics friendly, as the children should be given every opportunity to be both seen and heard.

# ONE ON ONE

## TANNERSVILLE PLAYS

### ONE ON ONE SONG

COMPOSED BY

BOB SAIDENBERG\*

LYRICS BY WILLIE REALE\*

### YOU SCRATCH MY BACK

BY PETER ZAPP\*

ZOO KEEPER MIKEY LUGO

APE GREG GERMAN

### THE QUEEN OF THE POLAR BEARS

BY DANIEL JUDAH SKLAR

VIRGINIA VARGAS

ROSEMARY MARY KANE

### THE PUPPET SHOW

BY AMY BIRNBAUM

BINGO (VOICE) AMY BIRNBAUM

ELIZABETH TIFFANY KENDLE

AMY AMY BIRNBAUM

### THE DANCING LESSON

BY DONALD MARGULIES

MISS VANESSA ROSHANDA COPPEDGE

ERICA BUMBLER BILLIE WILLIAMS-NEAL

CHOREOGRAPHED BY MISS COPPEDGE

TANNERSVILLE SPECIAL THANKS • STEVE HEFVENDAHL • EDUCATION CENTER  
AT CITIBANK • MARK HARTY • CURT DEMPSTER • LAURA SALVATO • LAURA BARNETT •  
STEVEN HAMILTON • DAVID MEAD • BRIAN BERK • SCOTT BRENNEN • RON GREEN •  
EMILIE WRIGHT • CARLOS SULLIVAN • PATTI VAMVOUKAKIS • JOHN MCCORMACK •  
PAT MARTIN • ARLENE MOHR • JOHN RYAN • AL MARBLY • KAREN ROSA • OFFICES OF  
JENNIFER SCHNEIDER/ASSOCIATES • ALL THE ANIMALS AT THE CATSKILL GAME FARM •

### JUST DESSERTS

BY BRUCE MACVITTIE\*

ELIZABETH CARA SCHULTZ

DWAYNE MAX SANABRIA

BIG DWAYNE BRUCE MACVITTIE\*

### -INTERMISSION-

### HEARTS, FLOWERS, AND JELLO

BY LEE COSTELLO

SANITATION MAINTENANCE ENGINEER

DEVON SHERMAN

RONRON GREEN

### ANOTHER FISHING STORY

BY JAMES MCDANIEL

DAVID JAMES MCDANIEL

HOWARD ALEX BESS

FISH VOICE BRUCE MACVITTIE\*

### HOW TO GET RID OF THE BOOGEYMAN

BY WILLIE REALE\*

HARMAN WILLIE REALE\*

MAX MAX SANABRIA

ARTIBA ARTIBA FORTUNE

BOOGEYMAN ROB REALE

OFFSTAGE VOICES MARY KANE

and LEE COSTELLO

### THE GENIE

BY LEWIS BLACK

DORIE CLARA RAYMOS

DAD'S VOICE WILLIAM CONVERSE ROBERTS

GENIE WILLIAM CONVERSE ROBERTS

DIRECTED BY WILLIE REALE\*

\*Denotes member of the Ensemble Studio Theatre

# ONE ON ONE

### ARTISTIC DIRECTOR

WILLIE REALE\*

### MUSICAL DIRECTOR

ROB REALE

### MANAGING DIRECTOR

VIRGINIA ADDISON

### DIRECTOR OF DEVELOPMENT AND ARTISTIC LIASON

JENNY SCHNEIDER

### SET DESIGNER

KEVIN JOSEPH ROACH

### LIGHTING DESIGNER

GREG MACPHERSON

### COSTUME DESIGNER

PATTI CLEARY

### GRAPHIC DESIGNER

IRIS A. BROWN

### ASSISTANT LIGHTING DESIGNER

JOSHUA JENKINS

### PRODUCTION STAGE MANAGER

MICHAEL RITCHE

### CARPENTERS AND PAINTERS

JOHN DOSSETT

LEE COSTELLO

COLLEEN FITZPATRICK

DAVID FUHRER

GAYLLE O'MALLEY

DAVID SOO

### LIGHT BOARD OPERATOR

JOSH KOVAR

### BAND

GUITAR/KEYBOARD ROB REALE

GUITAR BOB SAIDENBERG\*

BASS ERNIE PROVENCHER

SAXOPHONE BILL HARRIS

### INTERNS

MARK HAYES

SHARI KAPLAN

### DEVELOPMENT

RUTH COHEN

WENDY ETTINGER

### PHOTOGRAPHERS

STEPHANIE BERGER

BARBARA ETTINGER

The 52ND STREET PROJECT IS A COOPERATIVE VENTURE BETWEEN THE POLICE  
ATHLETIC LEAGUE AND THE ENSEMBLE STUDIO THEATRE IN NEW YORK CITY. IT IS  
DEDICATED TO CREATING NEW PLAYS TO CHALLENGE NOT FRUSTRATE CHILDREN FROM  
THE CLINTON NEIGHBORHOOD AND THE TIMES SQUARE WELFARE HOTELS IN NEW YORK  
CITY. EACH PLAY WAS WRITTEN WITH THE SPECIFIC CHILD IN MIND.

The 52nd Street Project's ONE ON ONE program is funded by The Altman Foundation.

\*Denotes member of the Ensemble Studio Theatre



ONE-ON-ONE  
By Lyn Greene

3

THE ROYAL AUDITION  
By Robert Reale

1

PAY OUR RESPECTS  
By Cassandra Medley

2

USE YOUR HEAD  
By Willie Reale

3

THE FINGERWITCH AND THE WIZARD  
By Frances McDormand

4

BABS N' BLABBY  
By William Wise

5

295-SOUL  
By Janet Zarish

7

THE SILVER RING  
By Katherine Long

7

ALL FOR CHARITY  
By John Patrick Shanley

9

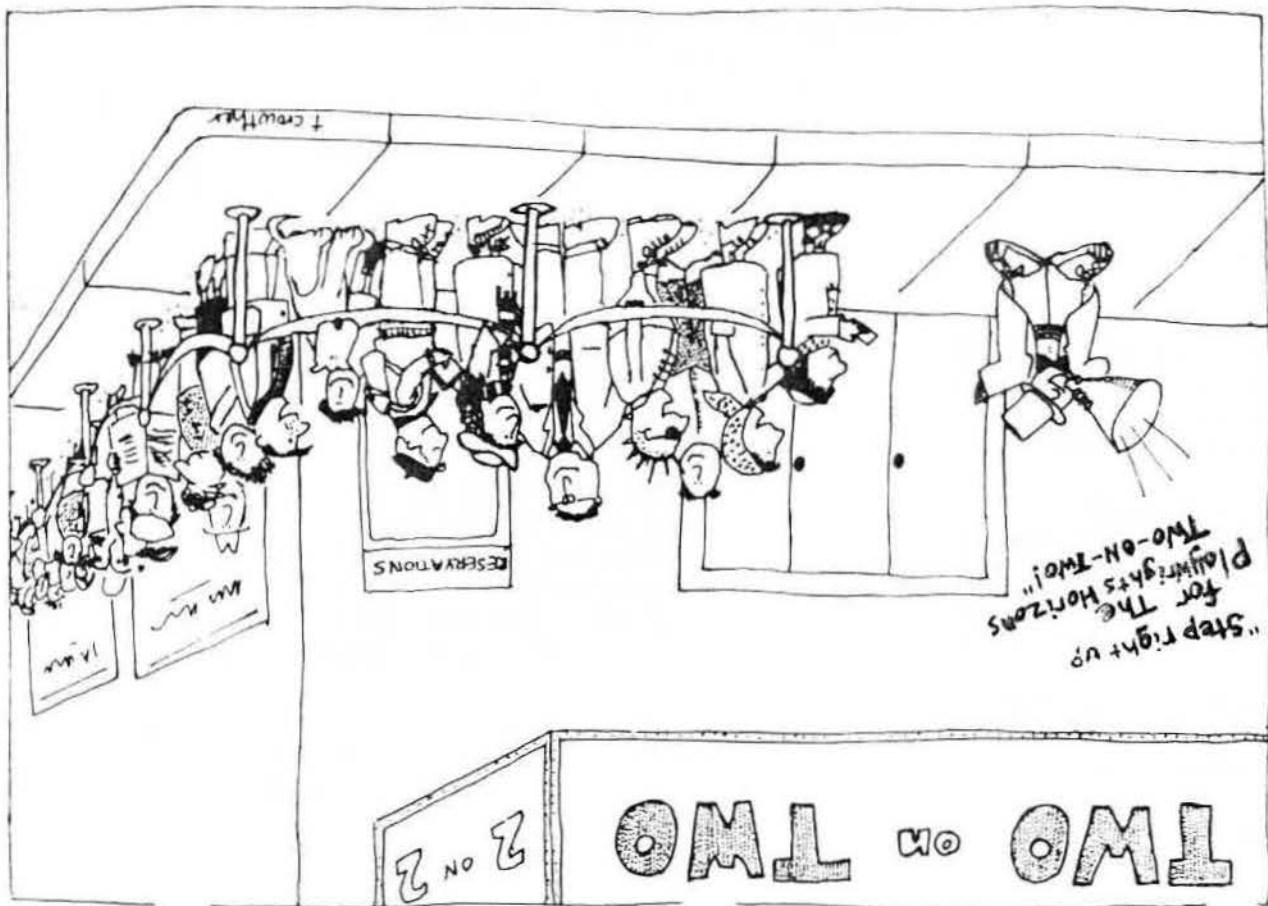

The 52nd Street Project is a cooperative program of the Police Athletic League and The Ensemble Studio Theatre. It is dedicated to creating good memories for the children of the Times Square and Clinton Areas.

The 52nd Street Project is supported by The Altman Foundation

#### Special Thanks

Andre Bishop  
Elizabeth Boyce  
Kuth Cohen  
Paul Daniels  
Kaye Houlihan  
Carl Mulert  
Josh Starbuck  
Carlos Sullivan  
Patty Vanvoukakis  
Albert Webster  
John Wulp and the students of the Playwrights Horizons Theatre School

THE LECOMTE DU NOUY FOUNDATION  
in association with  
PLAYWRIGHTS HORIZONS  
AND THE 52ND STREET PROJECT  
present

THE TWO-ON-TWO

THE PLAYS

HOW NOW BROWN COW  
written by Willie Reale  
directed by Tracy Thorne  
Cow- Kerry Marsh  
Other Cow- Roshanda Coppedge

STARSHIP LOUIE  
written by Jose Rivera  
directed by Lee Costello  
Captain- Heriberto Ruiz  
Alien- Frances Fargargo

POPCORN AND BIG BUCKS  
written by Thomas Babe  
directed by Willie Reale  
Man- Eric Tavares  
Woman- Alma Mendoza

LOUIS AND ALBERT SAVE THE WORLD IN SIX MINUTES  
written by Cindy Lou Johnson  
directed by Frances McDormand  
Louie- Shamine Gibson  
Albert- Richard Myrie

TEA TIME WITH THE TWISTER SISTERS  
written by Donald Margulies  
directed by Kate Nelligan  
Desiree Twister- Cara Shultz  
Pandora Twister- Paula Myrie  
Ramona Pickles- Tiffany Kendle

TRANSITIONS  
Boy in tux- Davon Sherman  
Man not in tux- Ron Greene

Music by Rob Reale  
Sets by Kevin Roach  
Costumes by Vicki Weiner  
with help from Christina Bone  
Lights by Peter West  
Production Stage Manager- Dennis Cameron  
Assistant Stage Manager- Michelle Fincher  
Running Crew- Ron Greene, Andy Kells, Yvette Gonzalez  
Program Design by Tracy Crowther  
Flyer Design by Maggie da Silva

# LAYBILL

PROJECT AT THE ENSEMBLE STUDIO THEATRE

The 52nd Street Project is dedicated to the creation and production of new plays and musicals for a company of children who reside in the Clinton neighborhood and in the Times Square Welfare Hotels. Its focus is to create acting vehicles for the children that allow them to show off their particular skills to their best advantage. The work is designed to challenge, and not frustrate; the entire process is about stacking the deck in favor of the child's success. The project is a cooperative program of the Police Athletic League and The Ensemble Studio Theatre and is funded solely through contributions.

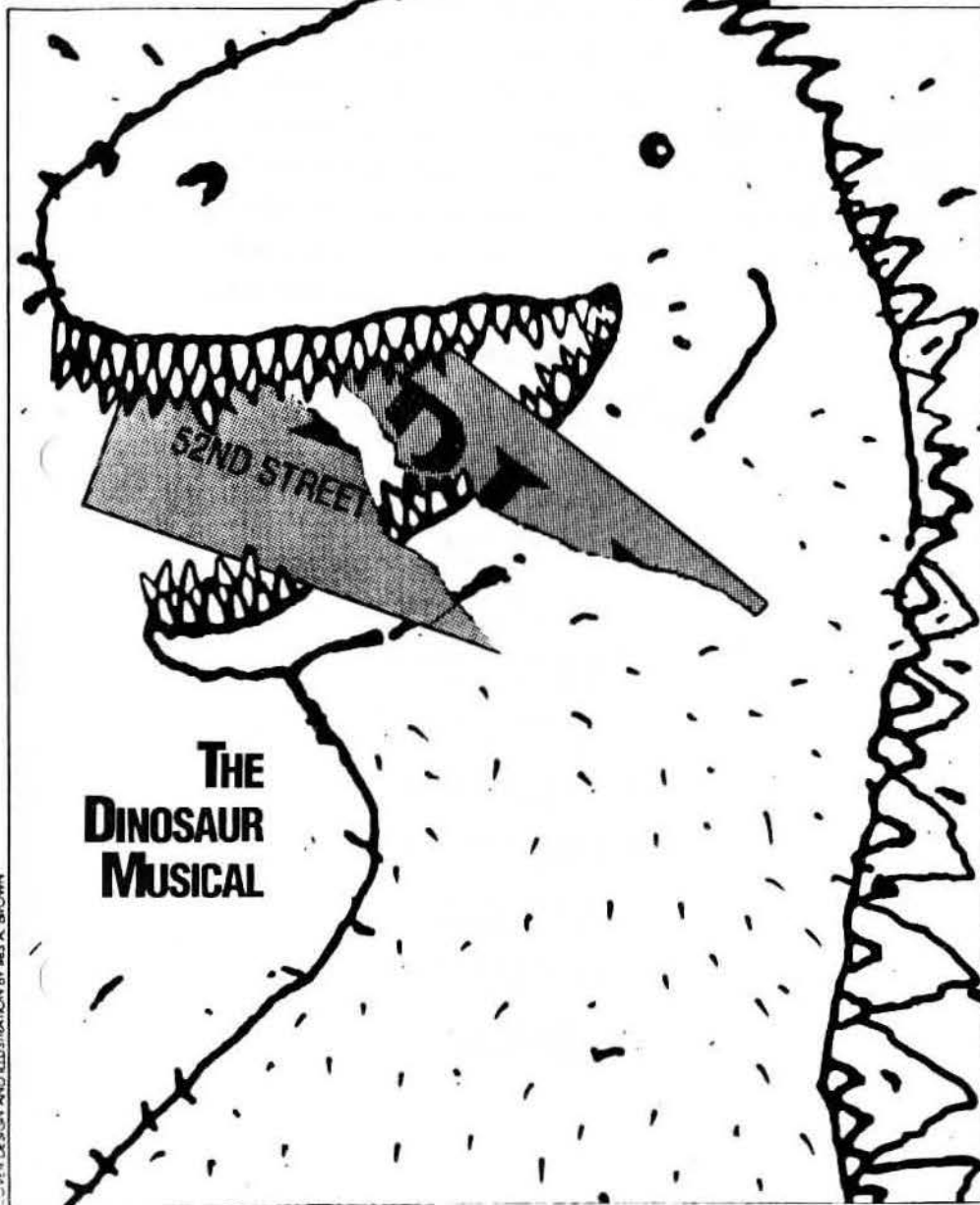

COVER DESIGN AND ILLUSTRATION BY BILLY A. BROWN

THE CAST  
(in order of appearance)

Narrator ..... Barnard Hughes  
Mother Sauropod ..... Paula Myrie  
Little Sauripod ..... Karen Myrie  
Tyrannosaurus Rex ..... Jose Soto  
Ornisaurus Maid ..... Jessica Soto  
Ornisaurus Maid ..... Dawn Jackson  
Stegasaurus Desk Clerk ..... Eric Tavares  
Prehistoric Fruit Tree Chef ..... Cara Schultz  
Prehistoric Fruit Tree Chef ..... Deneka Peniston  
Brontosaurus Waiter ..... Shamine Gibson  
Pterodactyl Bellhop ..... Arlen Collier  
Little Tyrannosaurus Rex ..... Virginia Vargas  
Tree Arms ..... Pam Lack  
Tree Arms ..... Cass Morgan

**MUSICAL NUMBERS**

"All The Conveniences"  
Karen, Jessica, Latanya, Dawn,  
Eric, Deneka, Shamine and Arlen

"Why Not Pretend"  
Karen and Virginia

"Sleeping Song"  
Dawn and Virginia

"Pick It Up"  
Cara and Deneka

"Love Will Never Bold Me"  
Paula & Jose

"And So On"  
Jessica and Dawn

"A Perfect Gentleman"  
Paula

"The Fall Girl Song"  
Jessica

"Fly By Night"  
Cara and Deneka

"Fight With Your Mind"  
Jose

"The Finale"  
The Company

**SPECIAL THANKS:**

Ben Siegler, Steve Eidel, CBS, Pat Martin, Ron Green, PAL, Curt Dempster, Brian Berk, Laura Salvato, Carl Zutz, EST, Eaves Brooks Costume Co., Scott Brennen, Russ Pennington, Patty Vamvoukakis, Steve Silberberg & Champion Zipper Corp., Masque Sound & Recording, Bicycle Habitat, Ray Maynard & Skydive, Inc., Larry Morley & United Rigging, Teddy Van Bimmel & VANCO, Andy Saldenberg & Additional Synthesizer Patches, Buckley Dunton & Ambassador Arts, Inc., Don Kushner & Designer's Workshop, Berhardt Fudyma Design Group, Lynden Mosse, Henson Associates, Carmen Matias, Arlene Mohr, Carlos Sullivan, Karen Rosa, Al Marlby, John Ryan, Dave Marsh, Eric Murkoff, Paul Mott, Jeannine Edmunds, John Wulp, Bill Fagerbakke, Dave (The Stay-Puff Marshmallow Man) Smith, Lucy Mayer-Harrop, Vickie Weiner, Vicker Weiner's Brother, Barbara McCrane, Marion Shamon, Rachel Chanoff, Diana Caunedo, Janet Zarish, Victor B. Handal, Bec Meyers, P.S. 111, Stephanie Berger.

**The 52nd Street Project is funded in part by:**

The Educational Foundation of America  
The Altman Foundation  
The Samuel and May Rudin Foundation, Inc.  
The Uris Brothers Foundation, Inc.  
The Hennessy Foundation, Inc.  
Viking Productions  
John and Polly  
Stephen Graham

## THE CAST

**Fran McDormand** (Assistant Director) has joyfully participated with The 52nd Street Project on Dig It, The One On One, Christmas Dreams, the Two on Two, and The Dinosaur Musical. In another life she's done a little Broadway, television, and movies like Blood Simple, and Raising Arizona. She, like Virginia, wants to be an adult someday.

**Dan Miller** (Cello) plays with a number of orchestras and other music groups throughout Europe and the Americas. He has most recently been performing with chamber ensembles and orchestras in the New York area. He is a big fan of spare ribs.

**Cass Morgan's** (Assistant Director) New York credits include the Tony nominated Pump Boys and Dinettes, which she also co-created, Another Paradise, Cryer and Ford's Hang On To The Good Times and Country Cabaret, both for Manhattan Theatre Club, Hair and The Human Comedy, La Boheme and The Knife all for the New York Shakespeare Festival. On television she has appeared in NBC's Pump Boys and Dinettes and the CBS film Vengeance.

**Pamela Penenberg-Bopkins** (Dino Accessories) currently works at Eaves-Brooks Costume Company, the company which brings to you Ringling Brothers & Barnum & Bailey Circus and Disney On Ice. Pam is also an investor in Shadowland, an Art Deco theatre opening its third season in the Catskills. This is the fourth production she has had the honor of working on with Willie Reale, et al. Each is a greater challenge.

**Tim Ray** (Keyboards) works freelance in recording and performing settings. He has degrees from Arizona State and New England Conservatories. He currently resides and works in Boston.

**Rob Reale** is a freelance musician and composer. Rob has known his brot Willie for as long as he can remember.

**Willie Reale** is the founder and artistic director of The 52nd Street Project. He has developed and produced over 30 plays and a feature length video tape for the children of this neighborhood. In real life, he is an actor and a playwright who's plays, Many Happy Returns and Fast Women, have been produced here at EST and are published by the Dramatists' Play Service. He has written some television as well. Along with his brother, Rob, he has written three musicals for the kids and is putting the finishing touches on an "adult" musical called Man On The Moon. There is very little chance that he will ever grow up.

**Michael P. Ritchie** (Stage Manager) has stage-managed over 50 productions both on and off Broadway, regional and summer stock. This show marks his first, but hopefully not his last, association with The 52nd Street Project.

**Kevin Joseph Roach** is a freelance theatrical designer and artisan. This is his third show with The 52nd Street Project; Christmas Dreams, Two on Two, and The Dinosaur Musical. He has lived in NYC for two years, having moved from Boston where he designed Macbeth for the Boston Shakespeare Company and Sam Shepard's Buried Child at the New Ehrlick Theatre, among many others.

**Tracy Thorne** has worked with The 52nd Street Project on The World Getting To Be A Bad Neighborhood, One on One, Christmas Dreams, and Two on Two. She just appeared in EST's Marathon '87 in All For Charity, a play originally written for The 52nd Street Project by John Patrick Shanley. In her free time she acts in off Broadway plays, soap operas and the odd movie. Tracy would like to play first base for the Mets when she is older.

**Rick Van Loon** (Bass) works the nightclub circuit in New York, most frequently with his band "Nightlife". Rick spends his spare time on the high seas.

**ARLEN COLLIER** most recently appeared in the 52nd Street Project's One On One program in The Royal Audition as King Arlen. Before that, he appeared in The World Is Getting To Be A Bad Neighborhood. Arlen wants to be a fireman when he grows up.

**SHAMINE GIBSON** most recently appeared in the 52nd Street Project's Two on Two in Siamese Twins. He has also been featured in The Fingerwitch, Christmas Dreams, and The World Is Getting To Be A Bad Neighborhood all with the 52nd Street Project. Shamaine wants to be an artist in future years.

**BARNARD HUGHES** was last seen on Broadway in The Iceman Cometh. He won the TONY, Drama Desk and Outer Critics' Circle Awards for his portrayal of Da in Da. Mr. Hughes has appeared in numerous Broadway productions. He has also been in many films and TV shows, too numerous to mention. Mr. Hughes is presently starring in the TV series The Cavanaugh's. This marks Mr. Hughes debut with the 52nd Street Project.

**DAWN JACKSON** starts her career with the 52nd Street Project. Dawn starred in 2-9-5 Soul. She has also appeared in Dig It and Christmas Dreams. In years to come, Dawn wants to be a doctor, nurse, singer, actress, teacher, mother, and saleswoman selling cars, groceries, cosmetics and Avon.

**KAREN MYRIE** has starred in Christmas Dreams and The Silver Ring. She has also appeared in Dig It. After studying with the 52nd Street Project, Karen wants to be a dancing librarian.

**PAULA MYRIE** has participated in many plays with the 52nd Street Project. Among them are Twilight Cowboy, Nick T. Maker - The Story Drags On, Success, The World Is Getting To Be A Bad Neighborhood, and The Silver Ring. Paula also understudied and performed the role at the West Bank Cafe Theatre Bar in Using Your Head. Not only does Paula act, she also was the assistant stage manager for Christmas Dreams. Paula wants to be a medical general practitioner.

**CARA SCHULTZ** was last seen in The 52nd Street Project's Two on Two in Tea Time With The Twister Sisters by Donald Margulies and The World Is Getting To Be A Bad Neighborhood. Cara wants to be a Star.

**DENEKA PENISTON** has been a member of the 52nd Street Project company for seven years. She's been in Seen But Not Heard, Christmas Dreams, Fire At Gracey Mansion, The Further Adventures Of Nick T. Maker, Nick T. Maker - The Story Drags On, The World Is Getting To Be A Bad Neighborhood, The 52nd Street Project Movie, and Pay All Respects. Deneka wants to be a novelist.

**JESSICA SOTO** appeared with Willie Reale in Using Your Head and The World Is Getting To Be A Bad Neighborhood both with The 52nd Street Project. Jessica wants to be a secretary when she grows up.

**JOSE SOTO** started and continues his acting career with the 52nd Street Project. Among the productions Jose has appeared in are Twilight Cowboy, Nick T. Maker - The Story Drags On, The World Is Getting To Be A Bad Neighborhood, and All For Charity. In addition to his participation with the Project, Jose has appeared in two films: Five Corners and Candy Mountain. Jose wants to be a corporate lawyer someday.

**ERIC TAVARES** made his theatrical debut in the 52nd Street Project's Two on Two in Tom Babe's Popcorn And Big Bucks. Eric wants to be the second baseman for the Mets when he is older.

**VIRGINIA VARGAS** makes her theatrical debut in The Dinosaur Musical. Virginia is one of the youngest members of this cast at eight years of age. At this point in her life, Virginia is not certain what she wants to be other than an adult someday.



**The 52nd Street Project** is dedicated to the creation and production of original plays and musicals for a company of children who reside in the Times Square Welfare Hotels and in the Clinton neighborhood. Its focus is to create acting vehicles for the children that will allow them to show off their particular skills to best advantage. The work is designed to challenge, not frustrate: the entire process is about stacking the deck in favor of the child's success.

The Project gratefully acknowledges the support of the following individuals during the 1986-1987 season:

Jaqueline & Howard P. Aronson  
 Marie Artesi  
 Joyce Baslow  
 Dion Birney  
 Andre Bishop  
 Eleanor Blissinger  
 Sari Bodl  
 Katherine Borowitz  
 Douglas Bourle  
 Michael Brennan  
 Mrs. Lorraine Brown  
 Garrett Brown  
 Mrs. Eddy Brown  
 Douglas Bourack  
 Mrs. Virginia Chureff  
 Kim Crowther  
 Joel Coen  
 Ruth Cohen  
 Mrs. Roger Crayton  
 Arthur Dantchik  
 Kathy Dantchik  
 John Douglas  
 David Dretzin  
 June Dunbar  
 Mrs. B.L. Ettinger  
 Barbara Ettinger  
 Felice Frances

Carolyn French  
 Bruno & Roslyn Freudenthal  
 Vera Gawansky  
 Daniel & Patricia Gerroll  
 Mark Dulaney Glen  
 Milton Goldman  
 Christine Goodheart  
 Stephen Graham  
 Graphics-to-Go  
 Susan Green  
 Clifford & Karyn Greene  
 Henry Guettel  
 Sarah Hershey  
 Jane Hoffman  
 Barnard Hughes  
 Jill Johnstone  
 Robert & Mary Joy  
 Nina Kimerker  
 Paula Landesman  
 Knight & Carole Landesman  
 Francis Levy  
 Carol Lewis  
 Per Lofving  
 John Lyons  
 William McElhiney  
 Greg MacPherson  
 Bruce MacVittie

Julia Miles  
 Fayette Aurella Nichols  
 Peter Neufeld  
 Mr. & Mrs. Edward Pennfield  
 Steve & Barbara Perry  
 Roger Peters  
 Renak Ramsay  
 Stephen Graham  
 Mr. & Mrs. Gene Reale  
 John & Joan Reynolds  
 Elizabeth Rigg  
 Ruth Robertson  
 Nell Robinson  
 Nille Rodgers  
 Alice Rubin  
 Kathy Schleyer  
 John Patrick Shanley  
 Paul Sullivan  
 Lauren Lowenthal Swift  
 John Thorne III  
 Karen Trott  
 Wendy Wasserstein  
 Donna & Walter Wick  
 Mr. & Mrs. Robert Wilder  
 David Williams  
 Andy Wolk  
 Laura Valeroso  
 Susan Vitucci  
 Janet Zarish

**Foundations and Corporations:**

The Altman Foundation  
 The Educational Foundation of America  
 The Exxon Corporation Foundation  
 Foundation for a Better New York  
 The William and Mary Greve Foundation  
 The Hennessy Foundation  
 International Creative Management  
 The Samuel and May Rudin Foundation  
 The Uris Brothers Foundation

THE 52ND STREET PROJECT  
 in conjunction with  
 THE POLICE ATHLETIC LEAGUE and  
 THE ENSEMBLE STUDIO THEATRE  
 Present

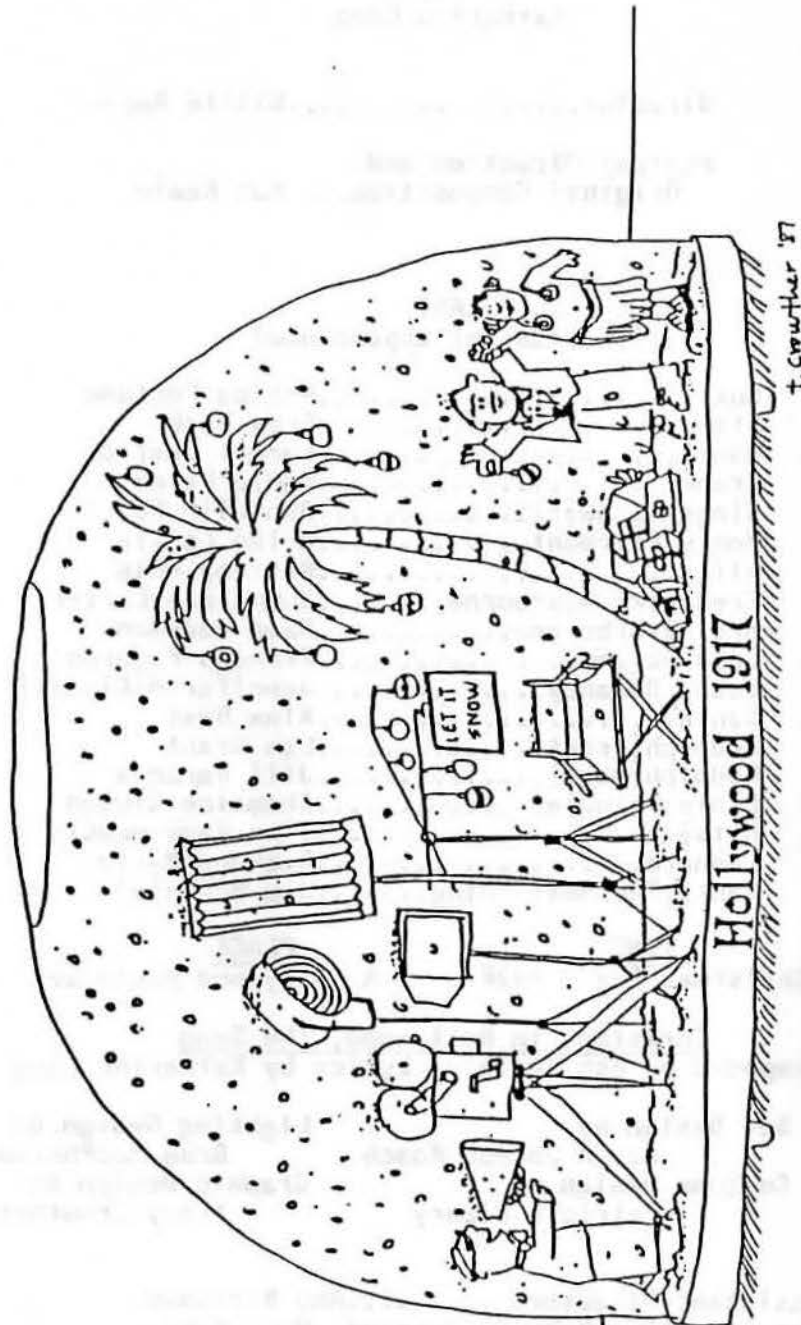

THE 52ND STREET PROJECT



# CHRISTMAS IN HOLLYWOOD

by  
Katharine Long

Director.....Willie Reale

Musical Direction and  
Original Composition....Rob Reale

## CAST

(in order of appearance)

Gus.....Artiba Fortune  
Stan.....Drew Nash  
Hank.....Lamarr Crafton  
Frank.....Eddie Perez  
Ginger Schwartz.....Danielle Ferrin  
Monty Fairmont.....Arlen Collier  
Alice.....Natisha Chin  
Frederika Dearborne.....Juanulete Carter  
Mrs. Dearborne.....Dawn Jackson  
Lola Delaney.....Frances Fagardo  
Leana Delaney.....Jennifer McClowski  
Santa.....Alex Bess  
Rudolph(front).....Lee Grant  
Rudolph(back).....Jill Barbosa  
Ernie Pringle.....Shamaine Gibson  
Mitsy.....Tina Vamvoukakis  
Leonard.....Richard Myrie  
Santa,The Real Thing.....Jim McDaniel

## TIME

Christmas Eve - 1928

## PLACE

A Hollywood Movie Set

## Christmas in Hollywood, The Song

Composed by Rob Reale      Lyrics by Katharine Long

## Set Design by

Kevin Joseph Roach

## Lighting Design by

Greg MacPherson

## Costume Design by

Patricia Cleary

## Graphic Design by

Tracy Crowther

Assistant Directors.....Amy Birnbaum,  
Lee Costello, DeBorah Johnson, Mary Kane,  
Jim McDaniel, Karen McGlaughlin, Patty Munter,  
Susan Terry and Tracy Thorne

Light Board Operator.....Josh Kovar

Carpenters and Artists.....Iris Brown,  
John Dossett, Colleen Fitzpatrick, David Fuhrer  
and David Soo

## Staff of The 52nd Street Project

Artistic Director.....Willie Reale  
Musical Director.....Rob Reale  
Managing Director.....Virginia Addison  
Director of Development/  
Artistic Liaison.....Jennifer Schneider  
Everything Else.....Shari Kaplan

**Special Thanks to** Gregory Banks at The Education Center, Laura Barnett, Stephanie Berger, Brian Berk, Scott Brennan, Citibank; Georgia, Mark Harty and Ursula, Dorothy Chansky, Ruth Cohen, Jim Costello, Curt Dempster, Barbara Ettinger, Jr., Wendy Ettinger, Ron Green, Mary Kane, Al Marbly, Pat Martin, Fran McDormand, Dave Mead, Arlene Mohr, Kate Nelligan, New York Theatre Workshop, Jean Osnos, John Ryan, L. Salvato, Martin L. Schneider/Associates, Ben Siegler, Dave Smith, Patty Vamvoukakis, Ed Willis, John Wulp, the Students of N.Y.U., the entire staff of The Police Athletic League, and our Advisory Committee

## Advisory Committee:

Wendy Ettinger, Chairperson

Ruth Cohen	Lynne Gugenheim
Mrs. Roger Crayton	Marsue MacNicol
Mrs. Barbara L. Ettinger	Carmen Matias
Jack Gilpin	Bob Saldenberg
Stephen Graham	Kevin Ward
John Wulp	

The 52nd Street Project is dedicated to the creation and production of original plays and musicals for a company of children who reside in the Times Square Welfare Hotels and in the Clinton Neighborhood. Its focus is to create acting vehicles for the children that will allow them to show off their particular skills to best advantage. The work is designed to challenge, not frustrate: the entire process is about stacking the deck in favor of the child's success.

The Project gratefully acknowledges the support of the following individuals during the 1987-1988 season:

Allan Arffa  
 Jaqueline & Howard P. Aronson  
 Marie Artesi  
 Joyce Baslow  
 Nina Bell Allen  
 Dian Birney  
 Andre Bishop  
 Eleanor Bissinger  
 Sari Bodl  
 Katherine Borowitz  
 Douglas Bourie  
 Michael Brennan  
 Mrs. Lorraine Brown  
 Garrett Brown  
 Mrs. Eddy Brown  
 Douglas Bourack  
 Ellen Chenoweth  
 Mrs. Virginia Chureff  
 Joel Coen  
 Ruth Cohen  
 Kim Crowther  
 Mrs. Joan Craton  
 Arthur Dantchik  
 Kathy Dantchik  
 John Douglas  
 David Dretzin  
 June Dunbar  
 Jeannine Edmonds  
 Mrs. B.L. Ettinger  
 Barbara Ettinger  
 Ronnie Ettinger  
 Martha Evans  
 Felice Frances  
 Carolyn French  
 Bruno &  
 Roslyn Freudenthal  
 Vera Gawarsky

Daniel & Patricia Gerroll  
 Jack Gilpin  
 Mark Dulaney Glen  
 Hilton Goldman  
 Christine Goodheart  
 Stephen Graham  
 Clifford & Karyn Greene  
 Henry Guettel  
 Jane Hamon  
 Sarah Hershey  
 Jane Hoffman  
 Mary Holloway - ABNY  
 Barnard Hughes  
 Doug Hughes  
 Laura Hughes  
 Aldon James  
 Jill Johnstone  
 Robert & Mary Joy  
 Nina Kimmerker  
 Thomas Kopache  
 Knight & Carole Landesman  
 Paula Landesman  
 Rocco & Heidi Landesman  
 Francis Lew  
 Carol Lewis  
 Lisa Limonde  
 Per Lofving  
 John Lyons  
 Robert McDonald  
 William McElhinxy  
 Connie McGowan  
 Marsue Madlicol  
 Greg MacPherson  
 Bruce MacVittie  
 Carmen Matias  
 Kay Matschullat  
 Julia Miles

Jane & Alan Morel  
 Jeff & Hanna Moskin  
 Fayette Aurelia Nichols  
 Peter Neufeld  
 Eric Overmeyer  
 Mr. & Mrs. Edward Pennfield  
 Steve & Barbara Perry  
 Roger Peters  
 Sally Philipps  
 Ronak Ramsay  
 Godfrey Rayner  
 Mr. & Mrs. Gene Roale  
 John & Joan Reynolds  
 Eliabeth Rigg  
 Ruth Robertson  
 Nell Robinson  
 Nile Rodgers  
 Alice Rubin  
 Kathy Schleyer  
 Martin & Rona Schneider  
 Fran Sears  
 John Patrick Shanley  
 Paul Sullivan  
 Lauren Lowenthal Swift  
 John Thorne III  
 Karen Trott  
 Kevin Ward  
 Wendy Wasserstein  
 Walter & Donna Wick  
 Mr. & Mrs. Robert Wilder  
 Beth Williams  
 David Williams  
 Andy Wolk  
 Laura Valeroso  
 Susan Vituoci  
 Janet Zarish

Foundations and Corporations:

The Altman Foundation  
 The Educational Foundation of America  
 The Exxon Corporation Foundation  
 Foundation for a Better New York  
 The William and Mary Greve Foundation  
 The Hennessy Foundation  
 International Creative Management  
 The Samuel and May Rudin Foundation  
 The Uris Brothers Foundation

THE SAINT VALENTINES DAY

# MASCARA

FIVE SHORT ONE ACTS



The 52nd Street Project  
Presents  
The Saint Valentine's Day  
Mascara Plays  
IN CONJUNCTION WITH  
THE POLICE ATHLETIC LEAGUE AND THE  
ENSEMBLE STUDIO THEATRE

I Don't Know About You

by Karen Myrie  
directed by Sloane Shelton  
MAGNOLIA ....Anne O'Sullivan  
MIKE .....George Babiak

Lies Turn Into Love

By Nathan Strohman  
directed by Daniel Judah Sklar  
PAM .....Ann Talman  
WILLIE .....Bruce Mac Vittie

At the Movies

by Damaris Citron  
directed by Lee Costello  
CAROL ANN ...Carla Meadows  
FRANKLIN ....Chris Ceraso

Lovers

by Artiba Fortune  
directed by Mary Kane  
RON .....Ron Green  
MOTHER NATURE ..Neida Guzman

Every Story Has Two Sides

by Paula Myrie  
directed by Laura Maria Censabella  
FLYMAN .....Kevin Joseph Roach  
CYNTHIA .....Gayelle O'Malley

Production Staff

Stage Manager .....Richard Hester  
Master Electrician .....David Mead  
Ass't. Stage Manager .....Trina Light  
Light Board Operator .....Heather Wiley  
Graphics .....Iris Brown

Staff

Artistic Director .....Willie Reale  
Managing Director .....Virginia Addison  
Director of Development ...Jenny Schneider  
Goddess Intern .....Trina Light

Special Thanks: Wendy Ettinger, Daniel Swee,  
Educational Center at Citibank, Gregory  
Banks, Curt Dempster, Brian Berk, Laura  
Barnett, Laura Salvato, David Mead, The  
Advisory Board, Ed Willis, Ron Green, Pat  
Martin, John Ryan, Dave Smith, Al Marby,  
Ben Siegler, The Julliard School, Barbara  
Ettinger, Robert Blake, Nancy Kersey,  
Patty Vamvoukakis, Dean Gray

Advisory Committee:

Wendy Ettinger, Chairperson

Ruth Cohen  
Mrs. Joan Craton  
Mrs. Barbara L. Ettinger  
Jack Gilpin  
Stephen Graham

Lynne Gugenheim  
Marsue MacNicol  
Carmen Matias  
Bob Saldenberg  
Kevin Ward  
John Wulp

Advisory Committee

Wendy Ettinger, Chairperson

Ruth Cohen  
Mrs. Joan Craton  
Mrs. B.L. Ettinger  
Jeannine Edmonds  
Jack Gilpin  
Stephen Graham

Lynne Gugenheim  
Marsue Macnicol  
Carmen Matias  
Fran McDormand  
Bob Saiden  
Kevin Ward  
John Wulp

The Project gratefully acknowledges the support of the following individuals:

Allen Aron  
Howard & Jacqueline Aronson  
Mie Aronson  
Joyce Bealov  
Mira Bell Allen  
Dian Birney  
Andre Blatop  
Eleanor Blatop  
Seri Bond  
Katherine Brodzitz  
Douglas Scarie  
Michael Brennan  
Mrs. Lorraine Brown  
Carratt Brown  
Mrs. Eddy Brown  
Douglas Barack  
Don Barnfield & Assoc.  
Ellen Chernoweth  
Mrs. Virginia Chareff  
Joel Coon  
Ruth Cohen  
Mr. & Mrs. Todd G. Cole  
Kia Croucher  
Mrs. Joan Craton  
Arthur Derschik  
Kathy Derschik  
Beverly Ditz  
Gert Duspater  
John Douglas  
David Dvezin  
Jane Garber  
Joanna Edwards  
Mrs. B.L. Ettinger  
Barbara Ettinger  
Richard Ettinger  
Bernie Ettinger  
Patricia Evans  
Patricia Frances  
Carolyn French  
Bruno & Roelyn  
Friedenthal  
Elizabeth Friedman  
Vera Gansky  
Daniel & Patricia Gerroll  
Jack Gilpin  
Mark Galaray Glen

Daniel & Patricia Gerroll  
Jack Gilpin  
Mark Galaray Glen  
Leonard & Marita Gochman  
Milton Goldson  
Christine Goodman  
Stephen Graham  
Sam Green  
Clifford & Evelyn Greene  
Lyone Greene  
Edward & Florina Green  
Henry Gertzel  
Laura Gershtein  
Lyone Gershtein  
Keith Haring  
Jane Harmon  
Sarah Harvey  
Jane Hoffman  
Mary Holloway/AMF  
Bernard Hughes  
Doug Hughes  
Laura Hughes  
Alden James  
Jill Johnston  
Robert & Mary Joy  
Mira Kaminer  
Thomas Kopache  
Bright & Charole Leshman  
Paula Leshman  
Rocco & Heidi Landsman  
Francis Levy  
Carol Lewis  
Lia Liscovide  
Mac Loebing  
Marjorie Longley  
John Lyons  
Carmen Matias  
Robert McDonald  
William McElhinney  
Carmel McDonald  
Marcus C. Macnicol  
Greg MacInterson  
Bruce MacVittie  
Bobby Mann  
Ray Matichuk

Bruce MacVittie  
Bobby Mann  
Ray Matichuk  
Joanna Matias  
Julia Miles  
Alan & Jane Moyal  
Robert Morris  
Jeff & Marva Moskine  
Fayette Aurilia Nichols  
Peter Novak  
Kevin O'Rourke  
Eric Owsen  
Mr. & Mrs. E. Penfield  
Steve & Barbara Perry  
Roger Peters  
Sally Shipps  
Frank Simey  
Godfrey Soyser  
Mr. & Mrs. Gene Steele  
James Swanson  
John & Joan Reynolds  
Elizabeth Sigg  
Ruth Steinman  
Neil Steinman  
Milla Rogers  
Allen Rubin  
Mirra Ross  
Kathy Schleyer  
Martin & Rose Schneider  
Fran Sears  
John Patrick Shanley  
Carolyn Stolper  
Paul Sullivan  
Andrew Stone & Lisa Taylor  
Loren Lowenthal Soffit  
John Thomas III  
Karen Trost  
Kevin Ward  
Mandy Wasserstein  
Walter & Doris Wick  
Mr. & Mrs. Robert Wilder  
Beth Williams  
David Williams  
Arby Wolk  
Laura Valerono  
Susan Vitacci  
Janet Zarish

FOUNDATIONS AND CORPORATIONS: The Altman Foundation, The Bay Foundation, Citibank/Citicorp, The Department of Cultural Affairs, The Educational Foundation of America, The Joyce Mertz-Gilmore Foundation, The William and Mary Grove Foundation, The Bemessy Foundation, Manhattan Community Arts Fund, The New York City Youth Bureau, The New York Times Company Foundation, The Samuel and May Rudin Foundation, The Fan Fox and Leslie S. Samuels Foundation, The Ucis Brothers Foundation.

THE 52ND STREET PROJECT



TIME: The Present  
PLACE: Anywhere U.S.A.  
ATRISE: Son bestows affectionate squeeze upon Mother

MOTHER...  
Put me down this instant!  
SON...



**THE  
MOTHER'S  
DAY  
SPECTACULAR!**

t.cowther 88

At The Lamb's Theatre . May 8 & 9, 1988

THE 52ND STREET PROJECT  
in conjunction with  
The Police Athletic League and  
The Ensemble Studio Theatre  
Present:

THE MOTHER'S DAY SPECTACULAR

ALL AT ONCE by Paula Myrie  
Directed by Donald Margulies  
Janis.....Mary Joy  
Jessica.....Ruby Joy  
Voice.....Janet Zarish

MOTHERS ARE ALWAYS RIGHT by Desiree Smith  
Directed by Laura Censabella  
Tracy.....Tracy Thorne  
Mom.....Joan Vail Thorne

LET IT RING by Dawn Jackson  
Directed by Lee Costello  
Mikey.....James McDaniel  
Mom.....Billie Williams-Neal

THE QUIET PLACE by Danielle Ferrin  
Directed by.....Jan Buckaloo  
May.....Mary Kane  
Mom.....Lois Smith  
Voice.....Rob Reale

NEVER TOO LATE by Jessica Cordero  
Directed by Sybil Rosen  
Alex.....Willie Reale  
Jeffery.....Rob Reale

Contributions gladly accepted at the door...  
immediately following the show.

THE 52nd STREET PROJECT is dedicated to the creation and production of original plays and musicals for a company of children who reside in the Times Square welfare hotels and in the Clinton neighborhood. The Projects main focus is to create acting vehicles for the children that allow them to show off their particular skills to best advantage. The work is designed to challenge, not frustrate: the entire process is about stacking the deck in favor of each child's success.

STAFF

Willie Reale, Artistic Director  
Rob Reale, Musical Director  
Virginia Addison, Managing Director  
Jenny Schneider, Director of Development  
Daniel Judah Sklar, Director of Literary Programming

PRODUCTION STAFF

Richard Hester, Stage Manager  
Peter West, Lighting Designer and Operator  
Doug Hutchinson, Running Crew

Light Hang Crew: Doug Hutchinson  
Peter West  
Dan Levine  
Bill Fagerbakke  
Colleen Fitzpatrick  
David Fuhrer

SPECIAL THANKS TO:

Curt Dempster, Laura Barnett, Jim Costello, David Mead, Dean Grey, Ben Siegler, Greg Banks and The Education Center at Citibank, Lisa Rowland, Dale Ward, Morris Crowe, Dennis Rivera and 1199 Union, Iris Brown, The 52nd Street Project Advisory Board, Wendy Ettinger, Ruth Cohen, John Ryan, Dave Smith, Ed Willis, Patty Vamvoukakis, Pat Martin, Al Marbly, Ron Green, Carolyn Rossi, Denise Nations, Steve Olsen, Lew Black, Rand Forester, Rusty McGee, The West Bank Cafe and The West Bank Cafe Theatre Bar  
Lisa Oransoff, Daniel Swee, Heidi Landesman, Neida Guzman

THE 52ND STREET PROJECT gratefully acknowledges the support of the following foundations, corporations and individuals:

The Bay Fdn., Dept. of Cultural Affairs, Educational Foundation of America Fan Fox and Leslie R. Samuels Fdn., Manhattan Community Arts Fund, The Joyce Mertz-Gilmore Fdn., NYC Youth Bureau, The NY Times Company Fdn., The Samuel and May Rubin Fdn., The Laura B. Vogler Fdn.

Kenec Allmen  
Allan Arifa/Kay  
Matschullat  
Elizabeth Barhydt  
Joy Baslow  
Stephanie Berger  
Ivan Birney  
Andre Bishop  
Eleanor Bissinger  
Douglas Borrie  
Michael Brennan  
Garrett Brown  
Iris Brown  
Don Buchwald & Assoc.  
Rev. Mack Buckaloo  
Ellen Chenoweth  
Ruth Cohen  
Mr. & Mrs. Todd Cole  
Mrs. Roger Craton  
Janet Crawford  
Bill Cwikowski  
Eucharine Long  
Cathy Dantchak  
Susan Dertz  
Curt Dempster  
John Duggett  
John H. Douglas  
David Dretzin/Joanna  
Merlin  
Jane Dunbar  
Joannine Edmonds  
Caroline & John Ellis  
Roy Eng  
John & Kitty Errett  
Mrs. B. L. Ettinger  
Barbara Ettinger/Robert  
Blake  
Richard Ettinger  
Ronnie Ettinger  
Albert & Elizabeth  
Faber  
Richard Fox  
Elizabeth Friedman  
Jack Gilpin  
Leonard & Marita  
Gochman  
Mark & Barbara Gordon  
Alice H. Gottesman  
Stephen Graham  
Clifford & Karen  
Grope

Edward & Flavia  
Grimm  
Laura Gugenheim  
Andrew Hajducky  
Keith Haring  
Jane Harmon & Assoc.  
Kathleen Held  
Peter Herdrich  
William Herdrich  
Jane Hoffman  
Mary Holloway  
J. Alan Hostettler  
Laura Hughes  
Aldon James  
Cindy Lou Johnson  
Jyll Johnston  
Robert & Mary Joy  
Mary Kane  
Berrilla Kerr  
Rita Knox/Stephen  
Cohen  
Henry D. Krieger  
Tom Kopache  
Pamela Lack  
Paula Landesman  
Berdi & Joceco  
Landesman  
Knight Landesman  
Bernard Lee  
Per Lofving/Martha  
Evans  
Marjorie Longley  
John Lyons  
M Group  
Marsue & Peter MacNicol  
Gregg MacPherson  
Bruce MacVittie/Ann  
Tallman  
Grace Malico  
Emily Mann  
Carmen Matias  
Paul McCrane  
Karen McCree  
James & Hannelore  
McDaniel  
Robert McDonald  
Fran McDiarmid  
William McElhiney  
Julia Miles  
Janet & Alan Morell  
Robert Morris  
Hannah & Jeff Muskin

Steven J. O'Neill  
Kevin O'Rourke  
Eric Overmyer  
Ellen Parker/Mack  
Lupkin  
Mary Ellen Parks  
Steve & Barbara Perry  
Mr. & Mrs. T. Plant  
Godfrey Rayner  
Mr. & Mrs. Gene Reale  
Paul Reale  
James Revson  
Lillian Rhodes  
Emily Riddle  
Elizabeth Rigg  
Jose Rivera  
Minna Rose  
Alice Rubin  
Joyce Rudnick  
Timothy Sanford  
Alex Schaap  
Kathy Schleyer  
Martin & Rona  
Schneider  
Jeffrey Schwartz  
Fran Sears  
John Patrick Shanley/  
Jayne Baynes  
Sloane Shelton  
Jan Buckaloo  
Robert Sherman  
Robert Siegler  
Lois Smith  
Jody Steiner  
Carolyn Stolper  
Andrew Sweet/Lisa  
Taylor  
Laurin Loventhal  
Swift  
John Thorne III  
Karen Trott  
Lisa Vaamonde  
Kevin Ward  
Ira Weitzman  
Donna & Walter Wick  
Mr. & Mrs. Robert  
Wilder  
Susan Willerman  
Andrew & Hannah Wolk  
Laura Valeruso  
Beth Williams  
James Yoshimura  
Janet Zarish

Donations gratefully accepted at the door!

THE 52ND STREET PROJECT  
IN CONJUNCTION WITH  
THE POLICE ATHLETIC LEAGUE AND  
THE ENSEMBLE STUDIO THEATRE PRESENT

THE ANNUAL  
ONE-ON-ONES\*

TWO SEPARATE EVENINGS OF  
10 NEW ONE ACT PLAYS

STARRING:

20 Project Kids

FEATURING:

20 of NYC Finest Actors and Playwrights

BLOCK ISLAND PLAYS

August 1 and 2 at 7:30 PM  
Monday & Tuesday

TANNERSVILLE PLAYS

August 15 and 16 at 7:30 PM  
Monday & Tuesday

WILLIE REALE

Artistic Director

ROB REALE

Musical Director

MARSUE CUMMING

Executive Director

VIRGINIA ADDISON

Production Manager

ONE  
ONE

\* Not part of the New York International Arts Festival

THE 52ND STREET PROJECT  
PRESENTS  
THE 1988 ONE-ON-ONE'S

PROJECT STAFF

Willie Reale, Artistic Director  
Marsue Cumming, Executive Director  
Virginia Addison, Production Manager  
Rob Reale, Musical Director  
Daniel Judah Sklar, Director of  
Literary Programming

PRODUCTION STAFF

Kevin Joseph Roach, Set Designer  
Teresa Bell, Lighting Designer  
Will Barker, Technical Director  
Rob Reale, Musical Director  
Richard Hester, Stage Manager  
Iris A. Brown, Graphics  
Robert Hill, Master  
Electrician  
Robert Blake, Photographer  
David Soo, Production  
Assistant  
Anne O'Sullivan, House  
Manager



THE 52ND STREET PROJECT is dedicated to the creation and production of original plays and musicals for a company of children who reside in the Times Square and Clinton Hill neighborhoods. The Project's main focus is to create acting vehicles for the children that allow them to show off their particular skills to best advantage. The work is designed to challenge, not frustrate: the entire process is about stacking the deck in favor of each child's success.

ADVISORY COMMITTEE

Wendy Ettinger, Chairperson

Ruth Cohen  
Joan Craton  
Mrs. B. L. Ettinger  
Jeannine Edmonds  
Jack Gilpin  
Stephen Graham

Lynne Gugenheim  
Carmen Matias  
Fran McDormand  
Bob Saidenberg  
Kevin Ward  
John Wulp

SPECIAL THANKS TO:

Bruce Cohen, Kathleen Von Schmid, Dale Ward, VANCO, Iris Brown, Dave Smith, Ed Willis, Patty Vamvoukakis, Pat Martin, Curt Dempster, Dave Mead, David Fuhrer, Amy Birnbaum, John Ryan, Al Marbly, Miles Gordon, Gary Nebiol, Bobby Dunn, Gregg MacPherson, Bob & Lyn Reale, Dr. Christina Biaggi, Virginia Dare, Joya Verde, Tom Reale, Wendy Ettinger, Barbara Ettinger, Jim Costello, Hy Moscovitz, Circle Rep, Greg Sutton, Marvin Salzberg, The Oceanwest Theatre Company, Opus, the dog, Stephen Hamilton, Interstate Navigation Company, Rodney Coleman, Raquel Marmol, Tom and Carol Lavelle, Amanda and Sean Velie-Gass, Kaye Bailey, Natalie Mitchell, COLORFORMS, Keith Wiarda and The New York Yankees, Dr. Al Sabatini, Dr. Lee, Dr. Bruce Pomerantz, Jenny Schneider, Lynne Greene, Leslie Slate, Bill Froelich, Tripod Printing, Inc., Dr. Stephen Knox, Anna Testa, Dennis Tolentino, Neida Guzman, Jody Steiner, Ginny Mazur, Brad, Lee Costello, Hugh Sinclair, Leslie Reed, Michael Cuiccio

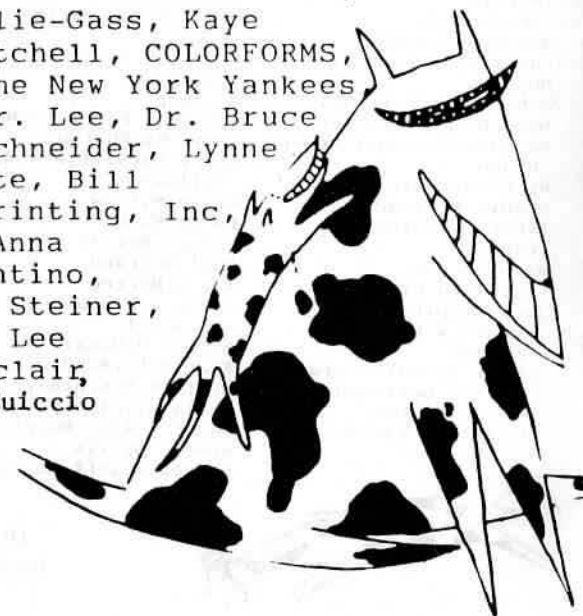

THE TANNERSVILLE BEDTIME ZONE ONE ON ONE

USEFUL TRASH by Leigh Curran  
Mikey.....Mikey Lugo  
M.....Leigh Curran  
/er.....Paul McCrane

THE EMISSARY by Bruce MacVittie  
G.A.....Francis Fargardo  
Man.....Bruce MacVittie

THE FACTS OF LIFE by Ben Siegler  
Dennis.....Dennis Martinez  
Dad.....Bill Fagerbakke  
Mom.....Neida Guzman

A NIGHT AT THE OPRAH by Nancy Giles  
Mother.....Nancy Giles  
Clarissa.....Karen Myrie  
Voice of Max...Ben Siegler  
Makeup Artist..Francis Fargardo  
Hairdo Artist..Kulondi Frier

COTTAGE SMALL BY WATERFALL by Willie Reale  
Ellen.....Mary Kane  
Sprite.....Max Sanabria  
Jack.....Willie Reale

INTERMISSION

STUCK ON TWOSIES by Lewis Black  
Suzie.....Kathryn Rossetter  
Betty Lou.....Virginia Vargas

PUNCH THE CLOCK by Janet Zarish and Kulondi Frier  
Gloria.....Kulondi Frier  
Leslie.....Janet Zarish

HOW LONG HAVE I BEEN SLEEPING by Katharine Long  
Darlene.....Lennette Fletcher  
Miss Hawkins...Katharine Long

HE WHO LAUGHS LAST by Kathryn Rossetter  
Agent Mr. Devil.Richard Myrie  
Lewis Black.....Himself



THE 52ND STREET PROJECT  
in conjunction with  
The Police Athletic League  
and  
The Ensemble Studio Theatre  
Present:

THE HALLOWEEN PLAYS  
October 28, 1988

Written by the "Replay" class  
Performed by the "Drama" class

MONSTER MASH by Danielle Ferrin  
Directed by.....Bruce MacVittie  
Joy.....Monica Jenkins  
Sam.....Calvin Woods  
Mom.....Billie Williams-Neal

THE WEIRD VACATION AT  
TRANSYLVANIA by Artiba Fortune  
Directed by.....Daniel Judah Sklar  
Tim.....Travis Crafton/  
Artiba Fortune  
Alet.....Frances Fargardo  
Ben.....Ned Eisenberg

BLESS YOUR HEART by Paula Myrie  
Directed by.....Lee Costello  
Highly Ann.....Kim Hartwick  
Carmen.....Melody Santana  
Ms. Crock.....Paul McCrane

THREE SISTERS by Shamine Gibson  
Directed by.....Marya Cohn  
Tracy.....Tina Vamvoukakis  
Pearl.....Karen Myrie  
Betty.....Kathy Rossetter

AN UNFORGETTABLE  
HALLOWEEN by Karen Myrie  
Directed by.....Willie Reale  
Bobby.....Gilbert Santana  
Joel.....Richard Myrie  
Coella.....Lewis Black

THE POTION by Tia Nesmith  
Directed by.....Karen Trott  
Jackie.....Kulondi Frier  
Julia.....Paula Myrie  
Wilda.....Karen Evans-Kandel

PRODUCTION STAFF

Production Mgr.....Mina Hammer  
Dramaturgs.....Jan Buckaloo  
Lee Costello  
Cas Hyman  
Willie Reale  
Daniel Sklar  
Set.....Kevin Joseph Roach  
Slides.....Fraser Bresnahan  
Casting.....Tracy Reese  
Sound/Music.....Rob Reale  
Light Board.....John Ceniceros  
Technical Crew.....Millard Corbett  
Mina Hammer  
Tracy Reese  
Marya Cohn  
Lee Costello

PROJECT STAFF

Artistic Director.....Willie Reale  
Executive Director.....Marsue Cumming  
Playmaking/Replay.....Daniel Sklar  
Administrative Asst.....Mina Hammer  
Drama Teachers.....Tracy Reese  
Mina Hammer  
52nd St. at  
Rheedlin Place.....Cas Hyman  
Marya Cohn

Special Thanks to: The PAL Staff and  
Counselors, Curt Dempster, Dave Mead,  
Steve Greg, Suzanne Brinkley and EST,  
Carmen Matthews, Ann Taylor and Doris  
O'Neill, Sloane Shelton, Ginny Addison  
Siegler, Robert Blake, Barbara Ettinger,  
Colorforms, A.V. Workshop



the support of the following foundations, corporations, government agencies and individuals:

Air-Flo Window Contracting Corporations, The Bay Foundation, Bilcrisue Charitable Foundation, Dept. of Cultural Affairs, Educational Foundation of America, Fan Fox and Leslie R. Samuels Foundation, Hennessy Foundation, Manhattan Community Arts Fund, The Joyce-Mertz Gilmore Foundation, New York Times Company Foundation, The Samuel and May Rudin Foundation, The Laura B. Vogler Foundation and

Bence Allmen  
Allan Arfa/Kay  
Matschullat  
Elizabeth Barhydt  
Joy Baslow  
Stephanie Berger  
Dion Birney  
Andre Bishop  
Eleanor & Gerald  
Bissinger  
Katherine Borowitz/  
John Turturro  
Douglas Borrie  
Michael Brennan  
Garrett M. Brown  
Iris Brown  
Don Buchwald & Assoc.  
Mrs. Mack Buckaloo  
Ellen Chenoweth  
Joel Coen  
Ruth Cohen  
Mr. & Mrs. Todd Cole  
Juan & Roger Craton  
Janet Crawford  
Bill Cwikowski/  
Katharine Long  
Susan Deitz  
Curt Dempster  
John Dossett  
John H. Douglas  
David Dretzin/Joanna  
Merlin  
June & Jack Dunbar  
Jeannine Edmonds  
Caroline & John Ellis  
Moy Eng  
John & Kitty Errett  
Mrs. B. L. Ettinger  
Barbara Ettinger/  
Robert Blake  
Richard Ettinger  
Ronnie Ettinger  
Albert & Elizabeth  
Faber  
Richard Fox  
Bruno & Roslyn  
Freudenthal  
Elizabeth Friedman  
Jack Gilpin  
Leonard & Marita  
Gochman  
Mark & Barbara Gordon  
Alice R. Gottesman  
Stephen Graham

Edward & Flavia  
Grimm  
Laura Gugenheim  
Andrew Hajducky  
Keith Haring  
Jane Harmon & Assoc.  
Kathleen Held  
David Herdrich  
Peter Herdrich  
William Herdrich  
Jane Hoffman  
Mary Holloway  
J. Alan Hostetler  
Laura Hughes  
Aldon James  
Norman Jewison  
Cindy Lou Johnson  
Jyll Johnstone  
Robert, Mary & Ruby  
Joy  
Mary Kane  
Berrilla Kerr  
Rita Knox/Stephen  
Cohen  
Tom Kopache  
Henry D. Krieger  
Pam and Andrew Lack  
Paula Landesman  
Heidi & Rocco  
Landesman  
Knight Landesman  
Bernard Lee  
Per Lofving/Martha  
Evans  
Marjorie Longley  
John Lyons  
M Group  
Marsue & Peter MacNicol  
Gregg MacPherson  
Bruce MacVittie/Ann  
Tallman  
Grace Malico  
Emily Nann  
Carmen Matias  
Paul McCrane  
Karen McCree  
James & Hannelore  
McDaniel  
Robert McDonald  
Fran McDormand  
William McElhiney  
Julia Miles  
Janet & Alan Morell  
Hannah & Jeff Moskiri  
Steven J. O'Reill

Kevin O'Rourke  
Eric Overmyer  
Ellen Parker/Mack  
Lipkin  
Mary Ellen Parks  
Steve & Barbara Perry  
Mr. & Mrs. T. Plant  
Godfrey Rayner  
Mr. & Mrs. Gene Reale  
Paul Reale  
James Revson  
Lillian Rhodes  
Emily Riddle  
Elizabeth Rigg  
Jose Rivera  
Hanna Rose  
Alice Rubin  
Joyce Rudnick  
Timothy Sanford  
Alex Schaap  
Kathy Schleyer  
Martin & Rona  
Schneider  
Jeffrey Schwartz  
Jos. E. Seagrans & Sons  
Fran Sears  
John Patrick Shanley  
Jayne Haynes  
Carol Shapiro  
Sloane Shelton/  
Jan Buckaloo  
Robert Sherman  
Robert Siegler  
Lois Smith  
Sheila K. Sobel  
Nancy Stahl  
Jody Steiner  
Carolyn Stolper  
Andrew Sweet/Lisa Taylor  
Lauren Loventhal  
Swift  
John Thorne III  
Karen Trott  
Lisa Vaamonde  
Kevin Ward  
Ira Weitzman  
Donna & Walter Wick  
Mr. & Mrs. Robert  
Wilder  
Susan Willerman  
Andrew & Hannah Wolk  
Laura Valeroso  
Beth Williams  
Jones Yushimura  
Janet Zarish

## THE 52ND STREET PROJECT

IN CONJUNCTION WITH THE  
POLICE ATHLETIC LEAGUE AND THE  
ENSEMBLE STUDIO THEATRE

PL NT

# THE MOON PLAYS

WRITTEN BY

THE 52ND STREET PLAYMAKERS

PERFORMED BY

THE 52ND STREET PROJECT ACTORS

Design: Iris A. Brown

THE 52ND STREET PROJECT

Presents  
THE MOON PLAYS

November 18 and 19, 1986

PROJECT STAFF

Willie Reale, Artistic Director  
Marsue Cumming, Executive Director  
Daniel Judah Sklar, Director of Literary  
Programming  
Mina Hammer, Administrative Assistant  
Tracy Reese, Teaching Intern  
Cas Hyman, 52nd Street at Rheedlin Place  
Marya Cohn, 52nd Street at Rheedlin Place

PRODUCTION STAFF

Kevin Joseph Roach.....Set Design  
Gregg MacPherson.....Lighting Design  
Jessica Murrow.....Stage Manager  
Tracy Reese.....Sound  
Christiane Peters.....Master Electrician  
Iris A. Brown.....Graphics/Slides  
David Soo.....Technical Director  
Martha Evans.....House Manager  
Ginny Addison Siegler.....Running Crew  
Paula Myrie.....Running Crew  
Max Oden.....Set Up Crew  
Tony Campisi.....Set Up Crew  
Greg Grove.....Set Up Crew

The 52nd Street Project's PLAYMAKING program gives kids the opportunity to learn how to write plays. Developed by writer/educator Daniel Judah Sklar, it begins with a series of exercises designed to teach kids the basic tenets of playwriting and culminates in their being paired with professional actors for whom they then write a play. Following an eight-week session of classes, an intensive working weekend, outside New York, adds a dramaturg/director who helps the young writer to shape and refine his/her script. These performances are the fruits of their labor.

ADVISORY COMMITTEE

Wendy Ettinger, Chairperson

Joan Craton	Heidi Landesman
Barbara L. Ettinger	Carmen Matias
Jeannine Edmonds	Frances McDormand
Jack Gilpin	Bob Saidenberg
Stephen Graham	Kevin Ward
Lynne Gugenheim	John Wulp

IN-KIND CONTRIBUTIONS

Ensemble Studio Theatre, Police Athletic League, Colorforms, Sheridan Elson, Caribiner, CBS, Materials for the Arts, A.V. Workshop

SPECIAL THANKS TO:

Wendy Ettinger, Daniel Swee, Frances McDormand and Joel Coen, Ginny Addison Siegler, Milard Corbett, Charles Shays, Patricia Murphy, Amy Birnbaum, Rob Reale, Fraser Bresnahan, Robert Blake, PAL Staff, EST Staff, Douglas, Grabowski, Peter MacNicol, Dave Smith, Harry Winer, Catherine Oxenberg, Dave Mead, Ruth Cohen, Rachel Rennick

Donations will be gratefully accepted at the door!

THE MOON PLAYS

These performances are dedicated to the memory  
of George Sklar

THE DAY THE MOONCREATURES CAME DOWN

by Monica Jenkins  
directed by Marya Cohn  
dramaturg.....Willie Reale  
Susan.....Cynthia Nixon  
Sam.....Doug Hutchinson

THE MAGICAL BOOK

by Justine Cook  
directed by Daniel Judah Sklar  
Boy.....Greg Grove  
Mr. Crimbul.....Tony Campisi  
Kid.....Tony Campisi

MY SECRET IDENTITY

by Roshanda Coppedge  
directed by Ben Siegler  
Jan.....Bill McElhiney  
Girl.....Janet Zarish

HOW THE MOON ACTS ON HALLOWEEN

by Kim Michele Hartwick  
directed by Susan Willerman  
Susan.....Rebecca Nelson  
Marsue.....Karen Evans-Kandel  
Dr. Jane.....Karen Trott  
Mama.....Karen Trott  
Papa.....Ben Siegler

LIFESTYLES OF THE RICH AND WEIRD

by Frances Fargardo  
directed by.....James McDaniel  
John.....Mark Blum  
Sue.....Pamela Tyson

KNOWING YOU

by Shirley Rumierk  
directed by Marsue Cumming  
Richard Humphry III.....Milard Corbett  
Wally Smith.....Robert Joy  
Raul, the French barber....Willie Reale

The 52nd Street Project at  
Rheedlen Place  
Present

THE CHRISTMAS PLAYS

Wednesday December 21, 1988  
5:00 pm

THE GIFT OF THE MAGGOT

Written By Donald Margulies  
Directed By George Babiak

Lauren Order.....Pura Fernandez  
Rosie Rosegarden...Stella Polanart  
Chester Drawers....Ismail Khair

A VERY SPECIAL SPRUCE

Written and Directed By Marya Cohn

Shep Malloy.....Tyrone Hernandez  
Roxie Richardo.....Georgiana Costa

TOO TOUGH FOR CHRISTMAS

Written and Directed By Willie Reale

Kevin.....Kevin Mack  
Danielle.....Danielle DeJesus

THE 52ND STREET PROJECT STAFF:

Willie Reale, Artistic Director  
Marsue Cumming, Executive Director  
Rob Reale, Musical Director  
Ginny Addison Siegler, Production Manager  
Tracy Reese, Intern  
Lee Costello, Assistant Stage Manager  
Hugh Sinclair, Sound Guy

AT RHEEDLEN PLACE:

Fracaswell Hyman, Drama Director  
Marya Cohn, Drama Assistant  
Michael Arsham, Director of Rheedlen Place

SPECIAL THANKS:

The staff and volunteers at Rheedlen Place, Mary Kane,  
Ben Siegler, Peter MacNicol, Frasier Bresnahan

HAPPY HOLIDAYS TO ALL!



THE 52ND STREET PROJECT  
in conjunction with  
The Police Athletic League  
and  
The Ensemble Studio Theatre  
Present:



**THE VALENTINE'S DAY PLAYS**  
February 14, 1989

Written by the "Replay" Class  
Performed by the "Drama" Class

**THE VALENTINE'S DAY PARTY** by Monica Jenkins  
Directed by.....Meredith Portman  
Giorgena.....Jill Barbosa  
George.....Ivory Howard/Willie Reale  
Giorget.....Gayle O'Malley

**YOU GOTTA HAVE GIVING** by Justine Cook  
Directed by.....Laura Maria  
Censabella  
Cindy.....Tina Vamvoukakis  
Donna.....Isabel Maldonado  
Dad.....Jim McDaniel

**THE PERFECT COUPLE** by Frances Fargardo  
Directed by.....Mary Kane  
Miss Cupid.....Frances Fargardo  
Cutie.....Anne O'Sullivan  
Steve "Don't Break My"  
Heart, III.....Tam Weeks

**THE VALENTINE'S DAY**  
**CHANGINGS** by Kim Hartwick  
Directed by.....Susan Willerman  
Alan Nebelthau  
Michael.....Greg Groves  
Leah.....Kulondi Frier  
Kristle.....Venus Batista

**IS THAT REALLY YOU?** by Shirley Rumierk  
Directed by.....Wendy Ettinger  
Mr. De Travin.....Bill McElhiney  
Mrs. De Travin.....Paula Myrie  
Mathew.....Bill McElhiney  
Rachel.....Paula Myrie  
Tuner.....Nyita Hanley

PRODUCTION STAFF

Production Mgr.....Michael Ritchie  
Dramaturgs.....Laura Maria  
Censabella  
Wendy Ettinger  
Mary Kane  
Daniel Judah  
Sklar  
Susan Willerman  
Set.....Kevin Jos. Roach  
Slides.....Iris Brown  
Sound/Music.....Rod Alonzo  
Light Board.....Milard Corbett  
Technical Crew.....Lisa Farago  
Jessica Feder  
Ronald Mendozo

PROJECT STAFF

Artistic Director.....Willie Reale  
Executive Director.....Marsue Cumming  
Playmaking/Replay.....Daniel Sklar  
Administrative Asst....Lisa Farago  
Drama Teachers.....Lisa Farago  
Jessica Feder  
Donna Wick  
Dance Teacher.....Rita Verri  
52nd Street at  
Rheedlin Place.....George Babiak

Special Thanks to: The PAL Staff,  
Dave Mead, Curt Dempster, EST Staff  
and Interns, Randy, Jenna, Kate, Fran  
McDormand, Wendy Ettinger, Barbara  
Ettinger, Stephanie Berger, Ginny  
Addison Siegler and Colorforms

THE 52ND STREET PROJECT gratefully acknowledges the support of the following foundations, corporations, government agencies and individuals:

Air-Flo Window Contracting Corporation, The Bay Foundation, Bilcrisue Charitable Foundation, Citibank, Dept. of Cultural Affairs, Dramatists Guild Fund, Educational Foundation of America, Fan and Leslie R. Samuels Foundation, Manhattan Community Arts Fund, The Joyce Mertz-Gilmore Foundation, Morgan Stanley Foundation, New World Foundation, New York City Youth Bureau, New York Times Company Foundation, The Samuel and May Rudin Foundation &

Renee Allmen  
Allan Arffa/Kay  
Matschullat  
Elizabeth Barhydt  
Joy Baslow  
Stephanie Berger  
Andre Bishop  
Eleanor & Gerard  
Bissinger  
Katherine Borowitz/  
John Turturro  
Douglas Borrie  
Garrett M. Brown  
Iris Brown  
Mrs. Mack Buckaloo  
Laura Maria  
Censabella  
Ellen Chenoweth  
Joel Coen  
Ruth Cohen  
Joan & Roger Craton  
Janet Crawford  
Bill Cwikowski/  
Katharine Long  
Curt Dempster  
Arlene Donovan  
John Dossett  
John H. Douglas  
June & Jack Dunbar  
Jeannine Edmonds  
Caroline & John Ellis  
Moy Eng  
John & Kitty Errett  
Mrs. B. L. Ettinger  
Barbara Ettinger/  
Robert Blake  
Albert & Elizabeth  
Faber  
Richard Fox  
David Frankel  
Bruno and Roslyn  
Freudenthal  
Elizabeth Friedman  
Jack Gilpin  
Leonard & Marita  
Gochman  
Mark & Barbara Gordon  
Alice R. Gottesman  
Stephen Graham  
Edward & Flavia  
Grimm  
Laura Gugenheim  
Andrew Hajducky

Keith Haring  
Jane Harmon & Assoc.  
Kathleen Held  
David Herdrich  
Peter Herdrich  
William Herdrich  
Jane Hoffman  
J. Alan Hostetler  
Barnard Hughes/  
Helen Stenborg  
Laura Hughes  
Norman Jewison  
Cindy Lou Johnson  
Jyll Johnstone  
Robert, Mary &  
Ruby Joy  
Mary Kane  
Berrilla Kerr  
Rita Knox/Stephen  
Cohen  
Tom Kopache  
Henry D. Krieger  
Pam & Andrew Lack  
Zohra Lampert/Paul  
Forman  
Paula Landesman  
Heidi & Rocco  
Landesman  
Knight Landesman  
Bernard Lee  
Per Lofving/Martha  
Evans  
Marjorie Longley  
John Lyons  
M Group  
Marsue & Peter  
MacNicol  
Greg MacPherson  
Bruce MacVittie/Ann  
Tallman  
Grace Malico  
Emily Mann  
Donald Marquilies/  
Lynn Street  
Paul McCrane  
Karen McCree  
James & Hannelore  
McDaniel  
Robert McDonald  
Fran McDormand  
William McElhiney  
Julia Miles  
Janet & Alan Morell

Steven J. O'Neill  
Kevin O'Rourke  
Eric Overmyer  
Ellen Parker/Mack  
Lipkin  
Steve & Barbara Perry  
Mr. & Mrs. T. Plant  
Mr. & Mrs. Gene Reale  
Paul Reale  
James Revson  
Lillian Rhodes  
Emily Riddle  
Elizabeth Rigg  
Jose Rivera  
Bruce & Ellen  
Roseman  
Alice Rubin  
Joyce Rudnick  
Timothy Sanford  
Alex Schaap  
Kathy Schleyer  
Jeffrey Schwartz  
Jos. E. Seagrams & Sons  
John Patrick Shanley/  
Jayne Haynes  
Carol Shapiro  
Sloane Shelton/Jan  
Buckaloo  
Robert Sherman  
Robert Siegler  
Lois Smith  
Sheila K. Sobel  
Nancy Stahl  
Jody Steiner  
Lauren Loventhal  
Swift  
John and Joan Vail  
Thorne  
Karen Trott  
Lisa Vaamonde  
Kevin Ward  
Wendy Wasserst  
Ira Weitzman  
Donna & Walter Wick  
Mr. & Mrs. Robert  
Wilder  
Susan Willerman  
Andrew & Hannah Wolk  
Laura Valeroso  
James Yoshimura  
Janet Zarish



The 52nd  
Street  
Project  
presents

the Spring  
thing

at  
Playwrights Horizons

THE 52ND STREET PROJECT  
Presents  
THE SPRING THING

March 19 and 20, 1989

**PROJECT STAFF**

Willie Reale, Artistic Director  
Marsue Cumming, Executive Director  
Daniel Judah Sklar, Dir. of Literary Programming  
Rob Reale, Musical Director  
Lisa Farago, Administrative and Teaching Intern  
Jessica Feder, Teacher, Creative Dramatics  
Donna Wick, Teacher, Creative Dramatics  
George Babiak, 52nd Street at Rheedlin Place  
Marya Cohn, 52nd Street at Rheedlin Place

**PRODUCTION STAFF**

Kevin Joseph Roach.....Set Designer  
David Soo.....Production Supervisor  
Chris Aurelia.....Technical Supervisor  
Joelle Bochner.....Stage Manager  
Rob Reale.....Sound  
Iris A. Brown.....Slides  
Bruce Cohen.....Press  
Tracy Crowther.....Flyer  
Rebecca Joerres.....Tech Crew  
Denise Johnsson.....Tech Crew  
Zoe Migel.....Tech Crew  
Paula Myrie.....Tech Crew  
Heather Plyant.....Tech Crew  
Ron Riley.....Tech Crew

The 52nd Street Project's **PLAYMAKING** program, developed by writer/educator, Daniel Judah Sklar, begins with a series of exercises designed to teach kids the basic tenets of playwriting and culminate in their being paired with professional actors for whom they then write a play. Following an eight-week session of classes, an intensive working weekend (outside of New York City) adds a dramaturg/director who helps the young writer to shape and refine his/her script. These plays are the fruits of their labors.

Although this is not a Playwrights Horizons event, from time to time, Playwrights Horizons makes its space available to outside organizations.

**ADVISORY COMMITTEE**

Joan Craton	Lynne Gugenheim
Barbara L. Ettinger	Heidi Landesman
Wendy Ettinger, Chair	Carmen Matias
Jeannine Edmonds	Frances McDormand
Jack Gilpin	Bob Saidenberg
Stephen Graham	Kevin Ward
	John Wulp

**IN-KIND CONTRIBUTIONS**

Ensemble Studio Theatre, Police Athletic League, Playwrights Horizons, Colorforms, Sheridan Elson, Materials for the Arts

**SPECIAL THANKS TO:**

Althea Bishop, Paul Daniels and the staff at Playwrights Horizons; Carl Mulert; David Milligan; Frances McDormand and Joel Coen; Ginny Addison Siegler; Charles Shays and Patricia Murphy; Dave Mead; Ruth Cohen; Donald Margulies; Carol Rosegg and the Martha Swope Studio; Curt Dempster, Peter Shavitz and the EST staff; PAL staff; Mary Kane; Rita Knox; James McDaniel; Rita Verri

**PHOTOGRAPH EXHIBIT**

The Project photographs in the lobby were taken by Stephanie Berger, Robert Blake and Barbara Ettinger. They are on sale, for the benefit of the Project. Framed (\$150) and Unframed (\$100). Please see Marsue Cumming or Willie Reale if you're interested in purchasing one.

THE PLAYMAKING PROGRAM IS FUNDED THROUGH A GENEROUS GRANT FROM THE EDUCATIONAL FOUNDATION OF AMERICA.

Donations will be gratefully accepted at the door!



THE SPRING THING

**THE SPRING PLANT** by Tina Vamvoukakis  
Dramaturg/Director.....Bill Elverman  
Isabel/Helen.....Kristine Sutherland  
Jason.....John Pankow

**THE STUDYING FRIENDSHIP** by Jill Barbosa  
Dramaturg/Director.....Daniel Judah Sklar  
Tom.....Alan Nebelthau  
Jenny.....Susan Willerman

**LOVE, MORE OR LESS** by Michael Schiff  
Dramaturg/Director.....Chris Ceraso  
Jake.....Jack Gilpin  
Carla.....Ann McDonough

**A DAY TORN TO RUINS** by Glen Jenkins  
Dramaturg.....Judy Dennis  
Director.....Willie Reale  
Tony Uma.....Lewis Black  
Lawk.....Peter MacNicol  
Angel of Death.....As Himself  
("Super Hero Theme Song" - lyrics by Lewis  
Black, Peter MacNicol and Willie Reale;  
music by Rob Reale. Recorded at Tenement  
Studios, New York City)

**TODAY IS YOUR LUCKY DAY** by Latanya Godfrey  
Dramaturg/Director.....Meredith Portman  
Anne.....Isabell Monk  
Joe.....Kevin O'Rourke

**THE LONELY TREE** by Shamine Gibson  
Dramaturg/Director.....Jan Buckaloo  
Lennie.....Arthur French  
Penny/Angie.....Lois Smith



THE 52ND STREET PROJECT gratefully acknowledges the support of the following foundations, corporations, government agencies and individuals:

Air-Flo Window Contracting Corporation, The Bay Foundation, Bilcrisue Charitable Foundation, Citibank, Dept. of Cultural Affairs, Dramatists Guild Fund, Educational Foundation of America, Fan Fox and Leslie R. Samuels Foundation, Manhattan Community Arts Fund, The Joyce-Mertz Gilmore Foundation, Morgan Stanley Foundation, New World Foundation, New York City Youth Bureau, New York Times Company Foundation, The Samuel and May Rudin Foundation &

Renee Allmen  
Allan Arffa/Kay  
Matschullat  
Elizabeth Barhydt  
Jo Baslow  
Stephanie Berger  
Andre Bishop  
Eleanor & Gerard  
Bissinger  
Patrick Boll  
Katherine Borowitz/  
John Turturro  
Douglas Borrie  
Garrett M. Brown  
Iris Brown  
Mrs. Mack Buckaloo  
Laura Maria  
Censabella  
Ellen Chenoweth  
Joel Coen  
Ruth Cohen  
Joan & Roger Craton  
anet Crawford  
Bill Cwikowski/  
Katharine Long  
Curt Dempster  
Arlene Donovan  
John Dossett  
John H. Douglas  
June & Jack Dunbar  
Jeannine Edmonds  
Caroline & John Ellis  
Moy Eng  
John & Kitty Errett  
Mrs. B. L. Ettinger  
Barbara Ettinger/  
Robert Blake  
Albert & Elizabeth  
Faber  
Richard Fox  
David Frankel  
Bruno and Roslyn  
Freudenthal  
Elizabeth Friedman  
Jack Gilpin  
Leonard & Marita  
Gochman  
Mark & Barbara Gordon  
Alice R. Gottesman  
Stephen Graham  
Edward & Flavia  
Grimm  
Laura Gugenheim  
Andrew Hajducky

Keith Haring  
Jane Harmon & Assoc.  
Kathleen Held  
David Herdrich  
Peter Herdrich  
William Herdrich  
Jane Hoffman  
J. Alan Hostetler  
Barnard Hughes/  
Helen Stenborg  
Laura Hughes  
Norman Jewison  
Cindy Lou Johnson  
Jyll Johnstone  
Elinor Jones  
Robert, Mary &  
Ruby Joy  
Mary Kane  
Berrilla Kerr  
Rita Knox/Stephen  
Cohen  
Tom Kopache  
Henry D. Krieger  
Pam & Andrew Lack  
Zohra Lampert/Paul  
Forman  
Paula Landesman  
Heidi & Rocco  
Landesman  
Knight Landesman  
Bernard Lee  
Per Lofving/Martha  
Evans  
Marjorie Longley  
John Lyons  
M Group  
Marsue & Peter  
MacNiccol  
Greg MacPherson  
Bruce MacVittie/Ann  
Tallman  
Grace Malico  
Emily Mann  
Donald Margulies/  
Lynn Street  
Paul McCrane  
Karen McCree  
James & Hannelore  
McDaniel  
Robert McDonald  
Fran McDormand  
William McElhiney  
Julia Miles  
Janet & Alan Morell

Steven J. O'Neill  
Kate Nelligan  
Peter Neufeld  
Kevin O'Rourke  
Eric Overmyer  
Ellen Parker/Mack  
Lipkin  
Steve & Barbara Perry  
Mr. & Mrs. T. Plant  
Mr. & Mrs. Gene Reale  
Paul Reale  
James Revson  
Lillian Rhodes  
Emily Riddle  
Elizabeth Rigg  
Jose Rivera  
Ellen & Bruce Roseman  
Alice Rubin  
Judith O. Rubin  
Joyce Rudnick  
Timothy Sanford  
Alex Schaap  
Kathy Schleyer  
Jeffrey Schwartz  
Jos. Seagrams & Sons  
John Patrick Shanley/  
Jayne Haynes  
Carol Shapiro  
Sloane Shelton/Jan  
Buckaloo  
Robert Sherman  
Robert Siegler  
Lois Smith  
Sheila K. Sobel  
Nancy Stahl  
Jody Steiner  
Lauren Swift  
John and Joan Vail  
Thorne  
Karen Trott  
Lisa Vaamonde  
Laura Valeroso  
Kevin Ward  
Wendy Wasserstein  
Ira Weitzman  
Donna & Walter Wick  
Mr. & Mrs. Robert  
Wilder  
Susan Willerman  
Marie Winn  
Andrew & Hannah Wolk  
James Yoshimura  
Janet Zarish

THE ENSEMBLE STUDIO THEATRE PRESENTS  
THE 52ND STREET PROJECT'S

# BEDTIME ZONE

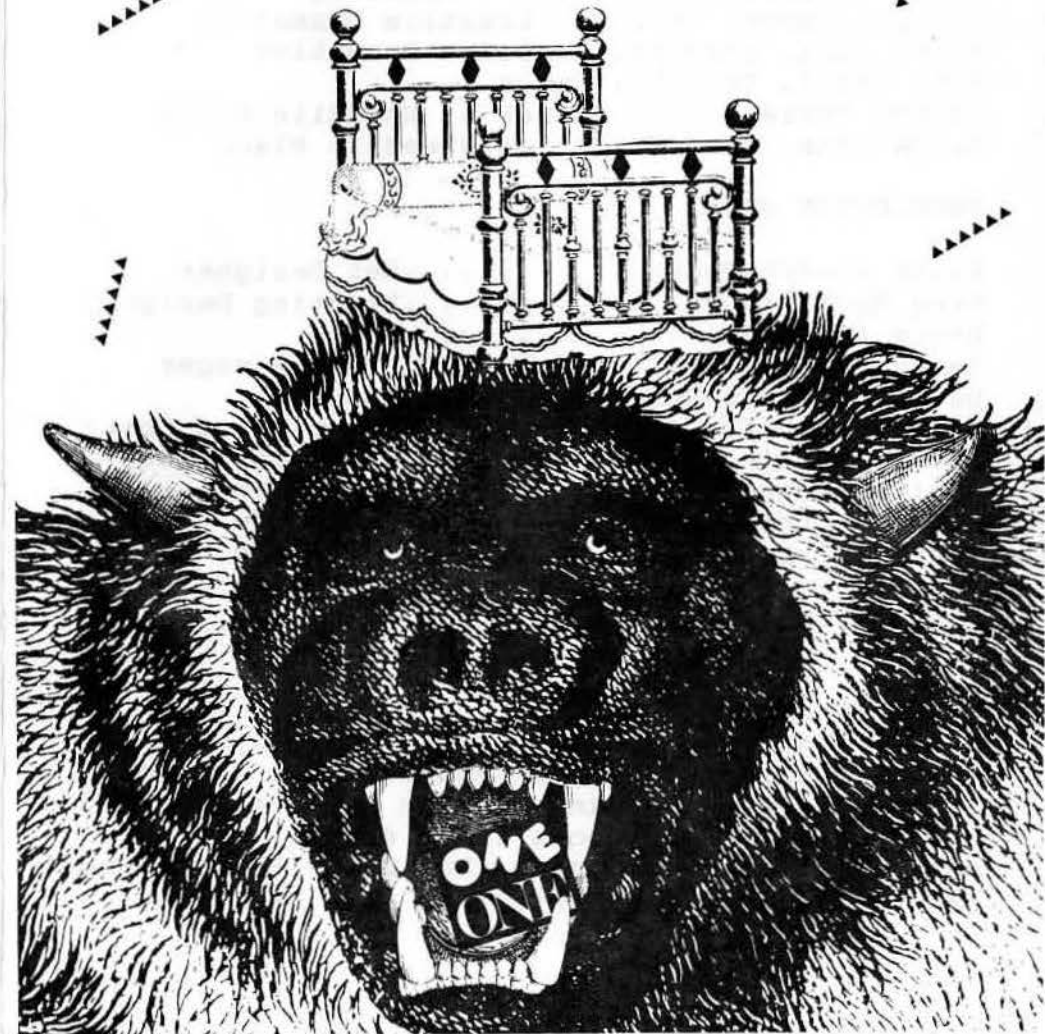



**THE 52ND STREET PROJECT**  
Presents  
**THE BEDTIME ZONE**

**PROJECT STAFF**

Willie Reale, Artistic Director  
Marsue Cumming, Executive Director  
Daniel Judah Sklar, Dir. of Literary Programming  
Susan Willerman, Teacher, Playmaking  
Jessica Feder, Teacher, Creative Dramatics  
Donna Wick, Teacher, Creative Dramatics  
Rita Verri, Teacher, Dance  
George Babiak, 52nd Street at Rheedlin Place  
Marya Cohn, 52nd Street at Rheedlin Place

**PRODUCTION STAFF**

Kevin Joseph Roach.....Set Designer  
Greg MacPherson.....Lighting Designer  
Bruce A. Cohen.....Press  
Jenny Peek.....Stage Manager  
David Soo/Paul McCrane.....Sound  
Milard Corbett.....Light Board Operator  
Iris A. Brown.....Graphics/Slides  
Joelle Bochner.....Tech Crew  
Denise Johnsson.....Tech Crew  
Heather Pylant.....Tech Crew  
Ron Riley.....Tech Crew  
Tracy Knights.....Tech Crew

**THE 52ND STREET PROJECT** is dedicated to the creation and production of original plays and musicals for a company of children who reside in the Times Square and Clinton Hill neighborhoods. The Project's main focus is to create acting vehicles for the children that allow them to show off their particular skills to best advantage.

**ADVISORY COMMITTEE**

Joan Craton  
Barbara L. Ettinger  
Wendy Ettinger, Chair  
Jeannine Edmonds  
Jack Gilpin  
Stephen Graham  
Lynne Gugenheim  
Heidi Landesman  
Carmen Matias  
Frances McDormand  
Bob Saidenberg  
Kevin Ward  
John Wulp

**IN-KIND CONTRIBUTIONS**

Ensemble Studio Theatre, Police Athletic League, Colorforms, Goldstein, Schrank, Segelstein & Shays, Ben Barenholtz, Sheridan Elson, Materials for the Arts, New Pond Foundation

**SPECIAL THANKS TO:**

Curt Dempster, Peter Shavitz and the E.S.T. Staff; Frances McDormand and Joel Coen; Wendy Ettinger; Charles Shays and Patricia Murphy; Dave Mead; Carol Rosegg and the Martha Swope Studio; Victoria Leach; P.A.L. Staff; Bob and Lyn Reale; Dr. Christina Biaggi; Virginia Dare and Joya Verde; Frances Fargardo; Karen and Annette Myrie; Lauren Swift; Rosemary DeBlasi; Julia Fraser; Rob Reale; Milard Corbett; Rosemary Portillo and the Edenwald Center; Al Sharpton's stylist; Raisa Gorb chev; Walt Disney; Bill Havens; Pam Lack; Colin Greer and Alta Starr; Pete Fisk; Bill Fagerbakke, Max Sanabria; Lennette Fletcher

**THE BEDTIME ZONE** plays were developed last summer as part of the Project's **ONE-ON-ONE** Program, when 19 kids and 19 writers collaborated on 19 new plays during a week-long stay outside of New York City.

THIS PRODUCTION OF "THE BEDTIME ZONE" HAS BEEN MADE POSSIBLE IN PART BY A GRANT FROM THE LEONARD N. STERN FOUNDATION.

**THE BEDTIME ZONE**  
Evening A  
April 5th - 9th, 1989

**HE WHO LAUGHS LAST** by Kathryn Rossetter  
Agent Mr. Devil.....Richard Myrie  
S Black.....Himself

**NOT AS GOOD AS THE ORIGINAL** by James Yoshimura  
Alex.....Alex Bess  
Miss Kane.....Mary Kane

**SCOUT'S HONOR** by Willie Reale  
Joe.....Willie Reale  
Angie.....Danielle Ferrin

**STUCK ON TWOSIES** by Lewis Black  
Suzie.....Kathryn Rossetter  
Betty Lou.....Virginia Vargas

**THE EXTRA-TERRESTRIAL HAIRDRESSER**  
by Cindy Lou Johnson  
Gene.....Frances McDormand  
Scary Harry.....Arlen Collier

-Intermission-

**BUTCH CASSIDY AND THE TAGALONG KID**  
by James McDaniel  
Butch Cassidy.....Artiba Fortune  
Tagalong.....James McDaniel

**BEAT-THE-EGG** by Donald Margulies  
Joe Goldmine.....Donald Margulies  
Karen.....Jessica Soto

**A CAMPFIRE STORY** by Ben Siegler  
Shamine.....Shamine Gibson  
Ben.....Ben Siegler  
.....James McDaniel

**EUGENIE** by Fracaswell Hyman  
Homer.....Fracaswell Hyman  
Eugenie.....Jose Soto  
The Eugenie Dancers.....Paula Myrie, Danielle  
Ferrin, Jessica Soto  
Choreographer.....Paula Myrie

Thank you for coming tonight. If you are not, but would like to be, on our mailing list, please fill out the form below and give it to us on your way out, or mail it to the address below.

If you enjoyed yourself tonight, please join us for EVENING B which runs from April 12th through 16th - same times, same place. Call 245-1350 for reservations. We would also like to know if you would like to be of help to us in the future (fundraising, technical crew, acting, writing, teaching, printing, etc.). If so, please fill out your name, number and area of interest below.

-----  
Please add my name to the mailing list:

NAME: \_\_\_\_\_

ADDRESS: \_\_\_\_\_

\_\_\_\_\_ Zip Code

-----  
Yes, I would like to help:

NAME: \_\_\_\_\_

DAYTIME PHONE: \_\_\_\_\_

AREA(S) OF INTEREST: \_\_\_\_\_

-----  
If you would like to mail this, and/or a donation, you can send them to: The 52nd Street Project, c/o Ensemble Studio Theatre, 549 West 52nd Street, New York, NY 10019. (212) 245-1350.

THE 52ND STREET PROJECT gratefully acknowledges the support of the following foundations, corporations, government agencies and individuals:

Air-Flo Window Contracting Corporation, The Bay Foundation, Bilcrisue Charitable Foundation, Citibank, Dept. of Cultural Affairs, Dramatists Guild Fund, Educational Foundation of America, Fan Fox and Leslie R. Samuels Foundation, Manhattan Community Arts Fund, The Joyce-Mertz Gilmore Foundation, Morgan Stanley Foundation, New World Foundation, New York City Youth Bureau, New York Times Company Foundation, The Samuel and May Rudin Foundation &

Renee Allmen  
Allan Arffa/Kay  
Matschullat  
Elizabeth Barhydt  
Jo Baslow  
Stephanie Berger  
Andre Bishop  
Eleanor & Gerard  
Bissinger  
Patrick Boll  
Katherine Borowitz/  
John Turturro  
Douglas Borrie  
Garrett M. Brown  
Iris Brown  
Mrs. Mack Buckaloo  
Laura Maria  
Censabella  
Ellen Chenoweth  
Joel Coen  
Ruth Cohen  
Joan & Roger Craton  
anet Crawford  
Bill Cwikowski/  
Katharine Long  
Curt Dempster  
Arlene Donovan  
John Dossett  
John H. Douglas  
June & Jack Dunbar  
Jeannine Edmonds  
Caroline & John Ellis  
Moy Eng  
John & Kitty Errett  
Mrs. B. L. Ettinger  
Barbara Ettinger/  
Robert Blake  
Albert & Elizabeth  
Faber  
Richard Fox  
David Frankel  
Bruno and Roslyn  
Freudenthal  
Elizabeth Friedman  
Jack Gilpin  
Leonard & Marita  
Gochman  
Mark & Barbara Gordon  
Alice R. Gottesman  
Stephen Graham  
Edward & Flavia  
Grimm  
Laura Gugenheim  
Andrew Hajducky

Keith Haring  
Jane Harmon & Assoc.  
Kathleen Held  
David Herdrich  
Peter Herdrich  
William Herdrich  
Jane Hoffman  
J. Alan Hostetler  
Barnard Hughes/  
Helen Stenborg  
Laura Hughes  
Norman Jewison  
Cindy Lou Johnson  
Jyll Johnstone  
Elinor Jones  
Robert, Mary &  
Ruby Joy  
Mary Kane  
Berrilla Kerr  
Rita Knox/Stephen  
Cohen  
Tom Kopache  
Henry D. Krieger  
Pam & Andrew Lack  
Zohra Lampert/Paul  
Forman  
Paula Landesman  
Heidi & Rocco  
Landesman  
Knight Landesman  
Bernard Lee  
Per Lofving/Martha  
Evans  
Marjorie Longley  
John Lyons  
M Group  
Marsue & Peter  
MacNicol  
Greg MacPherson  
Bruce MacVittie/Ann  
Tallman  
Grace Malico  
Emily Mann  
Donald Margulies/  
Lynn Street  
Paul McCrane  
Karen McCree  
James & Hannelore  
McDaniel  
Robert McDonald  
Fran McDormand  
William McElhiney  
Julia Miles  
Janet & Alan Morell

Steven J. O'Neill  
Kate Nelligan  
Peter Neufeld  
Kevin O'Rourke  
Eric Overmyer  
Ellen Parker/Mack  
Lipkin  
Steve & Barbara Perry  
Mr. & Mrs. T. Plant  
Mr. & Mrs. Gene Reale  
Paul Reale  
James Revson  
Lillian Rhodes  
Emily Riddle  
Elizabeth Rigg  
Jose Rivera  
Ellen & Bruce Roseman  
Alice Rubin  
Judith O. Rubin  
Joyce Rudnick  
Timothy Sanford  
Alex Schaap  
Kathy Schleyer  
Jeffrey Schwartz  
Jos. Seagrams & Sons  
John Patrick Shanley/  
Jayne Haynes  
Carol Shapiro  
Sloane Shelton/Jan  
Buckaloo  
Robert Sherman  
Robert Siegler  
Lois Smith  
Sheila K. Sobel  
Nancy Stahl  
Jody Steiner  
Lauren Swift  
John and Joan Vail  
Thorne  
Karen Trott  
Lisa Vaamonde  
Laura Valeroso  
Kevin Ward  
Wendy Wasserstein  
Ira Weitzman  
Donna & Walter Wick  
Mr. & Mrs. Robert  
Wilder  
Susan Willerman  
Marie Winn  
Andrew & Hannah Wolk  
James Yoshimura  
Janet Zarish

THE ENSEMBLE STUDIO THEATRE PRESENTS  
THE 52ND STREET PROJECT'S

# BEDTIME ZONE

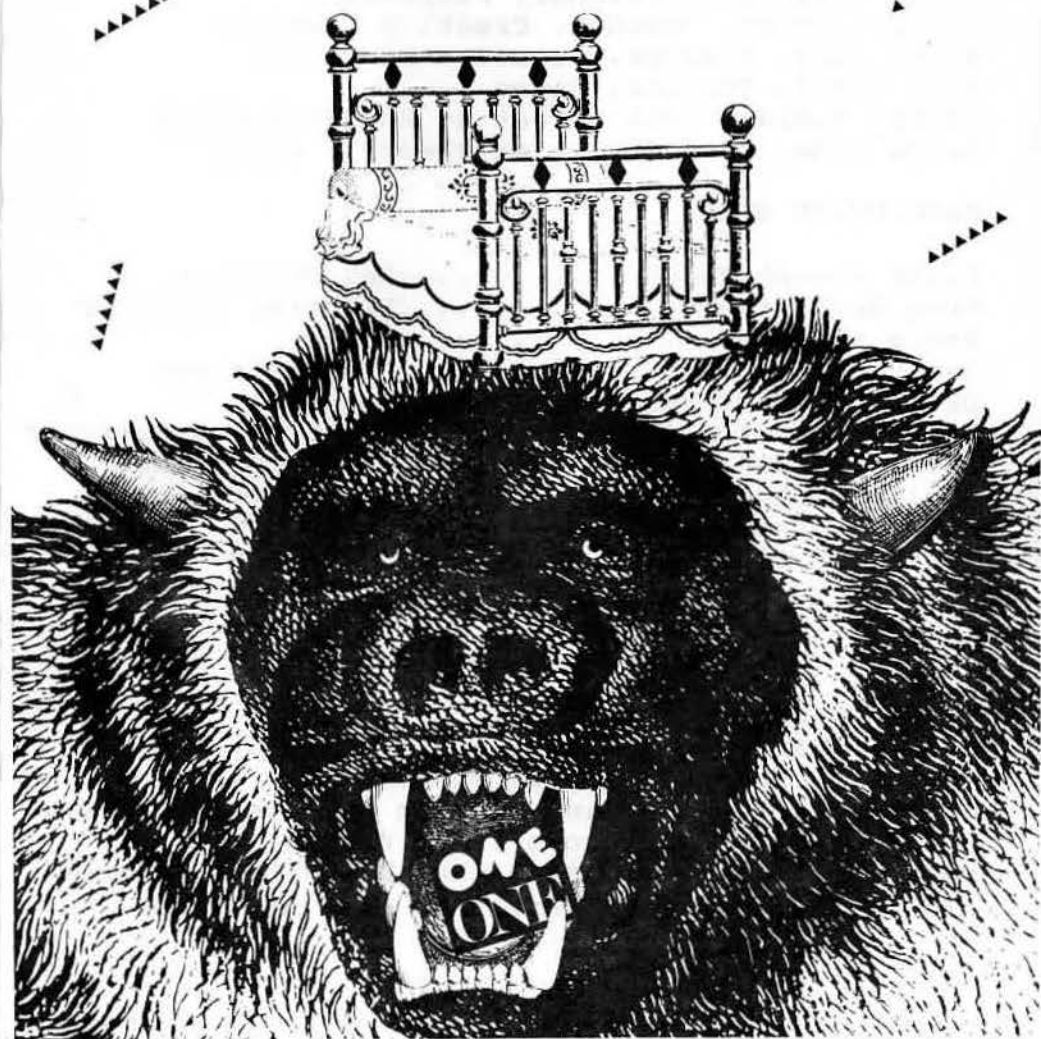



**THE 52ND STREET PROJECT**  
Presents  
**THE BEDTIME ZONE**

**PROJECT STAFF**

Willie Reale, Artistic Director  
Marsue Cumming, Executive Director  
Daniel Judah Sklar, Dir. of Literary Programming  
Susan Willerman, Teacher, Playmaking  
Jessica Feder, Teacher, Creative Dramatics  
Donna Wick, Teacher, Creative Dramatics  
Rita Verri, Teacher, Dance  
George Babiak, 52nd Street at Rheedlin Place  
Marya Cohn, 52nd Street at Rheedlin Place

**PRODUCTION STAFF**

Kevin Joseph Roach.....Set Designer  
Greg MacPherson.....Lighting Designer  
Bruce A. Cohen.....Press  
Jenny Peek.....Stage Manager  
David Soo/Paul McCrane.....Sound  
Milard Corbett.....Light Board Operator  
Iris A. Brown.....Graphics/Slides  
Joelle Bochner.....Tech Crew  
Denise Johnsson.....Tech Crew  
Heather Pylant.....Tech Crew  
Ron Riley.....Tech Crew  
Tracy Knights.....Tech Crew

**THE 52ND STREET PROJECT** is dedicated to the creation and production of original plays and musicals for a company of children who reside in the Times Square and Clinton Hill neighborhoods. The Project's main focus is to create acting vehicles for the children that allow them to show off their particular skills to best advantage.

**ADVISORY COMMITTEE**

Joan Craton  
Barbara L. Ettinger  
Wendy Ettinger, Chair  
Jeannine Edmonds  
Jack Gilpin  
Stephen Graham

Lynne Gugenheim  
Heidi Landesman  
Carmen Matias  
Frances McDormand  
Bob Saidenberg  
Kevin Ward  
John Wulp

**IN-KIND CONTRIBUTIONS**

Ensemble Studio Theatre, Police Athletic League, Colorforms, Goldstein, Schrank, Segelstein & Shays, Ben Barenholtz, Sheridan Elson, Materials for the Arts, New Pond Foundation

**SPECIAL THANKS TO:**

Curt Dempster, Peter Shavitz and the E.S.T. Staff; Frances McDormand and Joel Coen; Wendy Ettinger; Charles Shays and Patricia Murphy; Dave Mead; Carol Rosegg and the Martha Swope Studio; Victoria Leach; P.A.L. Staff; Bob and Lyn Reale; Dr. Christina Biaggi; Virginia Dare and Joya Verde; Frances Fargardo; Karen and Annette Myrie; Lauren Swift; Rosemary DeBlasi; Julia Fraser; Rob Reale; Milard Corbett; Rosemary Portillo and the Edenwald Center; Al Sharpton's stylist; Raisa Gorb chev; Walt Disney; Bill Havens; Pam Lack; Colin Greer and Alta Starr; Pete Fisk; Bill Fagerbakke, Max Sanabria; Lennette Fletcher

**THE BEDTIME ZONE** plays were developed last summer as part of the Project's **ONE-ON-ONE** Program, when 19 kids and 19 writers collaborated on 19 new plays during a week-long stay outside of New York City.

THIS PRODUCTION OF "THE BEDTIME ZONE" HAS BEEN MADE POSSIBLE IN PART BY A GRANT FROM THE LEONARD N. STERN FOUNDATION.

**THE BEDTIME ZONE**  
Evening B  
April 12th - 16th, 1989

**USEFUL TRASH** by Leigh Curran

Mikey.....Mikey Lugo  
Ma.....Leigh Curran  
River.....Paul McCrane

**HOW LONG HAVE I BEEN SLEEPING?** by Katharine Long

Darlene.....Shirley Rumierk  
Miss Hawkins.....Katharine Long

**PUNCH THE CLOCK** by Janet Zarish and Kulondi Frier

Gloria.....Kulondi Frier  
Leslie.....Polly Adams

**A NIGHT AT THE OPRAH** by Nancy Giles

Mother.....Nancy Giles  
Clarissa.....Karen Myrie  
Voice of Max.....Ben Siegler  
Makeup Artist.....Frances Fargardo  
Hairdo Artist.....Kulondi Frier

-INTERMISSION-

**THE HOMEWORKING** (or The PeeWee Possession)  
by Lee Costello

Dad.....Bruce MacVittie  
Lee.....Lee Costello  
Dawn.....Dawn Jackson

**COTTAGE SMALL BY WATERFALL** by Willie Reale

Ellen.....Mary Kane  
Sprite.....Edwin Maldonado, Jr.  
Jack.....Willie Reale

**THE EMISSARY** by Bruce MacVittie

G.A.....Frances Fargardo  
Man.....Bruce MacVittie

**AND YOU CALL YOURSELF A KID** by Richard Dresser  
and Greg Germann

Dominique.....Paula Myrie  
Dad.....Peter MacNicol

Thank you for coming tonight. If you are not, but would like to be, on our mailing list, please fill out the form below and give it to us on your way out, or mail it to the address below.

If you enjoyed yourself tonight, please join us for EVENING B which runs from April 12th through 16th - same times, same place. Call 245-1350 for reservations. We would also like to know if you would like to be of help to us in the future (fundraising, technical crew, acting, writing, teaching, printing, etc.). If so, please fill out your name, number and area of interest below.

-----  
Please add my name to the mailing list:

NAME: \_\_\_\_\_

ADDRESS: \_\_\_\_\_

\_\_\_\_\_ Zip Code

-----  
Yes, I would like to help:

NAME: \_\_\_\_\_

DAYTIME PHONE: \_\_\_\_\_

AREA(S) OF INTEREST: \_\_\_\_\_

-----  
If you would like to mail this, and/or a donation, you can send them to: The 52nd Street Project, c/o Ensemble Studio Theatre, 549 West 52nd Street, New York, NY 10019. (212) 245-1350.

THE 52ND STREET PROJECT gratefully acknowledges the support of the following foundations, corporations, government agencies and individuals:

Bilcrisue Charitable Trust, Citibank, D-B Trust; Dramatists Guild Fund; Educational Foundation of America; Fan Fox and Leslie R. Samuels Foundation; James A. Macdonald Foundation; Manhattan Community Arts Fund; The Joyce Mertz-Gilmore Foundation; Morgan Stanley Foundation; New World Foundation; New York Times Company Foundation; The Samuel & May Rudin Foundation, Spunk Fund, Inc.; The Young Women's League of Westport and

Polly Adams  
Catherine Allegra  
Renee Allmen  
Jane Anderson  
Allan Arffa/Kay  
Matschullat  
Jo Baslow  
Stephanie Berger  
Eleanor & Gerard  
Bissinger  
Juelle Bochner  
Patrick Boll  
Katherine Borowitz/  
John Turturro  
Garrett M. Brown  
Iris Brown  
Laura Maria  
Censabella  
Ellen Chenoweth  
Joel Coen  
Ruth Cohen  
Tom Cook/Susan  
Terner  
Joan & Roger Craton  
Janet Crawford  
Bill Cwikowski/  
Katharine Long  
Leslee G. Dart  
John Henry & Amy  
Introcaso Davis  
Curt Dempster  
G.H. Dennison/  
Christine Thomas  
Arlene Donovan  
John H. Douglas  
Richard & Rebecca  
Dresser  
June & Jack Dunbar  
Caroline & John Ellis  
John & Kitty Errett  
Mrs. B. L. Ettinger  
Barbara Ettinger/  
Robert Blake  
Albert & Elizabeth  
Faber  
Janet Foster/Michael  
Geiger  
David Frankel  
Bruno & Roslyn  
Freudenthal  
Elizabeth Friedman

Nancy Giles  
Mark & Barbara Gordon  
Stephen Graham  
Edward & Plavia  
Grimm  
Emily Grishman  
Gregory Grove  
Laura Gugenheim  
Lisa J. Gugenheim  
Jane Harmon & Assoc.  
David Herdrich  
Peter Herdrich  
William Herdrich  
Jane Hoffman  
Mark Hollinger  
Barnard Hughes/  
Helen Stenborg  
Norman Jewison  
Denise Johnsson  
Elinor Jones  
Robert, Mary &  
Ruby Joy  
Nancy Kammer  
Mary Kane  
Berrilla Kerr  
Tracy Knights  
Rita Knox/Stephen  
Cohen  
Tom Kopache  
Lynn Kressel  
Henry D. Krieger  
Pam Lack  
Zohra Lampert/Paul  
Forman  
Knight Landesman  
Matthew Lewis  
Per Lofving/Martha  
Evans  
John Lyons  
M Group  
Cathy MacNeil  
Marsue & Peter  
MacNicol  
Greg MacPherson  
Grace Malico  
Emily Mann  
David Margulies  
Donald Margulies,  
Lynn Street  
Ann M. Martin  
Henry Martin

Jane Read Martin  
Lisa Maurer  
Paul McCrane  
James & Hannelore  
McDaniel  
Frances McDormand  
William McElhiney  
Julia Miles  
David Misch  
Robert Moss  
Kate Nelligan  
Peter Neufeld  
Steven J. O'Neill  
Kevin O'Rourke/  
Edith Thurber  
Eric Overmyer  
John & Kristine  
Pankow  
Ellen Parker/Mack  
Lipkin  
Mary Ellen Parks  
Mr. & Mrs. T. Plant  
Mr. & Mrs. Gene Reale  
Paul Reale  
Ellen & Bruce Roseman  
Joyce Rudnick  
Timothy Sanford  
Jos. Seagrams & Sons  
John Patrick Shanley/  
Jayne Haynes  
Barry Shapiro  
Carol Shapiro  
Robert Siegler  
Lois Smith  
Sheila K. Sobel  
Nancy Stahl  
Jody Steiner  
Alberta Stout  
John & Joan Vail  
Thorne  
Wendy Wasserstein  
Ira Weitzman  
Mr. & Mrs. Robert  
Wilder  
Susan Willerman  
  
Marie Winn  
Andrew & Hannah Wolk  
James Yoshimura  
Janet Zarish

THE 52ND STREET PROJECT  
In Conjunction With The Police Athletic League and The Ensemble Studio Theatre  
Present the Annual One-On-Ones



"You Can't  
Copyright A  
Title"



Flyer Design: Brown

Artistic Director:  
Willie Reele



Executive Director:  
Marsue Cumming



THE 52ND STREET PROJECT  
Presents  
"YOU CAN'T COPYRIGHT A TITLE"

The 1989



PROJECT STAFF

Willie Reale, Artistic Director  
Marsue Cumming, Executive Director  
Daniel Judah Sklar, Dir. of Literary Programming  
Raquel Chung, Intern  
Paula Myrie, Assistant

PRODUCTION STAFF

Kevin Joseph Roach, Set Designer  
Greg MacPherson, Lighting Designer  
Henry Krieger, Musical Director  
Bruce Cohen/Victoria Lynch, Press Representatives  
Michael Ritchie, Stage Manager  
Shane Tillstom, Light Board Operator  
Iris A. Brown, Graphics/Slides  
Stephanie Berger, Still Photographer  
David Soo, Technical Director  
Julia Fraser, Tech Crew  
Tracy Knights, Tech Crew  
Paula Myrie, Tech Crew  
Jenny Peek, Tech Crew  
Wendy Radford, Tech Crew  
Raquel Chung, House Manager

THE 52ND STREET PROJECT is dedicated to the creation and production of original plays and musicals for a company of inner-city children. The Project's main focus is to create vehicles for the children that allow them to show off their particular skills and talent to best advantage.

ADVISORY COMMITTEE

Joan Craton  
Barbara L. Ettinger  
Wendy Ettinger, Chair  
Jane Edmonds  
Jack Gilpin  
Stephen Graham

Lynne Gugenheim  
Heidi Landesman  
Carmen Matias  
Frances McDormand  
Bob Saidenberg  
Kevin Ward  
John Wulp

IN-KIND CONTRIBUTIONS

Ensemble Studio Theatre; Police Athletic League; Colorforms; Goldstein, Schrank, Segelstein & Shays; Ben Barenholtz; Sheridan Elson; Materials for the Arts; Knox Associates

SPECIAL THANKS TO:

Curt Dempster, Peter Shavitz and the E.S.T. Staff; Marthe LeVan; P.A.L. Duncan Center Staff; Charles Shays and Patricia Murphy; Rita Knox and Knox Associates; Carol Rosegg and the Martha Swope Studio; Martha Velie-Gass; Pat McQuade; Annie and John O'Shaughnessy; Ed McGovern; Prudy and Mary Beth from The Ice Cream Place; Block Island Realty, Dave Schaller; Interstate Navigation Co.; Hunter Tracy; Rob Lee; Peter Wood and The Block Island Times; Brian Salzberg and "The Works"; Joe Brennan; Bobby Littlefield; Estes Gift Shop; Natalie Mitchell; Marty Moser; Marcia Donner; Happy and Chris Davis; Rob Reale; Pat Swan; Rose Mastrangelo; Fred Benson; Carol & Audrey and the High View; McQuades Marketplace; Peter Neufeld; Cynthia Allen; Ben Barenholtz; Jane Read Martin; Karin Barry; Jessica Feder; Tom Reale, Dr. Christina Biaggi; Joya Verde; Virginia Dare; "The Dream Team"; "The Reporters"; Lou, the dog; Hugh Sinclair Rocco Iacocca AND Bob and Lyn Reale!

"CAN'T COPYRIGHT A TITLE" plays were developed last week, on Block Island, as part of the Project's ONE-ON-ONE program. Eleven kids and eleven playwrights and actors collaborated on these eleven new plays during their week-long stay outside of New York City.

**"YOU CAN'T COPYRIGHT A TITLE"**

August 2nd - 5th, 1989

**THE MUMMY** by Peter Herdrich, Karen Trott  
& Shamine Gibson

Willy.....Shamine Gibson  
ie Mummy.....Karen Trott

"The Mummy Theme Song"  
music by Henry Krieger  
lyrics from "The Mummy"

**I REMEMBER MAMA** by Thomas Babe  
Miriam.....Pamala Tyson  
Julia.....Jessica Cordero

"Happy Face, Funny Face"  
music & lyrics by Pamala Tyson  
arranged by Henry Krieger

**THE BIG SLEEP** by Lewis Black  
Misael.....Misael Reyes  
Lewis.....Lewis Black

**GREAT EXPECTATIONS** by Richard Dresser  
Motorperson #1, Old Lady,  
& Motorperson #2.....Mary Kane  
Mikey.....Mikey Lugo

Act I  
-15 second Intermission-  
Act II  
-10 second Intermission-  
Act III

"Yesterday's Tomorrow"  
music by Henry Krieger  
lyrics by Richard Dresser

**MOOSE MURDERS** by Kathryn Rossetter  
ody Gannon.....Tina Vamvoukakis  
Cleaning Lady, Woman,  
Friday & Mall Chick....Kathryn Rossetter

Thank you for coming tonight. If you are not, but would like to be, on our mailing list, please fill out the form below and give it to us on your way out, or mail it to the address below. Please watch for notices for our next production, "The Sub-Atomic Musical" which will be presented in September at The Lamb's Theatre. We would also like to know if you would like to be of help to us in the future (areas of particular need include fundraising, technical crew, printing, teaching). If so, please fill out your name, number and area of interest.

-----  
Please add my name to the mailing list:

NAME: \_\_\_\_\_

ADDRESS: \_\_\_\_\_

\_\_\_\_\_ Zip Code

-----  
Yes, I would like to help:

NAME: \_\_\_\_\_

DAYTIME PHONE: \_\_\_\_\_

AREA(S) OF INTEREST: \_\_\_\_\_

-----  
If you would like to mail this, and/or a donation, you can send them to: The 52nd Street Project, c/o Ensemble Studio Theatre, 549 W. 52nd Street, New York, NY 10019. (212) 245-1350.

**GONE WITH THE WIND** by Fracaswell Hyman  
Ray.....Fracaswell Hyman  
Malcolm.....David Stevens

"Single Parent's Survival Kit"  
music & lyrics by Fracaswell Hyman  
arranged by Henry Krieger

**-INTERMISSION-**

**WHO'S AFRAID OF VIRGINIA WOLF?** by Willie Reale  
Virginia.....Annette Myrie  
Voice of Mom Wolf.....Pamala Tyson  
Mergatroid, the sheep..Willie Reale  
Shepherd.....Peter Herdrich

"It's Tough To Be Tough When You're Tender" and  
"The Salad Ballad"  
music by Henry Krieger  
lyrics by Willie Reale

**THE IMAGINARY INVALID** by Ben Siegler  
Ivonne.....Venus Batista  
Mom.....Kathryn Rossetter  
Playmate.....Tina Vamvoukakis

"Don't You Think So"  
music & lyrics by Henry Krieger

**GOODBYE, MR. CHIPS** by Peter MacNicol  
Slim.....Peter MacNicol  
Fred.....Karen Myrie  
Mac, Tired Man, Cosmo..James McDaniel

"The Road to Thespia"  
music & lyrics by Peter MacNicol  
arranged by Henry Krieger

**THE GRAPES OF WRATH** by Ned Eisenberg  
Joe.....Ned Eisenberg  
Hope.....Shirley Rumierk  
Connie.....Pamala Tyson

**THE IDIOT** by Cindy Lou Johnson  
Narrator.....Ned Eisenberg  
Prince Bob.....James McDaniel  
Stage Manager.....Willie Reale  
King Bill.....Richard Myrie

"You Got Me"  
music by Henry Krieger  
lyrics by Cindy Lou Johnson

**THE 52nd STREET PROJECT** gratefully acknowledges the support of the following foundations, corporations, government agencies and individuals:

Bikrisue Charitable Trust; Citibank, D-B Trust; Dramatists Guild Fund; Educational Foundation of America; Fan Fox and Leslie R. Samuels Foundation; James A. Macdonald Foundation; Manhattan Community Arts Fund; Manhattan Island Swimming Association; The Joyce Mertz-Gilmore Foundation; Morgan Stanley Foundation; New World Foundation; New York Times Company Foundation; The Samuel & May Rudin Foundation, Spunk Fund, Inc.; The Young Women's League of Westport and

Polly Adams	June & Jack Dunbar	Tom Kopache	Eric Overmyer
Catherine Allegra	Caroline & John Ellis	Lynn Kressel	John & Christine Pankow
Renee Allmen	John & Kitty Errett	Henry D. Krieger	Ellen Parker / Mack Lipkin
Jane Anderson	Mrs. B. L. Etinger	Pam Lack	Mary Ellen Parks
Allan Arffa / Kay Mauschullat	Barabra Etinger / Robert Blake	Zohra Lampert / Paul Forman	Nancy Piccione
Jean Bachrach	Susan Ewen / Ronnie Black	Knight Landesman	Mr. & Mrs. Gene Reale
Barbara Bakst	Albert & Elizabeth Faber	James & Joyce Lapenn	Paul Reale
Jo Baslow	Janet Foster / Michael Geiger	Mathew Lewis	Michael Ritchie / Kate Burton
Stephanie Berger	David Frankel	Per Lofving / Martha Evans	Ellen & Bruce Roseman
Eleanor & Gerard Bisinger	Bruno & Roslyn Freudenthal	John Lyons	Joyce Rudnick
Joelle Bochner	Elizabeth Friedman	M Group	Timothy Sanford
Patrick Boll	Nancy Giles	Cathy MacNeil	Sharon Schlarth
Katherine Borowitz / John Turturro	Mark & Barbara Gordon	Marsue & Peter MacNicol	John Patrick Shanley / Jayne Haynes
Garrett M. Brown	Stephen Graham	Greg MacPherson	Barry Shapiro
Iris A. Brown	Edward & Flavia Grimm	Grace Malico	Carol Shapiro
Tony Campisi	Emily Grishman	Emily Mann	Robert Siegler
Laura Maria Censabella	Gregory Grove	David Margulies	Lois Smith
Chris & Carla Ceraso	Laura Gugenheim	Donald Margulies / Lynn Street	Sheila K. Sobel
Cheryl Chalmers	Lisa J. Gugenheim	Ann M. Martin	Nancy Stahl
Ellen Chenoweth	Jane Harmon & Assoc.	Henry Martin	Robert Stecker
Raquel Chung	David Herdrich	Jane Read Martin	Alberta Stout
Joel Coen	Peter Herdrich	Lisa Maurer	Andrew Swee / Eise Taylor-Swee
Ruth Cohen	William Herdrich	Joan McAllister	John & Joan Vail Thorne
Tom Cook / Susan Turner	Jane Hoffman	Paul McCrane	Tracy Thorne
Joan & Roger Craton	Mark Hollinger	James & Hannelore McDaniel	Peter Thurber
Janet Crawford	Barnard Hughes / Helen Stenborg	Frances McDormand	Wendy Wasserstein
Bill Cwikowski / Katharine Long	Norman Jewison	William McElhiney	Ira Weitzman
Leslee G. Dart	Denise Johnson	Julia Miles	Robert & Andrea Wiener
John Henry & Amy Introcaso Davis	Elinor Jones	David Misch	Mr. & Mrs. Robert Wilder
Curt Dempster	Robert, Mary & Ruby Joy	Robert Moss	Susan Willerman
G.H. Dennison / Christine Thomas	Nancy Kammer	Karen Myrie	Marie Winn
Arlene Donovan	Mary Kane	Kate Nelligan	Andrew & Hannah Wolk
John H. Douglas	Berrilla Kerr	Peter Neufeld	James Yoshimura
Richard & Rebecca Dresser	Tracy Knights	Ellen Novack	Janet Zarish
	Rita Knox / Stephen Cohen	Michael O'Neill	
		Steven J. O'Neill	
		Kevin O'Rourke / Edith Thurber	

**IN-KIND CONTRIBUTIONS**

Ensemble Studio Theatre; Police Athletic League; Lamb's Theatre; Colorforms; Goldstein, Schrank, Segelstein and Shays; Sanford Goldstein; Ben Barenholtz; Materials for the Arts; Knox Associates; Parker Brothers; Morrell and Company; Bernhardt Fudyma Design Group.



THE 52ND STREET PROJECT PRESENTS

A New Musical by  
**ROB & WILLIE REALE**

September 20th thru September 24th  
**THE LAMBS THEATRE**

## CAST (In Order of Appearance)

ELVIN FITZWATER	James McDaniel
RUSSELL ROOTS	Paul McGrane
SAMANTHA FITZWATER	Jessica Soto
PENELOPE FITZWATER	Mary Kane
MELVIN FITZWATER	Clebert Ford
SCOOTER (AN ELECTRON)	Jose Soto
PAULA (A PROTON QUARK)	Paula Myrie
FRANCES (A NEUTRON QUARK)	Fran-Marie Fargardo
TIA (A PROTON QUARK)	Tia Nesmith
SHORTY (A PROTON QUARK)	Karen Myrie or Kulondi Frier
HEWT (A NEUTRINO)	Virginia Vargas
COLONEL WINSOME	Arlen Collier
MEISCHMONT	Peter MacNicol
ALEX (AN ANTI-QUARK)	Alex Bess
ARTIBA (AN ANTI-QUARK)	Artiba Fortune
AGNES	Frances McDormand
MOTHER FITZWATER	Annette Myrie

**AUTHOR'S NOTE:** *I am not a nuclear physicist. Most of the science in here is based on discoveries that have been made by men and women who are. As you will notice, this piece has mandated that I pose my own theories of particle physics. They are almost certainly bogus. However, in science as in art as in haberdashery, everyone is entitled to their own opinion.—WR*

## BAND

CONDUCTOR / GUITAR	Rob Reale
VIOLIN	Etienne Betz
CELLO	Nioka Workman
KEYBOARDS	Tim Ray
TRUMPET	Pete MacNamara
WOODWINDS	Rob DeBellis
WOODWINDS	Ron Kozak
BASS	Eric Massimino
DRUMS	James Murphy

## QUARK VICTORY PRODUCTION STAFF

DIRECTOR	Willie Reale	HOUSE MANAGER	Iris Bond
MUSICAL DIRECTOR	Rob Reale	ORCHESTRATORS	Gary Knox / Irwin Fisch
SET DESIGNER	Kevin Joseph Roach	MUSIC PREPARATION	Emily Grishman / Elise Bretton
COSTUME DESIGNER	Annie C. Patterson	LIGHTBOARD OPERATOR	Tracy Knights
LIGHTING DESIGNER	Greg MacPherson	SOUND OPERATOR	Scott Stauffer
SOUND DESIGNER	Bruce D. Cameron	PRODUCTION ASST.	Mina Hammer
CHOREOGRAPHER	Margie Castleman	ASST. CONDUCTOR	Tim Ray
DRAMATURG	Peter MacNicol	COSTUMIER	Janet Smith
STAGE MANAGER	Michael Ritchie	REHEARSAL PIANIST	Georg Brandel
ASST. STAGE MANAGER	Virginia Siegler	SCIENCE OFFICER	Paul Reale
GRAPHICS	Iris A. Brown	EVERYONE'S UNDERSTUDY	Karen Myrie
VEHICLE DESIGN	George Babiak	RUNNING CREW	Milard Corbett, Lee Costello, Noah Fleisher, Mina Hammer, Ron Riley, Neria Shelton, David Soo, Tracy Thorne, Annie Trush, Steve Wildern, Stuart Williams and Bill Wrubel

## PROJECT STAFF

ARTISTIC DIRECTOR	Willie Reale	ADMIN. / PRODUCTION ASST.	Mina Hammer
EXECUTIVE DIRECTOR	Marsue Cumming	INTERM	Annie Trush
DIR. OF LITERARY PROGRAMMING	Daniel Judah Sklar		

## ADVISORY COMMITTEE

Joan Craton	Jack Gilpin	Frances McDormand
Barbara L. Ettinger	Lynne Gugenheim	Bob Saldenberg
Wendy Ettinger, Chairperson	Heidi Landesman	Kevin Ward
Jeannine Edmonds	Carmen Matias	John Wulp

THE 52ND STREET PROJECT is an independent organization which operates with the help and cooperation of the Ensemble Studio Theatre and The Police Athletic League. It is dedicated to the creation and production of original plays and musicals for a company of inner-city children. The Project's main focus is to create vehicles for the children that allow them to show off their particular skills and talent to best advantage.

SET PROVIDED BY Hudson Scenic Studio, Inc. and Half Moon Productions.

THIS PROGRAM WAS MADE POSSIBLE in part by a grant from the Manhattan Community Arts Fund with public funds from the New York City Department of Cultural Affairs and from the Hon. David N. Dinkins, President of the Borough of Manhattan.

A VERY SPECIAL THANKS TO STEPHEN

## ACT I

TIME: <i>The Present</i>	PLACE: <i>A Laboratory</i>
Musical Numbers:	
SUDDENLY ALIVE†.....	<i>Russell and Elvin</i>
THROUGH THE CRACKS††.....	<i>Samantha</i>
THE BROTHER OF INDENTION†.....	<i>Melvin</i>
23 SKIDOO††.....	<i>Scooter, Samantha, Paula, Tia, Shorty, Frances, Newt</i>
LITTLE DID I KNOW††.....	<i>Penelope</i>
COLONEL WINSOME'S CRASH COURSE	
IN CHARM††.....	<i>Colonel Winsome, Paula, Tia, Meischmont</i>
WHERE DREAMS LIVE††.....	<i>Paula and Company</i>

THERE WILL BE A 15-MINUTE INTERMISSION BETWEEN ACTS

## ACT II

TIME: <i>One Second Later</i>	PLACE: <i>A Laboratory</i>
Musical Numbers	
ENTR'ACTE†.....	
BEING DIFFERENT†.....	<i>Frances and Russell</i>
IT'S LOVE†.....	<i>Alex, Artiba, Tia, Paula, Scooter and Samantha</i>
MAKE A WISH††.....	<i>Agnes</i>
FINALLY ALIVE†.....	<i>Tia and Company</i>

† Orchestrated by Irwin Fisch    †† Orchestrated by Gary Knox

## SPECIAL THANKS

*Ensemble Studio Theatre; Police Athletic League; Lamb's Theatre; Wendy Ettinger; Donna and Walter Wick; Lynn Barrett; Melissa Smith; Frances McDormand; James McDaniel; Lynnne Greene; Dave Smith; George Babiak, Dan Diggles and TheatreSports; Carolyn Rossi Copeland; Denise Nations; Clark Reiman; Rita Knox; Iris A. Brown; Lincoln Center; Lincoln Center Theater Company; Karin Barry; Carol Oakes; Patricia Murphy; Peter and Cathy Morrell; Henry D. Krieger; The Acting Company; ProMix; Lew Mead and Bob Rendon; By Special Arrangement; Intercoastal Fabrics; Herman's Formal Wear; Kevin O'Rourke; Bruce MacVittie; David Soo; Greg Grove; Dave Fuhrer; David Landay; Fred; Rachel Chanoff; Annie O'Sullivan; Playurights Horizons; Eileen Cowel; Mina Hammer; Annie Trush; Ginny Siegler; Jenny Peek; Stephanie Berger; Milard Corbett; Kate Nelligan; Don Kushner and Designers Workshop; Studio of Scene Painters (Najala Hanson, Judy Stillway, Mariana Asinari, Anne Cassidy); Tracy Crowther; Henry Vinas; Nada Guzman; Morgan Ritchie; Amy Birnbaum; Edith Thurber*

## THANK YOU FOR COMING TONIGHT

*If you are not, but would like to be, on our mailing list, please fill out the form below and give it to us on your way out, or mail to the address below. We would also like to know if you would like to be of help to us in the future (fundraising, technical crew, teaching, printing, etc.) If so, please fill out your name, number and area of interest below.  
Thanks Again.*

### PLEASE ADD MY NAME TO THE MAILING LIST:

Name .....

Address .....

..... Zip Code .....

### YES, I WOULD LIKE TO HELP:

Name .....

Daytime Phone .....

Area(s) of Interest .....

*If you would like to mail this, and/or a donation, you can send them to: The 52nd Street Project, c/o The Ensemble Studio Theatre, 549 West 52nd Street, New York, New York 10019 (212)245-1350.*

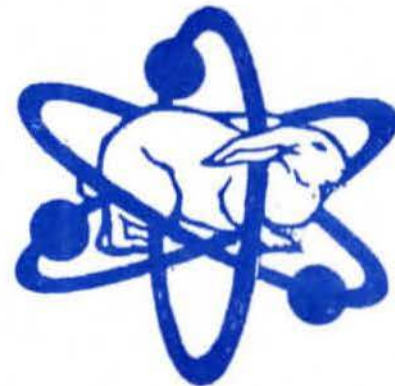



# THE 52ND STREET PROJECT

THE 52ND STREET PROJECT  
PRESENTS  
"HEROES"  
By Replay Class #3

## PENNY & LOAFER

By Jill Barbosa  
Directed by Pamela Tyson  
Abigail.....Kathy Hiler  
Mom.....Lori Quinones  
Penny.....Yolanda Maldonado  
Loafer.....Nelyn Maldonado

## YOUR VOICE

By Michael Schiff  
Directed by Mary Kane  
Tracy.....Brandy Minott  
Carmen.....Pamala Tyson  
Director/  
The Voice.....Danny Noonan

## TO BE OR NOT TO BE HUMAN

By Tina Vamvakakis  
Directed by Laura Maria Censabella  
Patty.....Iesha Blount  
Herbert.....Paul McCrane  
Dog King.....Kazmel Minott

## HEROISM - EVERYBODY HAS IT

By Latanya Godfrey  
Directed by Susan Willerman  
Reggie.....Rashawn Jenkins  
Jasmine.....Kulondi Frier  
Agua.....Paul Butler

## THE UNICORN THAT EARNED HIS HORN

By Glenray Jenkins  
Directed by Carl Capotorto  
Uni.....Victor Rojas  
Mother.....Felicia Allen  
Father.....Oscar Solano  
Elder/Evil  
Wizard.....Samona Squire  
Logan.....Hugh Sinclair

## PRODUCTION STAFF

Artistic Director.....Mary Kane  
Production Manager.....Mina Hammer  
Dramaturgs.....Carl Capotorto  
Laura Maria  
Censabella  
Cindy Lou  
Johnson  
Pamala Tyson  
Susan Willerman  
Sound.....Jose Soto  
Light Board.....Mina Hammer  
Sound Effects.....Travis Crafton  
Casting.....Tracy Reese  
Mina Hammer

## 52ND STREET PROJECT STAFF

Artistic Director.....Willie Reale  
Executive Director.....Marsue Cumming  
Admin/Prod. Asst.....Mina Hammer  
Playmaking Director.....Daniel Judah  
Sklar  
Drama Instructors.....Tracy Reese  
Mina Hammer  
Replay Instructors.....Laura Maria  
Censabella  
Susan  
Willerman

Very special thanks to: The P.A.L. Staff,  
The Ensemble Studio Theatre, Curt  
Dempster, Peter Shavitz, Kevin Causey,  
Chris Smith

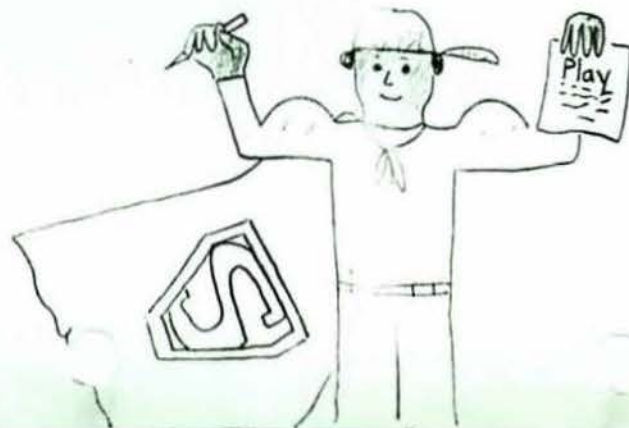

The 52nd Street Project gratefully acknowledges the support of the following foundations, corporations, and individuals:

American Express, Aurora Productions, D-B Trust, Dramatists Guild Fund, The Educational Foundation of America, James A. Macdonald Foundation, Manhattan Island Swimming Association, The Joyce Mertz-Gilmore Foundation, Morgan Stanley Foundation, The New World Foundation, The New York Times Company Foundation, The Samuel and May Rudin Foundation, The Fan Fox and Leslie R. Samuels Foundation, The Judith Harris Selig Memorial Fund, Spunk Fund, Inc. The Threshold Foundation, The Young Women's League of Westport and

Polly Adams  
Catherine Allegra  
Renee Almen  
Jane Anne Anderson  
Ronny Apfel  
Alan Artfa/Kay  
Matschullat  
Norma K. Asvies  
Jean Bacharach  
Barbara Bakst  
Cathy Baranck  
Ben Barenholtz  
Jo Baslow  
Terry Belanger  
Emily Benton  
Amy Birnbaum  
Mr. & Mrs. Gerald  
Bissinger  
Ron Black  
Joelle Bochner  
Patrick Bolt  
Katherine Borowitz/  
John Turturro  
Scott Brandon  
Michael Brennan  
Rita C. Brooks  
Bucky Browder  
Garrett Brown  
Tony Campisi/  
Kathy Bates  
Laura Maria Censabella  
Chris Caraso/Carla  
Meadows  
Cheryl Chalmers  
Ellen Chenoweth  
Raquel Chung  
Joel Coen  
Ruth Cohen  
Tom Cook/Susan  
Terner  
Joan Craton  
Arthur Dantchik  
Leslee Dart  
Dale Davis/Harris  
Spylios  
Curt Dempster  
G. H. Denniston/  
Christine Thomas  
Arlene Donovan  
John Douglas  
The Dreisbachs  
Rick & Rebecca  
Dresser  
Molra Driscoll  
Ned Eisenberg  
Caroline & John Ellis  
Bill Elverman  
John & Kitty Errett  
Barbara Ettinger

Ronnie Ettinger  
Wendy Ettinger  
Susan Ewen  
Mr. & Mrs. Albert  
Faber  
Randy Faktor  
Ilene Feldman  
Irwin Fisch  
Mr. & Mrs. Ben  
Fishbein  
Janet Foster/  
Michael Geiger  
Richard Fox  
David Frankel  
Bruno & Roslyn  
Fraudenthal  
Elizabeth Friedman  
Mo Ganey  
Betsy Garfella  
Dabney Payne  
Gibson  
Nancy Giles  
Jack Gopin  
Mr. & Mrs. Sanford  
Goldstein  
Stephen Graham  
Colin Greer/Frances  
LaBarre  
Flavia Grimm  
Emily Grishman  
Greg Grove  
Laura Gugenheim  
Lisa Gugenheim  
Lynne Gugenheim  
Ed Hajj  
Jane Harmon  
Peter Herdrich/  
Karen Trott  
Jane Hoffman  
Mark Hollinger  
Billy Hopkins  
Barnard Hughes/  
Helen Stenborg  
John Henry & Amy  
Introcaso Davis  
Mark Jacobs  
Sy Jacobs  
Denise Karin  
Johnsson  
Elinor Jones  
Bob & Mary Joy  
Nancy Kammer  
Mary Kane  
Berrilla Kerr  
Tracy Knights  
Rita Knox/Stephen  
Cohen  
Gary Knox  
Tom Kopache

Lynn Kressel  
Henry D. Krieger  
Marcia Jean Kurtz  
Pamela Lack  
Zohra Lampert/Paul  
Forman  
Knight Landesman  
Joyce Lapenn  
Matthew Lewis  
Pamela Linton  
Katharine Long/Bill  
Cwkowski  
Julia Lord  
John Lyons  
Pina MacDonald  
Cathy MacNeil  
Peter & Marsue  
MacNicol  
Grag MacPherson  
Nancy Maier  
Donald Margulies/  
Lynn Street  
David Margulies  
David Marsh  
Ann M. Martin  
Jane Read Martin  
Donna Missatll  
Lisa Maurer  
Connie S. Mauro  
Joan McAllister  
Paul McCrane  
James & Hannelore  
McDaniel  
Fran McDormano  
Bill McElhiney  
Julia Miles  
Elise Bretton Miller  
Steven Miller/Maria  
Winn  
David Misch  
Cass Morgan  
Robert Moss  
Karen Myrie  
Kate Nelligan/Rob Reale  
Ellen Novak  
Quentin O'Brien  
Michael O'Neill  
Kevin O'Rourke/  
Edith Thurber  
Carol Ochs  
Eric Overmyer  
John Pankow/  
Kristine Sutherland  
Ellen Parker/Mack  
Lipkin  
Mary Ellen Parks  
Alexandra Paxton  
David Peterkin  
Nancy Piccione

Wendy Radford  
Tim Ray/Nance Smith  
Ray  
Mr. & Mrs. Gene  
Reale  
Lillian Rhodes  
Michael Ritchie/Kate  
Burton  
Enid Roach  
Bruce & Ellen Roseman  
Alice Margaret Rubin  
Tim Sanford  
Gideon Schein  
Ken & Mary Ann  
Schuster  
John Patrick Shanley  
Barry Shapiro  
Carol Shapiro  
Ronnie Shapiro  
Peter Shavitz  
Sioane Shelton/Jan  
Buckaloo  
Alan D. Sieg  
Barry Sing  
Lbis Smith  
Leslie Spencer  
Nancy Stahl  
Robert Stecker  
Alberta Stout  
Keith & Cathy  
Suenholtz  
Andrew Sweet/Lisa  
Taylor  
Daniel Sweet  
Joan Vall Thorne  
Tracy Thorne  
Peter Thurber  
Laura Valeroso  
Kevin Ward  
Ira Weitzman  
Mary Wessely  
Mr. & Mrs. Robert  
Wiener  
Mr. & Mrs. Robert  
Wilder  
Susan Willerman  
Mr. & Mrs. Donald  
Wilson  
Andrew and Hannah  
Zackson We  
James Yos/  
Janet Zaris.

# STORIES



THE 52ND STREET PROJECT'S TRIPLE PLAY CLUB PRESENTS

# FAMILY





**THE 52ND STREET PROJECT'S  
TRIPLE PLAY CLUB  
Presents**

**FAMILY STORIES**

**PROJECT STAFF**

Willie Reale, Artistic Director  
Marsue Cumming, Executive Director  
Mina Hammer, Production/Administrative Asst.  
Daniel Judah Sklar, Playmaking Director  
Julia Crozier, Intern  
Fracaswell Hyman, 52nd Street at Graham-Windham

**PRODUCTION STAFF**

Kevin Joseph Roach, Set Designer  
Greg MacPherson, Lighting Designer  
Henry Krieger, Music Director  
Iris A. Brown, Graphics/Slides  
Jenny Peek, Stage Manager  
Tracy Knights, Light Board Operator  
Jose Soto, Sound  
Quentin O'Brien, Tech. Crew  
Neria Shelton, Tech. Crew  
Milard Corbett, Tech. Crew  
Steve Wildern, Tech. Crew  
Mary Wessely, Tech. Crew

**The 52nd Street Project** is an independent nonprofit organization which operates with the cooperation of E.S.T. and P.A.L. The Project brings inner-city children together with professional theatre artists to create theatre. **The Triple Play Club** is made up of kids who are veterans of our **Playmaking** program which is designed to teach them how to write plays. Each club member has written three plays, two of which have been produced. They have been working on these plays about families for the past year.

We would like to give special thanks to The Educational Foundation of America, The New World Foundation and The Fan Fox and Leslie R. Samuels Foundation for their support of the Playmaking program.

**BOARD OF DIRECTORS**

Marsue Cumming  
Wendy Ettinger, Chairperson  
Stephen Graham  
Pamela Lack

Heidi Landesman  
Frances McDormand  
Willie Reale  
Laura Valeroso

**ADVISORY COMMITTEE**

Joan Craton  
Barbara L. Ettinger  
Jeannine Edmonds  
Jack Gilpin

Lynne Gugenheim  
Carmen Matias  
Bob Saidenberg  
Kevin Ward  
John Wulp

**SPECIAL THANKS TO**

E.S.T., P.A.L., Duncan Center Staff, Rob Reale, Georg Brandl, Kevin Causey, Pat Murphy, John Greenleaf, Neil Mazzella, Gene O'Donovan, Judy Barrett, Myrna Weiss, Susan Murray, Jose Soto, Jr., Jose Soto, Sr., Kristen Johnson, Gail Frasier, Miya Signor, Nicole Brinson, Annie Trush, Paul McCrane, Holly Evers, Bill Havens, Susan Vitucci, Martha LeVan, Pete Shavitz, Curt Dempster, Kate Baggott, Amy Pahlka-Jellars, Raquel Chung, Annette Myrie, Sharon MacNeil, Peter Herdrich, Mark Lewis, Teachers & Writers Collaborative

The Instant Set Modules were designed by Kevin Joseph Roach and built by Hudson Scenic Studios and The Loop Exchange.

The Ensemble Studio Theatre's support of The 52nd Street Project is made possible by generous grants from the Milton Gordon Fund, Manufacturers Hanover Trust Company and the Leonard N. Stern Foundation.

**IN-KIND CONTRIBUTIONS**

Ensemble Studio Theatre; Police Athletic League; Hudson Scenic; The Loop Exchange; Colorforms; Goldstein, Schrank, Segelstein & Shays; Sanford Goldstein; Knox Associates; MacEmporium; John Greenleaf; Bernhardt Fudyma Design Group; YMHA; Stephen Graham; Young Playwrights Festival; Quad Cinema; Ben Barenholtz; Bill Wrubel

The flyer and program cover concept: The Triple Play Club  
Design: Iris A. Brown

**FAMILY STORIES**  
FEBRUARY 21 - MARCH 4, 1990

**MEMORIES**

By Fran-Marie Fargardo

Director: Kevin O'Rourke

Dramaturg: Marsue Cumming

(Lyrics by Fran-Marie Fargardo/Music by Henry Krieger)

Silver.....Michaela Murphy

Carl.....Larry Nathanson

Peter.....Jeffrey Lee

**CHILDREN SHOULD BE HEARD NOT ONLY SEEN**

By Monica Jenkins

Director: Henry Krieger

Dramaturg: Gayle Hanrahan

Lyrics by Monica Jenkins/Music by Henry Krieger)

Ebony.....Erika Alexander

Kim.....Mary Kane

Elizabeth.....Karen Evans-Kandel

Sam.....Peter Jay Fernandez

**THE VAMPIRE STORY**

By Shamine Gibson

Director and Dramaturg: Karen Trott

Gregory.....Josh Hamilton

James.....Hamilton Gillett

Nicholas.....Greg Grove

Tena.....Ann McDonough

**FINALLY**

By Jessica Cordero

Director: Pamala Tyson

Dramaturg: Sybil Rosen

Bibi.....Cecilia Arana

Father.....Jeff Sugarman

-INTERMISSION-

**IF THERE'S A WILL THERE'S A WAY**

By Karen Myrie  
Director and Dramaturg: Daniel Judah Sklar  
(Lyrics by Karen Myrie/Music by Henry Krieger)  
Lydia ..... Susan Willerman  
Naida ..... Pamala Tyson  
Richard..... Bruce MacVittie

**THE TWO RUNAWAYS**

By Justine Cook  
Director: Chris Ceraso  
Dramaturg: Susan Willerman  
Sue ..... Tracy Thorne  
Luke ..... Hugh Sinclair  
Lena ..... Mary Kane  
Gloria ..... Emma Walton

**YOU JUST DON'T UNDERSTAND**

By Paula Myrie  
Director: Bill Cwikowski  
Dramaturg: Cindy Lou Johnson  
Theresa..... June Ballinger  
Stephanie..... Lisa Maurer  
Cloudia..... Judy Tate

**PORTRAIT OUT OF FOCUS**

By Shirley Rumierk  
Director: Leigh Curran  
Dramaturg: Donald Margulies  
(Lyrics by Shirley Rumierk/Music by Henry Krieger)  
Junior..... David Margulies  
Seymore..... Manuel E. Santiago  
Melisha..... Phyllis Somerville  
Kassandra..... Cynthia Nixon

The 52nd Street Project gratefully acknowledges the support of the following foundations, corporations and individuals:

American Express, Aurora Productions, Citibank, D-B Trust, Dramatists Guild Fund, The Hennessy Foundation, James A. Macdonald Foundation, The Manhattan Community Arts Fund, The Manhattan Island Swimming Association, The Joyce Mertz-Gilmore Foundation, Morgan Stanley Foundation, The New World Foundation, The New York Times Company Foundation, The Samuel and May Rudin Foundation, The Fan Fox and Leslie R. Samuels Foundation, The Judith Harris Selig Memorial Fund, Spunk Fund, Inc., The Threshold Foundation, The Village Voice OBIE Awards, The Young Women's League of Westport and

Polly Adams  
 Kerew Alimen  
 Jane Anne Anderson  
 Ronny Apfel  
 Alan Aiffa/Kay  
 Matschullat  
 Norma E. Asnes  
 Linda Atalason  
 Joan Bacharach  
 Joanne Bailey  
 Barbara Bakst  
 Cathy Barancic  
 Men Batzscholtz  
 Kevin Barry  
 Tu Baslow  
 Terry Belanger  
 Emily Bentun  
 Amy Birnbaum  
 Mr. & Mrs. Gerald  
 Blasinger  
 Ron Black  
 Scott Brandon  
 Michael Brennan  
 Rita & Fred Brooks  
 Ducky Browder  
 Garrett Brown  
 Tony Caspiki/Kathy  
 Bates  
 Colleen Caye  
 Frank Ceraso/Lucia  
 Chasles  
 Terri Chalmers  
 Frank Chalkowitz  
 Kayoko Chang  
 Joel Cohen  
 Ruth Cohen  
 Tom Cook/Susan  
 Turner  
 Joan Craton  
 Leslie Dart  
 Dale Davis/Harris  
 Syllios  
 Muddy DeLone/  
 Robert Cohen  
 Curt Dempster  
 John Douglas  
 The Dreisbach's  
 Rick & Rebecca  
 Dresser  
 Moira Driscoll  
 Ned Eisenberg  
 Caroline & John  
 Ellis  
 Robert Ellison  
 Bill Elverman  
 John & Kitty Errett  
 Barbara F. Ettinger  
 Barbara L. Ettinger  
 Sandy Ettinger  
 Martha Evans/Pec  
 Lufving  
 Susan Ewen  
 Mr. & Mrs. Albert  
 Faber  
 Bill Fagerbakke  
 Wandy Factor

Irene Feldman  
 Irwin Fisch  
 Ben Fishbein  
 Janet Foster/  
 Michael Geiger  
 Richard Fox  
 David Frankel  
 Patricia Freebery/  
 Bruce Frye  
 Bruno & Roslyn  
 Freudenthal  
 Elizabeth Friedman  
 Mo Ganey  
 Betsy Gardella  
 Dabney Gibson  
 Jack Gilpin/Ann  
 McDonough  
 Sanford Goldstein  
 Elaine Golin  
 Stephen Graham  
 Helen Graves  
 Colin Greer/Frances  
 LaBarre  
 Flavia Grimm  
 Emily Grisham  
 Greg Grove  
 Lynne Gugenheim  
 Lisa Gugenheim  
 Lu Hall  
 Jayne Hantunen  
 Peter Heiorlich  
 Jane Hoffman  
 Mark Hollinger  
 Billy Hopkins  
 Amy Intrucaso &  
 John Henry Davis  
 Mark Jacobs  
 Sy Jacobs  
 Lorna Johnson  
 Elinor Jones  
 Bob & Mary Joy  
 Mary Kane  
 Martha Kearns  
 Shelia Kehoe  
 Berrillia Kerr  
 Rita Knox/Stephen  
 Cohen  
 Gary Knox  
 Stephen Knox/Anna  
 Testa  
 Henry D. Krieger  
 Marcia Jean Kurts  
 Pamela Lack  
 Joann Lanneck  
 Knight Landezman  
 Joyce Lapenn  
 Ray Larsen  
 Jill Larson  
 Pamela J. Linton  
 Katharine Long/Bill  
 Cwikowski  
 Julia Lord  
 John Lyons  
 Cathy McNeill

Peter & Marsue  
 MacNicol  
 Greg MacPherson  
 W. H. Macy/Felicity  
 Huffman  
 Nancy Malar  
 David Malar  
 The Guy Mansfield  
 Trust  
 Bruce Frye  
 David Margulies  
 Donald Margulies/  
 Lynn Street  
 David Marsh  
 Ann M. Martin  
 Jane Read Martin  
 Donna Massetti  
 Lisa Maurer  
 Connie S. Mauro  
 Joan McAllister  
 Paul McCrane  
 James & Hannelore  
 McDaniel  
 Pirlie McDonald  
 Frances McDormond  
 Elise Miller  
 Steven Miller/Marie  
 Winn  
 David Misch  
 Cass Morgan  
 Karen Myrie  
 Cynthia Nixon  
 Eileen Novack  
 Quentin O'Brien  
 Michael O'Neill  
 Steven J. O'Neill  
 Kevin O'Rourke/  
 Edith Thurber  
 Carol Ochs  
 Eric Overmyer  
 John Pankow/  
 Kristine Suther-  
 land  
 Ellen Parker/Mack  
 Lipkin  
 Mary Ellen Parks  
 Alexandra Paxton  
 David Peterkin  
 Nancy Piccione  
 Wendy Radford  
 Tim & Nance Smith  
 Ray  
 Mr. & Mrs. Gene  
 Reale  
 Elizabeth Rigg  
 Michael Ritchie/  
 Kate Burton  
 Enid Roach  
 Bruce & Ellen  
 Rosenan  
 Alice Margaret  
 Rubin  
 Joyce Rudnick  
 Tim Sanford  
 Gideon Schein  
 Sharon Schlarth  
 Sandy Schreiber  
 Ken & Mary Ann  
 Schuster

Seret Scott  
 John Patrick  
 Shanley/Jayne  
 Haynes  
 Barry Shapiro  
 Carol Shapiro  
 Ronnie Shapiro  
 Peter Shavitz  
 Alan D. Siege  
 Meg Simon  
 Barry Singer  
 Daniel Judah Sklar  
 Lois Smith  
 David Soo  
 Leslie Spencer  
 Robert Stecker  
 Jean Stein  
 Alberta Stout  
 Keith & Cathy  
 Suenholz  
 Jeff Sugarman  
 Andrew Sweet/Lisa  
 Taylor  
 Daniel Sweet  
 Bernie Telsay  
 Mary Testa  
 Joan Vail Thorne  
 Tracy Thorne  
 Peter Thurber  
 Karen Trutt  
 Laura Valerius  
 Kevin Ward  
 Ira Weitzman  
 Mary Wessely  
 Mr. & Mrs. Robert  
 Wiener  
 Mr. & Mrs. Robert  
 Wilder  
 Susan Willerman  
 Andrew Wolk/Hannah  
 Jackson Wolk  
 James Yoshimuta  
 Janet Zarish

THE 52ND STREET PROJECT PRESENTS  
**HUMAN***nature*

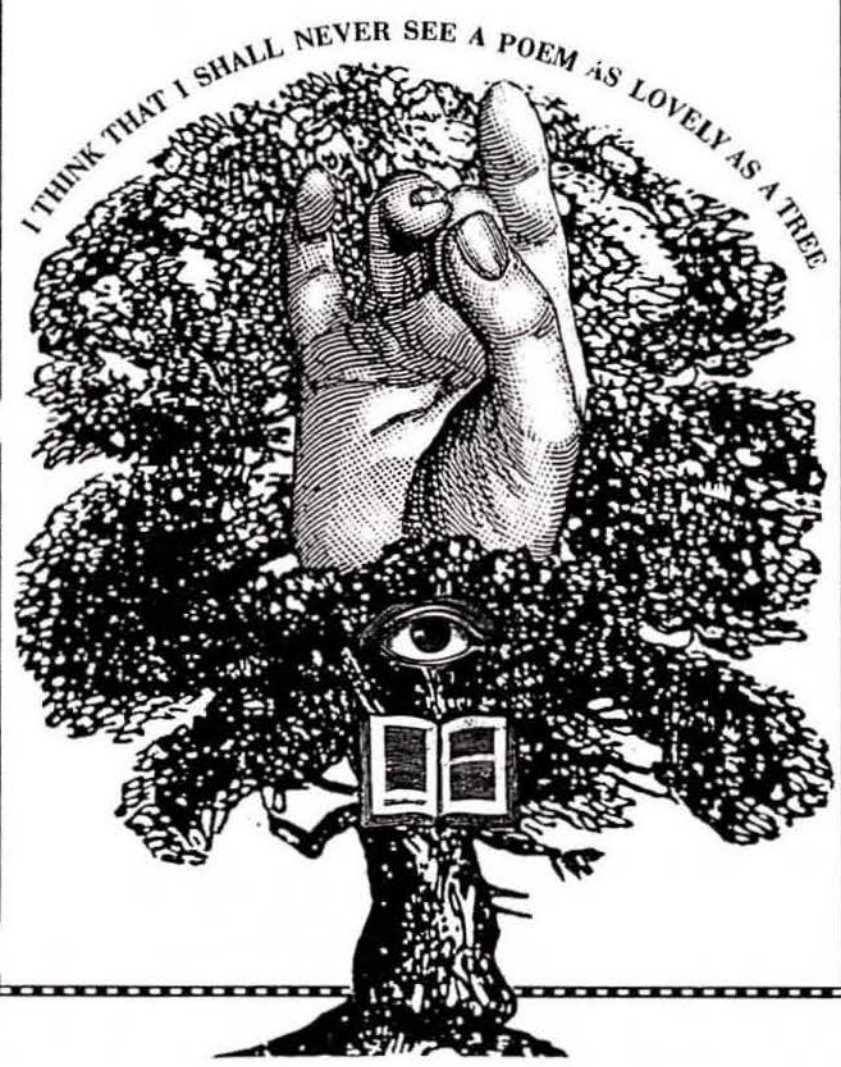



**THE 52ND STREET PROJECT**  
Presents

**"HUMANnature"**

**PROJECT STAFF**

Willie Reale, Artistic Director  
Marsue Cumming, Executive Director  
Mina Hammer, Production/Administrative Asst.  
Daniel Judah Sklar, Playmaking Director  
Julia Crozier, Drama Instructor  
Claudia Tracy, Drama Instructor  
Susan Willerman, Playmaking  
Michaela Murphy, Playmaking  
Fracaswell Hyman, 52nd Street at Graham-Windham

**PRODUCTION STAFF**

Kevin Joseph Roach, Set Designer	Frances Fargardo, Tech Cr
Greg MacPherson, Lighting Designer	Jill Kotler, Tech Crew
Henry D. Krieger, Music Director	Nancy Levin, Tech Crew
Iris A. Brown, Slides/Graphics	Neria Shelton, Tech Crew
Mina Hammer, Props/Colorforms	Ruth Siegal, Tech Crew
Michael Ritchie, Prod. Supervisor	Kevin Strohmeier, Tech Crew
Bill Wrubel, Stage Manager	David Wirth, Tech Crew
Karen Myrie, Asst. Stage Manager	Jean Bacharach, House Crew
Doug Mooney, Light Board	Nicole Brinson, House Crew
Janet Zarish, Keyboard	Donna Freeman, House Crew
Jose Soto, Jr., Sound	Alexandra Paxton, House Crew
Felicia Allen, Tech Crew	
Raquel Chung, Tech Crew	



The 52nd Street Project is an independent nonprofit organization which operates with the cooperation of the Ensemble Studio Theatre and the Police Athletic League. The Project brings inner-city children together with professional theatre artists to create theatre. The HUMANnature productions are a part of our Playmaking Program which is designed to teach children how to write plays. After eight weeks of classes, each child is given two actors to interview, a theme, and a director who guides them through the writing of a play during a weekend outside of New York City. These plays are the fruits of their labor.

**BOARD OF DIRECTORS**

Ben Barenholtz	Pamela Lack
Marsue Cumming	Heidi Landesman
Wendy Ettinger, Chairperson	Frances McDormand
Stephen Graham	Willie Reale
	Laura Valeroso

**ADVISORY COMMITTEE**

Joan Craton	Lynne Gugenheim
Barbara L. Ettinger	Carmen Matias
Jeannine Edmonds	Bob Saldenberg
Jack Gilpin	Kevin Ward
	John Wulp



**SPECIAL THANKS TO:**

Gregory Mosher, Bernard Gersten, Carol Ochs, Karin Barry, Becky Browder, Susan Knox, Jeff Hamlin and the staff of the Lincoln Center Theater Company; Sam Moore and the staff of the P.A.L.'s Duncan Center; Curt Dempster, Peter Shavitz and the staff of the Ensemble Studio Theatre; Rob Reale; Pat Murphy; John Greenleaf; Nell Mazzella and Gene O'Donovan of Hudson Scenic Studios; June Ballinger, Michael and Mathias Goldstein; Fran McDormand and Joel Coen; Sanford Goldstein; Gayle Hanrahan; Bruce Cohen and Victoria Lynch; Phyllis Binaghi and Colorforms; Barbara P. Ettinger; Omar; Stephanie Berger; Mohonk Mountain Lodge; Kristen Johnson; Ellen Dennis; Minna Rose; Karen McLaughlin; Miriam Ring and Ruth Cohen.



**IN-KIND CONTRIBUTIONS:**

Police Athletic League; Ensemble Studio Theatre; Lincoln Center Theater Company; Hudson Scenic Studios; Bruce Cohen and Associates; Colorforms; Goldstein, Schrank, Segelstein & Shays; Sanford Goldstein; Knox Associates; MacEmporium; Bernhardt Fudyma Design Group; The National Dance Institute; Great Adventure; The Silver Palate; The Brooklyn Bottling Corporation.



The 52nd Street Project would like to thank The Silver Palate for donating dessert for today's Benefit and The Brooklyn Bottling Corporation makers of "Best Health Natural Gourmet Sodas" for donating drinks. We would also like to thank Laura Valeroso for her work on the Benefit.

**"HUMANnature"**

The Mitzi E. Newhouse Theater  
June 3, 1990

**THE RAISE**

by Brandy Minott 8

Director/Dramaturg: Lee Costello ✓

JANET.....Phyllis Somerville ✓

DANIELLA.....Marcia Jean Kurtz

**NATURE OF PEOPLE**

by Lori Quinones - 10

Director/Dramaturg: Linda Atkinson -

JULIE.....Susan Willerman

BOB.....Charles Dumas

**PROBLEMS**

by Daniel Patrick Noonan - 9

Director/Dramaturg: Larry Nathanson

JO.....Evan Handler

CHARLIE.....John Fiedler

T.V.....Susan Willerman

**HURRICANE**

by Mikey Lugo 10

Director/Dramaturg: Daniel Judah Sklar

LIFEGUARD.....Susan Willerman

SUSANE.....Judy Tate

HUGO.....Paul McCrane

-INTERMISSION-

**FRIENDS CAN GET YOU THROUGH WINTER**

by Virginia Vargas ii

Director/Dramaturg: Michaela Murphy

BOZOCKO.....Jack Gilpin

BEAUTY.....Ann McDonough

WINTER.....Susan Willerman

(Lyrics by Virginia Vargas/Music by Henry D. Krieger)

**THE UNANIMOUS UNION**

by Kulondi Frier 10

Director/Dramaturg: Seret Scott

T.V. ANNOUNCER.....Susan Willerman

TURLUL.....James McDaniel

PAMPA-FLUFF.....Janet Zarish

**THE REALTOR AND THE RATKING**

by Richard Myrie 10

Director/Dramaturg: Willie Reale

LAURA.....Karen Evans-Kandel

RATKING.....Peter MacNicol

**THE WOODSMAN AND THE DANCING TREE**

by Victor Rojas 10

Director/Dramaturg: June Ballinger

THE DANCING TREE....Fracaswell Hyman

BUGS.....Greg Grove

MOTHER NATURE.....Susan Willerman

(Lyrics by Victor Rojas & Fracaswell Hyman/  
Music by Henry D. Krieger)

The 52nd Street Project gratefully acknowledges the support of the following foundations, corporations and individuals:

Altman Foundation, American Express, Citibank, Consolidated Edison, Nathan Cummings Foundation, Dramatists Guild Fund, The Hennessy Foundation, The Manhattan Community Arts Fund, Manhattan Island Swimming Association, Morgan Stanley Foundation, The New World Foundation, The New York Times Company Foundation, The Samuel and May Rudin Foundation, The Fox and Leslie R. Samuels Foundation, The Judith Harris Selig Memorial Fund, Spunk Fund, Inc., The Threshold Foundation, The Village Voice OBIE Awards, The Young Women's League of Westport and

Polly Adams  
Renee Altman  
Jane Anne Anderson  
Ronny Apfel  
Alan Arfa/Kay Melchulid  
Linda Ablinon  
Jean Baderach  
Joanne Bailey  
Barbara Bakst  
Cathy Baranok  
Ben Baranok  
Karin Berry  
Jo Bealor  
Terry Belanger  
Emily Benton  
Stephanie Berger  
Amy Birnbaum  
Mr. & Mrs. G. Belanger  
Scott Brandon  
Michael Brennan  
Rita C. Brooks  
Buddy Broder  
Garrett M. Brown  
Ann D. Brown  
Mindy Byer  
Tony Campbell/Kathy Bates  
Michael Ceyce  
Laura Marie Censabella  
Chris Ceraso/Carle Meadows  
Cheryl Chalmers  
Ellen Chenoweth  
Requet Chung  
Joel Coen  
Ruth Cohen  
Tom Cook/Susan Terner  
Joan Critton  
Lalene Dart  
Dale Davis/Harris Spylas  
Maddy deLone/Robert Cohen  
Curt Dempster  
John Douglas  
The Drabach's  
Rick & Patricia Dresser  
Ned Eisenberg  
Robert Ellison  
Bill Elverman  
John & Kitty Ernst  
Barbara L. Ellinger  
Barbara P. Ellinger  
Wendy Ellinger  
Martha Evans/Par Lohing  
Susan Evans/Rob Black  
Mr. & Mrs. Albert Faber  
Bill Fagerbakke  
Randy Feltor  
Gene Feldman  
Elsa First  
Irish Flech  
Ben Fleibin  
Janet Foster/Michael Geiger  
Richard Fox  
David Frankel  
Patricia Freberg/Bruce Frye  
Bruno & Rodlyn Freundenthal  
Elizabeth Friedman  
Mo Ganey  
Betsy Gardella  
Dorothy Payne Gibson  
Nancy Gilie

Jack Gilpin/Arn McDonough  
Ira Glase  
Dill Goldenhar  
Sanford Goldstein  
Elsie Golin  
Stephan Graham  
Helen Graves  
Dr. LaFruh Gray  
Colin Greer/Francois LaBere  
Fevia Grinn  
Emily Grishman  
Greg Grove  
Lynne Gugenheim  
Lisa Gugenheim  
Ed Hag  
Gayle Harrahan  
Peter Herdrich/Karen Trott  
Jane Hoffman  
Mark Hollinger  
Billy Hopkins  
Bernard Hughes/Helen Sternberg  
Patrick Hurley  
Amy Intraoos/John Henry Davis  
Mark Jacobs  
By Jacobs  
Lorna Johnson  
Elinor Jones  
Karen Jones-Meadows  
Bob, Mary & Ruby Joy  
Mary Kane  
Martha Kearns  
Shelia Kehoe  
Barbara Kerr  
Gary Knox  
Pete Knox/Stephen Cohen  
Stephen Knox/Anna Teale  
Henry Krieger  
Merle Jean Kurtz  
Pamela Lack  
Joann Lamneck  
Knight Landseman  
Joyce Lapern  
Ray Larsen  
Jill Larson  
Pamela J. Linton  
Katharine Long/Bill Calkowski  
Julia Lord  
John Lyons  
Pete MacDonald  
Cathy MacNeil  
Peter & Merause MacHool  
Greg MacPherson  
W. H. Macy/Felicity Hultman  
Nancy Malar  
Beverly Mansfield  
Dorothea Marusala  
David Margulies  
Donald Margulies/Lynn Street  
David Marsh  
Ann M. Martin  
Jane Reed Martin  
Donna Massetti  
Lisa Maurer  
Connie S. Mauro  
Joan McAllister  
Paul McCrane  
James & Hannelore McDermid

Francois McDermid  
Eise Brutton Miller  
Steven Miller/Marie Winn  
David Misch  
Bill Mitchellson  
Case Morgan  
Keren Myrie  
Kate Naligen/Rob Reale  
Ted Neustadt  
Cynthia Nixon  
Eben Novack  
Owen O'Brien  
Michael O'Neill  
Steven J. O'Neill  
Kevin O'Rourke/Edith Thurber  
Carol Ochs  
Eric Overmyer  
John Parkow/Kristine Sutherland  
Elen Parker  
Mary Ellen Parks  
Alexandra Paxton  
David Petelin  
Nancy Piodone  
Jill Portman  
Wendy Radford  
Shirley Ratner  
Tim & Tyeon Ray  
Mr. & Mrs. Gene Reale  
Paul Reale  
Lisa Reed  
Elizabeth Rigg  
Michael Ritchie/Kate Burton  
Erik Riech  
Karen L. Rose  
Mirna Rose  
Bruce & Ellen Roseman  
Kathryn Rosester/Lewis Black  
John Rothman  
Alice Margaret Rubin  
Joyce Rudnick  
Shirley Rumberk  
Tim Sanford  
Gideon Schain  
Sharon Scherlin  
Sandy Schreiber  
Ken & Mary Ann Schuster  
Saret Scott  
John Patrick Shanley/Jayne Haynes  
Barry Shapiro  
Carol Shapiro  
Ronnie Shapiro  
Peter Shavitz  
Alan D. Siege  
Meg Simon  
Jacqueline Simon  
Barry Singer  
Daniel Judah Sklar  
Liz Smith  
David Soo  
Leslie Spencer  
Robert Stecher  
Joan Stein  
Alberta Stout

Keith & Cathy Suenholz  
Jeff Sugarman  
Andrew Sweet/Lisa Taylor  
Daniel Sweet  
Helaine Tenkoff  
Bernie Teisley  
Mary Teale  
Joan Val Thorne  
Tracy Thorne  
Peter Thurber  
Laura Valeroso  
Kevin Ward  
Ira Weltzman  
Mary Weesly  
Mr. & Mrs. Robert Weiner  
Mr. & Mrs. Robert Wilder  
Susan Williams  
Harry Winer  
Andrew & Hannah Wolf  
James Yoshimura  
Janet Zarish

THE 52ND STREET PROJECT  
PRESENTS  
"THE BUTLER DID IT!"

Donations will be accepted at the door!





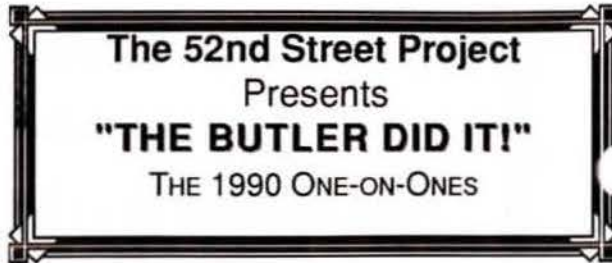
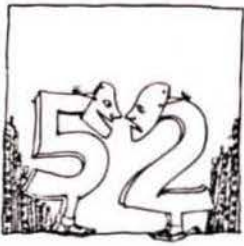

## PROJECT STAFF

Willie Reale, Artistic Director  
Marsue Cumming, Executive Director  
Mina Hammer, Production/Administrative Asst.  
Daniel Judah Sklar, Playmaking Director  
Gayle Hanrahan, Playmaking Volunteer

## PRODUCTION STAFF

Kevin Joseph Roach, Set Designer  
Greg MacPherson, Lighting Designer  
Henry Krieger, Music Director  
Nancy Levin, Stage Manager  
Bruce Cohen & Victoria Lynch, Press & P.R.  
Iris A. Brown, Slides  
Mina Hammer, Props/Colorforms  
Tracy Knights, Light Board Operator  
Jessica Bauman, Tech. Crew  
Milard Corbett, Tech. Crew  
Fran-Marie Fargardo, Tech. Crew  
Noah Gardner, Tech. Crew  
Patrick Hurley, Tech. Crew

Carolyn Morrow, Tech. Crew  
Karen Myrie, Tech. Crew  
Mindy Pfeffer, Tech. Crew  
Shirley Rumierk, Tech. Crew  
Neria Shelton, Tech. Crew  
John Williams, Tech. Crew  
Jean Bacharach, House Crew  
Aleta Kaufman, House Crew  
Jill Kotler, House Crew  
Jane Read Martin, House Crew  
Meredith Portman, House Crew  
Claudia Tracy, House Crew  
Mary Wessley, House Crew

**The 52nd Street Project** is an independent, nonprofit, organization that operates with the cooperation of the Ensemble Studio Theatre and the Police Athletic League. The Project brings inner-city children together with professional theatre artists to create theatre. This summer, our **One-on-One** program will take a total of 21 kids away for one-week stays in the country (10 to Block Island and 11 to Tannersville, NY) where they are matched one-on-one with a professional writer/actor who writes a play for him or herself to perform with his or her kid.

## BOARD OF DIRECTORS

Ben Barenholtz  
Marsue Cumming  
Mindy Ettinger, Chairperson  
Ben Graham

Pamela Lack  
Heidi Landesman  
Frances McDormand  
Willie Reale  
Laura Valeroso

## ADVISORY COMMITTEE

Joan Craton  
Jeannine Edmonds  
Barbara L. Ettinger  
Jack Gilpin

Lynne Gugenheim  
Carmen Matias  
Bob Saidenberg  
Kevin Ward  
John Wulp

## SPECIAL THANKS TO:

Curt Dempster, Peter Shavitz, Kate Baggott, Marthe Le Van, Jonathan and The Ensemble Studio Theatre; Sam Moore, Tito, Raymond and the staff at the P.A.L.; Tony & Bob Reale; Melissa & John Gruen; Frankie & Gordon Smith; Cindy & Tony Pas; Jennifer, Elliot & Rebecca Taubman; Dr. Christina Biaggi; Virginia Dare; Joya Verde; Martha McDonald; Pat McQuade; Annie Reale; Tom Reale; Fred Benson; Patricia O'Connell; Interstate Navigation Company; Prudie, Emily and The Ice Cream Place; Iris A. Brown; Stephanie Berger; Block Island Times; Block Island Realty; Diane & Don Tripler of the Corn Neck Country Store; New England Airlines; Hunter Tracy & Block Island Trucking; McQuades Marketplace; Everyone We've Ever Met in Our Whole Lives; Mudge; Sam Wahba from Egypt; David Jackson; Costume Collection; Pat Murphy; Susan Murray; Bill's Glass

## IN-KIND CONTRIBUTIONS:

Police Athletic League; Ensemble Studio Theatre; Hudson Scenic Studios; Bruce Cohen & Associates; Colorforms; Goldstein, Schrank, Segelstein & Shays; Sanford Goldstein; Knox Associates; MacEmporium; Bernhardt/fudyma Design Group; The National Dance Institute; Great Adventure; New York Giants; Stephen Graham

This program is made possible, in part, by a grant from The Manhattan Community Arts Fund, with public funds from the New York City Department of Cultural Affairs and from the honorable Ruth W. Messenger, President of the Borough of Manhattan.

**"The Butler Did It!"**  
**The 1990 Block Island One-on-Ones**  
 Ensemble Studio Theatre  
 August 18th & 19th, 1990

All music composed by Henry Krieger, unless otherwise noted.

**"THE BUTLER DID IT!"** - Company  
 Lyrics by Willie Reale

**THAT'S ENTERTAINMENT?**

Written and Directed by Peter MacNicol  
 Narrator.....Peter Herdrich  
 Blister, the Butler.....William Wise  
 Grimsby.....Peter MacNicol  
 The Lad.....Kristen Bess  
 "The Shopper's Serenade" - Music & Lyrics by Peter MacNicol  
 Arranged by Henry Krieger

**MICHELLE HAMMER...GIRL DETECTIVE**

Written and Directed by Leigh Curran  
 Michelle Hammer.....Samona Squire  
 Latitia LaNoir.....Leigh Curran  
 The Butler.....William Wise  
 "Life" - Lyrics by Samona Squire

**TONY TIMES' TIME**

Written and Directed by William Wise  
 Tony Times.....Alex Bess  
 Johnny Swift.....Jeff Williams  
 ZMW.....William Wise  
 "Everything in Life Comes Around" - Lyrics by William Wise

**PRELUDE TO A QUICHE**

Written and Directed by Garrett M. Brown  
 Hedda.....Fran-Marie Fargardo  
 Butler.....William Wise  
 Sue.....Garrett M. Brown  
 "The Recipe for Love and Death" - Lyrics by Garrett M. Brown

**THE HIGH NOTES MYSTERY**

Written and Directed by Pamala Tyson  
 Octavia Legato.....Tina Vamvoukakis  
 Stella Staccato.....Pamala Tyson  
 Peter Pianissimo.....William Wise  
 "Sing and Shout" - Music and Lyrics by Pamala Tyson  
 Arranged by Henry Krieger

- Intermission -

**A PICTURE'S WORTH A THOUSAND WORDS**

Written and Directed by Willie Reale  
 Young Prince Daniel.....Danny Noonan  
 Clarence, A Butler.....William Wise  
 Prince Philip, the  
 Extremely Popular.....Willie Reale  
 "Why Do I Feel So.....Y'Know" and "Learn Every Synonym" - Lyrics by Willie Reale

**THE BODYGUARD**

Written by Lori Quinones and Charles Dumas  
 Directed by Charles Dumas and Pamala Tyson  
 Cindy.....Lori Quinones  
 James, the Butler.....William Wise  
 B.G.....Charles Dumas  
 "Don't Make a Monster" - Lyrics by Lori Quinones and Charles Dumas

**LIKE SON, LIKE FATHER**

Written by Ronnie Noonan and Hugh Sinclair  
 Directed by Hugh Sinclair  
 Dr. Chester.....Ronnie Noonan  
 Gregory Chester.....Hugh Sinclair  
 Mr. Butler.....William Wise  
 "Everything Looks Brighter Now" - Lyrics by Nancy Levin

**WE'RE RICH!**

Written by Peter Herdrich, Karen Trott and Virginia Vargas  
 Directed by Peter Herdrich  
 Merv Head.....Peter Herdrich  
 Dorothy.....Virginia Vargas  
 Amanda.....Karen Trott  
 Padgett.....William Wise  
 "We're Rich" - Lyrics by Peter Herdrich, Karen Trott and Virginia Vargas

**FIRE ON THE MOUNTAIN**

Adapted from an African Folk Tale and Directed by Fracaswell Hyman  
 Kulondi.....Kulondi Frier  
 Haptom.....Fracaswell Hyman  
 Butler.....William Wise  
 Guests.....The Kids  
 "Fire on the Mountain" - Lyrics by Fracaswell Hyman

Thank you for coming! If you are not on our mailing list (or if your address has changed), please fill out this form and give it to us on your way out, or mail it to the address below. We would also like to know if you would like to be of help to us in the future (primarily in the areas of fundraising, backstage and printing). If so, please fill out your name, phone number and area(s) of interest below.

**PLEASE ADD ME TO YOUR MAILING LIST:**

Name \_\_\_\_\_

Address \_\_\_\_\_

\_\_\_\_\_ Zip \_\_\_\_\_

Phone \_\_\_\_\_

**YES, I WOULD LIKE TO BE OF HELP:**

Name \_\_\_\_\_

Daytime Phone \_\_\_\_\_

Area(s) of Interest \_\_\_\_\_

If you would like to mail this, or a donation, you can send them to:  
The 52nd Street Project, 552 W. 52nd St., New York, NY 10019  
(212) 245-1350.

There are a limited number of 52nd Street T-Shirts (with the Shel Silverstein logo) on sale in the lobby for \$12.00. Half of this is tax-deductible. Buy one and be the envy of all. Buy two and be the envy of everyone else. Great Gift Idea! Why not pick up several for the holidays?

The 52nd Street Project gratefully acknowledges the support of the following foundations, corporations and individuals:

Altman Foundation, American Express, Citibank, Consolidated Edison, Nathan Cummings Foundation, Dramatists Guild Fund, The William & Mary Greve Foundation, The Hennessy Foundation, The Manhattan Community Arts Fund, Manhattan Island Swimming Association, Morgan Stanley Foundation, The New World Foundation, New York Times Company Foundation, The Samuel and May Rudin Foundation, ...e Fan Fox and Leslie R. Samuels Foundation, The Judith Harris Selig Memorial Fund, Spunk Fund, Inc., The Threshold Foundation, The Village Voice OBIE Awards, The Young Women's League of Westport and

Polly Adams  
 Renee Altman  
 Jane Anne Anderson  
 Ronny Aptel  
 Alan Arfa/Kay Malschullat  
 Linda Abunson  
 Jean Bacharach  
 Joanne Bailey  
 Barbara Bakat  
 Cathy Baranick  
 Ben Barenholtz  
 Karin Barry  
 Jo Baslow  
 Terry Belanger  
 Emily Benton  
 Stephanie Berger  
 Amy Birnbaum  
 Mr. & Mrs. G. Bissinger  
 Scott Brandon  
 Michael Brennan  
 Rita C. Brooks  
 Becky Browder  
 Garrett M. Brown  
 Ann D. Brown  
 Mindy Byer  
 Tony Campisi/Kathy Bates  
 Michea Caye  
 Laura Maria Censabella  
 Chris Ceraso/Carla Meadows  
 Cheryl Chalmers  
 Ellen Chenoweth  
 Raquel Chung  
 Joel Coen  
 Ruth Cohen  
 Tom Cook/Susan Temer  
 Joan Craton  
 Leslee Dart  
 Dale Davis/Harris Spytloe  
 Maddy deLone/Robert Cohen  
 Curt Dempster  
 John Douglas  
 The Dreisbach's  
 Rick & Rebecca Dresser  
 Ned Eisenberg  
 Robert Ellison  
 Bill Elverman  
 John & Kitty Errett  
 Barbara L. Ettinger  
 Barbara P. Ettinger  
 Wendy Ettinger  
 Martha Evans/Pat Lohmg  
 Susan Ewers/Rob Black  
 Mr. & Mrs. Albert Faber  
 Bill Fagerbakke  
 Randy Faktor  
 Iene Feldman  
 Elias First  
 Irwin Fisch  
 Ben Fishbein  
 Janet Foster/Michael Geiger  
 Richard Fox  
 David Frankel  
 Patricia Freesberg/Bruce Frye  
 Bruno & Roslyn Freudenthal  
 Elizabeth Friedman  
 Mo Ganey  
 Betsy Gardella  
 Dabney Payne Gibson  
 Nancy Giles

Jack Gilpin/Ann McDonough  
 Ira Glass  
 Didi Goldenhar  
 Sanford Goldstein  
 Elaine Golin  
 Stephen Graham  
 Helen Graves  
 Dr. LaRuth Gray  
 Colin Greer/Frances LaBarre  
 Flavia Grimm  
 Emily Grishman  
 Greg Grove  
 Lynne Gugenheim  
 Lisa Gugenheim  
 Ed Hajj  
 Gayle Hanrahan  
 Peter Hedrich/Karen Trott  
 Jane Hotman  
 Mark Hollinger  
 Billy Hopkins  
 Bernard Hughes/Helen Stenborg  
 Patrick Hurley  
 Amy Introcaso/John Henry Davis  
 Mark Jacobs  
 Sy Jacobo  
 Lorna Johnson  
 Elinor Jones  
 Karen Jones-Meadows  
 Bob, Mary & Ruby Joy  
 Mary Kane  
 Martha Kearns  
 Sheila Kehoe  
 Berrilla Kerr  
 Gary Knox  
 Rita Knox/Stephen Cohen  
 Stephen Knox/Anna Testa  
 Henry Krieger  
 Marcia Jean Kurtz  
 Pamela Lack  
 Joann Lamneck  
 Knight Landesman  
 Joyce Lapenn  
 Ray Larsen  
 Jill Larson  
 Pamela J. Linton  
 Katharine Long/Bill Cwikowski  
 Julia Lord  
 John Lyons  
 Pirie MacDonald  
 Cathy MacNeil  
 Peter & Marusa MacNicol  
 Greg MacPherson  
 W. H. Macy/Felicity Hullman  
 Nancy Maier  
 Beverly Mansfield  
 Dorothea Marzuela  
 David Margulies  
 Donald Margulies/Lynn Street  
 David Marsh  
 Ann M. Martin  
 Jane Read Martin  
 Donna Massett  
 Lisa Maurer  
 Connie S. Mauro  
 Joan McAllister  
 Paul McCrane  
 James & Hannelore McDaniel

Francois McDormand  
 Elise Bretton Miller  
 Steven Miller/Marie Winn  
 David Misch  
 Bill Michelson  
 Case Morgan  
 Karen Myrie  
 Kate Nelligan/Rob Reale  
 Ted Neustadt  
 Cynthia Nixon  
 Ellen Novack  
 Quentin O'Brien  
 Michael O'Neill  
 Steven J. O'Neill  
 Kevin O'Rourke/Edith Thurber  
 Carol Ochs  
 Eric Overmyer  
 John Pankow/Kristine Sutherland  
 Ellen Parker  
 Amy Ellen Parks  
 Alexandra Paxton  
 David Peterkin  
 Nancy Piccone  
 Jill Portman  
 Wendy Radford  
 Shirley Ratner  
 Tim & Tyson Ray  
 Mr. & Mrs. Gene Reale  
 Paul Reale  
 Lisa Reed  
 Elizabeth Rigg  
 Michael Ritchie/Kate Burton  
 Erid Roach  
 Karen L. Rosa  
 Minna Rose  
 Bruce & Ellen Roseman  
 Kathryn Rosseter/Lewis Black  
 John Rothman  
 Alice Margaret Rubin  
 Joyce Rudnick  
 Shirley Rumierk  
 Tim Sanford  
 Gideon Schein  
 Sharon Schierth  
 Sandy Schreiber  
 Ken & Mary Ann Schuster  
 Seret Scott  
 John Patrick Shanley/Jayne Haynes  
 Barry Shapiro  
 Carl Shapiro  
 Ronnie Shapiro  
 Peter Shavitz  
 Alan D. Siegel  
 Meg Simon  
 Jacqueline Simon  
 Barry Singer  
 Daniel Judah Sklar  
 Lois Smith  
 David Soo  
 Leslie Spencer  
 Robert Stecker  
 Jean Stein  
 Alberta Stout

Keith & Cathy Suenholz  
 Jeff Sugarman  
 Andrew Sweet/Lisa Taylor  
 Daniel Sweet  
 Helaine Tankell  
 Bernie Telsky  
 Mary Testa  
 Joan Vail Thorne  
 Tracy Thorne  
 Peter Thurber  
 Laura Thuroso  
 Kevin Ward  
 Ira Weitzman  
 Mary Wessely  
 Mr. & Mrs. Robert Wenzel  
 Mr. & Mrs. Robert Wilder  
 Susan Willerman  
 Harry Winer  
 Andrew & Hannah Wolk  
 James Yoshimura  
 Janet Zarish

THE 52ND STREET PROJECT  
 PRESENTS  
 "THE BUTLER DID IT!"

Donations will be accepted at the door!





**The 52nd Street Project**  
Presents  
**"THE BUTLER DID IT!"**  
THE 1990 ONE-ON-ONES

**PROJECT STAFF**

Willie Reale, Artistic Director  
Marsue Cumming, Executive Director  
Mina Hammer, Production/Administrative Asst.  
Daniel Judah Sklar, Playmaking Director  
Gayle Hanrahan, Playmaking Volunteer

**PRODUCTION STAFF**

Kevin Joseph Roach, Set Designer  
Greg MacPherson, Lighting Designer  
Henry Krieger, Music Director  
Michael Ritchie, Stage Manager  
Tim Ray, Sound/Keyboards  
Bruce Cohen & Victoria Lynch, Press & P.R.  
Iris A. Brown, Slides  
Mina Hammer, Props/Colorforms  
Peter MacNicol, Troubleshooter  
Dennis Tolentino, Kid Wrangler  
Jackie Thurik, Costumes  
Tracy Knights, Light Board Operator  
Jessica Bauman, Tech. Crew  
Milard Corbett, Tech. Crew  
Fran-Marie Fargardo, Tech. Crew  
Noah Gardner, Tech. Crew

Patrick Hurley, Tech. Crew  
Nancy Levin, Tech. Crew  
Brian Mertes, Tech. Crew  
Karen Myrie, Tech. Crew  
Mindy Pfeffer, Tech. Crew  
Shirley Rumierk, Tech. Crew  
Neria Shelton, Tech. Crew  
John Williams, Tech. Crew  
Bill Wrubel, Tech. Crew  
Jean Bacharach, House Crew  
Aleta Kaufman, House Crew  
Jill Kotler, House Crew  
Jane Read Martin, House Crew  
Meredith Portman, House Crew  
Claudia Tracy, House Crew

**The 52nd Street Project** is an independent, nonprofit, organization that operates with the cooperation of the Ensemble Studio Theatre and the Police Athletic League. The Project brings inner-city children together with professional theatre artists to create theatre. This summer, our **One-on-One** program will take a total of 21 kids away for one-week stays in the country (10 to Block Island and 11 to Tannersville, NY) who are matched one-on-one with a professional writer/actor who writes a play for him or herself to perform with his or her kid.

Support from Citibank, the Liz Claiborne Foundation, the Milton Gordon Fund, Manufacturers Hanover Trust and The Leonard N. Stern Foundation has helped make it possible for the Ensemble Studio Theatre to present The 52nd Street Project this year.

**BOARD OF DIRECTORS**

Ben Barenholtz  
Marsue Cumming  
Gayle Ettinger, Chairperson  
Mina Hammer  
John Graham

Pamela Lack  
Heidi Landesman  
Frances McDormand  
Willie Reale  
Laura Valeroso

**ADVISORY COMMITTEE**

Joan Craton  
Jeannine Edmonds  
Barbara L. Ettinger  
Jack Gilpin

Lynne Gugenheim  
Carmen Matias  
Bob Saidenberg  
Kevin Ward  
John Wulp

**SPECIAL THANKS TO:**

Curt Dempster, Peter Shavitz, Kate Baggott, Marthe Le Van, Jonathan and The Ensemble Studio Theatre; Sam Moore, Tito, Raymond and the staff at the P.A.L.; Lyn & Bob Reale; Melissa & John Gruen; Frankie & Gordon Smith; Cindy & Tony Pannas; Jennifer, Elliot & Rebecca Taubman; Dr. Christina Biaggi; Virginia Dare; ... Verde; Martha McDonald; Pat McQuade; Annie Reale; Tom Reale; Fred Benson; Patricia O'Connell; Interstate Navigation Company; Prudie, Emily and The Ice Cream Place; Iris A. Brown; Stephanie Berger; Block Island Times; Block Island Realty; Diane & Don Tripler of the Corn Neck Country Store; New England Airlines; Hunter Tracy & Block Island Trucking; McQuades Marketplace; Everyone We've Ever Met in Our Whole Lives; Mudge; Sam Wahba from Egypt; David Jackson; Costume Collection; Pat Murphy; Susan Murray; Bill's Glass; George Babiak; Hugh Sinclair; Kirsten Sanderson; Marguerite Scott; Sarah Trelease; Buddy; Bidy; Emmet; Bill Cwikowski; Tyson Smith-Ray; Paul & Joan Myrie; Joann Lamneck; Morgan Ritchie; Barbara Ettinger and Dennis Tolentino!

**IN-KIND CONTRIBUTIONS:**

Police Athletic League; Ensemble Studio Theatre; Hudson Scenic Studios; Bruce Cohen & Associates; Colorforms; Goldstein, Schrank, Segelstein & Shays; Sanford Goldstein; Knox Associates; MacEmporium; Bernhardt/fudyma Design Group; The National Dance Institute; Great Adventure; New York Giants; Stephen ... am

This program is made possible, in part, by a grant from The Manhattan Community Arts Fund, with public funds from the New York City Department of Cultural Affairs and from the honorable Ruth W. Messinger, President of the Borough of Manhattan.

**"The Butler Did It!"**  
**The 1990 Tannersville One-on-Ones**

Ensemble Studio Theatre  
September 6, 7 & 8, 1990

All music composed by Henry Krieger, unless otherwise noted.

**"THE BUTLER DID IT!"** - Company - Lyrics by Willie Reale

**LET THEM EAT CAN**

Written and Directed by Greg Grove

Blonde with the Wand.....Katharine Long  
Professor.....Greg Grove  
Baylor, the Butler.....Donald Berman  
Billy.....Mikey Lugo

**SAY CHEESE**

Written by Willie Reale

Directed by Mary Kane

The Butler.....Donald Berman  
The Cheese Girl.....Nyita Hanley  
The Dairy Godmother.....Mary Kane

"I've Grown Accustomed To My Head" - Lyrics by Willie Reale

**CASSIETTA REFLECTS**

Written and Directed by Katharine Long

Cassietta.....Monica Jenkins  
Butler.....Donald Berman  
Reflection.....Katharine Long  
Girl.....Felicia Allen

"One And The Same" - Lyrics by Katharine Long

"Reflections In My Mind" - Lyrics by Monica Jenkins

**WHO SLAPPED ALFREDO FALLS?**

Written by Sandye Wilson and David Stevens

Directed by Sandye Wilson

Lawyer.....David Stevens  
Miss Va Va Voom.....Sandye Wilson  
Butler Boobie.....Donald Berman  
Alfredo Falls.....David Stevens

Thank you for coming! If you are not on our mailing list (or if your address has changed), please fill out this form and give it to us on your way out, or mail it to the address below. We would also like to know if you would be of help to us in the future (primarily in the areas of fundraising, backstage and printing). If so, please fill out your name, phone number and area(s) of interest below.

PLEASE ADD ME TO YOUR MAILING LIST:

Name \_\_\_\_\_

Address \_\_\_\_\_

\_\_\_\_\_ Zip \_\_\_\_\_

Phone \_\_\_\_\_

YES, I WOULD LIKE TO BE OF HELP:

Name \_\_\_\_\_

Daytime Phone \_\_\_\_\_

Area(s) of Interest \_\_\_\_\_

If you would like to mail this, or a donation, you can send them to:  
The 52nd Street Project, 552 W. 52nd St., New York, NY 10019  
(212) 245-1350.

There are a limited number of 52nd Street T-Shirts (with the Shel Silverstein logo) on sale in the lobby for \$12.00. Half of this is tax-deductible. Buy one and be the envy of all. Buy two and be the envy of everyone else. Great Gift Idea! Why not pick up several for the holidays?

### THE GOOD WOMAN WHO SAID NOTHING

Written and Directed by Lee Costello

Bertholdt, the Butler.....Donald Berman  
The Good Woman.....Lee Costello  
Gloria Snubbery Littlethingsbotherme  
Jones.....Felicia Allen  
Ladees of the Club.....Monica Jenkins, Annette Myrie &  
Shirley Rumierk

"I Am The President" - Lyrics by Felicia Allen

"Ladees Of The Club" - Lyrics by Lee Costello

### THE METAPHYSICS OF APPEARANCES VERSUS REALITY IN RELATION TO DREAM STATES

Written and Directed by Craig Lucas

Rolanda Bonanza.....Annette Myrie  
Bruno.....Craig Lucas  
Frank Butler.....Donald Berman  
"Island Girl" and "You Are What You Dream" - Lyrics by Willie Reale

### -INTERMISSION-

### HAIR. . . THE NINETIES

Written and Directed by Kathryn Rossetter

Choreography by Shirley Rumierk and Kathryn Rossetter  
Hilda.....Shirley Rumierk  
Francine.....Kathryn Rossetter  
Butler.....Donald Berman  
"Aria For Butler" - Lyrics by Kathryn Rossetter

### ME AND GRANDMA

Written and Directed by Karen Evans-Kandel

Elizabeth.....Darthula Harvey  
Grandma.....Karen Evans-Kandel  
Butler.....Donald Berman  
"Grandma And Me" - Lyrics by Karen Evans-Kandel

### THE BUTLER GETS THE BOOK THROWN AT HIM

Written by Jacquelyn Reingold and Jill Barbosa

Directed by Jacquelyn Reingold

Cybil.....Jill Barbosa  
Butler.....Donald Berman  
Ma.....Jacquelyn Reingold  
"The Bad Girl Rap" and "The Good Girl Rap" - Lyrics by Jacquelyn Reingold  
Music by Tim Ray

### HEAD OVER HEELS

Written by Richard Dresser

Directed by Kate Burton

Narrator.....Willie Reale  
King Bob.....Richard Myrie  
Hedda Verheels.....Kate Burton  
Leland, the Butler.....Donald Berman  
"Butler's Song" and "Hedda's Song" - Lyrics by Richard Dresser

### THE BUTLER DID IT! - A CONCERTINA VERSION

Written and Directed by Lewis Black

Glen.....Glen Jenkins  
Lewis Black.....Lewis Black  
Butler.....Donald Berman  
"We Are The Butler" - Lyrics by Lewis Black

The 52nd Street Project gratefully acknowledges the support of the following foundations, corporations and individuals:

Altman Foundation, American Express, Citibank, Consolidated Edison, Nathan Cummings Foundation, Dramatists Guild Fund, Educational Foundation of America, The Wilton & Mary Gow Foundation, The Hennessy Foundation, The Kids Fund, The James Macdonald Foundation, The Manhattan Community Arts Fund, Manhattan Island Swimming Association, Morgan Guaranty, Morgan Stanley Foundation, The New World Foundation, New York City Department of Youth Services, New York State Council on the Arts, The New York Times Company Foundation, The Sarnoff and May Rudin Foundation, The Fan Fund and Leslie R. Sarnoff Foundation, Spunk Fund, Inc., The Threshold Foundation, The Village Voice OBIE Awards, The Young Women's League of Westport and

Polly Adams  
Renae Alban  
Jane Aron Anderson  
Rosny Apfel  
Alan Aron/My Melachuk  
Norma K. Azees  
Dorothy B. Ashken  
Linda Ashken  
Jean Beathach  
Joanne Bailey  
Barbara Bakat  
Cathy Baranick  
Ben Baranowitz  
Karin Barry  
Ji Bealov  
Ann Beckerman  
Terry Belanger  
Emily Bertin  
Stephanie Berger  
Amy Birbaum  
Mr. & Mrs. O. Bealiger  
Scott Brandon  
Michael Brennan  
Rita C. Brooks  
Becky Browder  
Garrett M. Brown  
Ann O. Brown  
In memory of Mark Burkatos  
Mindy Bye  
Tony Campello/Kathy Bates  
Michael Croy  
Laura Marie Cerasole  
Olivia Caraco/Carla Meschino  
Cheryl Chalmers  
Ellen Charowitz  
Respal Chung  
George Cusack  
Joel Coen  
Ruth Cohen  
Patricia Coleman  
Tom Cook/Bush Tamer  
Joan Crain  
Laraine Dahl  
Dale Davis/Harrie Spinka  
Mahty del-June/Robert Cohen  
Curt Dempsie  
John Douglas  
The Drexel/Ed's  
Rick & Helene Dresser  
Paul Eisenberg  
Robert Ellson  
Bill Eisenman  
John & Kelly Street  
Barbara L. Ellinger  
Barbara F. Ellinger  
Wendy Ellinger  
Martha Evans/Pat Lohring  
Susan Evans/Pat Black  
Mr. & Mrs. Albert Faine  
Bill Fagerbakke  
Randy Falter  
Sara Feldman  
Elsa Feit  
Irwin Fein  
Ben Feinstein  
Janet Foster/Michael Gelger  
Richard Fox  
David Franklin  
Patricia Frostberg/Bruce Frye  
Bruce & Hopkin Froumenthal  
Elizabeth Friedman  
Mo Gandy  
Betty Gardsella

Debra Payne Gibson  
Henry Gibes  
Jack Giblin/Ann McDonough  
Gilbert Gilson/Christie Mulren  
Ira Glass  
Dill Goldstein/David Wolf  
Sandra Goldstein  
Elsie Gold  
Stephen Graham  
Helen Graves  
Dr. LaFuth Gray  
Michael A. Green  
Galen Green/Frances Labare  
Flavia Grimm  
Emily Grossman  
Greg Grove  
Lynne Gugeshain  
Lisa Gugeshain  
Ed Haj  
Gayle Hershman  
Ruth Hershman  
Peter Herdshy/Karen Trull  
Jane Hoffman  
Mark Holliger  
Billy Hopkins  
Bernard Hughes/Helen  
Santoluc  
Patrick Hurley  
Amy Inoué/John Henry  
Derek  
Mark Jacobs  
By Jacobs  
Lorna Johnson  
Elmer Jones  
Karen Jones-Meadows  
Suk, Mary & Ruby Jay  
Judith Kane  
Mary Kane  
Martha Karna  
Shelva Katske  
Berilla Kay  
Gary Knox  
Pete Knox/Stephen Cohen  
Stephen Kirov/Anna Tzels  
Henry Kligor  
Merida Jean Kurtz  
Patricia Leach  
Joann Lemnick  
NIGHT Lindemann  
Joyce Lapsen  
Ray Larsen  
Bill Larson  
Patricia J. Linton  
Katharine Long/Bill Oakwood  
Andrew E. L. Lorber  
Julia Lovel  
Craig Lucas  
John Lyons  
Pete MacDonald  
Cathy Marshall  
Peter & Marlene Marshall  
Greg MaulTherson  
W. H. Maup/Felicitly Hoffman  
Roma Malla  
Nancy Malar  
Beverly Mansfield  
Dorothea Marusale  
David Margulies  
Donald Margulies/Lynn Street  
David Marsh  
Ann M. Martin  
Jane Reed Martin  
Donna Maxwell

Lee Maurer  
Corvise S. Mauro  
Joan McAllister  
Paul McCrane  
James & Henrietta McDermid  
Frances McDermid  
Elise Swinton Miller  
Steven Miller/Maria Wira  
David Muth  
Max Mitzel  
Bill Mitchell  
Cass Morgan  
Karen Myrie  
Kate Nediger/Rob  
Fleish  
Ted Newsholt  
Cynthia Nixon  
Ellen Novack  
Quentin O'Brien  
Michael O'Hall  
Steven J. O'Hall  
Kevin O'Rourke/Edith  
Thorpe  
Carol Oche  
Eric Orentlicher  
John Parham/Christine  
Sutherland  
Ellen Parker  
Mary Ellen Parks  
Alexandra Paslon  
David Parker  
Nancy Pastore  
Jill Patterson  
Wendy Paulson  
The Pomeroy's  
Shirley Reine  
Tim & Tyson Ray  
Mr. & Mrs. Gene Reide  
Paul Reide  
Lisa Reed  
Elizabeth Pegg  
Michael Reine/Kate  
Burton  
Enid Reich  
Karen L. Rose  
Mirna Rose  
Bruce & Ellen Roseman  
Gabriel Rose  
Kathryn Rosenthal/Lewis Black  
John Rothman  
Alice Margaret Rubin  
Joyce Rubin  
Shirley Rubin  
Tim Santoro  
Gideon Schein  
Sharon Schwarz  
Sandy Schwab  
Ken & Mary Ann Schuster  
Sara Scott  
John Patrick Sharkey/Jayne  
Haynes  
Barry Shapiro  
Gard Shapiro  
Ronnie Shapiro  
Peter Shavit  
Alan D. Siegel  
Meg Simon  
Jeannine Simon  
Barry Singer  
Daniel Judith Sklar  
Lois Smith  
David Soo  
Leslie Spencer

Florence Stanley  
Martin Swerman  
Robert Swickler  
Jean Stein  
Alberta Stout  
Kath & Cathy Swartz  
Jeff Sugarman  
Andrew Sweet/Lisa Taylor  
Daniel Swetz  
Helaine Tardiff  
Bernie Tawey  
Joan Yell Thorne  
Tracy Thorne  
Peter Thorpe  
Laura Valerios  
Kevin Ward  
Ira Weitzman  
Mary Weisberg  
Mr. & Mrs. Robert Weiner  
Mr. & Mrs. Robert Wilkie  
Susan Wilerman  
Harry Wisner  
Andrew & Hannah Wolik  
James Yoshimura  
Janet Zarin

## THE 52ND STREET PROJECT Presents







**THE 52ND STREET PROJECT**  
**Presents**  
**THE DREAM THEME**

### Project Staff

Willie Reale, Artistic Director  
Marsue Cumming, Executive Director  
Mina Hammer, Production Manager  
Daniel Judah Sklar, Playmaking Director  
Gayle Hanrahan, Triple Play Club Volunteer  
Polly Adams, Playmaking Volunteer  
Claudine Jellison, Playmaking Volunteer

### Production Staff

Donald Berman, Guest Artistic Director  
Kevin Joseph Roach, Set Designer  
Greg MacPherson, Lighting Designer  
Marguerite Scott, Stage Manager  
Iris A. Brown, Graphics/Slides  
Jackie Thurik, Costumes  
George Babiak, Props  
Anne O'Sullivan, Sound  
Hugh Sindair, Technical Director  
Tracy Knights, Light Board Operator  
Neria Shelton, Colorforms  
Bill Wrubel, Synthesizer  
Scobie Putschler, Furniture  
Jose Soto, Slide Operator

Katherine K. Lumb, Running Crew  
Karen Myrie, Running Crew  
Claudia Tracy, Running Crew  
Andrew Kaplan, Set-up Crew  
Janet Freeman, Set-up Crew  
Fred Fehrmann, Light Hang  
Meredith Portman, House Manager  
Dorothy Atcheson, House Crew  
Katie Atcheson, House Crew  
Julia Crozier, House Crew  
Carolyn Morrow, House Crew  
Ross Purcey, House Crew  
Louise Quayle, House Crew  
Jill Thompkins, House Crew  
Amy Pahlka-Sellers, Swing Crew

The 52nd Street Project is an independent nonprofit organization that operates with the cooperation of the Police Athletic League and the Ensemble Studio Theatre. The Project brings inner-city children together with professional theatre artists to create theatre. The Dream Theme production is a part of our Playmaking program that is designed to teach children how to write plays. After eight weeks of classes, each child is given two actors, a theme and a director who guides him or her through the writing of a play during a weekend in the country. These are the fruits of their labors.

### Board of Directors

Ben Barenholtz  
Marsue Cumming  
Wendy Ettinger, Chairperson

Stephen Graham  
Pamela Lack  
Heidi Landesman  
Frances McDormand

Carol Ochs  
Willie Reale  
Pamala Tyson  
Laura Valeroso

### Special Thanks To:

Sam Moore and the staff of P.A.L.'s Duncan Center; Curt Dempster, Dominick Balletta, Robin Smith, Joseph DeFilippis, Bob Airhart, Randall Quan and the staff of E.S.T.; Rob Keale; Henry Krieger; Pat Murphy; Frances McDormand and Joel Coen; Barbara P. Ettinger; Sanford Goldstein; Phyllis Binaghi and Colorforms; Stephen Mendillo; Michael John LaChiusa; Arthur French; Joan Rosenfels; Mizon Nunes; Scottie Davis; Sandi Francis; Haagen-Dazs; Naked Angels and the Bicycle Habitat

### In-Kind Contributions:

Police Athletic League; Ensemble Studio Theatre; Hudson Scenic Studios; Bruce Cohen and Associates; Colorforms; Goldstein, Schrank, Segelstein and Shays; Sanford Goldstein; Bernhardt Fudyma Design Group; New York Giants

Part from Citibank, the Liz Claiborne Foundation, the Milton Gordon Foundation, Manufacturers Hanover Trust and The Leonard N. Stern Foundation has helped make it possible for the Ensemble Studio Theatre to present *The 52nd Street Project*.

Thank you for coming! If you are not on our mailing list (or if your address has changed), please fill out this form and give it to us on your way out, or mail it to the address below. We would also like to know if you would like to be of help to us in the future (primarily in the areas of fund-raising, printing, video dubbing and backstage). If so, please fill out your name, phone number and area(s) of interest below.

**PLEASE ADD ME TO YOUR MAILING LIST:**

Name \_\_\_\_\_

Address \_\_\_\_\_

\_\_\_\_\_ Zip \_\_\_\_\_

Phone \_\_\_\_\_

**YES, I WOULD LIKE TO BE OF HELP:**

\_\_\_\_\_

Daytime Phone \_\_\_\_\_

Area(s) of Interest \_\_\_\_\_

I would be interested in being a crew head for your next production \_\_\_\_\_

If you would like to mail this, and/or a donation, you may do so to: The 52nd Street Project, 552 West 52nd St., New York, NY 10019 (212) 245-1350.

have a brand new batch of 52nd Street Project T-Shirts (with the Shel Silverstein logo) on sale in the lobby for \$12.00. Half of this is tax-deductible. Colors include Black, Red, Fuschia, Jade, Grey and a limited number of Gold, Green and White. Great Gift Idea! Why not pick up several for the holidays????

**THE DREAM THEME**  
**Ensemble Studio Theatre**  
**November 29th, 30th and December 1st, 1990**

**SCARED**

by Ronnie Noonan

Director/Dramaturg: Katharine Long

APRIL.....Marcell Rosenblatt

DAVE.....Bill Cwikowski

**A MEAN DREAM**

by Samona Squire

Director/Dramaturg: Pamela Berlin

MOLLY.....Judy Tate

DIMITRI.....Paul Carlin

MS. HAAGEN-DAZS.....Marcia Jean Kurtz

**A DREAM OF LIFE (AND HOW TO LIVE IT)**

by Jamar Williams

Director/Dramaturg: Delroy Lindo

MR. ERIC.....Christopher Ceraso

MR. BARRY.....Leon Addison Brown

**IT'S ALL A DREAM**

by Wendell Borrero

Director/Dramaturg: William Carden

VICTOR.....Peter Francis James

JANET.....Polly Adams

## **THE REALTOR AND THE RATKING**

by Richard Myrie

Director/Dramaturg: Willie Reale

LAURA, A REALTOR.....Karen Evans-Kandel

RATKING.....Peter MacNicol

-INTERMISSION-

## **ALL GOOD PEOPLE GO TO HEAVEN**

by Elijah Barbosa

Director/Dramaturg: Daniel Judah Sklar

AMY.....Lili Taylor

JESUS.....Paul S. Eckstein

## **ANNA FALLS IN LOVE**

by Yolanda Maldonado

Director/Dramaturg: Kirsten Sanderson

MOTHER.....Leigh Curran

ANNA.....Cecilia Arana

STOREWORKER.....Michael John LaChiusa

DON.....Donald Berman

"I Like Don", lyrics by Yolanda Maldonado; music by Cecilia Arana

"Mom And Me", lyrics by Yolanda Maldonado; music by Henry Krieger

Accompaniment & Incidental Music by Michael John LaChiusa

## **LOVE AND POWER DON'T MIX**

by Jessica Soto

Director/Dramaturg: Susan Willerman

PAM.....Lyn Greene

MR. DEVILSON.....John Rainer

## **DREAM MACHINE**

by Eric Santoni

Director/Dramaturg: Reinaldo Povod

DREAMER.....Jerome McGill

JAMMER.....Pamala Tyson



# SHOW PROGRAMS 1991-1995

The 52nd Street Project gratefully acknowledges the support of the following foundations, corporations and individuals:

Altman Foundation, The Robert Bowne Foundation, Consolidated Edison, Nathan Cummings Foundation, Educational Foundation of America, The William & Mary Greve Foundation, The Hennessy Foundation, The Kids Fund, The Marquis George MacDonald Foundation, The James Macdonald Foundation, The Manhattan Community Arts Fund, Morgan Guaranty, Morgan Stanley Foundation, The New World Foundation, New York City Department of Youth Services, New York State Council on the Arts, The New York Times Company Foundation, The Samuel and May Rudin Foundation, The Fan Fax and Leslie R. Samuels Foundation, Spunk Fund, Inc., The Threshold Foundation, The Village Voice OBIE Awards, The Young Women's League of Westport and

Polly Adams  
Jane Anne Anderson  
Alan Arfa/Kay Malschullat  
Norma K. Azen  
Dorothy B. Alcheson  
Linda Atkinson  
Jean Bacharach  
Joanne Bailey  
Barbara Bakat  
Cathy Barancik  
Ben Barenthtz  
Karin Barry  
Jo Baslow  
Ann Beckerman  
Terry Belanger  
Emily Benton  
Stephanie Berger  
Amy Birnbaum  
Mr. & Mrs. G. Biseinger  
Scott Brandon  
Michael Brennan  
Rita C. Brooks  
Eric Brooks  
Becky Browder  
Garrett M. Brown  
Ann D. Brown  
in memory of Mack Buckaloo  
Mindy Byer  
Tony Campia/Kathy Bates  
Michee Caye  
Laura Maria Censabella  
Chris Ceraso/Carla Meadows  
Cheryl Chalmers  
Elen Chenoweth  
Raquel Chung  
George Coakley  
Joel Coen  
Ruth Cohen  
Richard S. Cohn  
Patricia Coleman  
Tom Cook/Susan Turner  
Joan Craton  
Arthur Dantchik  
Dale Davis/Harris Spylios  
Maddy deLone/Robert Cohen  
Curt Dempster  
Catherine Grace Dent  
John Douglas  
The Dreisbach's  
Rick & Rebecca Dresser  
Charles and Josephine Dumas  
Ned Eisenberg  
Robert Ellison  
Bill Elverman  
Barbara L. Ettinger  
Barbara P. Ettinger  
Wendy Ettinger  
Martha Evans/Per Loving  
Susan Evers/Fion Black  
Bill Fagerbakke  
Elsa First  
Ben Fishbein  
Janet Foster/Michael Geiger  
Richard Fox  
David Frankel  
Patricia Freebery/Bruce Frye  
Bruno & Roslyn Friendenthal  
Elizabeth Friedman  
Louis Friedman  
Mo Ganey

Dabney Payne Gibson  
Nancy Giles  
Jack Gilpin/Ann McDonough  
Gilbert Girion/Christie Mullen  
Ira Glass  
Didi Goldenhar/David Wolf  
Sanford Goldstein  
Elaine Golin  
Patricia Graf  
Stephen Graham  
Helen Graves  
Dr. LaRuth Gray  
Michael A. Green  
Colin Greer/Frances LaBarre  
Flavia Grimm  
Emily Grishman  
Greg Grove  
Lynne Gugenheim  
Lisa Gugenheim  
Ed Hajj  
Randy Hale  
Carl and Kathleen Hammer  
Gayle Harrahan  
Ruth Hercolani  
Peter Herdrich/Karen Trott  
Sarah Hershey  
Jane Hoffman  
Mark Hollinger  
Billy Hopkins  
Bernard Hughes/Helen Stenborg  
Patrick Hurley  
Amy Introcasso/John Henry Davis  
Lorna Johnson  
Gregory R. Johnson  
Elinor Jones  
Karen Jones-Meadows  
Bob, Mary & Ruby Joy  
Judith Kane  
Mary Kane  
Martha Kearns  
Sheila Kehoe  
Mark J. Kennedy  
Berrille Kerr  
Gary Knox  
Rita Knox/Stephen Cohen  
Henry Krieger  
Marcia Jean Kurtz  
Pamela Lack  
Joann Lamneck  
Joyce Lapenn  
Ray Larsen  
Jill Larson  
Katherine Long/Bill Owikowski  
Andrea E. L. Lorber  
Julia Lord  
Craig Lucas  
John Lyons  
Cathy MacNeil  
Peter & Marsus MacNicol  
Greg MacPherson  
W. H. Macy/Feldty Hultman  
Roma Maffia  
Nancy Meier  
Beverly Mansfield  
Dorothea Manuela  
David Margulies  
Donald Margulies/Lynn Street  
Ann M. Martin  
Jane Reed Martin  
Donna Massetti

Lisa Maurer  
Connie S. Mauro  
Joan McAllister  
Paul McCrane  
James & Hannelore McDaniel  
Pirie McDonald  
Frances McDormand  
Elise Bretton Miller  
Steven Miller/Marie Winn  
David Misch  
Max Mitchell  
Bill Mitchelson  
Case Morgan  
Karen Myrie  
Kate Nelligan/Rob Reale  
Ted Neustadt  
Cynthia Nixon  
Elen Novack  
Ouentin O'Brien  
Michael O'Neill  
Steven J. O'Neill  
Kevin O'Rourke/Edith Thurber  
Carol Ocha  
Eric Overmyer  
John Pankow/Kristine Sutherland  
Ellen Parker  
Mary Ellen Parka  
Alexandra Paxton  
Thomas P. Peters  
Nancy Piccione  
Jill Portman  
Wendy Radford  
The Rasminsky's  
Shirley Ratner  
Edward Ray  
Tim & Tyson Ray  
Mr. & Mrs. Gene Reale  
Paul Reed  
Lisa Reed  
Elizabeth Rigg  
Michael Ritchie/Kate Burton  
Enid Roach  
Karen L. Rosa  
Minna Rose  
Bruce & Ellen Roseman  
Galen Ross  
Kathryn Rosetter/Lewis Black  
John Rothman  
Alice Margaret Rubin  
Joyce Rudnick  
Shirley Rumlerk  
Tim Sanford  
Gideon Schein  
Sharon Schfarth  
Sandy Schreiber  
Seret Scott  
John Patrick Shanley/Jayne Haynes  
Barry Shapiro  
Carol Shapiro  
Ronnie Shapiro  
Peter Shevitz  
Alan D. Siegel  
Meg Simon  
Jacqueline Simon  
Barry Singer  
Daniel Judah Sklar  
Lois Smith  
David Soo

Leslie Spencer  
Jerome Spina, Jr.  
Florence Stanley/  
Martin Newman  
Robert Stecker  
Jean Stein  
Alberta Stout  
Keith & Cathy Suenholtz  
Jeff Sugarman  
Andrew Sweet/Lisa Taylor  
Daniel Sweet  
Helaine Tankall  
Bernie Telsky  
Mary Testa  
Joan Vail Thorne  
Tracy Thorne  
Laura Valeroso  
Peter Valeroso  
Kevin Ward  
Ira Weltzman  
Mary Wesley  
Mr. & Mrs. Robert Weiner  
Mr. & Mrs. Robert Wilder  
Susan Willem  
Harry Winer  
Andrew & Hannah Wolk  
Jeff and Janine Yasa  
James Yoshimura  
Janet Zarish

## THE 52ND STREET PROJECT Presents

# A PEACE OF MY MIND





**THE 52ND STREET PROJECT**  
Presents  
**A PEACE OF MY MIND**

**Project Staff**

Willie Reale, Artistic Director  
Marsue Cumming, Executive Director  
Mina Hammer, Production Manager  
Daniel Judah Sklar, Playmaking Director  
Greg Grove, Playmaking Volunteer

Meredith Portman, Playmaking Volunteer  
Judy Tate, Playmaking Volunteer  
Jenny Gersten, Intern  
Karen Schreiner, Intern



**Production Staff**

Janet Zarish, Guest Artistic Director  
Kevin Joseph Roach, Set Designer  
Tracy Knights, Lighting Designer  
Jenny Peek, Stage Manager  
Iris A. Brown, Graphics  
Mina Hammer, Slides  
Kym Michaud, Costumes  
Katherine K. Lumb, Props  
Ed Miller, Sound  
Andrew Kaplan, Technical Director  
Kermit Perlmutter, Light Board Operator  
Nancy Levin, Colorforms  
Tracy Reese, Synthesizer  
Claudia Tracy, Furniture  
Susan Murray, Slide Operator  
Aleksandra Puchlik, Colorforms Designer  
Marthe LeVan, House Manager  
Karin Barry, Running Crew  
Jill Slaymaker, Running Crew  
Margot Avery, House Crew

Kate Baggott, House Crew  
Jessica Bauman, House Crew  
Patty Cornell, House Crew  
Dody Fogel, House Crew  
Richard Ford, House Crew  
Dan Formento, House Crew  
Karen Myrie, House Crew  
Tracy Proust, House Crew  
Kirsten Sanderson, House Crew  
Marguerite Scott, House Crew  
Don Baron, Set Crew  
Cathy Contopoulos, Set Crew  
Tom Gardner, Set Crew  
Michael Huber, Set Crew  
Max Mitchell, Set Crew  
Stewart Kasden, Set Crew  
Aleta Kauffman, Set Crew  
Jean Bacharach, Light Hang and Focus  
Jessica Bauman, Light Hang and Focus  
Illeana Hoffman, Light Hang and Focus  
Karen Schreiner, Kid Wrangler  
Mo Ganey, Mailing

The 52nd Street Project is an independent nonprofit organization that operates with the cooperation of the Police Athletic League and the Ensemble Studio Theatre. The Project brings inner-city children together with professional theatre artists to create theatre. The A Peace of My Mind production is a part of our Playmaking program that is designed to teach children how to write plays. After eight weeks of classes, each child is given two actors, a theme and a director who guides him or her through the writing of a play during a weekend in the country. These are the fruits of their labors.



**Board of Directors**

Ben Barenholtz  
Marsue Cumming  
Wendy Ettinger, Chairperson  
Stephen Graham

Pamela Lack  
Heidi Landesman  
Frances McDormand  
Carol Ochs

Willie Reale  
Pamala Tyson  
Laura Valeroso



**Special Thanks To:**

Sam Moore and the staff of P.A.L.'s Duncan Center; Curt Dempster, Dominick Balletta, Robbin Smith, Maureen Martin, MICHAEL MOODY and the staff of E.S.T.; Greg MacPherson (!); Pat Murphy; Frances McDormand and Joel Coen; Barbara P. Ettinger; Sanford Goldstein; Phyllis Binaghi and Colorforms; T.D.F. Costume Collection; Wendy Ettinger; Carol Ochs; Jeff Williams; Lili Taylor; Michael Milea; Ronnie Noonan; Danny Noonan; Karen Schreiner; Annette Myrie; Jessica Soto; Kevin Roach; Jenny Gersten; Neil Mazzella and Hudson Scenic Studios and Mark Gould.



**In-Kind Contributions:**

Police Athletic League; Ensemble Studio Theatre; Hudson Scenic Studios; Bruce Cohen and Associates; Colorforms; Goldstein, Schrank, Segelstein and Shays; Sanford Goldstein; Bernhardt Fudyma Design Group and Stephen Graham



*Support from Citibank, the Liz Claiborne Foundation, the Milton Gordon Foundation, Manufacturers Hanover Trust and The Leonard N. Stern Foundation has helped make it possible for the Ensemble Studio Theatre to present The 52nd Street Project.*

# THE 52ND STREET PROJECT'S

## A PEACE OF MY MIND

Ensemble Studio Theatre

March 22nd, 23rd and 24th, 1991

### JAZZY JEFF AND BORING BARBARA MEET

by Olaniyi Makinde, Age 11 ←

Director/Dramaturg: Paul McCrane

JAZZY JEFF.....Jeff Lee

BORING BARBARA.....Barbara McCrane ←

### THE HUNGRY ALIEN

by Gabriel Garcia, Age 10 ←

Director/Dramaturg: Greg Grove

CYCLOPPA.....Laveme Hart ←

CYCLOPPO, her father.....Karl Soderstrom ←

CYCLOPPEE, her mother.....Martha Horstman ←

BIG DIPPER.....Donald Berman

### THE CLOWN AND THE GIRL

by Evelyn Maldonado, Age 9

Director/Dramaturg: Judy Tate

GYPSY.....Heather Lupton ←

YOLANDA.....Janet Zarish

### BOB'S DRUG ADVENTURE

by Luis Santoni, Age 11 ←

Director/Dramaturg: Meredith Portman

BOB.....Christopher Randolph ←

ANGEL.....Jeff Williams

**NOT LONELY ANYMORE**

by Kristy Lopez, Age 11 ←

Director/Dramaturg: Kay Matschullat ←

SARAH.....Anne Twomey ←

JANAL.....John Bedford Lloyd ←

**A MIND OF YOUR OWN**

by Eddie Zambrano, Age 9 ←

Director/Dramaturg: Daniel Judah Sklar

BANANA.....Ben Siegler

APPLE.....Samuel Le Bihan ←

**THE POWER OF LOVE**

by Joanne Ramirez, Age 13 ←

Director/Dramaturg: Byam Stevens ←

MONIQUE.....Sheryl Bess ←

DANNY.....Reed Birney ←



# THE 52ND STREET PROJECT

gratefully acknowledges the support of the following foundations, corporations, government agencies and individuals:

Altman Foundation, The Robert Bowne Foundation, The Liz Claiborne Foundation, Consolidated Edison, Nathan Cummings Foundation, Department of Cultural Affairs, Educational Foundation of America, The William & Mary Greve Foundation, The Hennessy Foundation, The Kids Fund, The Eugene & Rose Kleiner Family Foundation, The Marquis George MacDonald Foundation, The James Macdonald Foundation, The Manhattan Community Arts Fund, Morgan Guaranty, Morgan Stanley and Co., Inc, The New World Foundation, New York City Department of Youth Services, New York State Council on the Arts, The New York Times Company Foundation, The Samuel and May Rudin Foundation, The Fan Fox and Leslie R. Samuels Foundation, Spunk Fund, Inc., The Threshold Foundation, The Village Voice OBIE Awards, The Young Women's League of Westport and

Polly Adams  
Mr. & Mrs. William R. Adams  
Mr. & Mrs. Addison  
Diana Adee  
Jane Anne Anderson  
Alan Arffa/Kay Matuschall  
Dorothy B. Acheson  
Linda Atkinson  
Margot Avery  
Jenn Barzach  
Anne Bailey/Charles Wright  
Joanne Bailey  
Deborah Baker  
Wendy Baker  
Barbara Baker  
Dominick Balletta  
June Ballinger/Michael Goldstein  
Michael Bandier  
Cathy Barancik  
Ben Barancik  
Karin Barry  
Miranda Barry  
Jo Baslow  
Judy Massey Becker  
Ann Beckerman  
Terry Belanger  
Emily Benton  
Stephanie Berger  
Howard & Pat Berke  
Amy Birnbaum  
Mr. & Mrs. G. Biasinger  
Kristina Borowicka  
Fran Brill  
Hisa C. Brooks  
Eric Brooks  
Becky Browder/Ted Neustadt  
Garrett M. Brown  
Karen Brown  
in memory of Mack Buckaloo  
Mindy Byer  
Tony Campisi/Kathy Bates  
Alan Carter  
Susan Carter  
Michae Caye  
Laura Maria Censabella  
Chaire L. Chafes  
Cheryl Chalmers  
Rachel Chanoff  
Jill & Don Chaostain  
Ellen Chenoweth  
Pam & Michael Chepiga  
Louis Chiffarano  
Raquel Chung  
George Coakley  
Ruth Cohen  
Richard S. Cohn  
Patricia Coleman  
Tom Cook/Susan Termer  
Janet Crawford  
Edla Cwik  
Arthur Dantschik  
Main Damsiger  
Cynthia Darlow  
Leslee Dart  
Wende Datzel/Neil Cuthbert  
Dale Davis/Harris Spylios  
Maddy deLone/Robert Cohen  
Robert de Roacheid  
Carol & Booth Deakine  
Catherine Grace Dent  
The Dreubach's  
Rick & Rebecca Dresser  
Moira Driscoll  
William Duff-Griffin  
Charles and Josephine Dumas  
Ned Eisenberg  
Owen Ellison  
Robert Ellison  
Dana Emmons  
John P. Engel  
Barbara L. Ettinger  
Barbara P. Ettinger  
Wendy Ettinger  
Martha Evans/Pet Lofving

Susan Ewen/Ron Black  
Bill Fagerbakke  
Leslie Fanelli  
Jessica Feder-Birnbaum  
Peter Jay Fernandez  
Elas Fint  
Ben Fuhbein  
Tom Fontana/Sagan Lewis  
James Foreman  
Janet Foster/Michael Geiger  
Richard Fox  
David Frankel  
Bruno & Roslyn Freundenthal  
Lisa Frey/John McLaughlin  
Elisabeth Friedman  
Louis Friedman  
Mo Ganey  
in honor of Rozanne Oates  
Joseph Giardina  
Jack Gilpin/Ann McDunough  
Hilbert Girion/Christie Mulren  
Ira Glass  
Didi Goldenhar/David Wolf  
Alvin Goldfine  
Mrs. Ben P. Goldman  
Terry Goldman  
Edward & Susan Goldstein  
Sanford Goldstein  
Susan Goldstein  
Elaine Golin  
Christopher Gould  
Patricia Graf  
Stephen Graham  
Helen Graves  
Dr. LaRuth Gray  
Michael A. Green  
in honor of Cara Greene  
Sara Greenwood  
Colin Greer/Frances LaBarre  
Janet Grillo  
Flavia Grimm  
Emily Grishman  
Ed Haj  
Randy Hale  
Lynne Halliday  
Jonathan Hamel  
Carl and Kathleen Hammer  
Zella B. Hammer  
Evan Handliss  
Triha Hanger  
Gayle Hanrahan  
Raleigh Hansl  
Kamya Harding  
Gerard E. Harper  
Diana Haskel  
Duncan Hazard  
Ruth Hercolani  
Peter Herdrich/Karen Trout  
Sarah Hershey  
Chris Hill  
Jane Hoffman  
Billy Hopkins  
Irwin Horowitz  
Barnard Hughes/Helen Stenborg  
Patrick Hurley  
Amy Introcasso/John Henry Davis  
Cella Irvine  
Yves-Andre Istel  
Sy Jacobs  
Claudine Jefferson  
Cindy Lou Johnson  
Lorna Johnson  
Gregory R. Johnson  
Elinor Jones  
Karen Jones-Meadows  
Bob, Mary & Ruby Joy  
Lauren S. Kamens  
Judith & Michael Kane  
Mary Kane  
Martha Kearns  
Sheila Kehoe  
Mark J. Kennedy  
Berrilla Kerr

Ken Ketay/Alan Schaap  
Rita Knox/Stephen Cohen  
Judy Kuhn  
Marcia Jean Kurtz  
Lewis M. Kuit  
Pamela Lack  
Joann Lamneck  
Joyce Lapenn  
Ray Larsen  
Jill D. Larson  
Kate Lear  
Jesse & Dana Lehman  
Georgette & Morton Levy  
Vince Liebhart  
John Bedford Lloyd/Anne Twomey  
Katharine Long/Bill Cwikowski  
Andrea E. L. Lorber  
Craig Lucas  
Chris & Sally Lutz  
John Lyons  
Cathy MacNeil  
Peter & Marvise MacNicol  
Greg MacPherson  
W. H. Macy/Felicity Huffman  
Roma Maffia  
Michelle S. Magaine  
Cary Maloney/Hermes Malles  
Beverly Manafiel  
Dorothea Manuella  
David Margulies  
Donald Margulies/Lynn Street  
Ann M. Martin  
Jane Read Martin  
Mr. & Mrs. Peter Masterson  
Carmen Mathews  
Connie S. Mauro  
Joan McAllister  
Elsie M. McCabe  
Paul McCrane  
James & Hannelore McDaniel  
Pirle McDonald  
Frances McDermand  
William McElhinney  
Wilma & Norman Michaels  
Elise Britton Miller  
Steven Miller/Marie Winn  
David Mich  
Max Mitchell  
Bill Mitchellson  
George S. Morfogen  
Cass Morgan  
Patricia M. Murphy  
Susan Murray  
Lis Nealon  
Kate Nelligen/Rob Reale  
Charles M. Nelson  
Peter Neufeld  
Ted Neustadt  
Cynthia Nixon  
Doris O'Neill  
Michael O'Neill  
Steven J. O'Neill  
Kevin O'Rourke/Edith Thurber  
James L. Oakes  
Carol Ochs  
Henry D. Oatberg  
John Parlow/Kristine Sutherland  
Ellen Parker/Mack Lipkin  
Mr. & Mrs. Robert Parker  
Mr. & Mrs. Sanjay Patel  
Alexandra Paxton  
Frances Peiper  
Thomas F. Peters  
Nancy Piccione  
Jill Portman  
The Rasminsky's  
Shirley Ratner  
Edward Ray  
Tim & Tynon Ray  
Elizabeth Rea  
Paul Reale  
Lisa Reed  
Jacquelyn Reingold  
James Rewon

Elizabeth Rigg  
Michael Ritchie/Kate Burton  
Lilit Robertson  
Gus Rogerson  
Karen L. Rosa  
Minna Rose  
Bruce & Ellen Roseman  
Bara Rosenheck  
Gaylen Rose  
Kathryn Rossetter/Lewis Black  
Andy Roth  
John Rothman  
Alice Margaret Rubin  
Joyce Rudnick  
Paul Rudnick  
Amy Saltz  
Steven Sater  
Barry Scheckner  
Larry & Deborah Schiff  
Sharon Schlarth  
Lynn Schlesinger/William Lum  
Don Schneider  
Sandy Schreiber  
Ken & Mary Ann Schuster  
Seret Scott  
Angela & John Scrimenti  
Julie Selbo  
Susan Shacter  
John Patrick Shanley/Jayne Hays  
Barry Shapiro  
Carol Shapiro  
Murray Shapiro  
Ronnie Shapiro  
Peter Shawitz  
Bernice Baruch Shaw  
Brian Siberell/Patty Dryden  
Alan D. Siege  
Ben Siegler/Ginny Addison-Siegler  
Jacqueline Simon  
Meg Simon  
Alice Simpson  
Barry Singer  
Daniel J. udah Sklar  
Lois Smith  
Stephen Sondheim  
Leslie Spencer  
Jerome Spina, Jr.  
Florence Stanley/  
Martin Newman  
Robert Stecker  
Jean Stein  
Tom & Maureen Stewart  
Jeff Sugarman  
Andrew Sweet/Lisa Taylor  
Daniel Sweet  
Helaine Tankell  
Bernie Telsey  
Mary Testa  
Michael Thomas  
Joan Vail Thorne  
Tracy Thorne  
Catherine C. Tracy  
Martin & Kathleen Treat  
Michael Unthank  
Laura Valeroso  
Peter Valeroso  
Ida Valerente  
Mr. & Mrs. Charles Ward, III  
Kevin Ward  
Ira Weitzman  
Betty West/Oren Jacoby  
Dawn Westbrook  
Roland Westbrook  
Mr. & Mrs. Robert Wilder  
Susan Willerman  
Peggy Williams  
Harry Winer  
Gwen Winston  
Joan & Duack Wolf  
Jeff and Janine Yass  
Peter Zapp  
Janet Zariuh  
Gail Zweigenenthal  
(as of May 23, 1991)



*The 52nd Street Project*

1981-1991



CHRISTMAS DREAMS X THE FURTHER ADVENTURES OF NICK T.

MARKER X MINTHORN '84 X NICK T. MARKER... THE STORY DRAGS ON X DIG IT! X THE WORLD IS GETTING TO BE A BAD NEIGHBORHOOD X ONE-ON-ONE X SON-8 X THE DINOBAJU MUSICAL X SURF AND

ZONE X THE MOON PLAYS X THE SPRING THING X YOU CAN'T COPYRIGHT A TITLE X QUAR VICTORY X FAMILY STORIES X HUMAN NATURE X THE BUTLER DID IT! X THE DREAM THEME X A PEACE OF MY MIND X SEEN BUT NOT HEARD X

THE 52ND STREET PROJECT PRESENTS  
A KATE BURTON PRODUCTION

---

*Ten Will Get You Twenty*

---

A TENTH ANNIVERSARY MUSICAL RETROSPECTIVE

*Monday June 3, 1991*

*Vivian Beaumont Theater at Lincoln Center*

OUR VERY SPECIAL THANKS TO

---

Bruce Cohen and Associates; Ensemble Studio Theatre; Gilbert Paper Company; Cathy Barancik Graham; Bloomingdale's; Ronnie Davis and Washington Street Cafe Caterers; Dreisbach; Colin Greer and The New World Foundation; Charles Halpern, Joan Shigekawa and The Nathan Cummings Foundation; Eugene and Rose Kleiner Family Foundation; Julie Latzer, Michele S. Magazine and Scholastic, Inc.; Lincoln Center Theater; Andy Mintzer and Graphics For Industry; Michaela Murphy; John Paris and Paris Chocolates Flyer Candy Bars; Nancy Piccione, Michele Piccione and Alfred Angelo Bridals; Police Athletic League; Laura Rosenthal; Dr. Arnold Rosenthal; Patricia Schaefer and Morgan Stanley and Co., Inc.; Shaffer, Clarke & Co., Inc.; Barry Shapiro, Joe Zaidman and Noh Hands Productions; Barry Singer and Chartwell Booksellers; Sweet Concessions; Tanagraphics, Inc.; Dale Ward and Vanco Stage Lighting; Diane Von Furstenberg Studio; and

Everyone on the Best and Biggest Benefit Committee ever assembled (we would list you all if we had the space, but we know you know who you are)

*52nd Street Project* is an independent organization that operates with the help and cooperation of the Ensemble Studio Theatre and the Police Athletic League. The Project brings inner-city children together with professional theatre artists to create theatre. Through a variety of programs that either give kids the opportunity to write plays or to perform in them, the Project is designed to give each child a successful experience every time.

IN-KIND CONTRIBUTIONS

---

Bernhardt Fudyma Design Group; Bruce Cohen and Associates; Colorforms, Inc.; Consolidated Edison; Ensemble Studio Theatre; John Greenleaf and MacEmporium; Sanford Goldstein; Stephen Graham; Lincoln Center Theater; Neil Mazzella and Hudson Scenic; Patricia M. Murphy and Shays and Murphy; New York Mets; Police Athletic League; Robert de Rothschild and Robert Saidenberg

---

Contrary to appearances, this evening's proceedings were scripted by Lewis Black and W.R.

## PRODUCTION STAFF

**Director**  
Kate Burton

**Musical Director**  
Irwin Fisch

**Producers**  
Rachel Chanoff  
Ira Weitzman

**Lighting Designer**  
Greg MacPherson

**Costume Designer**  
Helen Toth

**Sound Designer**  
Scott Lehrer

**Stage Manager**  
Michael Ritchie

**Asst. Stage Manager**  
Mina Hammer

**Asst. Musical Directors**  
Barbara McCrane  
Paul McCrane

**All Around Great Helper**  
Donald Berman

**House Electrician**  
James Maloney

**Asst. Electricians**  
Fred Bredenbeck  
Paul Gruen

**Master Flyman**  
Dave Gorel

**House Propertyman**  
George T. Greene, Jr.

**Properties Assistant**  
Rick Hardy

**House Carpenter**  
Andy Benzinger

**Wardrobe**  
Karen Lloyd

**House Manager**  
Rheba Flegelman

**Chief Usher**  
M. L. Pollock

**Graphics**  
Iris A. Brown

**Photographer**  
Stephanie Berger

**Public Relations**  
Bruce Cohen and Assoc.

**Benefit Co-Chair**  
Karin Barry  
Carol Ochs

**Orchestrators**  
Bruce Coughlin  
Irwin Fisch  
Marc Katz

Gary Knox  
Rob Reale  
Josh Shneider

**Music Preparation**  
Emily Grishman,  
supervisor  
Elise Bretton

**Rehearsal Pianist**  
Steven Freeman

**Crew**  
Jean Bacharach  
Jenny Gersten  
Tracy Knights  
Marthe LeVan  
Kathryn Lumb  
Shidan Majidi  
Derek O'Bannon  
Meredith Portman  
Christopher Randolph  
Tracy Reese  
Francoise Renaud  
Minna Rose  
Marguerite Scott  
Neria Shelton  
David Steffen  
Bill Wrubel

## PROJECT STAFF

**Artistic Director** ..... Willie Reale

**Executive Director** ..... Marsue Cumming

**Production Manager** ..... Mina Hammer

**Playmaking Director** ..... Daniel Judah Sklar

## BOARD OF DIRECTORS

Ben Barenholtz  
Marsue Cumming  
Wendy Ettinger, *Chair*

Stephen Graham  
Pamela Lack  
Heidi Landesman  
Frances McDormand  
Carol Ochs

Willie Reale  
Pamala Tyson  
Laura Valeroso

## CAST

*In Order of Appearance*

Michael Ritchie  
Willie Reale  
Reale  
Mike Lugo  
Mary Vamvoukakis  
Jose Soto  
Irwin Fisch  
Kate Burton  
Donald Berman  
Glen Jenkins  
Peter MacNicol  
Karen Myrie  
Milard Corbett  
Charina Corbett  
Dawn Jackson  
Latanya Godfrey  
Myrie  
Deneka Peniston  
Pamala Tyson  
Virginia Vargas

### KID CORRAL

Eli Barbosa  
Jill Barbosa  
Wendell Borrero  
Kulondi Frier  
Gabriel Garcia  
Nyita Hanley  
Monica Jenkins  
Kristy Lopez  
Maniyi Makinde  
Elyn Maldonado

Yolanda Maldonado  
Ronnie Noonan  
Lori Quinones  
Victor Rojas  
Joanne Ramirez  
Eric Santoni  
Luis Santoni  
Tina Vamvoukakis  
Jamar Williams  
Eddie Zambrano

Marsue Cumming  
Susan Willerman  
Mary Kane  
Kathryn Rossetter  
Kate Nelligan

### ADULT CHORALE

Erika Alexander  
Cecilia Arana  
Reed Birney  
Charles Dumas  
Greg Germann  
Lyn Greene  
Evan Handler  
Barbara McCrane  
Paul McCrane  
Kevin O'Rourke  
Phyllis Somerville  
Ann Talman  
Karen Trott  
Henry Krieger  
Darthula Harvey

Daniel Judah Sklar  
Samona Squire  
Ann McDonough  
Daniel Patrick Noonan  
Fracaswell Hyman  
Annette Myrie  
Frances McDormand  
Arlen Collier  
Lewis Black  
Jessica Soto  
Fran-Marie Fargardo  
Tia Nesmith  
Alex Bess  
Shamine Gibson  
Richard Myrie  
James McDaniel  
Kristen Saunders Bess

Sheryll Bess  
Chris Ceraso  
Leigh Curran  
Bill Cwikowski  
Karen Evans-Kandel  
Jeff Lee  
Kate Long  
Bruce MacVittie  
Jerry McGill  
Carla Meadows  
Michaela Murphy  
Larry Nathanson  
Lois Smith  
Sandye Wilson

## MUSICAL NUMBERS

*There Will Be No Intermission*

- THE ROAD TO THESPIA.....Peter MacNicol and Karen Myrie  
*Music and lyrics by Peter MacNicol*  
*Arranged by Henry Krieger*
- THE SLEEPING SONG.....Dawn Jackson and Charina Corbett  
*Music by Rob Reale*  
*Lyrics by Willie Reale*
- PRETTY LITTLE HEADS OF STATE.....  
.....Latanya Godfrey, Paula Myrie and Deneka Peniston  
*Music by Rob Reale*  
*Lyrics by Willie Reale*
- ALL THE CONVENIENCES.....Pamala Tyson, Virginia Vargas and the Kid Corral  
*Music by Rob Reale*  
*Lyrics by Willie Reale*
- THE SALAD BALLAD.....The Adult Chorale  
*Music by Henry Krieger*  
*Lyrics by Willie Reale*  
*Vocal Arrangement by Paul McCrane*
- SUPREME HAPPINESS OF LIFE.....Shirley Rumierk and the Adult Choir  
*Music by Henry Krieger*  
*Lyrics by Shirley Rumierk*
- I'VE GROWN ACCUSTOMED TO MY HEAD.....Darthula Harvey  
*Music by Henry Krieger*  
*Lyrics by Willie Reale*
- REFLECTIONS IN MY MIND.....Samona Squire  
*Music by Henry Krieger*  
*Lyrics by Monica Jenkins*
- WHY DO I FEEL SO...Y'KNOW.....Daniel Patrick Noonan  
*Music by Henry Krieger*  
*Lyrics by Willie Reale*
- IT'S OKAY TO DREAM.....Fracaswell Hyman and Annette Myrie  
*Music by Henry Krieger*  
*Lyrics by Willie Reale*
- WHAT YOU GOTTA DO.....Frances McDormand and Arlen Colton  
*Music by Rob Reale*  
*Lyrics by Cindy Lou Johnson*
- THE FALL GIRL SONG.....Jessica Soto  
*Music by Rob Reale*  
*Lyrics by Willie Reale*

- 23 SKIDOO.....  
Jose Soto, Fran-Marie Fargardo, Kulondi Frier, Paula Myrie, Tia Nesmith and Jessica Soto  
*Music by Rob Reale*  
*Lyrics by Willie Reale*
- BEING DIFFERENT.....Fran-Marie Fargardo and Paul McCrane  
*Music by Rob Reale*  
*Lyrics by Willie Reale*
- IT'S LOVE.....  
.....Alex Bess, Shamine Gibson, Paula Myrie, Tia Nesmith, Jessica Soto and Jose Soto  
*Music by Rob Reale*  
*Lyrics by Willie Reale*
- I'VE GOT YOU.....Richard Myrie and James McDaniel  
*Music by Henry Krieger*  
*Lyrics by Cindy Lou Johnson*
- FINALLY ALIVE.....Tia Nesmith and Company  
*Music by Rob Reale*  
*Lyrics by Willie Reale*

## BAND

- Jack Bashkow.....woodwinds
- Irwin Fisch.....keyboards/conductor
- Seth Glassman.....bass
- .....k Gould.....trumpet
- Brian Koonin.....guitar
- James Murphy.....drums/percussion
- Josh Shneider.....woodwinds/keyboards

# OOPS!

## ADDITIONAL CAST

Kulondi Frier and Virginia Vargas are now appearing in  
"The Road To Thespia"  
Karen Myrie is a part of The Kid Corral  
Sheryll Bess, Peter Herdrich and Bruce MacVittie are a part of  
The Adult Chorale

Vocal Arrangement for "Supreme Happiness of Life" by  
Paul McCrane

## ADDITIONAL PRODUCTION STAFF

### *Choreographer*

Pamala Tyson

### *Co-Sound Designer*

William Dreisbach

### *Sound Operator*

Marc Salzberg

### *Orchestrator*

Larry Hochman

### *Hair Stylists*

Sheryll Bess

Leslie Frier

Allison Johnson

### *Rehearsal Pianists*

Rusty Magee

Steve Sandberg

### *Crew*

Phyllis Bishop

Becky Browder

Nancy Fahy

Ellen Fahy

Angie Gari

Erin Hennessey

Illeana Hoffman

Kate Hurd

Allison Johnson

Nancy Levin

Sheri Maher

Michaela Murphy

Ted Nugent

Magnus Ragnarson

Joan Rosenfels

Michael Sancineto

Hugh Sinclair

Mary Wessley

Chris Wigle

## ADDITIONAL VERY SPECIAL THANKS TO

The Costume Shop, Manhattan Theatre Club; Playwrights Horizons;  
Rob Reale; Snow Sound; Stephen Jay Hair Salon; Carmine Maragni,  
Matthew Teutonico, Nick Villani and Zeller Tuxedos.

This production is presented in memory of



## LIFELESS CHRONOLOGY OF THE PROJECT

Before Funding



- ☛ September, 1981 - Willie faces first class of six kids at the P.A.L.
- ☛ June, 1982 - "Seen But Not Heard"
- ☛ December, 1982 - "Christmas Dreams"
- ☛ June, 1983 - "The Further Adventures of Nick T. Maker"
- ☛ July, 1983 - The 52nd Street Project Film
- ☛ June, 1984 - Minithon '84
- ☛ June, 1985 - "Nick T. Maker... The Story Drags On"\*
- ☛ June, 1986 - "Dig It!" and "The World Is Getting To Be a Bad Neighborhood"\*

- ☛ Summer, 1986 - The First One-on-Ones#
- ☛ December, 1986 - "Christmas Dreams" revived\*
- ☛ April, 1987 - 2-on-2s
- ☛ June, 1987 - "The Dinosaur Musical" \*
- ☛ Summer, 1987 - "Surf and Turf" #
- ☛ December, 1987 - "Christmas In Hollywood" \*
- ☛ February, 1988 - "The St. Valentine's Day Mascara" \*
- ☛ May, 1988 - "The Mother's Day Spectacular" \*
- ☛ Summer, 1988 - "The Bedtime Zone" #
- ☛ November, 1988 - "The Moon Plays" \*
- ☛ March, 1989 - "The Spring Thing" \*
- ☛ April, 1989 - The Return of "The Bedtime Zone" #
- ☛ Summer, 1989 - "You Can't Copyright A Title" #
- ☛ September, 1989 - "Quark Victory" \*
- ☛ October, 1989 - Sparky, the goldfish, taken in by the Project.
- ☛ February, 1990 - "Family Stories" \*
- ☛ June, 1990 - "HumanNature" \*
- ☛ June 12, 1990 - Sparky, the goldfish, found floating. Foul play suspected.
- ☛ Summer, 1990 - "The Butler Did It!" #
- ☛ November, 1990 - "The Dream Theme" \*
- ☛ March, 1991 - "A Peace Of My Mind" \*
- ☛ June, 1991 - "Ten Will Get You Twenty" \*

After Funding



### LEGEND:

- \* BPWLOK: Big Play With Lots Of Kids
- \* BPMLOK: Big Musical With Lots Of Kids
- # The One-on-Ones - one-act plays written by adults for 1 kid & 1 adult
- ☛ Playmaking - one-act plays written by kids for 2 adult actors

Thank you for coming tonight! If you are not on our mailing list (or if your address has changed) please fill out this form and give it to us on your way out, or mail it to the address below. We would also like to know if you would like to be of help to us in the future (primarily in the areas of fundraising, printing, video and audio dubbing and backstage). If so, please fill out your name, phone number and area(s) of interest below.

### PLEASE ADD ME TO YOUR MAILING LIST:

Name \_\_\_\_\_

Address \_\_\_\_\_

\_\_\_\_\_ Zip \_\_\_\_\_

Phone \_\_\_\_\_

### YES I WOULD LIKE TO BE OF HELP:

Name \_\_\_\_\_

Daytime Phone \_\_\_\_\_

Area(s) of Interest \_\_\_\_\_

I would be interested in being a crew head for your next production \_\_\_\_\_

### FOR SALE!

In the lobby you will find the following for sale:

52nd Street Project T-Shirts in a variety of colors with the world famous Shel Silverstein Logo! - \$12.00

The brand new Tenth Anniversary Commemorative Poster by Project designer, Iris A. Brown - \$10.00

"Playmaking" by Daniel Judah Sklar. A book about Daniel's techniques on how to teach kids how to write plays. - \$12.00

Please remember that half of the cost of these items is tax-deductible!

If you would like to mail this, and/or a donation, you may do so to:  
The 52nd Street Project, 552 West 52nd Street, New York, NY 10019  
(212) 245-1350.

**PLEASE REMEMBER - DONATIONS ARE GRATEFULLY ACCEPTED AT THE DOOR!**

The 52nd Street Project gratefully acknowledges the support of the following foundations, corporations, government agencies and individuals: Altman Foundation, The Robert Bowne Foundation, Citibank, The Liz Claiborne Foundation, Consolidated Edison, Nathan Cummings Foundation, D-B Trust, Department of Cultural Affairs, Educational Foundation of America, The William and Mary Greve Foundation, The Kids Fund, The Eugene and Rose Kleiner Family Foundation, The Marquis George MacDonald Foundation, The James Macdonald Foundation, Morgan Guaranty, Morgan Stanley and Company, New York State Council on the Arts, The Samuel and May Rudin Foundation, The Fan Fox and Leslie R. Samuels Foundation, The Threshold Foundation and

Polly Adams/John Klaus  
William R. Adams/Guarne Heagerty  
Beth Adams  
Mr. & Mrs. Addison  
Nancy Adelson/Clayton Lewis  
Diana Ales  
Lynette E. Allison  
Jane Anna Anderson  
Lisa Arfink/Key Macchiusi  
Linda Atkinson  
Margot Avery  
Tony Ayward  
Jean Bacharach  
Anne Bailey/Charles Wright  
Jaime Bailey  
Deborah Baker  
Wendy Baker  
Dominick Bakkaferra/Wilco  
Michael Bender  
Cathy Bernick  
Ben Bernowitz  
Miroslava Berry  
Gary Bernin  
Jo Berman  
Christopher Beach  
July Messery Becker  
Terry Berger  
Water Alan Bennett, Jr.  
Emily Benson  
Mr. & Mrs. H. Benton  
Andrew Benzinger  
Corinne Berger  
Pat & Howard Berke  
Amy Birnbaum  
Ronnie Birnbaum  
Andre Bishop  
Mr. & Mrs. G. Bissinger  
Allison M. Bivon  
Kathleen Bivovics  
Risa Broman/Rene Garcia  
William L. Brennan  
Bob Brink  
Fran Brit  
Rita & Fred Brooks  
Eric Brown  
Betty Bruester/Ted Neuzil  
Karen Brown  
Garret M. Brown  
Deborah Brown  
Philip J. Brown  
David Busin  
Merand Butt  
Mindy Byer  
Cafe Film Center  
Steven Callahan/Christine Dunn  
Anne Carney  
Alan Carter  
Susan Carter  
Anne Casanese  
Laura Maria Cassabala  
Claire L. Chales  
Cheryl Chalmers  
Rachel Chavoff  
Jill & Dan Charlan  
Ellen Chenoweth  
Michael & Pamela Chepiga  
Louise Chiffarelli  
Peter Christantopoulos  
Russell Chung  
Ben & Mary Clark  
Charles Ray Cochran  
Ruth Cohen

Richard J. Cohn  
The Cooper Committee  
George Corbin, Jr.  
Eileen Coste  
Janet Crawford  
Edie Cusick  
Neil Cutler/Wendy Dastel  
Arthur Dantchik  
Cathy Dantchik  
Melia Davigler  
Cynthia DeWise  
Leslie Dart  
Dore Dastafants Spyias  
Robert de Rothchild  
Carol & Brian Devine  
Catherine Grace Dent  
Mayrle & Vincent Deprez  
Joel Dill, Dief  
Jacqueline Donagan  
Patty Draper  
Mina Driscoll  
William Duff-Griffin  
Charles & Josephine Dumas  
Marl Edrinas  
Joanne Edger  
Neil Eisenberg  
Elisat & Hammer  
Owen Etkin  
Beth A. Emanuel  
Dana Emmons  
John P. Engel  
Wendy Etinger  
Martha Evans/Per Lohring  
Susan Ewer/Ron Black  
Bill Fagan/John Catherine  
McGowan  
Jessica Feder/Steinbaum  
Peter Jay Fernandez  
Ella Frost  
Frances Fugelman  
Aissa A. Fogel  
Tam Fontana/Sagan Lewis  
Janie Foreman/Castine Jaron  
Janet Frazier/Michael Geiger  
David Frenkel  
Shirley & Byron Frensdorff  
Lisa Frey/John McLaughlin  
Elizabeth Friedman  
Laurie P. Friedman  
Steven & Carol Gentina  
Mo Garney  
Judy Gattman  
Thomas L. Gatzert  
Joseph Gindera  
Jack Gilpin/Ann McDonough  
Avin Gattina  
Mrs. Ben P. Gostman  
Jury Gostman  
Bertrand Gostman  
Edward & Susan Goldstein  
Susan Goldstein  
Helen & Peter Goldstein  
Oscar Goodman  
Christopher Gould  
Patricia Graf  
Stephen Graham  
Rosalind Gray  
In honor of Cara Greene  
Susan Greenhill  
Baris Greenwald  
Celia Green/Frances Lubom  
Joe Grillo/Jane Ira Sellen  
Janet Grillo  
Lynne Gugenheim  
Albert R. Gurney  
Randy Hess  
Thomas Hellias  
Lynne Helliday  
Jonathan Hessel  
Mina Hammer/Tam Fleake  
Cari & Kathleen Hammer  
Zella B. Hammer  
Evan Handler  
Trisha Harger  
Raleigh Harst

Kamya Harding  
Gerard E. Harper  
Diane Harrell  
Jayne Hayes/John Patrick Sharkey  
Duncan Hazard  
Betty Hegeman  
Sarah Hershay  
Rob Hershman  
Cathy Hesse  
Chris Hill  
Jane Hoffman  
Billy Hopkins  
Irene Horowitz  
Thomas Hulce  
Lisa P. Hyde  
Amy Ingrassia/John Harry Davis  
Celia Irvine  
Rusty Magee  
Yves Andre Isard  
By Jacinta  
Claudine Johnson  
Cindy Lou Johnson  
Gregory R. Johnson  
Avin Peizer Johnson  
Elmer Jones  
Cheryl Jones  
Owen Kagan  
Hella Jung  
Lauren Kamens  
Michael Kani/Judith Rudnick  
Ira Karasik/Hana Jacobson  
Mark J. Kennedy  
Ken Kopylov/Sue Schapp  
Pam Kyprianou  
Rita Kras/Stephen Cohen  
Judy Kuhn  
Marco Jean Kurtz  
Leslie M. Kurtz  
Pamela Lach  
Bill Lambert  
Gina Landis  
Arthur E. Landi  
Susan A. Lange  
Jayne Lapan  
Jill Larson  
Kara Lear  
Jesse & Dana Lehman  
Jesse Jane Leigh  
Priscilla Lenas  
Georgetta & Morgan J. Levy  
Vivica Liebhart  
John Bedford Lloyd/Anne Tierney  
Lisa Losenans  
Mr. & Mrs. Stephen Lumb  
Chris & Betty Lutz  
John Lyons  
Greg MacPherson  
Baris Madoff/Peter DaCicco  
Michelle S. Magalone  
Cory Maloney/Helmas Maltes  
James Maloney  
Donald Margulies/Lynn Street  
Ann M. Martin  
Timothy Mason  
Peter Masterson  
Carmen Mathews  
Connie S. Mauro  
Jean McAllister  
Eliot M. McCabe  
Paul McCrone  
James McCrone  
John McDonough  
Frances McDermant  
Ann M. McGoldan  
Joanna Martin/David Dretzin

Charles M. Nelson  
Lauri Merrill/Hardy Raetz  
Ellie Shanon Miller  
Sewen Miles/Maria Winn  
David Mitch  
Sal Moroff  
Margaret S. Montgomery  
George G. Morfogen  
Celia Morgan  
Patricia Murphy  
Lia Barney Murphy  
Susan Murray  
John G. Nard  
Liz Neason  
Peter Neufeld  
Simon Robert Newey  
Peter Newman  
Carol Ochs  
Sarah Orinwald  
Henry D. Oelberg  
Marian Oleson  
Rosemary & Charles Palms  
John & Kristine Parusse  
F. Richard Pappas  
Ellen Parker/Mack Lipkin  
Mr. & Mrs. Robert Parker  
Mr. & Mrs. Barry Pearl  
Amanda Perkin  
Frances Peiper  
Quentin O'Brien  
Ira Karasik/Hana Jacobson  
Doris O'Hall  
Michael O'Hall  
Kevin O'Sullivan/Edith Thurber  
James L. Oakes  
Lynette Perry  
David Perkin  
Ruth Perkin  
Pamela P. Peters  
Nancy Pichione  
John Phelan/Heidi O'Brien  
Rabbi Prutz  
Kathleen T. Quira  
Shirley Reiser  
Neil Reud/Lisa DeLishe  
Tim & Tyson Ray  
Edward & Ingeborg Ray  
Edith Rea  
Paul Reiss  
Jacquelyn Reingold  
James Reisman  
Lincoln & Katherine Richardson  
Elizabeth Rigg  
Lilla Robertson  
Steven W. Rosker  
Gail Rogerson  
Bruce & Ellen Roseman  
Baris Rosenheck  
Gaylen Ross  
Mach Rossoff  
Andy Roth  
Alyssa Roth  
Martha Roth/Edi Irwin  
John Rothman  
Donald J. Rothchild  
Joyce Rudnick  
Paul Rudnick  
James Ryan  
Amy Sartz  
Robert Sater  
Larry & Deborah Schiff  
Lynn Schaeffer/Willem Lum  
Dan Schreier  
Sidney Schneidman  
Ken & Mary Ann Schuster  
Steve Scott  
Angela & John Schorner  
Julie Sebe  
Noriko Sengoku  
Susan Shacter  
Barry Shapiro

Murray Shapiro  
Ben & Ginny Siegel  
Judith Siegan  
Joey Silverman  
Mag Simon  
Jacqueline Simon  
Alicia Simpson  
Mr. & Mrs. George Shaskan  
Bernice Seruch Shaul  
Annette Shear  
Noah Shears  
Michael Shuler  
Wilma Shulman  
Sharon Shwartz  
Brian Shwartz/Patry Dryden  
Barry Singer  
Tom Singer  
Isadore & Judith Singer  
Lila Smith  
Sally Socoloff  
Susan Solomon  
Dale Soules  
Erica Spalman-Silverman  
Janine Spira, Jr.  
Florence Stanley/Martin Neeman  
Robert Steiner  
Jerry Steiner  
Byron Stevens/Helen Tigman  
yam K. Stevens, Sr.  
Tom & Maurine Stewart  
Joy Jents Stewart  
J. Frederick Stillman, III  
Catherine Stillman  
Jeff Sugarman  
Loren Sulven  
Andrew Sussel/Elise Taylor  
Daniel Swas  
Anne Swift  
Hiroko Tanaka  
Jay Taras  
Lynn T. Tiggart/Lary Anderson  
Michael Thomas  
Stanley & Gloria Thomas  
Jan Var Thomas  
Tracy Thomas  
Susan Ann Thomas  
Catherine C. Tracy  
Martin & Kathleen Treat  
Kathleen Turner  
Judith Tygerl  
Pamela Tyson  
Michael Urmank  
Laura Valerese  
Peter Valerese/Charles Goldberg  
Ida Valerese  
Angela & Patsy Varrakalis  
Israel & Miria Varga  
Antonia H. G. Vermaulen  
Scott Weiss  
Mary Pat Walsh  
Emma Wilson/Stephen Hamilton  
Kevin Wilson  
Mr. & Mrs. Charles G. Wood, III  
Bruce & Christine Wasserstein  
John Weidman/Lila Celestino  
Ira Weitzman  
Mitchell A. Weitzner  
Dorothy West  
Dawn Westbrook  
Rosalind Westbrook  
Is B. Wheeler  
Chris Whipple  
Mr. & Mrs. Robert White  
Max Will  
Peggy Williams  
David Winham  
Queen Winston  
Kathryn & Robert Wolfe  
Margaret L. Wolf  
Jean & Dutch Wolf  
Joanna Woodward  
Jeff & Janine Yass  
Peter Zapp  
Janet Zarish/Mark Gould  
Gail Zweigenthal

REPRODUCED BY J. A. BROWN



The 52nd Street Project Presents  
**THE FOOD CHAIN**  
The 1991 Block Island One-on-Ones  
August 1, 2, 3 & 4, 1991  
The Ensemble Studio Theatre - New York City

**Project Staff**

Willie Reale, Artistic Director  
Marsue Cumming, Executive Director  
Jenny Gersten, Production/Administrative Assistant  
Daniel Judah Sklar, Playmaking Director  
Michaela Murphy, Replay  
Larry Nathanson, Replay  
June Ballinger, Director - 52nd Street at Graham-Windham  
Susan Willerman, Instructor - 52nd Street at Graham-Windham

**Production Staff**

Henry Krieger, Music Director/Pianist	David Soo, Load-in
Kevin Joseph Roach, Set Designer	Jessica Bauman, Slide Operator
Greg MacPherson, Lighting Designer	Jodi SH. Doff, House Manager
Anne C. Patterson, Costume Designer	Sean Flynn, Running Crew
Jenny Peek, Stage Manager	Danny Noonan, Running Crew
Fran-Marie Fargardo, A.S.M.	Jean Bacharach, House Crew
Peter MacNicol, Dir/Dramaturg Assist	Kate Baggot, House Crew
Iris A. Brown, Graphics/Slides	Karin Barry, House Crew
Mina Hammer, Slides	Mindy Byer, House Crew
Kyle Wilton, Colorforms	Jeff Chrzczon, House Crew
Mindy Pfeffer, Props	Raquel Chung, House Crew
Jose Soto, Synthesizer	Greer Goodman, House Crew
Jason Brown, Light Board Operator	Julia Hoban, House Crew
Taro Alexander, Taped Sound	Alysia Reiner, House Crew
Katherine Lumb, Furniture	Angela Trento, House Crew

The 52nd Street Project is an independent, nonprofit organization that operates with the cooperation of The Ensemble Studio Theatre and the Police Athletic League. The Project brings inner-city children together with professional theatre artists to create theatre. This summer, our One-on-One program will take 20 kids away for one-week stays on Block Island and Cape Cod where they are matched with professional writer/actors who write plays for them to perform together.

**Board of Directors**

Ben Barenholtz	Heidi Landesman
Marsue Cumming	Frances McDormand
Wendy Ettinger, Chair	Carol Ochs
Stephen Graham	Willie Reale
Pamela Lack	Pamala Tyson
	Laura Valeroso

**Special Thanks To:**

Curt Dempster, Dominick Balletta and The Ensemble Studio Theatre; Keith, Lystra, Patty, Tito and the P.A.L., Lyn & Bob Reale; Bob & Linda Frumolt; Cindy & Tony Pappas; Frankie & Gordon Smith; Jennifer & Elliot Taubman; Dr. Christina Biaggi; The Maxmen's; Virginia Dare & Joya Verde; Martha MacDonald; Annie Reale; Pat McQuade; Jimmy Reale; Interstate Navigation Company; Prudie and Emily and The Ice Cream Place; The Boat Works; Block Island Times; Block Island Realty; Nat Habib and the Oceanwest Theatre; Block Island Medical Services; Hannelore, Dorian and Evan McDaniel; Hunter Tracy and Block Island Trucking; Darla, Bidy and Mudge; Greg MacPherson; Byam Stevens (Junior and Senior) and Peter Francis James; Neil Mazzella and Hudson Scenic; McQuades Marketplace; Waye; Julianne Bernstein and The Naked Angels; David Soo and Sam from Egypt!

**In-Kind Contributions:**

Police Athletic League; Ensemble Studio Theatre; Hudson Scenic Studios, Inc.; Colorforms; Bruce Cohen & Associates; Goldstein & Murphy; Sanford Goldstein; Bernhardt Fudyma Design Group; New York Mets; Consolidated Edison; Stephen Graham



Thank you for coming! If you are not on our mailing list (or if your address has changed), please fill out this form and give it to us on your way out, or mail it to the address below. We would also like to know if you would like to be of help to us in the future (primarily in the areas of fundraising, backstage and printing). If so, please fill out your name, phone number and areas of interest below.

**PLEASE ADD ME TO YOUR MAILING LIST:**

NAME \_\_\_\_\_

ADDRESS \_\_\_\_\_

\_\_\_\_\_ Zip \_\_\_\_\_

PHONE \_\_\_\_\_

**YES, I WOULD LIKE TO BE OF HELP:**

NAME \_\_\_\_\_

DAYTIME PHONE \_\_\_\_\_

AREA(S) OF INTEREST \_\_\_\_\_

\_\_\_\_\_

**ON SALE IN THE LOBBY !!!**

52nd Street Project T-Shirts with Shel Silverstein Logo: \$12.00

"Playmaking" by Daniel Judah Sklar: \$12.00

10th Anniversary Commemorative Poster by Iris A. Brown: \$10.00

Remember, one-half of sale price is tax-deductible!

If you would like to mail this (and you're always welcome to enclose a tax-deductible contribution), you can send it to: The 52nd Street Project, 552 West 52nd Street, New York, NY 10019 ■ (212) 245-1350.

**THE FOOD CHAIN**

1991 Block Island One-on-Ones

Ensemble Studio Theatre

August 1, 2, 3 & 4, 1991

All music composed by Henry Krieger

"The Food Chain Theme Song" - Company - Lyrics by Willie Reale

**CRUSTACEAN FRUSTRATION**

Written and directed by James McDaniel

Written for Elijah Barbosa, Age 9

Fred.....James McDaniel

Lobster.....Elijah Barbosa

"Walking The Lobster" - Lyrics by James McDaniel

**LOVE THAT PIG**

Written and directed by James Ryan

Written for Lori Quinones, Age 11

German Shepherd.....Lori Quinones

Pig.....James Ryan

Arnold.....James McDaniel/Willie Reale

"I Love That Pig" - Lyrics by James Ryan

**LINKAGE**

Written and directed by Bruce MacVittie

Written for Ronnie Noonan, Age 11

Protozoa.....Annette Myrie

Ronnie/The Missing Link.....Ronnie Noonan

Jim.....Bruce MacVittie

Mission Control.....Jeff Williams

"The Missing Link Lament" - Lyrics by Bruce MacVittie

**RICHER THAN MUD**

Written and directed by Roma Maffia

Written for Mary Vamvoukakis, Age 6

Marie.....Mary Vamvoukakis

Melissa.....Roma Maffia

"A Girl From Manhattan" and "Richer Than Mud" - Lyrics by Roma Maffia

**THE ANNETTE MYRIE SHOW**

Written by Wendy Wasserstein ■ Directed by Jeff Williams

Written for Annette Myrie, Age 8

Producer.....Willie Reale  
Announcer.....Bruce MacVittie  
The Annette Myrie Singers.....Henry Krieger, Bruce MacVittie,  
Ann Talman & Joe White

Annette.....Annette Myrie

Georgia Peach.....Jeff Williams

Vernon.....Jeff Williams

"The Annette Myrie Show Theme Song" and "Dancin' The  
Zucchini" - Lyrics by Wendy Wasserstein

-Intermission-

**MR. B.**

Written and directed by Richard Dresser

Written for Luis Santoni, Age 11

Mr. B.....Luis Santoni

Nurse Hartley.....Ann Talman

"Time To Grow" - Lyrics by Richard Dresser

**SNOWFLAKES**

Written and directed by Fracaswell Hyman

Written for Evelyn Maldonado, Age 9

Girl.....Evelyn Maldonado

Man.....Fracaswell Hyman

Woman.....Roma Maffia

"I Got It Goin' On" - Lyrics by Fracaswell Hyman

**FAST FOOD FAIRY TALE**

Written and directed by Joe White

Written for Yolanda Maldonado, Age 12

Narrator.....Joe White

Princess.....Yolanda Maldonado

Cableman.....Joe White

Chutney.....Joe White

"A Fine How Do You Do" - Lyrics by Willie Reale

**DYING AMONG OTHER THINGS**

Written and directed by Willie Reale

Written for Jill Barbosa, Age 10

Jill.....Jill Barbosa

Ted.....Willie Reale

"The Epiglottis Song" & "Song Once Sung" - Lyrics by Willie Reale  
(surprise cameo appearances by Project staff)

**VICTOR AND SPALDING**

Written and directed by Spalding Gray

Written for Victor Rojas, Age 11

Victor.....Victor Rojas

Spalding.....Spalding Gray

"It's A Munching, Munching World" - Lyrics by Spalding Gray

The 52nd Street Project gratefully acknowledges the support of the following foundations, corporations, government agencies and individuals: Altman Foundation, The Robert Bowne Foundation, Citibank, The Liz Claiborne Foundation, Consolidated Edison, Nathan Cummings Foundation, D-B Trust, Department of Cultural Affairs, Educational Foundation of America, The William and Mary Greve Foundation, The Kids Fund, The Eugene and Rose Kleiner Family Foundation, The Marquis George MacDonald Foundation, The James Macdonald Foundation, Morgan Guaranty, Morgan Stanley and Company, New York State Council on the Arts, The Samuel and May Rudin Foundation, The Fan Fox and Leslie R. Samuels Foundation, The Threshold Foundation and

The 52nd Street Project  
at Graham-Windham  
presents

# STRANGERS

- |                                  |                                     |                                  |                                |                                 |
|----------------------------------|-------------------------------------|----------------------------------|--------------------------------|---------------------------------|
| Polly Adams/John Klauz           | Richard J. Cole                     | Kamryn Harding                   | Charles M. Nelson              | Murray Shapiro                  |
| William R. Adams/Doranne Neagles | The Cooper Committee                | David E. Hense                   | Laurel Maxwell/Larry Haas      | Ben & Giny Segal                |
| DeB Adams                        | George Corbin, Jr.                  | Dana Haskel                      | Elio Bronson Miller            | Joel Siegan                     |
| Mr. & Mrs. Addison               | Eileen Crowl                        | Jayne Hayes/John Patrick Sharkey | Steve Miller/Maria Wynn        | Joey Sherman                    |
| Nancy Addison/Clayton Lewis      | Janet Crawford                      | Duncan Hazzard                   | Sal Moritt                     | Mag Simon                       |
| Diane Ales                       | Eda Cucco                           | Betty Hegeman                    | Margaret B. Montgomery         | Jacqueline Simon                |
| Lynette E. Altan                 | Nail Curbish/Wendy Decker           | Sarah Hershey                    | George S. Morligan             | Ann Sponen                      |
| Angie Anne Aronson               | Arthur Darrich                      | Cathy Herstein                   | Cara Morgan                    | Mr. & Mrs. George Stokan        |
| Avin Art/Mary Macchiaroli        | Carly Demetri                       | Richard Hicks                    | Patricia Murphy                | Bernice Beruch Street           |
| Ulrica Ahlstrom                  | Maria Deinger                       | Chris Hill                       | Lisa Stanley Murphy            | Annelle Stear                   |
| Margot Avery                     | Cynthia Dinko                       | Jane Hoffman                     | Susan Murray                   | Nicole Swans                    |
| Tony Ayward                      | Leslee Diet                         | Elly Hopkins                     | John G. Harst                  | Michael Swisher                 |
| Jean Bacharach                   | Dan David/Linda Skyles              | Karen Horvath                    | Liz Nelson                     | Wanda Strickman                 |
| Anna Daisy/Charles Wright        | Robert de Rottschid                 | Thomas Huxel                     | Peter Nuckel                   | Sharon Strath                   |
| Janine Baker                     | Carole & Bob F. Deakin              | Lisa P. Hyde                     | Simon Robert Newey             | Brian Stover/Patty Dwyer        |
| Deborah Baker                    | Catherine Grace Dent                | Carla Irvine                     | Peter Newman                   | Berry Singer                    |
| Wendy Baker                      | Margie & Vincent Deprat             | Flurry Magee                     | Carol Ochs                     | Tom Singer                      |
| Dominick Baker/Tatiana Weiss     | Jodi S.L. Dell                      | Yves Andre Isal                  | Sarah Ochsweil                 | Isabelle & Judith Singer        |
| Michael Bender                   | Jacqueline Denegan                  | Sylvia Jacobs                    | Henry D. Oelberg               | Lois Smith                      |
| Cathy Benavich                   | Fairy Draper                        | Candice Johnson                  | Miriam Ochoa                   | Sally Socolow                   |
| Ben Beneshild                    | Mona Driscoll                       | Cony Lou Johnson                 | Rosemary & Charles Paine       | Susan Solomon                   |
| Miranda Berry                    | Charles & Josephine Dumas           | Gregory R. Johnson               | John & Kristine Pankos         | Dale Soules                     |
| Gary Bertin                      | Marl Eckstein                       | Avril Peter Johnson              | F. Richard Pappas              | Erica Spelman-Sheeman           |
| Jo Basine                        | Joanna Edgar                        | Ellen Jones                      | Evan Parker/Mack Lipkin        | Janine Spira, Jr.               |
| Christopher Beach                | Neil Eisenberg                      | Cherry James                     | Mr. & Mrs. Robert Parker       | Flavone Stacey/Martin Neeman    |
| Judy Messy Decker                | Elliot & Henner                     | Bob Jay                          | Alexandra Paston               | Robert Steiner                  |
| Terry Belanger                   | Owen Eliason                        | Helle Jager                      | Frances Peiper                 | Jerry Steiner                   |
| Water Allen Bennett, Jr.         | Beth A. Emanson                     | Lauren Kamara                    | Quinn O'Brien                  | Bryan Stevens/Robert Tighman    |
| Emily Bertoni                    | Dana Emmons                         | John P. Engel                    | David Perkin                   | Jan K. Stevens, Sr.             |
| Christina Bess                   | Wendy Edinger                       | Maureen Evans/Her Lohring        | Doris O'Hell                   | Tom & Laureen Stewart           |
| Julie Messy Decker               | Susan Ewert/Don Black               | Pat Kappaman                     | Kevin O'Hara/Edith Thurber     | Joey Stewart                    |
| Terry Belanger                   | DI Fagnat/Anna Catherine McCannahan | Judy Kohn                        | James L. Oakes                 | J. Frederick Stillman, III      |
| Water Allen Bennett, Jr.         | Jessica Feder-Embaum                | Henry Jean Kurtz                 | Lynette Perry                  | Catherine Stumbe                |
| Emily Bertoni                    | Elise Frey                          | Laurel M. Kert                   | David Perkin                   | Jeff Sugerman                   |
| Mr. & Mrs. N. Bertoni            | Shane Fagelman                      | Famecia Lack                     | Ruth Perkin                    | Andrew Sullivan                 |
| Andrew Bendiger                  | Ann A. Fogel                        | Anna Lande                       | Thomas P. Peck                 | Daniel Suss                     |
| Caroline Bagel                   | John Fontana/Caroline Leiner        | Susan A. Lange                   | Nancy Picoone                  | Anne Swift                      |
| Pat & Howard Baris               | Jane Foster/Robert Geiger           | David Frank                      | John Palmetto/Theresa O'Brien  | Erica Tanaka                    |
| Amy Brinbaum                     | Dore & Robert Frenkel/Elizabeth     | John Larson                      | Rob Pruitt                     | Jay Taras                       |
| Honora Brinbaum                  | Lisa Frey/John McLaughlin           | Kate Lee                         | Kathleen T. Quirk              | Lynn T. Tigani/Larry Anson      |
| Andre Barbas                     | Elizabeth Friedman                  | Jose & Dana Lehman               | Shirley Rowe                   | Michael Thomas                  |
| Mr. & Mrs. G. Branger            | Laura P. Friedman                   | Sara Jane Leigh                  | Neo Rauber/Lisa Bekheze        | Jean Val Thome                  |
| Arlean M. Brin                   | Steven & Carol Gendino              | Priscilla Lewis                  | Tim & Tyson Ray                | Tracy Thome                     |
| Kristina Brinovic                | Mike Garay                          | George & Morgan J. Levy          | Edith Rea                      | Susan Ann Thomson               |
| Rhea Brannon/Thane Garcia        | In honor of Suzanne Gates           | Wook Listhart                    | Paul Reiss                     | Catherine C. Tracy              |
| William L. Brinner               | Thomas L. Galarita                  | John Bedford Lloyd/Anne Twomey   | Jacquelyn Ringold              | Michael Tread                   |
| Bob Brescia                      | Joseph Gardine                      | Lisa Lovemore                    | James Rivison                  | John Tupper                     |
| Fran Brill                       | Jack Gilpin/Ann McDonough           | Clyde & Sally Lutz               | Lincoln & Katherine Richardson | Pamela Tyson                    |
| Rita & Fred Brooks               | Avril Gottlieb                      | John Lyons                       | Elizabeth Rog                  | Michael Urbank                  |
| Eric Brooks                      | Mrs. Ben P. Gostman                 | Greg MacPherson                  | Little Robertson               | Laura Valente                   |
| Becky Broaden/Ted Neuzadt        | Julie Goodman                       | Roma McArthur DeGane             | Steven W. Froscher             | Paul Valente/Charles Goldberg   |
| Karen Brown                      | Sanford Goldstein                   | Carole S. Magistrate             | Gus Rogerson                   | Isa Veldner                     |
| Garet M. Brown                   | Edward & Susan Goldstein            | Carole Maloney/James Malas       | Bruce & Ellen Roseman          | Angie & Patty Varnouk           |
| Deborah Brown                    | Susan Goldstein                     | James Maloney                    | Bera Rosebeck                  | Israel & Mira Vargas            |
| Philip J. Brown                  | Heven & Peter Goldstein             | David Margolis/Lynn Street       | Gaylen Rose                    | Scott Weiss                     |
| David Bustin                     | Greg Goodman                        | Ann M. Martin                    | Mack Rossitt                   | May Pat Weis                    |
| Marshall Butt                    | Christopher Gould                   | Peter Masterson                  | Andy Roth                      | Erica Weiss/Stephen Hamilton    |
| Mindy Dyer                       | Patricia Graf                       | Carole McInnes                   | Arnie Roth                     | Kevin Ward                      |
| Steven Callahan/Christine Dunn   | Ronald Gray                         | Corrie S. Meurs                  | Maria Roth/Ed Irwin            | Mr. & Mrs. Charles G. Ward, III |
| Anna Carney                      | In honor of Cole Greene             | Susan Greenfield                 | John Rothman                   | Bruce & Christine Wasserman     |
| Alex Carter                      | Paul Greenwood                      | Carin Green/Janice LaBare        | Donna J. Rothchild             | John Weidman/Lisa Celestino     |
| Susan Carter                     | Sara Greenwood                      | Janet Griffin/Jane Pa Bloom      | Joey Rudnick                   | Isa Weidman                     |
| Anna Catalano                    | James Gritz                         | Lynne Gugenheim                  | Paul Rudnick                   | Michael A. Weitzner             |
| Laura Maria Cerasola             | Lynne Gurney                        | Randy Hase                       | James Ryan                     | Betty West                      |
| Clare L. Chales                  | Thomas Helkiss                      | Thomas Helkiss                   | Ann M. McCabe                  | David Westbrook                 |
| Cheryl Chalmers                  | Lynne Haidley                       | Jonathan Hamer                   | Paul McCrone                   | Ir. B. Wheeler                  |
| Richard Chantel                  | Jonathan Hamer                      | Mina Hammer/Tom Heale            | John McDonough                 | Chris Whipple                   |
| Jill & Don Chastain              | Carl & Kathleen Hammer              | Carl & Kathleen Hammer           | Frankie McDonough              | Mr. & Mrs. Robert White         |
| Elan Chonoweth                   | Zela B. Hammer                      | Evan Handler                     | Sonny Medvedman                | Max Wolf                        |
| Michael & Pamela Cheppa          | Trish Hanger                        | Raechel Harts                    | Kath & Mary Ann Schuster       | Peggy Williams                  |
| Louis Chiffarano                 | Raechel Harts                       |                                  | Sarah Scott                    | Donald Windham                  |
| Peter Chigantopoulos             |                                     |                                  | Angie & John Schmitt           | Gwen Winston                    |
| Reuter Chung                     |                                     |                                  | Alicia Sebba                   | Kathryn & Robert                |
| Ben & Mary Crane                 |                                     |                                  | Noriko Sengoku                 | Margaret L. Wolf                |
| Charles Ray Cochrane             |                                     |                                  | Susan Shcher                   | Jean & Dutch Wolf               |
| Ruth Conan                       |                                     |                                  | Berry Shapiro                  | Jeanne Woodward                 |



57062015

Graham-Windham and The 52nd Street Project present

## STRANGERS

Playmaking at Graham-Windham

August 17 & 18, 1991

Ensemble Studio Theatre - New York City

### Project Staff

Willie Reale, Artistic Director

Marsue Cumming, Executive Director

Daniel Judah Sklar, Playmaking Director

June Ballinger, Director - 52nd Street at Graham-Windham

Susan Willerman, Instructor - 52nd Street at Graham-Windham

Jenny Gersten, Production/Administrative Assistant

### Production Staff

Dale Shields, Stage Manager

Richard Ford, ASM

Kathrine Guillaud, costumes, slides  
and colorform designer - adapted  
from drawings by Graham-Windham  
kids

Michael Rose, props

Stian Nelson, light board operator

Iris Brown, additional slides

Willie Melia, slides operator

Dana McCoy, synthesizer

Jimmy Martinez, program and flyer  
design

Donald Williams, sound

Hope Weiner, House Manager

Tyhisia Cobb, running crew

Tomicka Williams, running crew

Celina Raspberry, running crew

Shawndale Davis, running crew

Basil Boatwright, running crew

Lenny Yearwood, running crew

Ann Kahn, front of house

Omar Rose, house crew

Ronnie Noonan, house crew

Danny Noonan, house crew

Luis Santoni, house crew

#### GRAHAM-WINDHAM

Suzanne F. Bales, Chair of the Board

Joyce S. Lapenn, President and CEO

Lonnie Stafford, Vice President,  
Residential Treatment Center

Jennie Brown, Director,  
Residential Treatment Center

Taaliba Muhammad, Recreation Coordinator

Winston Thompson, Child Care Worker

Yolanda Salmon, Child Care Worker

**The 52nd Street Project at Graham-Windham** brings together together kids at Graham-Windham with professional theatre artists to create theatre. In Playmaking, the students were taught the essentials of playwriting in eight classroom sessions, and then wrote their own play with the support of an adult theatre professional during a weekend retreat in Tannersville, NY. **The 52nd Street Project** is an independent, nonprofit organization that operates with the cooperation of The Ensemble Studio Theatre and the Police Athletic League. **Graham-Windham**, founded in 1806, annually serves more than 6,000 children from families throughout the New York area. Its services include foster care and adoption; group homes and residential treatment for abused, neglected and emotionally disturbed children.

### The 52nd Street Project Board of Directors

Ben Barenholtz

Marsue Cumming

Wendy Ettinger, Chair

Stephen Graham

Amela Lack

Heidi Landesman

Frances McDormand

Carol Ochs

Wille Reale

Pamala Tyson

Laura Valeroso

### Special Thanks To:

Curt Dempster, Dominick Balletta and the Ensemble Studio Theatre, Kirsten Sanderson, Meg Scott, Bernard, Emily, Mary, and the Tannersville summer conference staff, Dr. Jennie Brown, Joyce Lapenn, William Hamer, Taaliba Muhammed, Winston Thompson, Yolanda Salmon, and all of the Graham-Windham staff, Sharon Stone, Angelique Leone, Brenda Schaeffer, Michael Goldstein, Jan Dorn, Mina Hammer, Judy Tate, Jeff Lee, Kiki Ingenthron, Yolanda Snowball, Iona Morris, Demetri Corbin, Julie Boyd, Cecila Arana, Peggy Vernieu, Willie, Marsue, Jenny, and the PAL staff

### In-Kind Contributions:

Police Athletic League; Ensemble Studio Theatre; Hudson Scenic Studios, Inc.; Orforms; Bruce Cohen & Associates; Goldstein & Murphy; Sanford Goldstein; Bernhardt Fudyma Design Group, New York Mts; Consolidated Edison; Stephen Graham

Thank you for coming! If you are not on our mailing list (or if your address has changed), please fill out this form and give it to us on your way out, or mail it to the address below. We would also like to know if you would like to be of help to us in the future (primarily in the areas of fundraising, printing, video dubbing and backstage). If so, please fill out your name, phone number and area(s) of interest below.

PLEASE ADD ME TO YOUR MAILING LIST:

Name \_\_\_\_\_

Address \_\_\_\_\_

\_\_\_\_\_ Zip \_\_\_\_\_

Phone \_\_\_\_\_

YES, I WOULD LIKE TO BE OF HELP:

Name \_\_\_\_\_

Daytime Phone \_\_\_\_\_

Area(s) of Interest \_\_\_\_\_

I would be interested in being a crew head for your next production \_\_\_\_\_

If you would like to mail this, and/or a donation, you may do so to: The 52nd Street Project, 552 West 52nd St., New York, NY 10019 (212) 245-1350.

We have a brand new batch of 52nd Street Project T-Shirts (with the Shel Silverstein logo) on sale in the lobby for \$12.00. Half of this is tax-deductible. Colors include Black, Red, Fuschia, Jade, Grey and a limited number of Gold, Green and White. Great Gift Idea!

## STRANGERS

Playmaking at Graham-Windham

August 17 & 18, 1991

Ensemble Studio Theatre - New York City

*BEARLY FRIENDS* by Jimmy Martinez

Dramaturg/director: Demitri Corbin

Narrator.....Demitri Corbin

Frankie/Hank.....Stephen Singer

Joey/Dick.....Chuck Cooper

*THE CONCEITED, THE MEAN, AND THE ONE THAT COULDN'T MIND HER BUSINESS* by Corrine Hawkins

Dramaturg/director: Kiki Ingenthron

Rose.....Sharon Lehner

Joyce.....Yolanda Snowball

Myr.....Rosalyn Coleman

*THE DOLPHIN AND THE BIRD* by Claudette Star Rowe

Dramaturg/director: Kirsten Sanderson

Bird.....Margaret Pazant

Dolphin.....Alice King

*DANGER ZONE* by Ronald Wilder

Dramaturg/director: Jeff Lee

Brad.....Andrew VanDusen

Paula the Bird.....Cecilia Arana

*PARTY CRAZY* by Shawndale Ziegler

Dramaturg/director: Murphy Guyer

S/P.....Demitri Corbin

Q.....Jan Dorn

*SMELLS OF THE WORST* by Ayda Palomino

Dramaturg/director: Emily Rubin

Ms. Jinkings.....Rosalyn Coleman

Anny the Onion.....Rebecca Nelson

Reffry the Refridgerator.....Peter Jay Fernandez

*THE ADVENTURES OF BILL AND SWEET CHUCK* by Shawn Sinceno

Dramaturg/director: Tom Singer

Sweet Chuck.....Julie Boyd

Bill.....Leon Addison Brown

*WATER BUGS* by Danita Fisher

Dramaturg/director: Martin Epstein

Maria.....Rondi Miller

Crystal.....Rosalyn Coleman

Corl.....Peter Francis James

*THE CHANGE* by Lawrence Carrol

Dramaturg/director: Susan Willerman

Mrs. Ruffin/Wendy.....Judy Tate

Bill.....Arthur French

*BIRTHDAY SURPRISE* by Lakesha Bey

Dramaturg/director: Phil Bosakowski

Gaiea/Woman.....Greer Allison

Arlene.....Belinda Hardin

Dad.....Jeff Lee

Mom.....June Ballinger

The 52nd Street Project gratefully acknowledges the support of the following foundations, corporations, government agencies and individuals: Altman Foundation, The Robert Bowne Foundation, Citibank, The Liz Claiborne Foundation, Consolidated Edison, Nathan Cummings Foundation, D-B Trust, Department of Cultural Affairs, Educational Foundation of America, The William and Mary Greve Foundation, The Kids Fund, The Eugene and Rose Kleiner Family Foundation, The Marquis George MacDonald Foundation, The James Macdonald Foundation, Morgan Guaranty, Morgan Stanley and Company, New York State Council on the Arts, The Samuel and May Rudin Foundation, The Fan Fox and Leslie R. Samuels Foundation, The Thresh

Polly Adams/John Klaus  
William R. Asensio/Jeanne Neagles  
Beth Adams  
Mr. & Mrs. Addison  
Nancy Addison/Clayton Lewis  
Diana Aoss  
Lynette E. Aison  
Jane Anne Anderson  
Ron Artick/Key Macchulisti  
Linda Aikman  
Margot Avery  
Tary Aysard  
Jean Becherach  
Anne Baley/Charles Wright  
Jayne Baley  
Deborah Baser  
Wendy Baser  
Dominick Baketa/Nena Weiss  
Michael Bender  
Cathy Benavich  
Ben Benavitz  
Miranda Berry  
Gary Barton  
Jo Barise  
Christopher Beach  
Judy Massey Becker  
Terry Belange  
Walter Allen Bennett, Jr.  
Emily Bertan  
Mr. & Mrs. H. Bertan  
Andrea Benzinger  
Corinne Berger  
Pat & Howard Berke  
Amy Berman  
Romina Berman  
Andre Bishop  
Mr. & Mrs. G. Bissinger  
Kristina Borovick  
Rita Branson/Rene Garcia  
William L. Bremer  
Bob Briscoe  
Fran Brill  
Rita & Fred Briscoe  
Eric Briscoe  
Becky Brewster/Ted Neusselt  
Karen Brown  
Garret M. Brown  
Deborah Brown  
Philip J. Brown  
David Buzan  
Marshall Butt  
Mindy Byer  
Cafe Film Center  
Steven Calisher/Christine Durr  
Anne Carney  
Alan Carter  
Susan Carter  
Anne Cattaneo  
Laura Mena Castaneda  
Claire L. Chelso  
Cheryl Chalmers  
Rachel Chanoff  
Jill & Dan Chastain  
Ellen Chelso  
Michael & Pamela Cherpig  
Louis Chiffarone  
Peter Chisante/paula  
Raquel Chung  
Ben & Mary Cline  
Charles Fly Cochran  
Ruth Cohen

Richard J. Cohn  
The Cooper Committee  
George Corrin, Jr.  
Eileen Cowie  
Janet Crawford  
Eda Cusick  
Neil Cutcher/Wendy Dastel  
Arthur Demich  
Cathy Dentrick  
Mara Derygki  
Cynthia Deyce  
Lakes Dart  
Dana Davach/Henry Szytko  
Robert de Rothschild  
Carol & Boon Desaine  
Catherine Grace Dent  
Margie & Vincent Deprez  
Judi SH. Dell  
Jacqueline Denagen  
Polly Draper  
Mara Driscoll  
William Duff Griffin  
Charles & Jeannine Dumas  
Muri Edwards  
Joanne Edger  
Neil Eisenberg  
Elkott & Hammer  
Owen Etkan  
Barth A. Etkan  
Dana Emmons  
John P. Engel  
Wendy Ettinger  
Marina Evans/Per Lohring  
Susan Ewen/Ron Black  
Bill Fogelstein/Catherine  
McCarran  
Jessica Feder-Brimbaum  
Peter Jay Fernandez  
Ella First  
Rhea Fingeman  
Auss A. Figli  
Tom Fisman/Dagan Lewis  
Janis Foreman/Candice Aaron  
Janet Foster/Michael Geiger  
David Frank  
Bruno & Raelyn Fraudenthal  
Lisa Frey/John McLaughlin  
Eliash Friedman  
Luigi P. Friedman  
Steven & Carol Gombino  
Mc Garay  
In honor of Flazanna Gates  
Thomas L. Gaziano  
Joseph Gendine  
Jack Golan/Ann McDonough  
Avin Goldfine  
Mrs. Ben P. Gostman  
Judy Goodman  
Berford Golden  
Edwess & Susan Goldstein  
Susan Goldway  
Helen & Peter Goldstein  
Gear Goodman  
Christopher Gaud  
Patricia Graf  
Stephen Graham  
Ressard Gray  
In honor of Cara Greens  
Susan Gwerthil  
Sara Greenwood  
Colin Gray/Francois Laflere  
Jae Gruber/Jane Iris Bloom  
Janet Griss  
Lynne Guggerman  
Albert R. Gurney  
Randy Hale  
Thomas Hakkaas  
Lynne Haliczay  
Jonathan Harne  
Mina Hammer/Tim Reese  
Carl & Kathleen Hammer  
Zella B. Hammer  
Evan Harber  
Trene Hanger  
Reagh Hans

Kamya Harding  
Gerard E. Harper  
Dana Hassel  
Jayne Hayes/John Patrick Shanley  
Duncan Hazard  
Betty Hegeman  
Sarah Harshay  
Rao Harsham  
Richard Hicks  
Chris Hill  
Jane Hoffman  
Billy Hopkins  
Irwin Horowitz  
Thomas Hulse  
Lisa P. Hyde  
Amy Inghos/John Henry Davis  
Cora Irvine  
Rusty Magee  
Yves-Anne Israel  
By Jacobs  
Claudine Jackson  
Cindy Lou Johnson  
Gregory H. Johnson  
Awen Pevler Johnson  
Elmer Jones  
Cherry Jones  
Bob Jay  
Helle Juloff  
Lauren Kaine  
Michael Kane/Judith Rudnick  
Ira Karasick/Rene Jacobson  
Men J. Kennedy  
Ken Kety/Avan Schapp  
Pam Kipperman  
Lisa Kras/Sophen Cohen  
Judy Kuhn  
Marcia Jean Kurtz  
Lara M. Kari  
Pamela Lack  
Bill Lambert  
Gene Landis  
Arthur E. Landt  
Susan A. Lange  
Joyce Laperre  
Jill Larson  
Kate Law  
Jesse & Dana Lehman  
Sara Jane Leigh  
Christie Lane  
Georgina & Margen J. Levy  
Vivian Liebman  
John Bedford Lloyd/Anne Teremy  
Lisa Lowmense  
Mr. & Mrs. Stephen Lumb  
Chris & Billy Lutz  
John Lyons  
Greg MacPherson  
Rama Maita/Peter DeCorte  
Michael S. Maguire  
Carry Maloney/Helma Malas  
James Maloney  
Donald Margules/Lynn Street  
Ann M. Martin  
Timothy Mason  
Peter Masterson  
Carmen Matthews  
Corrie S. Maure  
Joan McAlester  
Doris M. McCabe  
Paul McCrone  
James McCrone  
John McDonough  
Frances McDermid  
Ann M. McGeehan  
Joanna Martin/David Drezon

Charles M. Nelson  
Laure Messinger/Henry Reese  
Ellen Mezon Miller  
Steven Miller/Maria Wynn  
David Mich  
Sai Morrett  
Margaret B. Montgomery  
George S. Morfogen  
Cass Morgan  
Mara Murphy  
Jane Murphy  
Susan Murray  
John G. Nard  
Liz Nealon  
Peter Neale  
Simon Robert Newey  
Pearl Newman  
Carol Ochs  
Sarah Olmstead  
Henry D. Olsberg  
Miriam Olov  
Rosemary & Charles Palms  
John & Kristina Parkow  
F. Richard Pappas  
Ellen Parker/Mack Lipin  
Mr. & Mrs. Robert Parker  
Bob Jay  
Alessandra Parton  
Lauren Pease  
Quentin O'Brien  
Peter O'Brien  
Doris O'Neil  
Michael O'Neill  
Kevin O'Rourke/Edith Thurber  
James L. O'Neil  
Lynette Perry  
David Petelin  
Ruth Petelin  
Thomas P. Peters  
Nancy Pizzano  
John Pizzano/Helena O'Brien  
Rosh Pruitt  
Kathleen T. Quinn  
Shirley Reiner  
Nob Rauch/Lisa Beiswae  
Tim & Tyeen Ray  
Edward & Ingrid Ray  
Edith Rae  
Paul Reale  
Jacquelyn Reingast  
James Reison  
Lincoln & Katherine Richardson  
Elizabeth Rigg  
Lisa Roseman  
Steven W. Roisher  
Gus Rogerson  
Bruce & Ellen Roseman  
Sara Rosenheck  
Gaylen Ross  
Mick Rosoff  
Andy Roth  
Alyssa Roth  
Martha Roth/Edith Irwin  
John Rozman  
Donald J. Rochechic  
Joyce Rudnick  
Paul Rucke  
James Ryan  
Amy Seltz  
Steven Sezar  
James McCrone  
Lynn Schiesinger/Willem Lun  
Fran Schreier  
Soney Schreierman  
Ken & Mary Ann Schuster  
Saret Scott  
Angela & John Schmandt  
Julie Sebo  
Nevine Sengoku  
Jan & Dutch Wolf  
Barry Shapiro

Murray Shapiro  
Ben & Ginny Siegel  
Judith Sigman  
Joey Silverman  
Meg Simon  
Jacqueline Simon  
Alice Simpson  
Mr. & Mrs. George Shaskan  
Bernice Baruch Shast  
Annette Shier  
Nicola Shiers  
Michael Shieder  
Wima Shifman  
Sharon Shifman  
Brian Shoen/Patry Dryden  
Barry Singer  
Tom Singer  
Isaacov & Judith Singer  
Lila Smith  
Sally Soxwell  
Susan Solomon  
Dore Soxwell  
Erica Spelman-Silverman  
Jerome Spink, Jr.  
Florence Stanley/Martin Neeman  
Robert Stecker  
Jerry Steiner  
Byron Stevens/Robin Tigrman  
yann K. Stewart, Sr.  
Tom & Maureen Stewart  
Jay Jarvis Stewart  
Doris O'Neil  
Catherine Stronbos  
Jeff Sugarman  
Loren Sullivan  
Andrew Sweet/Eli  
Daniel Sweet  
Anne Swift  
Hiroo Tanaka  
Jay Taras  
Lynn T. Thigpen/Larry Aronson  
Michael Thomas  
Stanley & Gloria Thomas  
Joan Vail Thorne  
Tracy Thorne  
Susan Ann Thornton  
Catherine C. Tracy  
Marn & Kathleen Treat  
Kathleen Turner  
Judith Tyger  
Pamela Tyson  
Michael Untrach  
Laura Valeros  
Peter Valeros/Charles Goldberg  
Jos Valeros  
Angelo & Patsy Vamvakakis  
Israel & Mira Vargas  
Antonie H. G. Vermeulen  
Scott Weiss  
Mary Pat Weish  
Emma Wilson/Stephen Hamilton  
Kevin Ward  
Mr. & Mrs. Charles G. Ward, III  
Bruce & Christian Wasserstein  
John Weidman/Lisa Costburn  
Iris Weisman  
Michael A. Weizner  
Betty West  
Dawn Westbrook  
Roland Westbrook  
Iris B. Whipple  
Chris Whipple  
Mr. & Mrs. Robert Wasser  
Max Wils  
Peggy Williams  
Donald Winshan  
Owen Winson  
Kathryn & Robert W.  
Margaret L. Wolf  
Susan & Dutch Wolf  
Joanne Woodward  
Jeff & Jennie Yass  
Peter Zapp  
Janet Zarah/Mark Gault  
Gail Zweigenthal



THE 52ND STREET PROJECT  
PRESENTS THE  
1991 ONE-ON-ONES

# THE FOOD CHAIN

ILLUSTRATION BY M. A. BROWN

The 52nd Street Project Presents  
**THE FOOD CHAIN**  
The 1991 Cape Cod One-on-Ones  
August 27, 28, 29, 30, 1991  
The Ensemble Studio Theatre - New York City

### Project Staff

Willie Reale, Artistic Director  
Marsue Cumming, Executive Director  
Jenny Gersten, Very Useful Production/Administrative Assistant  
Daniel Judah Sklar, Playmaking Director  
Michaela Murphy, Replay  
Larry Nathanson, Replay  
June Ballinger, Director - 52nd Street at Graham-Windham  
Susan Willerman, Instructor - 52nd Street at Graham-Windham

### Production Staff

Rob Reale, Music Director  
Kevin Joseph Roach, Set Designer  
Greg MacPherson, Lighting Designer  
Kym Michaud, Costume Designer  
Katherine Lumb, Stage Manager  
Tim Ray, Pianist/Synthesizer  
Iris A. Brown, Graphics/Slides  
Mina Hammer, Slides  
Catou Gillaud, Colorforms  
Susan Shacter, Props  
Tracy Knights, Light Board Operator  
Shane Tillston, Lights  
Sean Flynn, Furniture  
Taro Alexander, Slide Operator  
Allison Michaud, Asst. Costumer

David Soo, Load-in  
Waldo Ford, Load-out  
Jodi SH. Doff, House Manager  
Karin Barry, Running Crew  
Danny Noonan, Running Crew  
Angela Trento, Running Crew  
Jean Bacharach, House Crew  
Jeff Chrzczon, House Crew  
Ann Kahn, House Crew  
Gabrielle Snannon, House Crew  
Nicole Sheara, House Crew  
Susan Vitucci, House Crew  
Dennis Tolentino, Indispensable I  
Jose Soto, Indispensable II

The 52nd Street Project is an independent, nonprofit organization that operates with the cooperation of The Ensemble Studio Theatre and the Police Athletic League. The Project brings inner-city children together with professional theatre artists to create theatre. This summer, our One-on-One program will take 20 kids away for one-week stays on Block Island and Cape Cod where they are matched with professional writer/actors who write plays for them to perform together.

### Board of Directors

Ben Barenholtz  
Marsue Cumming  
Wendy Ettinger, Chair  
Stephen Graham  
Pamela Lack

Heidi Landesman  
Frances McDormand  
Carol Ochs  
Willie Reale  
Pamala Tyson  
Laura Valeroso

### Special Thanks To:

Curt Dempster, Dominick Balletta and The Ensemble Studio Theatre; Keith, Lystra, Patty, Tito and the P.A.L., Lyn & Bob Reale; Bob & Linda Frumolt; Cindy & Tony Pappas; Frankie & Gordon Smith; Jennifer & Elliot Taubman; Dr. Christina Biaggi; The Maxmen's; Virginia Dare & Joya Verde; Martha MacDonald; Annie Reale; Pat McQuade; Jimmy Reale; Interstate Navigation Company; Prudie and Emily and The Ice Cream Place; The Boat Works; Block Island Times; Block Island Realty; Nat Habib and the Oceanwest Theatre; Block Island Medical Services; Hannelore, Dorian and E. McDaniel; Hunter Tracy and Block Island Trucking; Darla, Bidy and Mudge; Greg MacPherson; Byam Stevens (Junior and Senior) and Peter Francis James; Neil Mazzella and Hudson Scenic; McQuades Marketplace; Wayne; Julianne Bernstein and The Naked Angels; David Soo; Sam from Egypt; The Randolph Family; Our chef's on Cape Cod: Karin Barry & Carol Ochs; Robin at Hansl and Gretel; The Ultimate Style Salon; Browne's Liquor (for xeroxing, honestly); Cape Cod Potato Chips; Purity Supermarket; Bob Krystofolski; Ann & Judy at the Wareham High School; David Margulies & Phyllis Somerville; The Bucket Brigade; Mary Kane; Leon Addison Brown; Ned Eisenberg; Ted Neustadt and Hurricane Bob!

### In-Kind Contributions:

Police Athletic League; Ensemble Studio Theatre; Hudson Scenic Studios, Inc.; Colorforms; Bruce Cohen & Associates; Shays & Murphy; Sanford Wein; Bernhardt Fudyma Design Group; New York Mets; Consolidated Edison; Stephen Graham



**THE FOOD CHAIN**

1991 Cape (We survived Hurricane Bob) Cod  
One-on-Ones  
Ensemble Studio Theatre  
August 27, 28, 29, 30, 1991

All music composed by Rob Reale, unless otherwise noted.

**"Blame It On Bob"** - Company - Lyrics by Willie Reale ■ Music by Tim Ray  
and Rob Reale

**THE ADVENTURES OF SIR CORNINGTON OF CHOWDER**

Written by Willie Reale ■ Directed by Demitri Corbin

Written for Kristen Bess, Age 7

Bob, A Miserable Peasant. . . . .Demitri Corbin

Sir Cornington of Chowder. . . . . Kristen Bess

Masculine Chorus. . . . . Lewis Black, Paul Butler, Kevin  
O'Rourke, Christopher Randolph, Willie Reale & Jose Soto

"Unlucky" and "Next To You I'm Lucky" - Lyrics by Willie Reale

**HIGHER ORDER OF SHRIMP**

Written by Kevin O'Rourke & Edith Thurber ■ Directed by Kevin O'Rourke

Written for Samona Squire, Age 12

Shrimp. . . . . Samona Squire

Waiter. . . . . Kevin O'Rourke

Chef. . . . . Lewis Black

"I May Be Small, But I Can Swim" - Lyrics by Kevin O'Rourke  
Music by Tim Ray

**TWO TO GO**

Written by Carl Capotorto ■ Directed by Becky Browder

Written for Natasha Soto, Age 8

Honey Bun. . . . . Becky Browder

Cherry Tomato. . . . . Natasha Soto

"Two Foods Kvetching" - Lyrics by Willie Reale

**ELLIE AND ME**

Written and directed by Rob Reale

Written for Eric Santoni, Age 9

Ellie. . . . . Cecilia Arana

Theo. . . . . Eric Santoni

### **DREAMWORK\***

Written by Craig Lucas ■ Directed by Ann Talman  
Written for Darthula Harvey, Age 10  
Tall Woman. . . . . Ann Talman  
Charming Little Girl. . . . . Darthula Harvey  
Song  
Dance

-Intermission-

### **LOST ON THE COUCH**

Written and directed by Lewis Black  
Written for Nyita Hanley, Age 8 1/2  
Lucille. . . . . Nyita Hanley  
Larry. . . . . Lewis Black

### **SEAFOOD SURPRISE**

Written and directed by Christopher Randolph  
Written for Tina Vamvoukakis, Age 11  
Ed. . . . . Christopher Randolph  
Ethel. . . . . Tina Vamvoukakis  
Susie, the Waitress. . . . . Ann Talman  
Mr. Finn. . . . . Lewis Black  
"Make A Wish" - Lyrics by Christopher Randolph

### **CLIFFHANGER**

Written and directed by Willie Reale  
Written for Andre Parks, Age 9  
Keith, A British buzzard. . . . . Willie Reale  
The Maharaja. . . . . Andre Parks  
"The Buzzard's Lament" & "Can't Means Won't" - Lyrics by Willie Reale

### **MOM'S HOME COOKING**

Written by Richard Dresser ■ Directed by Pamala Tyson  
Written for Joanne Ramirez, Age 14  
Judy. . . . . Pamala Tyson  
Mom. . . . . Joanne Ramirez  
"Chill Out Mom" - Lyrics by Richard Dresser & Pamala Tyson  
Music arranged by Tim Ray & Rob Reale

### **EVERY LITTLE FISH IN THE SEA**

Written and directed by Cindy Lou Johnson  
Written for Wendell Borrero, Age 9  
Amoeba, Worm, Bass, Shark. . . . . Wendell Borrero  
The Voice Of The Wisdom Of All The Ages. . . . . Paul Butler  
Minnow. . . . . Natasha Soto  
Mourning Bass. . . . . Cecilia Arana, Nyita Hanley  
& Samona Squire  
"Every Little Fish In The Sea" - Lyrics by Cindy Lou Johnson  
Performed by The Hurricane Bob Singers ■ Choreographed by Pamala Tyson

\*Authorship in question. Play incomplete or nonexistent by opening night.

The 52nd Street Project gratefully acknowledges the support of the following foundations, corporations, government agencies and individuals: Altman Foundation, The Robert Bowne Foundation, Citibank, The Liz Claiborne Foundation, Consolidated Edison, Nathan Cummings Foundation, D-B Trust, Department of Cultural Affairs, The Department of Youth Services, Educational Foundation of America, The William and Mary Greve Foundation, The Kids Fund, The Eugene and Rosa Kleiner Family Foundation, The Marquis George MacDonald Foundation, The James Macdonald Foundation, Morgan Guaranty, Morgan Stanley and Company, New York State Council on the Arts, The New World Foundation, The New York Times Company Foundation, Primerica Foundation, The Samuel and May Rudin Foundation, The Fan Fox and Leslie R. Samuels Foundation, The Threshold Foundation and

Polly AdamsJohn Kauer  
William R. Adams, Jr. Neagles  
Beth Adams  
Mr. & Mrs. Addison  
Nancy AdersonClyde in Lewis  
Diane Adee  
Beth S. Adler  
Laurena Allen  
Lyndie L. Allman  
Jane Anne Anderson  
Cecilia Arana  
Alan AronoffKay Matzshulte  
Linda Aronson  
Irene L. Aronson  
Margot Avery  
Tony Ayward  
Jan Behrman  
Kris Bergatt  
Anne BaileyCharles Wings  
Jeanne Bailey  
Lynn Bailey  
Deborah Baker  
Wendy Baker  
Dorothy BakerCatherine Wilson  
Michael Barber  
Cathy Barwick  
Sam Barwick, Jr.  
Elizabeth Barzoff  
Miriam Barry  
Gay Barton  
Jill Bascoe  
Christopher Beach  
Julie Massey Becker  
Andre Beckles  
Henry Becker  
Terry Becker  
Walter Alan Bennett, Jr.  
Edly Benson  
Mr. & Mrs. N. Benson  
Olea Benz  
Andrew Berger  
Carrie Berger  
Pat & Howard Berke  
Pat Berlin  
Amy Bernbaum  
Rupen Beroukian  
Andre Berthel  
Mr. & Mrs. G. Beisenger  
Christian Bickelstein  
Shelley Rubin Stern  
R.D. Bickman  
Alison M. Bickman  
Lee Bihler  
Kathleen Birkbeck  
Rita BransonVerna Doris  
William L. Branner  
Sue Bress  
Tom Britt  
Rita & Fred Bross  
Eric Bross  
Sandy Brossen? et al. Housat  
Karen Brown  
Carol M. Brown  
Deborah Brown  
Phyllis J. Brown  
David Buxton  
Margaret Butt  
Mindy Byer  
Celia Fin Center  
Beverly Catherine Christine Dunn  
Lisa M. Callahan  
Patricia M. Carr  
Lynda Scott Carnegie  
Anne Carney  
Geneva Carr  
Susan Carter  
Anne Cattaneo  
Laura Marie Cavallaro  
Clara L. Chavis  
Cheryl Chavira  
Rachel Chavira  
Jill & Dan Chestnut  
Ethan Chermash  
Michelle & Patricia Cherge  
Laura Chiffone  
Peter ChiossoThomas  
Russell Chung  
Ben & Mary Clarke  
Charles Ray Cochran  
Ruth Cohen  
Richard J. Cohen  
Robert T. Coyle  
The Cooper Committee  
George Corbi, Jr.  
Eileen Corbi  
Janet Crawford  
Christina Cunningham  
Edie Cusack  
Neil CutlerWendy Daxner

Arthur Danczik  
Cathy Danczik  
Max Danciger  
Virginia Dera  
Glynis Deras  
Leslie Deer  
Dore DesevHarris Sykes  
Carol & Brian Deskins  
Catherine Grace Dent  
Margie & Vincent Desord  
Jodi Dill, Duff  
Jacqueline Dinsagen  
Polly Dixon  
Mara Drexel  
William Duff Griffin  
Charles & Josephine Dumas  
Jack & June Dunbar  
Muri Colville  
Ava Peter Johnson  
Neil Eisenberg  
Shawn Ellis  
Eliot & Hammer  
Deen Elikson  
Beth A. Elinson  
Dana Elinson  
John P. Engel  
Wendy Engler  
Martha EversBeth Lohing  
Susan EversBeth Black  
Bill FaganCatherine McClellan  
Larissa Fara  
Jessica Fader Brinkman  
Peter Jay Farnsworth  
Evel Fink  
Kath Fisher  
Rheal Flegenbaum  
Alicia A. Fiegel  
Tom FortinGeggen Lewis  
Michelle FrenkelCaroline Assari  
Janet FrenkelMichael Geiger  
David Francis  
Richard Francis  
Frank Fratantoni  
Bruno & Nancy Frausthal  
Lisa FreyLynn MillLaughlin  
Elizabeth Friedman  
Laura P. Friedman  
Steven & Carol Gantins  
Mia Gandy  
Betsy Gantins  
In Honor of Suzanne Gelles  
Thomas L. Gelsomino  
Nancy Gendronico  
Josephine Gardina  
Sharon & Gilbert  
Jack GigenekMcDonough  
The Gidyczs  
Aren Gidycz  
Mrs. Ben P. Gidycz  
Julie Gidycz  
Seymour Gidycz  
Edward & Susan Gidycz  
Susan Gidycz  
Helen & Peter Golden  
Glorie Goodman  
Christopher Gould  
Patricia Graf  
Bessie Graham  
Reedling Gray  
In Honor of Clara Greene  
Susan Greenberg  
Ken Greenfield  
Sara Greenwald  
Cahn GreenFrancis Lettman  
Jan OrloffLiane Ina Bloom  
Joni Grillo  
Stephan Grunell  
Lynda Guzman  
Albert R. Gurley  
Doreen E. GweenHoyer  
Randy Hae  
Thomas Hallias  
Lynne Halley  
Janet Hampton  
Mira HannonTom Hasek  
Carl, Kathleen  
Zella Hammer  
Evan Hamler  
Trisha Hanger  
Raleigh Harel  
Richard J. Harter  
Gerard E. Harper  
Diane Haskell  
Jayne HayesJohn Patrick Shanley  
Duncan Hazard  
Betsy Hegeman  
Robert Henschel  
Rak Henschel  
Richard Hicks

Chris Hill  
David G. Hoffman  
Jane Hoffman  
Lynn M. Hoss  
Betsy Hooken  
Pam Horowitz  
Prager Hultine  
Thomas Hulse  
Lisa P. Hyles  
Amy IngrassiaJohn Henry Davis  
Celia Ivins  
Jacqueline Dinsagen  
Polly Dixon  
By Justice  
Claudine Jackson  
Cindy Liu Johnson  
Gregory A. Johnson  
Ava Peter Johnson  
Elmer Jones  
Cheryl Jones  
Sue Joy  
Hattie Judger  
Laurin Kamens  
Michael KaneLudith Rubinick  
Mark Jacobs  
Dori Jacoby  
Lisa Kachewich  
Ira KarasikAlice Jacobson  
Mark J. Kennedy  
Bill KayeMark Schwab  
Pam Keppman  
Laurance Klesan  
Tracy Knight  
Rita KnudtBogdan Cohen  
Iris Kovacs  
Judy Kuhn  
Marce Jean Kurtz  
Lewisa M. Kutz  
Patricia Lack  
Bill Lambert  
Diane Landau  
Arthur E. Land  
Susan A. Lange  
Jayne Lapan  
Jill Larson  
Karen Joanne Lathan  
Kara Lee  
Jesse & Dana Lehman  
Sara Jane Leigh  
Jennifer S. Leites  
Phyllis Lemes  
Peggy Lee  
Shirley Lee  
Georgina & Marger J. Levy  
Vivica Leisner  
Ben Lizon  
John Bedford LloydAlanna Twanney  
Lisa Lippman  
Katherine K. Loria  
Mr. & Mrs. Sherman Loria  
Heather Lugin  
Chris & Sally Lutz  
John Lyons  
Peter & Maria Mackinn  
Greg MaulPamela  
Rupen McArthur DeCasse  
Michael S. Magidson  
Rudy Magee  
Carly M. MahoneyThomas Malles  
Laurance Mariani  
Anthony Marongelli  
Doreen MarguliesJohn Bross  
Amy Marx  
Timothy Mason  
Peter Massaron  
Carman Mathews  
Rick Mathews  
Connie S. Mathis  
Joan McAffee  
Eliot M. McCabe  
Paul McCrane  
James Ryan  
Francis McDonough  
Ann M. McGeehan  
Joanna MerriDavid Driscoll  
Jan & Richard Merrill  
Laurie MessnerHedy Haeas  
Eliot Strout Miller  
Linda Miller  
Sharon WillSchirle Winn  
Wendy Miller  
David Misch  
Ed Merrill  
Margaret E. Montgomery  
George E. Morgan  
Cedar Morgan  
Patricia Murphy

Liz Barney Murphy  
Susan Murphy  
John G. Neale  
Liz Nease  
Amy O'Neil  
Charles M. Nelson  
Virginia Newirth  
Peter Neufeld  
Francis Newirth  
Brian Robert Newery  
Peter Neuman  
Eliot Newsh  
Quentin O'Brien  
Peter O'Brien  
James L. Oakes  
Carol Ochs  
Sarah O'Connell  
Doris Oshel  
Michael Oshel  
Kevin O'Shaughnessy  
Kazuko Oshima  
Henry D. Oshing  
Miriam Osoe  
Rosemary & Charles Pans  
Peter Pans  
John & Kristine Pankas  
F. Richard Pappas  
Julia Pans  
Eliot PansMark Lapan  
Mr. & Mrs. Robert Pankas  
Alicia Pankas  
Jenny Pans  
Frances Pappas  
David Pans, Jr.  
Ken Pans  
Lyndie Perry  
Susan Perry  
David Perelman  
Ruth Perelman  
Thomas P. Peters  
Mindy Pfeffer  
Robert & Susan Pflieger  
Nancy Plotzke  
John PennworthO'Brien  
Bill Pinyan  
Douglas P. Piner  
David M. Piner  
Rosa Piner  
Marlene Quirk  
Kathleen T. Quinn  
Rebecca Rabinowitz  
Marge Raab  
Shirley Raab  
Neha RaichMae Benkovic  
Rita C. Raichman  
Tim & Terry Ray  
Edward Raupberg Ray  
Earl Ray  
Paul Reale  
Jacquelyn Reingold  
Chris Reisman  
Lynise & Katherine Romanstein  
Julie Riggs  
Elisabeth Rigg  
Lila Robinson  
Steven M. Roebuck  
Gail Rogerson  
Bruce & Erin Roseman  
Dorrie Rossman  
Karen Rossman  
Debra Ross  
Mach Rosoff  
Andy Roth  
Alyce Roth  
Martha RothBill Iwen  
John Rothman  
Robert de Rothschild  
Doreen J. Rothschild  
Joyce Rubinick  
Paul Rubinick  
James Ryan  
Amy Saltz  
Burt Salovey  
Steven Sater  
Larry & Deborah Schiff  
Lynn SchaefferWilliam Lutz  
Dori Schneider  
Betsy Schneiderman  
Kim & Mary Ann Schuler  
Margery C. Schwarz  
Janet P. Scott  
Sara Scott  
Angela & John Schwartz  
Julia Selig  
Herika Seligshu  
Susan Seligson  
Betsy Shapiro

Murray Shiers  
Mr. & Mrs. George Shiers  
Bernice Baruch Shier  
Arnold Shier  
Alice Shier  
Michael Shier  
Dr. Paul Shier  
Wanda Shiffman  
Sharon Shier  
Brian ShierKathy Dryden  
Ben & Ginny Singer  
Justin Singman  
Jay Singman  
Meg Simon  
Jacqueline Simon  
Alice Simpson  
Betsy Singer  
Tan Singer  
Isadora & Judith Singer  
David Julian Sisk  
Lee Simon  
Sally Siskowitz  
Susan Siskowitz  
Dore Siskowitz  
Eric Spelman & Sherman  
Julie Spelman, Jr.  
Marie Spornowitz  
Francis & Stanley Martin Neeman  
Robert Spitzer  
June Stein  
Jerry Steiner  
Alicia SteinerRaeann Tighman  
Yeh K. Stevens, Sr.  
Tam & Maureen Stewart  
Joy Weiss Stewart  
J. Frederick Stillman, II  
Dorothée Stronass  
Jill Sugarman  
Loren Sugarman  
Andrew SeeKatie Taylor  
Andre Sees  
Anne Seiff  
Helen Seiff  
Judy Seiff  
Jane Seiff  
Lynn T. Seiff  
Michael Seiff  
Stanley & Dora Thomas  
Sara Val Thomas  
Tracy Thomas  
Kathleen T. Thomas  
Catherine G. Tracy  
Kim TeroffPeter Harrison  
Marti & Kathleen Trice  
Kathleen Turner  
Julia Tygart  
Patricia Tyson  
Helen Tyson  
Joan Unger  
Michael Unger  
Laura Valasco  
Peter ValascoCharles Goldberg  
Ira Valasco  
Angelo & Patty ValascoJulie  
Irene & Mira Vargas  
Annette H. G. Vermaulen  
Scott Weiss  
Marc Wallace  
Mary Pat Walsh  
Erika WassonGaelan Hamilton  
Karen Wasson  
Debra Wasson  
Randy Wasson  
Hil B. Wheeler  
Chris Whipple  
Mr. & Mrs. Robert Wheeler  
Max White  
Jeff Whitman  
John White  
Peggy White  
Donald Whitman  
Geert Wilsen  
Kathryn & Robert Wolfe  
Margaret L. Wolf  
Joan & David Wolf  
Joanna Wolfson  
John Woodward  
Jill & James Yass  
Elizabeth Yass  
Sharon Yerman  
Susan Yerman  
Janet ZornMark Gould  
Dore Zlot



The 52nd Street Project Presents the 1991 Playbook Plays "Sometime Later..."

# SOMETIME LATER...

The 52nd Street Project Presents  
**SOMETIME LATER...**  
The 1991 Playback Plays  
October 15, 16, 17, 18, 19, 20, 1991  
The Samuel Beckett Theatre - New York City

**Project Staff**

Willie Reale, Artistic Director  
Carol Ochs, Executive Director  
Jenny Gersten, Assistant to the Directors  
Daniel Judah Sklar, Playmaking Director  
Michaela Murphy, Replay Co-Artistic Director  
Larry Nathanson, Replay Co-Artistic Director  
June Ballinger, Director - 52nd Street at Graham-Windham  
Susan Willerman, Instructor - 52nd Street at Graham-Windham

**Production Staff**

Kevin Joseph Roach, Set Designer  
Greg MacPherson, Lighting Designer  
Deborah Natoli, Stage Manager  
Iris A. Brown, Graphics/Slides  
Mina Hammer, Slides  
Douglas Daven, Colorforms  
Michele Mayas, Props  
Tracy Knights, Light Board Operator  
Basil Boatwright, Taped Sound  
Sean Sinceno, Synthesizer  
Jeremy Gray, Furniture  
Mina Hammer, Slide Operator  
Bill Wrubel, Load-In

Light Hang/Load-In Crew: Sally  
Chung, Jeremy Gray, Magnus  
Ragnarsson, Colleen Thurber  
Maggie Vandegrift  
Jean Bacharach, House Manager  
Running Crew: Sean Flynn, Suzy  
Kitman, Ed Miller, Alexandra  
Paxton, Mindy Pfeffer, Joanne  
Ramirez, Angela Trento,  
House Crew: Randy Hale, Art  
Halpern, Ann Kahn, Roberta  
Kastelic, Mindy Pfeffer, Gabriella  
Shannon, David Steffan, Pamela  
Stewart

The 52nd Street Project is an independent, nonprofit organization that operates with the cooperation of The Ensemble Studio Theatre and the Police Athletic League. The Project brings inner-city children together with professional theatre artists to create theatre. SOMETIME LATER is the pilot production of a new program called **Playback**. In it, an adult actor/playwright is paired with a kid actor/playwright. The duo is charged to invent two characters for the kid to write a play for. The adult then responds with a second play using the same two characters. The program was invented to challenge kids who are veterans of the Project's acting and writing programs.

**Board of Directors**

Ben Barenholtz  
Rachel Chanoff  
Marsue Cumming  
Stephan Ettinger, Chair  
Stephen Graham  
Pamela Lack

Heidi Landesman  
Frances McDormand  
Patricia Murphy  
Carol Ochs  
Willie Reale  
Pamala Tyson  
Laura Valeroso

**Special Thanks To:**

Curt Dempster, Dominick Balletta and The Ensemble Studio Theatre; Keith, Lystra, Patty, Tito and the P.A.L., Greg MacPherson; Neil Mazzella, Ralph, Jose and Hudson Scenic; Susan Murray and Stephen Graham, Helen Cook, Randee Smith, Pam Berlin, Bob Moss, Travis Preston, Dave Mead and The Playwrights Horizons Theatre School; John Bale; Carl Dettmer; Frank Braccagio; David Milligan, Paul Daniels and Playwrights Horizons; Phyllis Binaghi, Carol Bowker and Colorforms; Dave Smith and Bugs & Daffy; Jilian Gersten; Graham-Windham; Laura Jones, Gus Rogerson, Steve Shelton and Douglas Daven; Jan Buckaloo, Barbara Ettinger and Frances McDormand; The Young Playwrights Festival for the use of Peter Francis James; Tom Reale, and Christopher Danby Fisher.

**In-Kind Contributions:**

Police Athletic League; Ensemble Studio Theatre; Hudson Scenic Studios, Inc.; Colorforms; Bruce Cohen & Associates; Shays & Murphy; Sanford Goldstein; Bernhardt/Fudyma Design Group; New York Mets; Consolidated Edison; Stephen Graham, Donald Marcus, Playwrights Horizons Theatre School

Thank you for coming! If you are not on our mailing list (or if your address has changed), please fill out this form and give it to us on your way out, or mail it to the address below. We would also like to know if you would like to be of help to us in the future (primarily in the areas of fundraising, backstage and printing). If so, please fill out your name, phone number and areas of interest below.

**PLEASE ADD ME TO YOUR MAILING LIST:**

NAME \_\_\_\_\_

ADDRESS \_\_\_\_\_

\_\_\_\_\_ Zip \_\_\_\_\_

PHONE \_\_\_\_\_

**YES, I WOULD LIKE TO BE OF HELP:**

NAME \_\_\_\_\_

DAYTIME PHONE \_\_\_\_\_

AREA(S) OF INTEREST \_\_\_\_\_

\_\_\_\_\_

**ON SALE IN THE LOBBY !!!**

52nd Street Project T-Shirts with Shel Silverstein Logo: \$12.00  
"Playmaking" by Daniel Judah Sklar: \$12.00  
10th Anniversary Commemorative Poster by Iris A. Brown: \$10.00  
The Fabulous "Flyer Chocolate Bar": \$1.00  
Remember, one-half of sale price is tax-deductible!

If you would like to mail this (and you're always welcome to enclose a tax-deductible contribution), you can send it to:  
The 52nd Street Project, 552 West 52nd Street, New York, NY 10019 (212) 245-1350.

**SOMETIME LATER...**  
1991 Playback Plays  
The Samuel Beckett Theatre  
October 15, 16, 17, 18, 19, 20, 1991

**EVENING A: October 15 -18**

**WHISKEY, YOGURT**

Written by Danielle Ferrin, Age 14  
Directed by Jan Buckaloo  
Whiskey, a young cat ..... Danielle Ferrin  
Yogurt, a young dog. .... Hugh Sinclair

**YEARS LATER**

**WHISKEY & YOGURT REVISITED**

Written and Directed by Jan Buckaloo  
Whiskey, an old cat. .... Danielle Ferrin  
Yogurt, an old dog. .... Hugh Sinclair

**LOVE MOVES**

Written by Shamine Gibson, Age 15  
Directed by Demitri Corbin  
David. .... Shamine Gibson  
Dad. .... Christopher Danby Fisher

**TWO HOURS LATER**

**LOVE MOVES II**

Written by Daniel Judah Sklar  
Directed by Demitri Corbin  
David. .... Shamine Gibson  
Dad. .... Christopher Danby Fisher

-Intermission-

**ACT RIGHT**

Scenes 1-3 written by LaTanya Godfrey, Age 15  
**A VERY SHORT WHILE LATER**  
Scenes 4-6 written by Carl Capotorto  
Directed by Byam Stevens  
Bob. .... Peter Francis James  
Mother. .... LaTanya Godfrey  
Robber/Devil/Manny Dollars. .... William Wise  
Casting Director. .... Willie Reale

**EVENING B: October 19-20**

**THE TIME OF UNPRUNING**

Written by Jessica Soto, Age 14

Directed by Leigh Curran

Martha.....Leigh Curran  
Lisette.....Jessica Soto  
Grace.....Mina Hammer

**TWENTY-FIVE YEARS LATER**

**THE RED THING THAT PUMPS**

Written and directed by Leigh Curran

Martha.....Leigh Curran  
Lisette.....Jessica Soto  
Cameramen.....Basil Boatwright,  
Sean Sinceno

**GLEN'S PLAY**

Written by Glen Jenkins, Age 15

Directed by James McDaniel

Mike.....James McDaniel  
Steve.....Glen Jenkins  
Rose.....Mary Kane  
Voice.....Sean Sinceno

**A MOMENT LATER**

**HAM AND EGGS**

Written and directed by James McDaniel

Mike.....James McDaniel  
Steve.....Glen Jenkins

-Intermission-

**TWO OF A KIND**

Written by Jessica Cordero, Age 15

Directed by Kirsten Sanderson

Kathy.....Jessica Cordero  
Mom.....Christine Farrell

**FIVE MONTHS LATER**

**TWO OF A KIND, ACT II**

Written by Sybil Rosen

Directed by Kirsten Sanderson

Kathy.....Jessica Cordero  
Mom.....Christine Farrell

**THE NERVOUS SYSTEM**

Written by Jose Soto, Jr., Age 15

Directed by Mary Kane

Mr. Pittis.....Jeff Williams  
Eladio.....Jose Soto, Jr.  
Ms. Howard.....Mindy Pfeffer

**TEN YEARS LATER**

**DOUBLE JEOPARDY**

Written by Willie Reale

Directed by Mary Kane

Mr. Pittis.....Jeff Williams  
Eladio.....Jose Soto, Jr.  
Announcer.....Willie Reale  
Alex Trebek.....Willie Reale

Thank you for coming! If you are not on our mailing-list (or if your address has changed), please fill out this form and give it to us on your way out, or mail it to the address below. We would also like to know if you would like to be of help to us in the future (primarily in the areas of fundraising, backstage and printing). If so, please fill out your name, phone number and areas of interest below.

**PLEASE ADD ME TO YOUR MAILING LIST:**

NAME \_\_\_\_\_

ADDRESS \_\_\_\_\_

\_\_\_\_\_ Zip \_\_\_\_\_

PHONE \_\_\_\_\_

**YES, I WOULD LIKE TO BE OF HELP:**

NAME \_\_\_\_\_

DAYTIME PHONE \_\_\_\_\_

AREA(S) OF INTEREST \_\_\_\_\_

**ON SALE IN THE LOBBY !!!**

52nd Street Project T-Shirts with Shel Silverstein Logo: \$12.00

"Playmaking" by Daniel Judah Sklar: \$12.00

10th Anniversary Commemorative Poster by Iris A. Brown: \$10.00

The Fabulous "Flyer Chocolate Bar": \$1.00

Remember, one-half of sale price is tax-deductible!

If you would like to mail this (and you're always welcome to enclose a tax-deductible contribution), you can send it to:

The 52nd Street Project, 552 West 52nd Street, New York, NY 10019 (212) 245-1350.

TRIPLE  
THREAT

~~X/O~~  
~~X/O~~  
~~X/O~~  
2

yes! again

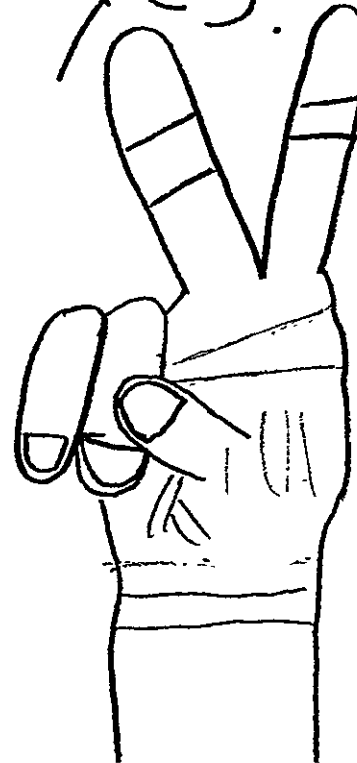

The 52nd Street Project Presents

**TRIPLE THREAT - PART II**

The 1991 Replay Plays

November 5, 1991

The Ensemble Studio Theatre - New York City

**Project Staff**

Willie Reale, Artistic Director

Carol Ochs, Executive Director

Daniel Judah Sklar, Playmaking Director

Michaela Murphy & Larry Nathanson, Guest Artistic Directors

Jenny Gersten, Assistant to the Directors

**Production Staff**

Jenny Peek, Stage Manager

Tracy Knights, Lighting Mentor and  
Technical Director

Mina Hammer, Art Mentor

Jeremy Gray, Load-In King

Wendell Borrero and Danny Noonan,  
Light Board Operators

Penny Plunkert, Slide Operator

Barbara McCrane, Synthesizer Mentor

Joanne Ramirez, Synthesizer

Jessie Klaus, Running Crew

Zach Klaus, Running Crew

Amy Barbosa, Art Crew & House Crew

Eli Barbosa, Art Crew

Jill Barbosa, Art Crew & Colorform Head

Dawn Jackson, Art Crew & Slide Crew

Evelyn Maldonado, Running Crew

Danny Noonan, Art Crew & Cover Design

Ronnie Noonan, Art Crew

Lori Quinones, Art Crew

Victor Rojas, Art Crew

Mary Vamvoukakis, Art Crew

Tina Vamvoukakis, Furniture Head

Virginia Vargas, Art Crew

Karen Myrie & Virginia Vargas,  
Assistants to the Artistic Directors

The 52nd Street Project brings inner-city kids together with professional theater artists to do theater. All of the Replay writers have attended Daniel Judah Sklar's 8-week Playmaking course and wrote plays for the production "HumanNature" or "The Dream Theme" in 1990. In February, they all returned to class for an 8-week Replay course which took them to the next step in playwriting. In April, the Project took 15 Replay kids with an equal number of adults to Tannersville for a weekend, where each play was given a rehearsed reading and critique with professional actors. Upon return to New York, the kids attended a week-long re-write class. Four plays were then selected for production. And for the second time in Project history, the plays are "all kid" produced - writers, directors, actors and crew. The first set was in August and we are planning the final set of Replay Plays in the spring.

**Special Thanks to:**

The P.A.L. staff; Curt, Dominick, and the Ensemble Studio Theatre, Michael Bernard, Wesley Clark, Penny Plunkert, John Klaus, and the kids' parents.

**TRIPLE THREAT - PART II**

The 1991 Replay Plays

November 5, 1991

**CITY HUSTLER**

Written by Jamar Williams

Directed by Lori Quinones

Adult Mentor, Jeff Sugarman

Auntie B. . . . . Samona Squire

Robby. . . . . Danny Noonan

Token Buyers. . . . . Jill Barbosa, Tina Vamvoukakis

**THE QUIET CONTEST**

Written by Wendell Borrero

Directed by Samona Squire

Adult Mentor, Anne O'Sullivan

Captain Hulk. . . . . Eli Barbosa

Mr. Power. . . . . Victor Rojas

**A BALL FOR A FALL**

Written by Danny Noonan

Directed by Victor Rojas

Adult Mentor, Polly Adams

Jack. . . . . Wendell Borrero

Tom. . . . . Luis Santoni

**MASSIVE FRIENDS**

Written by Samona Squire

Directed by Dawn Jackson

Adult Mentor, Susan Willerman

Antonette. . . . . Kulondi Frier

Simone. . . . . Annette Myrie

Jamal. . . . . Eric Santoni

Kev. . . . . Jamar Williams

Unknown Character. . . . . Yolanda Maldonado

Father Noonan. . . . . Ronnie Noonan



The 52nd Street Project gratefully acknowledges the support of the following foundations, corporations, government agencies and individuals: Altman Foundation, The Robert Brown Foundation, Citibank, N.A., The Liz Claiborne Foundation, Consolidated Edison, Nathan Cummings Foundation, D-B Trust, Department of Cultural Affairs, The Department of Youth Services, Educational Foundation of America, The William and Mary Grave Foundation, The Hennessy Foundation, The Kids Fund, The Eugene and Rose Kleber Family Foundation, The Marquis George MacDonold Foundation, The James Macdonold Foundation, Morgan Guaranty, Morgan Stanley and Company, New York State Council on the Arts, The New World Foundation, The New York Times Co. Foundation, Primavera Foundation, The Samuel and May Rudin Foundation, The Fan Fax and Leslie R. Samuels Foundation, The Threshold Foundation and

William E. Adams/J. Hoagale  
Beth Adams  
Henry Adams/Clyton Lewis  
Diane Ads  
Lynette L. Allison  
Alan Arfio/Kay Mutschelbat  
Margot Avery  
Joan Bacharach  
Aana Bailey/Charles Wright  
Joanna Bailey  
Lynn Bailey  
Deborah Baker  
Wendy Baker  
Domenick Balletto/Brian White  
Michael Bandier  
Colby Baranack  
Ean Baranowitz  
Elizabeth Barbeydt  
Maranda Barry  
Gary Bartos  
Christopher Beach  
Joely Muzzey Becker  
Terry Bekaner  
Walter Allen Bennett, Jr.  
Emily Beutels  
Mr. & Mrs. H. Beutels  
Andrew Benzinger  
Corinne Berger  
Pat & Howard Berke  
Amy Berenson  
Rebecca Berenson  
Andre Biskop  
Mr. & Mrs. G. Bissinger  
Allene M. Bliniken  
Risa Bronson/Rene Garcia  
Bak Bruck  
Froze Brill  
Rita & Fred Brooks  
Eric Brooks  
Bucky Browder/Tad Nemstahl  
Gerritt M. Brown  
Deborah Brown  
Phillip J. Brown  
David Buckle  
Mandy Byar  
Celia Fina Carter  
Steven Callahan/Christine  
Dana  
Anee Carney  
Gloria L. Chaloe  
Cheryl Chalmers  
Rockell Chasoff  
Jill & Don Christie  
Ellen Chownorth  
Michael & Pamela Czapiga  
Leah Chisler  
Peter Christenstophelous  
Ben & Mary Clark  
Charles Ray Cochran  
Ruth Cohen  
Richard J. Cole  
The Cooper Council  
George Corrie, Jr.  
Eileen Corral  
Janet Crawford  
Edie Crutch  
Neil Cuthbert/Wendy Dested  
Arthur Dackshik  
Cathy Dackshik  
Maia Demzigar  
Cynthia Durlow  
Larissa Durt  
Dale Davis/Harris Syybes  
Carol & Booth Deakins  
Catherine Grace Deak  
Jodi SH. Dell  
Patty Draper  
Maera Driscoll

William Dell-Griffin  
Jack & Jane Deubar  
Joanna Edgar  
Mad Eisenberg  
Elliott & Hommer  
Gwen Ellison  
John P. Engel  
Wendy Ettinger  
Martin Evans/Par LeVing  
Susan Evans/Rae Black  
Bill Fagerbakke/Catherine  
McClanahan  
Pater Joy Fernandez  
Shasha Fiegelbaum  
Alexis A. Fiegel  
Tom Fontana/Suzanne Lewis  
Janine Formosa/Caroline Arroyo  
Janet Foster/Michael Geiger  
David Frankel  
Lisa Fry/John McLaughlin  
Elizabeth Friedmann  
Lariss P. Friedmann  
Ma Geary  
Betty Gordella  
Thomas L. Gottstein  
Joseph Gordino  
Jack Goble/Ann McDonough  
The Gochman  
Alvin Goldfine  
Judy Goldfine  
Seymour Goldstein  
Edward & Susan Goldstein  
Susan Goldstein  
Helen & Peter Goldstein  
Greer Goodman  
Christopher Gould  
Patricia Graf  
Stephane Grubman  
Reisfeld Gray  
In honor of Sara Gruman  
Susan Greenhill  
Ken Greenfield  
Sara Greenwood  
Celia Greer/Frances LaBarre  
Joe Grillo/Jane Ira Brown  
Janet Griffin  
Stephane Grunwald  
Lyons Gupontskine  
Albert R. Gursky  
Thomas Halkias  
Lyons Halliday  
Jennifer Home  
Mina Homan/Tom Kaula  
Carl, Kathleen &  
Zella Homaner  
Irene Hummer  
Trisha Hunter  
Baleigh Huxel  
Karyn Hunting  
Gerald E. Hyslop  
Diane Hershall  
Joyce Hoyman/John Patrick  
Shandley  
Doranne Hessel  
Betty Hoggan  
Sarah Horkley  
Rob Horshorn  
Richard Hicks  
Chris Hill  
Joan Hoffman  
Bibby Hopkins  
Irwin Horowitz  
Thomas Hoke  
Amy Intracasa/John Henry  
Devin  
Celia Irvine  
Rusty Magoo  
Yves-Andre Islet

Mark Jacobs  
Sy Jacobs  
Candy Lee Johnson  
Gregory R. Johnson  
Avah Pavlar Johnson  
Eliot Jones  
Cherry Jones  
Bob Joy  
Hattie Jurgale  
Lawena Kanner  
Michael Kane/Judith Rodack  
Ira Karasick/Nora Jacobson  
Mark J. Kennedy  
Ken Ketry/Alice Schamp  
Patti Kipperman  
Tracy Knights  
Rita Koss/Stephen Cohen  
Joel Klein  
Morris Joan Kutz  
Lewis M. Kvit  
Pamela Lack  
Bill Lambert  
Gloria Landis  
Arthur E. Landi  
Susan A. Lange  
Joyce Lapina  
Bill Larson  
Kate Lear  
Jesse & Dana Lohman  
Sara Jane Leigh  
Priscilla Lemas  
Georgella & Morgan J. Levy  
Yveta Liebhart  
John Bradford Lloyd/Aana  
Tomasz  
Lina Lomaszewska  
Mr. & Mrs. Stephen Lamb  
Heather Layton  
Chris & Sally Letz  
John Lyons  
Peter & Marianne MacNicol  
Greg MacPherson  
Rama Mallin/Peter DeCorte  
Michelle S. Magazan  
Rusty Magoo  
Carry Maloney/Herman Malton  
James Maloney  
Donald Margulies/Lynn Street  
Ann M. Marlin  
Timothy Marson  
Peter Masterson  
Garnica Mathews  
Gennie S. Maure  
Joan McArdle  
Paul McCrane  
John McDonough  
Frances McDonough  
Janette Marlin/David Drezitz  
Jan & Richard Marrell  
Elise Bretton Miller  
Wendy Miller  
Cass Morgan  
Patricia Murphy  
Lili Stanley Murphy  
Susan Murray  
John G. Nardi  
Liz Nelman  
Charles M. Nelson  
Peter Neufeld  
Steven Robert Newery  
Peter Newman  
Ellen Nevock  
Debbie O'Brien  
Peter O'Brien  
James L. Onkas

Carol Ocks  
Sarah Okrestad  
Doris O'Neil  
Michael O'Neil  
Kevin O'Rourke/Edith Thorber  
Henry D. Ostberg  
Miriam Ostow  
Rosemary & Charles Pakes  
John Paris  
John & Kristina Pankow  
F. Richard Pappas  
Ellen Parker/Mack Lipkin/Mr. &  
Mrs. Robert Parker  
Mr. & Mrs. Seejay Patel  
Frances Paiger  
Lynette Perry  
Susan Perry  
David Peterkin  
Ruth Peterkin  
Thomas P. Peters  
Robert & Susan Phillips  
Henry Pichone  
John Pindauer/Irene O'Brien  
Nob Rauch/Lisa Reibow  
Tim & Tyne Ray  
Edith Rea  
Paul Reale  
Jacqueline Reingold  
James Reisman  
John Ridge  
Elizabeth Rigg  
Lila Robertson  
Geri Rogerson  
Bruce & Ellen Rosman  
Bara Rosenack  
Mack Rosoff  
Alyson Roth  
Martha Roth/Bill Irvine  
John Rotman  
Robert de Rothschild  
Donald J. Rothchild  
Joyce Rudack  
Paul Rudack  
James Ryan  
Steven Sator  
Larry & Deborah Schiff  
Lyons Schlesinger/Willem Leo  
Don Schneider  
Ken & Mary Ann Schenter  
Sara Scott  
Angelo & John Scribani  
Marika Seppala  
Susan Slaughter  
Barry Shapiro  
Murray Shapiro  
Mr. & Mrs. George Sheehan  
Bernice Baruch Shewel  
Sharon Shkurt  
Brian Shkurt/Patty Dryden  
Ben & Garry Siegler  
Judith Siemann  
Jury Silverman  
Mag Simon  
Jocqueline Simon  
Barry Singer  
Tom Singer  
Isadora & Judith Singer  
Daniel Jacob Sisker  
Luis Smith  
Susan Solomon

Erica Spallone-Silverman  
Jerome Spino, Jr.  
Florence Stanley/Martin  
Newman  
Robert Stecker  
Jerry Steiner  
Byron Stevens/Robin  
Tilghman  
yann K. Stevens, Sr.  
Tom & Marlene Stewart  
Joy Javits Stewart  
J. Frederick Stillman, III  
Catherine Strambos  
Jeff Sugarman  
Lavera Sullivan  
Andrew Swan/Elise Taylor  
Daniel Swan  
Aana Swell  
Hiroko Tanaka  
Joy Tarsas  
Lynn T. Thigpen/Larry  
Arnosso  
Michael Thomas  
Stanley & Gloria Thomas  
Joan Vail Thorne  
Tracy Thorne  
Susan Ann Thoreton  
Catherine C. Tracy  
Kathleen Turner  
Judith Tygard  
Pamela Tyson  
Michael Ustbank  
Laura Valeriso  
Peter Valeriso/Charles  
Goldberg  
Angelo & Petty  
Vannovohakis  
Scott Weiss  
Mary Pat Walsh  
Emma Walsh/Stephen  
Hemilton  
Mr. & Mrs. Charles G. Ward,  
III  
Bruce & Christine  
Wasserstein  
John Weidner/Lila Calabrese  
Ira Weitzman  
Mitchell A. Weitzman  
Betty West  
Ira B. Wheeler  
Mr. & Mrs. Robert Wilder  
Peggy Williams  
Donald Winham  
Gwen Winhoe  
Kathryn & Robert Welle  
Margaret L. Wall  
Joan & Detik Wall  
Joanna Woodford  
Jeff & Janine Yarr  
Joan Zarich/Mark Gould  
Gail Zwargenthal



THE 52ND STREET PROJECT PRESENTS  
**FOLLOW  
THE  
LEADER**

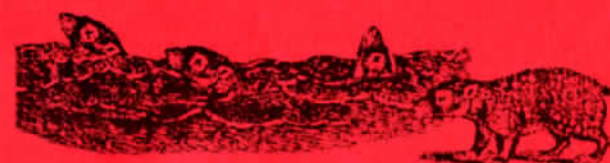

In addition the 52nd Street Project gratefully acknowledges the many individuals who have made gifts of less than \$50.



**THE 52ND STREET PROJECT**  
**Presents**  
**FOLLOW THE LEADER**

**Project Staff**

Willie Reale, Artistic Director  
Carol Ochs, Executive Director  
Jenny Gersten, Assistant to the Directors  
Daniel Judah Sklar, Playmaking Director  
Michael Bernard, Playmaking Volunteer  
Percy Granger, Playmaking Volunteer

Barbara McCrane, Playmaking Volunteer  
Hilary Nudell, Playmaking Volunteer  
Linda Stein, Playmaking Volunteer  
Phyllis Somerville, Playmaking Volunteer  
Karen Myrie, Intern

**Production Staff**

Kevin Joseph Roach, Set Designer  
Greg MacPherson, Lighting Designer  
Composer, Fred Carl  
Tracy Knights, Assistant Lighting Designer  
Katherine K. Lumb, Stage Manager  
Iris A. Brown, Graphics  
Mina Hammer, Slides  
Cathy Graham, Colorforms Designer  
Josh Gosfield, Colorforms Designer  
Patty Dryden, Colorforms Designer  
Sheila Kehoe, Costume Designer  
Jay Manzo, Props  
Jeremy Gray, Sound, Synthesizer & Load In  
Tracy Knights, Light Board Operator  
Robert Grusecki, Piano  
David Gaines, Piano  
Karin Barry, Colorforms Crew Chief  
Elizabeth Barrow, Colorforms Crew  
Julia Bradnan, Furniture Crew Chief  
Karen Myrie, Running Crew  
Victor Roias, Running Crew

Debbie Katzman, Slide Operator  
Jeff Chrczcon, House Crew  
Stephanie Diozzi, House Crew  
Jody SH. Doff, House Crew  
Jennifer Earle, House Crew  
Molly Jackson, House Crew  
Ann Kahn, House Crew  
Rikki Matthews, House Crew  
Minna Rose, House Crew  
Paul Gruen, Light Hang  
Tom Schall, Light Hang & Set Crew  
Hugh Sinclair, Light Hang  
Andrew Kaplan, Light Focus  
Mike Busanet, Light Focus  
Katherine K. Lumb, Set Crew  
David Wirth, Set Crew  
Karin Barry, Ms. Murray's Dresser  
Bob Johnson, Technical Director and House Manager, Vineyard Theatre.

The 52nd Street Project is an independent non-profit organization that operates with the cooperation of the Police Athletic League and the Ensemble Studio Theatre. The Project brings inner-city children together with professional theater artists to create theater. The FOLLOW THE LEADER production is a part of our Playmaking program that is designed to teach children how to write plays. After eight weeks of classes, each child is given two actors, a theme and a director who guides him or her through the writing of a play during a weekend in the country. These are the fruits of their labors.

**Board of Directors**

Ben Barenholtz	Stephen Graham	Carol Ochs
Rachel Chanoff	Heidi Landesman	Willie Reale
Marsue Cumming	Frances McDormand	Pamala Tyson
Wendy Ettinger, Chairperson	Patricia Murphy	Laura Valeroso

**Special Thanks To:**

Doug Aibel, Barbara Zinn Krieger, Jon Nakagawa and the Vineyard Theatre, Tito, Raymond and the staff of P.A.L.'s Duncan Center; Curt Dempster, Dominick Balletta, Andrew Kaplan and the staff of E.S.T.; Greg MacPherson; Barbara P. Ettinger; Wendy Ettinger & Derek McLane, Jack Gilpin and Ann McDonough; Percy Granger; Sylvia Caldman at the library; Brian Mulhall at the stables; Phyllis Binaghi, Carol Bowker and Colorforms; Chris Wigle; Kevin O'Rourke; Bernard Gersten, Susan Knox and Lincoln Center Theater, T.D.F. Costume Collection; Paul Gruen; Tom Schall; Daniel Swee; Annette Myrie; Andre Parks, Karen Myrie, Dawn Jackson, Michael Bernard, Michaela Murphy, Mary Kane, and Jeff Gross; Neil Mazzella, Chris, Sonia, and Hudson Scenic Studios.

**In-Kind Contributions:**

The Vineyard Theatre; Police Athletic League; Ensemble Studio Theatre; Hudson Scenic Studios; Bruce Cohen and Associates; Colorforms; Goldstein, Schrank, Segelstein and Shays; Sanford Goldstein; Bernhardt/Fudyma Design Group; Donald Marcus and Stephen Graham.

# THE 52ND STREET PROJECT'S

## FOLLOW THE LEADER

The Vineyard Theatre  
December 13th, 14th, 15th, 1991

### ACT I

#### THE THREATENED

by Nyita Hanley, Age 9  
Director/Dramaturg: Percy Granger

CANDY.....Anne Swift  
BOB.....Lili Taylor  
COP/CUSTOMER.....Jeremy Gray

#### THE TEACHING ACTRESS

by Rachel James, Age 8  
Director/Dramaturg: Judy Dennis

FRED.....Arthur French  
PATRICK.....Susan E. Murray  
DONNA.....Susan E. Murray

#### THE STAR AND THE STAR-TER

by Fernando Ramirez, Age 11  
Director/Dramaturg: Jack Agüeros

ELENA.....Jane Hoffman  
JULIA.....Mary Kane

#### DEALING WITH GOLD

by Gemma Cooper-Novack, Age 9  
Director/Dramaturg: Jeff Lee

NEREXA.....Gina Torres  
MARINA.....Barbara McCrane  
ARUBA.....Peter Jay Fernandez

### ACT II

#### DONNA'S WISH

by Rashida Koroma, Age 11  
Dramaturg: Tom Babe  
Director: Kevin O'Rourke

MORGAN.....Sheryll Bess  
DONNA.....Alexandra Gersten  
RENE.....Sheryll Bess  
ROCK.....Robert Joy

#### NOW WE'VE GOT EACH OTHER

by Annette Myrie, Age 9  
Dramaturg: Howard Korder  
Director: Willie Reale

ANGELA.....Karen Evans-Kandel  
JESSICA.....Sharon Washington

#### AT THE PRINCIPAL'S OFFICE

by Andre Parks, Age 10  
Director/Dramaturg: Peter Francis James

PRINCIPAL.....Mairo Driscoll  
ELI.....Christopher Dansby Fisher  
SOME KID.....Mairo Driscoll

#### THE PEACE OF ROOSHINICE

by Habiba Koroma, Age 12  
Director/Dramaturg: Karen Trott

NARRATOR.....Karen Evans-Kandel  
ERICA.....Becky Browder  
RUG.....Robert Joy  
TED.....Ted Turnblatt

Thank you for coming! If you are not on our mailing list (or if your address has changed), please fill out this form and give it to us on your way out, or mail it to the address below. We would also like to know if you would like to be of help to us in the future (primarily in the areas of fundraising, printing, office work and backstage). If so, please fill out your name, phone number and area(s) of interest below.

PLEASE ADD ME TO YOUR MAILING LIST:

Name \_\_\_\_\_

Address \_\_\_\_\_

\_\_\_\_\_ Zip \_\_\_\_\_

Phone \_\_\_\_\_

YES, I WOULD LIKE TO BE OF HELP:

Name \_\_\_\_\_

Daytime Phone \_\_\_\_\_

Area(s) of Interest \_\_\_\_\_

\_\_\_\_\_

I would be interested in being a crew head for your next production \_\_\_\_\_

If you would like to mail this, and/or a donation, you may do so to: The 52nd Street Project, 552 West 52nd St., New York, NY 10019 (212) 245-1350.

We have a brand new batch of 52nd Street Project T-Shirts (with the Shel Silverstein logo) on sale in the lobby for \$12.00. Half of this is tax-deductible. Great Gift Idea! Why not pick up several for the holidays???? Also on Sale are books posters and the Fabulous Flyer Chocolate Bar from the Official Chocolatier of the 52nd Street Project.

The 52nd Street Project gratefully acknowledges the support of the following foundations, corporations, government agencies and individuals: Altman Foundation, The Robert Bowne Foundation, The Bret Adams Agency, Citibank, N.A., The Liz Claiborne Foundation, Consolidated Edison, Nathan Cummings Foundation, D-B Trust, The Department of Youth Services, The Dramatist Guild Fund, Educational Foundation of America, The William and Mary Greve Foundation, The Hennessy Foundation, The Holland Lodge, The Kids Fund, The Eugene and Rose Klainer Family Foundation, The Marquis George MacDonald Foundation, The James Macdonald Foundation, Morgan Guaranty, Morgan Stanley and Company, The New World Foundation, The New York Times Company Foundation, Primerica Foundation, The Samuel and May Rudin Foundation, The Fan Fox and Leslie R. Samuels Foundation, St. Laurent Associates, The Threshold Foundation and

William R. Adams/J. Neogale  
Beth Adams  
Nancy Adelson/Clyton Lewis  
Lynette E. Albano  
Alan Arlin/Kay Mutschallert  
Margot Avery  
Joan Beckarach  
Aino Bailey/Charles Wright  
Deborah Baker  
Donatich Balletto/Neve Wilots  
Michael Bandier  
Carly Barnack  
Bon Barnack  
Miranda Barry  
Jessica Berman  
Christopher Beach  
Terry Belanger  
Caroline Berger  
Pat & Howard Berke  
Amy Birnbaum  
Andra Bishop  
Mr. & Mrs. G. Bissinger  
Sara & Ron Black  
Allison M. Bluhm  
Mark Blum  
Rita Brunson/Rona Garcia  
Rita & Fred Brooks  
Eric Brooks  
Rocky Brumber/Ted Houshall  
Gerrald M. Brown  
Deborah Brown  
David Buskin  
Celia Film Center  
Steven Callahan/Christina Dorn  
William Cardon  
Anna Carney  
Chris L. Chafetz  
Rachel Chasoff  
Elton Chasovvich  
Michael & Pamela Cospiga  
Louis Chofferman  
Marya & Fresser Cohn  
Ruth Cohen  
Richard J. Cohn  
The Cooper Committee  
Michael Cristofar  
Edie Cusick  
Neil Critchfield/Wendy Dastard  
Arthur Dantschik  
Helen Dantziger  
Leslie Dart  
Dale Davis/Harris Spyllos  
Carol & Booth Daubins  
Judy Deans  
Judith M. Deff  
Polly Draper  
Maize Driscoll

William Duff-Griffin  
Jack & Jane Dunbar  
Neil Eisenberg  
Elliot & Huzmar  
Alan P. Engel  
Wendy Etlinger  
Martha Evans/Pat LeVing  
Bill Fogarbakka/Catherine  
McChambers  
Peter Jay Fernandez  
Alexa A. Fogal  
Tom Fontana/Susan Lewis  
Janis Foxman/Caroline Aaron  
David Frankel  
Lisa Fry/John McLaughlin  
Linda P. Friedman  
The Ganey  
Thomas L. Getzheim  
Bernard Gerstein/Caro Cohen  
Jack Gilpin/Ann McDonough  
The Gochman  
Stanford Goldstein  
Edward & Susan Goldstein  
Susan Goldstein  
Helen & Peter Goldstein  
Christopher Gould  
Stephen Graham  
Reynold Gray  
In honor of Cara Green  
Susan Greenhill  
Celia Groer/Frances LaBerra  
Lyons Guggenheim  
Albert R. Gortzky  
Lyons Hallberg  
Jonathan Hanel  
Mina Hammer/Toni Rosta  
Carl, Kathleen &  
Zella Hammer  
Evan Handler  
Karyn Harding  
Gerald E. Harper  
Diane Haskell  
Janey Haynes/John Patrick  
Shanday  
Peter Hardrich  
Nichole Holburn  
Rob Hershmann  
Joan Hoffman  
Mary Holloway  
Billy Hopkins  
Irene Horowitz  
Thomas Hulse  
Amy Invernizzi/John Henry  
Davis

Yves-Andre Istel  
Mark Jacobs  
Sy Jacobs  
Cathy Lee Johnson  
Avak Pavlar Johnson  
Elmer Jones  
Bob Joy  
Michael Kane/Judith Reinick  
Ira Karasick/Neve Jacobson  
Mark J. Kennedy  
Alexa A. Fogal  
Patti Kipporson  
Tracy Knights  
Rita Kozl/Stephen Cohen  
Judy Kohn  
Marcia Joan Kurtz  
Lewis M. Kvit  
Penelope Lack  
Bill Lambert  
Gloria Landis  
Arthur E. Landl  
Joyce Lapson  
Jill Larson  
Kate Lear  
Priscilla Leans  
Georgette & Margon J. Levy  
Derek Livingston  
John Bulford Lloyd/Anne  
Twomey  
Liza Loesamer  
Mr. & Mrs. Stephen Lank  
John Lyons  
Peter & Marissa MacKikal  
Greg MacPherson  
Ronna Maffie/Peter DeCoste  
Michelle S. Magazzino  
Corry Mahoney/Herman Muller  
James Maloney  
Donald Margolis/Lynn Street  
Ann M. Martin  
Carman Mathews  
Ricki Matthews  
Joan McAllister  
Paul McCrone  
Frances McDermont  
Joanna Marks/David Dretzin  
Jon & Richard Marral  
Elsa Bretton Miller  
Patricia Murphy  
Lita Stanley Murphy  
Susan Marvey  
John G. Nordl

Liz Neebe  
Peter Neufeld  
Peter Newman  
Cynthia Nizan  
Elan Novack  
Peter O'Brien  
James L. Oakes  
Carol Ochs  
Kevin O'Rourke/Edith Thurber  
Henry D. Ostberg  
John & Kristina Pashaw  
F. Richard Pappas  
Elton Parker/Mack Lipkin  
Mr. & Mrs. Robert Parker  
David Parker  
Ruth Patarikin  
Thomas P. Peters  
Robert & Susan Phillips  
Helen & Peter Randolph  
Hub Rausch/Lisa Balshaw  
Tim & Tyana Ray  
Paul Reale  
Jacquelyn Reingold  
Jolie Ridge  
Elizabeth Rigg  
Lilla Robertson  
Gus Rogerson  
Bruce & Elton Roseman  
Mack Rosoff  
Robert de Rothschild  
Donald J. Rothschild  
Joyce Rodack  
Larry & Deborah Schiff  
Dore Schreiber  
Ken & Mary Ann Schuster  
James Selinger  
Angela & John Scrimmell  
Susan Shacter  
Barry Shapiro  
Murray Shapiro  
Barbara Baruch Shewl  
Brian Shoroff/Patty Dryden  
Bon & Glady Slegler  
Judith Siegman  
Joey Silverman  
Meg Simon  
Jacqueline Simon  
Barry Singer  
Tom Singer  
Isadora & Judith Singer  
Lois Smith

Susan Solomon  
Erica Spallman-Silverman  
Jerome Spina, Jr.  
Florence Stanley/Martin  
Newman  
Robert Stecker  
Jerry Steiner  
Byam Stearns/Robin Tighman  
Byam K. Stearns, Sr.  
Tom & Marlene Stewart  
Jay Javits Stewart  
J. Frederick Stillman, III  
Andrew Swao/Elise Taylor  
Daniel Swao  
Anna Swift  
Jay Tarsas  
Lill Taylor  
Michael Thomas  
Stanley & Gloria Thomas  
Joan Yell Thorne  
Tracy Thorne  
Catherine C. Tracy  
Kathleen Turner  
Judith Tyggard  
Loana Valerona  
Peter Valerona/Charles Goldberg  
Scott Warren  
Emma Walton/Stephen Hamilton  
Mr. & Mrs. Charles G. Ward, III  
Bruce & Christine Wasserman  
John Waldman/Lisa Colabura  
Im Waltzman  
Mitchell A. Waltzer  
Betty West  
Mr. & Mrs. Robert Wilder  
Donald Windham  
Gwen Winston  
Kathryn & Robert Wolfe  
Margaret L. Wolf  
Joan & Dutch Wolf  
Andrew Walk  
Joanna Woodward  
Jeff & Joanne Yess  
Satos Yamaguchi  
Joan Zarish/Mark Gould

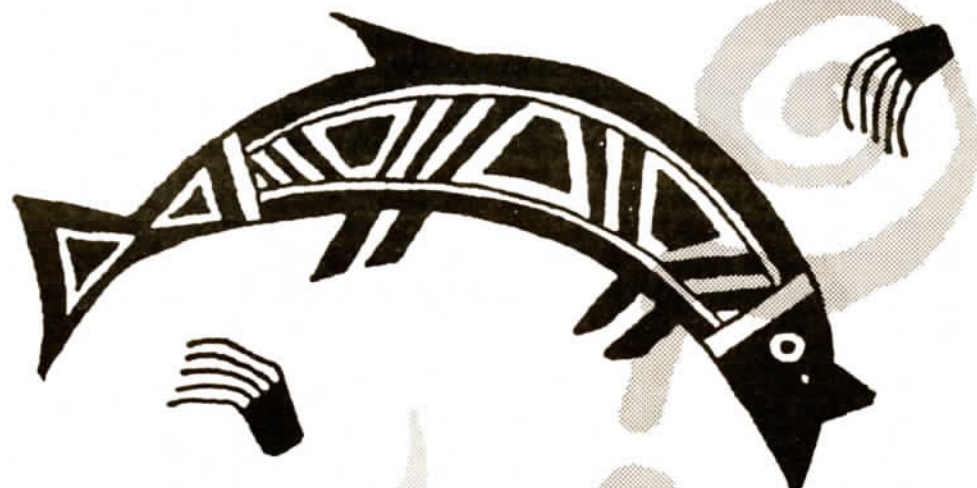

THE 52ND STREET PROJECT PRESENTS  
**THIS LAND IS WHOSE LAND?**



FRIDAY, MARCH 27TH  
SATURDAY, MARCH 28TH  
SUNDAY, MARCH 29TH

\*  
THE ENSEMBLE STUDIO THEATRE



In addition the 52nd Street Project is truly grateful to the many individuals who have made gifts of less than \$100. THIS LAND IS WHOSE LAND? is also made possible in part, with public funds from the New York State Council on the Arts and the New York City Department of Cultural Affairs. The 52nd Street Project gratefully acknowledges their support.

THE 52ND STREET PROJECT PRESENTS  
**THIS LAND IS WHOSE LAND?**

### Project Staff

Willie Reale, Artistic Director  
Carol Ochs, Executive Director  
Jenny Gersten, Assistant to the Directors  
Daniel Judah Sklar, Playmaking Director  
Pamela Coody, Project Intern  
Leslie Einhorn, Project Intern

Michael Bernard, Playmaking Volunteer  
Linda Stein, Playmaking Volunteer  
Anne Swift, Playmaking Volunteer  
Tracy Thorne, Playmaking Volunteer  
Edith Thurber, Minister of Education

### Production Staff

Kevin Joseph Roach, Set Designer  
Greg MacPherson, Lighting Designer  
Tracy Knights, Assistant Lighting Designer  
Katherine K. Lumb, Stage Manager  
Iris A. Brown, Graphics  
Mina Hammer, Slides & Projectionist  
Colorforms Designers:  
Patty Dryden & her Parsons' Class -  
Amè Balassanian, Connie Bourin, Emily Chase,  
David Laforque, Bill Sharp, Agatha Sohn, Andy  
Swift, Josh Tecu, John Vollaro, Violet Walker,  
Dianne Wenz, Sunny Woodall, Chris Young  
Helen Toth, Costume Designer  
Michael Sancineto, Costume Designer  
Paula Longendyke, Props Designer  
Sheila Kehoe, Daisy Heads  
Jeremy Gray, Sound & Synthesizer  
Tracy Knights, Light Board Operator  
Susan Murray, Colorforms Crew Chief  
Lori Hirschman, Furniture Crew Chief  
Debbie Katzman, Props Crew  
Basil Boatwright, Running Crew

Shawn Sinceno, Running Crew  
Shawndale Ziegler, Colorforms Crew  
Angela Trento, House Manager  
Leslie Einhorn, House Manager  
Laura Callahan, House Crew  
Jeff Chrczcon, House Crew  
Jennifer Earle, House Crew  
Ann Kahn, House Crew  
Rikki Matthews, House Crew  
Lane Mitchell, House Crew  
Minna Rose, House Crew  
Magnus Ragnarsson, Light Hang  
Tom Schall, Light Hang  
Paul Leishman, Load-in Chief  
Andre Anson, Set Crew  
Mike Doyle, Set Crew  
Jeremy Gray, Set Crew  
Lori Hirschman, Set Crew  
Katherine K. Lumb, Set Crew  
Daniel Swee, Chef Boyardi  
Nashormeh Lindo, Mural Coordinator

The 52nd Street Project is an independent non-profit organization that operates with the cooperation of the Police Athletic League and the Ensemble Studio Theatre. The Project brings inner-city children together with professional theater artists to create theater. The THIS LAND IS WHOSE LAND? production is a part of our Playmaking program that is designed to teach children how to write plays. After eight weeks of classes, each child is given two actors, a theme and a director who guides him or her through the writing of a play during a weekend in the country. These are the fruits of their labors.

### Board of Directors

Ben Barenholtz	Stephen Graham	Carol Ochs
Rachel Chanoff	Heidi Landesman	Willie Reale
Marsue Cumming, <i>ex-officio</i>	James McDaniel	Pamala Tyson
Wendy Ettinger, Chairperson	Frances McDormand	Laura Valeroso
Louis P. Friedman	Patricia M. Murphy	

### Special Thanks To:

Allison, Keith and the staff of P.A.L.'s Duncan Center; Curt Dempster, Dominick Balletta, Andrew Kaplan, Kevin Confoy and the staff of E.S.T.; Greg MacPherson; Barbara P. Ettinger; Fran McDormand and Joel Cohen; Phyllis Binaghi, Carol Bowker and Colorforms; Bernard Gersten, Susan Knox and Lincoln Center Theater, T.D.F. Costume Collection; Jonathan Green at Playwrights Horizons; Mary Ann Smith at Manhattan Theatre Club; Edmund Felix at Brooklyn College Department of Theatre; Tom Schall; Magnus Ragnarsson; Carol Rosegg; Michael Bernard; Jeffrey Gross; Dawn Jackson; Debbie Katzman; Rikki Matthews; Barbara McCrane; Michaela Murphy; Annette Myrie; Karen Myrie; Andre Parks; Allison Zimet; Daniel Swee; Helen Toth and Michael Sancineto; Neil Mazzella, Chris, Sonia, and Hudson Scenic Studios; Rob Reale; Tom Reale.

### In-Kind Contributions:

The Vineyard Theatre; Police Athletic League; Ensemble Studio Theatre; Hudson Scenic Studios; Bruce Cohen and Associates; Colorforms; Shays & Murphy; Sanford Goldstein; Bernhardt/Fudyma Design Group; Donald Marcus; Stephen Graham; Lili Taylor; Tom Reale; Martha Swope Studios.

Thank you for coming! If you are not on our mailing list (or if your address has changed), please fill out this form and give it to us on your way out, or mail it to the address below. We would also like to know if you would like to be of help to us in the future (primarily in the areas of fundraising, printing, office work and backstage). If so, please fill out your name, phone number and area(s) of interest below.

PLEASE ADD ME TO YOUR MAILING LIST:

Name \_\_\_\_\_

Address \_\_\_\_\_

\_\_\_\_\_ Zip \_\_\_\_\_

Phone \_\_\_\_\_

YES, I WOULD LIKE TO BE OF HELP:

Name \_\_\_\_\_

Daytime Phone \_\_\_\_\_

Area(s) of Interest \_\_\_\_\_

\_\_\_\_\_

I would be interested in being a crew head for your next production \_\_\_\_\_

If you would like to mail this, and/or a donation, you may do so to: The 52nd Street Project, 552 West 52nd St., New York, NY 10019 (212) 764-1379.

We have a brand new batch of 52nd Street Project T-Shirts (with the Shel Silverstein logo) on sale in the lobby for \$12.00. Half of this is tax-deductible. Great Gift Idea! Why not pick up several for Spring???. Also on Sale are books posters and the Fabulous Flyer Chocolate Bar from the Official Chocolatier of the 52nd Street Project.

## THE 52ND STREET PROJECT'S THIS LAND IS WHOSE LAND?

Ensemble Studio Theatre  
March 27, 28, 29, 1992

### ACT I

#### PEOPLE CAN CHANGE

by Erse Britto, Age 11  
Director/Dramaturg: Delroy Lindo

RED.....Peter Jay Fernandez  
CHIEF.....Ken Little Hawk  
JOHN.....Gus Rogerson

#### THIS LAND IS THE GREAT SPIRIT'S

by Elisa Mohamed, Age 10  
Director/Dramaturg: Celina Davis

ROY.....Christopher Dansby Fisher  
JOY.....June Ballinger  
GEORGE.....Ken Little Hawk  
ANNOUNCER.....Willie Reale

#### DARTHULA'S PLAY

by DARTHULA HARVEY, Age 10  
Director/Dramaturg: Judy Dennis

ROSE.....Pamala Tyson  
HERMAN.....Bruce MacVittie  
MR. LOVELAND.....Ken Little Hawk  
DOUG.....Bruce MacVittie

## THE LOST GIRLS

by Iasha Anderson, Age 14

Director/Dramaturg: Roma Maffia

ANGELICA..... J. Smith-Cameron

MARYLOU..... Erika Alexander

MAN..... Ken Little Hawk

## POTLATCH

by Raymond Harold, Age 10

Director/Dramaturg: Candido Tirado

POTLATCH..... Karen Kandel

CHRISTOPHER..... Paul McCrane

KEN..... Ken Little Hawk

## ACT II

## BETRAYED

by Omar Rose, Age 12

Director/Dramaturg: Michael Bernard

SLICK RICK..... Jerry McGill

QC..... Frances McDormand

CHIEF TURAWA..... Ken Little Hawk

## INDIAN DANCES

by Claudia Vasquez, Age 10

Director/Dramaturg: Elizabeth Margid

SPIRIT DANCER..... Sandye Wilson

KEN..... Ken Little Hawk

COWBOY..... Susan Willerman

## ACT II (cont.)

## MIXED FEELINGS

by Joell Soto, Age 11

Director/Dramaturg: Peter Francis James

PEDDLER..... Ken Little Hawk

JOHN..... Larry Nathanson

POCAHONTAS..... Carol Clarke

RAGING WATER..... Ken Little Hawk

## THE STORY OF THE CHANGING MAN

by Keith Anderson, Age 9

Director/Dramaturg: Daniel Judah Sklar

LYDIA..... Jane Muddyman

THE CHANGING MAN..... Brian Chandler

JOCK..... Ken Little Hawk

## GOD'S GIFT

by Alex Bess, Age 14

Director/Dramaturg: Chris Ceraso

KEN..... Ken Little Hawk

DAISY..... Kevin Geer

FRANKIE..... Shawn Elliott





TRIPLE

THREAT

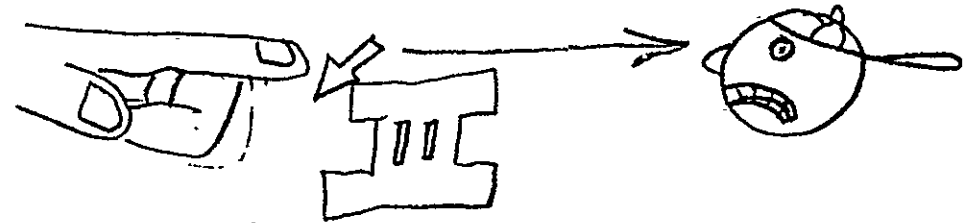

Laugh it's  
a joke

OH

NO!

not again

The 52nd Street Project Presents  
**TRIPLE THREAT - PART III**

The 1991 Replay Plays  
April Fool's Day, 1992

The Ensemble Studio Theatre - New York City

**Project Staff**

Willie Reale, Artistic Director  
Carol Ochs, Executive Director  
Daniel Judah Sklar, Playmaking Director  
Michaela Murphy & Larry Nathanson, "Triple Threat" Artistic Directors  
Jenny Gersten, Just Kidding  
Judy Dennis, Professor of Directing

**Production Staff**

Lori Hirschman, Stage Manager	Stage Crew: Jill Barbaosa, Alex Bess, Travis
Jennifer Gilbert, Lighting Mentor	Crafton, Myriam Varela, Maritza Welsh
Mina Hammer, Art Director	Andre Parks, House Crew
Paul Leishman, Set Magnum	Danny Noonan, Cover Design
Danny Noonan, Light Board Operators	Art Crew: Danny, Victor, Annette, Angela,
Tim Murphy, Slide Operator	Amy, Jill, Myriam, Maritza, Joanne,
Barbara McCrane, Sound Mentor	Fernando, Erse Britto, Kulondi, Samona,
Debbie Katzman, Crew Mentor	Lori, Karen, Tony, Orlando and Dawn
Lori Shearer, Assistant Extraordinaire	Karen Myrie, Assistant to the Artistic Directors

The 52nd Street Project provides adult theater professionals with the opportunity to work with children in order to sample all the new kinds of candy that today's generation consumes. *NOT!...April Fool's!* The 52nd Street Project really brings inner-city kids together with professional theater artists to do theater. All of the Replay writers attended Daniel Judah Sklar's 8-week Playmaking course and wrote plays for the productions of "HumanNature" or "The Dream Theme" in 1990. In February of last year, they all returned to class for an 8-week Replay course which took them to the next step in playwriting. In April, the Project took 15 Replay kids with an equal number of adults to Tannersville for a weekend, where each play was given a rehearsed reading and critique with professional actors. Upon return to New York, the kids attended a week-long re-write class and six-week directing seminar. The plays were then slated for one of three productions, and for the third time in Project history, the plays are "all-kid" produced - writers, directors, actors and crew. Triple Threats Part One and Two were in August and November respectively; Part Three is the last of the Replay productions and The Project would like to publicly state how un-threatening and delightful this event has been.

**Special Thanks to:** The P.A.L. staff; Curt Dempster, Dominick Balletta, Kevin Confoy, Andrew Kaplan and the Ensemble Studio Theatre, the strike crew, whoever you are, and the kids' parents.

**TRIPLE THREAT - PART III**

**BEST FRIENDS** Directed by Shirley Rumierk  
Written by Eric Santoni Adult Mentor, Barbara McCrane

The Incredible Punisher ..... Jamar Williams  
Ultron ..... Eli Barbosa  
Coach/God..... Luis Santoni

**LOOKS ARE DECEIVING** Directed by Joanne Ramirez  
Written by Victor Rojas Adult Mentor, Bert Goldstein

Warlock..... Eric Santoni  
Pindarella..... Lori Quinones  
Prince/Gremlin Ice..... Fernando Ramirez

**FAT BOY** Directed by Ronnie Noonan  
Written by Yolando Maldonado Adult Mentor, Polly Admas

Tom..... Wendell Borrero  
Kristy..... Annette Myrie  
Mom..... Fran-Marie Fargado

**SISTERS** Directed by Fran-Marie Fargado  
Written by Lori Quinones Adult Mentor, Susan Willerman

Annabeth..... Samona Squire  
Anna..... Dawn Jackson  
Bobby..... Victor Rojas

**TOO OLD!** Directed by Kulondi Frier  
Written by Shirley Rumierk Adult Mentor, Michaela Murphy

Mack..... Dannie Noonan  
Zack..... Richard Myrie  
Store Keeper..... Kulondi Frier  
Keds I..... Shirley Rumierk  
Reebok I..... Karen Myrie  
Nike I..... Ronnie Noonan  
Reebok II..... Luis Santoni  
Nike II..... Joanne Ramirez  
Linda..... Yolanda Maldonado

The 52nd Street Project gratefully acknowledges the support of the following foundations, corporations, government agencies and individuals: The Altman Foundation, The Bret Adams Agency, Citibank, N.A., The Liz Claiborne Foundation, Consolidated Edison, Nathan Cummings Foundation, D-B Trust, The Dammann Fund, The Department of Youth Services, The Dramatists Guild Fund, Educational Foundation of America, The Florence Gould Foundation, The William and Mary Grave Foundation, The Hemessy Foundation, The Holland Lodge Foundation, The Kids Fund, The Eugene and Rosa Kleiner Family Foundation, The MCJ Foundation, The Marquis George MacDonald Foundation, The James Macdonald Foundation, The Ann M. Martin Foundation, Morgan Guaranty Trust Co., Morgan Stanley and Company, The William Morris Agency, The New World Foundation, The New York Times Company Foundation, Primerica Foundation, The Samuel and May Rudin Foundation, The Fan Fox and Leslie R. Samuels Foundation, St. Laurent Associates, The Threshold Foundation, The Lila Acheson Wallace Theater Fund, The Wasserstein Parolla Foundation, The West Bank Cafe and

William R. Adams/J. Noegee	Carol & Booth Dookins	Jane Hoffman	Else Bretton Miller	Barry Singer
Beth Adams	Judy Dennis	Mary Holloway	Patricia Murphy	Tom Singer
Nancy Adelson/Clayton Lewis	Jodi SH. Doff	Billy Hopkins	Lisa Stanley Murphy	Isadore & Judith Singer
Lynette E. Allison	Polly Draper	Irwin Harowitz	Susan Murray	Lois Smith
Alan Arfa/Kay Matschullat	Maira Driscoll	Thomas Hulca	John G. Nardi	Susan Solomon
Margot Avery	William Duff-Griffen	Amy Inrocasa/John Henry	Liz Nealon	Erica Spellman-Silverman
Jan Bocharach	Jack & June Dunbar	Davis	James L. Nederlander	Jerome Spina, Jr.
Anne Bailey/Charles Wright	Mad Esenberg	Yves-Andre Isal	Peter Neufeld	Florence Stanley/Martin
Deborah Baker	Elliott & Hammer	Mark Jacobs	Peter Newman	Newman
Dominick Balletta/Hlene Wilots	John P. Engel	Sy Jacobs	Cynthia Nixon	Robert Stocker
Michael Bandler	Wendy Ellinger	Gindy Lea Johnson	Eliot Novack	Jerry Sterner
Cathy Baranck	Martha Evans/Per LaFving	Avah Pevlor Johnson	Peter O'Brien	Byam Stevens/Robin
Ben Barenholtz	Bill Fogerbakke/Catherine	Elinor Jones	James L. Oakes	Tighman
Miranda Barry	McClenahan	Bob Joy	Carol Ochs	Byam K. Stevens, Sr.
Jessica Baumman	Peter Jay Fernandez	Michael Kane/Judith Rudnick	Kevin O'Rourke/Edith	Tom & Maureen Stewart
Christopher Beach	Alexa A. Fogel	Ira Karasick/Nora Jacobson	Thurber	Joy Jovits Stewart
Terry Belanger	Tom Fantana/Sogan Lewis	Mark J. Kennedy	Henry D. Osberg	J. Frederick Skilman, III
Corinne Berger	Jamie Foreman/Caroline	Patti Kipperman	John & Kristine Pankow	Andrew Swao/Elise Taylor
Pat & Howard Berka	Aaron	Tracy Knights	F. Richard Pappas	Daniel Swao
Amy Birnbaum	David Frankel	Rita Knox/Stephen Cohen	Eliot Parker/Mack Lipkin	Anne Swift
Andre Bishop	Lisa Frey/John McLoughlin	Judy Kuhn	David Peterkin	Mr. & Mrs. Robert Parker
Mr. & Mrs. G. Bissinger	Louis P. Friedman	Marcia Jean Kurtz	David Peterkin	LRI Taylor
Susan & Ron Block	Ma Ganey	Lewis M. Kwit	Ruth Peterkin	Michael Thomas
Allison M. Blinken	Thomas L. Gazzonis	Pamela Lock	Thomas P. Peters	Stanley & Gloria Thomas
Mark Blum	Bernard Garsten/Cora Cohen	Bill Lambert	Robert & Susan Phillips	Joan Vail Thorne
Risa Bramon/Rene Garcia	Jack Galpin/Ann McDonough	Gloria Landes	Helen & Peter Randolph	Tracy Thorne
Rita & Fred Brooks	The Godmans	Arthur E. Landi	Nob Rauch/Lisa Balshaw	Catherine C. Tracy
Eric Brooks	Sanford Goldstein	Joyce Lapenn	Tim & Tyson Ray	Kathleen Turner
Becky Browder/Ted Neustadt	Edward & Susan Goldstein	Jill Larson	Paul Reale	Judith Tygard
Garrett M. Brown	Susan Goldstein	Kate Laar	Jacquelyn Ringgold	Laura Valeroso
Deborah Brown	Helen & Peter Goldstein	Joshua Lahrer	Julie Ridge	Peter Valeroso/Charles
David Buskin	Christopher Gould	Priscilla Lanes	Elizabeth Rigg	Goldberg
Cafe Film Center	Mark Gould	Georgette & Morgan J. Levy	Lillie Robertson	Wendy M. Vanden Heuvel
Joel Coen	Stephen Graham	Derek Livingston	Gus Rogerson	Scott Waara
Steven Callahan/Christine	Rosalind Gray	John Bedford Lloyd/Anne	Bruce & Ellen Roseman	Emma Walton/Stephen
Dunn	In honor of Cara Greene	Twomey	Mack Rossloff	Hamilton
William Carden	Susan Greenhill	Lisa Laesemore	Robert de Rothschild	Mr. & Mrs. Charles G. Ward,
Anne Carney	Colin Greer/Frances LaBarre	Mr. & Mrs. Stephen Lumb	Donald J. Rothschild	III
Claire L. Chafee	Lynne Gugenheim	John Lyons	Joyce Rudnick	Bruce & Christien Wasserstein
Rochal Charnoff	Albert R. Gurney	Peter & Marsue Macfical	Larry & Deborah Schiff	John Waidman/Lila Coleburn
Eliot Chanowitz	Lynne Halliday	Greg MacPherson	Dan Schneider	Ira Waitzman
Michael & Pamela Chapiga	Jonathan Hamel	Roma Maffia/Peter DeCasio	Kan & Mary Ann Schuster	Michael A. Waitzner
Lois Chalfarano	Mina Hammer/Tom Reale	Michelle S. Magazine	Seret Scott	Betsy West
Marya & Fraser Cohn	Carl, Kathleen &	Carry Maloney/Hermes Malloa	Angela & John Scrimant	Mr. & Mrs. Robert Wilder
Ruth Cohen	Zella Hammer	James Maloney	Susan Shacter	Donald Windham
Richard J. Cohn	Evan Handler	Donald Margulies/Lynn Street	Barry Shapiro	Gwan Winston
The Cooper Committee	Kamrya Harding	Ann M. Martin	Murray Shapiro	Kathryn & Robert Wolfe
Michael Cristofler	Gerard E. Harper	Carman Mathews	Bernice Baruch Shawl	Margaret L. Wolf
Edla Cusick	Diana Haskell	Rikki Matthews	Brian Sberell/Patty Dryden	Joan & Dutch Wolf
Neil Cuthbert/Wendy Dastool	Jayne Haynes/John Patrick	Joan McAllister	Ben & Ginny Siegler	Andrew Walk
Arthur Dantchik	Shanley	Paul McCrane	Judith Siegman	Joanne Woodward
Maia Danziger	Peter Herdrich	Frances McDormand	Joey Silverman	Jeff & Janine Yass
Leslie Dori	Michele Heilbrun	Joanna Merlin/David Dretzin	Meg Simon	Sotis Yannopoulos
Dale Davis/Harris Spytkos	Rob Harshman	Jan & Richard Merril	Jacqueline Simon	Janel Zarich

WHO'S WHO?

THE MISTAKEN IDENTITY PLAYS

THE POUGHKEEPSIE PLAYS

July 9th ☾ July 10th ☽ July 11th ☾ July 12th

THE ENSEMBLE STUDIO THEATRE

In addition the 52nd Street Project is truly grateful to the many individuals who have made gifts of less than \$100. WHO'S WHO? is also made possible in part with public funds from the New York State Council on the Arts and the New York City Department of Cultural Affairs.

The 52nd Street Project Presents

## WHO'S WHO?

The Mistaken Identity Plays

from Poughkeepsie

July 9, 10, 11, 12, 1992

The Ensemble Studio Theatre - New York City

### Project Staff

Willie Reale, Artistic Director

Carol Ochs, Executive Director

Jenny Gersten, Assistant to the Directors

Daniel Judah Sklar, Playmaking Director

June Ballinger, Director - 52nd Street at Graham-Windham

Susan Willerman, Instructor - 52nd Street at Graham-Windham

Gwyneth Kirkbride, Administrative Intern

Jerod Gunsberg, Production Intern

### Production Staff

Fred Carl, Music Director

Kevin Joseph Roach, Set Designer

Greg MacPherson, Lighting Designer

Jennifer Harvey, Costume Designer

Katherine Lumb, James Marr, Stage

Managers

Terry Cain, Pianist

Iris A. Brown, Graphics/Slides

Mina Hammer, Jenny Gersten, Slides

John Vollaro, Colorforms

Katherine Lumb, Props

Tracy Knights, Asst. to the Lighting

Designer

Shane Tilston, Light Board Operator

Jeremy Gray, Sound/Synthesizer

Joanne Ramirez, Furniture

Shirley Rumierk, Slide Operator

Paul Gruen, Load-In

Jerod Gunsberg, Load-In

James Marr, Load-In

Evan Miller, Load-In/Light

Karen Myrie, Running Crew

Angela Trento, Running Crew

Kerrigan Webb, Running Crew

Laura Webb, Running Crew

Karin Barry, House Manager

Jeff Chrzczonek, House Crew

Jessica Dorfman, House Crew

Beth Emelson, House Crew

Kaarin von Herrich, House Crew

Elise Mogensen, House Crew

Gwyneth Kirkbride, Kid Wrangler

Joanne Ramirez, Junior Counselor

### Board of Directors

Ben Barenholtz

Rachell Chanoff

Patricia Cumming, *ex-officio*

Wendy Ettinger, Chair

Louis P. Friedman

Stephen Graham

Heidi Landesman

James McDaniel

Frances McDormand

Patricia M. Murphy

Carol Ochs

Willie Reale

Pamala Tyson

Laura Valeroso

### Special Thanks To:

Curt Dempster and The Ensemble Studio Theatre; Allison, Patty, Tito, Raymond and the P.A.L.; Mark, Max, Leslie, Bill, Keishya, Jacki, Beth, the residents of Josselyn House, and the entire New York Stage and Film Gang; Fran McDormand & Joel Coen; Wendy Ettinger & Derek McLane; David Sneddon, Kristine Fleisher and The Fairway Market (which as we know is like no other market); John Paris and Flyer Chocolate Bars (which as we know is like no other Chocolate Bar); Vassar College; Edith Thurber; Paul Gruen; Bernard Gersten & Susan Knox; Jennifer Earle, Chris Kelly, Eric Berkal, Jeffrey Gross, Susan Murray; New York Theatre Workshop; Chefs: Iris Brown, Joe White, Eric Karpeles, Mike Sell, Peter Herdrich, Susan Vitucci; Hunter & Parker Cain; and Bruce MacVittie for taking care of the leftovers.

### In-Kind Contributions:

Police Athletic League; Ensemble Studio Theatre; New York Stage & Film; Ben Barenholtz, Hudson Scenic Studios, Inc.; Colorforms; Bruce Cohen & Associates; Lincoln Center Theater, Shays & Murphy; Sanford Goldstein; Bernhardt Fudyma Design Group; Stephen Graham.

The 52nd Street Project is an independent, nonprofit organization that operates with the cooperation of The Ensemble Studio Theatre and the Police Athletic League. The Project brings inner-city children together with professional theatre artists to create theatre. This summer, our One-on-One program will take 20 kids away for one-week stays on Block Island and in Poughkeepsie where they are matched with professional writer/actors who write plays for them to perform together.

**WHO'S WHO?**  
The Mistaken Identity Plays  
The Poughkeepsie One-on-Ones  
July 9, 10, 11, 12, 1992

"WHO'S WHO?" - Company

**LUNCH TIME**

Written by Donald Margulies \* Directed by Jeff Williams  
Written for Victor Rojas, Age 12

Jack ..... Victor Rojas  
Mike ..... Jeff Williams  
The Girl ..... Angela Golden  
"Tuna On Rye" - Lyrics by Willie Reale, Music By Fred Carl

**THE ASSOCIATION GAME**

Written and Directed by Karen Trott  
Written for Angela Golden, Age 9

Daphne ..... Angela Golden  
Bridget ..... Karen Trott  
"The Association Game" - Lyrics by Karen Trott, Music by Fred Carl

**PLAY FOR THREE ACTORS**

Written and Directed by Carl Capotorto  
Written for Amy Barbosa, Age 8

Carl ..... Carl Capotorto  
Amy ..... Amy Barbosa  
Sidney ..... To Be Announced  
"Give 'Em Show" - Lyrics by Carl Capotorto, Music by Fred Carl

**ELI'S COMING**

Written by Lewis Black \* Directed by Kevin O'Rourke  
Written for Eli Barbosa, Age 10

Announcer ..... Kevin O'Rourke  
Eli ..... Eli Barbosa  
Stevie the Stevester ..... Kevin O'Rourke  
"Eli's Coming" - Music & Lyrics by Laura Nyro

**TAKING MY SELF TO THE MOVIES**

Written and Directed by Willie Reale

Written for Eddie Zambrano, Age 10

Adult. . . . . Willie Reale

Kid. . . . . Eddie Zambrano

"Take Your Self To The Movies" - Lyrics by Willie Reale, Music by Fred Carl

• INTERMISSION •

**THE BLUE PLATE SPECIAL**

Written and Directed by Demitri Corbin

Written for Mary Vamvoukakis, Age 7

Mary. . . . . Mary Vamvoukakis

Max Jackson . . . . . Demitri Corbin

Cook/Announcer. . . . . Kevin O'Rourke

"I'm Just A Girl Named Mary" - Lyrics by Demitri Corbin, Music by Mary

Vamvoukakis & Fred Carl

"Mary" - Music & Lyrics by George M. Cohan

**LOOKING FOR THE STAR**

Written by Roma Maffia & Carl Capotorto \* Directed by Roma Maffia

Written for Jill Barbosa, Age 12

Cleopatra. . . . . Jill Barbosa

Dr. X . . . . . Roma Maffia

"Queen of the Nile" - Lyrics by Roma Maffia, Music by Fred Carl

**I WANT MY MOMMY BACK**

Written by Candido Tirado \* Directed by Janet Zarish

Written for Raymond Harold, Age 11

Son. . . . . Raymond Harold

Mother. . . . . Janet Zarish

"Give Me Back My Mommy" - Lyrics by Willie Reale, Music by Fred Carl

**DANNY & THE SEAWEED MONSTER**

Written by Jon Robin Baitz \* Directed by Pamala Tyson

Written for Danny Noonan, Age 11

Danny. . . . . Danny Noonan

Hilda Gross. . . . . Pamala Tyson

**MIXED COLORS**

Written by Peter Hedges \* Directed by Peter Hedges & Susan Bruce

Written for Fernando Ramirez, Age 11

Old Man In The Park/Carlos . . . . . Fernando Ramirez

Girl In The Park/Principal Pat. . . . . Susan Bruce

Music & Lyrics by Mr. Hedges, Age 30

Thank you for coming! If you are not on our mailing list (or if your address has changed), please fill out this form and give it to us on your way out, or mail it to the address below. We would also like to know if you would like to be of help to us in the future (primarily in the areas of fundraising, backstage and printing). If so, please fill out your name, phone number and areas of interest below.

**PLEASE ADD ME TO YOUR MAILING LIST:**

NAME \_\_\_\_\_

ADDRESS \_\_\_\_\_

\_\_\_\_\_ Zip \_\_\_\_\_

PHONE \_\_\_\_\_

**YES, I WOULD LIKE TO BE OF HELP:**

NAME \_\_\_\_\_

DAYTIME PHONE \_\_\_\_\_

AREA(S) OF INTEREST \_\_\_\_\_

**ON SALE IN THE LOBBY !!!**

52nd Street Project T-Shirts with Shel Silverstein Logo: \$12.00

"Playmaking" by Daniel Judah Sklar: \$13.00

10th Anniversary Commemorative Poster by Iris A. Brown: \$10.00

Flyer Chocolate Bar \$1.00

Remember, one-half of sale price is tax-deductible!

If you would like to mail this (and you're always welcome to enclose a tax-deductible contribution), you can send it to:

The 52nd Street Project, 552 West 52nd Street, New York, NY 10019, (212) 764-1379.

The 52nd Street Project gratefully acknowledges the support of the following foundations, corporations, government agencies and individuals: The Altman Foundation, The Bret Adams Agency, Citibank, N.A., The Liz Calborne Foundation, Consolidated Edison, Nathan Cummings Foundation, D-B Trust, The Dunham Fund, The Department of Youth Services, The Dramatists Guild Fund, Educational Foundation of America, The Florence Gould Foundation, The William and Mary Greve Foundation, The Homessy Foundation, The Holland Lodge Foundation, The Kids Fund, The Eugene and Rose Klainer Family Foundation, The MCJ Foundation, The Marquis George MacDonald Foundation, The James MacDonald Foundation, The Ann M. Martin Foundation, Morgan Guaranty Trust Co., Morgan Stanley and Company, The William Morris Agency, The New World Foundation, The New York Times Company Foundation, Primorica Foundation, The Samuel and May Rudin Foundation, The Fun Fox and Leslie R. Samuels Foundation, St. Laurent Associates, The Threshold Foundation, The Life Acheson Wallace Theater Fund, The Wessorsstein Perella Foundation, The West Bank Cafe and

William R. Adams/J. Naagick  
Beth Adams  
Nancy Adams/Clyton Lewis  
Lynette E. Allison  
Alan Arfio/Kay Mutschall  
Margot Avery  
Joan Bacharach  
Anna Bailey/Charles Wright  
Deborah Baker  
Dominick Ballante/Hana Wilentz  
Michael Barder  
Cathy Baruch  
Ben Baruchwitz  
Miranda Barry  
Jessica Bauman  
Christopher Beach  
Terry Balanger  
Caroline Berger  
Pat & Howard Berka  
Amy Birnbaum  
Andrea Bishop  
Mr. & Mrs. G. Bissinger  
Susan & Ron Block  
Allison M. Blonkin  
Mark Blum  
Rhea Bronson/Rene Garcia  
Rita & Fred Brooks  
Eric Brooks  
Bucky Browder/Ted Huestadt  
Garrett M. Brown  
Deborah Brown  
David Buskin  
Cafe Film Center  
Joel Coon  
Steven Callahan/Christine  
Dunn  
William Cardon  
Anne Carney  
Chitra L. Chafetz  
Rachel Chonoji  
Ethan Chomovitch  
Michael & Pamela Chupiga  
Luis Cheliffarano  
Marya & Fraser Cahn  
Ruth Cohen  
Richard J. Cohn  
The Cooper Committee  
Michael Cristofor  
Edna Crisick  
Neil Cuthbert/Wendy Dastoul  
Arthur Dancik  
Mark Danciger  
Leslie Dart  
Dale Davis/Harris Spylbes

Carol & Booth Danks  
Judy Daniels  
Joel SH. Doff  
Polly Draper  
Mauro Driscoll  
William Duff-Griffin  
Jack & Jane Dunbar  
Noel Emsberg  
Elliott & Hammer  
John P. Engel  
Wendy Erlinger  
Martha Evans/Pat LeVing  
Bill Fagan/John/Catherine  
McClanahan  
Peter Jay Fernandez  
Alexa A. Fogel  
Tom Fontana/Susan Lewis  
Janice Foreman/Caroline  
Aaron  
David Frankel  
Lisa Fry/John McLoughlin  
Louis P. Friedman  
Ma Ganey  
Thomas L. Gaziano  
Bernard Gersten/Cara Cohen  
Jack Gilpin/Ann McDonough  
The Godsmans  
Samford Goldstein  
Edward & Susan Goldstein  
Susan Goldstein  
Helen & Peter Goldstein  
Christopher Gould  
Mark Gould  
Stephen Graham  
Rosalind Gray  
In honor of Cara Greene  
Susan Greenhill  
Collin Groer/Francois LaBarre  
Lynne Gupenheim  
Albert R. Gurnsey  
Lynne Hallday  
Jonathan Harrel  
Mina Hammer/Tom Rade  
Carl, Kathleen &  
Zella Hammer  
Evan Hamsher  
Kamryn Harding  
Garrett E. Harpur  
Diana Hesckall  
Jayne Heyman/John Patrick  
Shanley  
Peter Hardich  
Michelle Hoffbrun  
Rob Harshman

Jane Hoffman  
Mary Holloway  
Billy Hopkins  
Irwin Horowitz  
Thomas Hulca  
Amy Inrocasa/John Henry  
Davis  
Yves-Andre Ival  
Mark Jacobs  
Sy Jacobs  
Cindy Lee Johnson  
Avrah Parker Johnson  
Elmer Jones  
Bob Joy  
Michael Kama/Judith Rudrick  
Ira Karasick/Wera Jacobson  
Mark J. Kennedy  
Patti Kipperman  
Tracy Knights  
Rita Knox/Stephen Cohen  
Judy Kahn  
Marcia Joan Kurtz  
Lewis M. Kniff  
Pamela Luck  
Bill Lambert  
Gloria Landes  
Arthur E. Landt  
Joyce Lapann  
Jill Larson  
Kate Lutz  
Joshua Lehrer  
Priscilla Lanes  
Georgette & Morgan J. Levy  
Derek Livingston  
John Bedford Lloyd/Anna  
Tweeney  
Lisa Loesamora  
Mr. & Mrs. Stephen Lamb  
John Lyons  
Peter & Marlene Macfical  
Greg MacPherson  
Raana Malibu/Peter DeCasio  
Michelle S. Magazine  
Corey Maloney/Hermes Mallon  
James Makenny  
Donald Margulies/Lynn Street  
Ann M. Martin  
Carman Matthews  
Ricki Matthews  
Joan McAllister  
Paul McCrane  
Frances McDermand  
Joanne Martin/David Dratzin  
Jan & Richard Merrill

Elsa Bretton Miller  
Patricia Murphy  
Lila Stanley Murphy  
Susan Murray  
John G. Nard  
Liz Nealon  
James L. Nederlander  
Peter Newfeld  
Peter Newman  
Cynthia Nixon  
Eliot Novack  
Peter O'Brien  
James L. Oakes  
Carol Ochs  
Kevin O'Rourke/Edith  
Thurber  
Henry D. Osberg  
John & Kristina Pankow  
F. Richard Pappas  
Eliot Parker/Mack Uplkin  
Mr. & Mrs. Robert Parker  
David Patarkin  
Ruth Patarkin  
Thomas P. Peters  
Robert & Susan Phillips  
Helen & Peter Randolph  
Nob Rauch/Lisa Balschew  
Tim & Tyson Ray  
Paul Reale  
Jacquelyn Reingold  
Julia Ridge  
Elizabeth Rigg  
Lillian Robertson  
Gus Rogerson  
Bruce & Ellen Rosaman  
Mack Rossaff  
Robert de Rothschild  
Donald J. Rothschild  
Joyce Rudnick  
Larry & Deborah Schiff  
Don Schneider  
Ken & Mary Ann Schuster  
Sara Scott  
Angela & John Scrimmell  
Susan Shacter  
Barry Shapiro  
Murray Shapiro  
Bernice Baruch Showl  
Brian Sberall/Patty Dryden  
Ben & Ginny Stogler  
Judith Singsman  
Joey Silverman  
Meg Simon  
Jacqueline Simon

Berry Singer  
Tom Singer  
Isadora & Judith Singer  
Luis Smith  
Susan Solomon  
Erica Spallman-Silverman  
Jerome Spine, Jr.  
Florence Stanley/Martin  
Newman  
Robert Stecker  
Jury Sterner  
Byron Stavros/Robin  
Tilghman  
Byron K. Stevens, Sr.  
Tom & Maruon Stewart  
Joy Jovits Stewart  
J. Frederick Stillman, III  
Andrew Stone/Elisa Taylor  
Daniel Swan  
Anne Swift  
Joy Tarses  
LBI Taylor  
Michael Thomas  
Stanley & Gloria Thome  
Joan Vail Thorne  
Tracy Thorne  
Catherine C. Tracy  
Kathleen Turner  
Judith Tyger  
Laura Valaresa  
Peter Valaresa/Charles  
Goldberg  
Wendy M. Vanden Hauvel  
Scott Waara  
Emma Walton/Stephen  
Hamilton  
Mr. & Mrs. Charles G. Ward,  
III  
Bruce & Christine Wessorsstein  
John Waldman/Lila Calabron  
Ira Waltzman  
Michael A. Waltzer  
Betsy West  
Mr. & Mrs. Robert Wilder  
Donald Windham  
Gwan Winston  
Kathryn & Robert Wolfe  
Margaret L. Wolf  
Joan & Duich Wolf  
Andrew Walk  
Joanna Woodward  
Jill & Janine Yess  
Sotios Yannopoulos  
Janet Zarish

The 52nd Street Project  
at Graham-Windham  
presents

# Mind Making



Saturday & Monday, Aug. 22nd & 21th  
7:30 PM

Sunday, August 23rd  
3:00 & 7:30 PM

Ensemble Studio Theatre  
549 W. 52nd St. Second Floor  
(Between 10th & 11th Avenues)

In addition the 52nd Street Project is truly grateful to the many individuals who have made gifts of less than \$100. WHO'S WHO? is also made possible in part with public funds from the New York State Council on the Arts and the New York City Department of Cultural Affairs.

Graham Windham and The 52nd Street Project present

## Mind Making

Ensemble Studio Theatre, New York City

### Project Staff

Willie Reale, Artistic Director  
Carol Ochs, Executive Director  
Jenny Gersten, Production/Administrative Assistant  
Daniel Judah Sklar, Playmaking Director  
June Ballinger, Director-52nd Street at Graham-Windham  
Judy Tate, Playmaking Instructor, 52nd St. at Graham Windham  
Gwyneth Kirkbride, Project Slave

### Production Staff

Joshua Friedman, Stage Manager  
Iva Onson, ASM, Slide Operator  
Stacy Morse, Slide and Colorform Design  
Debra Barsha, Music Director  
Anky Frilles, Lights & Sound  
Greg MacPherson, Lighting Design  
Kevin Joseph Roach, Set Designer  
Michael Cerenzie, House Manager  
Elizz Benson, House Manager  
Ann Kahn, Front of House  
Mikaela Beardsley, Front of House  
Toshay Ziegler, Props  
Alycia Auville, Running Crew  
Stacy Morse, Running Crew  
Danny Noonan, Running Crew  
Fernando Ramirez, Running Crew  
Joanne Ramirez, Running Crew

### Graham-Windham

Suzanne F. Bales, Chair of the Board  
Joyce S. Lapenn, President and CEO  
Lonnie Stafford, Vice President,  
Residential Treatment Center  
Jennie Brown, Director  
Residential Treatment Center  
Allison Ray, Coordinator of Volunteers

### Ensemble Studio Theatre

Curt Dempster, Artistic Director  
Susan Vitucci, Chair of Board  
Kirstin Sanderson, Dir. of Summer Conference  
Michael Cerenzie, Business Manager  
Elizz Benson, Administrative Assistant

The 52nd Street Project at Graham-Windham brings kids from Graham-Windham together with professional theatre artists to create theatre. In Playmaking, the students were taught the essentials of playwriting in eight classroom sessions, and then wrote their own play with the support of an adult theatre professional during a weekend retreat in Palenville, NY.

The 52nd Street Project is an independent, nonprofit organization that operates with the cooperation of The Ensemble Studio Theatre and the Police Athletic League. Graham-Windham, founded in 1806, annually serves more than 6,000 children from families throughout the New York area. Its services include foster care and adoption; group homes and residential treatment for abused, neglected, and emotionally disturbed children.

### The 52nd Street Project Board of Directors

Ben Barenholtz  
Rachell Chanoff  
Marsue Cumming, *ex officio*  
Wendy Ettinger, Chair  
Louis P. Friedman  
Stephen Graham  
Heidi Landesman

James McDaniel  
Frances McDormand  
Patricia M. Murphy  
Carol Ochs  
Willie Reale  
Pamala Tyson  
Laura Valeroso

### Special Thanks To:

Curt Dempster and The Ensemble Studio Theatre; Michael Cerenzie; Julie Boyd!!!!!!; Julia Glanders; Kirsten Sanderson; Willie Reale, Michael Potts, Sal Trapani, Jenny Gersten and Bill Wrubel for putting up the set; Andre Parks for getting a handle on the doorknobs; Mina Hammer; Amelia White; Jan Dorn; Stacy Morse for drawing beyond the call of duty; Judy Tate for flyer and program; The Graham-Windham Campus Staff.

Graham-Windham and the 52nd Street Project gratefully acknowledges Kraft General Foods; Tatum O'neal and John McEnroe who helped make this program possible.

### In-Kind Contributions

Police Athletic League; Ensemble Studio Theatre;  
Hudson Scenic Studios, Inc; Colorforms,  
Sanford Goldstein; Stephen Graham; Bernhardt Fudyma Design Group;



The 52nd St. Project  
at  
Graham-Windham

## **Mind Making**

**The Witch and The Beast** by Robert Gilchrist  
Dramaturg/Directors; Phil Bozakowski  
& Gay Manifold  
Jenny.....Jan Dorn  
Don.....Ron Brice

**Heat 'Em Up** by Noble Dockery-Bey  
Dramaturg/Director; Tom Singer  
Stovler.....Geoffry Wade  
Stovin.....John Leighton  
The Lady.....Jarod Harvey

**Lincoln Airport High** by Laticia Moore  
Dramaturg/Director; Susan Willerman  
Timmy.....Geoffry Wade  
Captain/Steve.....William Badgett  
Kim.....Cecelia Arana

**Diamonds are a Girl's Deadly Friend**  
by Shannon Warren  
Dramaturg/Director; Kirsten Sanderson  
Susan.....Mary Beth Peil  
Miles.....Leonard Stabb

**The Lion and the Tree** by Melvin Pagan  
Dramaturg/Director; Sal Trapani  
Lion.....Michael Potts  
Tree.....Sylvia Gassell

*Intermission*

**A Cry in the Wind** by Jason Williams  
Director/Dramaturg; Kent Alexander  
Geologist.....Yolanda Snowball  
Volcano/Spirit.....Kevin Davis

**Going Home** by Kasheem Footman  
Director/Dramaturg; Nicola Sheara  
Joe.....Venida Evans  
Slick.....Jeff Lee  
Kozmo.....Virginia Downing

**Depressed** by Jody James  
Director/Dramaturg; Judy Tate  
Depressed Dora.....Kimberleigh Aarn  
Baby Fire.....Jeff Sugarman  
Keenan.....Geoffry Wade

**The Bear, The Cave & the Old Oak Tree**  
by Melissa Gutter  
Director/Dramaturg; Dina Losito  
The Old Oak Tree.....Rosiland Coleman  
The Bear.....Merri Ann Milwe  
The Cave.....The Cave

**Peanut Butter** by Danita Fischer  
Director/Dramaturg; June Ballinger  
Billy.....Don Spalding  
Peanut Butter.....Jeff Lee  
Marie.....June Ballinger  
Fire.....Jeff Sugarman

Thank you for coming! If you are not on our mailing list (or if your address has changed), please fill out this form and give it to us on your way out, or mail it to the address below. We would also like to know if you would like to be of help to us in the future (primarily in the areas of fundraising, printing, video dubbing and backstage). If so, please fill out your name, phone number and area(s) of interest below.

PLEASE ADD ME TO YOUR MAILING LIST:

Name \_\_\_\_\_

Address \_\_\_\_\_

Zip \_\_\_\_\_

Phone \_\_\_\_\_

YES, I WOULD LIKE TO BE OF HELP:

Name \_\_\_\_\_

Daytime Phone \_\_\_\_\_

Area(s) of Interest \_\_\_\_\_

I would be interested in being a crew head for your next production \_\_\_\_\_

If you would like to mail this, and/or a donation, you may do so to: The 52nd Street Project, 552 West 52nd St., New York, NY 10019 (212) 245-1350.

We have a brand new batch of 52nd Street Project T-Shirts (with the Shel Silverstein logo) on sale in the lobby for \$12.00. Half of this is tax-deductible. Colors include Black, Red, Fuschia, Jade, Grey and a limited number of Gold, Green and White. Great Gift Idea!

The 52nd Street Project gratefully acknowledges the support of the following foundations, corporations, government agencies and individuals: The Altman Foundation, The Bret Adams Agency, Citibank, N.A., The Liz Claiborne Foundation, Consolidated Edison, Nathan Cummings Foundation, D-B Trust, The Dammann Fund, The Department of Youth Services, The Dramatists Guild Fund, Educational Foundation of America, The Florence Gould Foundation, The William and Mary Greve Foundation, The Homessy Foundation, The Holland Lodge Foundation, The Kids Fund, The Eugene and Rose Kleiner Family Foundation, The IACJ Foundation, The Marquis George MacDonald Foundation, The James Macdonald Foundation, The Ann M. Martin Foundation, Morgan Guaranty Trust Co., Morgan Stanley and Company, The William Morris Agency, The New World Foundation, The New York Times Company Foundation, Primerica Foundation, The Samuel and May Rudin Foundation, The Fun Fox and Leslie R. Samuels Foundation, St. Laurent Associates, The Threshold Foundation, The Lisa Acheson Wallace Theater Fund, The Wasserstein Perella Foundation, The West Bank Cafe and

William R. Adams/J. Hoogele	Carol & Booth Dakins	Jane Hoffman	Elsa Bratton Miller	Barry Singer
Beth Adams	Judy Dennis	Mary Holloway	Patricia Murphy	Tam Singer
Nancy Adebisi/Clayton Lewis	Jodi SH. Doff	Billy Hopkins	Lisa Stanley Murphy	Isadore & Judith Singer
Lynette E. Allison	Polly Draper	Irwyn Horowitz	Susan Murray	Lois Smith
Alan Arfitt/Kay Mutschallat	Maira Driscoll	Thomas Hulka	John G. Ward	Susan Solomon
Margot Avery	William Duff-Griffin	Amy Introcasa/John Henry	Liz Neelon	Erica Spallman-Silverman
Jean Bocharach	Jack & June Dunbar	Davis	James L. Nederlander	Jerome Spina, Jr.
Anne Bailey/Charles Wright	Ned Eisenberg	Yves-Andre Istel	Peter Neufeld	Florence Stanley/Martin
Deborah Baker	Elliott & Hammer	Mark Jacobs	Peter Newman	Newman
Dominick Balletta/Helen Wilots	John P. Engel	Sy Jacobs	Cynthia Hixon	Robert Stecker
Michael Bandler	Wendy Etlinger	Gindy Lou Johnson	Elihu Hovock	Jerry Sterner
Colby Baranack	Martha Evans/Par LaFring	Avrah Pevior Johnson	Peter O'Brien	Byam Stevens/Robin
Ben Baranoholtz	Bill Fagenbalka/Catherine	Elinor Jones	James L. Oakes	Tighman
Miranda Barry	McCenahane	Bob Joy	Carol Ochs	Byam K. Stevens, Sr.
Jessica Bouman	Peter Jay Fernandez	Michael Kane/Judith Rudnick	Kevin O'Rourke/Edith	Tom & Maureen Stewart
Christopher Beach	Alexa A. Fogel	Ira Karasick/Nora Jacobson	Thurber	Jay Javits Stewart
Terry Belanger	Tom Fontana/Sogan Lewis	Mark J. Kennedy	Henry D. Osberg	J. Frederick Stillman, III
Corinne Berger	Jamie Foreman/Caroline	Perri Kipperman	John & Kristine Pankow	Andrew Swope/Elsa Taylor
Pat & Howard Berka	Aaron	Tracy Knights	F. Richard Pappas	Daniel Sweeney
Amy Birnbaum	David Frankel	Rita Knox/Stephen Cohen	Ellen Parker/Mack Lipkin	Anne Swift
Andra Bishop	Lisa Frey/John McLaughlin	Judy Kohn	Mr. & Mrs. Robert Parker	Jay Tarsis
Mr. & Mrs. G. Bissinger	Louis P. Friedman	Marcia Jean Kurtz	David Peterkin	Lili Taylor
Susan & Ron Black	Mo Ganey	Lewis M. Kwit	Ruth Peterkin	Michael Thomas
Allison M. Blinken	Thomas L. Gazzianis	Pamela Lack	Thomas P. Peters	Stanley & Gloria Thomas
Mark Blum	Bernard Gersten/Cora Cohen	Bill Lambert	Robert & Susan Phillips	Joan Vail Thorne
Risa Bramon/Rene Garcia	Jack Gopin/Ann McDonough	Gloria Landes	Helen & Peter Randolph	Tracy Thorne
Rita & Fred Brooks	The Gochmans	Arthur E. Landi	Mob Rouch/Lisa Balshaw	Catherine C. Tracy
Eric Brooks	Sanford Goldstein	Joyce Lapann	Tim & Tyson Ray	Kathleen Turner
Becky Browder/Ted Neustadt	Edward & Susan Goldstein	Jill Larson	Paul Reale	Judith Tygard
Garrett M. Brown	Susan Goldstein	Kate Lear	Jacquelyn Reingold	Laura Valerosa
Deborah Brown	Helen & Peter Goldstein	Joshua Lehrtr	Julie Ridge	Peter Valerosa/Charles
David Buskin	Christopher Gould	Priscilla Lenas	Elizabeth Rigg	Goldberg
Cafe Film Center	Mark Gould	Georgette & Morgan J. Levy	Lillie Robertson	Wendy M. Vanden Heuvel
Joel Coen	Stephen Graham	Derek Livingston	Gus Rogerson	Scott Waara
Stevan Callahan/Christine	Rosalind Gray	John Bedford Lloyd/Anne	Bruce & Ellen Roseman	Emma Walton/Stephen
Dunn	In honor of Cara Greene	Twomey	Mack Rossaff	Hamilton
William Carden	Susan Greenhill	Lisa Loosemore	Robert de Rothschild	Mr. & Mrs. Charles G. Ward,
Anne Carney	Colin Graer/Franca LaBarra	Mr. & Mrs. Stephen Lumb	Donald J. Rothschild	III
Claire L. Chelae	Lynne Gugenheim	John Lyons	Joyce Rudnick	Bruce & Christine Wasserstein
Rachel Chanoff	Albert R. Gurney	Peter & Marsue MacHical	Larry & Deborah Schiff	John Waidman/Lila Coleburn
Ellen Chanoweth	Lynne Hallday	Grag MacPherson	Don Schneider	Ira Waitzman
Michael & Pamela Chepiga	Jonathan Harmel	Roma Malizia/Peter DeCosa	Ken & Mary Ann Schuster	Michell A. Waltzner
Lois Chialfarano	Mina Hammer/Tom Reale	Michele S. Magazine	Seret Scott	Beth West
Marya & Fraser Cohn	Carl, Kathleen &	Carey Maloney/Harmes Malica	Angela & John Scrimitti	Mr. & Mrs. Robert Wilder
Ruth Cohn	Zella Hammer	James Maloney	Susan Shocter	Donald Windham
Richard J. Cohn	Evan Handler	Donald Margulies/Lynn Street	Barry Shapiro	Gwen Winston
The Cooper Committee	Kamyra Harding	Ann M. Martin	Murray Shapiro	Kathryn & Robert Wolfe
Michael Cristofel	Gerard E. Harper	Carmen Mathews	Bernice Baruch Showl	Margaret L. Wolf
Edna Cusick	Diana Haskell	Rikki Matthews	Brian Siberell/Patty Dryden	Joan & Dutch Wolf
Nail Cuthbert/Wendy Dastool	Jayne Haynes/John Patrick	Joan McAllister	Ben & Ginny Siegler	Andrew Wolk
Arthur Dantschik	Shanley	Paul McCrane	Judith Siegman	Joanne Woodward
Maina Dantziger	Peter Herdrich	Frances McDormand	Joey Silverman	Jeff & Janine Yass
Leslee Dart	Michele Halbrun	Joanna Martin/David Dretzin	Meg Simon	Sotis Yannopoulos
Dale Davis/Harris Spylios	Rob Harshman	Jan & Richard Merrill	Jacqueline Simon	Janet Zarish

In addition the 52nd Street Project is truly grateful to the many individuals who have made gifts of less than \$100. WHO'S WHO? is also made possible in part with public funds from the New York State Council on the Arts and the New York City Department of Cultural Affairs.

THE 52ND STREET PROJECT PRESENTS THE  
1992 ONE-ON-ONES

WHO'S WHO?

THE MISTAKEN IDENTITY PLAYS

THE BLOCK ISLAND PLAYS

August 27th ☉ August 28th ☽ August 29th ☿ August 30th ♀

THE ENSEMBLE STUDIO THEATRE

The 52nd Street Project Presents

## WHO'S WHO?

The Mistaken Identity Plays

from Block Island

August 27, 28, 29, 30

The Ensemble Studio Theatre - New York City

### Project Staff

Willie Reale, Artistic Director

Carol Ochs, Executive Director

Jenny Gersten, Director of Marketing and Development

Daniel Judah Sklar, Playmaking Director

Michael Bernard, Associate Artistic Director

Jerry McGill, Production Manager

June Ballinger, Director - 52nd Street at Graham-Windham

Judy Tate, Susan Willerman, Instructors - 52nd Street at Graham-Windham

Gwyneth Kirkbride, Administrative Intern

### Production Staff

Henry Krieger, Music Director

Kevin Joseph Roach, Set Designer

Greg MacPherson, Lighting Designer

Lorraine Anderson, Costume Designer

Iris A. Brown, Graphics

Mina Hammer, Slides

Katherine Lumb, Stage Manager

Traci Johnson, Colorforms & Props

Karen Cooper, Colorforms & Props

Katherine Lumb, Props & Colorforms

Toshay Ziegler, Asst. Stage Manager

Katherine Lumb, Light Board Operator

Jeremy Gray, Sound/Asst. Lights

Michael Bernard, Sound/Synthesizer

Alex Crowley, Slide Operator

Shirley Rumierk, Props

Leslie Werthamer, Running Crew

Danny Noonan, Running Crew

Bill Wrubel, Load-In

Sal Trapani, Load-In

Michael Potts, Load-In

Bill Wrubel, Load-In

Andre Parks, Door Handle Expert

Karin Barry, House Manager

House Crew:

Lisa Baumwol, Mari Eckroate,

Rikki Matthews, Ann Kahn, Beth

Emelson, Leah Caplan, Meg

Inglima, Becky Browder, Ted

Neustadt, Paul Gutrecht

Karen Myrie, Junior Counselor

José Soto, Junior Counselor

### Board of Directors

Ben Barenholtz

Rachell Chanoff

Marsue Cumming, *ex-officio*

Wendy Ettinger, Chair

Louis P. Friedman

Stephen Graham

Heidi Landesman

James McDaniel

Frances McDormand

Patricia M. Murphy

Carol Ochs

Willie Reale

Pamala Tyson

Laura Valeroso

### Special Thanks To:

Curt Dempster, Michael Cerenzie and The Ensemble Studio Theatre; Allison, Patty, Tito, Raymond and the P.A.L.; Dr. Cristina Biaggi; Joya Verde and Virginia Dare; Annie Reale, Martha MacDonald & Carol LeValle; Bob & Linda Frumolt; Tom & Lois Watson; Ron & Judy Tierney; Jennifer & Eliot Taubma; Bob & Lyn Reale; Interstate Navigation Co.; Glen Hall; Mike Cuddlack; Ed McGovern and The Yellow Kittens; Phil O'Donnell; Ken at the depot; Mary Jane Balser; Ed McQuade; Hunter Tracy; Prudy and Mary Beth of the Ice Cream Place; Traci Johnson; Rikki Matthews; Laura Jones; Alex Crowley; Minna Rose; Daniel Judah Sklar and his French Friends; John Paris and Flyer Chocolate Bars; Bernard Gersten, Susan Knox and Lincoln Center Theater.

### In-Kind Contributions:

Police Athletic League; Ensemble Studio Theatre; New York Stage & Film, Ben Barenholtz, Hudson Scenic Studios, Inc.; Colorforms; Bruce Cohen & Associates; Lincoln Center Theater; Shays & Murphy; Sanford Goldstein; Bernhardt Fudyma Design Group; Stephen Graham.

The 52nd Street Project is an independent, nonprofit organization that operates with the cooperation of The Ensemble Studio Theatre and the Police Athletic League. The Project brings inner-city children together with professional theater artists to create theater. This summer, our One-on-One program took 20 kids away for one-week stays on Block Island and in Poughkeepsie where they were matched with professional writer/actors who wrote plays for them to perform together.

## **WHO'S WHO?**

The Mistaken Identity Plays  
The 1992 Block Island One-on-Ones  
August 27, 28, 29, 30

"WHO'S WHO?" - Lyrics by Willie Reale, Music by Henry Krieger  
Company

### **THE EMPEROR'S NEW LAWS**

Written and Directed by Bill Wrubel for Luis Santoni, Age 12

Luisius. . . . . Luis Santoni  
Foxia. . . . . Lori Quinones  
Billius. . . . . Bill Wrubel

"New Laws" - Lyrics by Willie Reale, Music By Henry Krieger

### **NEW KID**

Written and Directed by Cassandra Medley with Joell Soto, Age 11

Joell. . . . . Joell Soto  
Principal. . . . . Dion Graham

"New Kid" - Lyrics by Cassandra Medley, Music by Henry Krieger

### **REASON TO RHYME**

Written by Fracaswell Hyman for Lori Quinones, Age 12

Directed by Paul McCrane

Danny. . . . . Paul McCrane  
Annie. . . . . Lori Quinones  
Dawgie Singers. . . . . Bruce MacVittie, Jim Ryan,  
José Soto, Dion Graham

"Sparks in the Park," "Doggies Always Come Home," and "No More Reason  
to Rhyme" - Lyrics by Fracaswell Hyman, Music by Paul McCrane

### **FULL OF HOT AIR**

Written and Directed by Thomas Babe for Darthula Harvey, Age 11

Denise . . . . . Darthula Harvey  
Herman. . . . . Jim Ryan  
Pilot . . . . . Bruce MacVittie  
Firman. . . . . Jim Ryan

"I Don't Want to Die" - Lyrics by Thomas Babe, Music by Henry Krieger

### **LOOKING IN THE MIRROR**

Written and Directed by Michaela Murphy for Andre Parks, Age 11

Michael. . . . . Andre Parks  
Mirror. . . . . Michaela Murphy

"Just Be Who You Are" - Lyrics by Willie Reale, Music by Henry Krieger

• INTERMISSION •

**THE ESSENCE OF GOODNESS AND OTHER DISCOVERIES**

Written and Directed by Willie Reale for Wendell Borrero, Age 11  
Wendell.....Wendell Borrero  
Igor.....Willie Reale  
Beautiful Creation..... E.D. (in her New York Stage debut)  
"I'm Mad" and "I've Got A Hunch It's You" - Lyrics by Willie Reale, Music by Henry Krieger

**THE VISIT**

Written and Directed by Jerry McGill for Nyita Hanley, Age 11  
Jerry.....Jerry McGill  
Stacy.....Nyita Hanley  
"Your Sky Could Use A Little More Sun" - Lyrics by Jerry McGill, Music by Henry Krieger

**WHAT'S UP, DOC?**

Written and Directed by Bruce MacVittie for Natasha Soto, Age 9  
Dr. E.....Natasha Soto  
Darthula.....Darthula Harvey  
Peter.....Bruce MacVittie  
Another Patient..... Dion Graham  
"Think Positive" - Lyrics by Bruce MacVittie, Music by Henry Krieger

**FUN AND FROLIC WITH THE EMPEROR**

Written and Directed by Jim Ryan for Omar Rose, Age 12  
Reggie.....Thomas Babe  
Emperor.....Omar Rose  
Eunuchs..... Bruce MacVittie, Paul McCrane,  
Willie Reale  
"Too Old to Be Young" and "I am the Emperor" - Lyrics by Jim Ryan, Music by Henry Krieger

**INTERGALACTIC MOM**

Written and Directed by Cindy Lou Johnson for Erse Britto, Age 12  
Mom.....Roma Maffia  
Bok.....Erse Britto  
Swift Louie..... Roma Maffia  
Little Girl..... Roma Maffia  
Man..... Thomas Babe  
"I Don't Mind Lookin" - Lyrics by Cindy Lou Johnson, Music by Henry Krieger

Thank you for coming! If you are not on our mailing list (or if your address has changed), please fill out this form and give it to us on your way out, or mail it to the address below. We would also like to know if you would like to be of help to us in the future (primarily in the areas of fundraising, backstage and printing). If so, please fill out your name, phone number and areas of interest below.

**PLEASE ADD ME TO YOUR MAILING LIST:**

NAME \_\_\_\_\_

ADDRESS \_\_\_\_\_

\_\_\_\_\_ Zip \_\_\_\_\_

PHONE \_\_\_\_\_

**YES, I WOULD LIKE TO BE OF HELP:**

NAME \_\_\_\_\_

DAYTIME PHONE \_\_\_\_\_

AREA(S) OF INTEREST (please be specific)  
\_\_\_\_\_  
\_\_\_\_\_

**ON SALE IN THE LOBBY!**

Be the first ever to don 52nd Street Project **removable tatoos!** Only a buck.  
52nd Street Project T-Shirts with Shel Silverstein Logo: \$12.00  
"Playmaking" by Daniel Judah Sklar: \$13.00  
Flyer Chocolate Bar \$1.00

Remember, one-half of sale price is tax-deductible!

If you would like to mail this (and you're always welcome to enclose a tax-deductible contribution), you can send it to:  
The 52nd Street Project, 552 West 52nd Street, New York, NY 10019, (212) 764-1379.

The 52nd Street Project gratefully acknowledges the support of the following foundations, corporations, government agencies and individuals: The Altman Foundation, The Bret Adams Agency, Citibank, N.A., The Liz Claiborne Foundation, Consolidated Edison, Nathan Cummings Foundation, D-B Trust, The Dammann Fund, The Department of Youth Services, The Dramatists Guild Fund, Educational Foundation of America, The Florence Gould Foundation, The William and Mary Greva Foundation, The Hennessy Foundation, The Holland Lodge Foundation, The Kids Fund, The Eugene and Rose Kleiner Family Foundation, The MCI Foundation, The Marquis George MacDonald Foundation, The James Macdonald Foundation, The Ann M. Martin Foundation, Morgan Guaranty Trust Co., Morgan Stanley and Company, The William Morris Agency, The New World Foundation, The New York Times Company Foundation, Primerica Foundation, The Samuel and May Rudin Foundation, The Fan Fox and Leslie R. Samuels Foundation, St. Laurent Associates, The Threshold Foundation, The Lila Acheson Wallace Theater Fund, The Wasserstein Perella Foundation, The West Bank Cafe and

William R. Adams/J. Naegele  
Beth Adams  
Nancy Adelson/Clayton Lewis  
Lynette E. Allison  
Alan Aflia/Kay Matuschullat  
Margot Avery  
Jean Bacharach  
Anne Bailey/Charles Wright  
Deborah Baker  
Dominick Balletto/Irene Wilcox  
Michael Bandier  
Cathy Baranok  
Ben Barenholtz  
Miranda Barry  
Jessica Bauman  
Christopher Beach  
Terry Belanger  
Corinne Berger  
Pat & Howard Berke  
Amy Birnbaum  
Andre Bishop  
Mr. & Mrs. G. Bissinger  
Susan & Ron Black  
Allison M. Blinken  
Mark Blum  
Risa Bramon/Rene Garcia  
Rita & Fred Brooks  
Eric Brooks  
Becky Browder/Ted Neustadt  
Garrett M. Brown  
Deborah Brown  
David Buskin  
Cafe Film Center  
Jed Caen  
Steven Callahan/Christine  
Dunn  
William Carden  
Anne Carney  
Claire L. Chafae  
Rachel Chanoff  
Ellen Chenoweth  
Michael & Pamela Chepiga  
Louis Chiffarano  
Marya & Fraser Cohn  
Ruth Cohen  
Richard J. Cohn  
The Cooper Committee  
Michael Cristofar  
Edna Cusick  
Neil Cuthbert/Wendy Dastool  
Arthur Dantchik  
Maia Dantiger  
Leslee Dart  
Dale Davis/Harris Spylios

Carol & Booth Deakins  
Judy Dennis  
Jodi SH. Delf  
Polly Draper  
Maira Driscoll  
William Duff Griffen  
Jack & June Dunbar  
Ned Eisenberg  
Elliott & Hammer  
John P. Engel  
Wendy Ettinger  
Martha Evans/Per Lohving  
Bill Fagerbakke/Catherine  
McClenahan  
Peter Jay Fernandez  
Alexa A. Fogel  
Tom Fontana/Sogan Lewis  
Jamie Foreman/Caroline  
Aron  
David Frankel  
Lisa Frey/John McLaughlin  
Louis P. Friedman  
Ma Ganey  
Thomas L. Gazianis  
Bernard Gersten/Cora Cahon  
Jack Gilpin/Ann McDonough  
The Gochmans  
Sanford Goldstein  
Edward & Susan Goldstein  
Susan Goldstein  
Helen & Peter Goldstein  
Christopher Gould  
Mark Gould  
Stephen Graham  
Rosalind Gray  
In honor of Cara Greene  
Susan Greenhill  
Colin Graer/Franca LaBarre  
Lynne Gugenheim  
Albert R. Guney  
Lynne Halliday  
Jonathan Hamel  
Mina Hammer/Tom Reale  
Carl, Kathleen &  
Zella Hammer  
Evan Handler  
Kamrya Harding  
Gerard E. Harper  
Diana Haskell  
Jayne Haynes/John Patrick  
Shanley  
Peter Herdrich  
Michele Heilbrun  
Rob Harshman

Jane Hoffman  
Mary Holloway  
Billy Hopkins  
Irwin Horowitz  
Thomas Hulce  
Amy Intracasa/John Henry  
Davis  
Yves-Andre Ixid  
Mark Jacobs  
Sy Jacobs  
Cindy Lou Johnson  
Arah Pevlar Johnson  
Elinor Jones  
Bob Joy  
Michael Kane/Judith Rudnick  
Ira Karasick/Hara Jacobson  
Mark J. Kennedy  
Patti Kipperman  
Aaron  
Rita Knox/Stephen Cohen  
Judy Kuhn  
Marcia Jean Kurtz  
Lewis M. Kvit  
Pamela Lack  
Bill Lambert  
Gloria Landes  
Arthur E. Landi  
Joyce Lapann  
Jill Larson  
Kate Lear  
Joshua Lehrer  
Priscilla Lenex  
Georgette & Morgan J. Levy  
Derek Livingston  
John Bedford Lloyd/Anne  
Twomey  
Lisa Loosemore  
Mr. & Mrs. Stephen Lumb  
John Lyons  
Peter & Marsue MacNicol  
Greg MacPherson  
Roma Maffia/Peter DeCoste  
Michele S. Magazine  
Carey Maloney/Hermes Mallea  
James Maloney  
Donald Margulies/Lynn Street  
Ann M. Martin  
Carman Matthews  
Rikki Matthews  
Joan McAllister  
Paul McCrane  
Frances McDermont  
Joanna Marlin/David Dretzin  
Jan & Richard Merrell

Elise Breton Miller  
Patricia Murphy  
Lila Stanley Murphy  
Susan Murray  
John G. Nardi  
Liz Nealon  
James L. Nederlander  
Peter Neufeld  
Peter Newman  
Cynthia Nixon  
Ellen Novack  
Peter O'Brien  
James L. Oakes  
Carol Ochs  
Kevin O'Rourke/Edith  
Thurber  
Henry D. Ostberg  
John & Kristine Pankow  
F. Richard Pappas  
Ellen Parker/Mack Lipkin  
Mr. & Mrs. Robert Parker  
David Parker  
Ruth Parker  
Thomas P. Peters  
Robert & Susan Phillips  
Helm & Peter Randolph  
Nob Rauch/Lisa Balshaw  
Tim & Tyson Ray  
Paul Reale  
Jacquelyn Reingold  
Julie Ridge  
Elizabeth Rigg  
Lillian Robertson  
Gus Rogerson  
Bruce & Ellen Rosaman  
Mack Rosoff  
Robert de Rothschild  
Donald J. Rothschild  
Joyce Rudnick  
Larry & Deborah Schill  
Don Schneider  
Ken & Mary Ann Schuster  
Serei Scott  
Angela & John Scrimin  
Susan Shacter  
Barry Shapiro  
Bernice Baruch Showl  
Brian Sberelli/Patty Dryden  
Ben & Ginny Siegler  
Judith Siegman  
Joey Silverman  
Meg Simon  
Jacqueline Simon

Barry Singer  
Tom Singer  
Isadore & Judith Singer  
Lois Smith  
Susan Solomon  
Erica Spellman-Silverman  
Jerome Spina, Jr.  
Florence Stanley/Martin  
Newman  
Robert Stecker  
Jerry Steiner  
Byam Stevens/Robin  
Tighman  
Byam R. Stevens, Sr.  
Tom & Mousen Stewart  
Joy Jarvis Stewart  
J. Frederick Stillman, III  
Andrew Swan/Elise Taylor  
Daniel Swan  
Anne Swift  
Joy Tarses  
Lili Taylor  
Michael Thomas  
Stanley & Gloria Thomas  
Joan Vail Thorne  
Tracy Thorne  
Catherine C. Tracy  
Kathleen Turner  
Judith Tygard  
Laura Valerasa  
Peter Valerasa/Charles  
Goldberg  
Wendy M. Vanden Heuvel  
Scott Warner  
Emma Walton/Stephen  
Hamilton  
Mr. & Mrs. Charles G. Ward,  
III  
Bruce & Christine Wasserstein  
John Weidman/Lila Coleburn  
Ira Weitzman  
Mitchell A. Weitzner  
Beth West  
Mr. & Mrs. Robert Wilder  
Donald Windham  
Gwan Winston  
Kathryn & Robert Wolla  
Margaret L. Wolf  
Joan & Dutch Wolf  
Andrew Walk  
Joanne Woodward  
Jill & Janine Yoss  
Sofos Yannopoulos  
Janet Zarich  
(as of August 1992)

The 52nd Street Project  
presents

# First Things Second

The Ensemble Studio Theatre  
November 15th and 14th

In addition the 52nd Street Project is truly grateful to the many individuals who have made gifts of less than \$100. WHO'S WHO? is also made possible in part with public funds from the New York State Council on the Arts and the New York City Department of Cultural Affairs.

The 52nd Street Project Presents

## FIRST THINGS SECOND

The 1992 Playback Plays

November 15th & 14th  
The Ensemble Studio Theatre - New York City

### Project Staff

Willie Reale, Artistic Director  
Carol Ochs, Executive Director  
Jenny Gersten, Director of Marketing & Development  
Daniel Judah Sklar, Playmaking Director  
Michael Bernard, Associate Artistic Director  
Jerry McGill, Production Manager  
Susan Vitucci, Development Consultant  
Eris Migliorini, Project Intern Straordinario

### Production Staff

Kevin Joseph Roach, Set Designer  
Jan Kroeze, Lighting Designer  
Joe Saint, Assistant Lighting Designer  
Lorraine Anderson, Costume Designer  
Katherine Lumb, Stage Manager  
Iris A. Brown, Graphics  
Mina Hammer, Slide Design  
Traci Johnson & Karen Cooper,  
Colorforms & Props Design  
Toshay Ziegler, Sound & Synth  
Mike Kelleher, Furniture  
Alex Bess, Furniture Crew  
Marcia Levine, Slide Operator  
Angela Trento & Becky Browder,  
Colorforms Crew

Carrie Tocci & Eris Migliorini,  
Props Crew  
Light Hang/Load-In Crew:  
Jana Brockman, Paul Gruen,  
Alexandra Lipsitz, Katherine  
Lumb, Jonathan Weinberg, Bill  
Wrubel & Toshay Ziegler  
Karin Barry, House Manager  
House Crew:  
Peter Manning, Rikki Matthews,  
Tracy Reese

The 52nd Street Project is an independent, nonprofit organization that operates with the cooperation of The Ensemble Studio Theatre and the Police Athletic League. The Project brings inner-city children together with professional theatre artists to create theatre.

FIRST THINGS SECOND is the second-ever production of a program called Playback. In it, an adult actor/playwright is paired with a kid actor/playwright. The duo is charged to invent two characters for the kid to write a play for. The adult then responds with a second play using the same two characters. The program was invented to challenge kids who are veterans of the Project's acting and writing programs.

### Board of Directors

Ben Barenholtz	Rachel Chanoff
Marsue Cumming, <i>ex officio</i>	Wendy Ettinger, Chair
Louis P. Friedman	Stephen Graham
Heidi Landesman	James McDaniel
Frances McDormand	Patricia M. Murphy
Carol Ochs	Willie Reale
Pamala Tyson	Laura Valeroso

### Special Thanks To:

Curt, Kevin, Michael, Marcel, Jim and everybody else at The Ensemble Studio Theatre; P.A.L.; New York Theatre Workshop; The Mint Theatre Group; Dara Degnan; Sandi Francis; Pam "Fingers" Higley; Mike Kelleher; Rikki Matthews; Barbara McCrane; Michaela Murphy; Terry Textor; Carrie Tocci; Susan Willerman; Frank Wood; Eris, always; Sheila Kehoe; Jamie Levine; Andy Millon; Dave Baron.

### In-Kind Contributions:

Police Athletic League; Ensemble Studio Theatre; Hudson Scenic Studios, Inc.; Colorforms; Bruce Cohen & Associates; Shays & Murphy; Sanford Goldstein; Bernhardt/Fudyma Design Group; Stephen Graham, Donald Marcus; Tom Reale; Susan Vitucci; Fahrenheit Productions; Patty Dryden & Brian Siberell.



## FIRST THINGS SECOND

### 1992 Playback Plays

#### A WOMAN'S PLACE

Written by Fran-Marie Fargardo, Age 15

Directed by Susan Vitucci

President ..... Fran-Marie Fargardo  
Phyllis ..... Susan Vitucci  
Shirley ..... Shirley Rumierk

*Many Years Earlier*

#### A WOMAN'S PLACE II

Written and Directed by Susan Vitucci

Phyllis ..... Susan Vitucci  
Mommy ..... Fran-Marie Fargardo

#### ROOM TO BREATHE

Written by Dawn Jackson, Age 15

Directed by Elizabeth Margid

Irene ..... Dawn Jackson  
Roxanne ..... Elizabeth Margid  
Dad ..... Ned Eisenberg  
Mom ..... Dawn Jackson

*Fifteen Years Earlier*

#### ROOM TO BREATHE II

Written by Jim Ryan

Directed by Elizabeth Margid

Dad ..... Ned Eisenberg  
Mom ..... Dawn Jackson  
Baby ..... Elizabeth Margid

**LOVE THY NEIGHBOR**

Written by Ronnie Noonan, Age 13

Directed by Candido Tirado

Luna..... Stephanie Berry

Killer..... Ronnie Noonan

*Earlier That Evening*

**LOVE THY NEIGHBOR II**

Written and Directed by Candido Tirado

Luna..... Stephanie Berry

Killer..... Ronnie Noonan

**THE REAL McCOY**

Written by Shirley Rumierk, Age 15

Directed by Judy Dennis

Nurse..... Shirley Rumierk

McCoy..... Don Berman

*Thirty Years Earlier*

**THE REAL McCOY II**

Written by Bill Wise

Directed by Judy Dennis

Girl..... Shirley Rumierk

Man..... Don Berman

Woman..... Shirley Rumierk

**I THOUGHT I WAS YOUR NUMBER ONE**

Written by Richard Myrie, Age 12

Directed by Willie Reale

Bear..... James McDaniel

Mike..... Richard Myrie

*Two Nights Earlier*

**I THOUGHT I WAS YOUR NUMBER ONE II**

Written by Fracaswell Hyman

Directed by Willie Reale

Bear..... James McDaniel

Mike..... Richard Myrie

Thank you for coming! If you are not on our mailing list (or if your address has changed), please fill out this form and give it to us on your way out, or mail it to the address below. We would also like to know if you would like to be of help to us in the future (primarily in the areas of fundraising, backstage and printing). If so, please fill out your name, phone number and areas of interest below.

**PLEASE ADD ME TO YOUR MAILING LIST:**

NAME \_\_\_\_\_

ADDRESS \_\_\_\_\_

\_\_\_\_\_ Zip \_\_\_\_\_

PHONE \_\_\_\_\_

**YES, I WOULD LIKE TO BE OF HELP:**

NAME \_\_\_\_\_

DAYTIME PHONE \_\_\_\_\_

AREA(S) OF INTEREST \_\_\_\_\_

\_\_\_\_\_

**ON SALE IN THE LOBBY!!!**

52nd Street Project T-Shirts with Shel Silverstein Logo: \$12.00

"Playmaking" by Daniel Judah Sklar: \$12.00

The New and *Rad* 52nd Street Project Removable Tattoo: \$1.00

The Fabulous "Flyer Chocolate Bar": still only a buck

Remember, one-half of sale price is tax-deductible!

If you would like to mail this (and you're always welcome to enclose a tax-deductible contribution), you can send it to:

The 52nd Street Project

220 West 42nd Street

18th Floor

New York, NY 10036

(212) 764-1379

The 52nd Street Project gratefully acknowledges the support of the following foundations, corporations, government agencies and individuals: The Altman Foundation, The Bret Adams Agency, Citibank, N.A., The Liz Claiborne Foundation, Consolidated Edison, Nathan Cummings Foundation, D-B Trust, The Danmann Fund, The Dramatists Guild Fund, Educational Foundation of America, The Florence Gould Foundation, The William and Mary Grave Foundation, The Hennessy Foundation, The Holland Lodge Foundation, The MCJ Foundation, The Marquis George MacDonald Foundation, The James Macdonald Foundation, The Ann M. Martin Foundation, Morgan Guaranty Trust Co., Morgan Stanley and Company, The William Morris Agency, The New World Foundation, The New York Times Company Foundation, Primavera Foundation, The Samuel R. May Rudin Foundation, The Fan Fox and Leslie R. Samuels Foundation, St. Laurent Associates, Societa Generale, The Shold Foundation, The Lila Acheson Wallace Theater Fund, The Wasserstein Perella Foundation, The West Bank Cafe and

William R. Adams/J. Noogele	Carol & Booth Deakins	Jane Hoffman	Elise Bretton Miller	Barry Singer
Beth Adams	Judy Dennis	Mary Holloway	Patricia Murphy	Tom Singer
Nancy Adelson/Clayton Lewis	Jodi SH. Doff	Billy Hopkins	Lila Stanley Murphy	Isadore & Judith Singer
Lynette E. Allison	Polly Draper	Irwin Horowitz	Susan Murawitz	Lois Smith
Alan Arffa/Kay Mutschallat	Maira Driscoll	Thomas Hulce	John G. Marai	Susan Solomon
Margot Avery	William Duff-Griffin	Amy Intracasa/John Henry	Liz Nealon	Erica Spellman-Silverman
Jean Bacharach	Jack & June Dunbar	Davis	James L. Nederlander	Jerome Spina, Jr.
Anne Bailey/Charles Wright	Jeannine Edmunds	Yves-Andre Isid	Peter Neufeld	Florence Stanley/Martin
Deborah Baker	Ned Eisenberg	Mark Jacobs	Peter Newman	Newman
Dominick Balletta/Hlene Wilots	Elliott & Hammer	Sy Jacobs	Cynthia Nixon	Robert Stecker
Michael Bandler	John P. Engel	Gindy Lou Johnson	Ellen Novack	Jerry Starner
Cathy Baranck	Wendy Ettinger	Avrah Pawlor Johnson	Janica Novack	Byam Stevens/Robin
Ben Barenholtz	Martha Evans/Per Lohving	Elinor Jones	Peter & Margaret O'Brian	Tigman
Miranda Barry	Bill Fagerbakke/Catherine	Bob Joy	James L. Oakes	Byam K. Stevens, Sr.
Jessica Bowman	McClennahan	Michael Kane/Judith Rudnick	Carol Ochs	Tom & Maureen Stewart
Christopher Beach	Peter Jay Fernandez	Ira Karasick/Nora Jacobson	Kevin O'Rourke/Edith	Joy Jarvis Stewart
Terry Balanger	Alexa A. Fogel	Mark J. Kennedy	Thurbar	J. Frederick Sullivan, III
Corinne Berger	Tom Fontana/Sagan Lewis	Parri Kipperman	Henry D. Osberg	Andrew Swan/Elise Taylor
Pat & Howard Berke	Jamie Foreman/Caroline	Tracy Knights	John & Kristine Pankow	Daniel Swae
Amy Birnbaum	Aaron	Rita Knox/Stephen Cohen	F. Richard Pappas	Anne Swift
Andra Bishop	David Frankel	Judy Kahn	Ellen Parker/Mack Lipkin	Jay Tarses
Mr. & Mrs. G. Bissinger	Lisa Frey/John McLaughlin	Marcia Jean Kurtz	Mr. & Mrs. Robert Parker	Lil Taylor
Susan & Ron Block	Louis P. Friedman	Lewis M. Kwit	David Peterkin	Michael Thomas
Alison M. Blinken	Mo Ganey	Pamela Lock	Ruth Peterkin	Stanley & Gloria
Mark Blum	Thomas L. Gazianis	Bill Lambert	Thomas P. Peters	Joan Vail Thorne
Risa Bramon/Rene Garcia	Bernard Gersten/Cora Cahon	Gloria Landes	Robert & Susan Phillips	Tracy Thorne
Rita & Fred Brooks	Jack Gelpin/Ann McDonough	Arthur E. Landi	Helen & Peter Randolph	Catherine C. Tracy
Eric Brooks	The Gochmans	Joyce Lapann	Nob Rouch/Lisa Bolshov	Kathleen Turner
Becky Browder/Ted Heustadt	Sanford Goldstein	Jill Larson	Tim & Tyson Ray	Judith Tygard
Garrett M. Brown	Edward & Susan Goldstein	Kate Laer	Paul Reale	Laura Valerosa
Deborah Brown	Susan Goldstein	Joshua Lehrer	Jacquelyn Raingold	Peter Valeroso/Charles
Kate Burton/Michael Ritchie	Helen & Peter Goldstein	Priscilla Lanes	Julie Ridge	Goldberg
David Buskin	Christopher Gould	Georgette & Morgan J. Levy	Elizabeth Rigg	Wendy M. Vanden Hauvel
Cafe Film Center	Mark Gould	Derek Livingston	Lillie Robertson	Scott Waara
Joel Coen	Stephen Graham	John Bedford Lloyd/Anne	Gus Rogerson	Emma Walton/Stephen
Stevan Callahan/Christine	Rosalind Gray	Twomey	Bruce & Ellen Roseman	Hamilton
Dunn	In honor of Cara Greene	Lisa Loosemore	Mack Russell	Mr. & Mrs. Charles G. Ward,
William Carden	Susan Greenhill	Mr. & Mrs. Stephen Lumb	Robert de Rothschild	III
Anne Carney	Colin Greer/Frances LaBarra	John Lyons	Donald J. Rothschild	Bruce & Christine Wasserstein
Claire L. Chafae	Lynne Gugenheim	Peter & Marsue MacHical	Joyce Rudnick	John Waidman/Lisa Coleburn
Rachel Chanoff	Albert R. Gurney	Greg MacPherson	Larry & Deborah Schiff	Ira Waitzman
Elan Chanoweth	Lynne Holliday	Rama Maffia/Peter DeCoste	Don Schneider	Michael A. Waitzner
Michael & Pamela Chopiga	Jonathan Hamel	Michele S. Magazine	Ken & Mary Ann Schuster	Betsy West
Louis Chiffarano	Mina Hammer/Tom Reale	Corey Maloney/Hermes Malloa	Richard Schwartz	John Wexler
Marya & Fraser Cohn	Carl, Kathleen &	James Maloney	Sarah Scott	Mr. & Mrs. Robert Wilder
Ruth Cohen	Zella Hammer	Donald Margulies/Lynn Street	Angela & John Scrimanti	Donald Windham
Richard J. Cohn	Evian Handler	Ann M. Martin	Susan Shacter	Gwen Winston
The Cooper Committee	Kanyra Harding	Carman Matthews	Barry Shapiro	Kathryn & Robert Wolfe
Eleanor Coppola	Gerard E. Harper	Riki Matthews	Murray Shapiro	Margaret L. Wolf
Michael Cristofar	Diana Haskell	Joan McAllister	Bernice Baruch Showl	Joan & Dutch Wall
Edie Cusick	Jayne Haynes/John Patrick	Drew McCoy	Brian Sberall/Patty Dryden	Andrew Walk
Nail Cuthbert/Wendy Dastiel	Shanley	Paul McCrane	Ben & Ginny Siegler	Joanne Woodward
Arthur Danichuk	Peter Herdrich	Frances McDormand	Judith Siegman	Jeff & Janine Yass
Maia Dancziger	Michele Heilbrun	Joanna Merlin/David Dretzin	Joey Silverman	Sotos Yannopoulos
Leslee Dart	Rob Harshman	Jon & Richard Merrell	Meg Simon	Janel Zarish
Dale Davis/Harris Spylis			Jacqueline Simon	(as of 12/10/92)

In addition The 52nd Street Project is truly grateful to the many individuals who have made gifts of less than \$100. ON THE JOB is also made possible in part with public funds from the National Endowment for the Arts, New York State Council on the Arts, The Department of Youth Services and the New York City Department of Cultural Affairs.

THE  
52ND STREET  
PROJECT  
PRESENTS  
ON THE JOB  
AT  
NEW YORK  
THEATRE  
WORKSHOP

December  
11th, 12th and 13th

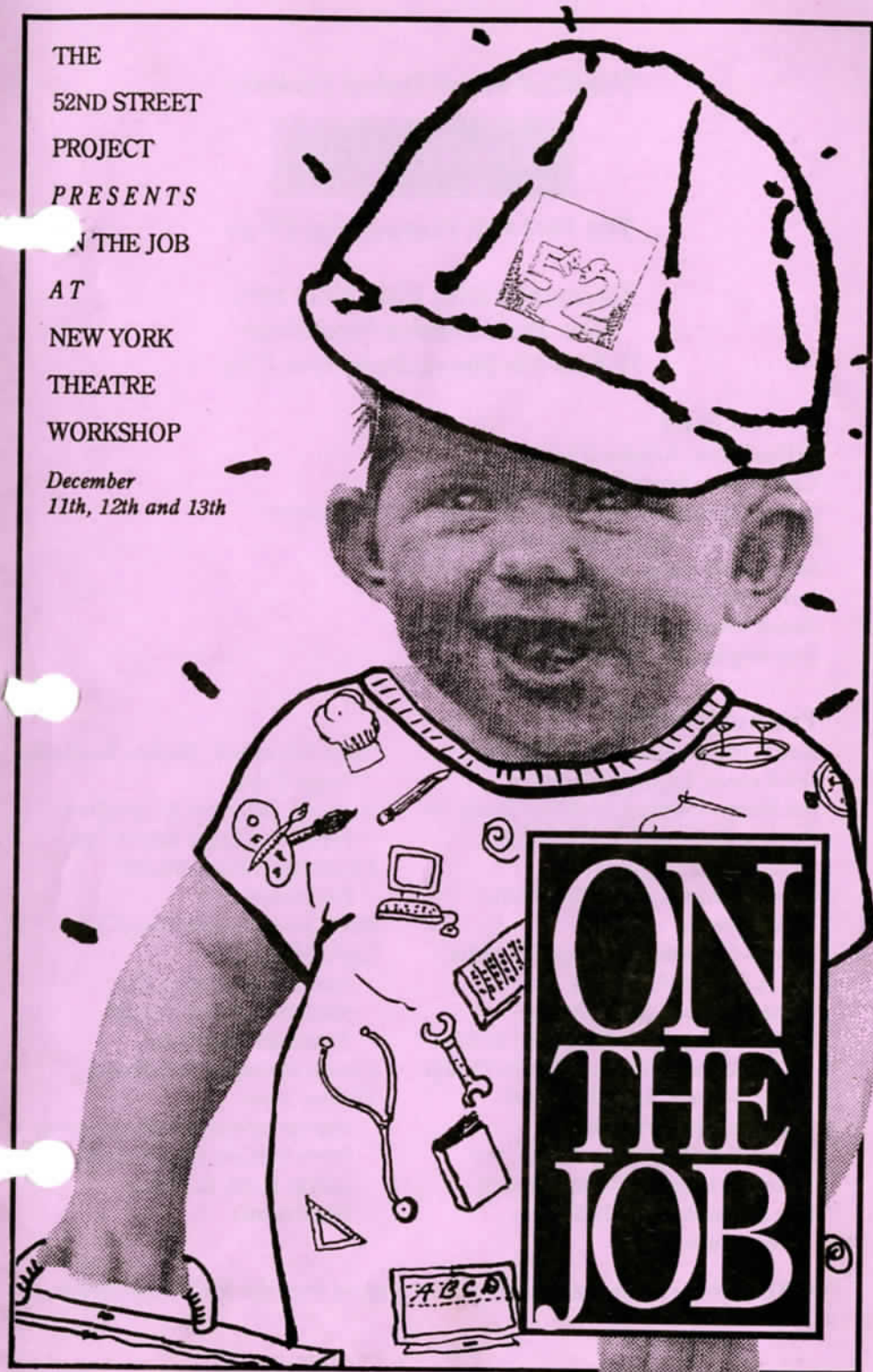

The 52nd Street Project Presents

## ON THE JOB

The 1992 Fall Playmaking Plays

December 11th, 12th, 13th, 1992  
New York Theatre Workshop  
79 East 4th Street, New York City

### Project Staff

Willie Reale, Artistic Director  
Carol Ochs, Executive Director  
Jenny Gersten, Director of Marketing & Development  
Daniel Judah Sklar, Playmaking Director  
Michael Bernard, Associate Artistic Director  
Jerry McGill, Production Manager  
Susan Vitucci, Development Consultant  
Eris Migliorini, Princess Intern

### Production Staff

Kevin Joseph Roach, Set Designer  
Jan Kroeze, Lighting Designer  
Joe Saint, Assistant Lighting Designer  
Patricia Sarnataro & David Zinn,  
Costume Designers  
David Baron & David Gennaro,  
Composers  
Simma Gershenson, Stage Manager  
Iris A. Brown, Graphics  
Mina Hammer, Slide Design  
Patty Dryden, Josh Goshfield & their  
class at Parson's, Colorforms Design  
Jenny Gersten, Sound & Synth  
Mike Kelleher, Furniture  
Wendell Borrero, Furniture Crew  
Dawn Jackson, Backstage Swing  
Eric Berkal & Eris Migliorini,  
Colorforms Crew

Traci Johnson & Shirley Rumierk,  
Props Crew  
Autumn Backman & Jonathan  
Weinberg, Light Board Ops  
Ethan Rosenblatt, Master  
Electrician  
Paul Gruen, Light Hang Guru  
Light Hang Crew:  
Autumn Backman, Eric  
McDaniel, Kevin Royan,  
Jonathan Weinberg  
House Manager, Ron Bottig  
House Crew:  
Marcia Levine, Peter Manning,  
Steve McCall, Linda Morris  
Carrie Tocci, & Leslie  
Wertheimer

The 52nd Street Project is an independent, nonprofit organization that operates with the cooperation of The Ensemble Studio Theatre and the Police Athletic League. The Project brings inner-city children together with professional theatre artists to create theatre.

ON THE JOB is a production of our Playmaking program that is designed to teach children how to write a play. After eight weeks of classes, each child is given two actors, a theme and a director who guides him or her through the writing of a play during a weekend in the country. These are the fruits of their labors.

### Board of Directors

Ben Barenholtz	Rachel Chanoff
Marsue Cumming, <i>ex officio</i>	Wendy Ettinger, Chair
Louis P. Friedman	Stephen Graham
Heidi Landesman	James McDaniel
Frances McDormand	Patricia M. Murphy
Carol Ochs	Willie Reale
Pamala Tyson	Laura Valeroso

### Special Thanks To:

James C. Nicola, Nancy Kassak Diekmann, George Xenos, and the entire lovely staff of the New York Theatre Workshop; The Ensemble Studio Theatre; P.A.L.; Cora Cahan, Jeffrey Gross and The New 42nd Street; Eric Karpeles & Mike Sell; Gary & Flory Nebiol; Martha Sader; Jana Brockman; Hilary Chaplain; Wesley Clark; Moira Driscoll; Suzy Kitman; Rikki Matthews; Barbara McCrane; Sandy Mulvihill; Tracy Reese; Chris Shannahan; Susan Willerman; Eris, endlessly; Jamie Livingston; Andy Millon; Mary Perrin & Flash.

### In-Kind Contributions:

Police Athletic League; Ensemble Studio Theatre; Hudson Scenic Studios, Inc.; Colorforms; Bruce Cohen & Associates; Shays & Murphy; Sanford Goldstein; Bernhardt/Fudyma Design Group; Stephen Graham, Donald Marcus; Tom Reale; Baron & Baron Productions; Susan Vitucci; Fahrenheit Productions; Patty Dryden & Brian Siberell.

"On The Job" is made possible in part by a grant from the MCJ Foundation.

**ON THE JOB  
ACT I**

**MAGIC**

Written by Erica Borrero, age 9  
Director/dramaturg, Moira Driscoll

Karen..... Jill Larson  
Laren..... Will Badgett

**THE COMEDY STRIP**

Written by Natasha Soto, age 9  
Director/dramaturg, Susan Kim

Mona..... Susan Murray  
Lisa..... Sandye Wilson

**LISA GETS A PART-TIME JOB**

Written by Jennifer Soccaros, age 9  
Director/dramaturg, Christopher Grabowski

Jose..... Arthur French  
Lisa..... Lisa Gay Hamilton  
The Boss..... Joe Grifasi  
The Lobster..... Arthur French

**THE MAIDKEEPER**

Written by Amy Barbosa, age 8  
Director/dramaturg, Barbara McCrane

Rob..... Joe White  
Janese..... Myra Taylor  
Voice of the Boss..... Michael Bernard

"Hawaii" -- lyrics by Amy Barbosa, music by David Gennaro  
performed by Dave Gennaro and Jerry Krenach

**THE LOVEBIRDS**

Written by Desmond Robertson, age 9  
Director/dramaturg, David Pence, Jr.

Tony..... Christopher Dansby Fisher  
Nancy..... Sandy Mulvihill  
Dan..... Christopher Dansby Fisher

"So So Silly" -- lyrics by Desmond Robertson, music by David Baron  
performed by David Baron and Jerry Krenach

## ACT II

### THE BEST FRIENDS

Written by Joseph Jackson, age 7  
Dramaturg, Jerry McGill  
Director, Willie Reale

Jackson..... Dion Graham  
Ally..... Alexandra Gersten

### THE BODY, THE RING, AND THE PARTNERS

Written by Jed Clark, age 11  
Director/dramaturg, Kent Alexander

Josiph..... Michael Potts  
Percy..... John Steber  
Chief..... John Steber

### SISTERS

Written by Angela Golden, age 9  
Director/dramaturg, Roma Maffia

Tanya..... Julie Boyd  
Charlene..... Brenda Thomas  
Dr. Williams..... Michael Bernard

### DROOPY AND WHUP

Written by Jeffrey Zambrano, age 13  
Director/dramaturg, Michael Bernard

Whup..... Larry Nathanson  
Doopy..... Oliver Platt  
Ringmaster..... Joe Grifasi

### "The Ballad of Droopy and Whup"

Lyrics by Jeffrey Zambrano, music by David Baron  
Performed by David Gennaro and Jerry Krenach

Thank you for coming! If you are not on our mailing list (or if your address has changed), please fill out this form and give it to us on your way out, or mail it to the address below. We would also like to know if you would like to be of help to us in the future (primarily in the areas of fundraising, backstage and printing). If so, please fill out your name, phone number and areas of interest below.

#### PLEASE ADD ME TO YOUR MAILING LIST:

NAME \_\_\_\_\_

ADDRESS \_\_\_\_\_

\_\_\_\_\_ Zip \_\_\_\_\_

PHONE \_\_\_\_\_

#### YES, I WOULD LIKE TO BE OF HELP:

NAME \_\_\_\_\_

DAYTIME PHONE \_\_\_\_\_

AREA(S) OF INTEREST \_\_\_\_\_

#### ON SALE IN THE LOBBY -- Holiday Items Galore!

52nd Street Project T-Shirts with Shel Silverstein Logo: \$12.00  
"Playmaking" by Daniel Judah Sklar: \$12.00  
The New and *Rad* 52nd Street Project Removable Tattoo: \$1.00  
The Fabulous "Flyer Chocolate Bar": still only a buck  
Remember, one-half of sale price is tax-deductible!

If you would like to mail this (and you're always welcome to enclose a tax-deductible contribution), you can send it to:

The 52nd Street Project  
220 West 42nd Street  
18th Floor  
New York, NY 10036  
(212) 764-1379

The 52nd Street Project gratefully acknowledges the support of the following foundations, corporations, and individuals: The Altman Foundation, The B.E.T.A. Fund, Citibank, N.A., The Liz Claiborne Foundation, Consolidated Edison, Nathan Cummings Foundation, D-B Trust, The Dammann Fund, Educational Foundation of America, The Friar's Foundation, The Florence Gould Foundation, The William and Mary Greve Foundation, The Hennessy Foundation, The Holland Lodge Foundation, The MCJ Foundation, The Marquis George MacDonald Foundation, The James Macdonald Foundation, The Ann M. Martin Foundation, The Joyce Mertz-Gilmore Foundation, Morgan Guaranty Trust Co., Morgan Stanley and Company, The William Morris Agency, The New World Foundation, The New York Times Company Foundation, Noh Hands Productions, Primerica Foundation, The Fan Fox and Leslie R. Samuels Foundation, St. James Church, St. Laurent Associates, Shays & Murphy, Societe Generale, The Threshold Foundation, The Lila Acheson Wallace Theater Fund, The Wasserstein Perella Foundation, The West Bank Cafe and

Jane Anderson	Ned Eisenberg	Greg MacPherson	Sloane Shelton
Alan Arffa/Kay	John P. Engel	Bruce MacVittie	Brian Siberell/Patty
Matschullat	Wendy Ettinger	Roma Maffia/Peter	Dryden
Cathy Barancik	Martha Evans/Per	DeCoste	Ben & Ginny Siegler
Ben Barenholtz	Lofving	Donald Margulies/	Meg Simon
Gary Barton	David Frankel	Lynn Street	Barry Singer
Jessica Bauman	Kermit Frasier	Ann M. Martin	Tom Singer
Terry Belanger	Louis P. Friedman	Rikki Matthews	Lois Smith
Andre Bishop	Bernard Gersten/Cora	Drew McCoy	Erica Spellman-
Mr. & Mrs. G. Bissinger	Cahan	Paul McCrane	Silverman
Susan & Ron Black	Jack Gilpin/Ann	Frances McDormand	Georgette Squire (and
Allison M. Blinks	McDonough	Rebecca Miller	friends)
Risa Bramon/Rene	Marian Godfrey	Patricia Murphy	Robert Stecker
Garcia	Susan Goldstein	James L. Nederlander	Jody Steiner/Myles
Rita & Fred Brooks	Kip Gould	Ellen Novack	Gordon
Eric Brooks	Mark Gould	Janice Novack	Sue Steiner
Becky Browder/Ted	Stephen Graham	Peter & Margaret	Byam Stevens/Robin
Neustadt	Colin Greer/Frances	O'Brien	Tilghman
Garrett M. Brown	LaBarre	Carol Ochs	Byam K. Stevens, Sr.
Kate Burton/Michael	Mina Hammer/Tom	Kevin O'Rourke/Edith	Tom & Maureen
Ritchie	Reale	Thurber	Stewart
Mara Buxbaum	Evan Handler	John & Kristine Pankow	Joy Javits Stewart
Steven Callahan/	Michele Heilbrun	David Peterkin	J. Frederick Stillman, III
Christine Dunn	Rob Hershman	Robert & Susan Phillips	Andrew Sweet/Elise
William Carden	Peter Herdrich	Helen & Peter Randolph	Taylor
Anne Carney	Michele Heilbrun	David Rasche/Heather	Anne Swift
Kathleen Carroll	Jane Hoffman	Lupton	Jay Tarses
Phoebe Cates/Kevin	Billy Hopkins	Nob Rauch/Lisa	Joan Vail Thorne
Klein	Irwin Horowitz	Belshaw	Tracy Thorne
Rachel Chanoff	Mark Jacobs	Tim & Tyson Ray	Laura Valeroso
Joel Coen	Sy Jacobs	Paul Reale	Wendy M. vanden
Marya & Fraser Cohn	Daniel Jenkins/Kathy	Jacquelyn Reingold	Heuvel
Ruth Cohen	Hiler	Joe & Carol Reich	Emma Walton/Stephen
Richard J. Cohn	Cindy Lou Johnson	In memory of Jay	Hamilton
Eleanor Coppola	Bob Joy	Robinson	Bruce & Christine
Neil Cuthbert/Wendy	Eric Karpeles/Mike Sell	Gus Rogerson	Wasserstein
Dasteel	Bill Lambert	Robert de Rothschild	Wendy Wasserstein
Arthur Dantchik	Arthur E. Landi	Donald J. Rothschild	Ira Weitzman
Dale Davis/Harris	Joyce & James Lapenn	Sally & Joseph Russo	Betsy West
Spylios	Jill Larson	Don Schneider	John Wexler
Judy Dennis	Dana Lehman	Richard Schwartz	Jeff & Janine Yass
Moira Driscoll/David	Joshua Lehrer	Seret Scott	Sotos Yannopoulos
Pence, Jr.	Georgette & Morton J.	Barry Shapiro	
William Duff-Griffen	Levy	Bernice Baruch Shawl	(as of 3/25/93)
Jack & June Dunbar	Peter & Marsue		
Jeannine Edmunds	MacNicol		

In addition The 52nd Street Project is truly grateful to the many individuals who have made gifts of less than \$100. FISH OUT OF WATER is also made possible in part with public funds from the National Endowment for the Arts, New York State Council on the Arts, The Department of Youth Services and the New York City Department of Cultural Affairs.

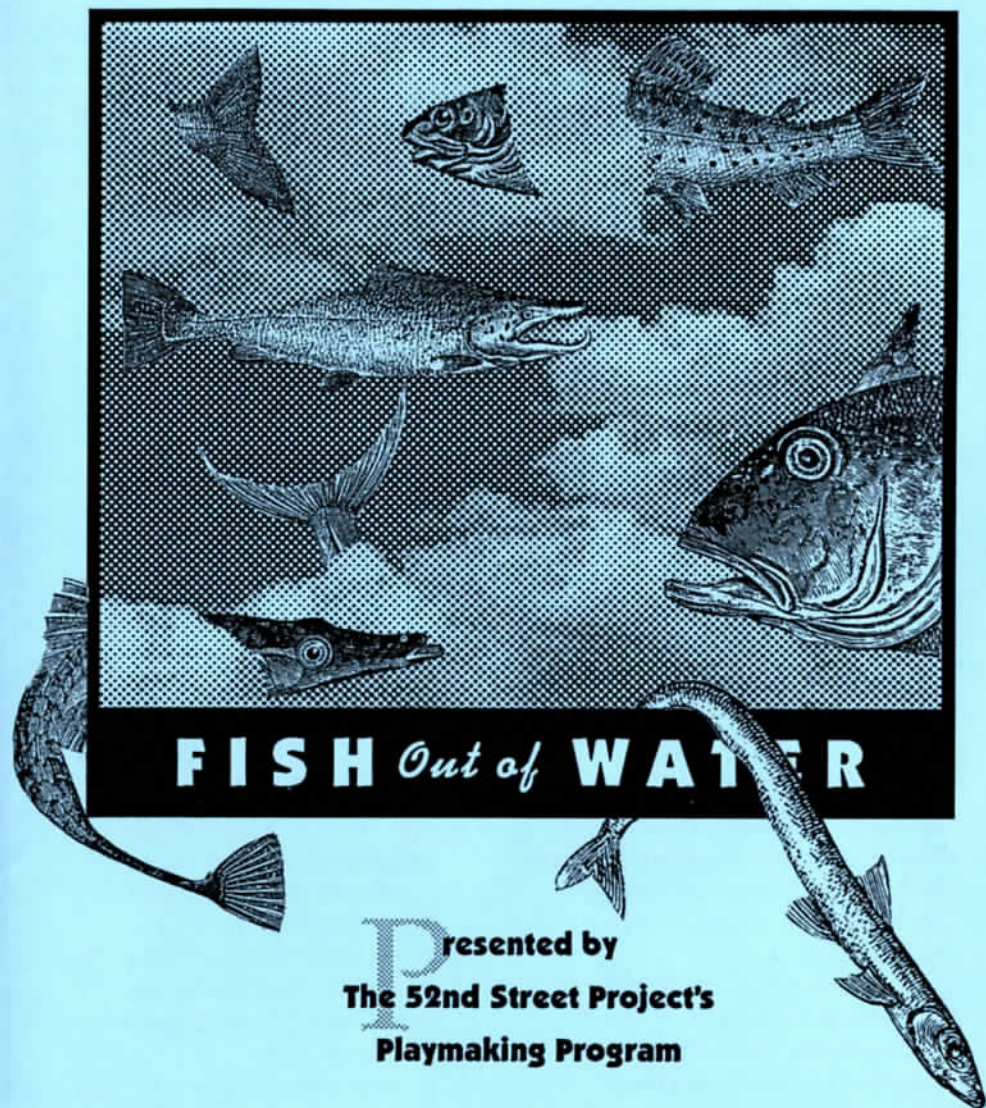

## FISH Out of WATER

Presented by  
The 52nd Street Project's  
Playmaking Program

Ensemble Studio Theatre  
March 26th thru March 28th 1993

The 52nd Street Project presents

## FISH OUT OF WATER

The 1993 Spring Playmaking Plays

March 26, 27, 28, 1993

The Ensemble Studio Theatre  
New York City

### Project Staff

Willie Reale, Artistic Director  
Carol Ochs, Executive Director  
Jenny Gersten, Director of Marketing & Development  
Michael Bernard, Associate Artistic Director  
Jerry McGill, Production Manager  
Susan Vitucci, Development Consultant  
Playmaking Volunteers: Peggy Adler, Lori Jarislow, Barbara McCrane,  
Michaela Murphy, Kevin Roach, Juanita Vega, Joe White  
Project Interns: Nadege Auguste, Janice Deitner, David Strong

### Production Staff

Kevin Joseph Roach, Set Designer	Cindy Tolan & Samona Squire, Colorforms Crew
Greg MacPherson, Lighting Designer	Leigh Fondakowski & Victor Rojas, Props Crew
Sheila Kehoe, Costume Designer	Load-In Crew: Thomas Nahrwold (& truck), Paul Leishman.
David Baron & Bobby Dowd, Composers	David Pence, Jr., & Frank Wood
Simma Gershenson, Stage Manager	Light Hang Crew:
Iris A. Brown, Graphics	Michael Bernard, Jenny Gersten, Katherine Lumb & Carol Ochs
Mina Hammer, Slide Design	Katherine Lumb & Carol Ochs
Katherine Lumb, Props Design	House Manager, Karin Barry
Orli Auslander, Michael Bernard, Karen Cooper & Traci Johnson, Colorforms Design	House Crew:
Keith Benjamin, Sound & Synth	Cathy Dantchik, Beth Emelson,
Alex Crowley, Slide Operator	Lisa Kauffman, Marcia Levine,
Paul Leishman, Furniture Dude	Peter Manning & Carrie Tocci
Wendell Borrero & Richard Schwartz, Furniture Crew	

"Fish Out of Water" is made possible in part by a grant from the MCJ Foundation.

The 52nd Street Project is an independent, nonprofit organization that operates with the cooperation of The Ensemble Studio Theatre and Rheedlen Place, a community-based counselling center located on 51st Street. The Project brings inner-city children together with professional theater artists to create theater.

FISH OUT OF WATER is a production of our Playmaking program that is designed to teach children how to write a play. After eight weeks of classes, each child is given two actors, a theme and a director who guides him or her through the writing of a play during a weekend in the country. These are the fruits of their labors.

### Board of Directors

Ben Barenholtz	Rachel Chanoff
Marsue Cumming, <i>ex officio</i>	Wendy Ettinger, Chair
Louis P. Friedman	Stephen Graham
Heidi Landesman	James McDaniel
Frances McDormand	Patricia M. Murphy
Carol Ochs	Willie Reale
Pamala Tyson	Laura Valeroso

### Special Thanks To:

Michael Cerenzie, Kevin Confoy, Curt Dempster and the entire lovely staff of The Ensemble Studio Theatre; Mike Arsham, Kathy, Ken, Miriam, Joselyn and the entire staff of Rheedlen Place (welcome!); New York Theatre Workshop; Daniel, Ronnie, Margot and Women's Inter-Art; Cora Cahan, Jeffrey Gross and The New 42nd Street; Barbara Ettinger; Wendy Ettinger and Derek McLane; Peter Aaron and Brooke Allen; Cecilia Arana; Jana Brockman; Cathy Dantchik; Catherine Ganey; Kevin Geer; Lisa Kauffman; Mike Kelleher; Barbara McCrane; Sandy Mulvihill; Susan Murray; Kevin Phelan & Susan Willerman; Elisabel Asencio and P.S. 111.

### In-Kind Contributions:

Ensemble Studio Theatre; Hudson Scenic Studios, Inc.; Colorforms; Bruce Cohen & Associates; Shays & Murphy; Sanford Goldstein; Bernhardt/Fudyma Design Group; Stephen Graham, Donald Marcus; Tom Reale; Baron & Baron Productions; Fahrenheit Productions; Patty Dryden & Brian Siberell.



**FISH OUT OF WATER**  
**ACT I**

**JENNY AND PAT**

Written by Patricia Miller, age 8  
Director/dramaturg, June Ballinger

Pat ..... Martha Plimpton  
Jenny ..... Karen Kandel

**FRIENDS FOREVER**

Written by Cordell Horsford, age 9  
Director/dramaturg, Dion Graham

Philip ..... José Soto  
Mother ..... Wendy vanden Heuvel  
Rosie ..... Wendy vanden Heuvel  
"Ballad of Philip and Rosie" -- lyrics by Cordell Horsford, music by David Baron

**THE CAT OUT OF THE BAG**

Written by Mary Vamvoukakis, age 8  
Director/dramaturg, Judy Goldman

Jennifer ..... Myra Taylor  
Spots ..... Robin Morse  
Kidnapper ..... Myra Taylor  
"Hawaii" -- lyrics by Amy Barbosa, music by David Gennaro  
performed by Dave Gennaro and Jerry Krenach

**THE BABY**

Written by Judith Agosto, age 8  
Director/dramaturg, Barbara McCrane

Doctor ..... Frank Wood  
Mattie ..... Erika Alexander  
P.A. System ..... June Ballinger

**BATSY AND STINKY**

Written by Luis Anthony Maldonado, age 7.5  
Director/dramaturg, Michael Bernard

Batsy ..... Tim Meadows  
Stinky ..... Bill Cwikowski  
And Controlla as himself  
"I Created a Masterpiece" -- lyrics by Luis Anthony Maldonado, music by Bobby Dowd and David Baron

## ACT II

### THE ELECTION

Written by Joseph Mohamed, age 8  
Director/dramaturg, Peter Hedges

Martha Washington..... Alexander Draper  
George Washington..... Suzen Murakoshi  
French..... Alexander Draper  
British..... Alexander Draper  
German..... Alexander Draper  
Live music brought to you by Peter Hedges, age 30

### MOMMA ROSE IN THE NORTH POLE

Written by Stephanie Tejada, age 8  
Director/dramaturg, Carmyn Rivera

Adrian..... Juanita Vega  
Juan..... Kevin Geer  
Santa..... Willie Reale

### MY OLD BEST FRIEND

Written by Freddie Matos, Age 8  
Director/dramaturg, Willie Reale

Amanda..... Sandi Francis  
Peter..... Donald Berman  
Michael..... Manny Santiago  
"Puerto Rico Is Boring, New Jersey Is Fun" -- lyrics by Freddie Matos,  
music by David Baron

### SENSITIVE AND SILLY

Written by Kristen Bess, age 9  
Dramaturg, Jerry McGill  
Director, Jane Hoffman

Jessica..... Cecilia Arana  
Baloo..... Daniel Jenkins  
Robber..... Michael Bernard  
"Baloo's Rap" -- lyrics by Kristen Bess, music by David Baron

Thank you for coming! If you are not on our mailing list (or if your address has changed), please fill out this form and give it to us on your way out, or mail it to the address below. We would also like to know if you would like to be of help to us in the future (primarily in the areas of fundraising, backstage and printing). If so, please fill out your name, phone number and areas of interest below.

### PLEASE ADD ME TO YOUR MAILING LIST:

NAME \_\_\_\_\_

ADDRESS \_\_\_\_\_

\_\_\_\_\_ Zip \_\_\_\_\_

PHONE \_\_\_\_\_

### YES, I WOULD LIKE TO BE OF HELP:

NAME \_\_\_\_\_

DAYTIME PHONE \_\_\_\_\_

AREA(S) OF INTEREST \_\_\_\_\_

### ON SALE IN THE LOBBY

52nd Street Project T-Shirts with Shel Silverstein Logo: \$12.00  
"Playmaking" by Daniel Judah Sklar: \$13.00  
The New and *Rad* 52nd Street Project Removable Tattoo: \$1.00  
The Fabulous "Flyer Chocolate Bar": \$1.50  
Remember, one-half of sale price is tax-deductible!

If you would like to mail this (and you're always welcome to enclose a tax-deductible contribution), you can send it to:

The 52nd Street Project  
220 West 42nd Street  
18th Floor  
New York, NY 10036  
(212) 764-1379

**COMING UP AT  
THE 52ND STREET PROJECT...**

**FISH OUT OF WATER**

9 PLAYS BY NEW WRITERS FROM THE PROJECT'S PLAYMAKING PROGRAM

PERFORMED MARCH 26TH, 27TH, AND 28TH HERE AT THE ENSEMBLE STUDIO THEATER. FOR RESERVATIONS CALL (212) 459-4173.

ALSO...CATCH A FISH ON THE AIR, WHEN A PLAYWRIGHT AND HIS/HER CAST GO LIVE ON WNYC (93.9 FM) NEXT SUNDAY, MARCH 21ST FROM 6:00 - 8:00 PM.

**SMALL THINGS CONSIDERED**

THE 52ND STREET PROJECT'S FIRST-EVER REALLY BIG EXTRAVAGANZA BENEFIT, HELD AT THE SUPPER CLUB ON MONDAY, MAY 10TH. THE EVENING INCLUDES SUPPER (OBVIOUSLY), DANCING TO THE SWINGING TUNES OF VINCE GIORDANO'S NIGHTHAWKS, AND A LIVE RADIO CONCERT WITH PERFORMANCES BY PROJECT KIDS AND ADULTS. FOR MORE INFORMATION, CALL JENNY AT (212) 764-1379.

**Triples  
Theater  
BOOK II**

The 52nd Street Project  
presents  
**TRIPLE THREAT<sup>2</sup> -- BOOK 2**

The 1992 Replay Plays  
March 11, 1993

The Ensemble Studio Theatre, New York City

**The 52nd Street Project Staff:**

Willie Reale, Artistic Director  
Carol Ochs, Executive Director  
Michael Bernard, Associate Artistic Director and Triple Threat Deity  
Kevin Roach, Scenic Mentor  
Mylene Santon, Scenic Mentor Assistant  
Jerry McGill, Production Manager  
Jenny Gersten, Director of Marketing and Development  
Susan Vitucci, Development Consultant  
Nadege Auguste, Project Intern  
David Strong, Project Intern

**Production Staff:**

The company plus Claudia Vasquez, Mike Garcia and Toshay Ziegler

**Art Crew:**

All sets built by the company with special guests Claudia Vasquez and Joseph Mohamed

Cover Design by Joell Soto

The 52nd Street Project brings inner-city kids together with professional theater artists to do theater. All of the Replay writers attended Daniel Judah Sklar's eight-week Playmaking course and wrote plays for the productions of "Peace of My Mind" and "Follow The Leader" in 1990-91. In February of last year, they all returned to class for an eight-week Replay course which took them to the next step in playwriting. In May, the Project took 15 Replay kids with a group of friends and family to Esopus, NY for a day-long picnic and reading of their plays with a group of professional actors. The plays were then slated for one of two productions, and for the fifth time in Project history, the plays are "all-kid" produced – writers, directors, actors, and crew. The "squared" symbol after the title signifies that this is the second round of the Triple Threat series.

**TRIPLE THREAT<sup>2</sup> -- BOOK 2**

**LOVE LIES**

Written by Nyita Hanley  
Directed by Yolanda Maldonado  
Adult mentor, Tracy Thorne

Lu ..... Victor Rojas  
Ti ..... Tina Vamvoukakis  
Brother ..... Andre Parks  
Teenagers ..... Evelyn Maldonado

**WHAT ABOUT ME?**

Written by Tina Vamvoukakis  
Directed by Joanne Ramirez  
Adult mentor, Larry Nathanson

Brenda ..... Lori Quinones  
Emily ..... Nyita Hanley  
Terrence ..... Fernando Ramirez  
Martin ..... Eli Barbosa  
Ghost Dad ..... Raymond Harold

**MOONLIGHT**

Written by Joanne Ramirez  
Directed by Gemma Cooper-Novack  
Adult mentor, John Steber

Princess ..... Annette Myrie  
Moonlight ..... Rachel James  
Prince ..... Joell Soto  
Mother ..... Evelyn Maldonado

This performance of Triple Threat will be performed without an intermission

The 52nd Street Project gratefully acknowledges the support of the following foundations, corporations, and individuals: The Altman Foundation, The B.E.I.A. Fund, Cibank, N.A., Consolidated Edison, Nathan Cummings Foundation, DB Trust, The Dornmann Fund, Educational Foundation of America, The First Parish in Concord, The Fritz's Foundation, The Florence Gould Foundation, The William and Mary Greve Foundation, HBO, The Hennessy Foundation, The Holland Lodge Foundation, Iron Mountain Productions, Rose & Eugene Keiner Family Foundation, Kijomyn Theaters, The MCI Foundation, The Marquis George Macdonald Foundation, The James Macdonald Foundation, The Ann M. Martin Foundation, Mercon Coffee, The Joyce Mertz-Gilmore Foundation, Morgan Guaranty Trust Co., Morgan Stanley and Company, The William Morris Agency, The New World Foundation, The New York Times Company Foundation, Noh Hands Productions, Pimisco Foundation, The Pumpkin Foundation, The Fan Fax and Leslie R. Samuels Foundation, St. James Church, St. Laurent Associates, George F. & Myra Shaskan Foundation, The Shubert Organization, Skadden, Arps, Slate, Meagher & Flom, Shays & Murphy, Société Générale, The Threshold Foundation, Variety, Wachter, Grant, Rosen & Katz, The Uta Acheson Walker Theater Fund, The Wasserman Panko Foundation, The West Bank Cafe and...

Mr. & Mrs. Roy A. Abramowitz  
Terry Adams  
May Arneen  
Nancy Arneen/Toby Hoden  
Eugene Anderson/Jenny Morgenstern  
Jane Anderson  
Alan Arffa/Kay Mutschallat  
Bonnie Arffa  
Norma Asnes  
June Ballinger/Michael Goldstein  
Mr. & Mrs. Larry Bangser  
Ben Baranhalz  
Karin Barry  
Kathy Bates/Tony Campisi  
Gary Barton  
Dwight Batteau, Jr.  
Jessica Berman  
Terry Bekinger  
Laurie Beechman/Neil Mazzella  
Kenneth J. Bennett  
Walter Allen Bennett  
Melvyn & Maxine Bergman  
Pam Berlin/William Carden  
Myrna & Barry Bernard  
Nina Bernstein  
Andie Bishop  
Mr. & Mrs. G. Bissinger  
Susan & Ron Black  
Richard Blackstone  
R.O. Blechman  
Allison M. Blinken  
Bita & Fred Brooks  
Eric Brooks  
Becky Browder/Ted Neustadt  
Deborah Brown  
Garrett M. Brown  
Kate Burton/Michael Ritchie  
Mara Busbaum  
Steven Calahan/Christine Dunn  
William Carden  
Anne Carney  
Kathleen Carroll  
Phoebe Cates/Kevin Klein  
Kathleen & Henry Chaffont  
Rachel Chanoff  
William Christian  
Lewis Clayton/Nancy Adelson  
Eric & Stacy Cochran  
Joel Coen/Fran McDormand  
Marya & Fraser Cohn  
Ruth Cohen  
Richard J. Cohn  
Eleanor Coppola  
Laurence Costa  
Eileen Cowell/David Sarnett  
Joan Strauss Cullman  
Neil Cutbert/Wandy Dastel  
Arthur Dantchik  
Cathy Dantchik  
Dale Davis/Harris Spytos  
Jacqueline de la Chaume  
Nicholas DeMarco  
Patricia Dempsey  
Judy Dennis  
Edward Dirugenis  
Dianne Dreyer  
Maira Driscoll/David Pence, Jr.  
William Duff-Griffin  
Mr. & Mrs. Charles Dumas  
Jack & June Dunbar  
Jeannine Edmunds

Ned Eisenberg  
John P. Engel  
Richard P. Ettinger  
Wendy Ettinger  
Martha Evans/Per Lovving  
Nick Evans  
Peter Jay Fernandez  
Liza Finley  
Arthur Fleischer, Jr.  
Kirstine Fleisher & David Sneeddon  
David Frankel  
Kermit Frasier  
Louis P. Friedman  
Judith Garson/Stevan Rappoport  
Thomas Gazornias  
Bernard Gersten/Lara Cohen  
Modeline Lee Gifford  
Jack Gilpin/Ann McDonough  
Marian Godfrey  
Peter & Helen Goldstein  
Susan Gokstein  
Christopher & Joan Dineen Gould  
Mark Gould  
Stephen & Cathy Graham  
Cahn Greer/Frances LaBarre  
Eben Griles & John Kapernick  
Emily Grishman  
Thomas Haikias  
Mina Hammer/Tom Reale  
Evan Handler  
Stephen Hanson  
Peter Hedges/Susan Bruce  
Michele Heilbrun  
Marian Heiskell  
Joy & Harry Henshel  
John Herron  
Rob Hershman  
Peter Herdich/Karen Trott  
Michele Heilbrun  
Jane Hoffman  
Billy Hopkins  
Irwin Horowitz  
Eleanor Huber  
Mark Jacobs  
Sy Jacobs  
Lafanya & Samuel Jackson  
Linda Leroy Janikow  
Daniel Jenkins/Kathy Hiller  
Cindy Lou Johnson  
Lorna Johnson  
M. Lynne Johnson  
Larry & Mary Jones  
Bob Joy  
Julia & Lee Kalchaim  
Judith & Michael Kane  
Eric Kapeles/Mike Sell  
Richard Kastelman  
Seth Klarman  
Robert Klein  
Mary Kong  
Henry Kieger  
Bill Lambert  
Arthur E. Landi  
Joyce & James Laperin  
Thomas La Puppet  
Jill Larson  
Dana Lerman  
Joanna Lehrer  
Jonathan & Stephanie Levi

William & Marcia Levy  
Georgette & Morton J. Levy  
Mary Lusers  
John Lyons  
Bruce MacVittie  
Peter & Marsue MacNicol  
Greg MacPherson  
Bruce MacVittie  
Roma Maffio/Peter DeCoste  
Donald Marquies/Lynn Street  
Ann M. Martin  
Rikki Matthews  
Frank & Linda Mawronicalas  
Cody McClean  
Colleen McCourtney  
Drew McCoy  
Paul McCrane  
James & Hannelore McDaniel  
Tim Meadows  
S. Epitha Merckson  
Rebecca Miller  
Andy Millon/Faye Jackson  
Drew Mlstein  
Jamie Moldofsky  
Mr. & Mrs. Douglas A. Morse  
Jane Muddyman  
Patricia Murphy  
Peter Neufeld  
Elen Novack  
Janica Novack  
Maureen O'Boyle  
Peter & Margaret O'Brien  
Jacki Ochs/Jan Kreeze  
Sharon O'Connor  
Kevin O'Rourke/Edith Thurber  
John & Kristine Pankow  
Russ & Leslie Paparo  
Ted & Jim Peas  
David Peterkin  
Steven Peter  
Thomas P. Peters  
Eise Petrus & David Nigraut  
Robert & Susan Phillips  
Lawrence Polatchek  
David M. Prior  
Christopher Randolph  
Helen & Peter Randolph  
Daniel Rappaport  
David Rasche/Heather Lupton  
Nob Rauch/Lisa Balshaw  
Tim & Tyson Ray  
Paul Reale  
Jacquelyn Reingold  
Janet Reich  
Joe & Carol Reich  
Elizabeth Rigg  
Jerome Robbins  
Kevin & Kathleen Roberts  
In memory of Jay Robinson  
Gus Rogerson  
Minna Rose  
Daryl Roth  
Robert de Rothschild  
Donald J. Rothschild/Lotchen Shivers  
Sally & Joseph Russo

Jane M. Sangerman & Joseph V...  
Joshua Sapan  
Dr. Zeborah Schoel  
Don Schneider  
Richard Schwartz  
Seret Scott  
Barry Shapiro  
Bernice Bousch Showl  
Mr. & Mrs. Charles Shays  
Walter & Hannah Shmerler  
Constance Shulman  
Sloane Shelton  
Brian Siberell/Patty Dryden  
Jerome & Ruth Siegel  
Ben & Ginny Siegler  
Charles Silver  
Jacqueline Simon  
Meg Simon  
Barry Singer  
Tom Singer  
Miles A. Slater  
Luis Smith  
Erica Spellman-Silverman  
Georgette Squire (and friends)  
Paul & Rena Stallings  
Robert Stecker  
Robert Stein  
Jody Steiner/Myles Gordon  
Sue Steiner  
Byam Stevens/Robin Tighman  
Byam K. Stevens, Sr.  
Fisher Stevens  
Tom & Maureen Stewart  
Joy Javits Stewart  
J. Frederick Stillman, III  
Joy Tarses  
Andrew Sweet/Elise Taylor  
Daniel Sweet  
Anne Swift  
Hiroko Tanaka  
Lili Taylor  
Joy Tarses  
Joan Vail Thome  
Tracy Thome  
Stephen Tobias  
Yves & Rachel Tourne  
Adriano Trigrani/Tim Stephenson  
Pamela Tyson  
Richard & Kathie Valeriani  
Laura Valerosa  
Wendy M. vanden Heuvel  
John Vassilaros/Alexandra Gersten  
Susan Vitucci  
Mary Pat Walsh  
Emma Walton/Stephen Hamilton  
Bruce & Christine Wasserstein  
Wendy Wasserstein  
Neil Wassner/Deborah Baker  
John Weidman  
Ira Weitzman  
Mitch Weitzner/Judy Tygard  
Robert & Andrea Weiner  
Treat Williams  
Betsy West  
John Westler  
Jeff & Janine Yass  
Sotia Yannopoulos

## THE 52ND STREET PROJECT PRESENTS

# BLAST FROM THE PAST



**THE 1993  
ONE-ON-ONE  
PLAYS**

**ENSEMBLE STUDIO THEATRE  
JULY 22ND THRU JULY 25 1993**

In addition The 52nd Street Project is truly grateful to the many individuals who have made gifts of less than \$100. BLAST FROM THE PAST is also made possible in part with public funds from the National Endowment for the Arts, New York State Council on the Arts, The Department of Youth Services and the NYC Department of Cultural Affairs.

The 52nd Street Project Presents  
The 1993 One-on-Ones

**BLAST FROM THE PAST**

The Pennsylvania Plays

July 22, 23, 24, 25

The Ensemble Studio Theatre - New York City

**Project Staff**

Willie Reale, Artistic Director  
Carol Ochs, Executive Director  
Jenny Gersten, Director of Marketing & Development  
Michael Bernard, Associate Artistic Director  
Jerry McGill, Production Manager  
Susan Vitucci, Development Consultant  
Iris A. Brown, Staff Graphic Designer  
Joanne Ramirez & Paula Myrie, Junior Counselors  
Marie Gaumy, Intern

**Production Staff**

Henry Krieger, Composer & Music Director  
Kevin Joseph Roach, Set Designer  
Greg MacPherson, Lighting Designer  
Kevin Brainerd, Costume Designer  
Joshua Lehrer, Stage Manager  
Mina Hammer, Slide Design  
Mike Sell, Props Design  
Suzy Kitman & Karen Cooper,  
Colorforms Design  
Paula Myrie, Choreography  
Keith Benjamin, Sound & Synth  
Noel Dawkins, Slide Operator  
Alex Heath, Light Board Operator  
Mike Kelleher & Kevin Zucker,  
Furniture Crew

Cindy Tolan & Victor Rojas,  
Colorforms Crew  
Leigh Fondakowski & Diana Rojas,  
Props Crew  
Light Hang Crew:  
Alex Heath, Darryl Swanson  
House Managers, Karin Barry & Beth  
Emelson  
House Crew:  
Stephanie Diozzi, Elizabeth Dugger,  
Erica McConnell, Lane Mitchell,  
Dana Segal, Erica Tener  
Eric Karpeles, Blast From The Past  
Repasts

The 52nd Street Project is a nonprofit organization that brings inner-city children from the Clinton neighborhood together with professional theater artists to create theater. BLAST FROM THE PAST is a production of our One-on-One program, which is designed to give children the opportunity to go away for one week stays in the country and enjoy the undivided attention of a professional theater artists who serves as friend, mentor and role model.

**Board of Directors**

Ben Barenholtz	Rachel Chanoff
Marsue Cumming, <i>ex officio</i>	Wendy Ettinger, Chair
Louis P. Friedman	Stephen Graham
Larry Jones	Heidi Landesman
James McDaniel	Frances McDormand
Patricia M. Murphy	Carol Ochs
Willie Reale	Pamala Tyson
Laura Valeroso	

**Special Thanks To:**

The best families: Noah Baen & Karen Schmeckpepper, Bill, Linda, Sean & Kelley, Cobb, Joan Henry, Chuck, Andrea, Melanie & Emma Heyn, Liz Huntington & Dan Brinkerhoff; our regular families; Martha Sader; Sally and Joseph Russo; Wayne Braffman & Roberta Crane; David Sneddon and Fairway Market; Jerry Durkin; Steve, Joe, Suzanne, Laura and the Double W Ranch; Larry Wolhandler; Anna Rutledge; Mark and Wendy; Paul Reale; Marissa Chibas; Barbara McCrane; Suzanne Glennon; Joanne Ramirez; Carol Clarke; Christopher Dansby Fisher; Kevin Geer; Judy Goldman; Jenny Peek; Jocelyn Rappaport; Tom Schall; Wendy Stulberg; Jeff Williams; Nick's Coffee Shop; Paul Geier, Frank Kane; Doctor Becker and the Doctor at the Emergency Room; Trisha Cook; and most importantly and especially, Hildy, Walter, Knightley, Mike and Eric.

**In-Kind Contributions:**

Ensemble Studio Theatre; Hudson Scenic Studios, Inc.; Fairway Market; Colorforms; Bruce Cohen & Associates; Shays & Murphy; Bernhardt/Fudyma Design Group; Joel Coen/Hudsucker Productions; Stephen Graham; Lincoln Center Theater; Tom Reale; Patty Dryden & Brian Siberell.

# BLAST FROM THE PAST

## ACT I

### SOMETIMES Y

Written by Joel Coen & Frances McDormand for Raymond Harold, age 12

Directed by Frances McDormand

Cave Son . . . . . Raymond Harold  
Cave Mom . . . . . Frances McDormand  
"Sometimes Y" lyrics by Joel Coen

### TO BEAT OR NOT TO BEAT

Written and directed by Jacquelyn Reingold for Judy Agosto, age 9

Bianca in the Black Beret . . . . . Judy Agosto  
Tammy . . . . . Jacquelyn Reingold  
Hula-Hoop Choreography by Judy Agosto

### TO BEE OR NOT TO BEE

Written and directed by Susan Kim for Yolanda Maldonado, age 14

Ms. Noah . . . . . Jake-ann Jones  
Bee . . . . . Yolanda Maldonado  
"The Importance of Bees is Earnest" lyrics by Willie Reale

### RELUCTANT GEORGE AND THE DRAGON

Written and directed by Charles Dumas for Jed Clarke, age 11

Sir George . . . . . Jed Clarke  
Mayor . . . . . Charles Dumas  
Dragon . . . . . Charles Dumas  
"Jed's Song" lyrics by Charles Dumas and Willie Reale

### DISCO DIVA

Written and directed by Robert Shaffron for Evelyn Maldonado, age 11

Shirley . . . . . Evelyn Maldonado  
Sharpy . . . . . John Steber  
"Disco Diva" and "I Miss My Mother" lyrics by Robert Shaffron

### THINGS ARE LOOKING BETTER EVERY DAY

Written and directed by Willie Reale for Samantha Soto, age 8

Samantha . . . . . Samantha Soto  
Vincenzo . . . . . Willie Reale  
"America My Love" "La Storia Di Vincenzo" "Things Are Looking Better Every Day" lyrics by Willie Reale

• I N T E R M I S S I O N •

## ACT II

### THE EDUCATION AND ENLIGHTENMENT OF TRIGINOMETRIES, A SLAVE

Written and directed by Michael Bernard for Jeffrey Zambrano, age 13

Triginometries, a slave . . . . . Jeffrey Zambrano  
Sacariliac, a Greek god . . . . . Michael Bernard  
"To Be Super" "Sometimes You Gotta Come on Down" lyrics by Michael Bernard

### CLEO COOL AND THE AGONY OF YOUTH

Written by Ned Eisenberg for Natasha Soto, age 10

Directed by Cass Morgan

Girl . . . . . Cass Morgan  
Cleopatra . . . . . Natasha Soto  
"You Gotta Wait Your Turn" lyrics by Ned Eisenberg

### ORLANDO AND LA CONTESSA

Written by Chris Ceraso for Luis Anthony Maldonado, Age 8

Directed by Barbara McCrane

Orlando . . . . . Luis Anthony Maldonado  
La Contessa . . . . . Barbara McCrane  
Porthole Pirate . . . . . Paul Reale  
"Santa Maria del Sol" lyrics by Chris Ceraso

### BEATLEMANIACS

Written and directed by Bill Wrubel for Elisa Mohamed, age 11

Tina . . . . . Elisa Mohamed  
Gina . . . . . Myra Taylor  
Paul . . . . . Bill Wrubel  
"Beatle Wife" lyrics by Bill Wrubel & Willie Reale; "Queens Girl" lyrics by Bill Wrubel

### JOSH DREAMS

Written by Peter Hedges, age 31 for Joseph Mohamed, age 8

Directed by Marissa Chibas

Josh . . . . . Joseph Mohamed  
Mom . . . . . Marissa Chibas  
Mom at Nine . . . . . Natasha Soto  
"Josh's Lullaby" lyrics by Willie Reale

Thank you for coming! If you are not on our mailing list (or if your address has changed), please fill out this form and give it to us on your way out, or mail it to the address below. We would also like to know if you are interested in becoming a volunteer. We are always in need of help in all areas, so, please fill out your name, address and phone number.

#### PLEASE ADD ME TO YOUR MAILING LIST:

NAME \_\_\_\_\_

ADDRESS \_\_\_\_\_

\_\_\_\_\_ Zip \_\_\_\_\_

PHONE \_\_\_\_\_

#### YES, I WOULD LIKE TO BE OF HELP:

NAME \_\_\_\_\_

HOME PHONE \_\_\_\_\_

I AM REALLY USEFUL AT (52nd Street Project related things only, i.e. mailings, backstage help, fundraising, etc.) \_\_\_\_\_

#### ON SALE IN THE LOBBY

52nd Street Project T-Shirts with Shel Silverstein Logo: \$12.00

"Playmaking" by Daniel Judah Sklar: \$13.00

A Rad 52nd Street Project Removable Tattoo: \$1.00

The Fabulous "Flyer Chocolate Bar": \$1.50 (\$1.00 for kids)

The latest in 52 Merchandise: Baseball Caps in 3 Glorious Colors! \$15.00

Remember, one-half of sale price is tax-deductible!

If you would like to mail this (and you're always welcome to enclose a tax-deductible contribution), you can send it to:

The 52nd Street Project  
220 West 42nd Street, 18th Floor  
New York, NY 10036  
(212) 764-1379



The 52nd Street Project gratefully acknowledges the support of the following foundations, corporations, and individuals: The Altman Foundation, The B.E.T.A. Fund, Citibank, N.A., Consolidated Edison, Nathan Cummings Foundation, DB Trust, The Darmann Fund, Educational Foundation of America, The First Parish in Concord, The Friar's Foundation, The Florence Gould Foundation, The William and Mary Greve Foundation, HBO, The Hennessy Foundation, The Holland Lodge Foundation, Iron Mountain Productions, Rose & Eugene Kainer Family Foundation, Jappyn Theatre, The KCI Foundation, The Marquis George MacDonald Foundation, The James Macdonald Foundation, The Ann M. Martin Foundation, Harlan Coffee, The Joyce Hertz-Gilmore Foundation, Morgan Guaranty Trust Co., Morgan Stanley and Company, The William Morris Agency, The New World Foundation, The New York Times Company Foundation, Noh Harsh Productions, Painesia Foundation, The Pumpkin Foundation, The Fox and Leslie R. Samuels Foundation, St. James Church, St. Laurent Associates, George F. & Myra Shezkan Foundation, The Shubert Organization, Skadden, Arps, Slate, Meagher & Flom, Shays & Murphy, Societe Generale, The Threshold Foundation, Variety, Wachtel, Lipson, Rosen & Katz, The Lila Acheson Wallace Theater Fund, The Wasserstein Family Foundation, The West Bank Cafe and...

Mr. & Mrs. Roy A. Abramowitz  
Terry Adams  
May Ameen  
Nancy Ameen/Toby Hodan  
Eugene Anderson/Jerry Margenthau  
Jane Anderson  
Alan Arlio/Kay Matschuliet  
Bernie Arho  
Norma Anees  
June Ballinger/Michael Goldstein  
Mr. & Mrs. Larry Bangser  
Ben Baranzhiltz  
Karin Barry  
Kathy Bates/Tony Campisi  
Gary Barton  
Dwight Battreau, Jr.  
Jessica Bouman  
Terry Belsinger  
Laurie Beechman/Neil Mazzella  
Kenneth J. Bennett  
Walter Allen Bennett  
Melvyn & Maxine Bergman  
Pam Berlin/William Carden  
Myrna & Barry Bernard  
Nina Bernstein  
Andre Bishop  
Mr. & Mrs. G. Bissinger  
Susan & Ron Black  
Richard Blackstone  
R.O. Blachman  
Allison M. Blinken  
Rita & Fred Brooks  
Eric Brooks  
Becky Browder/Ted Neustadt  
Deborah Brown  
Garrett M. Brown  
Kate Burton/Michael Ritchie  
Mara Busbaum  
Steven Callahan/Christine Dunn  
William Carden  
Anne Carney  
Kathleen Carroll  
Phoebe Cates/Kevin Klein  
Kathleen & Henry Chaffont  
Rachel Chanoff  
William Christian  
Lewis Clayton/Wancy Adelson  
Eric & Stacy Cochran  
Joel Cohn/Tam McCharmand  
Marya & Fraser Cohn  
Ruth Cohn  
Richard J. Cohn  
Eleanor Coppola  
Laurence Costa  
Eileen Cowell/David Sarnett  
Joan Straus Cullman  
Neil Culbert/Wendy Desteal  
Arthur Dantchik  
Cathy Dantchik  
Dale Davis/Harris Spylios  
Jacqueline de la Chaume  
Nicholas DeMarco  
Patricia Dempsey  
Judy Dennis  
Edward DiRugieri  
Dianne Dreyer  
Moira Driscoll/David Pence, Jr.  
William Duff-Griffen  
Mr. & Mrs. Charles Dumas  
Jack & Jane Dunbar  
Jeannine Edmunds

Ned Eisenberg  
John P. Engel  
Richard P. Entinger  
Wendy Entinger  
Martha Evans/Per Lohring  
Nick Evans  
Peter Jay Fernandez  
Liza Finley  
Arthur Fleischer, Jr.  
Kristine Fleischer & David Sneddon  
David Frankel  
Kermit Frasier  
Louis P. Friedman  
Judith Garson/Steven Rappoport  
Thomas Gazzoni  
Bernard Gersten/Cara Cahan  
Madeline Lee Gifford  
Jack Gilpin/Ann McDonough  
Marian Godfrey  
Peter & Helen Goldstein  
Susan Goldstein  
Christopher & Joan Diveen Gould  
Mark Gould  
Stephen & Cathy Graham  
Colin Greer/Frances LaBarre  
Ellen Griles & John Kapernick  
Emily Grishman  
Thomas Hallikas  
Aline Hammer/Tom Reale  
Evan Handler  
Stephen Hanson  
Peter Hedges/Susan Bruce  
Michele Heilbrun  
Marian Heiskill  
Joy & Harry Henshel  
John Herron  
Rob Hershman  
Peter Herdich/Karen Troit  
Michele Heilbrun  
Jane Hoffman  
Billy Hopkins  
Irwin Horowitz  
Eleanor Huber  
Mark Jacobs  
Sy Jacobs  
LoTanya & Samuel Jackson  
Linda Levy Janklow  
Daniel Jenkins/Kathy Hiler  
Cindy Lou Johnson  
Lorna Johnson  
M. Lynne Johnson  
Larry & Mary Jones  
Bob Joy  
Julia & Lee Kalchheim  
Judith & Michael Kane  
Eric Kaprielis/Mike Sell  
Richard Kastelman  
Seth Klamon  
Robert Klein  
Mary Kong  
Henry Krieger  
Bill Lambert  
Arthur E. Landi  
Joyce & James Lappens  
Thomas La Puppel  
Jill Larson  
Dana Lehman  
Joshua Lehrer  
Jonathan & Stephanie Levi

William & Marcia Levy  
Georgette & Marlon J. Levy  
Mary Ludes  
John Lyons  
Bruce MacVittie  
Peter & Marsue MacNical  
Greg MacPherson  
Bruce MacVittie  
Roma Marfin/Peter DeCoste  
Donald Margulies/Lynn Street  
Ann M. Martin  
Rikki Matthews  
Frank & Linda Mavronicalas  
Cody McClain  
Colleen McCourtney  
Drew McCay  
Paul McCrane  
James & Hannelore McDaniel  
Tim Meadows  
S. Epitha Merckson  
Rebecca Miller  
Andy Millan/Faye Jackson  
Drew Milstein  
Jamie Moklatsky  
Mr. & Mrs. Douglas A. Morse  
Jane Muddyman  
Patricia Murphy  
Peter Neufeld  
Elen Novack  
Janice Novack  
Maureen O'Boyle  
Peter & Margaret O'Brien  
Carol Ochs  
Jacki Ochs/Jan Kroeze  
Sharon O'Lannon  
Kevin O'Rourke/Edith Thurber  
John & Kristine Parikow  
Russ & Leslie Paparo  
Ted & Jim Pados  
David Peterkin  
Steven Peter  
Thomas P. Peters  
Elise Petrus & David Algrant  
Robert & Susan Phillips  
Lawrence Palatchek  
David M. Prior  
Christopher Randolph  
Helen & Peter Randolph  
Daniel Rappoport  
David Rasche/Heather Lupton  
Nob Rauch/Lisa Belslow  
Tim & Tyson Ray  
Paul Reale  
Jacquelyn Reingold  
Janet Reich  
Joe & Carol Reich  
Alexandra Rhodie  
Elizabeth Riggs  
Jerome Robbins  
Kevin & Kathleen Roberts  
In memory of Joy Robinson  
Gus Rogerson  
Minna Rose  
Daryl Roth  
Robert de Rothschild  
Donald J. Rothschild/Lattchen Shivers  
Sally & Joseph Russo

Jane M. Sangerman & Joseph Vadopoulos  
Joshua Sapan  
Dr. Zevah Schachtel  
Dan Schneider  
Richard Schwartz  
Sere Scott  
Barry Shapiro  
Bernice Bouch Showl  
Mr. & Mrs. Charles Shays  
Walter & Hannah Shemerler  
Constance Shulman  
Sloane Shelton  
Brian Siberall/Patty Dryden  
Jerome & Ruth Siegel  
Ben & Ginny Siegler  
Charles Silver  
Jacqueline Simon  
Mag Simon  
Barry Singer  
Tom Singer  
Miles A. Slater  
Luis Smith  
Erica Spellman-Silverman  
Georgette Squire (and friends)  
Paul & Rena Stallings  
Robert Stecker  
Robert Stein  
Judy Steiner/Myles Gordon  
Sue Steiner  
Byam Stevens/Robin Tighman  
Byam K. Stevens, Sr.  
Fisher Stevens  
Tom & Maureen Stewart  
Joy Jovits Stewart  
J. Frederick Stillman, III  
Jay Tarses  
Andrew Sween/Elise Taylor  
Daniel Sween  
Anne Swift  
Hiroya Tanaka  
Lili Taylor  
Jay Tarses  
Joan Vail Thome  
Tracy Thome  
Stephen Tobias  
Yves & Rachel Tourne  
Adriana Trigianni/Tim Stepherson  
Pamala Tyson  
Richard & Kathie Valeriani  
Laura Valeriso  
Wendy M. vanden Heuvel  
John Vassilakos/Alexandra Gersten  
Susan Vitucci  
Mary Pat Walsh  
Emma Walton/Stephen Hamilton  
Bruce & Christine Wasserstein  
Wendy Wasserstein  
Neil Wassner/Deborah Baker  
John Weidman  
Ima Weitzman  
Mitch Weitzner/Judy Tygard  
Robert & Andrea Weiner  
Treat Williams  
Betsy West  
John Weiler  
Jeff & Janine Yass  
Sotos Yannopoulos

in # 1/21/93

# THE 52ND STREET PROJECT

## PRESENTS

# BLAST FROM THE PAST

## ENSEMBLE STUDIO THEATRE

AUGUST 26TH THROUGH AUGUST 29TH 1993

In addition The 52nd Street Project is truly grateful to the many individuals who have made gifts of less than \$100. BLAST FROM THE PAST is also made possible in part with public funds from the National Endowment for the Arts, New York State Council on the Arts, The Department of Youth Services and the NYC Department of Cultural Affairs.

The 52nd Street Project Presents  
The 1993 One-on-Ones

**BLAST FROM THE PAST**

The Block Island Plays

August 26, 27, 28, 29

The Ensemble Studio Theatre - New York City

**Project Staff**

Willie Reale, Artistic Director  
Carol Ochs, Executive Director  
Jenny Gersten, Director of Marketing & Development  
Michael Bernard, Associate Artistic Director  
Jerry McGill, Production Manager  
Susan Vitucci, Development Consultant  
Iris A. Brown, Staff Graphic Designer  
Marie Gaumy, Wendy Valdez, Kevin Zucker, Interns  
Shirley Rumierk, Junior Counselor and Cameo Hog  
Bruce MacVittie, Understudy

**Production Staff**

Henry Krieger, Composer  
Tim Ray, Music Director  
Kevin Joseph Roach, Set Designer  
Jan Kroeze, Lighting Designer  
Sheila Kehoe & Karen Rosten, Costume Designers  
Katherine Lumb, Stage Manager  
Mina Hammer, Slide and Prop Design  
Mike Sell & Katherine Lumb, Props Design  
Evan Bernard & Karen Cooper, Colorforms Design  
Vanessa Valdes, Sound Operator  
Noel Dawkins, Slide Operator

Kevin Zucker & Peter Manning, Furniture Crew  
Taro Alexander, Erica Borrero & Shirley Rumierk, Colorforms Crew  
Leigh Fondakowski & Victor Rojas, Props Crew  
Light Hang Crew:  
Michael Bernard, Jan Kroeze, Peter Ludwig, Katherine Lumb  
House Manager, Karin Barry  
House Crew:  
Beth Emelson, Laura Jones, Erika McConnell, Lane Mitchell, Laura Sametz, Mary Pat Walsh, Erica

The 52nd Street Project is a nonprofit organization that brings inner-city children from the Clinton neighborhood together with professional theater artists to create theater. BLAST FROM THE PAST is a production of our One-on-One program, which is designed to give children the opportunity to go away for one week stays in the country and enjoy the undivided attention of a professional theater artist who serves as friend, mentor and role model.

**Board of Directors**

Ben Barenholtz	Rachel Chanoff
Marsue Cumming, <i>ex officio</i>	Wendy Ettinger, Chair
Louis P. Friedman	Stephen Graham
Larry Jones	Heidi Landesman
James McDaniel	Frances McDormand
Patricia M. Murphy	Carol Ochs
Willie Reale	Pamala Tyson
Laura Valeroso	

**Special Thanks To:**

Most families: Rita and Steve Draper, Lyn, Bob and Jimmie Reale, Jennifer and Elliot Taubman, Judy and Ron Tierney; Dr. Cristina Biaggi; Virginia Dare and Joya Verde; Bob and Linda Frumolt; Annie Reale; Martha MacDonald; Pat McQuade; Interstate Navigation; Ken Cadow at the Depot; Peter the Meat at B.I.G.; McQuade's Market Place; Glen and Gary Hall; Hunter Tracy; Prudy Buckley and The Ice Cream Place; Gary Pollard and the Empire Theater; Alexandra Gersten and Johnny Vassilaros; Greg MacPherson and Noel Dawkins; Fran and Rally Migliaccio; The Block Island Medical Center; Phil O'Donnell and Winfields; Ed McGovern; Don Thimble; Joshua Lehrer; Larry Malvern; Meg Scott; Larry Nathanson; Neil Mazzella; Cora Cahan, Jeffrey Gross and The New 42; Leigh Fondakowski; Katie Atcheson; Marie Gaumy; Cecilia Arana; Barbara McCrane; Frank Wood; Dion Graham; Kevin Zucker; Taro Alexander; Jessica Soto; Diana Rojas; Victor Rojas; Bruce MacVittie; Jeff Williams.

**In-Kind Contributions:**

Ensemble Studio Theatre; Hudson Scenic Studios, Inc.; Fairway; Colorforms; Bruce Cohen & Associates; Shays & Murphy; Bernhardt/Fudyma Design Group; Joel Coen/Hudsucker Productions; Stephen Graham; Lincoln Center Theater; Tom Reale; Patty Dryden & Brian Siberell.

# BLAST FROM THE PAST

## ACT I

**BLAST FROM THE PAST THEME SONG** — The Company

### A DECENT CUP OF TEA

Written and directed by Michael Bernard for Freddy Matos, age 9

Lord Greystoke . . . . . Michael Bernard  
Tarzan . . . . . Freddy Matos  
Cheetah . . . . . Michaela Murphy  
"In The City" and "Me At Home" lyrics by Michael Bernard

### BLOCK ISLAND MELODRAMA

Written and directed by Demitri Corbin for Erica Borrero, age 10

Johnnie, the Piano Man . . . . . Larry Malvern  
Diamond Lil . . . . . Erica Borrero  
Daphne . . . . . Shirley Rumierk  
"Dream On" lyrics by Demitri Corbin

### OUT ON A LIMB

Written and directed by Thom Babe for Cordell Horsford, age 10

John . . . . . Cordell Horsford  
Timmie . . . . . Thom Babe  
Old Salty Dog . . . . . Michael Imperioli  
"Out On A Limb" lyrics by Willie Reale

### JOE AND THE KID

Written by Charles Fuller for Desmond Robertson, age 9

Directed by Dion Graham

Teacher . . . . . Dion Graham  
Kid . . . . . Desmond Robertson  
Joe Louis . . . . . Dion Graham  
"Just The Graces" and "I Wish I Could Help Joe" lyrics by Charles Fuller

### OH BOY

Written and directed by Lili Taylor for Fernando Ramirez, age 12

Princess Barbara . . . . . Lili Taylor  
Tilbogen . . . . . Fernando Ramirez  
"Amusing Barbara" and "One Step At A Time" lyrics by Willie Reale

• INTERMISSION •

## ACT II

### RICK SWAN AND THE MYSTERIOUS BLONDE

Written and directed by J. McGill for Eddie Zambrano, age 11

Rick Swan ..... Eddie Zambrano  
Nora ..... Shirley Rumierk  
Lou ..... J. McGill  
"Nice Guys Finish First" lyrics by J. McGill, music by Henry Krieger and J. McGill

### WHAT'S MINE LINE?

Written and directed by Michaela Murphy for Jennifer Socarras, age 10

Nonny ..... Michaela Murphy  
Wilhemina ..... Jennifer Socarras  
"Nice Elizabethan Girl" and "Just Pretend" lyrics by Willie Reale

### THE SPIRIT OF '77

Written and directed by Willie Reale for Amy Barbosa, age 9

Captain Rottenquitter ..... Willie Reale  
Amy, a courier ..... Amy Barbosa  
"A Missive From George" "Rottenquitter's Reply" and "Let Go" lyrics by Willie Reale

### DAINTY DAISY DONNER

Written by Carl Capotorto for Diana Rojas, age 15

Directed by Roma Maffia

Dainty Daisy Donner ..... Diana Rojas  
Agnes ..... Roma Maffia  
"The Sun Above" lyrics by Carl Capotorto, "We're Never Looking Back" lyrics by Willie Reale

Thank you for coming! If you are not on our mailing list (or if your address has changed), please fill out this form and give it to us on your way out, or mail it to the address below. We would also like to know if you are interested in becoming a volunteer. We are always in need of help in all areas, so, please fill out your name, address and phone number.

#### PLEASE ADD ME TO YOUR MAILING LIST:

NAME \_\_\_\_\_

ADDRESS \_\_\_\_\_

\_\_\_\_\_ Zip \_\_\_\_\_

PHONE \_\_\_\_\_

#### YES, I WOULD LIKE TO BE OF HELP:

NAME \_\_\_\_\_

PHONE \_\_\_\_\_

I AM REALLY USEFUL AT (52nd Street Project related things only, i.e. mailings, backstage help, fundraising, etc.) \_\_\_\_\_

#### ON SALE IN THE LOBBY

52nd Street Project T-Shirts with Shel Silverstein Logo: \$12.00

"Playmaking" by Daniel Judah Sklar: \$13.00

A Rad 52nd Street Project Removable Tattoo: \$1.00

The Fabulous "Flyer Chocolate Bar": \$1.50 (\$1.00 for kids)

The latest in 52 Merchandise: Baseball Caps in 3 Glorious Colors! \$15.00

Remember, one-half of sale price is tax-deductible!

If you would like to mail this (and you're always welcome to enclose a tax-deductible contribution), you can send it to:

The 52nd Street Project  
220 West 42nd Street, 18th Floor  
New York, NY 10036  
(212) 764-1379

The 52nd Street Project gratefully acknowledges the support of the following foundations, corporations, government agencies and individuals: The Altman Foundation, The Bret Adams Agency, Citibank, N.A., The Liz Claiborne Foundation, Consolidated Edison, Nathan Cummings Foundation, D-B Trust, The Dammann Fund, The Department of Youth Services, The Dramatists Guild Fund, Educational Foundation of America, The Florence Gould Foundation, The William and Mary Greys Foundation, The Hennessy Foundation, The Holland Lodge Foundation, The Kids Fund, The Eugene and Rose Kleiner Family Foundation, The MCJ Foundation, The Marquis George MacDonald Foundation, The James Macdonald Foundation, The Ann M. Martin Foundation, Morgan Guaranty Trust Co., Morgan Stanley and Company, The William Morris Agency, The New World Foundation, The New York Times Company Foundation, Primerica Foundation, The Samuel and May Rudin Foundation, The Fan Fox and Leslie R. Samuels Foundation, St. Laurent Associates, The Threshold Foundation, The Life Acheson Wallace Theater Fund, The Wessnerstein Perella Foundation, The West Bank Cafe and

William R. Adams/J. Koopels  
Beth Adams  
Nancy Adelson/Clayton Lewis  
Lynette E. Allison  
Alan Arfa/Kay Mutschallat  
Margot Avery  
Jean Bacharach  
Anne Bailey/Charles Wright  
Dorothy Baker  
Dominick Ballato/Irene Wilots  
Michael Bender  
Cathy Boranick  
Ben Boranick  
Miranda Barry  
Jessica Bauman  
Christopher Beach  
Terry Balanger  
Carlene Berger  
Pat & Howard Berka  
Amy Birnbaum  
Andre Bishop  
Mr. & Mrs. G. Bissinger  
Susan & Ron Block  
Allison M. Blinkan  
Mark Blum  
Risa Brannon/Rene Garcia  
Rita & Fred Brooks  
Eric Brooks  
Becky Browder/Ted Neustadt  
Garratt M. Brown  
Dorothy Brown  
David Buskin  
Cafe Film Center  
Joel Coen  
Steven Callahan/Christine  
Dunn  
William Carden  
Anne Carney  
Claire L. Chaloe  
Rochal Chanoff  
Ellen Chenoweth  
Michael & Pamela Chopiga  
Louis Chiffarone  
Marya & Fraser Cohn  
Ruth Cohn  
Richard J. Cohn  
The Cooper Committee  
Michael Cristofar  
Edla Cursick  
Neil Cuthbert/Wendy Dostool  
Arthur Danzikh  
Maia Danziger  
Leslee Dart  
Dale Davis/Harris Spylios

Carol & Booth Deakins  
Judy Dennis  
Jodi Sh. Doll  
Polly Draper  
Moira Driscoll  
William Duil-Griffin  
Jack & June Dunbar  
Anne Bailey/Charles Wright  
Eliott & Hammer  
John P. Engel  
Wendy Etlinger  
Martha Evans/Pat Loring  
Bill Fagan/John/Catherine  
McDonahan  
Peter Jay Fernandez  
Alexa A. Fogel  
Tom Fontana/Sagan Lewis  
Janine Foreman/Caroline  
Aaron  
David Frankel  
Lisa Frey/John McLaughlin  
Lois P. Friedman  
Ma Ganey  
Thomas L. Gazzonis  
Bernard Gershen/Cara Cohen  
Jack Gipple/Ann McDonough  
The Gechemans  
Sanford Goldstein  
Edward & Susan Goldstein  
Susan Goldstein  
Helen & Peter Goldstein  
Christopher Gould  
Mark Gould  
Stephen Graham  
Rosalind Gray  
In honor of Cara Greene  
Susan Greenhill  
Colin Greer/Francais LaBarre  
Lynne Guyanheim  
Albert R. Gurney  
Lynne Hallday  
Jonathan Hamel  
Mina Hammer/Tom Reale  
Carl, Kathleen &  
Zella Hammer  
Evan Handler  
Kamrya Harding  
Gerard E. Harper  
Diane Haskall  
Joyne Haynes/John Patrick  
Shanley  
Peter Herdrich  
Michelle Heilbrun  
Rob Harshman

Jane Hoffman  
Mary Holloway  
Billy Hopkins  
Irwin Horowitz  
Thomas Puka  
Amy Injacoma/John Henry  
Doris  
Yves-Andre Isral  
Mark Jacobs  
Sy Jacobs  
Cindy Lee Johnson  
Avah Pevler Johnson  
Elnor Jones  
Bob Joy  
Michael Kama/Judith Rudnick  
Ira Karasick/Wera Jacobson  
Mark J. Kennedy  
Patti Kipperman  
Tracy Knights  
Rita Knox/Stephen Cohen  
Judy Kuhn  
Marcia Jean Kurtz  
Larvis M. Kvit  
Pamela Lock  
Bill Lambert  
Gloria Landes  
Arthur E. Landi  
Joyce Lapann  
Jill Larson  
Katie Laor  
Joshua Lehrer  
Priscilla Lives  
Georgette & Morgan J. Levy  
Derek Livingston  
John Bedford Lloyd/Anne  
Twomey  
Lisa Loesamora  
Mr. & Mrs. Stephen Lumb  
John Lyons  
Peter & Marsue MacNicol  
Greg MacPherson  
Roma Malin/Peter DeCeste  
Michelle S. Magazine  
Carry Maloney/Hermes Malton  
James Maloney  
Donald Margulies/Lynn Street  
Ann M. Martin  
Carmen Mathews  
Ricki Matthews  
Joan McAllister  
Paul McCrane  
Frances McDermand  
Joanna Martin/David Dratzin  
Jan & Richard Merrill

Elsa Breton Miller  
Patricia Murphy  
Lila Starley Murphy  
Susan Murray  
John G. Nardi  
Liz Nealon  
James L. Nederlander  
Peter Neufeld  
Peter Newman  
Cynthia Nixon  
Eliot Novack  
Peter O'Brien  
James L. Oakes  
Carol Ochs  
Kevin O'Rourke/Edith  
Thurber  
Henry D. Osberg  
John & Kristina Pankow  
F. Richard Pappas  
Eliot Parker/Mack Lipkin  
Judy Kuhn  
David Peterkin  
Ruth Peterkin  
Thomas P. Peters  
Robert & Susan Phillips  
Helen & Peter Randolph  
Nob Rauch/Lisa Belshaw  
Tim & Tyson Ray  
Paul Reale  
Jacquelyn Raingold  
Julie Ridge  
Elizabeth Rigg  
Lillian Robertson  
Gus Rogerson  
Bruce & Ellen Roseman  
Mack Russell  
Robert de Rothschild  
Donald J. Rothschild  
Joyce Rudnick  
Larry & Deborah Schiff  
Greg Schneider  
Ken & Mary Ann Schuster  
Sara Scott  
Angela & John Scrimanti  
Susan Shacter  
Barry Shapiro  
Murray Shapiro  
Bernice Baruch Showl  
Brian Sbaroff/Patty Dryden  
Ban & Ginny Siegler  
Judith Slegman  
Joey Silverman  
Meg Simon  
Jacqueline Simon

Barry Singer  
Tom Singer  
Isadora & Judith Singer  
Lois Smith  
Susan Solomon  
Erica Spellman-Silverman  
Jerome Spina, Jr.  
Florence Stanley/Martin  
Newman  
Robert Stocker  
Jerry Storer  
Byron Stevens/Robin  
Tilghman  
Byron K. Stevens, Sr.  
Tom & Maurine Stewart  
Joy Javits Stewart  
J. Frederick Stillman, III  
Andrew Swaab/Elsa Taylor  
Daniel Swaab  
Anne Swift  
Joy Tarses  
Lili Taylor  
Michael Thomas  
Stanley & Gloria Thomas  
Joan Vall Thorne  
Tracy Thorne  
Catherine C. Tracy  
Kathleen Turner  
Judith Tygard  
Laura Valerese  
Peter Valerese/Charles  
Goldberg  
Wendy M. Vanden Houvel  
Scott Waara  
Emma Walton/Stephen  
Hamilton  
Mr. & Mrs. Charles G. Ward,  
III  
Bruce & Christin Wessnerstein  
John Weidman/Lita Coleburn  
Ira Weitzman  
Mitchell A. Weitzner  
Betsy West  
Mr. & Mrs. Robert Wilder  
Donald Windham  
Gwan Winston  
Kathryn & Robert Wolfe  
Margaret L. Wolf  
Brian & Dutch Wolf  
Andrew Walk  
Joanna Woodward  
Jeff & Janine Yess  
Sotou Yannopoulos  
Janet Zarish  
(as of August 1992)

The 52nd Street Project  
at Graham-Windham  
presents

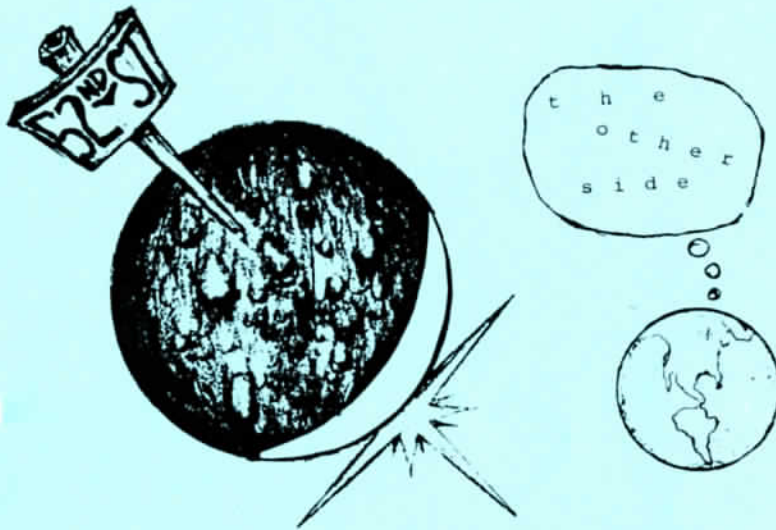

THE ENSEMBLE STUDIO THEATER  
SEPTEMBER 1,2,3 1993

Joe M...  
355-  
2940

In addition the 52nd Street Project is truly grateful to the many individuals who have made gifts of less than \$100. WHO'S WHO? is also made possible in part with public funds from the New York State Council on the Arts and the New York City Department of Cultural Affairs.

Graham-Windham and The 52nd Street Project present  
**The Other Side**

One on Ones at Graham-Windham

September 1,2,3 1993

Ensemble Studio Theatre - New York City

### Project Staff

Willie Reale, Artistic Director  
Carol Ochs, Executive Director  
Michael Bernard, Associate Artistic Director  
Jenny Gersten, Director of Marketing & Development  
Jerry McGill, Production Manager  
Susan Vitucci, Development Consultant  
Iris A Brown, Graphic Designer  
June Ballinger, Director - 52nd Street at Graham-Windham  
Susan Willerman, Asst. to Director-52 Street at Graham-Windham

### Production Staff

Michelle Kay, stage manager & lights  
Katherine Lumb, slide design  
Daryl Swanson, colorform, props,  
additional slide design and sound  
Jeff Day, slide photographer  
Mark O'Conner, lighting design  
Alice King, costumes  
Scott Shina, prod. asst. and wrangler  
Kevin Joseph Roach, set designer  
Jocelyn Rappaport, front of house  
Connie Schlier, slide operator  
Stacey Ivey, crew  
Carmie Daily, crew  
Toshay Ziegler, crew  
Lisa Timmel, crew  
Cheri Morse, crew  
Elizz Benson, house manager  
Rochelle Hogue, house manager  
Tess Healy, house manager  
Claudette Rowe, asst. house mgr.

### Graham-Windham

John Sargent, Board Chair  
Suzanne F. Bales, Senior Vice Chair  
Joyce S. Lapenn, President and CEO  
Lonnie Stafford, Vice President,  
Residential Treatment Center  
Al Rodriguez, Director, Residential  
Treatment Center  
Larry Tobin, Unit Director

### Ensemble Studio Theatre

Curt Dempster, Artistic Director  
Michael Goldstein, Board Chair  
Jaimie Richards, Director of Summer  
Conference  
Michael Cerenzie, Associate Prod.  
Elizz Benson, Asst. to Artistic Dir.

**The 52nd Street Project at Graham-Windham** brings together kids at Graham-Windham with professional theatre artists to create theatre. *The Other Side* is part of our one-on-one program that pairs professional playwrights and actors with kids. Six kids and six actor/playwrights spent a week together in the Hamptons, where the artists wrote one act plays for themselves to perform in with their kid partners. **The 52nd Street Project** is an independent, nonprofit organization that operates with the cooperation of The Ensemble Studio Theatre. **Graham-Windham**, founded in 1806, annually serves more than 6,000 children from families throughout the New York area. Its services include foster care and adoption; group homes and residential treatment for abused, neglected and emotionally disturbed children.

### The 52nd Street Project Board of Directors

Ben Barenholtz	James McDaniel
Rachell Chanoff	Frances McDormand
Marsue Cumming, <i>ex officio</i>	Patricia M. Murphy
Wendy Ettinger, Chair	Carol Ochs
Louis P. Friedman	Wille Reale
Stephen Graham	Pamala Tyson
Larry Jones	Laura Valeroso
Heidi Landesman	

### Special Thanks To:

Curt Dempster and the Ensemble Studio Theatre; Mark O'Conner; Steve Hamilton and the Bay Street Theater Festival; Susan Gunn; Ruth Weinstock; Priscilla & Christian & Tomas Myhersky; Sidney Reynolds; Robert Kalfin; Beryl Bernay; Juanita & Frank Wimberly; Mr. & Mrs. John Sargent; Marge & Lloyd Day; Eileen O'Neill and South Hampton College; Jesse Soto; The Renzi family; Joe at Main St. Properties; Western Connecticut State University; Judy Tate for her piano and Scott Shina for his coaching and fun.

### Kind Contributions:

Ensemble Studio Theatre; Hudson Scenic Studios, Inc.; Colorforms; Sanford Goldstein; Bernhardt Fudyma Design Group; Stephen Graham.

## **The Other Side**

One on Ones at Graham-Windham

September 1,2,3 1993

Ensemble Studio Theatre - New York City

*THE OTHER SIDE*.....lyrics by Scott Shina and all the  
kids.

*MAGIC COFFEE CAFE* written and directed by Emily Rubin for Corrine  
Hawkins

Rhonda.....Corrine Hawkins  
Somalle.....Emily Rubin  
customer.....Susan Willerman  
*lyrics by Emily Rubin*

*NEW TRICKS* written and directed by Joe Gilford for Shawn Sincino  
Olddog.....Shawn Sincino  
Man/young man.....Joe Gilford  
Woman.....June Ballinger

*BAD GIRL* written and directed by Judy Tate for Danita Fisher  
Dede.....Danita Fisher  
Muse.....Judy Tate  
Headmistress.....Susan Willerman  
*music and lyrics by Judy Tate*

*THE CURE* written and directed by Will Badgett for Claudette Rowe  
Harold.....Will Badgett  
Dr. Bailey.....Jesse Soto  
Assistant.....Claudette Rowe  
*lyrics by Will Badgett; music by Debra Barsha*

*SIX FEET DEEP* written and directed by Kent Alexander for  
Lawrence Carrol  
Troy.....Lawrence Carrol  
Pops.....Kent Alexander  
Friend.....Shawn Sinceno  
God.....Will Badgett

*STAR* written and directed by Sal Trapani for Shannon Warren  
Julie Jubilee.....Shannon Warren  
Eddie.....Sal Trapani  
*music and lyrics by Sal Trapani*

**Understudy for all characters, Jesse Soto**

*This show will be performed without an intermission*

Thank you for coming! If you are not on our mailing list (or if your address has changed), please fill out this form and give it to us on your way out, or mail it to the address below. We would also like to know if you are interested in becoming a volunteer. We are always in need of help in all areas, so, please fill out your name, address and phone number.

**PLEASE ADD ME TO YOUR MAILING LIST:**

NAME \_\_\_\_\_

ADDRESS \_\_\_\_\_

\_\_\_\_\_ Zip \_\_\_\_\_

PHONE \_\_\_\_\_

**YES, I WOULD LIKE TO BE OF HELP:**

NAME \_\_\_\_\_

DAYTIME PHONE \_\_\_\_\_

I AM REALLY USEFUL AT (52nd Street Project related things only, i.e. mailings, backstage help, fundraising, etc.) \_\_\_\_\_

**ON SALE IN THE LOBBY**

52nd Street Project T-Shirts with Shel Silverstein Logo: \$12.00

"Playmaking" by Daniel Judah Sklar: \$13.00

A Rad 52nd Street Project Removable Tattoo: \$1.00

The Fabulous "Flyer Chocolate Bar": \$1.50 (\$1.00 for kids)

The latest in 52 Merchandise: Baseball Caps in 3 Glorious Colors! \$15.00

Remember, one-half of sale price is tax-deductible!

If you would like to mail this (and you're always welcome to enclose a tax-deductible contribution), you can send it to:

The 52nd Street Project  
220 West 42nd Street, 18th Floor  
New York, NY 10036  
(212) 764-1379



The 52nd Street Project gratefully acknowledges the support of the following foundations, corporations, and individuals: The Aaron Foundation, The B.E.T.A. Fund, Citibank, N.A., Conradi/Edison, Nathan Cummings Foundation, D&B Trust, The Doremus Fund, Educational Foundation of America, The First Parish in Concord, The Fair's Foundation, The Florence Gould Foundation, The William and Mary Center Foundation, HBO, The Harway Foundation, The Holland Lodge Foundation, Jon Mountain Productions, Rose & Eugene Weiner Family Foundation, Saperstein Trust, The AKJ Foundation, The Atlantic George MacDorland Foundation, The Jerome MacDorland Foundation, The Art M. Martin Foundation, Alcon Coffee, The Joyce Metz-Gibson Foundation, Morgan Guaranty Trust Co., Morgan Stanley and Company, The William Weiss Agency, The New World Foundation, The New York Times Company Foundation, Noh Harsh Productions, Phoenix Foundation, The Pumpkin Foundation, The Pan Fun and Leslie R. Sornow Foundation, St. James Church, St. Leonard Association, George F. & Myra Sheehan Foundation, The Student Organization, Stables, Arts, State, Mather & Ross, Shays & Murphy, Societe Generale, The Threshold Foundation, Vining, Wickard, Light, Rosen & Katz, The Libby Avenue Wallace Theatre Fund, The Wozzerman Family Foundation, The West Bank Cafe and...

Mr. & Mrs. Roy A. Abramowitz  
Terry Adams  
Ally Aronson  
Nancy Aronson/Toby Hodan  
Eugene Anderson/Jenny Margerthaus  
Tom Anderson  
Alan Arlin/Kay Martschall  
Barbara Arlo  
Ronna Aronson  
Jane Ballinger/Michael Goldstein  
Mr. & Mrs. Larry Bergner  
Ben Bernhardt  
Karin Berry  
Kathy Bates/Tony Conroy  
Gary Barton  
Dwight Battman, Jr.  
Jessica Bauman  
Terry Beckman  
Laurie Bechman/Wed Mazzola  
Kermit J. Bennett  
Walter Alan Bennett  
Melysa E. Maxine Bergman  
Pam Berlin/Willem Lardon  
Myrna & Barry Bernard  
Nico Bernstein  
Andra Bichig  
Mr. & Mrs. G. Bissinger  
Susan & Rex Black  
Richard Blackstone  
E.D. Blackman  
Alison M. Blackman  
Blou & Fred Brooks  
Eric Brooks  
Becky Browder/Ted Neustadt  
Deborah Brown  
Garrett M. Brown  
Kate Burton/Michael Biehn  
Heim Buchman  
Sharon Calahan/Christine Dunn  
William Lardon  
Anna Carney  
Kathleen Carroll  
Phyllis Carter/Kevin Cain  
Kathleen & Henry Oshroff  
Rachel Chavall  
William Christian  
Lavin Clayton/Nancy Mahan  
Eric & Stacy Cochran  
Joel Coen/Fran McDermott  
Maysa & Frank Cohen  
Barb Cohen  
Richard J. Cohen  
Doranne Cappola  
Laurance Cerio  
Elaine Cowell/David Schwartz  
Joan Cowan/Gabriel  
Neil Cullbert/Wendy Drexler  
Arthur Dantschik  
Cathy Dantschik  
Dale Davis/Timothy Saylor  
Jacqueline de la Chausse  
Michelle DeLorenzo  
Patricia Dempsey  
Judy Deneo  
Edward DiRuggieri  
Doranne Dwyer  
Maize Dworkin/David Pecca, Jr.  
William Duff-Giffen  
Mr. & Mrs. Charles Duran  
Jack & Jane Durbin  
Ineziana Edmunds

Neil Eisenberg  
John P. Engel  
Richard P. Estinger  
Wendy Estinger  
Martha Evans/Tue Lohring  
Rick Evans  
Peter Jay Farnsworth  
Liza Fein  
Arthur Feinstein, Jr.  
Kristine Fletcher & David Sondheim  
David Frankel  
Kamell Frasier  
Louis P. Friedman  
Judith Garson/Steven Rappaport  
Thomas Geometric  
Bernard Gersten/Lara Cohen  
Rochelle Lee Gilford  
Jack Gilpin/Jen  
McDonough  
Morris Godfrey  
Peter & Helen Goldstein  
Susan Goldstein  
Christopher & Joan Dwean Gould  
Mark Gould  
Stephan & Cathy Graham  
Celia Gray/Terence LeBarre  
Eben Greer & John Kaprowick  
Emily Grisman  
Thomas Hallinan  
Alan Hammer/Tam Raabe  
Fran Handler  
Stephan Hansen  
Peter Halden/Susan Bruce  
Michelle Halloran  
Alicia Haiskell  
Joy & Harry Harshel  
John Harrow  
Rob Harrowman  
Peter Harshbich/Karen Ivett  
Michelle Heffernan  
Joan Heffernan  
Billy Heffernan  
Irwin Herzog  
Eleanor Huber  
Mark Jacobs  
Sy Jacobs  
Lorraine & Samuel Jackson  
Linda Lenny Jackson  
Daniel Jenkins/Kathy Hill  
Cindy Lee Johnson  
Lana Johnson  
M. Yanna Johnson  
Larry & Mary Jones  
Bob Joy  
Julia & Len Kaldman  
Judith & Michael Kane  
Eric Kaprielian/Mika Sell  
Richard Kaserman  
Seth Karmann  
Robert Klein  
Mary Kang  
Henry Karger  
Bill Lambert  
Arthur E. Lanil  
Joyce & James Lapeere  
Thomas La Pappat  
Bill Larson  
Dore Lehman  
Joshua Lerner  
Jonathan & Stephanie Levi

William & Marcia Levy  
Georgette & Martin J. Levy  
Mary Leiders  
John Lyons  
Bruce MacVittie  
Peter & Marlene MacVittie  
Greg MacPherson  
Bruce MacVittie  
Kenny Mullin/Peter DeCasta  
Donald Margulies/Lynn Street  
Ann M. Martin  
Bill Matthews  
Frank & Linda Mavroukales  
Coby McClain  
Colleen McCourtney  
Drew McCoy  
Paul McCrone  
James & Harvelore McDaniel  
Tam McElvaine  
S. Epithio Mackeson  
Rebecca Miller  
Andy Milburn/Troy Jackson  
Drew Millman  
Janice Minkoffsky  
Mr. & Mrs. Douglas A. Morse  
Janice Muddiman  
Patricia Murphy  
Peter Newfield  
Ellen Novack  
Janica Novack  
Alverson O'Boyle  
Peter & Margaret O'Brien  
Carol Ochi  
Joceli Odeh/Jun Eneze  
Sharon O'Carroll  
Kevin O'Rourke/Edith Thurber  
John & Estelle Pankow  
Russ & Leslie Pappas  
Ted & Sue Peiris  
David Peterson  
Steven Peter  
Thomas P. Peters  
Elsa Petrus & David Agrant  
Robert & Susan Phillips  
Lawrence Politchuk  
David H. Prior  
Christopher Randolph  
Helen & Peter Randolph  
Daniel Rappaport  
David Rasche/Wendy Lupton  
Niki Rasch/Lisa Balshaw  
Tim & Tyson Ray  
Paul Reade  
Jacqueline Reingold  
Janet Reich  
Joe & Carol Reich  
Alexandra Reade  
Elizabeth Rigg  
Jerome Roberts  
Kevin & Kathleen Roberts  
In memory of Jay Robinson  
Gus Robinson  
Alvino Rosa  
Daryl Roth  
Robert de Rothschild  
Dorced J. Rothschild/Lanthen Shivers  
Sally & Joseph Russo

Joan M. Sargenson & Joseph Vardapian  
Judith Sapan  
Dr. Zubinski Schachtel  
Dan Schneider  
Richard Schwartz  
Scott Scott  
Betsy Shapiro  
Barbara Shovich Show  
Mr. & Mrs. Charles Shays  
Walter & Harrosh Shemer  
Cecilia Shulman  
Sharon Shulman  
Brian Silver/Pratty Dryden  
Janette & Ruth Segal  
Ben & Garry Singer  
Charles Silver  
Jacqueline Simon  
Magg Simon  
Barry Singer  
Tom Singer  
Miles A. Siskin  
Lain Smith  
Erica Spaulman-Silverman  
Georgette Segal (and friends)  
Paul & Janet Stralings  
Robert Stricker  
Robert Stein  
Judy Steiner/Myles Gordon  
Sue Steiner  
Byron Steiner/Robin Tipler  
Byron E. Steiner, Sr.  
Felix Steiner  
Tom & Rosemary Stewart  
Joy Judith Stewart  
J. Frederick Stillman, III  
Joy Torres  
Andrew Swann/Bliss Taylor  
Daniel Swann  
Anne Swift  
Hiroko Tanaka  
Liz Taylor  
Joy Torres  
Joan Vall Brown  
Lucy Thorne  
Stephan Tobias  
Tom & Rachel Toome  
Adriana Triguero/Tim Stephenson  
Pamela Truan  
Richard & Kathie Vekstein  
Luana Volante  
Wendy M. van den Hoed  
John Vassilopoulos/Helen Gerstein  
Susan Vercel  
Mary Pat Walsh  
Emma Walton/Stephen Harshman  
Bruce & Christine Wasserstein  
Wendy Wasserstein  
Neil Wasser/Doranne Baker  
John Weinman  
Jo Weinman  
Mick Weitzman/Judy Tygard  
Robert & Andrea Wiener  
Trent Williams  
Betty West  
John Weiser  
Jeff & Jennie Yess  
Sara Yampopoulos

## The 52nd Street Project presents

# Pivotal Roles

New York Theatre Workshop  
October 30, 31 and November 1st

w 417/71

In addition, the 52nd Street Project is truly grateful to the many individuals who have made gifts of less than \$100. PIVOTAL ROLES is also made possible in part with public funds from the National Endowment for the Arts, New York State Council on the Arts, the Department of Youth Services, and the NYC Department of Cultural Affairs.

**The 52nd Street Project Presents  
The 1993 Playback Plays**

**Pivotal  
Roles**

**October 30, 31 & November 1, 1993  
New York Theatre Workshop - New York City**

**Project Staff**

Willie Reale, Artistic Director  
Carol Ochs, Executive Director  
Jenny Gersten, Director of Marketing & Development  
Michael Bernard, Associate Artistic Director  
Jerry McGill, Production Manager  
Susan Vitucci, Development Consultant  
Iris A. Brown, Staff Graphic Designer  
Mollie Langston, Project Intern

**Production Staff**

Kevin Joseph Roach, Set Designer	Taro Alexander & Kevin Zucker, Furniture Crew
Greg MacPherson, Lighting Designer	Mollie Langston & Shirley Rumierk, Props Crew
Sue White, Assistant Lighting Designer	Mike Sell & Eric Karpeles, Flyer Graphics
Simma Gershenson, Stage Manager	Peter Manning, House Manager
Katherine Lumb, Slide Design	House Crew:
Jeff Day, Slide Photographer	Julie Sukman, Erica Tener
Kim Chandler, Karen Cooper & Traci Johnson, Props Design	
Vanessa Valdes, Sound	
Noel Dawkins, Slide Operator	

PIVOTAL ROLES is made possible in part by grants from The Berrilla Kerr Foundation, The Pumpkin Foundation, Morgan Stanley and The B.E.T.A Fund.

The 52nd Street Project is a non-profit organization that brings inner-city children from the Clinton neighborhood together with professional theater artists to create theater. PIVOTAL ROLES is a production of our Playback program. In it, an adult actor/playwright is paired with a kid actor/playwright. The duo is charged to create two characters for which the kid then writes a play. The adult then responds with a second play using at least one of the two characters. The program was invented to challenge kids who are veterans of the Project's acting and writing programs.

**Board of Directors**

Ben Barenholtz	Rachel Chanoff
Wendy Ettinger, Chair	Louis P. Friedman
Stephen Graham	Larry Jones
Heidi Landesman	James McDaniel
Frances McDormand	Patricia M. Murphy
Carol Ochs	Willie Reale
Pamala Tyson	Laura Valeroso

**Special Thanks To:**

Jim, Nancy, Carla, Esther, Glen, Sue, Eric and everyone else at New York Theatre Workshop; Peggy Adler and New Dramatists; Greg MacPherson and Noel Dawkins; Richard Kornberg; Cora Cahan, Jeffrey Gross and the New 42; Judy Goldman; Peter Herdrich; the entire, generous company of "Blown Sideways Through Life"; Kevin Joseph Roach; Katie Atcheson; Dan Jenkins; Karen Kandel; Suzy Kitman; Mia; Susan Murray; Peter Sarsgard; Lili Taylor.

**In-Kind Contributions:**

Caribiner; Ensemble Studio Theatre; Hudson Scenic Studios, Inc.; Colorforms; Fairway; Bruce Cohen & Associates; Shays & Murphy; Sanford Goldstein; Bernhardt/Fudyma Design Group; Stephen Graham; Lincoln Center Theater; Tom Reale; Patty Dryden & Brian Siberell; New Dramatists.

## **PIVOTAL ROLES**

### **1993 Playback Plays**

#### **MONEY PROBLEMS**

Written by Tina Vamvoukakis, Age 14

Directed by Willie Reale

Susan..... Tina Vamvoukakis  
Ann..... Karen Kandel

#### **LUCKY DUCK**

Written and Directed by Willie Reale

Ann..... Tina Vamvoukakis  
The Lucky Duck..... Karen Kandel

#### **NO PLACE LIKE HOME - Scene 1**

Written by Jill Barbosa, Age 14

Directed by William Wise

Mom..... Jill Barbosa  
Son..... William Wise  
Zorka..... Arleigh Richards

#### **NO PLACE LIKE HOME - Scenes 2 & 3**

Written and Directed by William Wise

Son/Father..... William Wise  
Zorka..... Arleigh Richards  
Zorkina..... Jill Barbosa

#### **FRIENDSHIP AND ADVICE**

Written by Lori Quinones, Age 14

Directed by Karen Trott

Jackie..... Karen Trott  
Samantha..... Lori Quinones  
Dad..... William Wise  
Mom..... Karen Trott

#### **IT'S ALWAYS SOMETHING**

Written and Directed by Karen Trott

Samantha..... Lori Quinones  
Juno..... Karen Trott  
Dad..... William Wise

**AGAINST ALL ODDS**

Written by Joanne Ramirez, Age 16

Directed by Cassandra Medley

Dr. Porter.....Cassandra Medley  
Denise.....Gina Torres  
Melissa.....Joanne Ramirez  
Secretary.....Cassandra Medley

**THE SENATOR**

Written and Directed by Cassandra Medley

Senator.....Gina Torres  
Secretary.....Cassandra Medley  
Elder Woman.....Joanne Ramirez  
Stephanie.....Joanne Ramirez

**UNCLE SAM'S BOND WAGON AGAIN**

Written by Victor Rojas, Age 13

Directed by Peter Jay Fernandez

Paulie.....Peter Jay Fernandez  
Vincent.....Victor Rojas  
Steven Spielberg.....Bruce MacVittie

*Flashback*

**EVERYBODY GET ON UNCLE SAM'S BOND WAGON**

Written by Francis Ford Coppola

Directed by Peter Jay Fernandez

Vincent.....Peter Jay Fernandez  
Paulie.....Victor Rojas  
Mr. Vanni.....Bruce MacVittie

"Everybody Get on Uncle Sam's Bond Wagon" music & lyrics by Carmine Coppola; "I'm Sorry" lyrics by Victor Rojas, music by David Baron.

**"Pivotal Roles" will be performed without an intermission**

Thank you for coming! If you are not on our mailing list (or if your address has changed), please fill out this form and give it to us on your way out, or mail it to the address below. We would also like to know if you are interested in becoming a volunteer. We are always in need of help in all areas, so, please fill out your name, address and phone number.

**PLEASE ADD ME TO YOUR MAILING LIST:**

NAME \_\_\_\_\_

ADDRESS \_\_\_\_\_

\_\_\_\_\_ Zip \_\_\_\_\_

PHONE \_\_\_\_\_

**YES, I WOULD LIKE TO BE OF HELP:**

NAME \_\_\_\_\_

DAYTIME PHONE \_\_\_\_\_

I AM REALLY USEFUL AT (52nd Street Project related things only, i.e. mailings, backstage help, fundraising, etc.) \_\_\_\_\_

**ON SALE IN THE LOBBY**

- 52nd Street Project T-Shirts with Shel Silverstein Logo: \$12.00
  - "Playmaking" by Daniel Judah Sklar: \$13.00
  - A Rad 52nd Street Project Removable Tattoo: \$1.00
  - The Fabulous "Flyer Chocolate Bar": \$1.50 (\$1.00 for kids)
  - The latest in 52 Merchandise: Baseball Caps in 3 Glorious Colors! \$15.00
- Remember, one-half of sale price is tax-deductible!

If you would like to mail this (and you're always welcome to enclose a tax-deductible contribution), you can send it to:

The 52nd Street Project  
220 West 42nd Street, 18th Floor  
New York, NY 10036  
(212) 764-1379

The 52nd Street Project gratefully acknowledges the support of the following foundations, corporations, and individuals: The Altman Foundation, Applause Printing & Graphics, The B.E.T.A. Fund, Citibank, Consolidated Edison, Barbara Bell Cumming Foundation, Nathan Cummings Foundation, DB Trust, The Dammann Fund, Educational Foundation of America, The First Parish in Concord, The Fritz Foundation, The William and Mary Grove Foundation, HBO, The Hennessy Foundation, The Hokland Lodge Foundation, Iron Mountain Productions, The Benita Kerr Foundation, Rose & Eugene Kliner Family Foundation, Kijamyn Theaters, The MCI Foundation, The Marquis George MacDonald Foundation, The James MacDonald Foundation, The Ann M. Marin Foundation, Maroon Coffee, The Joyce Matz-Gilmore Foundation, Morgan Guaranty Trust Co., Morgan Stanley and Company, The William Morris Agency, The New World Foundation, The New York Times Company Foundation, Noh Harods Productions, Primavera Foundation, The Pumpkin Foundation, The Fox and Leslie R. Samuels Foundation, St. James Church, The Shubert Organization, Skadden, Arps, Slate, Meagher & Flom, Shays & Murphy, The Threshold Foundation, Variety, Wachtel, Lipton, Rosen & Katz, The Lila Acheson Wallace Theater Fund, The Wassenstein Perella Foundation, The West Bank Cafe, as well as matching gifts from AT&T, Bankers Trust and the Rockefeller Group and the following individuals:

Mr. & Mrs. Roy A. Abramowitz  
Terry Adams  
May Ameen  
Nancy Ameen & Toby Hoden  
Eugene Anderson & Jenny Margenthal  
Jane Anderson  
Alan Arffa & Kay Matuschillat  
Bonnie Arffa  
Norma Jones  
June Baillinger & Michael Goldstein  
Mr. & Mrs. Larry Bangser  
Ben Baranzhitz  
Karin Barry  
Kathy Bates & Tony Campisi  
Gary Barton  
Dwight Batteau, Jr.  
Jessica Bauman  
Terry Bekinger  
Louise Beechman & Neil Mazzella  
Neil Bell  
Kenneth J. Bennett  
Walter Allen Bennett  
Melynn & Maxine Bergman  
Pam Beckin & William Carden  
Myrna & Barry Bernard  
Nina Bernstein  
Andre Bishop  
Mr. & Mrs. G. Bissinger  
Susan & Ron Black  
Richard Blockstone  
R.D. Bledman  
Alison M. Blinken  
Patricia Bradbury  
Rita & Fred Brooks  
Eric Brooks  
Becky Browder & Ted Neustadt  
Deborah Brown  
Garrett M. Brown  
Kate Burton & Michael Ritchie  
Mara Buzbaum  
Steven Callahan & Christine Dunn  
William Carden  
Anne Carney  
Kathleen Carroll  
Phoebe Cates & Kevin Klein  
Kathleen & Henry Chaffart  
Rachel Chanoff  
William Christian  
Lewis Clayton & Nancy Adelson  
Eric & Stacy Cochran  
Joel Coen/Fran McDermott  
Marya & Fraser Cahn  
Ruth Cohen  
Richard J. Cohn  
Eleanor Coppola  
Laurence Costa  
Eileen Cowell & David Sennett  
Joan Straus Gullman  
Neil Cuthbert & Wendy Dasteel  
Arthur Dantchik  
Cathy Dantchik  
Dale Davis & Harris Spyllos  
Jacqueline de la Chourne  
Nicholas DeMarzo  
Patricia Dempsey  
Judy Dennis  
Edward DiRogaris  
Dianne Dreyer  
Maira Discol & David Pence, Jr.  
William Duff-Griffen  
Mr. & Mrs. Charles Dumas  
Jack & June Dunbar

Jeanine Edmunds  
Ned Eisenberg  
John P. Engel  
Richard P. Entinger  
Wendy Entinger  
Martha Evans & Per Lohving  
Nick Evans  
Peter Jay Fernandez  
Liza Finley  
Arthur Fleischer, Jr.  
Kristine Fleisher & David Sweddon  
Bridget Fando & Eric Stoltz  
David Frankel  
Kermit Frazier  
Louis P. Friedman  
Judith Garson & Steven Rappaport  
Thomas Gazanics  
Bernard Gersten & Cara Cahon  
Madeleine Lee Gifford  
Jack Gilpin & Ann McDonough  
Marion Godfrey  
Peter & Helen Goldstein  
Susan Goldstein  
Christopher & Joan Dineen Gould  
Mark Gould  
Stephen & Cathy Graham  
In memory of Kermit Greene  
Colin Greer & Frances LaBarre  
Elen Griles & John Kapernick  
Emily Grishman  
Thomas Hallikas  
Hina Hammer & Tam Reale  
Evan Handler  
Stephen Hanson  
Peter Hedges & Susan Bruce  
Michele Heilbrun  
Marion Heiskell  
Joy & Harry Henshel  
John Herron  
Rob Hershman  
Peter Herdrich & Karen Trott  
Michele Heilbrun  
Jane Hoffman  
Billy Hopkins  
Irwin Horowitz  
Eleanor Huber  
Mark Jacobs  
Sy Jacobs  
LaTanya & Samuel Jackson  
Linda Leroy Janklow  
Daniel Jenkins & Kathy Hiller  
Cindy Lou Johnson  
Lana Johnson  
M. Lynne Johnson  
Larry & Mary Jones  
Bob Joy  
Julia & Lee Kalcheim  
Judith & Michael Kane  
Eric Karpeles & Mike Sell  
Richard Kastleman  
Seth Klamman  
Robert Klein  
Mary Kong  
Henry Krieger  
Bill Lambert  
Arthur E. Landi  
Joyce & James Lopenn  
Thomas La Puppert  
Jill Larson  
Carol LaValle  
Dana Lehman

Joshua Lehrer  
Jonathan & Stephanie Levi  
William & Maria Levy  
Georgette & Merton J. Levy/Mary Ludes  
John Lyons  
Peter & Maruse MacNical  
Greg MacPherson  
Bruce MacVittie  
Rama Mallia & Peter DeCoste  
Donald Margulies & Lynn Street  
Ann M. Martin  
Bikki S. Matthews  
Frank & Linda Mavronicalas  
Cody McCain  
Colleen McCourtney  
Drew McCoy  
Paul McGraw  
James & Hannelore McDaniel  
Tim Meadows  
S. Epitha Markerson  
Rebecca Miller  
Andy Milon & Faye Jackson  
Drew Mstein  
Jamie Moldatsky  
Mr. & Mrs. Douglas A. Morse  
Sally Campbell Morse  
Jane Muddoyman  
Patricia Murphy  
Peter Neufeld  
Elen Novack  
Janice Novack  
Maureen O'Boyle  
Peter & Margaret O'Brian  
Carol Ochs  
Jacki Ochs & Jan Kroeze  
Sharon O'Connor  
Kevin O'Rourke & Edith Thurber  
John & Kristine Pankow  
Russ & Leslie Paparo  
Ted & Jim Pedas  
David Peterkin  
Steven Peter  
Thomas P. Peters  
Eisa Petrus & David Algrant  
Robert & Susan Phillips  
Lawrence Polatchek  
David M. Prior  
Christopher Randolph  
Helen & Peter Randolph  
Daniel Rappaport  
David Rasche & Heather Lupton  
Nob Rauch & Lisa Belshaw  
Tim & Tyson Roy  
Paul Reale  
Jacquelyn Reingold  
Janet Reich  
Joe & Carol Reich  
Alexandra Rhoadie  
Elizabeth Rigg  
Jerome Robbins  
Kevin & Kathleen Roberts  
In memory of Jay Robinson  
Gus Rogerson  
Mirna Rose  
In memory of Doris Ross  
Daryl Roth  
Robert de Rothschild

Sally & Joseph Russo  
Jane M. Sangerman & Joseph Vodopivec  
Joshua Sapan  
Dr. Zoharah Schachtel  
Dan Schneider  
Richard Schwartz  
Saret Scott  
Barry Shapiro  
Bernice Baruch Shaw  
Mr. & Mrs. Charles Shays  
Walter & Hannah Sherman  
Constance Shulman  
Sloane Shelton  
Brian Sibersell & Patty Dryden  
Jerome & Ruth Siegel  
Ben & Ginny Siegler  
Charles Silver  
Jacqueline Simon  
Meg Simon  
Barry Singer  
Tam Singer  
Miles A. Slater  
Lois Smith  
Edna Spellman-Silverman  
Georgette Squire (and friends)  
Paul & Rene Stallings  
Robert Stecker  
Robert Stein  
Jody Steiner & Myles Gordon  
Sue Steiner  
Byam Stevens & Robin Tighman  
Byam K. Stevens, Sr.  
Fisher Stevens  
Tom & Maureen Stewart  
Joy Janits Stewart  
J. Frederick Stillman, III  
Joy Tarses  
Andrew Sweet & Elise Taylor  
Daniel Sweet  
Anne Swift  
Hiroko Tanaka  
Lili Taylor  
Joy Tarses  
Joan Yail Thome  
Tracy Thome  
Stephen Tobias  
Yves & Rachel Tourne  
Adriano Trigliani & Tim Stepherson  
Pamala Tyson  
Richard & Kathie Valeriani  
Laura Valeriso  
Wendy M. vanden Heuvel  
John Vassilaros & Alexandra Gersten  
Susan Vitucci  
Mary Pat Walsh  
Emma Walton & Stephen Hamilton  
Bruce & Christine Wasserstein  
Wendy Wasserstein  
Neil Wassner & Deborah Baker  
John Weidman  
Lawrence & Wendy Weiss  
Ira Weitzman  
Mitch Weitzner & Judy Tygard  
Robert & Andrea Weiner  
Treat Williams  
Betsy West  
John Wexler  
Jeff & Janine Yoss

as of 12/7/93



THE  
**POWER  
PLAYS**

TEN NEW PLAYS BY TEN NEW WRITERS  
FROM THE 52ND STREET PROJECT'S PLAYMAKING PROGRAM

Friday, December 10, 7:00 PM  
Saturday, December 11, 3:00 & 7:00 PM  
Sunday, December 12, 3:00 & 7:00 PM

Playwrights Horizons Studio Theatre

In addition, The 52nd Street Project is truly grateful to the many individuals who have made gifts of less than \$100. THE POWER PLAYS is also made possible in part with public funds from the National Endowment for the Arts, New York State Council on the Arts, The Department of Youth Services and the NYC Department of Cultural Affairs.

The 52nd Street Project Presents  
The Fall 1993 Playmaking Plays

# THE POWER PLAYS

December 10, 11, 12, 1993

Playwrights Horizons Studio Theater - New York City

## The 52nd Street Project Staff

Willie Reale, Artistic Director  
Carol Ochs, Executive Director  
Jenny Gersten, Director of Marketing & Development  
Michael Bernard, Associate Artistic Director, Playmaking Director  
Jerry McGill, Production Manager  
Susan Vitucci, Development Consultant  
Iris A. Brown, Staff Graphic Designer  
Mollie Langston, Intern  
Juliette Carillo, Playmaking Volunteer  
Suzanne Dottino, Playmaking Volunteer  
Julie Rose, Playmaking Volunteer  
Laura Sametz, Playmaking Volunteer  
Jeffrey Solomon, Playmaking Volunteer  
Juanita Vega, Playmaking Volunteer  
Rebecca Williams, Playmaking Volunteer

## Production Staff

Kevin Joseph Roach, Set Designer  
Greg MacPherson, Lighting Designer  
Elizabeth Hope Clancy, Costume Design  
Christopher Wigle, Stage Manager  
Katherine Lumb, Colorforms Design  
Mina Hammer, Slide Design  
Jeff Day, Slide Photographer  
Kim Chandler, Props Design  
Mike Kelleher, Light Board Operator  
Vanessa Valdes, Sound Design  
Noel Dawkins, Slide Operator  
Keith Benjamin, Furniture Head  
Taro Alexander, Furniture Crew  
Leigh Fondakowski, Props Head  
Victor Rojas, Props Crew  
George Babiak, Colorforms Head  
Susan Murray, Colorforms Crew

Load-In and Light Hang He-Men and  
She-Women:

George Babiak, Michael Bernard,  
Keith Benjamin, Jenny Gersten, Mike  
Kelleher, Bruce MacVittie, Carol  
Ochs, Tom Schall, Christopher  
Wigle

House Manager, Peter Manning

House Crew:

Suzanne Dottino, Mollie Langston,  
Warren Leight, Paula Myrie, Geoff  
Pender, Carrie Tocci

Colorforms Schleppers:

Kevin Geer, Bruce MacVittie

The 52nd Street Project is a non-profit organization that brings inner-city children from the Clinton neighborhood together with professional theater artists to create theater. THE POWER PLAYS are part of our Playmaking program. The young participants receive eight weeks of classes adapted for the Project by Daniel Judah Sklar from his book, Playmaking: Children Writing and Performing Their Own Plays. Each child is given two actors, a theme and a director who guides him or her through the writing of a play during a weekend in the country. THE POWER PLAYS are the fruits of their labors.

## Board of Directors

Ben Barenholtz	Rachel Chanoff
Wendy Ettinger, Chair	Louis P. Friedman
Stephen Graham	Larry Jones
Heidi Landesman	James McDaniel
Frances McDormand	Patricia M. Murphy
Carol Ochs	Willie Reale
Pamala Tyson	Laura Valeroso

## Special Thanks To:

Don Scardino, Leslie Marcus, Lynn Landis, Jack O'Connor, Michael Clark, Anne Padien, Michael Garces, and the swell staff of Playwrights Horizons; New York Theatre Workshop; Peggy Adler and New Dramatists; Mary Follett, Jennifer Armstrong and Hartley House; Michael Arsham, Ken Terrell, Wasim Husain and Rheedlen Place; Eric Karpeles and Michael Sell; Tyler Hill Bed & Breakfast; Galilee Bed & Breakfast; Joseph and Sally Russo; Stephen and Cathy Graham; Cora Cahan, Jeffrey Gross and The New 42; Greg Gunther; Taro Alexander; Laura Sametz; Katherine Lumb; Kelly Copper; Peter Manning; Suzy Kitman; Mollie Langston; Chris Mitchell; Martha Braunfield; Jocelyn Rappaport; Bruce MacVittie; Barbara McCrane; Lisa Benavides.

## In-Kind Contributions:

Adobe, Inc.; Ensemble Studio Theatre; Hudson Scenic Studios, Inc.; Fairway; Colorforms; Bruce Cohen & Associates; Shays & Murphy; Bernhardt/Fudyma Design Group; Joel Coen/Hudsucker Productions; Caribiner, Inc.; Stephen Graham; Lincoln Center Theater; Materials for the Arts; Tom Reale; Patty Dryden & Brian Siberell.

# THE POWER PLAYS

## The Fall 1993 Playmaking Plays

### ACT I

#### ROMANTIC HOTEL

Written by Tessa Connor, Age 9

Dramaturg/Director, Michael Angel Johnson

Kevin. . . . . Don Berman

Megan. . . . . Lisa Benavides

#### THE GIRL UNDER THE GRATES

Written by Jonsie Smith, Age 9

Dramaturg/Director, William Carden

Jasmine. . . . . Juanita Vega

Leroy. . . . . John Steber

#### THE STOLEN MOONLIGHT

Written by Ahmed Attia, Age 8

Dramaturg/Director, Candido Tirado

Mr. Dark. . . . . Tom Carrozza

Newswoman. . . . . Tom Carrozza

Detective McKendall. . . . . Shawn Elliott

The Man on the Street. . . . . Tom Carrozza

#### GOING THROUGH CHANGES

Written by Joseline Torres, Age 12

Dramaturg/Director, Charles Dumas

Vanessa. . . . . Moira Driscoll

Roscoe. . . . . Daryl Theirse

#### EXCUSES

Written by Lakisha May, Age 8

Dramaturg, Cassandra Medley

Director, Stephen Haff

Boss. . . . . Victor Mack

Jasmin. . . . . Lisa Gay Hamilton

David. . . . . Victor Mack

## ACT II

### THE PLAYMASTERS

Written by Kevin Hartwick, Age 7, and 8 on Sunday

Dramaturg/Director, Michael Bernard

Dave. .... Carmen Elena Sosa  
Robert. .... William Christian

### DESSERT MEADOW

Written by Sahara Lynn Walsh, Age 9

Dramaturg/Director, Becky Browder

Cupcake. .... Suzen Murakoshi  
Butterscotch. .... Susan Willerman  
Mr. Brussel Sprouts. .... Frank Wood  
Monsieur Willow. .... Frank Wood

"Sap Rap" lyrics by Sahara Lynn Walsh, music by Dasez Tempo.

### POWER HUNGRY CYNTHIA

Written by Diana Rojas, Age 15

Dramaturg/Director, Martha Banta

Gloop. .... Leon "Trey" Wilson  
Boss. .... Michael Bernard  
Cynthia. .... Carol Clarke

"Go Gloop" lyrics by Diana Rojas, music by Robert Reale.

### MY WEEKEND AWAY

Written by Alex Metzler, Age 8

Dramaturg/Director, Bill Wrubel

Michael. .... Tyrone Wilson  
Christy. .... Marcell Rosenblatt

Thank you for coming! If you are not on our mailing list (or if your address has changed), please fill out this form and give it to us on your way out, or mail it to the address below. We would also like to know if you are interested in becoming a volunteer. We are always in need of help in all areas, so, please fill out your name, address and phone number.

### PLEASE ADD ME TO YOUR MAILING LIST:

NAME \_\_\_\_\_

ADDRESS \_\_\_\_\_

\_\_\_\_\_ Zip \_\_\_\_\_

PHONE \_\_\_\_\_

### YES, I WOULD LIKE TO BE OF HELP:

NAME \_\_\_\_\_

DAYTIME PHONE \_\_\_\_\_

I AM REALLY USEFUL AT (52nd Street Project related things only, i.e. mailings, backstage help, fundraising, etc.) \_\_\_\_\_

### ON SALE IN THE LOBBY

52nd Street Project T-Shirts with Shel Silverstein Logo: \$12.00

Playmaking by Daniel Judah Sklar: \$13.00

The Fabulous "Flyer Chocolate Bar": \$1.50 (\$1.00 for kids)

The latest in 52 Merchandise: Baseball Caps in 3 Glorious Colors! \$15.00

Remember, one-half of sale price is tax-deductible!

If you would like to mail this (and you're always welcome to enclose a tax-deductible contribution), you can send it to:

The 52nd Street Project  
220 West 42nd Street, 18th Floor  
New York, NY 10036-7211  
(212) 764-1379



The 52nd Street Project gratefully acknowledges the support of the following foundations, corporations, and individuals: The Alton Foundation, Applause Printing & Graphics, The B.E.T.A. Fund, Cibank, Consolidated Edison, Barbara Bell Cumming Foundation, Nathan Cummings Foundation, D-B Trust, The Damron Fund, The Dramatists Guild Fund, Educational Foundation of America, The First Parish in Concord, The Fria's Foundation, The William and Mary Greve Foundation, HBO, The Hennessy Foundation, The Holland Lodge Foundation, Iron Mountain Productions, The Benito Kart Foundation, Kell's, Rose & Eugene Keiner Family Foundation, Jujamcyn Theaters, The MLI Foundation, The Marquis George MacDonald Foundation, The James MacDonald Foundation, The Ann M. Martin Foundation, Mercan Coffee, Morgan Guaranty Trust Co., Morgan Stanley and Company, The William Morris Agency, The New World Foundation, The New York Times Company Foundation, Noh Hands Productions, The Pumpkin Foundation, The Fox and Leslie R. Samuels Foundation, St. James Church, The Shubert Organization, Skadden, Arps, Slate, Meagher & Fom, Shays & Murphy, The Shubert Organization, Jules & Doris Stein Foundation, The Threshold Foundation, Variety, Wachtell, Lipton, Rosen & Katz, The Lila Acheson Wallace Theater Fund, The Wasserstein Perella Foundation, The West Bank Cafe, as well as matching gifts from AT&T, Bankers Trust and the Rockefeller Group and the following individuals:

Mr. & Mrs. Roy A. Abramowitz  
 May Ameen  
 Nancy Ameen & Toby Haden  
 Eugene Anderson & Jerry Margenthaler  
 Alon Arfa & Kay Matschullat  
 Bonnie Arfa  
 Norma Jones  
 Emanuel Azenberg  
 June Balinger & Michael Goldstein  
 Mr. & Mrs. Larry Bangser  
 Ben Barenholtz  
 Karin Barry  
 Kathy Bates & Tony Campisi  
 Gary Barton & Rob Hershman  
 Dwight Botteau, Jr.  
 Jessica Bauman  
 Laurie Beechman & Neil A. Mazzella  
 Neal Bell & Thom Babe  
 Kenneth J. Bennett  
 Melvyn & Maxine Bergman  
 Pam Berlin & William Larden  
 Myrna & Barry Bernard  
 Alexander Bernstein  
 Nina Bernstein  
 André Bishop  
 Mr. & Mrs. H. Gerald Bisinger  
 Susan & Ron Block  
 Richard Blackstone  
 R.D. Blechman  
 Judy Blume & George Cooper  
 Katherine Barowitz & John Turturro  
 Patricia Bradbury  
 Rita & Fred Brooks  
 Eric Brooks  
 Becky Browder & Ted Neustadt  
 Deborah Brown  
 Kate Burton & Michael Ritchie  
 Mara Buxbaum  
 Steven Callahan & Christine Dunn  
 Kathleen Carroll  
 Kathleen & Henry Chalfant  
 Rachel Chonoff  
 William Christian  
 Lewis Clayton & Nancy Adelson  
 Eric & Stacy Cochran  
 Joel Coen & Fran McDormand  
 Richard J. Cohn  
 Laurence Costa  
 Eileen Cowell & David Sennett  
 Joan Straus Cullman  
 Arthur Dantchik  
 Cathy Dantchik  
 Dale Davis & Harris Spyllis  
 Jacqueline de la Chaume  
 Nicholas DeMarco  
 Pamela Dempsey  
 Judy Dennis  
 Mr. & Mrs. DiRugeri  
 Dianne Dreyer  
 Richard & Rebecca Dresser  
 William Duff-Griffin  
 Mr. & Mrs. Charles Dumas  
 Jack & June Dunbar  
 Ned Eisenberg  
 Barbara L. Ettinger  
 Richard P. Ettinger  
 Wendy Ettinger & Derek McLane  
 Martha Evans & Per Lohving  
 Nick Evans

Peter Jay Fernandez  
 Liza Finley  
 Arthur Fleischer, Jr.  
 Kristine Fleischer & David Sneddon  
 Bridget Fonda & Eric Stoltz  
 David Frankel  
 Kermit Frazier  
 Louis P. Friedman  
 Charles Fuller  
 Judith Garson & Steven Rappaport  
 Rose Gasser  
 Thomas Gaziano  
 Bernard Gersten & Cara Cohen  
 Madeline Lee Giffard  
 Peter & Helen Goldstein  
 Susan Goldstein  
 Christopher & Joan Dineen Gould  
 Stephen & Cathy Graham  
 In memory of Kermit Greene  
 Colin Greer & Frances LaBorte  
 Ellen Gries & John Kapernick  
 Emily Grishman  
 A.R. Gurney  
 Thomas Halikias  
 Evan Handler  
 Peter Hedges & Susan Bruce  
 Manon Heiskell  
 Jay & Harry Henshel  
 John Heron  
 Peter Herdich & Karen Tratt  
 Jane Hoffman  
 Irwin Horowitz  
 Eleanor Huber  
 Barnard Hughes & Helen Stenberg  
 Bill Irwin  
 Mark Evan Jacobs  
 Sy Jacobs  
 Lalanya & Samuel Jackson  
 Linda Leray Janikow  
 Daniel Jenkins & Kathy Hiler  
 Lama Johnson  
 M. Lynne Johnson  
 Larry & Mary McElrath Jones  
 Julia & Lee Kalcheim  
 Judith & Michael Kane  
 Eric Karpales & Mike Sell  
 Richard Kastleman  
 Seth Klarman  
 Robert Klein  
 Mary Kang  
 Henry Krieger  
 Arthur E. Landi  
 James Lapine  
 Thomas La Puppet  
 Jill Larson  
 Carol LaValle  
 Jesse Lehman  
 Joshua Lehrer  
 Jonathan & Stephanie Lewi  
 Wilam & Marcia Levy  
 Georgette & Manton J. Levy  
 Mary Luders  
 John S. Lyons  
 Peter & Marsue MacNicol  
 Bruce MacVitie  
 Donald Margulies & Lynn Street  
 Constance Marks  
 Ann M. Martin

Carmen Matthews  
 Rikki S. Matthews  
 Frank & Linda Mavronicalos  
 Cody McClain  
 Colleen McCourtney  
 David Frankel  
 James & Hannelore McDaniel  
 Tim Meadows  
 S. Epitha Merkanon  
 Rebecca Miller  
 Andy Milon & Faye Jackson  
 Jamie Moldofsky  
 Sally Campbell Morse  
 Peter & Helen Goldstein  
 Patricia M. Murphy  
 Timothy Blake Nelson  
 Peter Neufeld  
 Ellen Novack  
 Janice Novack  
 Maureen O'Boyle  
 Peter & Margaret O'Brien  
 Carol Ochs  
 Jacki Ochs & Jan Kroeze  
 Sharon O'Connor  
 Kevin O'Rourke & Edith Thurber  
 John & Kristine Pankow  
 Russ & Leslie Papparo  
 Ted & Jim Peckas  
 David J. Petekun  
 Steven Peter  
 Thomas P. Peters  
 Elise Petrus & David Algrant  
 Robert & Susan Phillips  
 Lawrence Polatshchik  
 David M. Pinar  
 Christopher Randolph  
 Helen & Peter Randolph  
 Daniel Rappaport  
 David Rasche & Heather Lupton  
 Nob Rauch & Lisa Belshaw  
 Tim & Tyson Smith Kay  
 Paul Reale  
 Jacquelyn Reingold  
 Janet Reich  
 Joe & Carol Reich  
 Anne Rensselaer Linker Memorial Fund  
 Mary Kang  
 Henry Krieger  
 Arthur E. Landi  
 James Lapine  
 Thomas La Puppet  
 Jill Larson  
 Carol LaValle  
 Jesse Lehman  
 Joshua Lehrer  
 Jonathan & Stephanie Lewi  
 Wilam & Marcia Levy  
 Georgette & Manton J. Levy  
 Mary Luders  
 John S. Lyons  
 Peter & Marsue MacNicol  
 Bruce MacVitie  
 Donald Margulies & Lynn Street  
 Constance Marks  
 Ann M. Martin  
 Campbell Scott

Seret Scott  
 Mitchell Sennel & Colleen Carroll  
 Barry Shapiro/Bernice Baruch Shaw  
 Mr. & Mrs. Charles Shays  
 Sloane Shelton  
 Walter & Hannah Shmerler  
 Constance Shulman  
 Sloane Shelton  
 Brian Sibrell & Patty Dryden  
 Jerome & Ruth Siegel  
 Ben & Ginny Siegler  
 Charles Silver  
 Jacqueline Simon  
 Meg Simon  
 Barry Singer  
 Tom Singer  
 Miles A. Slater  
 Lois Smith  
 Peter Neufeld  
 Erica Spellman-Silverman  
 Georgette Squire (and friends)  
 Paul & Rena Stallings  
 Robert Stecker  
 Robert Stein  
 Jody Steiner & Myles Gordon  
 Sue Steiner & Lois Boatwright  
 Byam Stevens & Robin Highman  
 Byam K. Stevens, Sr.  
 Fisher Stevens  
 Tam & Maureen Stewart  
 Jay Jarvis Stewart  
 J. Frederik Stillman, III  
 Jay Tarses  
 Andrew Sweet & Elise Taylor  
 Daniel Sweet  
 Anne Swift  
 Hiroko Tanaka  
 Lili Taylor  
 Jay Tarses  
 Jean Vail Thorne  
 Tracy Thome  
 Stephen Tobias  
 Gina Torres  
 Yves & Rachel Toure  
 Adriano Tigrani & Tim Stephenson  
 Pamela Tolson  
 Richard & Kathie Valeriani  
 Laura Valeriano  
 Wendy M. vanden Heuvel  
 John Vassiliaras & Alexandra Gersten  
 Susan Vituca  
 Mary Pat Walsh  
 Emma Walton & Stephen Hamilton  
 Bruce & Christine Wasserstein  
 Wendy Wasserstein  
 Neil Wassner & Deborah Baker  
 John Weidman  
 Lawrence & Wendy Weiss  
 Ira Weitzman  
 Mitch Weitzner & Judy Lygard  
 Robert & Andrea Wiener  
 Treat Williams  
 Betsy West  
 John Wesley  
 Jeff & Janine Yass  
 Sotos Yannopoulos

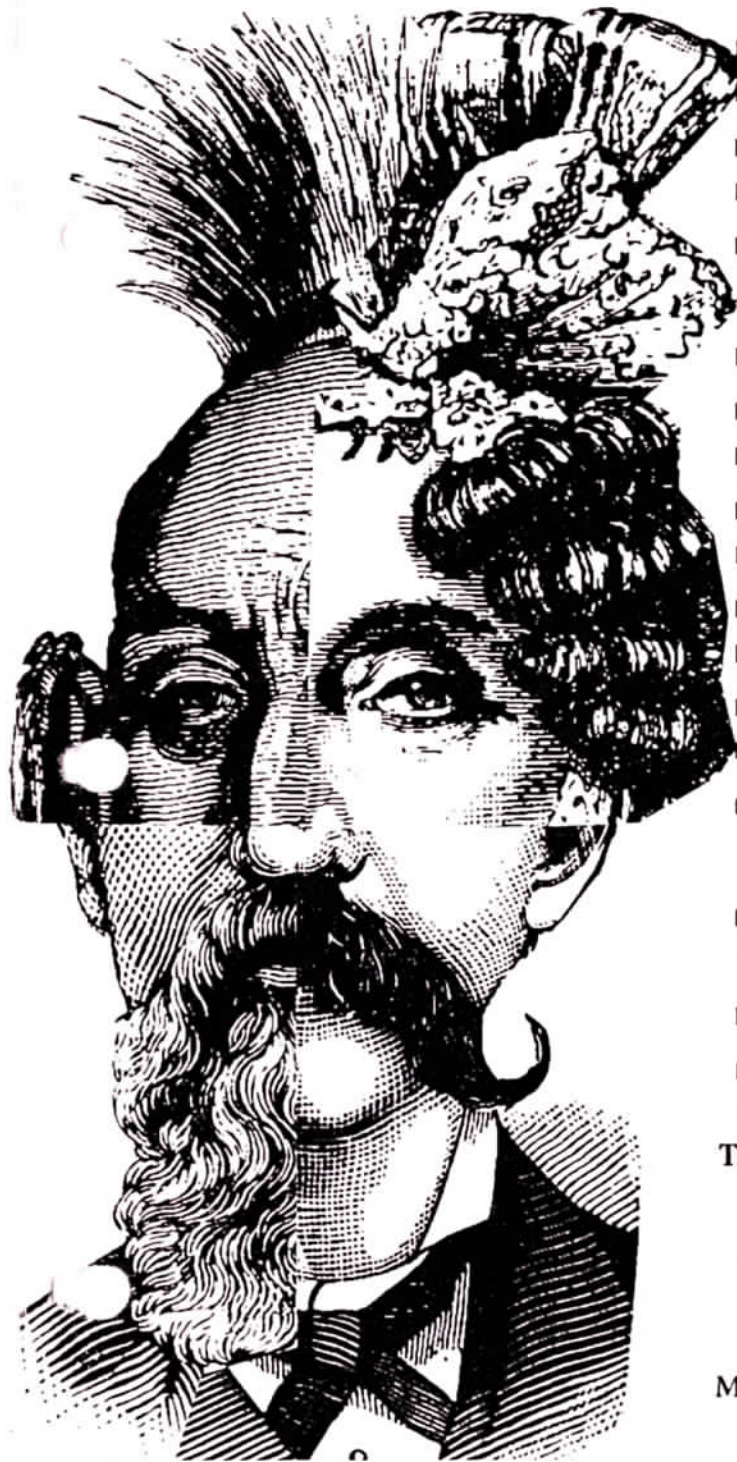

# ALL MIXED UP

The 52nd Street  
 Project  
 at  
 Ensemble  
 Studio  
 Theatre

March 18, 19, 20  
 1994

In addition, The 52nd Street Project is truly grateful to the many individuals who have made gifts of less than \$100. ALL MIXED UP is also made possible in part with public funds from the National Endowment for the Arts, New York State Council on the Arts, The Department of Youth Services and the NYC Department of Cultural Affairs.

The 52nd Street Project Presents  
The Winter 1994 Playmaking Plays

# All Mixed Up

March 18, 19, 20, 1994  
Ensemble Studio Theatre, New York City

## The 52nd Street Project Staff

Willie Reale, Artistic Director  
Carol Ochs, Executive Director  
Michael Bernard, Associate Artistic Director  
Jenny Gersten, Director of Marketing & Development  
Jerry McGill, Production Manager  
Susan Vitucci, Development Consultant  
Iris A. Brown, Staff Graphic Designer  
Taro Alexander, Playmaking Volunteer  
Lisa Benavides, Playmaking Volunteer  
Juliette Carillo, Playmaking Volunteer  
Timothy Blake Nelson, Playmaking Volunteer  
Jocelyn Rappaport, Playmaking Volunteer

## Production Staff

Kevin Joseph Roach, Set Designer  
Greg MacPherson, Lighting Designer  
Kevin Brainerd, Costume Design  
Sheila Kehoe, Costume Assistant  
Simma Gershenson, Stage Manager  
Mina Hammer, Slide Design  
Jeff Day, Slide Photographer  
Kim Chandler, Samantha Hack, Katherine Lumb, Scott Ramsay, Props Design  
Vanessa Valdes, Sound Design  
Colorforms Design: Patty Dryden's art class from Parson's:  
Ben Beberashuili, Ken Beck, Florence Cave, Jen Clebowicz, Tony Ginzburg, Sandra Gonzalez, Maya Ichikawa, Demetrius Karamitsos, Sandra Meyer, Randy Pollak, Grisette Salvadoa, Nicole Schooley, Beegee Tolpa, Luis Torres

Laura Sametz, Slide Operator  
Ben Alsup, Furniture Head  
Raymond Harold, Furniture Crew  
Leigh Fondakowski, Props Head  
Victor Rojas, Props Crew  
Noel Dawkins, Colorforms Head  
Claudia Cannon, Colorforms Crew  
George Babiak & Shirley Rumiernik, Swings  
Load-In Crew:  
Taro Alexander, Evan Bernard, Michael Bernard, Madison Cowan, Bruce MacVittie, Carol Ochs, Thomas Schall  
House Managers, Karin Barry & Peter Manning  
House Crew:  
Katie Atcheson, Andrea Berloff, Carrie Tocci, Juliette Whitworth

The 52nd Street Project is a non-profit organization that brings inner-city children from the Clinton neighborhood together with professional theater artists to create theater. ALL MIXED UP is part of our Playmaking program. The young participants receive eight weeks of classes adapted for the Project by Joel Judah Sklar from his book, Playmaking: Children Writing and Performing Their Own Plays. Each child is given two actors, a theme and a director who guides him or her through the writing of a play during a weekend in the country. ALL MIXED UP is the fruits of their labors.

## Board of Directors

Ben Barenholtz	Rachel Chanoff
Wendy Ettinger, Chair	Louis P. Friedman
Stephen Graham	Larry Jones
Heidi Landesman	James McDaniel
Frances McDormand	Patricia M. Murphy
Carol Ochs	Willie Reale
Pamala Tyson	Laura Valeroso

## Special Thanks To:

Kevin and the staff of Ensemble Studio Theatre; Mary Follett, Jennifer Armstrong and Hartley House; New York Theatre Workshop; Michael Winter and New Dramatists; Michael Arsham, Ken Terrell, Yvonne and Rheedlen Place; Wendy Ettinger, Derek McLane and Cooper; Barbara Ettinger; Frances McDormand & Joel Coen; Eric Karpeles and Michael Sell; Cora Cahan, Jeffrey Gross and The New 42; George Babiak; Taro Alexander; Shari Bodi, Karen Cooper; Madison Cowan; Samantha Hack; Amanda Jacobs; Katherine Lumb; Judy Minor; Eve Pelligrino; Jocelyn Rappaport; Diana Rojas; Victor Rojas; Andrea Schneeman; Garland Scott; Howard Solomon; Karen Trott, Liz Tucillo; Kathy Yates.

## In-Kind Contributions:

Adobe, Inc.; Ensemble Studio Theatre; Neil A. Mazzella & Hudson Scenic Studios, Inc.; Fairway; Colorforms; Baron & Baron; Bruce Cohen & Associates; [unclear] & Murphy; Iris A. Brown & Bernhardt/Fudyma Design Group; Joel Coen/Hudsucker Productions; Caribiner, Inc.; Emily Grishman; New York Theatre Workshop; Playwrights Horizons; Eric Karpeles & Mike Sell; Stephen Graham; Judy Goldman & Michael Tillinger; Steve Olsen & The West Bank Cafe; Andy Millon; Lincoln Center Theater; Materials for the Arts; Tom Reale; Patty Dryden & Brian Siberell.

**ALL MIXED UP**  
**The Winter 1994 Playmaking Plays**

**ACT I**

**MY SON, THE HERO**

Written by Janice Santaigo, Age 10

Dramaturg/Director, Suzen Murakoshi

Susana ..... Alexandra Gersten  
David ..... Taro Alexander  
Big Bopper ..... Michael Bernard

**CAUGHT DEAD IN PHILADELPHIA**

Written by Zsuzsa Mysak, Age 10

Dramaturg/Director, Jocelyn Rappaport

MB. .... Kit Flanagan  
Casper ..... Will Badgett  
Waitress ..... Camilia Sanes

**THE MAN OF THE PAST**

Written by Eric Hooper, Age 10

Dramaturg/Director, Joe White

Spartacus ..... Danny Johnson  
Mary ..... Jane Muddyman  
Jennifer ..... Jane Muddyman

**ASIA FIGHT**

Written by Chris Hansen, Age 10

Dramaturg/Director, Kent Alexander

Kent, the cat ..... Alvin Alexis  
Tomy, the dog ..... Thomas Schall

"Friends are Alright" lyrics by Chris Hansen, music by David Baron

**• Intermission •**

## ACT II

### THE FAR OUT TREE

Written by David Harold, Age 10

Dramaturg/Director, Michael Bernard

Al. .... Melissa Murray

Dave. .... Daniel Jenkins

"This Tree" lyrics by David Harold, music by David Baron

### FRIENDS FOREVER

Written by Sara Lambo, Age 9

Dramaturg/Director, Seret Scott

Brian. .... Michael Dolan

Hercules. .... Denise Mickelbury

Flight Attendant. .... Camilia Sanes

### THE TALE OF THE UNWANTED BIRD NAMED PRUDENCE

Written by Sandra Fernandez, Age 10

Dramaturg/Director, Juliette Carrillo

Prudence. .... Christopher Dansby Fisher

Bull. .... Alexander Draper

Emily. .... Marty New

Composer/accompanist, Beata Moon

### THERE'S NO PLACE LIKE HOME

Written by Raymond Ocasio, Age 11

Dramaturg/Director, Delroy Lindo

Billy, a big man. .... Arthur French

John, a snake. .... Michael Imperioli

Thank you for coming to ALL MIXED UP! If you are not on our mailing list (or if your address has changed), please fill out this form and give it to us on your way out, or mail it to the address below. We would also like to know if you are interested in becoming a volunteer. We are always in need of help in all areas, so, please fill out your name, address and phone number.

#### PLEASE ADD ME TO YOUR MAILING LIST:

NAME \_\_\_\_\_

ADDRESS \_\_\_\_\_

\_\_\_\_\_ Zip \_\_\_\_\_

PHONE \_\_\_\_\_

#### YES, I WOULD LIKE TO BE OF HELP:

NAME \_\_\_\_\_

DAYTIME PHONE \_\_\_\_\_

I AM REALLY USEFUL AT (52nd Street Project related things only, i.e. mailings, backstage help, fundraising, etc.) \_\_\_\_\_

#### ON SALE IN THE LOBBY

52nd Street Project T-Shirts with Shel Silverstein Logo: \$12.00

Playmaking by Daniel Judah Sklar: \$13.00

The Fabulous "Flyer Chocolate Bar": \$1.50 (\$1.00 for kids)

The latest in 52 Merchandise: Baseball Caps in 3 Glorious Colors! \$15.00

Remember, one-half of sale price is tax-deductible!

If you would like to mail this (and you're always welcome to enclose a deductible contribution), you can send it to:

The 52nd Street Project  
220 West 42nd Street, 18th Floor  
New York, NY 10036-7211  
(212) 764-1379

*The 52nd Street Project  
presents*



## **The Discovery Plays**

**Monday, April 18th & Tuesday, April 19th, 1994**

**West Bank Cafe**  **Downstairs Theatre**

Design & Illustration by Iris A. Brown

The 52nd Street Project Presents  
The 1994 Two-on-Twos

## **Eureka!** The Discovery Plays

April 18th and 19th, 1994  
West Bank Cafe Downstairs Theatre, New York City

### **The 52nd Street Project Staff**

Willie Reale, Artistic Director  
Carol Ochs, Executive Director  
Michael Bernard, Associate Artistic Director  
Jenny Gersten, Director of Marketing & Development  
Jerry McGill, Production Manager  
Susan Vitucci, Development Consultant  
Iris A. Brown, Staff Graphic Designer  
Watson and Crick, Project interns

### **Production Staff**

Kevin Joseph Roach, Set Designer  
Greg MacPherson, Lighting Designer  
Crystal Thompson, Costume Designer  
Rusty Magee, Music Director & SFX  
Michael Ritchie, Stage Manager  
Paula Myrie, Assistant Stage Manager  
Vanessa Valdes, Sound Design  
Hank Meiman, Master Technician  
Set and Props Builders, George Babiak,  
Amy Barbosa, Karin Barry, Michael  
Bernard, Kristen Bess, Grace Bonfiglio,  
Kim Chandler, Doris DiFranco, Jenny  
Gersten, Katherine Lumb, Kate McCamy,  
Jerry McGill, Dan Noonan, Andre Parks,  
Jocelyn Rappaport, Diana Rojas, Victor  
Rojas, Vanessa Valdes

Helene Lantry, Furniture Head  
Alex Bess, Furniture Crew  
Amanda Jacobs, Props Head  
Victor Rojas, Props Crew  
House Managers, Jean Bachrach & Laura  
Sametz  
Bar Staff:  
Jenny Gersten and Bill Wrubel

The 52nd Street Project gratefully acknowledges  
D'Agostino's and Dr. Brown's  
for their generous contribution of vanilla ice cream and root beer,  
respectively, for these performances.

The 52nd Street Project is a non-profit organization that brings inner-city children from the Clinton neighborhood together with professional theater artists to create theater. EUREKA! The Discovery Plays are part of the Two-on-Two program, in which a professional playwright creates a play specifically for two kids who are then guided by an adult director. The Two-on-Two's represent the second level of the Project's three-part acting program.

### **Board of Directors**

Ben Barenholtz	Rachel Chanoff
Wendy Ettinger, Chair	Louis P. Friedman
Stephen Graham	Larry Jones
Heidi Landesman	James McDaniel
Frances McDormand	Patricia M. Murphy
Carol Ochs	Willie Reale
Pamala Tyson	Laura Valeroso

### **Special Thanks To:**

Steve Olsen, Rand Foerster and Patricia Miller and the West Bank Cafe; Michael, Jana, Ron and the staff of New Dramatists; New York Theatre Workshop; Sundance Institute; Atlantic Theater Company; Katherine Lumb; Joanne Ramirez; Shirley Rumierk; Jeffrey Gross; Materials for the Arts; Taro Alexander; and Nancy Thompson.

### **In-Kind Contributions:**

Adobe, Inc.; Ensemble Studio Theatre; Neil A. Mazzella & Hudson Scenic Studios, Inc.; Fairway; Colorforms; Baron & Baron; Bruce Cohen & Associates; Shays & Murphy; Iris A. Brown & Bernhardt/Fudyma Design Group; Joel Coen/Hudsucker Productions; Caribiner, Inc.; Emily Grishman; New York Theatre Workshop; Playwrights Horizons; Eric Karpeles & Mike Sell; Stephen Graham; Judy Goldman & Michael Tillinger; Steve Olsen & The West Bank Cafe; Andy Millon; Lincoln Center Theater; Materials for the Arts; Tom Reale; Patty Dryden & Brian Siberell.

# **EUREKA!**

## **The Discovery Plays**

### **DR. JONES AND MR. HENRY**

Written by Tim Meadows & Jennifer Unter

Directed by Michael Bernard

Dr. Jones. . . . . Dan Noonan  
Mr. Henry. . . . . Andre Parks  
Newscaster . . . . . Annette Myrie

"The Song of Dr. Jones and Mr. Henry" lyrics by Michael Bernard,  
music by Rusty Magee

### **A DOUBLE LIFE**

Written by John Ford Noonan

Directed by Rand Foerster

Kateesha C. . . . . Karen Myrie  
Ernesto G . . . . . Eli Barbosa

### **THE EUREKA DRIVING SCHOOL**

Written by Adriana Trigiani

Directed by Becky Browder

Miss Eureka, Evelyn, TV Correspondent. . . . . Annette Myrie  
Victor. . . . . Wendell Borrero

**CONTINUED...**

**MYRTLE'S PICNIC**

Written by Susan Kim  
Directed by John Steber

Darlene . . . . . Jill Barbosa  
Myrtle . . . . . Nyita Hanley

**IT'S ALL BEEN DONE BEFORE**

Written by Donald Margulies  
Directed by Elizabeth Margid

Watson . . . . . Shirley Rumierk  
Crick . . . . . Joanne Ramirez

"It's All Been Done Before" lyrics by Willie Reale, music by Robert Reale

Jeff Hardy, accompanist and composer of incidental music  
Daniel Denver, Percussion

**USING YOUR NOODLE**

Written by Willie Reale  
Directed by Jerry McGill

Kristenio . . . . . Kristen Bess  
Diana . . . . . Diana Rojas

"It's Time To Eat" and "Pasta Pasta" lyrics by Willie Reale, music by Henry Krieger

Thank you for coming to EUREKA! If you are not on our mailing list (or if your address has changed), please fill out this form and give it to us on your way out, or mail it to the address below. We would also like to know if you are interested in becoming a volunteer. We are always in need of help in all areas, so, please fill out your name, address and phone number.

**PLEASE ADD ME TO YOUR MAILING LIST:**

NAME \_\_\_\_\_

ADDRESS \_\_\_\_\_

\_\_\_\_\_ Zip \_\_\_\_\_

PHONE \_\_\_\_\_

**YES, I WOULD LIKE TO BE OF HELP:**

NAME \_\_\_\_\_

DAYTIME PHONE \_\_\_\_\_

**I AM REALLY USEFUL AT** (52nd Street Project related things only, i.e. mailings, backstage help, fundraising, etc.) \_\_\_\_\_

**ON SALE AT THE BAR**

52nd Street Project T-Shirts with Shel Silverstein Logo: \$12.00

The latest in 52 Merchandise: Baseball Caps in 3 Glorious Colors! \$15.00

Remember, one-half of sale price is tax-deductible!

If you would like to mail this (and you're always welcome to enclose a tax-deductible contribution), you can send it to:

The 52nd Street Project  
220 West 42nd Street, 18th Floor  
New York, NY 10036-7211  
(212) 764-1379



The 52nd Street Project gratefully acknowledges the support of the following Foundations, corporations, and individuals: The Altman Foundation, Applause Printing & Graphics, Barker Welfare Foundation, The B.E.T.A. Fund, Chase Manhattan Bank, Consolidated Edison, Barbara Bell Cumming Foundation, Nathan Cummings Foundation, D-B Trust, The Dammann Fund, Judy Donahue Associates, The Dramatists Guild Fund, Educational Foundation of America, Farragone, The William and Mary Greve Foundation, The Holland Lodge Foundation, The Bonnie Kerr Foundation, Keh's, The MCI Foundation, The Marquis George MacDonald Foundation, The James Macdonald Foundation, The Ann M. Martin Foundation, Morgan Guaranty Trust Co., Morgan Stanley and Company, The William Morris Agency, The New World Foundation, The New York Times Company Foundation, Paul, Weiss, Rifkind & Garson, The Pumpkin Foundation, RUM Group, Rockefeller Group, Russak Advertising, The Fan Fan and Leslie R. Saravali Foundation, The Shubert Organization, Shays & Murphy, The Shubert Organization, Jules & Doris Stein Foundation, Harold & Mini Steinberg Charitable Trust, The Threshold Foundation, Annie Ranssalar Tinker Memorial Fund, Traveler's Fund, Variety, John A. Vassilaras & Sons, Inc., The Lita Acheson Wallace Theater Fund, The Wasserstein Perella Foundation, The West Bank Cafe, Yorke Construction, as well as matching gifts from AIBT, Bankers Trust, Alex & Brown & Sons, CBS Foundation, and the Rockefeller Group and the following individuals:

Mr. & Mrs. Roy A. Abramowitz  
 Pamela D. Adams  
 May Ameen  
 Nancy Ameen & Toby Hoden  
 Alan Arfio & Kay Matschullat  
 Emanuel Azenberg  
 Paola Baccini  
 Deborah Baker & Neil Wassner  
 June Bakinger & Michael Goldstein  
 Ben Baranholtz  
 Karin Barry  
 Angela Bassett  
 Gary Barton & Rob Hershman  
 Jessica Bourman  
 Laurie Beedman & Neil A. Mazzella  
 Neal Bell & Thom Babe  
 Kenneth J. Bennett  
 Myrna & Barry Bernard  
 Alexander Bernstein  
 Nina Bernstein  
 Mr. & Mrs. H. Gerald Bisinger  
 Eric Black  
 Susan & Ron Black  
 Richard Blackstone  
 R.O. Blechman  
 Robert & Allison Blinken  
 Audrey Bloch  
 Judy Blake & George Cooper  
 Katherine Borowitz & John Turturro  
 Patricia Bradbury  
 Eric Brooks  
 Rita & Fred Brooks  
 Becky Browder & Ted Neustadt  
 Deborah Brown  
 Marc & Susan Brown  
 Kate Burton & Michael Ritchie  
 Mara Buxbaum  
 Steven Calikhan & Christine Dunn  
 Mr. & Mrs. Richard M. Cashin  
 Rachel Chanoff  
 Marissa Chibos & Travis Preston  
 William Christian  
 Joel Coen & Fran McDormand  
 Richard Cohen  
 Richard J. Cohn  
 Arthur Collins & Stephanie Barber  
 Eileen Cowei & David Sennett  
 Joan Straus Gullman  
 Arthur Dantchik  
 Cathy Dantchik  
 Mr. & Mrs. Peter Dawkins  
 Georgia Delano  
 Robert P. D'Elia  
 Judy Dennis  
 Mr. & Mrs. DRUGERIS  
 Richard & Rebecca Dresser  
 Stephen J. Dubner  
 William Duff-Griffen  
 Jack & June Dunbar  
 Ned Eisenberg  
 Beth A. Emelson  
 John & Diana Engel  
 Barbara L. Ettinger  
 Richard P. Ettinger  
 Wendy Ettinger & Derek McLane  
 Martha Evans & Per Lovving  
 Frank Fava

Peter Jay Fernandez  
 Kristine Fleisher & David Sneddon  
 Rand Foerster & Jana McClure  
 Alexa Fogel  
 Bridget Fonda & Eric Stoltz  
 Tom Fontana  
 Leatrice Franca  
 David Frankel  
 Kermit Frazier  
 Judith Freed  
 Louis & Patrice Friedman  
 Charles Fuller  
 Judith Garson & Steven Rappaport  
 Rose Gosner & Larry Chertoff  
 Thomas L. Gazzanos  
 Bernard Gersten & Caro Cahon  
 Jillian Gersten  
 Madeline Lee Gifford  
 Marion Godfrey  
 Pam & Kevin Goldman  
 Paula Goldstein  
 Sanford & Marion Goldstein  
 Susan Goldstein  
 Stephen & Cathy Graham  
 Rosalind & Mervin Gray  
 In memory of Kermit Greene  
 Colin Greer & Frances LaBare  
 Ellen Gries & John Kapernick  
 Emily Grishman  
 Sue Grossman  
 Lisa Gugenheim  
 Tim Gurnee  
 A.R. Gurney  
 Brian Hogerman  
 Thomas Holkies  
 Linda J. Hall  
 John Hart  
 Stewart & Lamo Hayim  
 Peter Hedges & Susan Bruce  
 David Herdich & Elizabeth Palmer  
 Peter Herdich & Karen Trott  
 John Herron, Jr.  
 Francis W. Hill  
 Jane Hoffman  
 Lynn M. Holst  
 Willy Holtzman & Sylvia Shepard  
 Irwin Horowitz  
 Barnard Hughes & Helen Stenberg  
 Bill Irwin & Martha Roth  
 Mark Evan Jacobs  
 Sy Jacobs  
 Linda Leroy Janklow  
 Kathy Jennings  
 Cindy Lou Johnson  
 Lamo Johnson  
 M. Lynne Johnson  
 Mr. & Mrs. Alistair D. Johnston  
 Larry & Mary McElroth-Jones  
 Karen & Paul Kandel  
 Judith & Michael Kane  
 Eric Karpales & Mike Sell  
 Richard & Jessie Kastlerman  
 Sheila Kehoe  
 Joanne Keyes  
 Seth Klarman  
 Dr. & Mrs. Joseph Kalke  
 Mary Kong

Louis Lanza  
 James Lapine  
 Thomas La Puppert  
 Carol LaValle  
 Mr. & Mrs. Jesse Lehman  
 Joshua Lehrer  
 Jonathan & Stephanie Levi  
 Georgette & Morton J. Levy  
 Ellen Lewis  
 Mark Linn-Baker  
 Derek Livingston  
 Marjorie Laggia  
 Craig Lucas  
 Roma Maffia & Peter DeCoste  
 Donald Margulies & Lynn Street  
 Constance Marks  
 Robert Marston  
 Carmen Matthews  
 Harriet Matschullat  
 Rikki S. Matthews  
 George J. Mavronicolas  
 Max D. Mayer  
 Colleen McCourtney & Murray Yerlin  
 Andrew McKeon  
 Mr. & Mrs. McNellis  
 Rebecca Miller  
 Andy Millon  
 Sally Campbell & Tam Morse  
 Jane & Bill Muddyman  
 Suzen Murakoshi  
 Michaela Murphy & Larry Nathanson  
 Kate Nelligan & Robert Reale  
 Randy & Rona Nelson  
 Timothy Nelson & Lisa Bernavides  
 Ellen Novack  
 Janice Novack  
 Peter & Margaret O'Brien  
 Bryan O'Rourke  
 Kevin O'Rourke & Edith Thurber  
 Carol Ochs  
 Jacki Ochs & Jan Kroeze  
 Kazuto Ohira  
 Mr. & Mrs. Jaime Oriol  
 Eric Overtmeyer  
 Randy Poor  
 Steven E. Peter  
 David J. Peterkin & Nancy Jacobs  
 Thomas P. Peters  
 Robert & Susan Phillips  
 Oliver Platt & Camilla Campbell  
 Lawrence Palattheik  
 Martin F. Paris  
 Christopher Randolph  
 Helen & Peter Randolph  
 Tim & Tyson Smith-Roy  
 Paul Reese & Barbara McCrane  
 Janet Reish & Bart Elsbach  
 Jacquelyn Reingold  
 Maria Reveley  
 Elizabeth Rigg  
 In memory of Jay Robinson  
 Dr. Bruce & Ellen Roseman  
 Daryl Roth  
 Donald J. Rothschild & Latchen Shivers

Sally & Joseph Russo  
 Martha Sader & Alan Smith  
 Arnold & Agnes Sametz  
 Jane M. Sangerman & Joseph  
 Vadapalas  
 Dr. Zeborah Schachtel  
 Don Schneider  
 Milton Scafield  
 Campbell Scott  
 Dana Segal  
 Mitchell Sernel & Colleen Carroll  
 Barry Shapiro  
 Joann Shapiro  
 Mr. & Mrs. George Shaskan  
 Bernice Baruch Showl  
 Ann & Bill Sheffer  
 Sloane Shelton  
 Brian Sibelrell & Patty Dryden  
 Jerome & Ruth Siegel  
 Lorna Simpson  
 Amy E. Singer  
 Barry Singer & Jenine Ferrari  
 Mark Singer & Darcy Dunn  
 Miles A. Slater  
 Lois Smith  
 Ted Stanley  
 John Steber & Robert Shaffran  
 Robert Stecker  
 Robert Stein  
 Sue Steiner & Lori Boatwright  
 Byam Stevens & Robin Tilghman  
 Andrew Sweet & Elise Taylor  
 Daniel Sweet  
 Jay Tarses  
 Mary Lou Teel & Peter Freundlich  
 Rutherford Thompson  
 John & Joan Val Thome  
 Gina Torres  
 Yves & Rachel Tourre  
 Adriana Trigianni & Tim Stephenson  
 Kathleen Turner  
 Pamela Tyson  
 Laura Valerosa  
 Suzanne Vega  
 Mark Vietor  
 Peter Austin Vlachos  
 Mary Pat Walsh  
 Emma Walton & Stephen Hamilton  
 Wendy Wasserstein  
 Samuel H. Weiser  
 Lawrence & Wendy Weiss  
 Solly Weiss  
 Robert & Andrea Weiner  
 Max & Barbara Wilk  
 Susan Willeman  
 Jeff Williams  
 John & Pamela Wineapple  
 Terrence J. Witter  
 Joanne Woodward  
 James Wooten & Marc Cherry  
 Mr. & Mrs. Joe Yaccarino  
 Jeff & Janine Yass  
 Pierre Zimmerman

□ □ 7/28/94

In addition, The 52nd Street Project is truly grateful to the many individuals who have made gifts of less than \$100. ALL OVER THE MAP is also made possible in part with public funds from the National Endowment for the Arts, New York State Council on the Arts, The Department of Youth Services and the NYC Department of Cultural Affairs.

*The 52nd Street Project*  
 presents

**ALL OVER THE MAP**

*The Pennsylvania Plays*

*The Ensemble Studio Theatre*  
 Thursday, July 28th  
 thru  
 Sunday, July 31

The 52nd Street Project Presents  
The 1994 One-on-Ones

**ALL OVER THE MAP**

The Pennsylvania Plays

July 28, 29, 30, 31

The Ensemble Studio Theatre - New York City

**Project Staff**

Willie Reale, Artistic Director  
Carol Ochs, Executive Director  
Michael Bernard, Associate Artistic Director  
Jenny Gersten, Director of Marketing & Development  
Jerry McGill, Production Manager  
Susan Vitucci, Development Consultant  
Iris A. Brown, Staff Graphic Designer  
Jessalyn Gilsig, Intern  
Shirley A. Rumierk, Counselor

**Production Staff**

Henry Krieger, Composer & Music Director  
Kevin Joseph Roach, Set Designer  
Greg MacPherson, Lighting Designer  
Patty Cleary, Costume Designer  
Deirdre McCrane, Stage Manager  
Mike Sell, Slide Design  
Props Design: Mike Sell, Kim Chandler,  
Jessalyn Gilsig, Deirdre McCrane  
Kim Chandler, Colorforms Design  
Shirley A. Rumierk, Choreography  
Vanessa Valdes, Sound Design  
Synth, Jenny Gersten  
Rod Alonzo, Slide Operator  
Wendy Stulberg, Slide Photographer  
Josie Torres, Wardrobe Assistant

George Babiak & Mike Kelleher,  
Furniture Crew  
José Dominguez & Jessica Soto,  
Colorforms Crew  
Taro Alexander & Victor Rojas,  
Props Crew  
Light Hang & Set Crew:  
Taro Alexander, Rod Alonzo, Keith  
Benjamin, Michael Bernard, Jessalyn  
Gilsig, Jonathan Bernstein, Mike  
Kelleher, Deirdre McCrane, Thomas  
Schall  
House Manager, Noël Dawkins  
House Crew:  
Eric Karpeles, All Over The Map Meals

The 52nd Street Project is a nonprofit organization that brings inner-city children from the Clinton neighborhood together with professional theater artists to create theater. ALL OVER THE MAP is a production of our One-on-One program, which is designed to give children the opportunity to go away for one week stays in the country and enjoy the undivided attention of a professional theater artist who serves as friend, mentor and role model.

**Board of Directors**

Ben Barenholtz	Rachel Chanoff
Wendy Ettinger, Chair	Louis P. Friedman
Stephen Graham	Larry Jones
Heidi Landesman	James McDaniel
Frances McDormand	Patricia M. Murphy
Carol Ochs	Willie Reale
Pamala Tyson	Laura Valeroso

**Special Thanks To:**

Curt, Jacqueline, Stephanie and Ensemble Studio Theatre; Michael Winter and New Dramatists; The host families: Barbara & Ted Cain, Bill, Linda, Sean & Kelly Cobb, Chuck, Andrea & Emma Heyn, Tracy Rust & Rick Kaufmann, Sohail Raikhy; our regular families; Joan Henry, Sally and Joseph Russo, Martha Sader, Sally & Lenny Weiss; David Sneddon and Fairway Market; Alpine Meat House; Kip Thompson & Alex Finlayson; Larry Wolhandler and Painter's Tavern; Gloria Krause, D.V.A.A.; Rita Levy; Mark and Wendy; Gary Rickard; Lang's Roto-Rooter Sewer & Drain Service; Michael Hurley; Rod Alonzo; George Babiak; Amanda Beasley; Claudia Cannon; José Dominguez; Amanda Jacobs; Lori Quinones; Diana Rojas; Victor Rojas; Jessica Soto; Vanessa Valdes; Susan Willerman; and most importantly and lovingly we thank Hildy, Walter, Knightley, Mike and Eric.

**In-Kind Contributions:**

Adobe, Inc.; Alpine Meat House; Ensemble Studio Theatre; Neil A. Mazzella & Hudson Scenic Studios, Inc.; Fairway Market; Alpine Meat; John A. Vassilaros & Sons; Colorforms; Baron & Baron; Shays & Murphy; Iris A. Brown & Bernhardt/Fudyma Design Group; Joel Coen/Hudsucker Productions; Emily Grishman; New Dramatists; New York Theatre Workshop; Playwrights Horizons; Eric Karpeles & Mike Sell; Stephen Graham; Steve Olsen & The West Bank Cafe; Andy Millon; Lincoln Center Theater; Materials for the Arts; Tom Reale; Patty Dryden & Brian Siberell.

# ALL OVER THE MAP

## ACT I

### DESTINATION: STEVE

By Robert Shaffron, written for Kevin Hartwick, age 8

Captain . . . . . Kevin Hartwick  
Ground Control . . . . . Robert Shaffron  
Strongarm . . . . . John Steber  
"Space Dog" lyrics by Robert Shaffron

### RULES AND REGGAE-LATIONS

By Jacquelyn Reingold, written for Jonsi Smith, age 10

U. S. President . . . . . Jonsi Smith  
Jerk Chicken . . . . . Cecilia Arana  
"Do the Chicken Jerky" lyrics by Jacquelyn Reingold and Willie Reale

### O.T.M.

By Lois Smith, written for Joseph Mohamed, age 9

Peter . . . . . Joseph Mohamed  
Creature . . . . . Lois Smith  
"How Could You" & "You're Such A Good Boy" lyrics by Lois Smith

### I'M BETTER THAN YOU

By Lewis Black, written for Desmond Robertson, age 10

Des . . . . . Desmond Robertson  
Voice Over . . . . . Jerry McGill  
All Other Characters . . . . . Lewis Black  
"I'm Better Than You" lyrics by Lewis Black; "I'm Not Better Than You" lyrics  
by Willie Reale

### A PARABOLIAN PARABLE

By Willie Reale, written for Freddy Matos, age 10

Quadratron, Lord of the Boxites . . . . . Willie Reale  
Arco, Prince of Parabola . . . . . Freddy Matos  
"I Hate Anyone Who Isn't Exactly Like Me" & "Remarkably Similar" lyrics by  
Willie Reale

• I N T E R M I S S I O N •

## ACT II

### **BIG BOPPIN' SUMMER SURF BEACH BALL BIKINI PARTY**

By Michael Bernard, written for Jennifer Socarras, age 12

Rich Girl . . . . . Jennifer Socarras  
Cabana Boy . . . . . Michael Bernard  
"Big Boppin' Summer Surf Beach Ball Bikini Party" & "Why Don't I Dream" lyrics  
by Michael Bernard  
Special Thanks to Eric and Mike; George and John

### **ELECTRON MESSENGERS IN CYBERSPACE**

By Susan J. Vitucci, written for Sahara Walsh, age 10

Cybernia . . . . . Sahara Walsh  
Fonoffonoff . . . . . Susan J. Vitucci  
Virus . . . . . Shirley A. Rumierk  
"On the Info Highway" & "Around Each And Every Corner" lyrics by Susan J.  
Vitucci

### **ZASU POINT**

By John Guare, written for David Harold, age 11

David . . . . . David Harold  
Michael . . . . . Michael Potts  
"I Don't Want To Go Home" lyrics by John Guare

### **PERFECTLY FRANK**

By Demitri Corbin, written for Jed Clarke, age 12

Frank Strong. . . . . Jed Clarke  
The Strongettes. . . . . Cecilia Arana, Jessalyn Gilsig, Shirley A. Rumierk  
The Chief . . . . . Demitri Corbin  
Penny Lane . . . . . Shirley Rumierk  
The Mean and Hateful Man with the Golden Thimble . . . . . Demitri Corbin  
"The Frank Strong Song" "The Ballad of GooneyGooGoo" "Penny In the Clouds"  
"The Frank Strong Song Reprise" lyrics by Willie Reale

Thank you for coming to ALL OVER THE MAP. If you are not on our mailing list (or if your address has changed), please fill out this form and give it to us on your way out, or mail it to the address below. We would also like to know if you are interested in becoming a volunteer. We are always in need of help in all areas, so, please fill out your name, address and phone number.

### **PLEASE ADD ME TO YOUR MAILING LIST:**

NAME \_\_\_\_\_

ADDRESS \_\_\_\_\_

\_\_\_\_\_ Zip \_\_\_\_\_

PHONE \_\_\_\_\_

### **YES, I WOULD LIKE TO BE OF HELP:**

NAME \_\_\_\_\_

DAYTIME PHONE \_\_\_\_\_

**I AM REALLY USEFUL AT** (52nd Street Project related things only, i.e. mailings, backstage help, fundraising, etc.) \_\_\_\_\_

### **ON SALE IN THE LOBBY**

52nd Street Project T-Shirts with Shel Silverstein Logo: \$12.00

The latest in 52 Merchandise: Baseball Caps in 3 Glorious Colors! \$15.00

The Fabulous Flyer Bar \$1.50/\$1.00 for kids

Bound to take you all over the map in taste sensations

Remember, one-half of sale price is tax-deductible!

If you would like to mail this (and you're always welcome to enclose a tax-deductible contribution), you can send it to:

The 52nd Street Project  
220 West 42nd Street, 18th Floor  
New York, NY 10036-7211  
(212) 764-1379

The 52nd Street Project gratefully acknowledges the support of the following foundations, corporations, and individuals: The Altman Foundation, Applause Printing & Graphics, Baker Welfare Foundation, The B.E.T.A. Fund, Chase Manhattan Bank, Consolidated Edison, Barbara Bell Cumming Foundation, Nathan Cummings Foundation, DB Test, The Dammann Fund, Jody Danohue Associates, The Dramatists Guild Fund, Educational Foundation of America, Ferragamo, The William and Mary Greve Foundation, The Holland Lodge Foundation, The Benito Keri Foundation, K&H's, The MCI Foundation, The Marquis George McDonald Foundation, The James McDonald Foundation, The Ann M. Martin Foundation, Morgan Guaranty Trust Co., Morgan Stanley and Company, The William Morris Agency, The New World Foundation, The New York Times Company Foundation, Paul, Weiss, Rifkind & Garrison, The Pumpkin Foundation, RIM Group, Rockefeller Group, Russak Advertising, The Fan Fax and Leslie R. Somuels Foundation, The Shubert Organization, Shays & Murphy, The Shubert Organization, Jules & Doris Stein Foundation, Harold & Miri Steinberg Charitable Trust, The Threshold Foundation, Annie Ranssolaier Tinker Memorial Fund, Traveler's Fund, Variety, John A. Vasilaros & Sons, Inc., The Uta Adhesion Wallace Theater Fund, The Wasserstein Perella Foundation, The West Bank Cafe, Yorke Construction, as well as matching gifts from AIBI, Bankers Trust, Alex & Brown & Sons, CBS Foundation, and the Rockefeller Group and the following individuals:

Mr. & Mrs. Roy A. Abramowitz  
 Pamela D. Adams  
 May Armeen  
 Nancy Armeen & Toby Haden  
 Alan Arffa & Kay Matschullat  
 Emanuel Azenberg  
 Paola Bacchi  
 Deborah Baker & Neil Wassner  
 June Ballinger & Michael Goldstein  
 Ben Barenholtz  
 Karin Bary  
 Angela Bassett  
 Gary Barton & Rob Hershman  
 Jessica Bowman  
 Laurie Beachman & Neil A. Mazzella  
 Neal Bell & Thom Babe  
 Kenneth J. Bennett  
 Myrna & Barry Bernard  
 Alexander Bernstein  
 Nina Bernstein  
 Mr. & Mrs. H. Gerald Bissinger  
 Eric Black  
 Susan & Ron Black  
 Richard Blackstone  
 R.D. Blackman  
 Robert & Allison Blinken  
 Audrey Bloch  
 Judy Blume & George Cooper  
 Katherine Borowitz & John Turturno  
 Patricia Bradbury  
 Eric Brooks  
 Rita & Fred Brooks  
 Becky Browder & Ted Neustadt  
 Deborah Brown  
 Marc & Susan Brown  
 Kate Burton & Michael Ritchie  
 Mara Buxbaum  
 Steven Callahan & Christine Dunn  
 Mr. & Mrs. Richard M. Cashin  
 Rachel Chanoff  
 Marissa Chibos & Travis Preston  
 William Christian  
 Joel Coen & Fran McDormand  
 Richard Cohen  
 Richard J. Cohn  
 Arthur Collins & Stephanie Barber  
 Eileen Cowell & David Sennett  
 Joan Strauss Cullman  
 Arthur Dantchik  
 Cathy Dantchik  
 Mr. & Mrs. Peter Dawkins  
 Georgia Delano  
 Robert P. D'Elia  
 Judy Dennis  
 Mr. & Mrs. Dilrugeris  
 Richard & Rebecca Dresher  
 Stephen J. Dubner  
 William Duff-Griffin  
 Jack & June Dunbar  
 Ned Eisenberg  
 Beth A. Emelson  
 John & Diana Engel  
 Barbara L. Ettinger  
 Richard P. Ettinger  
 Wendy Ettinger & Derek McLane  
 Martha Evans & Per Lohing  
 Frank Fava  
 Peter Jay Fernandez

Kristine Fleisher & David Sneadon  
 Rand Foerster & Jana McClure  
 Alexa Fogel  
 Bridget Fonda & Eric Stoltz  
 Tom Fontana  
 Laetitia Franca  
 David Frankel  
 Kermit Frazier  
 Judith Freed  
 Louis & Patrice Friedman  
 Charles Fuller  
 Judith Garson & Steven Rappaport  
 Rose Gosner & Larry Chertoff  
 Thomas L. Gazarinos  
 Bernard Gersten & Cora Cahon  
 Jilian Gersten  
 Madeline Lee Giffard  
 Marian Godfrey  
 Pam & Kevin Goldman  
 Paula Goldstein  
 Sanford & Marian Goldstein  
 Susan Goldstein  
 Stephen & Cathy Graham  
 Rosalind & Mervin Gray  
 In memory of Kermit Greene  
 Colin Greer & Frances LaBarre  
 Ellen Griles & John Kapernick  
 Emily Grishman  
 Sue Grossman  
 Lisa Gugenheim  
 Tim Guinee  
 A.R. Gurney  
 Brian Hogeman  
 Thomas Holikias  
 Linda J. Hall  
 John Hart  
 Stewart & Lama Hayim  
 Peter Hedges & Susan Bruce  
 In memory of Gertrude Heimer  
 David Herdich & Elizabeth Palmer  
 Peter Herdich & Karen Tratt  
 John Heron, Jr.  
 William J. Hübsher  
 Francis W. Hill  
 Jane Hoffman  
 Lynn M. Holst  
 Willy Holtzman & Sylvia Shepard  
 Irwin Horowitz  
 Barnard Hughes & Helen Stenborg  
 Bill Irwin & Martha Roth  
 Mark Evan Jacobs  
 Sy Jacobs  
 Linda Leroy Janklow  
 Kathy Jennings  
 Cindy Lou Johnson  
 Lorna Johnson  
 M. Lynne Johnson  
 Mr. & Mrs. Alistair D. Johnston  
 Larry & Mary McBrath-Jones  
 Karen & Paul Kandel  
 Judith & Michael Kane  
 Eric Karpeles & Mike Sell  
 Richard & Josie Kastleman  
 Sheila Kehoe  
 Jayne Keyes  
 I. Russell King  
 Seth Klarman  
 Dr. & Mrs. Joseph Kalker

Mary Kong  
 Louis Lanza  
 James Lapine  
 Thomas La Puppet  
 Carol LaVallie  
 Mr. & Mrs. Jesse Lehman  
 Joshua Lehrer  
 Jonathan & Stephanie Levi  
 Georgette & Morton J. Levy  
 Ellen Lewis  
 Mark Linn-Baker  
 Derek Livingston  
 Rose Gosner & Larry Chertoff  
 Marjorie Loggia  
 Craig Lucas  
 Roma Mattia & Peter DeCaste  
 Donald Margulies & Lynn Street  
 Constance Marks  
 Robert Marston  
 Carmen Matthews  
 Paula Goldstein  
 Harriet Matschullat  
 Rikki S. Matthews  
 George J. Mavronicalos  
 Max D. Mayer  
 Colleen McCourtney & Murray Verlin  
 Andrew McKean  
 Mr. & Mrs. McNellis  
 Rebecca Miller  
 Andy Millon  
 Sally Campbell & Tom Morse  
 Jane & Bill Muddyman  
 Suzen Murakoshi  
 Michaela Murphy & Larry Nathanson  
 Kate Neiligan & Robert Reale  
 Randy & Rona Nelson  
 Timothy Nelson & Lisa Benavides  
 Ellen Novack  
 Janice Novack  
 Peter & Margaret O'Brien  
 Bryan O'Rourke  
 Kevin O'Rourke & Edith Thurber  
 Carol Ochs  
 Jacki Ochs & Jan Kraeze  
 Kazuto Ohira  
 Mr. & Mrs. Jaime Oriol  
 Eric Overmyer  
 Randy Paar  
 Steven E. Peter  
 David J. Peterkin & Nancy Jacobs  
 Thomas P. Peters  
 Robert & Susan Phillips  
 Oliver Platt & Camilla Campbell  
 Lawrence Polatchek  
 Martin F. Puts  
 Christopher Randolph  
 Helen & Peter Randolph  
 Tim & Tyson Smith-Ray  
 Paul Reale & Barbara McClrane  
 Janet Reich & Bart Esboch  
 Jacquelyn Reingold  
 Mana Reveley  
 Elizabeth Rigg  
 Thyreast Robertson  
 In memory of Jay Robinson  
 Dr. Bruce & Ellen Roseman  
 Daryl Roth

Donald J. Rothschild & Latchen Shivers  
 Sally & Joseph Russo  
 Martha Sader & Alan Smith  
 Arnold & Agnes Sometz  
 Jane M. Sangerman & Joseph  
 Vadolopol  
 Dr. Zebarah Schochel  
 Dan Schneider  
 Milton Scafield  
 Campbell Scott  
 Dana Segal  
 Mitchell Semel & Colleen Carrall  
 Barry Shapiro  
 Joann Shapiro  
 Mr. & Mrs. George Shaskan  
 Bernice Baruch Shawl  
 Ann & Bill Sheffer  
 Sloane Shelton  
 Brian Siberell & Patty Dryden  
 Jerome & Ruth Siegel  
 Lorna Simpson  
 Amy E. Singer  
 Barry Singer & Jenine Ferrari  
 Mark Singer & Darcy Dunn  
 Miles A. Slater  
 Lois Smith  
 Ted Stanley  
 John Steber & Robert Shaffran  
 Robert Stecker  
 Robert Stein  
 Sue Steiner & Lori Boatwright  
 Byam Stevens & Robin Tighman  
 Andrew Sweet & Elise Taylor  
 Daniel Sweet  
 Jay Tases  
 Mary Lou Teel & Peter Freundlich  
 Rutherford Thompson  
 John & Joan Vail Thorne  
 Gina Tares  
 Yves & Rachel Toure  
 Adriana Trigiani & Tim Stephenson  
 Kathleen Turner  
 Pamela Tyson  
 Laura Valeroso  
 Suzanne Vega  
 Mark Vietor  
 Peter Austin Vlachos  
 Mary Pat Walsh  
 Emma Walton & Stephen Hamilton  
 Wendy Wasserstein  
 Samuel H. Weiser  
 Lawrence & Wendy Weiss  
 Sally Weiss  
 Robert & Andrea Weiner  
 Max & Barbara Wilk  
 Susan Willeman  
 Jeff Williams  
 John & Pamela Wineapple  
 Terrence J. Witter  
 Joanne Woodward  
 James Wooten & Marc Cherry  
 Mr. & Mrs. Joe Taccarino  
 Jeff & Janine Yass  
 Pierre Zimmerman

11/8/94

In addition, The 52nd Street Project is truly grateful to the many individuals who have made gifts of less than \$100. ALL OVER THE MAP is also made possible in part with public funds from the National Endowment for the Arts, New York State Council on the Arts, The Department of Youth Services and the NYC Department of Cultural Affairs.

The 52nd Street Project  
 presents

# ALL OVER THE MAP

The Block Island Plays

The Ensemble Studio Theatre  
 Thursday, August 25th  
 thru  
 Sunday, August 28th

The 52nd Street Project Presents  
The 1994 One-on-Ones

**ALL OVER THE MAP**

The Block Island Plays

August 25, 26, 27, 28, 1994

The Ensemble Studio Theatre - New York City

**Project Staff**

Willie Reale, Artistic Director  
Carol Ochs, Executive Director  
Michael Bernard, Associate Artistic Director  
Jenny Gersten, Director of Marketing & Development  
Jerry McGill, Production Manager  
Lisa Benavides, Production Manager in Training  
Susan Vitucci, Development Consultant  
Iris A. Brown, Staff Graphic Designer  
Jessalyn Gilsig, Intern

**Production Staff**

Tim Ray, Composer & Music Director  
Kevin Joseph Roach, Set Designer  
Greg MacPherson, Lighting Designer  
Sheila Kehoe, Costume Designer  
Karen Roston, Assistant Costume Designer  
Hank Meiman, Stage Manager  
Mina Hammer, Slide Design  
Kim Chandler, Props Design  
Traci Johnson, Colorforms Design  
Vanessa Valdes, Sound Design  
Wendy Stulberg, Slide Photographer  
Tyson Smith-Ray, Musical Assistant

Mina Hammer, Slide Operator  
George Babiak & Evelyn Maldonado,  
Furniture Crew  
Helene Lantry & Alexandra Paxton,  
Colorforms Crew  
Amanda Jacobs & Shirley Rumierk,  
Props Crew  
Load-in Crew:  
Lisa Benavides, Michael Bernard,  
Evan Handler, Hank Meiman & Tim  
Nelson.  
House Managers, Karin Barry & Laura  
Sametz  
House Crew:  
Andrea Chapin, Noël Dawkins, Beth  
Emelson, Carrie Tocci

The 52nd Street Project is a nonprofit organization that brings inner-city children from the Clinton neighborhood together with professional theater artists to create theater. ALL OVER THE MAP is a production of our One-on-One program, which is designed to give children the opportunity to go away for one week stays in the country and enjoy the undivided attention of a professional theater artist who serves as friend, mentor and role model.

**Board of Directors**

Ben Barenholtz	Rachel Chanoff
Wendy Ettinger, Chair	Louis P. Friedman
Stephen Graham	Larry Jones
Heidi Landesman	James McDaniel
Frances McDormand	Patricia M. Murphy
Carol Ochs	Willie Reale
Pamala Tyson	Laura Valeroso

**Special Thanks To:**

Curt, Jacqueline, Stephanie and Ensemble Studio Theatre; Michael Winter and New Dramatists; Yvonne LaViale and Hartley House; The host families: Rita & Steve Draper, Bob & Lyn Reale, Mary & Monty Stover, Elliot & Jennifer Taubman, Ron & Judy Tierney; Virginia Dare & Joya Verde; Dennis & Trudy O'Toole; Ruth Kaufman; Emily Reese; Lenny Orland & Sue Wise; David Sneddon and Fairway Market; Nora Forbes; Liz & Nick Masci; Hunter Tracy; Ed McGovern and the Yellow Kittens; Phil O'Donnel; Bill Bendokas; Carol & Tom LaValle; Greg MacPherson; McQuade's Marketplace; Gary Hall; Martha MacDonald, Jim Reale & Pat McQuade; Wayne McQuade; Prudy and the Ice Cream Place; Interstate Navigation; BI BINGO and the volunteer fire department; BI Realty; Phelan Real Estate; Sam; Zora, Ariana, Niko & Alexis; Barbara Goldman; Penny Rosen; Susan Kim; Lisa Benavides; Tim Nelson; Traci Johnson; Melissa Murray; Bruce MacVittie; Rod Alonzo; Suzen Murakoshi; Janice Santiago; Elisa Mohamed; Jed Clarke; Ray Ocasio; Chris Hansen; Michaela Murphy; Thomas Schall; Becky Browder; Ayelet Kaznelson; Phil Gille at Hudson Scenic.

**In-Kind Contributions:**

Adobe, Inc.; Alpine Meat House; Ensemble Studio Theatre; Neil A. Mazzella & Hudson Scenic Studios, Inc.; Fairway Market; John A. Vassilaros & Sons; Colorforms; Baron & Baron; Shays & Murphy; Iris A. Brown & Bernhardt/Fudyma Design Group; Joel Coen/Hudsucker Productions; Emily Grishman; New Dramatists; New York Theatre Workshop; Playwrights Horizons; Eric Karpeles & Mike Sell; Stephen Graham; Steve Olsen & The West Bank Cafe; Andy Millon; Lincoln Center Theater; Materials for the Arts; Tom Reale; Patty Dryden & Brian Siberell.

**ALL OVER THE MAP**  
**AUGUST 25, 26, 27, 28, 1994**

**ALL OVER THE MAP THEME SONG - Company**

Lyrics by Willie Reale

**TEXAS IS CRYING IN THE LADIES ROOM**

Written and directed by Michaela Murphy, for Deshana Hamid, age 10

Rhode Island . . . . . Deshana Hamid  
Texas . . . . . Michaela Murphy  
Alaska . . . . . Elisa Mohamed  
"My Hat Is Off to Texas" lyrics by Willie Reale

**SCIENTIST MEETS FISH**

Written by Susan Kim, for Chris Hansen, age 10

Directed by Lisa Benavides

Eggfoot . . . . . Lisa Benavides  
Perry . . . . . Chris Hansen  
"The Painting Piranha" lyrics by Willie Reale

**AN EARTH SLAM**

Written and directed by Suzen Murakoshi, for Janice Santiago, age 10

Atlas . . . . . Suzen Murakoshi  
Amelia . . . . . Janice Santiago  
Voice Over . . . . . Michael Bernard  
"I'm Only Ten" lyrics by Willie Reale

**A COMEDY OF MANNERS**

Written and directed by Willie Reale, for Elisa Mohamed, age 13

Ross . . . . . Willie Reale  
Siss . . . . . Elisa Mohamed  
Props Person . . . . . Helene Lantry  
"The Cockeyed Narrative" & "The Interrupted Lament" lyrics by Willie Reale

**STRANDED STRANGERS**

Written and directed by Jerry McGill, for Cordell Horsford, age 11

Sonny . . . . . Cordell Horsford  
Max . . . . . Jerry McGill  
Pilot . . . . . Jenny Gersten  
"The Ask Me Song" & "Turn A Little Into A Lot" lyrics by Jerry McGill

## INTERMISSION

### FLYING HIGH

Written and directed by Evan Handler, for Ahmed Attia, age 8

X-Meister . . . . . Evan Handler  
Student. . . . . Ahmed Attia  
"Change The Dream" lyrics by Willie Reale

### LAST CALL FOR DULUTH

Written and directed by Kate Long, for Tessa John-Connor, age 10

Emmett Lane. . . . . Dion Graham  
Clarisa Sharpay . . . . . Tessa John-Connor  
"Get Out of My Way I'm Clarisa Sharpay" lyrics by Kate Long

### DOLL IN LIMBO

Written and directed by Tim Nelson, for Zsuzsa Mysak, age 11

Claire the doll. . . . . Zsuzsa Mysak  
Bob. . . . . Tim Nelson  
"At Least I Have My Head" & "Claire's Song" lyrics by Tim Nelson

### THE ADVENTURES OF LEWIS AND CLARK

Written and directed by Michael Bernard, for Raymond Ocasio, age 12

Clark . . . . . Melissa Murray  
Lewis . . . . . Raymond Ocasio  
Sacajawea and Bear . . . . . Michael Bernard  
"Lewis and Clark" "Through Those Eyes" & "Lead Me Right To You" lyrics by Michael Bernard

### THE LEGEND OF COWBOY BOB

Written and directed by Bruce MacVittie, for Anthony Maldonado, age 9

Crotchety . . . . . Bruce MacVittie  
"Snake Eyes" McQuade. . . . . Larry Nathanson  
Cowboy Bob . . . . . Anthony Maldonado  
Lulu Fifi Smith . . . . . Tessa John-Connor  
"The Legend of Cowboy Bob" & "The Ballad of the Changed Cowboy" lyrics by Bruce MacVittie

Thank you for coming to ALL OVER THE MAP. If you are not on our mailing list (or if your address has changed), please fill out this form and give it to us on your way out, or mail it to the address below. We would also like to know if you are interested in becoming a volunteer. We are always in need of help in all areas, so, please fill out your name, address and phone number.

### PLEASE ADD ME TO YOUR MAILING LIST:

NAME \_\_\_\_\_

ADDRESS \_\_\_\_\_

\_\_\_\_\_ Zip \_\_\_\_\_

PHONE \_\_\_\_\_

### YES, I WOULD LIKE TO BE OF HELP:

NAME \_\_\_\_\_

DAYTIME PHONE \_\_\_\_\_

**I AM REALLY USEFUL AT** (52nd Street Project related things only, i.e. mailings, backstage help, fundraising, etc.) \_\_\_\_\_

### ON SALE IN THE LOBBY

#### Project Stuff featuring the Shel Silverstein Logo

T-Shirts in 3 Glorious colors: \$12.00  
Baseball Caps in 3 Glorious colors: \$15.00

#### Food Stuff

Alysa J. Goodman's cookies: \$1.00  
The Fabulous Flyer Bar \$1.50/\$1.00 for kids

Bound to take you all over the map in taste sensations

Remember, one-half of sale price is tax-deductible!

If you would like to mail this (and you're always welcome to enclose a tax-deductible contribution), you can send it to:

The 52nd Street Project  
220 West 42nd Street, 18th Floor  
New York, NY 10036-7211  
(212) 764-1379



# THE 52ND STREET PROJECT

PRESENTS

## REPLAY ENSEMBLE

AT NEW DRAMATISTS

NOVEMBER 11TH AT 6:30PM

### That's Amoré By Jeffrey Zambrano

Directed by Jeffrey Zambrano and Adam Felber

Pizza . . . . . Jed Clarke  
Cab . . . . . Andre Parks  
Man . . . . . Eli Barbosa

### Jennifer's Play By Jennifer Soccaros

Directed by Jennifer Soccaros and Susan Willerman

Nicole . . . . . Mary Vamvoukakis  
Phillup . . . . . Joseph Mohamed  
Father . . . . . Cordell Horsford  
Mother . . . . . Jennifer Soccaros

### The Couple That Never Got Along By Amy Barbosa

Directed by Amy Barbosa and John Steber

Phillip . . . . . Eddie Zambrano  
Jessica . . . . . Erica Borrero  
Judge . . . . . Judy Agosto

### The Great Escape By Darthula Harvey

Directed by Darthula Harvey and Barbara McCrane

Freddy . . . . . Evelyn Maldonado  
Tiny Tim . . . . . Anthony Maldonado  
Brother . . . . . Cordell Horsford  
Sister . . . . . Stephanie Tejada  
Angela . . . . . Gemma Cooper-Novack

### Sometimes Things Happen By Elisa Mohamed

Directed by Elisa Mohamed and Moira Driscoll

Patient . . . . . Natasha Soto  
Mother . . . . . Yolanda Maldonado  
Son . . . . . Wendell Borrero  
Judge . . . . . Eli Barbosa

### The Best Friends By Joseph Asafo

Directed by Joseph Asafo and Robert Shaffron

BMW . . . . . Fernando Ramirez  
Tonka . . . . . Raymond Harold

Set Crew: The Replay Ensemble, as led by Jill Barbosa.

Stage Manager/Kid Wrangler: Mollie Langston

All sets constructed by the Replay Ensemble Company under the brilliant direction of set-king Kevin Joseph Roach and his lackeys Jenny Gersten and David Soo.

The 52nd Street Project and the Replay Ensemble would like to offer its thanks to the following individuals and organizations who have helped to make this evening possible: Peggy Adler and the staff of New Dramatists for their generosity, Material For the Arts for the cardboard, Kevin Joseph Roach for the weekend, Katherine Lumb for the last minute props, Carol Ochs for her car.

The 52nd Street Project Staff:

Willie Reale, artistic director  
Carol Ochs, executive director  
Michael Bernard, associate artistic director  
Jenny Gersten, director of marketing & development  
Jerry McGill, production manager  
Susan Vitucci, development consultant  
Iris A. Brown, staff graphic designer  
Mollie Langson, Project Intern

The 52nd Street Project gratefully acknowledges the support of the following foundations, corporations, and individuals: The Altman Foundation, The American Red Cross Overseas Association, Barker Welfare Foundation, The B.E.T.A. Fund, Chase Manhattan Bank, Consolidated Edison, Barbara Bell Cumming Foundation, Nathan Cummings Foundation, DB Trust, The Dormann Fund, Jody Donohue Associates, The Dramatists Guild Fund, Educational Foundation of America, Ferragamo, The William and Mary Greve Foundation, The Holland Lodge Foundation, the Benito Ker Foundation, Kieh's, The MCI Foundation, The Marquis George MacDonnell Foundation, The James Macdonald Foundation, The Ann M. Martin Foundation, Morgan Guaranty Trust Co., Morgan Stanley and Company, The William Morris Agency, The New World Foundation, The New York Times Company Foundation, Paul, Weiss, Rikind & Gorison, The Pumpkin Foundation, RIM Group, Rockefeller Group, Russek Advertising, The Fan Fax and Leslie R. Samuels Foundation, The Shubert Organization, Shays & Murphy, The Shubert Organization, Jules & Doris Stein Foundation, Harold & Miri Steinberg Charitable Trust, The Threshold Foundation, Annie Renaissance Tinker Memorial Fund, Traveler's Fund, Variety, John A. Vassaras & Sons, Inc., The Lia Adheson Wallace Theater Fund, The Wasserstein Perella Foundation, The West Bank Cafe, Yorke Construction, as well as matching gifts from AT&T, Bankers Trust, Alex & Brown & Sons, CBS Foundation, the Rockefeller Group, and The New York Times Company Foundation and the following individuals:

Mr. & Mrs. Roy A. Abramowitz  
 Pamela D. Adams  
 May Ameen  
 Nancy Ameen & Toby Haden  
 Amy Merrill Ansara  
 Alan Arfio & Kay Matschullat  
 Emanuel Azenberg  
 Paola Baccini  
 Deborah Baker & Neil Wassner  
 June Ballinger & Michael Goldstein  
 Ben Barenholtz  
 Karin Barry  
 Angela Bossett  
 Gary Barton & Rob Hershman  
 Jessica Bauman  
 Laurie Beechman & Neil A. Mazzella  
 Ned Bell & Thom Babe  
 Kenneth J. Bennett  
 Myrna & Barry Bernard  
 Alexander Bernstein  
 Nina Bernstein  
 Mr. & Mrs. H. Gerald Bissinger  
 Eric Block  
 Susan & Ron Block  
 Richard Blackstone  
 R.D. Blechman  
 Robert & Alison Blaken  
 Audrey Bloch  
 Judy Blume & George Cooper  
 Katherine Borowitz & John Turturo  
 Patricia Bradbury  
 Eric Brooks  
 Rita & Fred Brooks  
 Becky Browder & Ted Neustadt  
 Deborah Brown  
 Marc & Susan Brown  
 Kate Burton & Michael Ritchie  
 Mara Buxbaum  
 Steven Callahan & Christine Dunn  
 Mr. & Mrs. Richard M. Cashin  
 Rachel Chanoff  
 Marissa Chabas & Travis Preston  
 William Christian  
 Joel Coen & Fran McDermott  
 Richard Cohen  
 Richard J. Cohn  
 Arthur Collins & Stephanie Barber  
 Eileen Cowel & David Sennett  
 Joan Straus Cullman  
 Arthur Dantchik  
 Cathy Dantchik  
 Mr. & Mrs. Peter Dawkins  
 Georgia Delano  
 Robert P. D'Elia  
 Judy Dennis  
 Mr. & Mrs. DiRuggeris  
 Richard & Rebecca Dresser  
 Stephen J. Dubois  
 William Duff-Giffen  
 Jack & June Dunbar  
 Ned Eisenberg  
 Beth A. Emslein  
 John & Diana Engel  
 Barbara L. Ettinger  
 Richard P. Ettinger  
 Wendy Ettinger & Derek McLane  
 Martha Evans & Per Lohving  
 Frank Fava  
 Peter Jay Fernandez

Kristine Fleisher & David Sueddon  
 Rand Foerster & Jana McClure  
 Alexa Fogel  
 Bridget Fonda & Eric Stoltz  
 Tom Fontana  
 Laetitia Franca  
 David Frankel  
 Kermit Fraser  
 Judith Freed  
 Louis & Patrice Friedman  
 Charles Fuller  
 Judith Gerson & Steven Rappaport  
 Rose Gansner & Larry Chertoff  
 Thomas L. Gazanias  
 Bernard Gensten & Cara Cahon  
 Jilian Gersten  
 Madeline Lee Gifford  
 Marian Godfrey  
 Pam & Kevin Goldman  
 Paula Goldstein  
 Sanford & Marion Goldstein  
 Susan Goldstein  
 Stephen & Cathy Graham  
 Rosalind & Mervin Gray  
 In memory of Kermit Greene  
 Colin Greer & Frances LaBarre  
 Ellen Gries & John Kapernick  
 Emily Grishman  
 Sue Grossman  
 Lisa Gugenheim  
 Tim Guinee  
 A.K. Gurney  
 Brian Hagerman  
 Thomas Halkias  
 Linda J. Hall  
 John Hart  
 Stewart & Loma Hayim  
 Peter Hedges & Susan Bruce  
 In memory of Gertrude Heimer  
 David Herdich & Elizabeth Palmer  
 Peter Herdich & Karen Trot  
 John Heron, Jr.  
 William J. Hibsher  
 Francis W. Hill  
 Jane Hoffman  
 Lynn M. Holst  
 Willy Holtzman & Sylvia Shepard  
 Irwin Horowitz  
 Bernard Hughes & Helen Stenberg  
 Bill Irwin & Martha Roth  
 Mark Evan Jacobs  
 Sy Jacobs  
 Linda Leroy Janklow  
 Kathy Jennings  
 Cindy Lou Johnson  
 Lorna Johnson  
 M. Lynne Johnson  
 Mr. & Mrs. Alistair D. Johnston  
 Larry & Mary McElrath-Jones  
 Karen & Paul Kandal  
 Judith & Michael Kane  
 Eric Karples & Mike Sell  
 Richard & Josie Kastelman  
 Sheila Kehoe  
 Jayne Keyes  
 J. Russell King  
 Seth Klamman  
 Dr. & Mrs. Joseph Kalkor  
 Mary Kong

Louis Lanza  
 James Lapine  
 Thomas La Puppert  
 Carol LaValle  
 Mr. & Mrs. Jesse Lehman  
 Joshua Lehrer  
 Heather M. Lester  
 Jonathan & Stephanie Levi  
 Georgette & Morton J. Levy  
 Reto Levy  
 Ellen Lewis  
 Mark Linn-Baker  
 Derek Livingston  
 Marjorie Loggia  
 Craig Lucas  
 Rama Maffio & Peter DeCoste  
 Donald Margulies & Lynn Street  
 Constance Marks  
 Robert Marston  
 Carmen Matthews  
 Hamiet Matschullat  
 Rikki S. Matthews  
 George J. Mavronicolas  
 Max D. Mayer  
 Colleen McCourtney & Murray Varlin  
 Andrew McKean  
 Mr. & Mrs. McHalls  
 Rebecca Miller  
 Andy Milton  
 Sally Campbell & Tom Morse  
 Jane & Bill Muddyman  
 Suzen Murakoshi  
 Michaela Murphy & Larry Nathanson  
 Kate Nelligan & Robert Keale  
 Randy & Rona Nelson  
 Timothy Nelson & Lisa Benavides  
 Elen Novack  
 Janice Novack  
 Peter & Margaret O'Brien  
 Bryan O'Rourke  
 Kevin O'Rourke & Edith Thurber  
 Carol Ochs  
 Jacki Ochs & Jan Kroeze  
 Kazuto Ohira  
 Mr. & Mrs. Jaime Oriol  
 Eric Ovaemyer  
 Randy Pozar  
 Steven E. Peter  
 David J. Peterkin & Nancy Jacobs  
 Thomas P. Peters  
 Robert & Susan Phillips  
 Oliver Platt & Camilla Campbell  
 Lawrence Polatchek  
 Martin F. Paris  
 Christopher Randolph  
 Helen & Peter Randolph  
 Tam & Tyson Smith-Ray  
 Paul Reale & Barbara McCrane  
 Janet Reich & Bart Esboch  
 Jacquelyn Reingold  
 Maria Reveley  
 Elizabeth Rigg  
 Thyraest Robertson  
 In memory of Jay Robinson  
 Dr. Bruce & Ellen Roseman  
 Daryl Roth

Donald J. Rothschild & Lottchen Shivers  
 Sally & Joseph Russo  
 Martha Soder & Alan Smith  
 Arnold & Agnes Sametz  
 Jane M. Sangerman & Joseph Vabopoulos  
 Dr. Zerah Schachtel  
 Don Schneider  
 Milton Scofield  
 Campbell Scott  
 Dana Segal  
 Mitchell Sernel & Colleen Carroll  
 Barry Shapiro  
 Joann Shapiro  
 Mr. & Mrs. George Shaskan  
 Bernice Bruch Show  
 Ann & Bill Sheffer  
 Sloane Shelton  
 Brian Sberrell & Patty Dryden  
 Jerome & Ruth Siegel  
 Loma Simpson  
 Amy E. Singer  
 Barry Singer & Jerine Ferrari  
 Mark Singer & Darcy Dunn  
 Miles A. Slater  
 Lois Smith  
 Adam Spilka  
 Ted Stanley  
 John Steber & Robert Shaffran  
 Robert Stecker  
 Robert Stein  
 Sue Steiner & Lori Rostwright  
 Byam Stevens & Robin Tighman  
 Andrew Sweet & Elise Taylor  
 Daniel Sweet  
 Jay Tarses  
 Mary Lou Teel & Peter Freundlich  
 Rutherford Thompson  
 John & Joan Vail Thorne  
 Gina Tarses  
 Yves & Rachel Tourne  
 Adriana Trigianni & Tim Stephenson  
 Kathleen Turner  
 Pamela Tyson  
 Laura Valerosa  
 Suzanne Vega  
 Mark Vietor  
 Peter Austin Vlachos  
 Mary Pat Walsh  
 Emma Walton & Stephen Hamilton  
 Wendy Wasserstein  
 Samuel H. Weiser  
 Lawrence & Wendy Weiss  
 Sally Weiss  
 Robert & Andrea Weiner  
 Max & Barbara Wilk  
 Susan Willerman  
 Jeff Williams  
 John & Pamela Wineapple  
 Terrence J. Witter  
 Joanne Woodward  
 James Woolton & Marc Cherry  
 Mr. & Mrs. Joe Yaccarino  
 Jeff & Janine Yass  
 Pierre Zimmerman

as of 11/04/94

The 52nd Street Project  
 presents

# The Forgotten Plays

Six new plays from The 52nd Street Project's  
 Plaback Program

Friday, November 4 at 7:30 pm  
 Saturday, November 5 at 3:00 and 7:30 pm  
 Sunday, November 6 at 3:00 pm

Ensemble Studio Theatre, New York City

In addition, The 52nd Street Project is truly grateful to the many individuals who have made gifts of less than \$100. THE FORGOTTEN PLAYS is also made possible in part with public funds from the National Endowment for the Arts, New York State Council on the Arts, The Department of Youth Services and the NYC Department of Cultural Affairs.

**The 52nd Street Project Presents  
The 1994 Playback Plays**

**The Forgotten Plays**

**November 4, 5, 6, 1994  
The Ensemble Studio Theatre - New York City**

**Project Staff**

Willie Reale, Artistic Director  
Carol Ochs, Executive Director  
Michael Bernard, Associate Artistic Director  
Jenny Gersten, Director of Marketing & Development  
Lisa Benavides, Production Manager  
Susan Vitucci, Development Consultant  
Iris A. Brown, Staff Graphic Designer  
Sabrina Rodriguez, Intern

**Production Staff**

Kevin Joseph Roach, Set Designer  
Greg MacPherson, Lighting Designer  
Barry Cohen, Assistant Lighting Designer  
Simma Gershenson, Stage Manager  
Slide Design: Nok Acharee, Andrew  
Jackson Kocher, Erick Kuo, Katherine  
Lumb, Paolo Mendoza, John Steward  
Jeff Day, Slide Photographer  
Kim Chandler, Props Design  
Colorforms Design: Evan Bernard, Traci  
Johnson, Sabrina Rodriguez,  
Vanessa Valdes, Sound Design  
Flyer design by Katherine K. Lumb  
Chef, Christopher Randolph  
Sous Chef, Gregor Paslawsky

Noël Dawkins & Jen Robinson, Slide  
Operators  
George Babiak & Raymond Ocasio,  
Furniture Crew  
Susan Murray & Diana Rojas,  
Props Crew  
Greg Paul & Jed Clarke, Colorforms  
Crew  
Light Hang: George Babiak, Lisa  
Benavides, Michael Bernard, Tim  
Nelson  
Set Load-In Crew: Lisa Benavides,  
Michael Bernard, Hank Meiman,  
Thomas Schall  
House Manager, Karin Barry  
House Crew:  
Beth Emelson, of course.

The 52nd Street Project is a non-profit organization that brings inner-city children from the Clinton neighborhood together with professional theater artists to create theater. THE FORGOTTEN PLAYS is a production of our Playback program. In it, an adult actor/playwright is paired with a kid actor/playwright. The duo is charged to invent two characters for the kid to write a play for. The adult then responds with a second play using the same two characters. The program was invented to challenge kids who are veterans of the Project's acting and writing programs.

**Board of Directors**

Ben Barenholtz	Rachel Chanoff
Wendy Ettinger, Chair	Louis P. Friedman
Stephen Graham	Larry Jones
Heidi Landesman	James McDaniel
Frances McDormand	Patricia M. Murphy
Carol Ochs	Willie Reale
Pamala Tyson	Laura Valeroso

**Special Thanks To:**

Helen, Peter and Christopher Randolph; Curt, Jacquelyn, Jim, Stephanie and all the interns at EST; New York Theatre Workshop; Michael Winter and New Dramatists; Hartley House; Gregor Paslawsky; Mike Quon Design Group; David Baron; Atlantic Theater Company; Negro Ensemble Company; George Babiak; Eddie Pepitone.

**In-Kind Contributions:**

Adobe, Inc.; Alpine Meat House; Ensemble Studio Theatre; Neil A. Mazzella & Hudson Scenic Studios, Inc.; Fairway Market; John A. Vassilaros & Sons; Colorforms; Baron & Baron; Virginia Dare; Shays & Murphy; Iris A. Brown & Bernhardt/Fudyma Design Group; Emily Grishman; New Dramatists; Hartley House; New York Theatre Workshop; Painter's Tavern; Playwrights Horizons; Eric Karpeles & Mike Sell; Stephen Graham; Steve Olsen & The West Bank Cafe; Andy Millon; Materials for the Arts; Tom Reale.

# **THE FORGOTTEN PLAYS**

## **BIG BROTHER AND SMALL BROTHER**

Written by Andre Parks, Age 12

Directed by Jerry McGill

Mark..... Andre Parks

Pete..... Jerry McGill

"The Dog and Cat Song" lyrics by Andre Parks, music by Michael Bernard; "I'm A Street Rapper" lyrics by Andre Parks

## **LEFT UNSAID**

Written and Directed by Jerry McGill

Mark..... Andre Parks

Pete..... Jerry McGill

## **FRIENDS AND MONEY**

Written by Luis Santoni, Age 15

Directed by Bill Wrubel

Tiny Tim..... Roberth Shaffron

Big Joe..... Luis Santoni

Security Guard..... Jed Clarke

## **LAST WORDS**

Written and Directed by Bill Wrubel

Big Joe..... Luis Santoni

Ghost..... Robert Shaffron

Tiny Tim..... Robert Shaffron

## **FORGOTTEN**

Written by Darthula Harvey, Age 13

Directed by Chris Ceraso

Ms..... Karen Kandel

Wendy Garrison..... Darthula Harvey

## **...AND FORGOTTEN AND FORGOTTEN AND...**

Written and Directed by Chris Ceraso

Wendy Garrison..... Darthula Harvey

Patricia Garrison..... Karen Kandel

Eloise..... Sabrina Rodriguez

# INTERMISSION

## UH, I FORGOT

Written by Dan Noonan, Age 13

Directed by Candido Tirado

Forgét..... Dan Noonan  
Paranoia..... Tom Carrozza  
Mrs. Forgét..... Lisa Benavides  
Mrs. Paranoia..... Sabrina Rodriguez

## I FORGÉT

Written and directed by Candido Tirado

Paranoia..... Tom Carrozza  
Forgét..... Dan Noonan  
Mrs. Forgét..... Lisa Benavides  
Mrs. Paranoia..... Sabrina Rodriguez

## MY MOTHER I'LL NEVER FORGET HER

Written by Yolanda Maldonado, Age 15

Directed by Seret Scott

Lilly..... Sandye Wilson  
Melissa..... Yolanda Maldonado

"Never Let Go" lyrics by Yolanda Maldonado, music by David Baron

## MY MOTHER I'LL NEVER FORGET HER - SCENE 2

Written and directed by Seret Scott

Lilly..... Sandye Wilson  
Melissa..... Yolanda Maldonado

## PART ONE

Written by Fernando Ramirez, Age 14

Directed by Willie Reale

Jose..... Fernando Ramirez  
Mom..... Martha Plimpton  
Gertrude..... Martha Plimpton

## PART TWO

Written and Directed by Willie Reale

Jose..... Fernando Ramirez  
Gertrude..... Martha Plimpton

Thank you for coming to THE FORGOTTEN PLAYS. If you are not on our mailing list (or if your address has changed), please fill out this form and give it to us on your way out, or mail it to the address below. We would also like to know if you are interested in becoming a volunteer. We are always in need of help in all areas, so, please fill out your name, address and phone number.

### PLEASE ADD ME TO YOUR MAILING LIST:

NAME \_\_\_\_\_

ADDRESS \_\_\_\_\_

\_\_\_\_\_ ZIP \_\_\_\_\_

PHONE \_\_\_\_\_

### YES, I WOULD LIKE TO BE OF HELP:

NAME \_\_\_\_\_

DAYTIME PHONE \_\_\_\_\_

**I AM REALLY USEFUL AT** (52nd Street Project related things only, i.e. mailings, backstage help, fundraising, etc.) \_\_\_\_\_

### ON SALE IN THE LOBBY

#### Project Stuff featuring the Shel Silverstein Logo

T-Shirts in 4 Glorious colors: \$12.00

Baseball Caps in 3 Glorious colors: \$15.00

#### Food Stuff

The Fabulous Flyer Bar \$1.50/\$1.00 for kids

Remember, one-half of sale price is tax-deductible!

If you would like to mail this (and you're always welcome to enclose a tax-deductible contribution), you can send it to:

The 52nd Street Project  
220 West 42nd Street, 18th Floor  
New York, NY 10036-7211  
(212) 764-1379

The 52nd Street Project gratefully acknowledges the support of the following foundations, corporations, and individuals: The Altman Foundation, The American Red Cross Overseas Association, Barker Wilkare Foundation, The B.E.T.A. Fund, Chase Manhattan Bank, Consolidated Edison, Barbara Bell Cumming Foundation, Nathan Cummings Foundation, D-B Trust, The Dammann Fund, Jody Danovue Associates, The Dramatists Guild Fund, Educational Foundation of America, Ferragamo, The William and Mary Greve Foundation, The Holland Lodge Foundation, The Barilo Ker Foundation, Kieh's, The MCI Foundation, The Marquis George Macdonald Foundation, The James Macdonald Foundation, The Ann M. Martin Foundation, Morgan Guaranty Trust Co., Morgan Stanley and Company, The William Morris Agency, The New World Foundation, The New York Times Company Foundation, Paul, Weiss, Ribkind & Garrison, The Pumpkin Foundation, RIM Group, Rockefeller Group, Russak Advertising, The Fan Fax and Leslie R. Sarnaels Foundation, The Shubert Organization, Shays & Murphy, The Shubert Organization, Jules & Davis Stein Foundation, Harold & Mimi Steinberg Charitable Trust, The Threshold Foundation, Annie Rensselaer Tinker Memorial Fund, Traveler's Fund, Variety, John A. Vasaleros & Sons, Inc., The Lila Acheson Wallace Theater Fund, The Wasserstein Perella Foundation, The West Bank Cafe, Yorke Construction, as well as matching gifts from AT&T, Bankers Trust, Alex & Brown & Sons, CBS Foundation, the Rockefeller Group, and The New York Times Company Foundation and the following individuals:

Mr. & Mrs. Roy A. Abramowitz  
 Pamela D. Adams  
 May Ameen  
 Nancy Ameen & Toby Hoden  
 Amy Merrill Ansara  
 Alan Arfo & Kay Matschullat  
 Emanuel Azenberg  
 Paola Bocini  
 Deborah Baker & Neil Wassner  
 June Ballinger & Michael Goldstein  
 Ben Barenholtz  
 Karin Bony  
 Angela Bassett  
 Gary Barton & Rob Hershman  
 Jessica Bauman  
 Laurie Beachman & Neil A. Mazzella  
 Neal Bell & Thom Babe  
 Kenneth J. Bennett  
 Myrna & Barry Benzard  
 Alexander Bernstein  
 Nina Bernstein  
 Mr. & Mrs. H. Gerald Bissinger  
 Eric Block  
 Susan & Ron Block  
 Richard Blackstone  
 R.O. Blechman  
 Robert & Alison Blinkin  
 Audrey Bloch  
 Judy Blume & George Cooper  
 Katherine Borowitz & John Turturo  
 Patricia Bradbury  
 Eric Brooks  
 Rita & Fred Brooks  
 Becky Browder & Ted Neustadt  
 Deborah Brown  
 Marc & Susan Brown  
 Kate Burton & Michael Ritchie  
 Maria Burbaum  
 Steven Callahan & Christine Dunn  
 Mr. & Mrs. Richard M. Cashin  
 Rachel Chonoff  
 Marissa Chabas & Travis Preston  
 William Christian  
 Joel Coen & Fran McDamand  
 Richard Cohen  
 Richard J. Cohn  
 Arthur Collins & Stephanie Barber  
 Eileen Cowel & David Sennett  
 Joan Straus Cullman  
 Arthur Dantschik  
 Cathy Dantschik  
 Mr. & Mrs. Peter Dowkins  
 Georgia Delano  
 Robert P. D'Elia  
 Judy Dennis  
 Mr. & Mrs. Dilagaris  
 Richard & Rebecca Dresser  
 Stephen J. Dubner  
 William Duff-Griffin  
 Jack & Jane Dunbar  
 Ned Eisenberg  
 Beth A. Emelson  
 John & Diana Engel  
 Barbara L. Ettinger  
 Richard P. Ettinger  
 Wendy Ettinger & Derek McLane  
 Martha Evans & Par Lohving  
 Frank Fava  
 Peter Jay Fernandez

Kristine Fleisher & David Sneedon  
 Rand Foerster & Jana McClure  
 Neza Fogel  
 Bridget Fonda & Eric Stoltz  
 Tom Fontana  
 Laurice Franca  
 David Frankel  
 Kermit Fraser  
 Judith Freed  
 Louis & Patricia Friedman  
 Charles Fuller  
 Judith Gasson & Steven Rappaport  
 Rose Gasner & Larry Chertoff  
 Thomas L. Gazanias  
 Bernard Gersten & Cara Cahon  
 Brian Gersten  
 Madeline Lee Giffard  
 Marian Godfrey  
 Pam & Kevin Goldman  
 Paula Goldstein  
 Sanford & Marion Goldstein  
 Susan Goldstein  
 Stephen & Cathy Graham  
 Rosalind & Mervin Gray  
 In memory of Kermit Greene  
 Colin Greer & Frances Labarre  
 Ellen Greis & John Kapernick  
 Emily Grishman  
 Sue Grossman  
 Lisa Gugenheim  
 Tim Guinee  
 A.R. Gurney  
 Brian Hagerman  
 Thomas Habikias  
 Linda J. Hall  
 John Hart  
 Stewart & Lamo Hoyim  
 Peter Hedges & Susan Bruce  
 In memory of Gertrude Heimer  
 David Herrlich & Elizabeth Palmer  
 Peter Herrlich & Karen Trott  
 John Heenan, Jr.  
 William J. Hiltsher  
 Francis W. Hill  
 Jane Hoffman  
 Lynn M. Holst  
 Willy Holtzman & Sylvia Shepard  
 Irwin Horowitz  
 Bernard Hughes & Helen Stenberg  
 Bill Irwin & Martha Roth  
 Mark Evan Jacobs  
 Sy Jacobs  
 Linda Lary Janklow  
 Kathy Jennings  
 Cindy Lou Johnson  
 Lorna Johnson  
 M. Lynne Johnson  
 Mr. & Mrs. Alistair D. Johnston  
 Larry & Mary McBreath-Jones  
 Karen & Paul Kandel  
 Judith & Michael Kane  
 Eric Karpales & Mike Sell  
 Richard & Josie Kastleman  
 Sheila Kehoe  
 Jayme Keyes  
 J. Russell King  
 Seth Klarman  
 Dr. & Mrs. Joseph Kolkier  
 Mary Kong

Louis Lanza  
 James Lapine  
 Thomas La Puppert  
 Carol LaValle  
 Mr. & Mrs. Jesse Lehman  
 Joshua Lehrer  
 Heather M. Lester  
 Jonathan & Stephanie Levi  
 Georgette & Martin J. Levy  
 Reto Levy  
 Ellen Lewis  
 Mark Linn-Baker  
 Derek Livingston  
 Thomas L. Luzzani  
 Marjorie Loggia  
 Craig Lucas  
 Rama Maffia & Peter DeCaste  
 Donald Margulies & Lynn Street  
 Constance Marks  
 Robert Marston  
 Carmen Matthews  
 Harriet Matschullat  
 Rikki S. Matthews  
 George J. Mavronicalas  
 Max D. Mayer  
 Colleen McLaurmey & Murray Verlin  
 Sally & Bruce McDermott  
 Andrew McKeon  
 Mr. & Mrs. McHells  
 Rebecca Miller  
 Andy Millon  
 Sally Campbell & Tom Morse  
 Jane & Bill Muddyman  
 Suzen Murakoshi  
 Michaela Murphy & Larry Nathanson  
 Kate Nelligan & Robert Keale  
 Randy & Rana Nelson  
 Timothy Nelson & Lisa Benovides  
 Ellen Novack  
 Janice Novack  
 Peter & Margaret O'Brien  
 Bryan O'Rourke  
 Kevin O'Rourke & Edith Thurber  
 Carol Ochs  
 Jacki Ochs & Jan Kroeze  
 Kazuto Ohira  
 Mr. & Mrs. Jaime Oriol  
 Eric Overmyer  
 Randy Poor  
 Steven E. Peter  
 David J. Peterkin & Nancy Jacobs  
 Thomas P. Peters  
 Robert & Susan Phillips  
 Oliver Platt & Camilla Campbell  
 Lawrence Palatchek  
 Martin F. Paris  
 Christopher Randolph  
 Helen & Peter Randolph  
 Tim & Tyson Smith-Ray  
 Paul Reake & Barbara McCrane  
 Janet Reich & Bart Eisbach  
 Jacquelyn Reingold  
 Maria Reveley  
 Elizabeth Rigg  
 Thymost Robertson  
 In memory of Jay Robinson  
 Dr. Bruce & Ellen Roseman

Daryl Roth  
 Donald J. Rothschild & Latchen Shivers  
 Sally & Joseph Russo  
 Martha Sader & Alan Smith  
 Arnold & Agnes Sametz  
 Jane M. Sangerman & Joseph Vodopalas  
 Dr. Zeborah Schochet  
 Dan Schneider  
 Milton Scofield  
 Campbell Scott  
 Dana Segal  
 Mitchell Sennel & Calleen Carroll  
 Barry Shapiro  
 Joann Shapiro  
 Mr. & Mrs. George Shaskan  
 Bernice Baruch Showl  
 Ann & Bill Sheffer  
 Sloane Shelton  
 Brian Sibeloff & Patty Dryden  
 Jerome & Ruth Siegel  
 Lama Simpson  
 Amy E. Singer  
 Barry Singer & Jenine Ferrai  
 Mark Singer & Darcy Dunn  
 Miles A. Slater  
 Lois Smith  
 Adam Spilka  
 Ted Stanley  
 John Steber & Robert Shaffran  
 Robert Stecker  
 Robert Stein  
 Sue Steiner & Lori Boothwright  
 Byam Stevens & Robin Tilghman  
 Andrew Sweet & Elise Taylor  
 Daniel Swave  
 Jay Tarses  
 Mary Lou Teel & Peter Freundlich  
 Rutherford Thompson  
 John & Joan Vail Thorne  
 Gina Torres  
 Yves & Rachel Toure  
 Adriana Trigiani & Tim Stephenson  
 Kathleen Turner  
 Pamela Tyson  
 Laura Valerosa  
 Suzanne Vega  
 Mark Viator  
 Peter Austin Vlachos  
 Mary Pat Walsh  
 Emma Walton & Stephen Hamilton  
 Wendy Wasserstein  
 Samuel H. Wasser  
 Lawrence & Wendy Weiss  
 Sally Weiss  
 Robert & Andrea Weiner  
 Max & Barbara Wilk  
 Susan Willerman  
 Jeff Williams  
 John & Pamela Wineapple  
 Terrence J. Winer  
 Joanne Woodward  
 James Wooten & Marc Cherry  
 Mr. & Mrs. Joe Yaccarino  
 Jeff & Janine Yess  
 Pierre Zimmerman

as of 12/28/94

In addition, The 52nd Street Project is truly grateful to the many individuals who have made gifts of less than \$100. SHHH...THE SECRET PLAYS is also made possible in part with public funds from the National Endowment for the Arts, New York State Council on the Arts, The Department of Youth Services and the NYC Department of Cultural Affairs.

The 52nd Street Project  
 presents



# The Secret Plays

Eight new plays by eight young writers from  
 The 52nd Street Project's Playmaking program

December 9, 7:30 p.m.  
 December 10, 3:30 & 7:30 p.m.  
 December 11, 3:30 & 7:30 p.m.

Playwrights Horizons Studio Theatre  
 New York City

The 52nd Street Project Presents  
The Fall 1994 Playmaking Plays

## Shhh...The Secret Plays

December 9, 10, 11, 1994

Playwrights Horizons Studio Theatre, New York City

### The 52nd Street Project Staff

Willie Reale, Artistic Director  
Carol Ochs, Executive Director  
Michael Bernard, Associate Artistic Director  
Jenny Gersten, Director of Marketing & Development  
Lisa Benavides, Production Manager  
Susan Vitucci, Development Consultant  
Iris A. Brown, Staff Graphic Designer  
Sabrina Rodriguez, Intern of Excellence

Alina Arenal, Playmaking Volunteer  
Barbara McCrane, Playmaking Volunteer  
Tim Nelson, Playmaking Volunteer  
John Steber, Playmaking Volunteer

### Production Staff

Kevin Joseph Roach, Set Designer  
Greg MacPherson, Lighting Designer  
Barry Cohen, Other Lighting Designer  
Crystal Thompson, Costume Design  
Kristi Lang, Costume Assistant  
Katherine Lumb, Stage Manager  
Slide Design:  
Nok Acaree, Mina Hammer, Erick Kuo,  
Andrew Jackson Kohler, Katherine Lumb,  
Paolo Mendoza, John Steward  
Wendy Stulberg, Slide Photographer  
Kim Chandler, Props Design  
Vanessa Valdes, Goddess of Sound  
Colorforms Design, Evan Bernard, Michele  
Mayas

Lisa Dove, Synthesizer Operator  
Jen Robinson, Slide Operator  
Greg Paul, Furniture Head  
Jeffrey Zambrano, Furniture Crew  
Elizabeth Keiser, Props Head  
Mary Vamvoukakis, Props Crew  
Jenny Gersten, Colorforms Head  
Tina Vamvoukakis, Colorforms Crew  
Load-In Crew:  
Barry Cohen, Lisa Dove, Kevin Geer,  
Tracy Knights Greg MacPherson, Tim  
Nelson, Kevin Roach, Thomas Schall,  
Bill Wrubel  
House Managers, Peter Manning & Julia  
Whitworth  
House Crew:  
Peggy Adler, Amanda Jacobs

The 52nd Street Project is a non-profit organization that brings inner-city children from the Clinton neighborhood together with professional theater artists to create theater. SHHH...THE SECRET PLAYS is part of our Playmaking program. Young people participate in eight weeks of classes adapted for the Project by Daniel Judah Sklar from his book, Playmaking: Children Writing and Performing Their Own Plays. During the eight weeks, the participants learn the elements of drama and write their first play. At the end of the class, each child is given two actors, a theme and a director who guides him or her through the writing of a play during a weekend in the country. SHHH...THE SECRET PLAYS are the fruits of their labors.

### Board of Directors:

Ben Barenholtz	Rachel Chanoff
Wendy Ettinger, Chair	Louis P. Friedman
Stephen Graham	Larry Jones
Heidi Landesman	James McDaniel
Frances McDormand	Patricia M. Murphy
Carol Ochs	Willie Reale
Pamala Tyson	Laura Valeroso

### Special Thanks To:

Stephen & Cathy Graham; Don Scardino, Leslie Marcus, Lynn Landis, Jack O'Connor, Michael Clark and the staff at Playwrights Horizons; New York Theatre Workshop; Michael Winter and New Dramatists; Mary Follett, Kate Walsh and the staff of Hartley House; Ken Terrell and the staff of Rheedlen Place; Charlotte Armstrong; Celia ; Mike Quon Design Group; Naked Angels; David Baron; Noel Dawkins; Tracy Kegan;

### In-Kind Contributions:

Alpine Meat House; Ensemble Studio Theatre; Neil A. Mazzella & Hudson Scenic Studios, Inc.; Fairway Market; John A. Vassilaros & Sons; Colorforms; Baron & Baron; Virginia Dare; Shays & Murphy; Iris A. Brown & Bernhardt/Fudyma Design Group; Emily Grishman; New Dramatists; Gifts In Kind America; Hartley House; New York Theatre Workshop; Painter's Tavern; Playwrights Horizons; Eric Karpeles & Mike Sell; Stephen Graham; Steve Olsen & The West Bank Cafe; Andy Millon; Materials for the Arts; Tom Reale.

# Shhh...The Secret Plays

The Fall 1994 Playmaking Plays

## ACT I

### BEST "SO-CALLED" FRIENDS

Written by Deshana Hamid, Age 10

Dramaturg, Michael Bernard

Director, Celina Davis

Wilted Flower. . . . . Melissa Murray

Big Friendly Tree. . . . . Gina Torres

Pretty Girl . . . . . Elizabeth Keiser/Celina Davis

### TELL THE TRUTH

Written by Laura Khalifa, Age 9

Dramaturg/Director, Michael angel Johnson

Brian. . . . . William Christian

Evelyn. . . . . Cynthia Nixon

### MY SECRET CHRISTMAS

Written by Yull Neri Borda, Age 12

Dramaturg/Director, Tim Nelson

Father. . . . . Leon "Trey" Wilson

Madaline. . . . . Kelly Taffe

### RAMON'S LOVE

Written by Ben Barthelemy, Age 11

Dramaturg/Director, Darryl Theirse

Ramon. . . . . Tyrone Wilson

Julie. . . . . Mary Testa

Spriit. . . . . Mary Testa

• INTERMISSION •



## ACT II

### THE CLUBHOUSE

Written by Corinda Smith, Age 11

Dramaturg/Director, Judy Goldman

Jenny..... Helene Lantry

Dad.....Michael Bernard

Crystal..... Alina Arenal

### SERVANTS

Written by Thomas Santoni, Age 10

Dramaturg/Director, Peter Francis James

John..... Gus Rogerson

Scarecrow.....Reed Birney

Voice of God..... Peter Francis James

and Willie Reale as Satan

### WAY DOWN SOUTH

Written by Elizabeth Carson, Age 12

Dramaturg, Lisa Benavides

Director, Moira Driscoll

Billy..... Saverio Guerra

Sally..... Barbara McCrane

### THE STREETFIGHTERS

Written by Frank Hansen, Age 11

Dramaturg/Director, George Babiak

Blood Boy..... Victor Mack

J.C Penney.....Gregor Paslawsky

Old Man..... George Spelvin

ALL MUSIC COMPOSED BY RUSTY MAGEE

Thank you for coming to SHHH...THE SECRET PLAYS. If you are not on our mailing list (or if your address has changed), please fill out this form and give it to us on your way out, or mail it to the address below. We would also like to know if you are interested in becoming a volunteer. We are always in need of help in all areas, so, please fill out your name, address and phone number.

#### PLEASE ADD ME TO YOUR MAILING LIST:

NAME \_\_\_\_\_

ADDRESS \_\_\_\_\_

\_\_\_\_\_ ZIP \_\_\_\_\_

PHONE \_\_\_\_\_

#### YES, I WOULD LIKE TO BE OF HELP:

NAME \_\_\_\_\_

DAYTIME PHONE \_\_\_\_\_

I AM REALLY USEFUL AT (52nd Street Project related things only, i.e. mailings, backstage help, fundraising, etc.) \_\_\_\_\_

#### ON SALE IN THE LOBBY

Remember, one-half of sale price is tax-deductible!

#### **Project Stuff featuring the Shel Silverstein Logo**

T-Shirts in 4 Glorious colors: \$12.00

Baseball Caps in 3 Glorious colors: \$15.00

#### **Food Stuff**

The Fabulous Flyer Bar \$1.50/\$1.00 for kids

If you would like to mail this (and you're always welcome to enclose a tax-deductible contribution), you can send it to:

The 52nd Street Project

220 West 42nd Street, 18th Floor

New York, NY 10036-7211

(212) 764-1379

The 52nd Street Project gratefully acknowledges the support of the following foundations, corporations, and individuals: The Altman Foundation, The American Red Cross Overseas Association, Banker Welfare Foundation, The B.E.T.A. Fund, Chase Manhattan Bank, Consolidated Edison, Barbara Bell Cunningham Foundation, Nathan Cummings Foundation, The Damann Fund, Jody Danahue Associates, The Dramatists Guild Fund, Educational Foundation of America, Faragamo, The William and Mary Grave Foundation, The Holland Lodge Foundation, The Rita J. and Stanley H. Kaplan Foundation, Kahl's, The Marquis George MacDonald Foundation, The James Macdonald Foundation, The Ann M. Martin Foundation, P. Morgan, Morgan Stanley and Company, The William Morris Agency, The New World Foundation, The New York Times Company Foundation, Paul, Weiss, Rifkind & Garrison, The Pumpkin Foundation, RIM Group, Rockefeller Group, Russak Advertising, The Fan Fax and Leslie R. Sarrouis Foundation, The Schubert Organization, Jules & Doris Stein Foundation, Harold & Mimi Steinberg Charitable Trust, The Threshold Foundation, Travelers Fund, Variety, John A. Vassilatos & Sons, Inc., The Lila Acheson Wallace Theater Fund, The West Bank Cafe, Yorke Construction, as well as matching gifts from AT&T, Bankers Trust, Alex & Brown & Sons, CBS Foundation, The Rockefeller Group, and The New York Times Company Foundation and the following individuals:

Mr. & Mrs. Roy A. Abramowitz  
Pamela D. Adams  
May Ameen  
Amy Merrill Aronson  
Alan Arfo & Kay Matuschullat  
Emanuel Azenberg  
Paola Baccini  
Deborah Baker & Neil Wosner  
June Ballinger & Michael Goldstein  
Francis S. Bahr  
Ben Barenholtz  
Karin Barry  
Angela Bassett  
Jessica Bauman  
Laurie Beechman & Neil A. Mazzella  
Neal Bell & Thom Babe  
Lisa Benavides & Timothy Nelson  
Pamela S. Berlin & William Carden  
Alyona & Barry Bernard  
Alexander Bernstein  
Nina Bernstein  
Mr. & Mrs. H. Gerald Bissinger  
Eric Block  
Susan & Ron Block  
Richard Blackstone  
R.O. Blechman  
Robert & Alison Blinken  
Audrey Bloch  
Judy Blume & George Cooper  
Katherine Borowitz & John Turturo  
Patricia Bradbury  
Bertha & Samuel Britt  
Eric Brooks  
Rita & Fred Brooks  
Becky Browder & Ted Neustadt  
Deborah Brown  
Marc & Susan Brown  
Denise Bursz & Peter Jay Fernandez  
Dorena L. Burton  
Kate Burton & Michael Ritchie  
Steven Callahan & Christine Dunn  
Mr. & Mrs. Richard M. Cashin  
Rachel Chanoff  
William Christian  
Joel Coen & Fran McDormand  
Richard Cohen  
Richard J. Cohn  
Arthur Collins & Stephanie Barber  
Eileen Cowel & David Sennett  
Joan Straus Cullman  
Arthur Dantchik  
Cathy Dantchik  
Mr. & Mrs. Peter Dawkins  
Georgia DeLano  
Robert P. D'Elia  
Judy Dennis  
Mr. & Mrs. DRogers  
Richard & Rebecca Dresser  
Stephen J. Dubner  
Jack & June Dunbar  
Ned Eisenberg  
Beth A. Ermsolon  
John & Diana Engel  
Barbara L. Ettinger  
Richard P. Ettinger  
Wendy Ettinger & Derek McLane  
Martha Evans & Par Loving  
Frank Fava  
Kristine Flasher & David Sneedon  
Rand Foerster & Jana McClure  
Alexa Fogal

Bridget Fonda & Eric Straltz  
Tom Fontana  
Leatrice Franco  
David Frankel  
Kermit Frasier  
Judith Freed  
Louis & Patricia Friedman  
Judith Garson & Steven Rappoport  
Rose Gosner & Larry Chertoff  
Thomas L. Gozanias  
Alexandra Gersten & John Vassilatos  
Bernard Gersten & Cora Cahon  
Jilian Gersten  
Pam & Kevin Goldman  
Paula Goldstein  
Sanford & Marion Goldstein  
Susan Goldstein  
Stephen & Cathy Graham  
Rosaland & Mervin Gray  
In memory of Kermit Greene  
Colin Greer & Francis LaBarre  
Janet L. Grillo & David Russell  
Emily Grishman  
Sue Grossman  
Lisa Gugenheim  
Tim Guinee  
A.R. Gurney  
Brian Hogerman  
Thomas Holikias  
Linda J. Holl  
Emma & Stephen Hamilton  
Marcia Gay Harden  
John Hart  
Stewart & Lorna Hoyim  
In memory of Gertrude Heimer  
Paul E. Jejinian & Charlotte Ellerston  
David Herdich & Elizabeth Palmer  
Peter Herdich & Karen Trott  
John Hemon, Jr.  
William J. Hipsler  
Francis W. Hill  
Jane Hoffman  
John Hoffman  
Lynn M. Holst  
Willy Holtzman & Sylvia Shepard  
Irwin Horowitz  
Bernard Hughes & Helen Stenberg  
Mr. & Mrs. David Henry Hwang  
Bill Irwin & Martha Roth  
Mark Evan Jacobs  
Sy Jacobs  
Linda Leroy Janklow  
Kathy Jennings  
Cindy Lou Johnson  
Lorna Johnson  
M. Lynne Johnson  
Mr. & Mrs. Alistair D. Johnston  
Lony & Mary McEbrath-Jones  
Karen & Paul Kandel  
Judith & Michael Kane  
Eric Karpales & Mike Sell  
Richard & Jessie Kastlerman  
Ron Kastner  
Sheila Kehoe  
Joyne Keyes  
J. Russell King  
Seth Klarman  
Dr. & Mrs. Joseph Kalkor  
Mary Kong  
Henry Krieger

Louis Lanza  
Tom Lapanie  
Thomas La Puppet  
Jill Larson  
Carol LaValle  
Mr. & Mrs. Jesse Lehman  
Joshua Lehrer  
Heather M. Lester  
Jonathan & Stephanie Levi  
Georgette & Marton J. Levy  
Reba Levy  
Mr. & Mrs. William G. Levy  
Ellen Lewis  
Mark Linn-Baker  
Derek Livingston  
Marjorie Loggia  
Julia Lord & Lee Kalcheim  
Craig Lucas  
Roma Maffia  
Elizabeth Marano  
Donald Marquies & Lynn Street  
Constance Marks  
Robert Marston  
Carmen Matthews  
Harriet Matuschullat  
Rikki S. Matthews  
George J. Mavronikolas  
Max D. Mayer  
Andrew McKeon  
Mr. & Mrs. McNeill  
Rebecca Miller  
Andy Millon  
Sally Campbell & Tom Morse  
Jane & Bill Muddymann  
Suzen Akurakoshi  
Michaela Murphy & Larry Nathanson  
Kate Neillson & Robert Keale  
Randy & Kona Nelson  
Ruth Nelson  
Ellen Novack  
Janice Novack  
Peter & Margaret O'Brien  
Byron O'Rourke  
Kevin O'Rourke & Edith Thurber  
Carol Ocho  
Jacki Ocho & Jan Kroeze  
Kazuto Ohira  
Mr. & Mrs. Jaime Oriol  
Eric Overmyer  
Randy Paar  
F. Richard Pappos  
Steven E. Peter  
David J. Peterkin & Nancy Jacobs  
Mr. & Mrs. Alton E. Peters  
Thomas P. Peters  
Robert & Susan Phillips  
Oliver Platt & Camilla Campbell  
Lawrence Polatchek  
Martin F. Paris  
Christopher Randolph  
Helen & Peter Randolph  
Tim & Tyson Smith-Ray  
Paul Reale & Barbara McCrone  
Janet Reich & Bart Eisbach  
Jacquelyn Reingold  
Maria Reveley  
Elizabeth Rigg  
Thyreast Robertson  
In memory of Jay Robinson  
Dr. Bruce & Ellen Roseman  
Mr. Arnold Rosenshine

Daryl Roth  
Donald J. Rothschild & Lottchen Shivers  
Sally & Joseph Russo  
Martha Soder & Alan Smith  
Arnold & Agnes Sametz  
Jane M. Sangerman & Joseph  
Yodopoulos  
Dr. Zorah Schachtel  
Dan Schneider  
Milton Seabold  
Campbell Scott  
Sere Scott  
Dana Segal  
Mitchell Semel & Colleen Carroll  
Beryl Shapiro  
Joann Shapiro  
Mr. & Mrs. George Shaskan  
Bernice Baruch Shawl  
Ann & Bill Sheffer  
Sloane Shelton  
Brian Sibersell & Patty Dryden  
Jerome & Ruth Siegel  
Lorna Simpson  
Amy E. Singer  
Bary Singer & Janine Ferrari  
Mark Singer & Darcy Dunn  
Miles A. Slater  
Lois Smith  
Adam Spilka  
Ted Starley  
John Steber & Robert Shaffron  
Robert Stecker  
Robert Stein  
Sue Steiner & Lori Boothwright  
Byam Stevens & Robin Tilgiman  
Catherine Strumbos  
Andrew Sweeney & Elise Taylor  
Daniel Swee  
In memory of Harlan J. Swift  
Joy Tarses  
Mary Lou Teel & Peter Freundlich  
Rutherford Thompson  
John & Joan Vail Thorne  
Gina Torres  
Yves & Rachel Toure  
Adriana Trigiani & Tim Stephenson  
Kathleen Turner  
Anne Twomey & John Bedford Lloyd  
Pamela Tyson  
Laura Valerosa  
Suzanne Vega  
Mark Vietor  
Peter Austin Vlachos  
Mary Pat Walsh  
Wendy Wasserstein  
Samuel H. Weiser  
Lawrence & Wendy Weiss  
Sally Weiss  
Robert & Andrea Weiner  
Max & Barbara Wilk  
Susan Willerman  
Jeff Williams  
John & Pamela Wineapple  
Terrence J. Witter  
Joanne Woodward  
James Wooten & Marc Cherry  
Mr. & Mrs. Joe Yaccarino  
Jeff & Janine Yass  
Pierre Zimmernan

## EXPECT THE UNEXPECTED



Eight new plays by eight young writers from  
The 52nd Street Project's Playmaking program

March 17, 7:30 p.m. • March 18, 3:00 & 7:30 p.m. • March 19, 3:00 p.m.

Ensemble Studio Theatre, New York City

The 52nd Street Project Presents  
The Unpredictable Spring 1995 Playmaking Plays

## EXPECT THE UNEXPECTED

March 17, 18, 19, 1995

Ensemble Studio Theatre, New York City

### The 52nd Street Project Staff

Willie Reale, Artistic Director

Carol Ochs, Executive Director

Michael Bernard, Associate Artistic Director

Jenny Gersten, Director of Marketing & Development

Eris Migliorini, Production Manager

Susan J. Vitucci, Development Consultant

Iris A. Brown, Staff Graphic Designer

Maura Griffin, Interna Maxima

Playmaking Volunteers: Lisa Benavides, Elizabeth Keiser, Kwana Martinez,  
Tim Nelson, Dexter Nesbitt

### Production Staff

Kevin Joseph Roach, Set Designer

Jan Kroeze, Lighting Designer

Greg MacPherson, Other Lighting Designer

Crystal Thompson, Costume Design

Kristi Lang, Costume Assistant?

Simma Gershenson, Stage Manager

Slide Design:

Nok Acaree, Erick Kuo, Katherine Lumb,

Phillip O'Brien, John Steward

Wendy Stulberg, Slide Photographer

Kim Chandler, Props Design

Vanessa Valdes, Goddess of Sound

Kelly Copper, Colorforms Design

David Baron, Composer

Noël Dawkins, Synthesizer Operator

Steven Hunt, Slide Operator

George Babiak, Furniture Head

Jed Clarke, Furniture Crew

Jilly Crook, Props Head

Jeffrey Zambrano, Props Crew

Cecilia Arana, Colorforms Head

Zsuzsa Mysak, Colorforms Crew

Load-In Crew:

Keith Benjamin, Michael Lugo, Hank

Meiman

Lights Crew:

Matthew Bonifacio, Carlo Trigiani,

Kathlyn Mackovjak

House Managers:

Karin Barry & Laura Sametz

House Crew:

Howard Solomon, Erica Tener, Carlo

Trigiani, Mary Pat Walsh

The 52nd Street Project is a non-profit organization that brings inner-city children from the Clinton neighborhood together with professional theater artists to create theater. EXPECT THE UNEXPECTED is part of our Playmaking program. Young people participate in eight weeks of classes adapted for the Project by Daniel Judah Sklar from his book, Playmaking: Children Writing and Performing Their Own Plays. During the class sessions, the participants learn the elements of drama and write their first play. At the end of the class, each child is given two actors, a theme and a director who guides him or her through the writing of a play during a weekend retreat in the country. The EXPECT THE UNEXPECTED plays are the fruits of their labors.

### Board of Directors:

Ben Barenholtz

Wendy Ettinger, Chair

Stephen Graham

Heidi Landesman

Frances McDormand

Carol Ochs

Pamala Tyson

Rachel Chanoff

Louis P. Friedman

Larry Jones

James McDaniel

Patricia M. Murphy

Willie Reale

Laura Valeroso

### Special Thanks To:

Eric Karpeles & Mike Sell; Curt Dempster, Jacquelyn Siegel, Abigail Zealey and the staff at Ensemble Studio Theatre; Roberta Crane and Wayne Braffman; Joyce Castleberry and Gerry Hovagimyan; Martha Sader; Gary Rickard; Larry Wolhandler; New York Theatre Workshop; Michael Winter and New Dramatists; Mary Follett, Kate Walsh, Yvonne LaViale and the staff of Hartley House; Ken Terrell and the staff of Rheedlen Place; Mike Quon Design Group; David Baron; Kathlyn Mackovjak; Mary Vamvoukakis would like to dedicate her play, "The Mystery" to her mother and her whole family.

### In-Kind Contributions:

Alpine Meat House; Ensemble Studio Theatre; Neil A. Mazzella & Hudson Scenic Studios, Inc.; Fairway Market; John A. Vassilaros & Sons; Colorforms; Baron & Baron; Virginia Dare; Shays & Murphy; Iris A. Brown & Bernhardt/Fudyma Design Group; Emily Grishman; New Dramatists; Gifts In Kind America; Hartley House; New York Theatre Workshop; Painter's Tavern; Playwrights Horizons; P.S. 111; Eric Karpeles & Mike Sell; Stephen Graham; Steve Olsen & The West Bank Cafe; Andy Millon; Materials for the Arts; Tom Reale.

# EXPECT THE UNEXPECTED

The Unpredictable Spring 1995 Playmaking Plays

## ACT I

### EXCHANGE

Written by Stephanie Santana, Age 12

Dramaturg/Director, Lili Taylor

Chris..... Michael Imperioli  
Dayamara..... Karen Trott  
King..... Michael Bernard

### THE MYSTERY

Written by Mary Varnvoukakis, Age 10

Dramaturg/Director, Marissa Chibas

Maria..... Lois Smith  
Lisa-Jay..... Lisa Gay Hamilton

### BURGLARIES IN NEW YORK

Written by Jason Prieto, Age 12

Dramaturg/Director, Tim Nelson

Freddy..... Alvin Alexis  
Brian..... Charles Dumas  
Officer Y..... Kevin Geer

### BULLDOG DRUMMEN, P.I.

Written by Tony Santiago, Age 11

Dramaturg/Director, Carl Capotorto

Bulldog..... Peter Jay Fernandez  
Chrystal..... Denise Burse

"I'm Getting Suspicious" and "X Man's Lament" lyrics by Tony Santiago, music by David Baron

• INTERMISSION •

## ACT II

### THE ADVENTURES OF STRONGLEY THE DRAGON

Written by David Dominique, Age 9

Dramaturg, Willie Reale

Director, Dion Graham

Strongley..... Frank Wood

Witch..... Wafa Cunningham

### JEM AND FOOTBALL

Written by Jonathan Santiago, Age 11

Dramaturg/Director, Michael Bernard

Jem..... Robert Jimenez

Mom..... Angela Trento

### A COMEDY ABOUT THE DEATH PENALTY

Written by Judy Agosto, Age 10

Dramaturg/Director, Lisa Benavides

Raymond..... John Fiedler

Lady/Marsha..... Michelle Hurst

### SPEEDY AND SLOWLY

Written by Marcsi Mysak, Age 9

Dramaturg/Director, Elizabeth Keiser

Speedy..... Larry Nathanson

Slowly..... Michaela Murphy

"You and Me" lyrics by Marcsi Mysak, music by David Baron

Thank you for coming to EXPECT THE UNEXPECTED. If you are not on our mailing list (or if your address has changed), please fill out this form and give it to us on your way out, or mail it to the address below. We would also like to know if you are interested in becoming a volunteer. We appreciate any help in all areas, so, if you're interested, leave us your name and phone number and someone from our staff will contact you soon.

#### PLEASE ADD ME TO YOUR MAILING LIST:

NAME \_\_\_\_\_

ADDRESS \_\_\_\_\_

\_\_\_\_\_ ZIP \_\_\_\_\_

PHONE \_\_\_\_\_

#### YES, I WOULD LIKE TO BE OF HELP:

NAME \_\_\_\_\_

DAYTIME PHONE \_\_\_\_\_

I AM REALLY USEFUL AT (52nd Street Project related things only, i.e. mailings, backstage help, fundraising, etc.) \_\_\_\_\_

#### ON SALE IN THE LOBBY

Remember, one-half of sale price is tax-deductible!

#### **Project Stuff featuring the Shel Silverstein Logo**

T-Shirts in 4 Glorious colors: \$12.00

Baseball Caps in 3 Glorious colors: \$15.00

#### **Food Stuff**

The Fabulous Flyer Bar \$1.50/\$1.00 for kids

If you would like to mail this (and you're always welcome to enclose a tax-deductible contribution), you can send it to:

The 52nd Street Project  
220 West 42nd Street, 18th Floor  
New York, NY 10036-7211  
(212) 764-1379

If you would like to order The 52nd Street Project's Kid Theater Kit, call Dramatists Play Service at 683-8960, and more information call the Project office.

52nd Street Project gratefully acknowledges the support of the following foundations, corporations, and individuals: The Altman Foundation, The American Red Cross Overseas Association, Welfare Foundation, The B.E.T.A. Fund, Chase Manhattan Bank, Consolidated Edison, Barbara Bell Cunningham Foundation, Nathan Cummings Foundation, The Darrmann Fund, Judy Hove Associates, The Dramatists Guild Fund, Educational Foundation of America, Ferragamo, The Wilbur and Mary Greve Foundation, The Holland Lodge Foundation, The Rita J. and My H. Kaplan Foundation, Kell's, The Marcus George MacDonald Foundation, The James MacDonald Foundation, The Ann M. Martin Foundation, J.P. Morgan, Morgan Stanley and Co., The William Morris Agency, The New World Foundation, The New York Times Company Foundation, Paul, Weiss, Rifkind & Garrison, The Pumpkin Foundation, RJM Group, Steiner Group, Russak Advertising, The Fox Fox and Leslie R. Samuels Foundation, The Schubert Organization, Jules & Doris Stein Foundation, Harold B. Mann Steinberg Charitable Trust, Threshold Foundation, Travelers Fund, Vanity, John A. Vasilaros & Sons, Inc., The Uta Haden Wallace Theatre Fund, The West Bank Cafe, Yorke Construction, as well as matching from AT&T, Bankers Trust, Alex & Brown & Sons, CBS Foundation, The Rockefeller Group, and The New York Times Company Foundation and the following individuals:

3 Mrs. Roy A. Abramowitz  
 10 D. Adams  
 Ameen  
 Merrill Ansara  
 Alfia & Kay Matschulat  
 Axel Azenberg  
 1 Boca  
 10 Baker & Neil Wassner  
 Ballinger & Michael Goldstein  
 10 S. Baher  
 Barenholtz  
 1 Barry  
 10 Bassett  
 10 Bowman  
 10 Beechman & Neil A. Mazzella  
 Bell & Thom Babe  
 Benavides & Timothy Nelson  
 10 S. Binin & William Cardan  
 10 B. Barry Bernard  
 10 Berstein  
 10 Berstein  
 3 Mrs. H. Gerald Bissinger  
 10 Block  
 10 & Ron Black  
 10 Blackstone  
 10 Blackman  
 10 B. Allison Blinken  
 10 Bloch  
 10 Blume & George Cooper  
 10 Branne Barowitz & John Turbano  
 10 Broadway  
 10 B. Samuel Britt  
 10 Brooks  
 10 Fred Brooks  
 10 Browder & Ted Neustadt  
 10 Brown  
 10 Susan Brown  
 10 Busse & Peter Jay Fernandez  
 10 L. Burton  
 10 Burton & Michael Ritchie  
 10 Callahan & Christine Dunn  
 3 Mrs. Richard M. Cashin  
 10 Chanoff  
 10 Christian  
 10 Coen & Fran McDormand  
 10 Cohen  
 10 J. Cohen  
 10 Collins & Stephanie Barber  
 10 Cowell & David Sennett  
 10 Straus Cullman  
 10 Dantchik  
 10 Dantchik  
 10 Dantchik  
 3 Mrs. Peter Dawkins  
 10 Delano  
 10 P. D'Elia  
 10 Dennis  
 3 Mrs. Dirkupers  
 10 & Rebecca Dresser  
 10 E. Dubner  
 10 E. Juna Dunbar  
 10 Eisenberg  
 10 A. Emelton  
 10 B. Diana Engel  
 10 E. Etinger  
 10 P. Etinger  
 10 Etinger & Derek McLane  
 10 Evans & Pat Lohing  
 10 Fava  
 10 Fleisher & David Sneddon  
 10 Foerster & Jane McClure  
 10 Fogel

Bridget Fonda & Eric Stoltz  
 Tom Fontana  
 Leatrice Franco  
 David Frankel  
 Kermit Fraser  
 Judith Freed  
 Louis & Patricia Friedman  
 Judith Garson & Steven Kappoport  
 Rose Gazner & Larry Chertoff  
 Thomas I. Gazanos  
 Alexandra Gersten & John Vassilatos  
 Bernard Gersten & Cora Cohen  
 Ilhan Gersten  
 Pam & Kevin Goldman  
 Paula Goldstein  
 Sanford & Maron Goldstein  
 Susan Goldstein  
 Stephan & Cathy Graham  
 Retalind & Mervyn Gray  
 In memory of Kermit Greene  
 Colin Greer & Frances LaBarre  
 Janet L. Grillo & David Russell  
 Emily Greshman  
 Sue Grossman  
 Lisa Gupenhaim  
 Tim Gurnee  
 A.R. Gurney  
 Brian Hagerman  
 Thomas Hakizas  
 Linda J. Hall  
 Emma & Stephen Hamilton  
 Marica Gay Harden  
 John Hart  
 Stewart & Lorna Hayim  
 In memory of Gertrude Heimer  
 Paul E. Jessiman & Charlotte Ellerston  
 David Herdich & Elizabeth Palmer  
 Peter Herdich & Karen Trott  
 John Heron, Jr.  
 William J. Hibshaw  
 Francis W. Hill  
 Jane Hoffman  
 John Hoffman  
 Lynn M. Holst  
 Willy Holtzman & Sylvia Shepard  
 Irwin Horowitz  
 Bernard Hughes & Helen Sternberg  
 Mr. & Mrs. David Henry Hwang  
 Bill Irwin & Martha Roth  
 Mark Evan Jacobs  
 Sy Jacobs  
 Linda Lacey Janikow  
 Kathy Jennings  
 Candy Lou Johnson  
 Lorna Johnson  
 M. Lynne Johnson  
 Mr. & Mrs. Alston D. Johnston  
 Larry & Mary McElrath-Jones  
 Karen & Paul Kandel  
 Judith & Michael Kane  
 Eric Kappeles & Mike Sall  
 Richard & Josie Kastlerman  
 Ron Kastner  
 Sheila Kehoe  
 Jayne Keyes  
 10 Russell King  
 Seth Klarman  
 Dr. & Mrs. Joseph Kolker  
 Mary Kong  
 Henry Kruger

Louis Lanza  
 James Lapine  
 Thomas La Puppert  
 Jill Larson  
 Carol LaValle  
 Mr. & Mrs. Jesse Lehman  
 Joshua Lehrer  
 Heather M. Lester  
 Jonathan & Stephanie Levi  
 Georgette & Martin J. Levy  
 Reba Levy  
 Mr. & Mrs. William G. Levy  
 Ellen Lewis  
 Mark Linn-Baker  
 Derek Livingston  
 Marjorie Loggia  
 Julia Lord & Lee Kalchauer  
 Craig Lucas  
 Roma Matha  
 Elizabeth Marne  
 Donald Margulies & Lynn Street  
 Constance Marks  
 Robert Marston  
 Emily Marshman  
 Carmen Matthews  
 Horriet Matschulat  
 Rikki S. Matthews  
 George J. Monanickos  
 Max D. Mayer  
 Andrew McKean  
 Mr. & Mrs. McNeill  
 Rebecca Miller  
 Andy Millon  
 Sally Campbell & Tom Morse  
 Jane & Bill Muddyman  
 Suzan Morakoshi  
 Michaela Murphy & Larry Nathanson  
 Kate Nelligan & Robert Koole  
 Peter Nelson  
 Ruth Nelson  
 Ellen Novack  
 Janice Novack  
 Peter & Margaret O'Brien  
 Bryan O'Rourke  
 Kevin O'Rourke & Edith Thurber  
 Carol Ochs  
 Jacki Ochs & Jan Kooze  
 Kazuo Ohira  
 Mr. & Mrs. Jaime Onil  
 Eric Overmyer  
 Randy Pace  
 F. Richard Pappas  
 Steven E. Peter  
 David J. Peterkin & Nancy Jacobs  
 Mr. & Mrs. Alton E. Peters  
 Thomas P. Peters  
 Robert & Susan Phillips  
 Oliver Platt & Camilla Campbell  
 Lawrence Polatchek  
 Martin F. Paris  
 Christopher Randolph  
 Helen & Peter Randolph  
 Tim & Lyson Smith-Ray  
 Paul Reale & Barbara McCrane  
 Janet Reich & Bari Esbach  
 Jacquelyn Reingold  
 Maria Reveley  
 Elizabeth Rigg  
 Thyreast Robertson  
 In memory of Jay Robinson  
 Dr. Bruce & Ellen Roseman  
 Mr. Arnold Rosenshine

Daryl Roth  
 Donald J. Rothschild & Lorraine Shivas  
 Sally & Joseph Russo  
 Martha Sader & Alan Smith  
 Arnold & Agnes Sametz  
 Jane M. Sangerman & Joseph  
 Vadopoulos  
 Dr. Deborah Schochet  
 Don Schneider  
 Milton Schofield  
 Campbell Scott  
 Seret Scott  
 Dana Segal  
 Mitchell Sernal & Colleen Carroll  
 Barry Shapiro  
 Joann Shapiro  
 Mr. & Mrs. George Shekian  
 Bernice Brauch Shawl  
 Ann & Bill Shaffer  
 Skane Shelton  
 Brian Siberell & Patty Dryden  
 Jerome & Ruth Siegel  
 Lorna Simpson  
 Amy E. Singer  
 Barry Singer & Jenine Ferrari  
 Mark Singer & Darcy Dunn  
 Miles A. Slater  
 Lois Smith  
 Adam Spilka  
 Ted Stanley  
 John Steber & Robert Shaffron  
 Robert Stecker  
 Robert Stein  
 Sue Steiner & Lori Boatwright  
 Byam Stevens & Robin Tighman  
 Catherine Strumbos  
 Andrew Sweet & Elise Taylor  
 Darrel Sweet  
 In memory of Harlan J. Swift  
 Jay Tarses  
 Mary Lou Teel & Peter Freundlich  
 Rutherford Thompson  
 John & Joan Van Thorne  
 Gina Torres  
 Yves & Rachel Tourne  
 Adriano Trigiani & Tim Stephenson  
 Kathleen Turner  
 Anne Twomey & John Bedford Lloyd  
 Pamela Tyson  
 Laura Valerato  
 Suzanne Vega  
 Mark Vietor  
 Peter Austin Voches  
 Mary Pat Walsh  
 Wendy Wasserstein  
 Samuel H. Wester  
 Lawrence & Wendy Weiss  
 Sally Weiss  
 Robert & Andrea Wener  
 Max & Barbara Wilk  
 Susan Wilkerman  
 Jeff Wilkerson  
 John & Pamela Wineapple  
 Tenencia J. Witt  
 Joanne Woodward  
 James Wooten & Marc Chery  
 Mr. & Mrs. Joe Yaccarino  
 Jeff & Janine Yoss  
 Pierre Zimmerman

The 52nd Street Project  
 presents



The Sequel

Monday, April 17th & Tuesday, April 18th, 1995

West Bank Cafe  Downstairs Theatre

407 West 42nd Street, New York City

dition, The 52nd Street Project is truly grateful to the many individuals who have made gifts of less than \$100. EUREKA 2! THE SEQUEL is also made possible in part with funds from the National Endowment for the Arts, New York State Council on the Arts, The Department of Youth Services and the NYC Department of Cultural Affairs.

Design & Illustration by Iris A. Brown

as of 3/14/95

The 52nd Street Project Presents  
The 1995 Two-on-Twos

# **Eureka 2!** **The Sequel**

April 17th and 18th, 1995  
West Bank Cafe Downstairs Theatre

## **The 52nd Street Project Staff**

Willie Reale, Artistic Director  
Carol Ochs, Executive Director  
Michael Bernard, Associate Artistic Director  
Jenny Gersten, Director of Marketing & Development  
Eris Migliorini, Production Manager  
Susan J. Vitucci, Development Consultant  
Iris A. Brown, Staff Graphic Designer  
Maura Griffin, Intern of Greatness

## **Production Staff**

Kevin Joseph Roach, Set Designer  
Hank Meiman, Lighting Designer  
Costume Design, Sheila Kehoe, Karen  
Roston and Deborah Rubin  
Fred Carl, Composer  
Albin Konopka, Musical Director  
Jessica Murrow, Sound Design  
Kim Chandler, Props Design  
Hank Meiman, Stage Manager

Set and Props Builders, Evan Bernard; Kim  
Chandler; Kelly Copper; Jilly Crook;  
Maura Griffin; Mina Hammer; Katherine  
Lumb; Kate McCamy; Scott Ramsay;  
Kevin Joseph Roach; John Steward;  
Alberta Testanero  
Rod Alonzo, Furniture Head  
Betsy Foldes, Furniture Crew  
Jilly Crook, Props Head  
Diana Rojas, Props Crew  
House Manager, Laura Sametz  
Bar Staff:  
Jenny Gersten, Anthony Maldonado,  
Joanne Ramirez and Bill Wrubel

**The 1995 Two-on-Twos program is made possible in part by a  
Cultural Challenge Grant from the NYC Department of Cultural  
Affairs and the New York State Council for the Arts.**

**The 52nd Street Project gratefully acknowledges  
D'Agostino Supermarkets and Dr. Brown's  
for their generous contribution of vanilla ice cream and root beer,  
respectively, for these performances.**

The 52nd Street Project is a non-profit organization that brings inner-city children from the Hell's Kitchen neighborhood together with professional theater artists to create theater. EUREKA 2! The Sequel is part of the Two-on-Two program, in which a professional playwright creates a play specifically for two kids who are then guided by an adult director. The Two-on-Two's represent the second level of the Project's three-part acting program.

## **Board of Directors**

Ben Barenholtz	Rachel Chanoff
Wendy Ettinger, Chair	Louis P. Friedman
Stephen Graham	Larry Jones
Heidi Landesman	James McDaniel
Frances McDormand	Patricia M. Murphy
Carol Ochs	Willie Reale
Pamala Tyson	Laura Valeroso

## **Special Thanks To:**

Steve Olsen, Rand Foerster, Hank Meiman and the West Bank Cafe; Michael Winter, Ron Riley and the staff of New Dramatists; Joshua Lehrer and the Atlantic Theater Company; New York Theatre Workshop; Wendy Ettinger & Derek McLane; Maria Tucci; Lorna and The Pines; Materials for the Arts; Calista Hendrickson; Sheila Kehoe; and Fred Carl.

## **In-Kind Contributions:**

Alpine Meat House; Ensemble Studio Theatre; Neil A. Mazzella & Hudson Scenic Studios, Inc.; Fairway Market; John A. Vassilaros & Sons; Citibank, N.A.; Colorforms; Baron & Baron; Virginia Dare; Shays & Murphy; Iris A. Brown & Bernhardt/Fudyma Design Group; Emily Grishman; New Dramatists; Gifts In Kind America; Hartley House; Kiehl's; New York Theatre Workshop; Painter's Tavern; Playwrights Horizons; P.S. 111; Eric Karpeles & Mike Sell; Stephen Graham; Steve Olsen & The West Bank Cafe; Andy Millon; Materials for the Arts; Tom Reale; Joseph E. Seagram & Sons; Scholastic Productions.

# EUREKA 2! THE SEQUEL

## **SUBWAY STORY**

Written by Tim Meadows & Jennifer Unter

Directed by Juliette Carrillo

Stocky Bonds. . . . . Raymond Harold

Carla Cuttadealya. . . . . Natasha Soto

"The Song from the play 'Subway Story'"

lyrics by Michael Bernard

music by Fred Carl

## **NEW FRIENDS?**

Written by Candido Tirado

Directed by John Steber

Ramona. . . . . Yolanda Maldonado

Computer . . . . . Tina Vamvoukakis

"Something to Remember"

lyrics by Willie Reale

music by Fred Carl

## **THE CHOCOLATE SLIPPER**

Written by Michael angel Johnson

Directed by Joe White

Professor Reason . . . . . Victor Rojas

Mimi. . . . . Kulondi Frier

Business Woman . . . . . Kulondi Frier

Donald . . . . . Victor Rojas



**CONTINUED...**

**THE TENDER TRAP DOOR**

Written by Michael Bernard  
Directed by Taro Alexander

New Jersey Jones. .... Jennifer Socarras  
DW. .... Jed Clarke

“Under Your Nose”  
lyrics by Willie Reale  
music by Fred Carl

**THE DOCTOR IS IN**

Written by Susan Kim  
Directed by Martha Banta

Dr. Shirley Livingstone. .... Samona Squire  
Sylvia Fowler-Griffin. .... Dawn Jackson

**TALK THE TALK**

Written by Bill Wrubel  
Directed by Eris Migliorini

Zeke. .... Eric Santoni  
Deke. .... Eddie Zambrano

“Delores Delmonico and Me”  
lyrics by Willie Reale  
music by Fred Carl

Thank you for coming to EUREKA 2! THE SEQUEL. If you are not on our mailing list (or if your address has changed), please fill out this form and give it to us on your way out, or mail it to the address below. We would also like to know if you are interested in becoming a volunteer. We are always in need of help in all areas, so, please fill out your name, address and phone number.

**PLEASE ADD ME TO YOUR MAILING LIST:**

NAME \_\_\_\_\_

ADDRESS \_\_\_\_\_

\_\_\_\_\_ Zip \_\_\_\_\_

PHONE \_\_\_\_\_

**YES, I WOULD LIKE TO BE OF HELP:**

NAME \_\_\_\_\_

DAYTIME PHONE \_\_\_\_\_

**I AM REALLY USEFUL AT** (52nd Street Project related things only, i.e. mailings, backstage help, fundraising, etc.) \_\_\_\_\_

\_\_\_\_\_

**ON SALE AT THE BAR**

52nd Street Project T-Shirts with Shel Silverstein Logo: \$12.00

Remember, one-half of sale price is tax-deductible!

If you would like to mail this (and you're always welcome to enclose a tax-deductible contribution), you can send it to:

The 52nd Street Project  
220 West 42nd Street, 18th Floor  
New York, NY 10036-7211  
(212) 764-1379

The 52nd Street Project gratefully acknowledges the support of the following foundations, corporations, and individuals: The Almont Foundation, The American Red Cross Overseas Association, Banker Welfare Foundation, The B.E.T.A. Fund, Chase Manhattan Bank, Consolidated Edison, Barbara Bell Currenng Foundation, Nathan Currenng Foundation, The Doremus Fund, Jody Dorekian Associates, The Doremus Gold Fund, Educational Foundation of America, Frangipane, The Wilson and Mary Grove Foundation, The Holland Lodge Foundation, The Ito J. and Stanley R. Kaplan Foundation, Telf's, The Marquis George Macdonald Foundation, The James Macdonald Foundation, The Ann M. Martin Foundation, P. Morgan, Morgan Stanley and Company, The Wilson Morris Agency, The New World Foundation, The New York Times Company Foundation, Paul, Weiss, Rind & Garrison, The Pumpkin Foundation, RHM Group, Raskaloff Group, Raskal Advertising, The Fox Fox and Leslie R. Schwartz Foundation, The Student Organization, Alex & Dana Stein Foundation, Harold & Henri Steinberg Charitable Trust, The Theobald Foundation, Tronies Fund, Varsity, John A. Vassalano & Sons, Inc., The Leo Acheson Wallace Theater Fund, The West Bank Cafe, York Construction, as well as matching gifts from A.T.&T., Bankers Trust, Aler & Brown & Sons, CBS Foundation, the Rockefeller Group, and The New York Times Company Foundation and the following individuals:

Mr. & Mrs. Roy A. Abramowitz  
 Pamela D. Adams  
 May Amann  
 Amy Merrill Amson  
 Alan Aron & Roy Altschuler  
 Emanuel Aronberg  
 Paula Baccini  
 Deborah Baker & Hal Wassner  
 Jane Ballinger & Michael Goldstein  
 Frances S. Baker  
 Ben Barabatz  
 Robin Barry  
 Angela Bassett  
 Jessica Baurman  
 Laurie Bachman & Hal A. Mazzella  
 Ned Bell & Thom Eske  
 Lisa Bennefeld & Timothy Nelson  
 Pamela S. Bialik & William Gordon  
 Wayne & Barry Berman  
 Alexander Bernstein  
 New Bernstein  
 Mr. & Mrs. H. Gerald Bissinger  
 Eric Block  
 Susan & Bob Block  
 Richard Blockstein  
 R.D. Blockman  
 Robert & Wilson Block  
 Andrew Block  
 Judy Bluma & George Cooper  
 Catherine Bonowitz & John Turkus  
 Patricia Bosbury  
 Barbra & Samuel Brit  
 Eric Brooks  
 Rho & Fred Brooks  
 Becky Brewster & Ted Husted  
 Deborah Brown  
 Marc & Susan Brown  
 Denise Buzar & Peter Jay Fernandez  
 Duane L. Burton  
 Kay Burton & Michael D'Elia  
 Shanon Callahan & Christine Dunn  
 Mr. & Mrs. Richard M. Cashin  
 Carol Charnoff  
 William Chutkan  
 Joel Coon & Fran McDermott  
 Richard Cohen  
 Richard J. Cohn  
 Arthur Collins & Stephanie Barlow  
 Elissa Conell & David Sarant  
 Joan Strauss Coleman  
 Arthur Conchick  
 Cathy Conchick  
 Mr. & Mrs. Peter Donkers  
 Georgia Dalano  
 Robert P. D'Elia  
 Judy Daniels  
 Mr. & Mrs. D'Elia  
 Richard & Rebecca Drexler  
 Stephen J. Dizon  
 Jack & Jane Dunbar  
 Ned Eisenberg  
 Beth A. Emanuel  
 John & Diana Engel  
 Barbara L. Ettinger  
 Richard P. Ettinger  
 Wendy Ettinger & Derek McLain  
 Martha Evans & Pw Lohing  
 Frank Fove  
 Kristine Fierher & David Swendsen  
 Rand Fenster & Jane McClure  
 Alexis Fogel

Bikey Fund & Eric Stahl  
 Tom Fontana  
 Lucette Franco  
 David Frankel  
 Kermit Frowie  
 Judith Fried  
 Laura & Patricia Friedman  
 Judith Gerson & Steven Kappoport  
 Rose Georje & Larry Chertoff  
 Thomas L. Gezasics  
 Alexandra Gersten & John Youssarian  
 Bernard Gersten & Cara Cohen  
 Jean Gersten  
 Pam & Kevin Goldman  
 Paula Goldstein  
 Sanford & Morton Goldstein  
 Susan Goldstein  
 Stephen & Cathy Graham  
 Rosalind & Marvin Gray  
 In memory of Ernest Greene  
 Colin Greer & Frances Lubera  
 Janet L. Griffin & David Russell  
 Emily Grisham  
 Sue Grossman  
 Lisa Gugelbaum  
 Tom Grunow  
 A.R. Gurney  
 Brian Hagerman  
 Thomas Halkias  
 Linda J. Hall  
 Emma & Stephen Hamilton  
 Marcia Goy Harlan  
 John Hart  
 Stewart & Lorna Hoyim  
 In memory of Gertrude Heimer  
 Paul E. Hejman & Charlotte Eberstein  
 David Herdich & Elizabeth Palmer  
 Peter Herdich & Karen Irest  
 John Herten, Jr.  
 William J. Hisher  
 Francis W. Hill  
 Jane Hoffman  
 John Hoffman  
 Lyne M. Holt  
 Willy Halzman & Sylvia Shepard  
 Irwin Horowitz  
 Bernard Hughes & Helen Steinberg  
 Mr. & Mrs. David Henry Hwang  
 Bill Irwin & Martha Roth  
 Mark Eyan Jacobs  
 Sy Jacobs  
 Linda Lary Jarblow  
 Kathy Jennings  
 Cindy Lay Johnson  
 Lorna Johnson  
 M. Lynne Johnson  
 Mr. & Mrs. Alister D. Johnson  
 Larry & Mary McEeth-Jones  
 Karen & Paul Karolik  
 Judith & Michael Kane  
 Eric Karpman & Mike Sell  
 Richard & Jessie Kesterman  
 Ron Kestner  
 Sheila Kohn  
 Joyann Koyes  
 J. Russell King  
 Seth Korman  
 Dr. & Mrs. Joseph Kalka  
 Harry Lang  
 Harry Lange

Louis Lantz  
 James Lapine  
 Thomas La Poppet  
 Jill Larson  
 Carol LaVale  
 Mr. & Mrs. Jesse Lehman  
 Joshua Lehman  
 Heather M. Lester  
 Jonathan & Stephanie Lee  
 Georgette & Martin J. Levy  
 Rolo Levy  
 Mr. & Mrs. William G. Levy  
 Eban Lewis  
 Mark Linn-Baker  
 Derek Livingston  
 Marjorie Logan  
 Julia Loni & Lee Kalchman  
 Greg Lucas  
 Kimo Martha  
 Elizabeth Malone  
 Donald Margulies & Lynn Street  
 Constance Marks  
 Robert Marston  
 Carmen Matthews  
 Harriet Matichuk  
 Edith S. Matthews  
 George J. Mathrasias  
 Alan D. Mayer  
 Andrew McKeon  
 Mr. & Mrs. Michelle  
 Rebecca Miller  
 Andy Miller  
 Sally Campbell & Tom Nara  
 Jane R. B. Muddyman  
 Susan Marakovich  
 Michael Murphy & Larry Nathanson  
 Kate Madigan & Robert Euse  
 Randy & Rana Nelson  
 Ruth Nelson  
 Eban Novack  
 Janice Novack  
 Peter & Margaret O'Brien  
 Bryan O'Rourke  
 Tavis O'Rourke & Edith Thurber  
 Carol Ochs  
 Jacki Ochs & Jan Krause  
 Kazuo Ochi  
 Mr. & Mrs. Joanne Onal  
 Eric Oweymer  
 Randy Papp  
 F. Richard Pappas  
 Steven E. Pater  
 David J. Penick & Nancy Jacobs  
 Mr. & Mrs. Alan E. Peters  
 Thomas P. Peters  
 Robert & Susan Phillips  
 Oliver Platt & Camille Campbell  
 Lawrence Polachuk  
 Martin T. Puri  
 Christopher Randolph  
 Helen & Peter Randolph  
 Eric Rappaport & Mike Sell  
 Richard & Jessie Kesterman  
 Ron Kestner  
 Sheila Kohn  
 Joyann Koyes  
 J. Russell King  
 Seth Korman  
 Dr. & Mrs. Joseph Kalka  
 Harry Lang  
 Harry Lange

Daryl Roth  
 Donald J. Rothschild & Lillian Shivers  
 Sally & Joseph Russo  
 Martha Sailer & Alan Smith  
 Arnold & Agnes Sametz  
 Jane M. Sangerman & Joseph  
 Vachopoulou  
 Dr. Zborah Scheibel  
 Dan Schneider  
 Milton Seinfeld  
 Campbell Scott  
 Sweet Scott  
 Dana Seigel  
 Mitchell Serval & Colleen Carroll  
 Barry Shapiro  
 Joann Shapiro  
 Mr. & Mrs. George Shaskan  
 Bernice Shush Shew  
 Ann & Bill Shaffer  
 Simone Shelton  
 Brian Sherrill & Perry Dryden  
 Jerome & Ruth Siegel  
 Lemo Simpson  
 Amy E. Singer  
 Barry Singer & Janice Ferris  
 Mark Singer & Darcy Dunn  
 Miles A. Slater  
 Lois Smith  
 Adam Spolka  
 Ted Stoney  
 John Steiner & Robert Sheffer  
 Robert Stecker  
 Robert Stein  
 Sue Steiner & Len Boothwright  
 Byron Stevens & Robin Tegelman  
 Catherine Strumb  
 Andrew Swine & Elise Taylor  
 Daniel Swine  
 In memory of Helen J. Swift  
 Jay Tatar  
 Mary Lou Teal & Peter Frensdlich  
 Butterfield Thompson  
 John & Joan Vial Thorne  
 Gina Torres  
 Yves & Rachel Toure  
 Adriane Ungioni & Tom Stephenson  
 Catherine Turner  
 Anne Twomey & John Bedford Lloyd  
 Pamela Tyson  
 Laura Valerosa  
 Suzanne Vega  
 Mark Vetter  
 Peter Austin Vlachos  
 Mary Pat Walsh  
 Wendy Wasserman  
 Samuel H. Weiser  
 Lawrence & Wendy Weiss  
 Sally Weiss  
 Robert & Andrea Weiner  
 Alex & Barbara Will  
 Susan Williamson  
 Jeff Williams  
 John & Pamela Wineapple  
 Larance J. Wine  
 Joanne Woodward  
 James Woolen & Marc Cherry  
 Mr. & Mrs. Joe Yaccarino  
 Jeff & Janine Yoss  
 Phyllis Zimmerman

## The 52nd Street Project presents

# DOUBLE OR NOTHING: THE RISKY PLAYS

## The 1995 One-on-One Plays

Ensemble Studio Theatre  
 July 13th Through July 16th 1995

In addition, The 52nd Street Project is truly grateful to the many individuals who have made gifts of less than \$100. EXPECT THE UNEXPECTED is also made possible in part with public funds from the National Endowment for the Arts, New York State Council on the Arts, The Department of Youth Services and the NYC Department of Cultural Affairs.

The 52nd Street Project Presents  
The 1995 One-on-Ones

**DOUBLE OR NOTHING: THE RISKY PLAYS**

The Pennsylvania Plays

July 13, 14, 15, 16, 1995

The Ensemble Studio Theatre - New York City

**Project Staff**

Willie Reale, Artistic Director  
Carol Ochs, Executive Director  
Michael Bernard, Associate Artistic Director  
Jenny Gersten, Director of Marketing & Development  
Eris Migliorini, Production Manager  
Susan Vitucci, Development Consultant  
Iris A. Brown, Staff Graphic Designer  
Glen Brackenridge, Intern  
Diana & Victor Rojas, Counselors

**Production Staff**

Henry Krieger, Composer & Music Director  
Kevin Joseph Roach, Set Designer  
Greg MacPherson, Lighting Designer  
Crystal Thompson, Costume Designer  
Joshua Lehrer, Stage Manager  
Mike Sell, Slide Design  
Kim Chandler, Props Design  
Colorforms Design:  
Kelly Copper, Pavol Liska  
Joe Kentner, Sound Design  
Rod Alonzo, Slide Operator  
Chris Bartlett, Slide Photographer  
Scott Ramsey, Raymond Harold, Glen  
Brackenridg,  
Furniture Crew  
Debbon Ayer & Diana Rojas,  
Colorforms Crew

Jilly Crook & Victor Rojas,  
Props Crew  
Light Hang & Set Crew,  
Rod Alonzo, Katie Atcheson, Lisa  
Benavides, Glen Brackenridge, Leon  
Addison Brown, Wendy vanden  
Heuvel, Karen Kandel, Gus Rogerson,  
Victor Rojas, Tom Schall, Carlo Trigiani

House Manager, Karin Barry Schall  
House Crew: Katie Atcheson, Beth  
Emelson, Elizabeth Keiser, Mary Pat  
Walsh

Eric Karpeles, Risky Play Meals

The 52nd Street Project is a nonprofit organization that brings inner-city children from the Clinton neighborhood together with professional theater artists to create theater. DOUBLE OR NOTHING: THE RISKY PLAYS is a production of our One-on-One program, which is designed to give children the opportunity to go away for one week stays in the country and enjoy the undivided attention of a professional theater artist who serves as friend, mentor and role model.

**Board of Directors**

Ben Barenholtz	Rachel Chanoff
Wendy Ettinger, Chair	Louis P. Friedman
Stephen Graham	Larry Jones
Heidi Landesman	James McDaniel
Frances McDormand	Patricia M. Murphy
Carol Ochs	Willie Reale
Pamala Tyson	Laura Valeroso

**Special Thanks To:**

Curt, Abigail, and Ensemble Studio Theatre; The host families: Barbara & Ted Cain, Bill, Linda, Sean & Kelly Cobb, Chuck, Andrea, Melanie & Emma Heyn, Deborah & David Pursch, Corky & Jeanie Rutledge; our regular families; Joan Henry, Sohail Raikhy, Martha Sader, Sally & Lenny Weiss; David Sneddon and Fairway Market; Kip Thompson & Alex Finlayson; Larry Wolhandler, Donna & Leslie and Painter's Tavern; Rita Levy; Mark Koeppen and Wendy Townsend; Naomi Dickerson, Gary Rickard; Bori Rauchman; The Atlantic Theater Company; Michael O'Gara; Howard Solomon, and most importantly and lovingly we thank Hildy, Walter, Knightley, Mike and Eric.

**In-Kind Contributions:**

Adobe, Inc.; Ensemble Studio Theatre; Neil A. Mazzella & Hudson Scenic Studios, Inc.; Fairway Market; Colorforms; Baron & Baron; Shays & Murphy; Iris A. Brown & Bernhardt/Fudyma Design Group; Joel Coen/Hudsucker Productions; Emily Grishman; New Dramatists; New York Theatre Workshop; Playwrights Horizons; Eric Karpeles & Mike Sell; Stephen Graham; Steve Olsen & The West Bank Cafe; Andy Millon; Lincoln Center Theater; Materials for the Arts; Tom Reale; Patty Dryden & Brian Siberell; John A. Vassilaros & Son; Citibank, N.A.; Kiehl's; Joseph E. Seagrams & Sons; Scholastic Productions.

# DOUBLE OR NOTHING: THE RISKY PLAYS

## ACT 1

### **The Great Googely Moogely**

Written and directed by Michael Bernard, for Tony Santiago, age 11

The Great Googely Moogely	Tony Santiago
Some Guy	Don Berman
Pete	Michael Bernard
The GM's	Michael Bernard, Glen Brackenridge, Victor Rojas

"Get Up (I Feel Like Being a Googely Moogely) Pt. 1" and "The Guru Song" Lyrics by Michael Bernard

### **A Couple of Cards**

Written and directed by Jacquelyn Reingold, for Chris Hansen, age 11

The Joker	Alex Draper
The One-Eyed Jack	Chris Hansen

"Inside Us Is a Wild Card" Lyrics by Jacquelyn Reingold

### **The Petunia Sisters Bloom**

Written and directed by Juliette Carrillo, for Marsci Mysak, age 9

Paisley Petunia	Marsci Mysak
Penelope Petunia	Juliette Carrillo
Voices:	Glen Brackenridge, Henry Krieger, Donald Berman

"Broadway or Bust" and "Double Trouble" Lyrics by Willie Reale

### **Venus in Retrograde**

Written and directed by Susan J. Vitucci, for Deshana Hamid, age 11

Maxi	Deshana Hamid
Venetia	Susan J. Vitucci
Venus Rising	Wendy vanden Heuvel, Eris Migliorini, Melissa Murray, Diana Rojas

"Venus in Retrograde" and "Sometimes" Lyrics by Susan J. Vitucci

### **The Second To The Last Stop**

Written and directed by Willie Reale, for Thomas Santoni, age 10

Amos	Thomas Santoni
Clem	Gus Rogerson

"The Second To The Last Stop Funeral Home," "Three Fives and Two Twos" and "The Better and Peaceful Unknown" Lyrics by Willie Reale

## ACT II

### Royal Flush

Written by Tim Blake Nelson, for Raymond Ocasio, age 13  
Directed by Lisa Benavides

Marcus Comodius Latrinus	Raymond Ocasio
Bombastica Longwindia	Lisa Benavides
Roman Guard	Eris Migliorini

"I'm Marcus Comodius Latrinus" and "At Least We've Met Each Other" Lyrics by Tim Blake Nelson

### The Ballad of Johnny Wrangler

Written and directed by Karen Kandel, for Eric Hooper, age 11

Johnny Wrangler	Eric Hooper
Mom/Pete	Karen Kandel

The Balladeers: Don Berman, Jerry McGill, Gus Rogerson, Willie Reale  
"The Ballad" and "One Move At A Time" Lyrics by Willie Reale, "Johnny's Lament"  
Lyrics by Karen Kandel

### Chefs: The Musical

Written and directed by Jerry McGill, for Ahmed Attia, age 9

Am	Ahmed Attia
Jake	Jerry McGill
Donna	Eris Migliorini

"Let's Mix" and "Come With Me" Lyrics by Jerry McGill

### Another West Side Story

Written and directed by Bill Wrubel, for Zsuzsa Mysak, age 12

Phyllis	Melissa Murray
Francine	Zsuzsa Mysak

"The Torment of Phyllis" and "Suburban Girl" Lyrics by Bill Wrubel

### The Stuff That Dreams Are Made Of

Written by Chris Ceraso, for Janice Santiago, age 11  
Directed by Wendy vanden Heuvel

Winged Serpent	Janice Santiago
Noah's Wife	Wendy vanden Heuvel
Animals	Diana Rojas, Victor Rojas

"Storybooks & Nursery Rhymes" and "The Water's Getting Higher" Lyrics by Chris Ceraso.

All music by Henry Krieger

Thank you for coming to DO JBLE OR NOTHING. If you are not on our mailing list (or if your address has changed), please fill out this form and give it to us on your way out or mail it to the address below. We would also like to know if you are interested in becoming a volunteer. We are always in need of help in all areas, so, please fill out your name, address and phone number.

### PLEASE ADD ME TO YOUR MAILING LIST:

NAME \_\_\_\_\_

ADDRESS \_\_\_\_\_

\_\_\_\_\_ Zip \_\_\_\_\_

PHONE \_\_\_\_\_

### YES, I WOULD LIKE TO BE OF HELP:

NAME \_\_\_\_\_

DAYTIME PHONE \_\_\_\_\_

**I AM REALLY USEFUL AT** (52nd Street Project related things only, i.e. mailings, backstage help, fundraising, etc.) \_\_\_\_\_

### ON SALE IN THE LOBBY

52nd Street Project T-Shirts with Shel Silverstein Logo: \$12.00

The Fabulous Flyer Bar	\$1.50/\$1.00 for kids
The New Flyer Gold	\$2.00

Remember, one-half of sale price is tax-deductible!

If you would like to mail this (and you're always welcome to enclose a tax-deductible contribution), you can send it to:

The 52nd Street Project  
220 West 42nd Street, 18th Floor  
New York, NY 10036-7211  
(212) 764-1379

The 52nd Street Project gratefully acknowledges the support of the following foundations and corporations: The Altman Foundation, The American Red Cross Overseas Association, Armstrong Hirsch Jozefowicz Tyerman & Weinbaum, Baker Wilfong Foundation, Chase Manhattan Bank, Consolidated Edison, Barbara Bell Cunningham Foundation, Nathan Cummings Foundation, The Darreman Fund, The Dramatists Guild Fund, Educational Foundation of America, Salvatore Fawcetta, The William and Mary Grove Foundation, The Harriessy Foundation, The Holland Lodge Foundation, KAM, The Rita J. and Stanley H. Kaplan Foundation, The Benita Kane Foundation, Kohl's, Lloyds Bank, The James MacFarland Foundation, The Jan M. Martin Foundation, JP Morgan, Morgan Stanley and Company, The William Morris Agency, The New World Foundation, The New York Times Company Foundation, The Purlin Foundation, RJM Group, The Fan Fan and Leslie R. Samuels Foundation, Shays & Murphy, The Sulzberger Foundation, Harold & Mimi Steinberg Charitable Trust, The Threshold Foundation, Travelers Fund, Variety, John A. Vassilatos & Sons, Inc., Wochol, Lipson, Rosen & Katz, The Lia Achson Wallace Theatre Fund, The West Bank Cafe, Valerie Wilson Travel, Yorka Construction, as well as matching gifts from AT&T, Bankers Trust, Alex & Brown & Sons, CBS Foundation, the Rockefeller Group, and The New York Times Company Foundation, Pfizer. In addition, the following individuals made gifts to The 52nd Street Project this year:

Karen Adels & Ted Brady  
Gabriel Aella  
Alexis J. Alexanian  
Man Bush Anderson  
Amy Merrill Antara  
William J. Apuzzo  
Alan Arlos & Kay Mutschaller  
Emanuel Azenberg  
Alex Balaban & Kim Bussinger  
Jane Ballinger & Michael Goldstein  
Frances S. Balke  
Mr. & Mrs. Lawrence Bangsar  
Ben Barenholtz  
Karen Barry & Thomas Schall  
Angela Bassett  
Jessica Bauman  
Catherine Beckman  
Laurie Beachman & Neil A. Mazzella  
Lisa Benavides & Timothy Nelson  
Pamela S. Barkin & William Cardan  
Jane Ira Bloom & Joe Gefani  
Alyna & Barry Benzad  
Mr. & Mrs. H. Gerald Bissinger  
Susan & Ron Block  
Richard Blockstone  
R.O. Blochman  
Robert & Alison Blonk  
Audrey Bloch  
Judy Burns & George Cooper  
Steven Bochco  
Catherine Borowitz & John Turkano  
Cristina Botta Singletan  
Blaise Box  
Michael Brennan  
Bartha & Samuel Bitt  
Eric Brooks  
Iris & Fred Brooks  
Becky Browder & Ted Neustadt  
Deborah Brown  
Iris A. Brown & Joe White  
Susan Bruce & Peter Hodges  
Debrae Bursac & Peter Joy Fernandez  
Kate Burton & Michael Kinzie  
Steven Callahan & Christine Dunn  
Rachel Chanoff  
Dawnraut Chantillon & Gerard Harper  
Ellen Chonoweth  
Marissa Chibas & Tomis Preston  
William Christian  
Dr. Susan Coates  
Jed Coan & Fran McDonnand  
Alice & Barry Cohen  
Ruth Cohen  
Richard J. Cole  
Arthur Collins & Stephanie Barber  
Penelope A. Collins  
Elise & Francis Coppola  
Thomas Cotti  
Eileen Cowell & David Sennett  
Margaret Crammins & Pierce Rafferty  
Joan Straus Cullman  
Arthur Dantchik  
Frances & Howard Davis  
Mr. & Mrs. Peter Dawkins  
Mr. & Mrs. DiRogosa  
Stephan J. Dubner  
Josephine & Charles Dumas  
Jack & Jane Dunbar  
Neil Essenberg

Shawn Eliot  
Caroline & John Ellis  
Gwen Ellison  
Israel A. Englander  
Beth A. Emanuel  
Wendy Ettlinger & Derek McLane  
Martha Evans & Pw Leving  
Randy Finch  
Kirstine Fleisher & David Sweddon  
Amy Flood  
David Frankel  
Richard Frankel  
Kermit Frisau  
Lois Fricke & David Hollander  
Amy Friedman  
Louis & Patricia Friedman  
Janice Fudyman & Craig Bernhardt  
Charles Fuller  
Judith Garson & Steven Rappaport  
Rose Gassner & Larry Chertoff  
Alexandra Gerten & John Vassilatos  
Bernard Gerten & Cara Cohen  
Alan Gertson  
Sarafox & Marion Goldstein  
John Gould Rubin  
Stephen & Cathy Graham  
Frances & Colin Greer  
Janet L. Grillo & David Russell  
Emily Grishman & Susan Sampelman  
Lisa J. Guyanham  
A.R. Gurney  
Thomas Harlicks  
Linda & William Halvorsen  
Emma & Stephen Hamilton  
John Hart  
Eugenie Denise Harvey  
Paul E. Hejirjian & Charlotte Elberston  
Mr. & Mrs. Harry B. Hershel  
David Herdich & Elizabeth Palmer  
Peter Herdich & Karen Iratt  
William J. Hirschler  
Jane Hoffman  
John Hoffman  
Willy Holtzman & Sylvia Shepard  
Irwin Horowitz  
Catherine Howard  
Bernard Hughes & Helen Sternberg  
Mr. & Mrs. David Harry Hwang  
Bill Irwin & Martha Roth  
Mark Evan Jacobs  
André Jauckle  
Linda Levy Janklow  
George Jonasson  
Andrea Johnson  
Larry & Mary McStrath-Jones  
Ruth Jones  
Doris S. Judell  
Hattie & Rajendra Jungai  
Jane Kaczmarek & Bradley Whitford  
Mr. & Mrs. Max Kahn  
Robin Amos Kahn  
Maurice Kanbar  
Karen & Paul Kandel  
Judith & Michael Kane  
Eric Kapelles & Mike Sell  
Ryn Kasher  
Sheda Kehoe  
J. Russell King  
Woodie King, Jr.

Beth & Seth Korman  
Dr. & Mrs. Joseph Kofler  
Mary Kong  
Mike Koval  
Harry Kruger  
Judy Kuhn & David Schwab  
Fran Kuman  
Hadi Landesman  
Thomas La Pappet  
Jill Larson  
Mr. & Mrs. Jesse Lehman  
Heather M. Lester  
Georgette & Morton J. Levy  
Rita Levy  
Mr. & Mrs. William G. Levy  
Carol & Jonathan Linbar  
Jacqueline Little  
Mimi Livingston  
Magorie Logan  
John Lord & Lee Kalkchwin  
John S. Lyons  
Kim Lyons  
Greg MacPherson  
Donald Margulies & Lynn Street  
Ricki S. Matthews  
George J. Mavronikolas  
Max D. Mayr  
McGinnis McCoy  
Barbara McGuire & Paul Reale  
Hannelore & James McDaniel  
Andrew McKeon  
Audrey & Denny Meyer  
Drew Milstein  
Jane & Bill Muddyman  
Kate Nelligan & Robert Reale  
Randy & Erika Nelson  
Barb Nelson  
Helen & James Neuberger  
Ellen Novack  
Peter & Margaret O'Brien  
Kevin O'Rourke & Edith Thurber  
Carol Ochs  
Jacki Ochs & Jan Kweze  
Paul Onderdonk  
F. Richard Pappas  
Steven E. Peine  
David J. Peterkin & Nancy Jacobs  
Mr. & Mrs. Alton E. Peters  
Thomas P. Peters  
Ethan J. Phillips  
Robert & Susan Phillips  
Oliver Platt & Camille Campbell  
Martha Plimpton  
Richard Polachuk  
Christopher Randolph  
Helen & Peter Randolph  
Donna Racant  
Jacquelyn Ringgold  
Ivo & Kim Rifkin  
Robin Amos Kahn  
Theodore Robertson  
Marna Rosa  
Rabyn & David Rosenberg  
Richard J. Rubenstein  
Martha Sader & Alan Smith  
Jane M. Songerman & Joseph  
Vodopala  
Dr. Zborosh School

Mr. & Mrs. Walter Steiner  
Don Schneider  
Milton Schofield  
Campbell Scott  
Sweet Scott  
Dana Segal  
Mitchell Samuel & Colleen Carroll  
Barry Shapiro  
James Lapine  
Bernice Baruch Showel  
Lillian Shivers & Donald J. Rothchild  
Barry Singer & Janine Fivrat  
Mark Singer & Darcy Dunn  
Lutz Smith  
Adam Spilka  
John Steiner & Robert Shaffran  
Robert Stecker  
James Sterling  
James Stovall  
Catherine Struttas  
Linda Swartz  
Daniel Swine  
In memory of Harlan J. Swift  
Mr. & Mrs. Martin Tardak  
Jay Taras  
Lil Taylor & Michael Imperial  
Mary Lisa Teal & Peter Frandlich  
Rutherford Thompson  
John & Joan Val Thoma  
Gina Jones  
Yves & Rochel Touma  
Adriana Tiggiani & Tim Stephenson  
Kathleen Turner  
Anne Twammy & John Bedford Lloyd  
Judith Tygard & Mitch Weitzner  
Laurie Ungard  
Laura Valerona  
Joan & Paul Van Der Gift  
Alexander Vassilatos  
Elizabeth Valquez & Alexander  
Bernstein  
Mark Victor  
Susan J. Vinod  
Stewart von Oelsen  
Thomas von Oelsen  
Robin Wagner  
Mary Pat Walsh  
Dr. & Mrs. Borah Walton  
Wendy Wasserstein  
Sam Waterstein  
Charles C. Watkins, III  
Becca Weber  
John Weisman  
Robert & Andrea Weiner  
Sally Weiss  
Ira Wetzman  
Marc Werner  
John Wesler  
Max & Barbara Wilk  
Susan Wilerman  
Elizabeth Wilkoma  
Edward Wiseman  
Taraanca J. Witna  
Bill F. Wrubel  
Jeff & Janine Yass  
Lisa Zeff & Ed Fields

as of 8/9/95.

The 52nd Street Project is also truly grateful to the many individuals who have makes gifts of less than \$100.

The 52nd Street Project presents

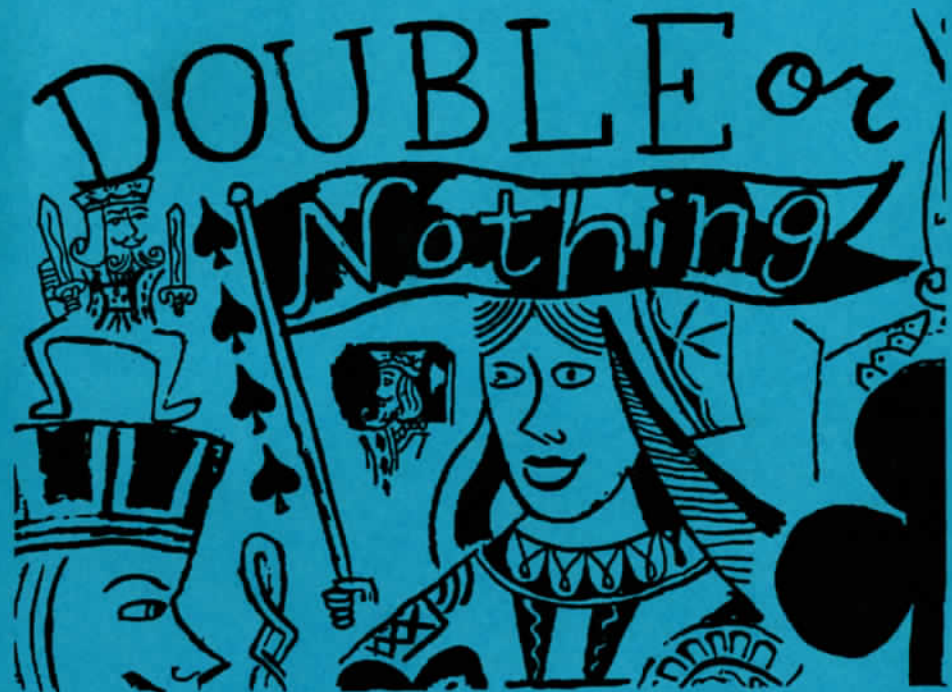

Illustration/design by Josh Gosfield

# The Risky Plays from Block Island

The 1995 Harold & Mimi Steinberg Charitable Trust  
One-on-One Plays  
Ensemble Studio Theatre, New York City  
August 10, 11, 12 at 7:30 p.m.  
August 13 at 3:00 and 7:30 p.m.

The 52nd Street Project Presents  
The Harold and Mimi Steinberg Charitable Trust  
1995 One-on-Ones

**DOUBLE OR NOTHING**

The Risky Plays From Block Island

August 10, 11, 12, 13 1995  
The Ensemble Studio Theatre - New York City

**Project Staff**

Willie Reale, Artistic Director  
Carol Ochs, Executive Director  
Michael Bernard, Associate Artistic Director  
Jenny Gersten, Director of Marketing & Development  
Eris Migliorini, Production Manager  
Susan Vitucci, Development Consultant  
Iris A. Brown, Staff Graphic Designer  
Kulondi Frier, Administrative Assistant  
Glen Brackenridge and Maura Griffin, Interns  
Alexis Frye and Claudia Ramponi, Counselors

**Production Staff**

Rusty Magee, Composer & Music Director  
Kevin Joseph Roach, Set Designer  
Greg MacPherson, Lighting Designer  
Elizabeth Clancy, Costume Designer  
Sheila Kehoe, Assistant Costume Designer  
Katherine Lumb, Stage Manager  
Slide Design:  
Renato Castillo, Erick Kuo, John Steward  
Props Design:  
Kim Chandler, Jilly Crook, Scott Ramsay  
Colorforms Design:  
Evan Bernard, Michele Mayas  
Keith Benjamin, Sound Design  
Rod Alonzo, Slide Operator  
Gregor Halenda, Slide Photographer

Furniture Crew:  
Tom Carrozza & Raymond Harold  
Colorforms Crew:  
Maura Griffin & Diana Rojas  
Props Crew:  
Jilly Crook & Victor Rojas  
Light Hang & Set Crew:  
Rod Alonzo, Michael Bernard,  
Katherine Lumb, Greg MacPherson,  
Bruce MacVittie, Eris and David  
Migliorini  
House Manager, Amanda Jacobs  
House Crew:  
Katie Acheson, Lisa Benavides, Beth  
Emelson, Elizabeth Keiser, Trisha Roach

The One-on-Ones program is also made possible, in part, with public funds from the New York State Council on the Arts, the Department of Youth Services, and the New York City Department of Cultural Affairs.

The 52nd Street Project is a non-profit organization that brings inner-city children from the Clinton neighborhood together with professional theater artists to create theater. DOUBLE OR NOTHING: THE RISKY PLAYS is a production of our One-on-One program, which is designed to give children the opportunity to go away for one week stays in the country and enjoy the undivided attention of a professional theater artist who serves as friend, mentor and role model.

**Board of Directors**

Ben Barenholtz	Rachel Chanoff
Wendy Ettinger, Chair	Louis P. Friedman
Stephen Graham	Larry Jones
Heidi Landesman	James McDaniel
Frances McDormand	Patricia M. Murphy
Carol Ochs	Willie Reale
Pamala Tyson	Laura Valeroso

**Special Thanks To:**

Curt, Abigail, and Ensemble Studio Theatre; Dr. Cristina Biaggi, Pat, Aidan and Noah Walsh; Virginia Dare and Joya Verde; Rita and Steve Draper; Martha Gass and Pat McQuade (for cooking and hosting!); Jennifer and Elliot Taubman; Judy and Ron Tierney; Lyn and Bob Reale; Mike, Ruth and Caroline at Block Island Realty; Ann Hall; Rachel; Interstate Navigation; McQuade's Market; Hunter Tracy; Bill Bendokas at New England Airlines; Liz and Phil at Winfield's; Prudy and the Ice Cream Place; Jimmy Reale; CSC: Gregor Halenda; Lynn and Mark Amft; and Nathaniel Magee.

**In-Kind Contributions:**

Adobe, Inc.; Ensemble Studio Theatre; Neil A. Mazzella & Hudson Scenic Studios, Inc.; David Sneddon and Fairway Market; Colorforms; Baron & Baron; Shays & Murphy; Iris A. Brown & Bernhardt/Fudyma Design Group; Emily Grishman; New Dramatists; New York Theatre Workshop; Playwrights Horizons; Eric Karpeles & Mike Sell; Dr. Cristina Biaggi; Stephen Graham; Steve Olsen & The West Bank Cafe; Andy Millon; Lincoln Center Theater; Materials for the Arts; Tom Reale; Port Authority; Mayor's Office of Film & Television; Patty Dryden & Brian Siberell, John A. Vassilaros & Son; Citibank, N.A.; Kiehl's; Joseph E. Seagrams & Sons; Scholastic Productions.

## DOUBLE OR NOTHING: THE RISKY PLAYS

### **The Double or Nothing Theme Song - Company**

lyrics by Willie Reale

#### **Fire**

Written and directed by Lili Taylor, for Kevin Hartwick, age 9

Geezmo . . . . . Kevin Hartwick  
Chief Sam . . . . . Lili Taylor  
Lucy . . . . . Lili Taylor  
"I Hate My Own Guts" and "An Infernal Duet" lyrics by Willie Reale

#### **Mulch Action**

Written by Susan Kim, for Ashley Dominique, age 9

Directed by Dion Graham

Mulch Action . . . . . Ashley Dominique  
D.J. "Hardboiled" Hennessey . . . . . Dion Graham  
"Hard Boiled Hennessey's Sensitivity Clinic" lyrics by Willie Reale

#### **The Might of the Iguana**

Written and directed by Nancy Giles, for Judy Agosto, age 11

Iggy . . . . . Judy Agosto  
Lizzie . . . . . Nancy Giles  
Voice of Lizzie's Mom . . . . . Moira Driscoll  
"The Reptilian National Anthem" lyrics by Willie Reale

#### **The Adventures of Super Hero Person**

Written and directed by Michael Bernard, for David Harold, age 13

Super Hero Person . . . . . David Harold  
Evil Really Not Very Nice Guy . . . . . Michael Bernard  
Super Powers . . . . . Michael Bernard  
"Stupid Hero" and "I Think We'll Be Alright" lyrics by Michael Bernard

#### **Claol**

Written and directed by Lewis Black, for Sahara Walsh, age 11

Also directed by Martha Plimpton

Wanda The Weasel . . . . . Martha Plimpton  
Serena The Swan . . . . . Sahara Walsh  
"Little Ole Original Me" lyrics by Willie Reale

## INTERMISSION



## ACT II

### Reptile Logic

Written and directed by Robert Shaffron, for Jean Pierre Bernard Barthelemy, age 11

Wally ..... John Steber  
Rodney ..... John Pierre Bernard Barthelemy  
The Vicious Dentor ..... John Steber  
"Another 'Gator" lyrics by Robert Shaffron

### Double Trouble

Written and directed by Bruce MacVittie, for Frank Hansen, age 11

Lance Trouble ..... Frank Hansen  
Chance Bumble ..... Bruce MacVittie  
Director ..... Willie Reale  
Lance Trouble Chorus . . . . Michael Bernard, Glen Brackenridge, Nancy Giles,  
Dion Graham, Maura Griffin, Martha Plimpton, Robert Shaffron, John Steber  
Daphne ..... Eris Migliorini  
"Lance's Theme Song" "The Chance/Lance Lament" and "Lonely at the Top" lyrics by  
Bruce MacVittie

### A Swamp Romp

Written and directed by Moira Driscoll, for Jonsi Smith, age 11.5

Miss Ida Lureen ..... Jonsi Smith  
Dr. Jane Fletcher ..... Moira Driscoll  
Paramedic Mick ..... Dion Graham  
Paramedic Earl ..... Glen Brackenridge  
Wally Gator ..... Rusty Magee  
"Okee Dokee Karaoke" lyrics by Willie Reale

### How Long We Know Each Other?

Written and directed by Willie Reale, for Yull Neri Borda, age 13

Charlie ..... Yull Neri Borda  
Pete ..... Larry Nathanson  
Waitress ..... Michaela Murphy  
"A Little About Priscilla" lyrics by Willie Reale

### Night in Shining

Written and directed by Michaela Murphy, for Charina Corbett, age 8

Night ..... Michaela Murphy  
Day ..... Charina Corbett  
"Rise and Shine" lyrics by Michaela Murphy, music by Michaela Murphy and Rusty  
Magee; "All the Difference in the World" lyrics by Willie Reale

Thank you for coming to DOUBLE OR NOTHING. If you are not on our mailing list (or if your address has changed), please fill out this form and give it to us on your way out or mail it to the address below. We would also like to know if you are interested in becoming a volunteer. We are always in need of help in all areas, so, please fill out your name, address and phone number.

### PLEASE ADD ME TO YOUR MAILING LIST:

NAME \_\_\_\_\_

ADDRESS \_\_\_\_\_

\_\_\_\_\_ ZIP \_\_\_\_\_

PHONE \_\_\_\_\_

### YES, I WOULD LIKE TO BE OF HELP:

NAME \_\_\_\_\_

DAYTIME PHONE \_\_\_\_\_

**I AM REALLY USEFUL AT** (52nd Street Project related things only, i.e. mailings, backstage help, fundraising, moving heavy items, etc.) \_\_\_\_\_

### ON SALE IN THE LOBBY

52nd Street Project T-Shirts with Shel Silverstein Logo: \$12.00

The Fabulous Flyer Bar \$1.50/\$1.00 for kids

52nd Street Books:

Collections of One-on-One Plays from years past:

The Butler Did It! (\$30), The Bedtime Zone (\$20)(with music by Henry Krieger)

Or pick up 52 Pick Up: A Practical Guide to Doing Theater With Children, a "how to" guide written by Willie Reale with a Playmaking course by Daniel Judah Sklar. \$35

Remember, one-half of sale price is tax-deductible!

If you would like to mail this (and you're always welcome to enclose a tax-deductible contribution), you can send it to:

The 52nd Street Project • 220 W. 42nd Street, 18<sup>th</sup> Floor New York, NY 10036-7211 • (212) 764-1379

The 52nd Street Project gratefully acknowledges the support of the following foundations and corporations: The Altman Foundation, The American Red Cross Overseas Association, Aronson Hirsch Jackoway Tyman & Weintraub, Barker Welfare Foundation, Chase Manhattan Bank, Consolidated Edison, Barbara Bell Cumming Foundation, Nathan Cummings Foundation, The Dammann Fund, The Dramatists Guild Fund, Educational Foundation of America, Salvatore Ferragamo, The Harace W. Goldsmith Foundation, The William and Mary Gewe Foundation, The Haraway Foundation, The Hobart Lodge Foundation, ICM, The Rita J. and Stanley H. Kaplan Foundation, The Benita Kan Foundation, Kieh's, Lloyds Bank, The James Macdonald Foundation, The Ann M. Martin Foundation, JP Morgan, Morgan Stanley and Company, The William Morris Agency, The New World Foundation, The New York Times Company Foundation, The Pumpkin Foundation, RHM Group, The Fan Fan and Leslie R. Sarunas Foundation, Shays & Murphy, The Selzberger Foundation, Harold & Miri Steinberg Charitable Trust, The Threshold Foundation, Towlers Fund, Vanity, John A. Vaccaro & Sons, Inc., Wachtel, Lipton, Rosen & Katz, The Lia Acheson Wallace Theatre Fund, The West Bank Cafe, Valerie Wilson Travel, Yorka Construction, as well as matching gifts from AT&T, Bankers Trust, Max & Brown & Sons, CBS Foundation, The Rockefeller Group, and The New York Times Company Foundation, Please. In addition, the following individuals made gifts to The 52nd Street Project this year:

Karen Aldala & Ted Brady  
Gabriel Avila  
Alexis J. Alexanian  
Nan Bush Anderson  
Amy Merrill Aronson  
William J. Apuzzo  
Alan Arfa & Kay Matschallat  
Emanuel Azarberg  
Alec Baldwin & Kim Basinger  
June Bollinger & Michael Goldstein  
Frances S. Bolter  
Mr. & Mrs. Lawrence Bangsu  
Ben Borenholz  
Karin Barry & Thomas Schall  
Angela Bossert  
Jessica Bozman  
Catherine Beckman  
Laurie Beedman & Neil A. Mazzella  
Lisa Benavides & Timothy Nelson  
Pamela S. Berlin & William Carden  
Jane Ira Bloom & Joe Gelzso  
Myrna & Barry Bonard  
Mr. & Mrs. H. Gerald Bisinger  
Susan & Ron Block  
Richard Blockstone  
R.O. Blechman  
Robert & Allison Blinikan  
Audrey Bloch  
Judy Blume & George Cooper  
Steven Bochco  
Catherine Barowitz & John Turtura  
Cristina Botta Singleton  
Blaise Box  
Michael Brennan  
Bertha & Samuel Britt  
Eric Brooks  
Rita & Fred Brooks  
Becky Browder & Ted Haurstodt  
Deborah Brown  
Iris A. Brown & Joe White  
Susan Brucia & Peter Hodges  
Denise Burton & Peter Jay Fernandez  
Kate Burton & Michael Ritchie  
Steven Callahan & Christine Dunn  
Rachel Charoff  
Dawnarae Charleston & Gerard Harper  
Elhan Chansavath  
Maissa Chibes & Travis Preston  
William Christian  
Dr. Susan Coates  
Joel Coen & Fran McDermott  
Alice & Barry Cohen  
Ruth Cohen  
Richard J. Cohn  
Arthur Collins & Stephanie Barber  
Pamela A. Collins  
Elise & Francis Coppola  
Thomas Cott  
Ethan Cowell & David Sennett  
Margaret Crimmins & Pierce Rafferty  
Joan Straus Cullman  
Arthur Danitchik  
Frances & Howard Davis  
Mr. & Mrs. Peter Dawkins  
Mr. & Mrs. Diluguis  
Stephen J. Dobner  
Josephine & Charles Dumas  
Jack & Jane Dunbar  
Mad Eisenberg  
Shawn Elliot

Barbara Eliran  
Caroline & John Ellis  
Gwen Elston  
Israel A. Englander  
Beth A. Emelson  
Wendy Etinger & Derek McLane  
Martha Evans & Pat Laving  
Randy Finch  
Kristine Fleisher & David Sneddon  
Amy Flood  
David Frankal  
Richard Frankal  
Karril Frazier  
Luis Fricka & David Hollander  
Amy Friedman  
Louise & Patricia Friedman  
Janice Fudyma & Craig Bernhardt  
Charles Fuller  
Judith Garson & Steven Rappaport  
Rose Gasner & Larry Charloff  
Alexandra Gersten & John Vassilareas  
Bernard Gersten & Cara Cohen  
Miran Gersten  
Sarford & Marian Goldstein  
John Gould Rubin  
Stephen & Cathy Graham  
Frances & Colin Greer  
Janet L. Grillo & David Russell  
Emily Grishman & Susan Sampliner  
Lisa J. Gugenheim  
A.R. Gurney  
Thomas Halikias  
Linda & William Halvorson  
Emma & Stephen Hamilton  
Marcia Gay Harden  
John Hart  
Eugenia Daria Hervey  
Paul E. Heppner & Charlotte Eberston  
Mr. & Mrs. David Henry Hwang  
David Hardich & Elizabeth Palmer  
Peter Hardich & Karen Trott  
William J. Hirsch  
Jane Hoffman  
John Hoffman  
Willy Holtzman & Sylvia Shepard  
Irwin Horowitz  
Catherine Howard  
Bernard Hughes & Helen Stenberg  
Mr. & Mrs. David Henry Hwang  
Bill Irwin & Martha Roth  
Mark Evan Jacobs  
Andi Jaedde  
Linda Lavy Janklow  
George Johannsson  
Andrea Johnson  
Larry & Mary McElraith-Jones  
Ruth Jones  
Davis S. Judell  
Hattie & Rajendra Jutagir  
Jane Kaczmarek & Bradley Whitford  
Mr. & Mrs. Alan Kahn  
Robin Aron Kahn  
Maurice Kanbar  
Karen & Paul Kandel  
Judith & Michael Kane  
Eric Karpales & Mike Sell  
Ron Kastner  
Sheila Kahoe  
J. Russell King  
Woodie King, Jr.

Beth & Seth Korman  
Dr. & Mrs. Joseph Kalkar  
Gwen Elston  
Mike Koval  
Harry Krieger  
Judy Kahn & David Schwab  
Fran Kamin  
Heidi Landestman  
James Lapine  
Thomas La Pappet  
Jill Larson  
Mr. & Mrs. Jesse Lehman  
Heather M. Lester  
Georgette & Morton J. Levy  
Rita Levy  
Mr. & Mrs. William G. Levy  
Carol & Jonathan Lieber  
Jacqueline Little  
Mara Livingston  
Marjorie Loggia  
Julia Lord & Lee Kalchheim  
John S. Lyons  
Kim Lyson  
Marsue & Peter MacClinal  
Greg MacPherson  
Rusty Magee  
Donald Margulies & Lynn Street  
Rikki S. Matthews  
George J. Mavronicolas  
Max D. Mayer  
McGinnis McCoy  
Barbara McCraw & Paul Reale  
Hannelore & James McDaniel  
Andrew McKeon  
Aukry & Danny Meyer  
Drew Weinstein  
Jane & Bill Muddayman  
Kate Naligan & Robert Reale  
Randy & Rena Nelson  
Ruth Nelson  
Helen & James Neuburger  
Eliot Novack  
Peter & Margaret O'Brien  
Kevin O'Rourke & Edith Thorber  
Carol Ochs  
Jacki Ochs & Jan Krouze  
Paul Onderdonk  
F. Richard Pappas  
Steven E. Patel  
David J. Patinkin & Nancy Jacobs  
Mr. & Mrs. Alan E. Patras  
Thomas P. Patras  
Ethan J. Phillips  
Robert & Susan Phillips  
Oliver Platt & Camilla Campbell  
Martha Pierpton  
Richard Polachek  
Christopher Randolph  
Helen & Peter Randolph  
Willie Rade  
Dorena Record  
Jacquelyn Raingold  
Ive & Ron Rifkin  
Elizabeth Rigg  
Thyraost Robertson  
Manna Raso  
Robyn & David Rosenberg  
Richard J. Rubinstein  
Martha Sadler & Alan Smith  
Jane M. Sangerman & Joseph

Vodopoles  
Dr. Zeharah Schochet  
Mr. & Mrs. Walter Sherman  
Don Schneider  
Milton Schofield  
Campbell Scott  
Saret Scott  
Dana Seegal  
Mitchell Samuel & Colleen Carroll  
Barry Shapiro  
Mr. & Mrs. George Shekton  
Bernice Baruch Showl  
Lillian Shivers & Donald J. Rothchild  
Barry Singer & Jeanine Ferrati  
Mark Singer & Darcy Dunn  
Luis Smith  
Adam Spilka  
John Steber & Robert Shaffron  
Robert Stocker  
James Sterling  
James Stovall  
Catherine Strambos  
Linda Swartz  
Daniel Sweet  
In memory of Harlan J. Swift  
Mr. & Mrs. Martin Tandler  
Jay Taves  
Lil Taylor & Michael Imperiali  
Mary Lou Teal & Peter Froundlich  
Rutherford Thompson  
John & Joan Val Thoma  
Gina Torres  
Yves & Rachel Toure  
Adriana Trigiani & Tim Stephenson  
Kathleen Turner  
Anne Twamney & John Bedford Lloyd  
Judith Tygar & Mich Weitzman  
Leslie Uroozog  
Laura Valeruso  
Joan & Paul Van Der Giff  
Alexander Vasilescu  
Elizabeth Valquez & Alexander  
Bernstein  
Mark Victor  
Susan J. Vitucci  
Stewart von Oelsen  
Thomas von Oelsen  
Robin Wagner  
Mary Pat Walsh  
Dr. & Mrs. Borch Walton  
Wendy Wasserstein  
Sam Waterston  
Charles C. Watkins, III  
Bruce Weber  
John Weidman  
Robert & Andrea Weiner  
Sally Weiss  
Jo Wetzman  
Marc Werner  
John Wesley  
Max & Barbara Wilk  
Susan Wilkerman  
Elizabeth Williams  
Valerie Wilson  
Edward Wiseman  
Terrance J. Wittor  
Bill F. Winbel  
Jeff & Janine Yoss  
Lisa Zeff & Ed Fields

as of 11/2/95

# The 52nd Street Project presents

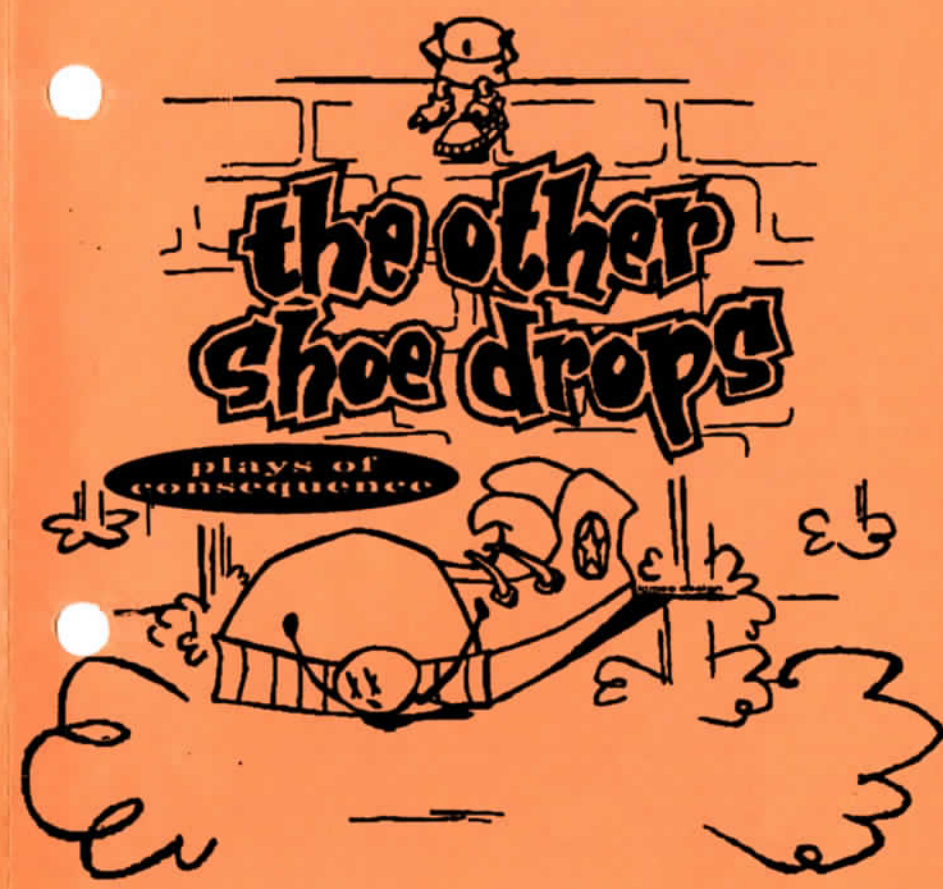

## Six new plays from The 52nd Street Project's Playback Program

Friday, November 3 at 7:30 pm  
Saturday, November 4 at 3:00 and 7:30 pm  
Sunday, November 5 at 3:00 pm

Playwrights Horizons Studio Theater, New York City

The 52nd Street Project Presents  
The 1995 Playback Plays

## The Other Shoe Drops

November 3, 4, 5, 1995

Playwrights Horizons Studio Theater - New York City

### Project Staff

Willie Reale, Artistic Director  
Carol Ochs, Executive Director  
Michael Bernard, Associate Artistic Director  
Jenny Gersten, Director of Marketing & Development  
Eris Migliorini, Production Manager  
Susan J. Vitucci, Development Consultant  
Iris A. Brown, Staff Graphic Designer  
Jessica Lissy, Intern

### Production Staff

Kevin Joseph Roach, Set Designer  
Greg MacPherson, Lighting Designer  
Laurent Junod, Assistant Lighting Designer  
Crystal Thompson, Costume Designer  
Jenny Gersten, Stage Manager  
Lisa Dove, Composer & Music Director  
Slide Design:  
Renato Castilho, Erick Kuo,  
Katherine Lumb, Paolo Mendoza,  
John Steward, Alberta Testanero  
Gregor Halenda, Slide Photographer  
Props Design:  
Jilly Crook & Scott Ramsay  
Mina Reale, Colorforms Design  
Vanessa Valdes, Sound Design  
Flyer illustration by Kim Chandler  
Chefs:  
Karin Schall and Carol Ochs

Rod Alonzo, Slide Operator  
Furniture Crew:  
George Babiak  
Props Crew:  
Jilly Crook & Victor Rojas  
Colorforms Crew:  
Catherine Berry & Latanya Godfrey  
Light Hang:  
Katie Acheson, Catherine Berry,  
Laurent Junod, Reed Rudy  
Set Load-In Crew:  
Keith Benjamin, Gus Rogerson,  
Thomas Schall  
House Managers:  
Karin Schall, Mary Pat Walsh  
House Crew:  
Beth Emelson, Tricia Roche,  
Laura Sametz, Alison Shanks

The 52nd Street Project is a non-profit organization that brings inner-city children from the Clinton neighborhood together with professional theater artists to create theater. THE OTHER SHOE DROPS is the production of our Playback program. In it, an adult actor/playwright is paired with a kid actor/playwright. The duo is charged to invent two characters for the kid to write a play for. The adult then responds with a second play using the same two characters. All of the children are veterans of the "Playmaking classes" which were adapted for the Project by Daniel Judah Sklar from his book *Playmaking: Children Writing and Performing Their Own Plays*.

### Board of Directors

Ben Barenholtz	Rachel Chanoff
Wendy Ettinger, Chair	Louis P. Friedman
Stephen Graham	Larry Jones
Heidi Landesman	James McDaniel
Frances McDormand	Patricia M. Murphy
Carol Ochs	Willie Reale
Pamala Tyson	Laura Valeroso

### Special Thanks To:

Helen and Peter Randolph; Don Scardino, Leslie Marcus Lynn Landis, Andreas Testani and Michael Clark and the rest of the staff at Playwrights Horizons; Emily Benton; Stephen Haff and New Dramatists; Hartley House; Mike Quon Design Group; Gregor Halenda; Holly Hynes; Lisa Benavides; Jilian Gersten; Stephen Graham; Orli Auslander; David Heuvelman.

### In-Kind Contributions:

Ensemble Studio Theatre; Neil A. Mazzella & Hudson Scenic Studios, Inc.; David Sneddon and Fairway Market; Colorforms; Baron & Baron; Shays & Murphy; Iris A. Brown & Bernhardt/Fudyma Design Group; Emily Grishman; New Dramatists; New York Theatre Workshop; Playwrights Horizons; Eric Karpeles & Mike Sell; Dr. Cristina Biaggi; Stephen Graham; Steve Olsen & The West Bank Cafe; Mario Egozzi; Gregor Halenda; Andy Millon; Lincoln Center Theater; Materials for the Arts; Tom Reale; Port Authority; Mayor's Office of Film & Television; John A. Vassilaros & Son; Kiehl's; Joseph E. Seagrams & Sons; Paris Chocolates; Scholastic Productions.

"The Other Shoe Drops" is made possible by a grant from the Berrilla Kerr Foundation.

# **The Other Shoe Drops**

## **Finally, Naturally Funny**

Written by Jennifer Socarras, Age 12

Directed by Carl Capotorto

Teacher, Principal, etc. . . . . Jennifer Socarras  
Anthony . . . . . Carl Capotorto  
Munchie . . . . . Jennifer Socarras

## **Epilogue**

Written and directed by Carl Capotorto

Anthony . . . . . Carl Capotorto  
Munchie . . . . . Jennifer Socarras

## **A Killing In Sports**

Written by Eli Barbosa, Age 13

Directed by Jerry McGill

Jimmy . . . . . Jerry McGill  
Max . . . . . Eli Barbosa  
Coach . . . . . Eli Barbosa

## **Vending**

Written and directed by Jerry McGill

Jerry . . . . . Jerry McGill  
Eli . . . . . Eli Barbosa  
Woman . . . . . Eris Migliorini

## **Pointe of No Return**

Written by Diana Rojas, Age 17

Directed by Kathryn Rossetter

Maria . . . . . Diana Rojas  
Jennifer . . . . . Kathryn Rossetter  
Announcer . . . . . Carl Capotorto

## **Return to the Point**

Written and Directed by Kathryn Rossetter

Maria . . . . . Diana Rojas  
Jennifer, Jr. . . . . Kathryn Rossetter  
(Choreography by Diana Rojas)

## INTERMISSION

### Comrade's Comrade

Written by Raymond Harold, Age 14

Dramaturg, Michael Bernard

Directed by George Babiak

Ty Rant..... Robert Jimenez  
Comrade..... Raymond Harold  
Bank Teller..... Michael Bernard  
"How Extremely Happy I Am" lyrics by Raymond Harold,  
music by Lisa Dove

### Comrade's Comrade's Comrade

Written by Michael Bernard

Directed by George Babiak

Comrade..... Raymond Harold  
Superman..... Robert Jimenez  
Ty Rant..... Robert Jimenez

### Stuck On Stupid

Written by Virginia Vargas, Age 16

Directed by Willie Reale

Dr. Tina Yorker..... Marissa Chibas  
Destiny..... Virginia Vargas  
"I'm Sorry" Lyrics by Virginia Vargas, music by Lisa Dove

### The Force of Destiny

Written and Directed by Willie Reale

Destiny..... Virginia Vargas  
Bart..... Willie Reale  
Dr. Tina Yorker..... Marissa Chibas  
"Find The Common Denominator" lyrics by Willie Reale,  
music by Lisa Dove

### Time Flies When You're Alive

Written by Jed Clarke, Age 14

Directed by Gina Torres

Omar..... Jed Clarke  
Mrs. Mojo..... Gina Torres  
Squirrel..... Jilly Crook  
Weasel..... Catherine Berry

### Stationary Store Cowboy

Written and Directed by Gina Torres

Omar..... Jed Clarke  
Mrs. Mojo..... Gina Torres

Thank you for coming to THE OTHER SHOE DROPS. If you are not on our mailing list (or if your address has changed), please fill out this form and give it to us on your way out or mail it to the address below. We would also like to know if you are interested in becoming a volunteer. We are always in need of help in all areas, so, please fill out your name, address and phone number.

PLEASE ADD ME TO YOUR MAILING LIST:

NAME \_\_\_\_\_

ADDRESS \_\_\_\_\_

\_\_\_\_\_ ZIP \_\_\_\_\_

PHONE \_\_\_\_\_

YES, I WOULD LIKE TO BE OF HELP:

NAME \_\_\_\_\_

DAYTIME PHONE \_\_\_\_\_

I AM REALLY USEFUL AT (52nd Street Project related things only, i.e. mailings, budget help, fundraising, moving heavy items, etc.) \_\_\_\_\_

### ON SALE IN THE LOBBY

52nd Street Project T-Shirts with Shel Silverstein Logo: \$12.00

The Fabulous Flyer Bar (in six mouthwatering flavors!) \$2.00 & \$1.50/\$1.00 for kids

### 52nd Street Books:

52 Pick Up: A Practical Guide to Doing Theater With Children

a "how to" guide by Willie Reale with a Playmaking course by Daniel Judah Sklar. \$35

Playmaking: Children Writing and Performing Their Own Plays

by Daniel Judah Sklar \$14

Remember, one-half of sale price is tax-deductible!

I would like to mail this (and you're always welcome to enclose a tax-deductible contribution), you can send it to:

The 52nd Street Project 220 West 42nd Street, 18th Floor New York, NY 10036-7211  
(212) 764-1379

The 52nd Street Project gratefully acknowledges the support of the following foundations and corporations: The Altman Foundation, The American Red Cross Overseas Association, Aronson Hirsch Jockaway Tyeman & Weinheimer, Barker Wilfong Foundation, Chase Manhattan Bank, Caroladated Edison, Barbara Bell Curring Foundation, Nathan Cummings Foundation, The Damman Fund, The Dramatists Guild Fund, Educational Foundation of America, Salvatore Ferragamo, The Haroca W. Goldzahn Foundation, The William and Mary Grove Foundation, The Hennessy Foundation, The Holard Lodge Foundation, ICM, The Rita J. and Stanley H. Kaplan Foundation, The Barilla Kari Foundation, Kohl's, Lloyd's Bank, The James Macdonald Foundation, The Ann M. Martin Foundation, JP Morgan, Morgan Stanley and Company, The William Morris Agency, The New World Foundation, The New York Times Company Foundation, The Pumpkin Foundation, RJM Group, The Fran Fox and Leslie R. Samuels Foundation, Shays & Murphy, The Sulzberger Foundation, Harold & Miri Steinberg Charitable Trust, The Threshold Foundation, Travelers Fund, Variety, John A. Vassaleros & Sons, Inc., Wachtmill, Lipton, Kasan & Katz, The Life Adhesion Wallace Theater Fund, The West Bank Cafe, Valerie Wilson Travel, Yorka Construction, as well as matching gifts from AT&T, Bankers Trust, Alex & Brown & Sons, CBS Foundation, the Rockefeller Group, and The New York Times Company Foundation, Pfizer. In addition, the following individuals made gifts to The 52nd Street Project this year:

Karen Adala & Tod Brady	Barbara Elikan	Woodie King, Jr.	Jane M. Sangerman & Joseph
Gabriel Aiello	Caroline & John Ellis	Beth & Seth Klarman	Vodopolas
Nicolas J. Alexanian	Gwen Ellison	Dr. & Mrs. Joseph Kalkar	Dr. Zaborah Schochal
Nan Bush Anderson	Israel A. Englander	Mary Kong	Mr. & Mrs. Walter Shmeidler
Amy Marcell Ansara	Beth A. Emelson	Mike Kowal	Don Schneider
William J. Apuzzo	Wandy Ettinger & Derek McLane	Henry Kringer	Milton Scafield
Alan Arffa & Kay Matschuk	Martha Evans & Pam LaFving	Judy Kahn & David Schwab	Campbell Scott
Emanuel Azarberg	Randy Finch	Fran Kamin	Sarah Scott
Alec Baldwin & Kim Basinger	Kristine Fleischer & David Sneddon	Heidi Landesman	Dana Segal
Jane Ballinger & Michael Goldstein	Amy Flood	James Lapine	Mitchell Samuel & Colleen Carroll
Frances S. Bahr	David Frankal	Thomas La Puppert	Barry Shapiro
Mr. & Mrs. Lawrence Bangsar	Richard Frankal	Jill Larson	Mr. & Mrs. George Shekton
Ben Baranholtz	Kermit Frazier	Mr. & Mrs. Jesse Lahman	Bernice Baruch Showl
Karin Barry & Thomas Schall	Luis Fricks & David Hollander	Heather M. Lester	Lutchen Shivers & Donald J. Rothschild
Angela Bassett	Amy Friedman	Georgette & Martin J. Levy	Barry Singer & Jenine Ferrari
Jessica Bauman	Louis & Patricia Friedman	Rita Levy	Mark Singer & Darcy Dunn
Catherine Beckman	Janica Fudyma & Craig Bernhardt	Mr. & Mrs. William G. Levy	Lois Smith
Louise Beederman & Neil A. Mazzella	Charles Fuller	Carol & Jonathan Lieber	Adam Spika
Lisa Benavides & Timothy Nelson	Judith Garson & Steven Rappaport	Jacqueline Little	John Straber & Robert Shaffron
Pamela S. Berlin & William Carden	Rosa Gassner & Larry Chertoff	Mimi Livingston	Robert Straker
Jane Ira Bloom & Joe Gefosi	Alexandra Gersten & John Vassaleros	Marjorie Loggia	James Sterling
Nyma & Barry Bernard	Alexandra Gersten & Cara Cohen	Julia Lord & Lee Kakchaim	James Stovall
Mr. & Mrs. H. Gerald Bissinger	Jillan Gersten	John S. Lyons	Catherine Strumbas
Susan & Ron Black	Sanford & Marion Goldstein	Kim Lyson	Linda Swartz
Richard Blackstone	John Gould Rubin	Marsue & Peter MacNical	Daniel Swire
R.D. Blackman	Stephen & Cathy Graham	Greg MacPherson	In memory of Harlan J. Swift
Robert & Alison Blankin	Frances & Colin Greer	Rusty Magpie	Mr. & Mrs. Martin Tandler
Audrey Bloch	Janet L. Grillo & David Russell	Donald Margulies & Lynn Street	Jay Tarsas
Judy Blume & George Cooper	Emmy Grishman & Susan Samplover	Rikki S. Matthews	Lili Taylor & Michael Imperioli
Steven Bochaz	Lisa J. Gugenheim	George J. Mavroukales	Mary Lou Teal & Peter Freundlich
Catherine Borowitz & John Turiano	A.R. Gurney	Max D. Mayer	Rutherford Thompson
Cristina Botta Singleton	Thomas Halkias	McGinnis McCay	John & Joan Vol Thome
Blaize Box	Linda & William Halverson	Barbara McCrane & Paul Roole	Gina Torres
Michael Brennan	Emma & Stephen Hamilton	Hannelore & James McDaniel	Yves & Rachel Toure
Bertha & Samuel Britt	Marcia Goy Harden	Andrew McLean	Adriana Trigianni & Tim Stephenson
Eric Brooks	John Hart	Audrey & Danny Mayer	Kathleen Turner
Rita & Fred Brooks	Eugenia Denise Harvey	Drew Mstein	Anne Twomey & John Bradford Lloyd
Becky Browder & Ted Neustadt	Paul E. Hainjian & Charlotte Elberston	Jane & Bill Muddyman	Judith Tygard & Mitch Weitzner
Deborah Brown	Mr. & Mrs. Harry B. Henshel	Kate Hailigan & Robert Rade	Leslie Uzong
Iris A. Brown & Joe White	David Hardrich & Elizabeth Palmer	Randy & Rene Nelson	Laura Valerosa
Susan Bruce & Peter Hodges	Peter Hardrich & Karen Trott	Ruth Nelson	Joan & Paul Van Der Grift
Denise Bursa & Peter Joy Hernandez	William J. Hibshar	Helen & James Neuberger	Alexander Vasilescu
Kate Burton & Michael Ritchie	Jane Hoffman	Eliot Novack	Elizabeth Velazquez & Alexander
Steven Callaghan & Christine Dunn	John Hoffman	Peter & Margaret O'Brien	Bernstein
Rachel Charoff	Willy Holtzman & Sylvia Shepard	Kevin O'Rourke & Edith Thurber	Mark Vietor
Devereux Chantillon & Gerard Harper	Irwin Horowitz	Jacki Ochs & Jan Kroeze	Susan J. Vitucci
Elihu Chanoweth	Catherine Howard	Paul Onderdonk	Stewart von Oelsohn
Marissa Chibas & Travis Preston	Betty Howe	F. Richard Poppas	Thomas von Oelsohn
William Christian	Barnard Hughes & Helen Stenberg	Steven E. Peter	Robin Wagner
Dr. Susan Coates	Mr. & Mrs. David Henry Hwang	David J. Peterkin & Nancy Jacobs	Mary Pat Walsh
Joel Coen & Fran McDemmond	Bill Irwin & Martha Roth	Mr. & Mrs. Alton E. Peters	Dr. & Mrs. Borah Walton
Alice & Barry Cohen	Mark Evan Jacobs	Thomas P. Peters	Wendy Wasserstein
Ruth Cohen	Andie Joeddie	Ethan J. Phillips	Sam Waterston
Richard J. Cohn	Linda Laroy Janiklow	Robert & Susan Phillips	Charles C. Watkins, III
Arthur Collins & Stephanie Barber	George Johannesson	Oliver Platt & Camilla Campbell	Bruce Weber
Penelope A. Collins	Andrea Johnson	Martha Flampton	John Weidman
Ellie & Francis Coppola	Larry & Mary McElrath-Jones	Richard Polatchek	Robert & Andrea Weiner
Thomas Cott	Ruth Jones	Christopher Randolph	Sally Weiss
Eileen Cowell & David Sennett	Doris S. Judell	Helen & Peter Randolph	Ira Wetzman
Margaret Crammins & Pierce Rafferty	Hattie & Rajendra Jutagir	Wilma Rade	Marc Werner
Jean Straus Cullman	Jane Kaczmarek & Bradley Whitford	Donna Recant	John Westler
Arthur Dantchik	Robin Ames Kahn	Jacquelyn Reingold	Max & Barbara Wilk
Frances & Howard Davis	Maurice Kanbar	Iva & Ron Rifkin	Susan Willerman
Mr. & Mrs. Peter Dawkins	Karen & Paul Kandel	Elizabeth Rigg	Elizabeth Williams
Mr. & Mrs. DiRuggeris	Judith & Michael Kane	Thyrost Robertson	Valerie Wilson
Stephen J. Dubner	Eric Karpales & Mike Sall	Minna Rose	Edward Wiseman
Josephine & Charles Dumas	Roni Kastner	Robyn & David Rosenberg	Terrance J. Wittor
Jack & Jane Dunbar	Sheila Kahoe	Richard J. Rubinstein	Bill F. Wrubel
Ned Eisenberg	J. Russell King	Martha Sader & Alan Smith	Jeff & Janine Yass
Shawn Eliot			Lisa Zeff & Ed Fields

The 52nd Street Project is also truly grateful to the many individuals who have made gifts of less than \$100.

as of 12/7/95

The 52nd Street Project Presents:

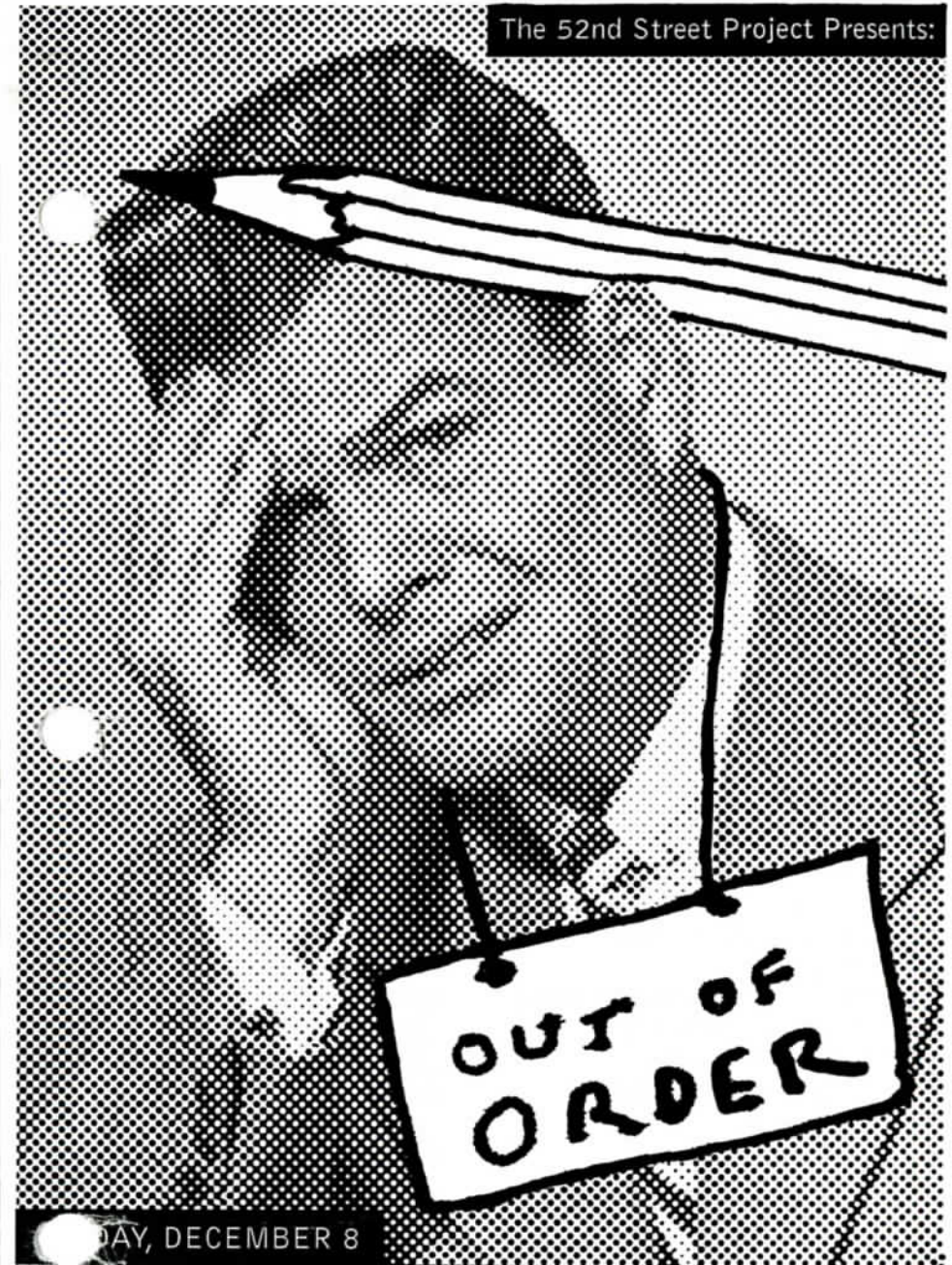

FRIDAY, DECEMBER 8

SATURDAY, DECEMBER 9

SUNDAY, DECEMBER 10

Ensemble Studio Theatre

THE 52ND STREET PROJECT PRESENTS

## OUT OF ORDER

DECEMBER 8, 9, 10, 1995

ENSEMBLE STUDIO THEATRE - NEW YORK CITY

### PROJECT STAFF

Willie Reale, Artistic Director  
Carol Ochs, Executive Director  
Michael Bernard, Associate Artistic Director  
Jenny Gersten, Director of Marketing & Development  
Eris Migliorini, Production Manager  
Susan J. Vitucci, Development Consultant  
Iris A. Brown, Staff Graphic Designer  
Jessica Lissy, Intern  
Playmaking Class Assistants:  
Kim Bendheim, Adam Felber, Mike Kelleher,  
Tanya Kordhoc, Allison Tatlock

### PRODUCTION STAFF

Kevin Joseph Roach, Set Designer  
Jan Kroeze, Lighting Designer  
Mark O'Connor, Assistant to the Lighting Designer  
Sheila Kehoe, Costume Designer  
Karen Roston, Co-Costume Designer  
Simma Gershenson, Stage Manager  
David Baron, Composer  
Mike Sell, Slide Design  
Gregor Halenda, Slide Photographer  
Props Design:  
Kim Chandler, Jilly Crook & Scott Ramsay  
Traci Johnson, Colorforms Design  
Keith Benjamin, Sound Design  
Flyer illustration by Iris A. Brown  
Chef, Eric Karpeles

Noël Dawkins, Slide Operator  
Furniture Crew:  
Carlo Trigiani & Victor Rojas  
Props Crew:  
George Babiak & Jeffrey Zambrano  
Colorforms Crew:  
Catherine Berry & Diana Rojas  
Light Hang:  
Bob Holland, Jack O'Connor,  
Mark O'Connor, Seth "Cher" Wenig  
Set Load-In Crew:  
George Babiak, Nancy Giles,  
Robert Jimenez, Thomas Schall  
House Manager:  
Amanda Jacobs  
House Crew:  
Kim Bendheim, Beth Emelson, Jen Robinson

OUT OF ORDER is made possible by generous grants from the Barker Welfare Foundation, Chase Manhattan Bank, N.A., Ann M. Martin Foundation, and the Pumpkin Foundation. In addition, the Playmaking program is also made possible, in part, with public funds from the New York State Council on the Arts, the Department of Youth Services, and the New York City Department of Cultural Affairs.

**THE 52ND STREET PROJECT** is a non-profit organization that brings inner-city children from the Clinton neighborhood together with professional theater artists to create theater. OUT OF ORDER is part of our Playmaking program. Young people participate in eight weeks of classes adapted for the Project by Daniel Judah Sklar from his book, Playmaking: Children Writing and Performing Their Own Plays. During the class sessions, the participants learn the elements of drama and write their first

At the end of the class, each child is given two actors, a theme and a director guides him or her through the writing of a play during a weekend retreat in the country. The OUT OF ORDER plays are the fruits of their labors.

### BOARD OF DIRECTORS

Ben Barenholtz	Rachel Chanoff
Wendy Ettinger, Chair	Louis P. Friedman
Stephen Graham	Larry Jones
Heidi Landesman	James McDaniel
Frances McDormand	Patricia M. Murphy
Carol Ochs	Willie Reale
Pamala Tyson	Laura Valeroso

### SPECIAL THANKS TO:

Karpeles and Mike Sell; Curt Dempster, Susan Jonas, Jamie Richards, Abigail Lealey and the staff at Ensemble Studio Theatre; Roberta Crane and Wayne Braffman; Joyce Castleberry and Gerry Hovagimyan; Martha Sader; Stephen Haff and New Dramatists; Mary Follett, Jennifer Armstrong, Yvonne LaViale and the staff of Hartley House; Ken McLean, Yajaira Maldonado and the staff of Rheedlen Place; Stephen and Cathy Graham; David Baron; Roberta Favant; Tanya Kordhoc; George Babiak; Chris Ceraso; Waffa Cunningham; Beth Emelson; Adam Felber; Jessica Lissy; Larry Nathanson; Karin Schall; Robert Shaffron; Jeanne Simpson; John Steber; Wendy Stulberg; Anne O'Sullivan; Vanessa Valdes; Jon Patrick Walker; Jeff Williams; Frank Wood; Mr. Knightly.

### IN-KIND CONTRIBUTIONS:

Ensemble Studio Theatre; Neil A. Mazzella & Hudson Scenic Studios, Inc.; David Sneddon and Fairway Market; Colorforms; Baron & Baron; Shays & Murphy; Iris A. Brown & Bernhardt/Fudyma Design Group; Emily Grishman; New Dramatists; New York Theatre Workshop; Playwrights Horizons; Eric Karpeles & Mike Sell; Dr. Cristina Halenda; Andy Millon; Lincoln Center Theater; Materials for the Arts; Rain Restaurant; Tom Reale; Port Authority; Mayor's Office of Film & Television; John A. Vassilaros & Son; Kiehl's; Joseph E. Seagrams & Sons; Paris Chocolates; Scholastic Productions.

# OUT OF ORDER

## THE FALL 1995 PLAYMAKING PLAYS

### ACT I

#### THE WRITER AND THE TREEMAN

Written by Noel Polanco, Age 10

Dramaturg/Director, Martha Banta

Treeman. .... Tom Carrozza

Maria. .... Michelle Hurst

#### THE HAUNTED SCHOOL

Written by Pamela Vera, Age 10

Dramaturg/Director, Carmyn Rivera

Jessica. .... Jilly Crook

Ana. .... Eris Migliorini

#### COUGAR

Written by Hakim Latimore, Age 9

Dramaturg/Director, John Steber

Cougar. .... William Christian

Alex. .... Cecilia Arana

#### THE TIME MACHINE

Written by Rufus Read, Age 9

Dramaturg/Director, Michael Bernard

Bill. .... Jon Patrick Walker

Josh. .... Walker Jones

Ugly Cave Woman. .... Catherine Berry

Thug. .... George Babiak

INTERMISSION

GO BUY STUFF



**ACT II**

**SHARKY AND TIGGY**

Written by William Brown, Age 12

Dramaturg, Robert Shaffron

Director, Byam Stevens

Sharky..... Ray Anthony Thomas

Tiggy..... Robin Morse

WE'RE GONNA KILL THE JAZZ SINGER lyrics by William Brown,  
music by David Baron

**THE DANGEROUS CLOWN**

Written by Natalie Musteata, Age 9

Dramaturg/Director, Judy Goldman

Carolina..... Judy Kuhn

Clown..... Melissa Maxwell

GOING TO THE TOY STORE and WE ARE SAFE lyrics by Natalie Musteata,  
music by David Baron

**THE FRIEND FROM ANOTHER PLANET**

Written by Hunter Reid-Eaton, Age 10

Dramaturg/Director, David Schwab

Seebe..... Leon "Trey" Wilson

Saaba..... Jeff Williams

**SLIPPING INTO DARKNESS**

Written by Eddie Cooper, Age 13

Dramaturg/Director, Candido Tirado

Sean/Fire Chief/Nancy..... Nancy Giles

John..... Thomas Schall

Thank you for coming to OUT OF ORDER. If you are not on our mailing list (or if your address has changed), please fill out this form and give it to us on your way out or mail it to the address below. We would also like to know if you are interested in becoming a volunteer. We are always in need of help in all areas, so, please fill out your name and phone number, and we'll call you.

**EASE ADD ME TO YOUR MAILING LIST:**

NAME \_\_\_\_\_

ADDRESS \_\_\_\_\_

ZIP \_\_\_\_\_

PHONE \_\_\_\_\_

YES, I WOULD LIKE TO BE OF HELP:

NAME \_\_\_\_\_

DAYTIME PHONE \_\_\_\_\_

I AM REALLY USEFUL AT (52nd Street Project related things only, i.e. mailings, backstage help, draising, moving heavy items, etc.) \_\_\_\_\_

**ON SALE IN THE LOBBY**

52nd Street Project T-Shirts with Shel Silverstein Logo: \$12.00

The Fabulous Flyer Bar (in five mouthwatering flavors!): \$2.00 & \$1.50/\$1.00 for kids

52nd Street Project Caps: \$15.00

**52nd Street Project BOOKS**

Playmaking: Children Writing and Performing Their Own Plays by Daniel Judah Sklar \$14

52 Pick Up: A Practical Guide to Doing Theater With Children a HOW TO guide by Willie Reale with a Playmaking course by Daniel Judah Sklar \$35

If you would like to mail this (and you're always welcome to enclose a tax-deductible contribution), you can send it to:

The 52nd Street Project 220 West 42nd Street, 18th Floor New York, NY 10036-7211 (212) 764-1379



# SHOW PROGRAMS 1996-2000

The 52nd Street Project gratefully acknowledges the support of the following foundations and corporations: The Altman Foundation, Aronson Hirsch Jockaway Tyman & Weintraub, Baker Waller Foundation, Chase Manhattan Bank, Consolidated Edison, Barbara Hill Gunning Foundation, Nelson Gunning Foundation, The Damron Fund, The Dramatic Guild Fund, Educational Foundation of America, EPC, Sabotage Foundation, The Horace W. Goldsmith Foundation, The William and Mary Grove Foundation, The Haremsky Foundation, The Holland Lodge Foundation, ICM, Invention Artist, The Rita J. and Stanley H. Kaplan Foundation, The Benita Kay Foundation, Lloyds Bank, The James Macdonald Foundation, The Jen M. Morris Foundation, JP Morgan, Morgan Stanley and Company, The William Morris Agency, The New World Foundation, The New York Times Company Foundation, The Northwest Point Foundation, The Pumpkin Foundation, RJM Group, The Fox Fox and Leslie R. Sarason Foundation, Shays & Murphy, The Schulberg Foundation, Harold & Miri Shubberg Charitable Trust, The Threshold Foundation, Travelers Fund, Variety, John A. Vaccaro & Sons, Inc., Woodard, Lothrop, Alton & Katz, The Lila Acheson Wallace Trust Fund, The West Bank Cafe, Valerie Wilson Travel, Writers & Artists, Yorka Construction, as well as matching gifts from AT&T, Bankers Trust, CRS Foundation, the Rockefeller Group, and The New York Times Company Foundation, Please. In addition, the following individuals made gifts of over \$150 to the 52nd Street Project this year:

Karen Akide and Ted Brady  
Amy Merrill Aronson  
Emmanuel Azenberg  
Jane Ballinger & Michael Goldstein  
Martha Baris & David Janne  
Stephanie Barber & Arthur Collins  
Ben Baruchowitz  
Ken Bessinger & Alec Baldwin  
Jessica Beuman  
Catherine Beckman  
Laurie Bechtman & Neil A. Muzzella  
Lisa Bonowitz & Timothy Nelson  
Pamela S. Buelo & William Cardin  
Jane Ira Busch & Joe Gallo  
Myra & Barry Bursaw  
Susan & Ben Black  
Richard Blockstone  
Robert & Alison Blumkin  
Audrey Block  
Steven Bochco  
Katharine Borowitz & John Tortorella  
Cristina Botta Singhman  
Blaise Box  
Bartha & Samuel Bitt  
Eric Brooks  
Rita & Fred Brooks  
Becky Browder & Ted Neustadt  
Deborah Brown  
Iris A. Brown & Joe White  
Susan Bruce & Peter Hodges  
Denise Buzza & Peter Jay Fernandez  
Kate Burton & Michael Ritchie  
Mr. & Mrs. Richard Cahlin  
Rachel Charoff  
Marissa Chabot & Travis Pecton  
William Christian  
Alice & Barry Cohen  
Ruth Cohen  
Richard J. Cohn  
Marya Cohen & Franze Brzezinski  
Arthur Collins & Stephanie Barber  
Penelope A. Collins  
Elin & Francis Coppola  
Eileen Cover & David Sorett  
Margaret Corman & Pierce Rafferty  
Jean Street Colman  
Arthur Danilchik  
Mr. & Mrs. Peter Dawkins  
Georgie & Bill DeLoze  
Mr. & Mrs. DiEgiovanni  
Stephen J. Dobner  
Jack & Jane Dunbar  
Neil Eisenberg  
Caroline & John Ellis  
Gwen Elliott

Israel A. Englander  
Beth A. Emanson  
Woody Ertlinger & Derek McLane  
Ritina Flaisher & David Sweddon  
Amy & Scott Flood  
David Frankal  
Richard Frankal  
Kamell Frazier  
Iain Fricka & David Hollander  
Amy Friedman  
Linda & Patricia Friedman  
Judith Gerson & Steven Doppaquet  
Rosa Gerson & Larry Chernoff  
Alexandra Gersten & John Vaccaro  
Barbara Gersten & Cass Cohen  
Iwan Getz & Mark Ginnell  
Sanford & Marion Goldstein  
John Gould Rubin  
Carly & Stephen Grubman  
Frances & Colin Gwar  
Michael Guel  
Janet L. Gella & David Russell  
Emily Gidman & Susan Scarpino  
Lisa J. Gogginstein  
A.R. Guney  
Mr. Josie de Guzman & Anshu Jaackel  
Thomas Habkins  
Emma & Steve Hamilton  
Marisa Gay Harlan  
John Hart  
Eugenia Denise Harvey  
William J. Hirsch  
Willy Holtzman & Sylvia Shepard  
Irwin Horowitz  
Barbara Hughes & Helen Stenberg  
Mr. & Mrs. David Henry Huang  
Mark Evan Jacobs  
Sy Jacobs  
Linda Larry Janklow  
Andrew L. Johnson  
Larry & Mary McElrath-Jones  
Ruth Jones  
Davis S. Judell  
Hattie & Rajendra Jutaji  
Jane Kaczmarek & Bradley Whitford  
Mr. & Mrs. Max Kahn  
Robin James Kahn  
Alonca Karbar  
Eric Kaye & Mike Sol  
Ron Kachur  
Shella Kahon  
J. Russell King  
Woodie King, Jr.  
Beth & Seth Klarman  
Dr. & Mrs. Joseph Kalkar

Henry Kleger  
July Kahn & David Schwab  
Haid Landerman  
Jill Larson  
Heather M. Lester  
Georgette & Morton J. Levy  
Beto Levy  
Carol & Jonathan Lieber  
Marjorie Lippie  
Julia Lard & Lee Kalkstein  
Katharine Lamb & Joe Vitale  
John S. Lyons  
Kim Lyons  
Marion & Peter MacCliff  
Greg MacPherson  
Rusty Magee  
Donald Margolis & Lynn Street  
Ray Merschliff & Alan Arfa  
George J. Menewickas  
Max D. Meyer  
McGinnis McCoy  
Barbara McGraw & Paul Kende  
Helen & James McDaniel  
Frances McDaniel & Joel Coen  
Andrew McKean  
Audrey & Dorey Meyer  
Rick Meyers & PJ Brown  
Andy Milson  
Drew Minton  
Jane & Bill Muddymen  
Patricia M. Murphy & Adam Spilka  
Kate Nellgas & Robert Zada  
Michael S. Nelson  
Pamela Nelson & Peter Fritschel  
Randy & Kona Nelson  
Ruth Nelson  
Helen & James Neuberger  
Mr. & Mrs. Ray E. Neuberger  
Ellen Nevick  
Kevin O'Rourke & Edith Tharber  
Carol Ochs  
Jacki Ochs & Jan Kravitz  
Paul & Maria Orlendank  
Elizabeth Palawa & David Herdich  
Steven E. Peter  
David J. Petelin & Nancy Jacobs  
Mr. & Mrs. Alton E. Peters  
Thomas P. Peters  
Ethan J. Phillips  
Edward & Susan Phillips  
Oliver Platt & Camille Campbell  
Martha Plimpton  
Richard Politchak  
Christopher Randolph  
Helen & Peter Randolph

Willie Rada  
Donna Riccardi  
Jacquelyn Ringgold & Brian Martes  
Joe & Ben Rifkin  
Susan & Elmer Rose  
Robyn & David Rosenberg  
Betty & Clifford Ross  
Martha Roth & Bill Irwin  
Judith O. Rubin  
Richard J. Rubenstein  
Martha Soder & Alton Smith  
Jane Songerman & Joseph Valopoles  
Karin & Thomas Schall  
Mitchell Samuel & Colleen Carroll  
Barry Shapiro  
Bernice Bruch Showel  
Lillian Shivers & Donald J. Rothchild  
Jacqueline Simon  
Barry Singer  
Mark Singer & Darcy Dana  
Luis Smith  
John Straber & Robert Shuffman  
Jean Stein  
Joy Joelle Stewart  
Linda Swartz  
Daniel Swaz  
In memory of Harlan J. Swift  
Ann Takman  
Mr. & Mrs. Martin Tandler  
Catherine L. Thomas  
Adriana Trigiari & Tim Stephenson  
Karen Trutt & Peter Herdich  
Kathleen Turner  
Anne Twomey & John Bedford Lloyd  
Judith Tyger & Mitch Watzow  
Laura Valerzo  
Elizabeth Valerzo & Alexander  
Benstein  
Susan J. Vitucci  
Stewart von Oelsen  
Robin Wagner  
Mary Pat Walsh  
Dr. & Mrs. Sarah Walton  
Wendy Wasserstein  
Sam Waterstein  
Robert & Andrea Weiner  
Sally Weiss  
Ivo Wetzman  
Max & Barbara Wilf  
Susan Wilkerson  
Elizabeth Williams  
Donald Windham  
Jeff & Janine Yess  
Lisa Zell & Ed Fields

Donors of less than \$150 please know that the capacity for gratitude in our hearts far exceeds the limitations of this small page. as of 1/20/96

The 52nd Street Project presents

# Breaking The Mold

Monday, January 22nd & Tuesday, January 23rd, 1996

West Bank Cafe  Downstairs Theatre

407 West 42nd Street, New York City

The 52nd Street Project Presents

## Breaking The Mold

The 1996 Two-on-Twos  
January 22 & 23, 1996

West Bank Cafe Downstairs Theatre, New York City

### The 52nd Street Project Staff

Willie Reale, Artistic Director  
Carol Ochs, Executive Director  
Michael Bernard, Associate Artistic Director  
Jenny Gersten, Director of Marketing & Development  
Eris Migliorini, Production Manager  
Susan J. Vitucci, Development Consultant  
Iris A. Brown, Staff Graphic Designer

### Production Staff

Kevin Joseph Roach, Set Designer  
Hank Meiman, Lighting Designer  
Costume Design, Crystal Thompson  
Henry Krieger, Composer  
Rusty Magee, Monday Musical Director  
Henry Krieger, Tuesday Musical Director  
Vanessa Valdes, Sound Design  
Props Design: Kim Chandler, Jilly Crook &  
Scott Ramsay  
Hank Meiman, Stage Manager

Set Painters: Lisa Benavides; Grace Bonfiglio;  
Jenny Gersten; Erick Kuo; Katherine  
Lumb; Paolo Mendoza; Kate McCamy;  
Eris Migliorini; Wendy Stulberg; Kevin  
Joseph Roach; John Steward; Alberta  
Testanero  
Noel Dawkins, Furniture Head  
Betsy Foldes, Props Head  
Backstage Crew: Yolanda Maldonado &  
Tina Vamvoukakis  
House Manager, Mary Pat Walsh  
Bar Staff: Eddie Cooper, Jenny Gersten &  
Michael Ritchie

The 1995 Two-on-Twos program is made possible in part by a  
Cultural Challenge Grant from the NYC Department of Cultural  
Affairs and the New York State Council for the Arts.

The 52nd Street Project gratefully acknowledges  
Boylan's and D'Agostino Supermarkets  
for their generous contribution of birch beer and vanilla ice cream,  
respectively, for these performances.

The 52nd Street Project is a non-profit organization that brings inner-city children from the Hell's Kitchen neighborhood together with professional theater artists to create theater. BREAKING THE MOLD is part of the Two-on-Two program, in which a professional playwright creates a play specifically for two kids who are then guided by an adult director. The Two-on-Two's represent the second level of the the Project's three-part acting program.

### Board of Directors:

Ben Barenholtz	Lisa Benavides
Rachel Chanoff	Wendy Ettinger, Chair
Louis P. Friedman	Stephen Graham
Larry Jones	Heidi Landesman
James McDaniel	Frances McDormand
Patricia M. Murphy	Carol Ochs
Willie Reale	Pamala Tyson
Laura Valeroso	Elizabeth Williams

### Special Thanks To:

Steve Olsen, Hank Meiman and the West Bank Cafe; Stephen Haff, Ron Riley and the staff of New Dramatists; Wendy Ettinger & Derek McLane; Maria Tucci; David Strathairn and Logan Goodman; Materials for the Arts; Neil Mazzella, Roger and Hudson Scenic; Kevin Joseph Roach; the gang at Mike Quon Design; Steve Schofel, Mike Falzone and the staff of 220 West 42nd Street; Abigail, Jamie and the staff at Ensemble Studio Theatre; Holly Hynes & Miguel Casteneda.

### In-Kind Contributions:

Ensemble Studio Theatre; Neil A. Mazzella & Hudson Scenic Studios, Inc.; David Sneddon and Fairway Market; Colorforms; Baron & Baron; Emily Benton; Joyce Castleberry & Gerry Hovagimyan; Virginia Dare & Joya Verde; Joanne Comerford; Jose Dominguez & Lisa Waldman; Alpine Meat House; Roberta Crane & Wayne Braffman; Mark Keoppen & Wendy Townsend; Kip Thompson; Painter's Tavern; Shays & Murphy; Iris A. Brown & Bernhardt/Fudyma Design Group; Emily Grishman; New Dramatists; New York Theatre Workshop; Playwrights Horizons; Eric Karpeles & Mike Sell; Dr. Cristina Biaggi; Stephen Graham; Steve Olsen & The West Bank Cafe; Mario Egozzi; Gregor Halenda; Andy Millon; Lincoln Center Theater; Materials for the Arts; Rain Restaurant; Tom Reale; Port Authority; Mayor's Office of Film & Television; John A. Vassilaros & Son; Kiehl's; Joseph E. Seagrams & Sons; Paris Chocolates; Scholastic Productions.

## BREAKING THE MOLD

### **BOYS WILL BE TOYS**

Written by Susan Kim  
Directed by Dion Graham

Captain Mutation..... Freddy Matos  
Dodo..... Luis Anthony Maldonado

### **SELENA'S BEEN DUPED**

Written by Adriana Trigiani  
Directed by George Babiak

Selena..... Elisa Mohamed  
Will..... Desmond Robertson

### **"Just A Little Thumbthing"**

lyrics by Willie Reale  
music by Henry Krieger

### **BINGO POWER**

Written by Michael Bernard  
Directed by Anne Garcia Romero

Norbert..... Cordell Horsford  
Radio Voice..... Michael Bernard  
Big Mouth Baranski..... Joseph Mohamed  
Police Officer 1..... Tina Varnvoukakis  
Police Officer 2..... Betsy Foldes  
Rum Tummy..... Hank Meiman

**CONTINUED...**

**ESCAPE FROM JELLOLAND**

Written by Liz Tuccillo  
Directed by Lisa Benavides

Voice Over..... Willie Reale  
Jennifer.....Amy Barbosa  
Gina..... Mary Vamvoukakis

"The Jello Blues"  
lyrics by Liz Tuccillo  
music by Henry Krieger

**HEADS IN THE CLOUDS**

Written by Willie Reale  
Directed by Joe White

Alejandro..... Luis Santoni  
Hakeem.....Fernando Ramirez

**FISH STORIES**

Written by Eduardo Machado  
Directed by Stephen Haff

Boy..... Alex Metzler  
Girl..... Evelyn Maldonado

"Inside"  
lyrics by Eduardo Machado  
music by Henry Krieger

Thank you for coming to BREAKING THE MOLD. If you are not on our mailing list (or if your address has changed), please fill out this form and give it to us on your way out, or mail it to the address below. We would also like to know if you are interested in becoming a volunteer. We are always in need of help in all areas, so, please fill out your name, address and phone number.

**PLEASE ADD ME TO YOUR MAILING LIST:**

NAME \_\_\_\_\_

ADDRESS \_\_\_\_\_

\_\_\_\_\_ Zip \_\_\_\_\_

PHONE \_\_\_\_\_

**YES, I WOULD LIKE TO BE OF HELP:**

NAME \_\_\_\_\_

DAYTIME PHONE \_\_\_\_\_

**I AM REALLY USEFUL AT** (52nd Street Project related things only, i.e. mailings, backstage help, fundraising, etc.) \_\_\_\_\_

**ON SALE AT THE BAR**

52nd Street Project **T-Shirts** (\$12) and **Baseball Caps** (\$15) with Shel Silverstein Logo

Remember, one-half of sale price is tax-deductible!

If you would like to mail this (and you're always welcome to enclose a tax-deductible contribution), you can send it to:

The 52nd Street Project  
220 West 42nd Street, 18th Floor  
New York, NY 10036-7211  
(212) 764-1379

The 52nd Street Project gratefully acknowledges the support of the following foundations and corporations: The Altman Foundation, Armstrong Hirsch Jackoway Tyerman & Wehner, Barker Welfare Foundation, Chase Manhattan Bank, Consolidated Edison, Barbara Bell Cumming Foundation, Nathan Cummings Foundation, The Dammann Fund, The Dramatists Guild Fund, Educational Foundation of America, EPIC, Salvatore Ferragamo, The Horace W. Goldsmith Foundation, The William and Mary Greive Foundation, The Hennessy Foundation, The Holland Lodge Foundation, ICM, Innovative Artists, The Rita J. and Stanley H. Kaplan Foundation, The Berilla Kerr Foundation, Uboys Bank, The James Macdonald Foundation, The Ann M. Martin Foundation, JP Morgan, Morgan Stanley and Company, The William Morris Agency, The New World Foundation, The New York Times Company Foundation, The Northwest Point Foundation, The Pumpkin Foundation, RUM Group, The Fan Fox and Leslie R. Samuels Foundation, Shays & Murphy, The Sulzberger Foundation, Harold & Miri Steinberg Charitable Trust, The Threshold Foundation, Travelers Fund, Variety, John A. Vassler & Sons, Inc., Wachter, Lipson, Rosen & Katz, The Lia Acheson Wallace Theater Fund, The West Bank Cafe, Valerie Wilson Travel, Writers & Artists, York Construction, as well as matching gifts from AT&T, Bankers Trust, CBS Foundation, the Rockefeller Group, Pfizer, and The New York Times Company Foundation. In addition, the following individuals made gifts of over \$150 to The 52nd Street Project this year:

Karen Aidala and Tod Brody	Caroline & John Ellis	Woody King, Jr.	Wile Reese
Amy Merrill Ansara	Owen Ellison	Beth & Seth Klarman	Donna Racant
Emanuel Azenberg	Israel A. Englander	Dr. & Mrs. Joseph Kolker	Jacquelyn Reingold & Brian Merten
Jane Balingier & Michael Goldstein	Beth A. Emelton	Henry Krieger	Ivi & Ron Rifkin
Martha Banta & David Turner	Wendy Ellinger & Derek McLane	Judy Kuhn & David Schwab	Susan & Eithu Rose
Stephanie Barber & Arthur Collins	Kristine Fleisher & David Sneddon	Heidi Landerman	Robyn & David Rosenberg
Ben Barenholtz	Amy & Scott Flood	Jill Larson	Betsy & Clifford Ross
Kim Basinger & Alec Baldwin	David Frankel	Hauher M. Lester	Martha Roth & Bill Irwin
Jessica Bauman	Richard Frankel	Georgette & Morton J. Levy	Judith O. Rubin
Catherine Bockman	Kermit Frazier	Carol & Jonathan Lieber	Reta Levy
Laurie Beechman & Neil A. Mazzala	Lois Fricke & David Hollander	Marjorie Loggia	Martha Sader & Allan Smith
Lisa Benavides & Timothy Nelson	Amy Friedman	Julia Lord & Lee Kalkheim	Jane Sangerman & Joseph Vadalapan
Pamela S. Berlin & William Carden	Louis & Patricia Friedman	Katherine Lumb & Joe Vitale	Karin & Thomas Schall
Jane Ira Bloom & Joe Gritzel	Judith Garson & Steven Rappaport	John S. Lyons	Mitchell Semel & Colleen Carroll
Myma & Barry Bernard	Rose Gasser & Larry Chertoff	Kim Lyson	Berry Shapiro
Susan & Ron Black	Alexandra Gersten & John Vasiliadis	Marsue & Peter MacNicol	Bernice Saruch Shawl
Richard Blackstone	Bernard Gersten & Cora Cahlan	Greg MacPherson	Lotzohen Shivers & Donald J. Rothchild
Robert & Allison Slinkin	Ileen Getz & Mark Grinnell	Rusty Magee	Jacqueline Simon
Audrey Bloch	Sanford & Marion Goldstein	Donald Margulies & Lynn Street	Barry Singer
Steven Bochco	John Gould Rubin	George J. Mavronicolas	Mark Singer & Darcy Dunn
Katherine Borowitz & John Turano	Cathy & Stephen Graham	Max O. Mayer	Lois Smith
Cristina Botta Singetoni	Frances & Colin Greer	McGinnis McCoy	John Steber & Robert Shaffron
Blaise Box	Michael Greif	Barbara McCrane & Paul Reale	Jean Stein
Bertha & Samuel Brit	Janet L. Grillo & David Russell	Hannelore & James McDaniel	Joy Javitt Stewart
Eric Brooks	Emily Grishman & Susan Sampliner	Frances McDonnand & Joel Coen	Linda Swartz
Rita & Fred Brooks	Lisa J. Gugenheim	Andrew McKeon	Daniel Sweet
Becky Browder & Ted Neustadt	A.R. Gurney	Audrey & Danny Meyer	In memory of Harlan J. Swift
Deborah Brown	Ms. Josie de Guzman & Andre Jaecle	Beck Meyers & P.J. Brown	Ann Talman
Ms A. Brown & Joe White	Thomas Hallikas	Andy Milton	Mr. & Mrs. Martin Tandler
Susan Bruce & Peter Hedges	Ernie & Steve Hamilton	Drew Mistein	Catherine L. Thomas
Denise Burne & Peter Jay Fernandez	Marcia Gay Harden	Jane & Bill Muddyman	Adriana Trigiani & Tim Stephenson
Kate Burton & Michael Rikhie	John Hart	Patricia M. Murphy & Adam Spika	Karen Troll & Peter Herdrich
Mr. & Mrs. Richard Cashin	Eugenia Denise Harvey	Kate Nelligan & Robert Reale	Kathleen Turner
Rachel Chanoff	William J. Hibsher	Michael S. Nelson	Anne Twomey & John Bedford Lloyd
Mariusa Chibas & Travis Preston	Willy Holtzman & Sylvia Shepard	Pamela Nelson & Peter Fritschel	Judith Tygard & Mitch Weltzner
William Christian	Iwin Horowitz	Randy & Rona Nelson	Laura Valensco
Alice & Barry Cohen	Barnard Hughes & Helen Stanborg	Ruth Nelson	Elizabeth Velazquez & Alexander Bernstein
Ruth Cohen	Mr. & Mrs. David Henry Hwang	Helen & James Neuberger	Susan J. Vitucci
Richard J. Cohn	Mark Evan Jacobs	Mr. & Mrs. Roy R. Neuberger	Stewart von Dehaen
Marya Cohn & Fraser Bresnahan	Sy Jacobs	Ellen Novack	Robin Wagner
Arthur Collins & Stephanie Barber	Linda Leroy Janklow	Kevin O'Rourke & Edith Thurber	Mary Pat Walsh
Penelope A. Collins	Andrea L. Johnson	Carol Ochs	Dr. & Mrs. Sorah Walton
Elle & Francis Coppola	Larry & Mary McElrath-Jones	Jacki Ochs & Jan Kroeze	Wendy Wasserstein
Eileen Cowell & David Sennett	Ruth Jones	Paul & Maria Oosterdonk	Samuel A. Waterston
Margaret Cremenini & Pierce Raftery	Doris S. Judell	Elizabeth Palmer & David Herdrich	Robert & Andrea Weiner
Joan Graus Cullman	Hattie & Rajendra Jutagir	Steven E. Peter	Sally Weiss
Arthur Dantschik	Jane Kaczmarek & Bradley Whitford	David J. Pelekin & Nancy Jacobs	Ira Wetzman
Mr. & Mrs. Peter Dawkins	Mr. & Mrs. Max Kahn	Mr. & Mrs. Alton E. Peters	Max & Barbara Wik
Georgia & Bill Delano	Robin Amos Kahn	Thomas P. Peters	Susan Wileman
Mr. & Mrs. DiRuggeris	Maurice Kanbar	Ethan J. Phillips	Elizabeth Williams
Stephen J. Dubner	Eric Karpelus & Mike Sell	Robert & Susan Phillips	Donald Windham
Jack & June Dunbar	Ron Kasiner	Oliver Pratt & Camilla Campbell	Jeff & Janine Yass
Ned Eisenberg	Shella Kehoe	Martha Plimpton	Lisa Zeff & Ed Fields
	J. Russell King	Richard Polachek	
		Christopher Randolph	
		Helen & Peter Randolph	

as of 1/20/96



HB Playwrights  
Foundation  
124 Bank Street

Friday,  
March 22nd at 7:30 p.m.  
Saturday,  
March 23rd at 3:00 and 7:30 p.m.  
Sunday,  
March 24th at 3:00 and 7:30 p.m.

To those who made gifts of less than \$150, for which we have no fort small enough, we give humongous, extra bold and heartfelt thanks.

THE 52ND STREET PROJECT PRESENTS:

# Take Charge:

## THE RESPONSIBILITY PLAYS

March 22, 23, and 24, 1996

HB Playwrights Foundation, New York City

### PROJECT STAFF

Willie Reale, Artistic Director  
Carol Ochs, Executive Director  
Michael Bernard, Associate Artistic Director  
Sally Bock, Director of Development and Marketing  
George R. Babiak, Production Manager  
Susan J. Vitucci, Development Consultant  
Iris A. Brown, Staff Graphic Designer  
MaryPat Walsh, Super-Duper Gal Monday-through-Friday

### Interns:

Meredith Beuwkes, Erik Bowie, Sarah Makris

### Playmaking Class Assistants:

Catherine Berry, Meredith Beuwkes, Jose Dominguez, Allison Eikerenkoetter,  
Adam Felber, Barbara McCrane, Eris Migliorini, Alison Tatlock

### PRODUCTION STAFF

Kevin Joseph Roach, Set Designer  
Alistair Wandesforde-Smith,  
Lighting Designer  
Sheila Kehoe, Costume Designer  
Karen Roston, Co-Costume Designer  
Noel Dawkins, Stage Manager  
David Baron, Composer  
Vanessa Valdes, Sound Designer  
Slide Design:

Erik Kuo, Katherine Lumb,  
Paolo Mendoza, John Steward,  
Alberta Testanero, Terry Turner  
*Plus special mention to:*  
Angela Dundee & Sharon Scotland

Gregor Halenda, Slide Photographer

### Props Design:

Kim Chandler, Scott Ramsay  
Paula Longendyke, Colorforms Design  
Madeleine Rafferty (age 7),  
Assistant Colorformist  
Flyer illustration by Ruder-Finn

Sarah Makris, Slide Operator

### Furniture Crew:

Erik Bowie, Fernando Ramirez

### Props Crew:

Jilly Crook, Samona Squire

### Colorforms Crew:

Brian Kilpatrick, Luis Santoni

### Light Hang:

Meredith Beuwkes, Vienna Hagen,  
Brian O'Neill, Gus Rogerson

### Set Load-In Crew:

Erik Bowie, Stephen Haff,  
Danny Johnson, Brian O'Neill,  
Lori Scherer, Alison Tatlock

### House Manager:

Karin Barry

### House Crew:

Jenny Gersten, Russ Lees,  
Don Berman, Adam Felber,  
Jeannie Simpson

Playmaking Chef, Charlotte Armstrong

TAKE CHARGE is made possible by generous grants from the Barker Welfare Foundation, Chase Manhattan Bank, N.A., Ann M. Martin Foundation, and the Pumpkin Foundation. In addition, the Playmaking program is also made possible, in part, with public funds from the New York State Council on the Arts, the Department of Youth Services, and the New York City Department of Cultural Affairs.

The 52nd Street Project is a non-profit organization that brings inner-city children from the Clinton neighborhood together with professional theater artists to create theater. TAKE CHARGE is part of our Playmaking program. Young people participate in eight weeks of classes adapted for the Project by Daniel Judah Sklar from his book, *Playmaking: Children Writing and Performing Their Own Plays*. During the class sessions, the participants learn the elements of drama and write their first play. At the end of the class, each child is given two actors, a theme and a director who guides him or her through the writing of a play during a weekend retreat in the country. TAKE CHARGE: THE RESPONSIBILITY PLAYS is the fruit of their labors.

### Board of Directors

Ben Barenholtz	Lisa Benavides
Rachel Chanoff	Wendy Ettinger, Chair
Louis P. Friedman	Stephen Graham
Larry Jones	Heidi Landesman
James McDaniel	Frances McDormand
Patricia M. Murphy, Esq.	Carol Ochs
Willie Reale	Pamala Tyson
Laura Valeroso	Elizabeth Williams

### Special Thanks To:

Stephen & Cathy Graham; Celia, Bonnie and Wendell; Laura Eldridge, Barbara Harris and the Kent School; William Carden, Trudy Steibl, Vienna Hagen and HB Playwrights Foundation; Stephen Haff and New Dramatists; Mary Follett, Jennifer Armstrong, Yvonne LaViale and the staff of Hartley House; David Baron; Rob Reale.

### In-Kind Contributions:

Ensemble Studio Theatre; Neil A. Mazzella & Hudson Scenic Studios, Inc.; David Sneddon and Fairway Market; Colorforms; Baron & Baron; Shays & Murphy; Iris A. Brown & Bernhardt/Fudyma Design Group; Emily Grishman; New Dramatists; New York Theatre Workshop; Playwrights Horizons; Eric Karpeles & Mike Sell; Dr. Cristina Biaggi; Stephen Graham; Steve Olsen & The West Bank Cafe; Mario Egozzi; Gregor Halenda; Andy Millon; Lincoln Center Theater; Materials for the Arts; Rain Restaurant; Tom Reale; Port Authority; Mayor's Office of Film & Television; John A. Vassilaros & Son; Kiehl's; Joseph E. Seagrams & Sons; Paris Chocolates; Scholastic Productions; Yorke Construction; Jomen Electrics; Mark Keoppen; Kevin Joseph Roach.



Angela Bassett and Jimmy Smits  
(honorary co-chairs)

and the Board of Directors of  
The 52nd Street Project

kindly request that you

# SAVE THE DATE

at the Copacabana

I	T	'S
M	A	Y
S	I	X <sup>th</sup>

be there or be square

and it's  
The 52nd Street Project's  
Fifteenth Anniversary Benefit

featuring a round of  
**CELEBRITY SQUARES**

(kinda like a game show with appearances by  
your favorite Project kids and well-known actors)

For more information call Carol Ochs at (212) 764-1379  
After March 29, call her at our new Project Clubhouse number: (212) 333-5252

## TAKE CHARGE: THE SPRING 1996 PLAYMAKING PLAYS

### ACT 1

#### The Haunted House

Written by Jonathan Brown, age 10

Dramaturg/Director, Danny Johnson

Fangs the Headsnapper ..... Christopher Dansby Fisher

Goul the Ghost ..... Allison Eikerenkoetter

#### Pushed for No Reason

Written by Orquidea Alicea, age 10

Dramaturg/Director, Anne Garcia-Romero

Daniel, a blue jeep ..... Sharon Washington

Baldo, a red jeep ..... Helene Lantry

Sheila, a yellow jeep ..... Helene Lantry

#### Sibling Love

Written by Candy Godoy, age 10

Dramaturg/Director, Julie Boyd

Abby, 5 years old ..... Arthur French

Bobby, her brother, 7 years old ..... Barbara McCrane

Mom ..... Elizabeth Keiser

#### Boys to Men

Written by Osage Lewis, age 10

Dramaturg/Director, Peter Jay Fernandez

Mike, age 21 ..... Denise Burse

Larry, his brother, age 22 ..... Kevin Geer

#### This Game Isn't Going Right

Written by Carl Moon, age 10

Dramaturg/Director, Peter Herdrich

Coach ..... Gus Rogerson

Michael Talito ..... Michael Dolan

Announcer ..... Don Criqui

Hockey Stick ..... Gus Rogerson

**INTERMISSION**

## ACT 2

### Election Day

Written by Alex Alicea, age 10

Dramaturg, Willie Reale

Director, Eris Migliorini

Steffani ..... Laurine Towler  
Robert ..... Taro Alexander  
Andrea ..... Elizabeth Keiser  
Secretary ..... Fernando Ramirez

### A Trip to Paris

Written by Lorraine Lopez, age 10

Dramaturg/Director, Michael angel Johnson

Emily ..... Emily Wachtel  
Cathy ..... Ted Neustadt  
Stephen ..... Ted Neustadt

### OOPSI

Written by Alex Cooper, age 10

Dramaturg, Julie McKee

Director, Peter Herdrich

Shnike, an 18 year old girl ..... Karen Trott  
Coach Dodo ..... Frank Wood  
Shnike's boyfriend ..... Frank Wood

### The Happy Couple...Sometimes

Written by Tanika Parson, age 10

Dramaturg/Director, Michael Bernard

Rose ..... Alison Tatlock  
Richard ..... Yusef Bulos  
Mechanic ..... Luis Santoni

### The Life of Rachel

Written by Gloria Trejo, age 11

Dramaturg/Director, Stephen Haff

Mom ..... Myra Lucretia Taylor  
Dad ..... Jose Soto  
Rachel ..... Jane Muddyman  
Jason ..... Erik Bowie

Thank you for coming to TAKE CHARGE. If you are not on our mailing list (or if your address has changed), please fill out this form and give it to us on your way out or mail it to the address below. We would also like to know if you are interested in becoming a volunteer. We are always in need of help in *all areas*, so please fill out your name and phone number, and we'll call you.

#### PLEASE ADD ME TO YOUR MAILING LIST:

NAME \_\_\_\_\_

ADDRESS \_\_\_\_\_

ZIP \_\_\_\_\_

PHONE \_\_\_\_\_

#### YES, I WOULD LIKE TO BE OF HELP:

NAME \_\_\_\_\_

DAYTIME PHONE \_\_\_\_\_

I AM REALLY USEFUL AT (52nd Street Project related things only. Examples: Mailings, backstage help, fundraising, moving heavy items, etc.)...

If you would like to mail this (and you're always welcome to enclose a tax-deductible contribution), you can send it to:  
The 52nd Street Project 500 West 52nd St. New York, NY 10019  
(212) 333-5252

## ON SALE IN THE LOBBY

*Cool Stuff*

The Fabulous Flyer Bar  
(in five mouth-watering flavors!)  
**\$2.00 and \$1.50. \$1.00 for kids**

52nd Street Project T-Shirts  
with Shel Silverstein's logo  
**\$12.00**

52nd Street Project Caps  
**\$15.00**

*52nd Street  
Project Books*

Playmaking: Children Writing and  
Performing Their Own Plays  
by Daniel Judah Sklar **\$14.00**

52 Pick Up: A Practical Guide to Doing Theater  
with Children  
A HOW TO guide by Willie Reale with Playmaking  
lesson plans by Daniel Judah Sklar **\$35.00**



**CELEBRITY SQUARES**  
**The 52nd Street Project's**  
**15th Anniversary Gala**

**MONDAY, MAY 6, 1996**

At the Copacabana

**CHAIRPERSON**  
 Wendy Ettinger

**ARTISTIC DIRECTOR**  
 Willie Reale

**EXECUTIVE DIRECTOR**  
 Carol Ochs

**CELEBRITY SQUARES**

**Honorary Chairs**

Angela Bassett Jimmy Smits

**Co-Chairs**

Lisa Benavides Louis P. Friedman  
 Becky Browder Patrice Friedman  
 Rachel Chanoff Karin Schall

Laura Valeroso



**The 52nd Street Project**  
**Board of Directors**

Ben Barenholtz James McDaniel  
 Lisa Benavides Frances McDormand  
 Rachel Chanoff Patricia M. Murphy  
 Wendy Ettinger, Chairperson Carol Ochs  
 Louis P. Friedman Willie Reale  
 Stephen Graham Pamela Tyson  
 Larry Jones Laura Valeroso  
 Heidi Landesman Elizabeth Williams



**The 52nd Street Project**  
**gratefully acknowledges**

Stephanie Berger  
 Iris A. Brown  
 Bernhardt Fudyma Design Group  
 Ron Kastner, Capital Printing  
 Kobrand  
 Masque Sound  
 Neal Mazzella, Hudson Scenic  
 Nickelodeon  
 The Printing Store  
 Revlon  
 Scholastic Productions and Scholastic, Inc.  
 John A. Vassilaros & Sons  
 Watkins Products, since 1868



for their generous donations of products and services to Celebrity Squares



**CELEBRITY SQUARES**

**Cast**

In order of appearance

Announcer ..... Kevin O'Rourke  
 Host ..... Lewis Black  
 Contestant #1 ..... Victor Garber  
 Contestant #2 ..... Thomas Santoni  
 Spokesmodel ..... Mary Yamvoukakis

**The Celebrities**

Jill Barbosa, David Dominique, Barbara Feldon,  
 Cordell Horsford, James McDaniel,  
 Frances McDormand, Zsuzsa Mysak, Marcsi Mysak,  
 Kate Nelligan, Jose Soto



**Directed by**

Mark Linn-Baker



**Music by**

Henry Krieger

**Lyrics by**

Willie Reale

*"The Pencil Song" and "This is My Moment"*



**Book by**

Michael Bernard, Lewis Black,  
 Willy Holtzman, Willie Reale and Max Wilk



**Musical Director**

Henry Krieger



**The Three-In-A-Row Band**

Joe Pasarro, Drums  
 Tim Ray, Piano  
 Doug Romoff, Bass  
 Judy Kuhn, Guest Vocals  
 Karen Trott, Guest Vocals



## Center Squares

Arthur Dantchik\*  
Cathy and Stephen Graham\*

## Secret Squares

Blaise R. Box, Staging & Design Inc.\*  
Donaldson, Luffin & Jenrette  
Wendy Ettinger & Derek McLane\*  
Louis P. Friedman & Patrice Friedman\*  
Greg MacPherson\*  
Jane Muddyman & Jonathan Heine\*

Bill Muddyman\*  
Peter J. Phillips, Lloyds Bank Plc.\*  
John A. Vassiaros &  
Alexandra Gersten\*  
Joanne Woodward  
Janine & Jeffrey Yass

## Corner Squares

Eleanor Bergstein  
Barry & Myrna Bernard\*  
Elizabeth Velazquez Bernstein &  
Alexander Bernstein\*  
Katherine Borowitz & John Torturo\*  
Cristina Botta & James Singleton  
Samuel & Bertha Britt  
Eric Brooks  
Deborah Brown\*  
Kate Burton & Michael Ritchie\*  
Dick & Lisa Cashin  
Stockard Channing\*  
Glenda Chesslar  
Peter & Judith Dawkins\*  
Donna & William DeSeta  
Barbara Eilan  
Richard A. Hadar &  
Marlaine Deppe  
Peter Herdrick & Karen Trott\*  
Jane Hoffman\*  
M. Lynne Johnson\*  
Larry Jones & Mary McElrath-Jones\*  
Betty & George Kaiser  
Eric Karpeles & Mike Sell\*  
Beth & Seth Klamman  
Mary Koop  
Heidi Landesman\*  
Robert Sean Leonard\*

Liza Lerner  
John Bedford Lloyd & Anne Twomey\*  
Max Mayer  
Frances McDormand & Joel Coen\*  
MCI Foundation  
Brian Hertes & Jackie Reingold\*  
Steve Olsen\*  
Kevin O'Rourke & Edith Thurber\*  
Chuck & Jean Pease  
Elizabeth & Alton E. Peters  
Susan & Robert Phillips\*  
Christopher Randolph\*  
Todd Richter  
Betsy & Clifford Ross\*  
Stefan M. Selig  
Meg Simon  
Jay Tarses  
Adriana Tripani &  
Tim Stephenson\*  
Uniwold Group, Inc.  
Paul H. Valley  
Wendy vanden Heuvel  
Susan J. Vitucci\*  
Emily Wachtel  
Bob Weiner  
Elizabeth Williams & Joseph Forte\*  
Matt Williams  
Jim & Mary Lin Yoshimura

## Contestants

Wendy Abrams  
Joe Alexander  
Brooke Allen  
Sue Atkins & Eben Shapiro  
Jane Ballinger & Michael Goldstein\*  
Larry & Phyllis Bangser  
Stephanie Barber & Arthur Collins  
Ben Barenholtz\*  
Terry Belanger  
Lisa Benavides & Tim Nelson\*  
Pamela S. Berlin & William Garden\*

Jane Binney  
André Bishop\*  
Ron & Susan Black\*  
Audrey Bloch & Joseph Wiesenthal  
Stuart Bloomberg & Mary Farrell  
Robi & Ruth Blumberg  
Sally Bock & Mark Wurfel  
Mark Bramble  
Becky Browder & Ted Neustadt\*  
Susan Bruce & Peter Hedges  
Cora Caban & Bernard Gersten\*

Steve C. Callahan & Christine M. Dunn  
Louisa Campbell & Sven Travis  
Rachel Channoff\*  
Maresa Chibas & Travis Preston\*  
Ethan Coen & Trish Cooke\*  
Ruth Cohen\*  
Richard J. Colin  
Thomas Cott\*  
Eileen Cowel & David Sennett\*  
Margaret Crummins & Pierce Rafferty  
Nadia Dajani  
Gpa & Mishla Dichter  
Tom Dougherty  
Stephen J. Dubner\*  
Karen Dunn  
Mario Eguzi  
Allison Ellwood  
Beth Emelson\*  
Barbara Ettinger  
Elizabeth Eynon  
Adam Felber & Jeanne Simpson  
Peter Jay Fernandez & Denise B. Bourse  
Dr. & Mr. Irwin Fesch  
Tom Fontana  
Kermit Frazier  
Amy Friedman  
Charles Fuller  
Rose Gasner & Larry Chertoff  
Gary Gersh  
Simma Gershenson\*  
Jenny C. Gersten\*  
Ileen Getz & Mark Grinnell  
Noah & Cynthia Gilson  
Susan Goldstein  
Tony Goldwyn & Jane Mosky  
Emily Grishman & Susan Sampliner\*  
Lisa J. Guggenheim\*  
Dolly Hall  
Emma & Stephen Walton\*  
Evan Handler  
Marcia Gay Harden\*  
Barnaby Harris  
Eugenia Harvey  
Paul Heimann & Charlotte Elfrtson\*  
John Hoffman  
Willy Holtzman & Sylvia Shepard\*  
George Homig  
Sarah Horowitz\*  
Barbara Howard  
Michelle Hurst  
Annette Insdorf & Mark Ethan  
Cecile Insdorf  
Amanda Jacobs & Gary Wolf

Mark Evan Jacobs\*  
Peter Jacobson  
Allison Jannoy  
Linda LeRoy Janklow  
Hope Jessup  
Andrea L. Johnson  
Susan Jones  
Cherry Jones  
Marcy & Max Kalin  
Lee Kalcheim  
Karen Kandel  
Darlene Kaplan & Steve Zuckerman  
Lucy Kaplan & John Cavello  
Sheila Kehoe  
Jeremy Koch/Sound One Corp.  
Henry Krieger & Robert Joy\*  
Judy Kohn & David Schwab\*  
Dr. Jonathan LaPook & Kate Lear  
Thomas LaPuppet  
Jill Larson\*  
Warren Leight  
Dell Lemmon  
Mimi Livingston  
Bruce MacVittie\*  
Peter J. Manning\*  
Kay Matschullat & Alan Arffa\*  
George J. Mavronicolas  
Mary McCormack  
Tucker McGrady & Laura Guerra  
Barbara McCrane & Paul Reale\*  
Andy Millon  
Walter Mosley\*  
Michaela Murphy & Larry Nathanson\*  
Patricia M. Murphy & Adam Spilka\*  
Kate Nelligan & Robert Reale\*  
Rona & Randy Nelson  
Jim Neuberger & Helen Stambler  
Jacki Ochs & Jan Kroeze\*  
Mr. & Mrs. Bill Plesky  
Neil Pepe & Mary McCann  
Thom Peters  
Oliver Platt & Camilla Campbell\*  
Nicholas Platt & Robyn Watts  
Toby Poser  
Adam Reingold  
Eric Ritter  
Daryl Roth  
Janice Rous  
Richard Rubenstein  
Wade Rusco, Inc.  
Christopher Ryan  
Lana Sametz  
Tim Sanford & Lisa Finstrom\*

Sauce Entertainment  
Annie Sawyer  
Karin & Tom Schall\*  
Man Scofield  
Joan Scott  
Seret Scott\*  
Dana Segal  
Mitchell R. Semel & Colleen C. Carroll  
Jacqueline & Pierre Simon  
Barry Singer  
John Slattery  
Lois Smith  
Abigail Solomon  
John Steber\*  
Robert B. Stecker  
Daniel Sweet\*  
Susan & Stephen Symons  
Lili Taylor\*  
Mary Lou Teel & Peter Fremdlich

Crystal Thompson  
Jacqueline & Rutherford Thompson  
Tracy Thorne & Edmund Lewis  
Liz Tuicillo  
Joseph Vadopoulos &  
Jane Sangerman  
Laura Valeroso & David Seidman\*  
Lisa Vanonde  
Mark Victor  
Joseph Vitale & Katherine Lumb  
Brian Walls  
Mary Pat Walsh\*  
Elizabeth Warner  
Jake Weber & Nora Ariffin  
Steve Westimer & Jane Bolster  
Susan Willerman  
May Worrich & Marc Jaffe  
Neil Yoskin

as of 5/3/96



## Production Staff for Celebrity Squares

Derek McLane, Set Design  
Greg MacPherson, Lighting Design  
Tom Morse, Sound Design  
Crystal Thompson, Costume Design  
Hank Meiman, Stage Manager

## The 52nd Street Project Staff

Willie Reale, Artistic Director  
Carol Ochs, Executive Director  
Michael Bernard, Associate Artistic Director  
Sally Bock, Director of Development and Marketing  
George R. Babiak, Production Manager  
Susan J. Vitucci, Development Consultant  
Iris A. Brown, Staff Graphic Designer  
Meredith Beowkes and Sarah Makris, Interns



## Special Thanks

Evan Bernard, Beth Emelson, Simma Gershenson, Jenny Gersten, Nancy Giles,  
Mark Hooper, Joy Kilpatrick, Barbara McCrane, Eris Mighorini, Diana Rojas,  
Victor Rojas, Vanessa Valdes, Mary Pat Walsh, Sharon Washington, Mark Wurfel  
and all the incredible volunteers who helped with our mailing.

Program Design: Iris A. Brown

\* denotes benefit committee member

The 52nd Street Project gratefully acknowledges the support of the following foundations and organizations: Akiba Wilton Foundation; The Billie Platz Charitable Edition; The Diamond's Gift Fund; Wilson and Mary Green Foundation; The Maxine W. Goldstein Foundation; Highty Park Inc.; The Hennessey Foundation; The Hillier Lodge Foundation; Mr. Mo. J. and Dorcas H. Yaffe Foundation; Liberty Bank; The M.G. J. Trust; M.J. Foundation; James A. Macdonald Foundation; Mrs. M. Martin Foundation; The Morgan Stanley Foundation; The New York Times Co. Foundation; Liza's Park Foundation; Cal and Jay H. Rosenfeld Foundation; Dr. R.M. Green, Steven and Phyllis; Dr. John and Janet Stein Foundation; The Student Foundation; Gundersen; The Wilson; Dr. Thomas Foundation; Howard Group Inc.; John A. Woodland & Sons Inc.; Warrick L. Latta, Rosen & Katz; The Arthur Weisberg Fund; Woodland Park; Wilson & Green; in addition, the following individuals made gifts in excess of \$100 to the 52nd Street Project this year:

- |  |  |  |  |
|--|--|--|--|
| <p>Neeraj Agrawal<br/>Jan Alexander<br/>Brooks Allen<br/>John Ang<br/>Amy Aronoff &amp; McGinnis Murray<br/>Ann Aronoff &amp; Ray Matcovitch<br/>Rosa Aronoff &amp; John Wilson<br/>Susan Aronoff &amp; Dan Shapiro<br/>Joan Salvaggio &amp;<br/>Michael Goldberg<br/>Marilyn Davis &amp; David Green<br/>Ben. Kandelman<br/>Janice Gorman<br/>Liz Rosenberg &amp; Ted Nelson<br/>Doris Berger<br/>Debbie Bergman<br/>Frances Marks &amp; William Lavender<br/>Barry &amp; Maria Diamond<br/>Alexandra Hirschen &amp;<br/>Elizabeth Weinstein<br/>Ruth &amp; Susan Stahl<br/>Judith Weiss &amp;<br/>Joseph Weinstein<br/>Scott Weinstein &amp; Mary Farrell<br/>Rita &amp; Jack Weinstein<br/>Leah Dwyer &amp; James Weintraub<br/>William Weinstein &amp;<br/>John Terrence<br/>Candice Rabin Shapiro<br/>Barbara &amp; Leonard Roth<br/>Ted Strick<br/>Betty Steiner &amp; Ted Neustadt<br/>Dorothy Stein<br/>Ruth &amp; T.J. Steiner<br/>Susan Stone &amp; Peter Hochstetler<br/>Dennis Stone &amp;<br/>Peter Jay Terunuma<br/>Kari Burton &amp; Michael Hirsch<br/>Cora Cohen &amp; Leonard Gorman<br/>Daniel &amp; Margaret Cahill<br/>Steven Corbett &amp;<br/>Christine Davis<br/>Carole Campbell &amp; Oscar Platt<br/>Linda Campbell<br/>Oliver, Carol &amp; Maxwell Carmel<br/>Richard &amp; Lisa Carter<br/>Ann Casella &amp; Jerry Kaplan<br/>James Cohen<br/>Richard Channing<br/>Rachel Chisoff<br/>Vera Chisoff<br/>Levy Chisoff &amp; M. Rose Gorman<br/>Gloria Chisoff<br/>Miriam Chisoff &amp;<br/>Tracy Chisoff<br/>William Chisoff<br/>Jan Chisoff &amp; Nancy Ferman<br/>Ellen Cain &amp; Tom Dwyer<br/>Joel Cain &amp; Fred M. Diamond<br/>Boris Cahan</p> | <p>Ruth Cohen<br/>Suzanne Comstock<br/>Thomas Cook<br/>Margaret Crommel &amp;<br/>Paige Walling<br/>Joan Green Collins<br/>Ruth Cohen<br/>Betty Dwyer<br/>Cathy Dwyer<br/>Judith &amp; Peter Dwyer<br/>George &amp; William Dwyer<br/>Michelle Green &amp; Richard Haber<br/>Debra &amp; William Tordella<br/>Cathy &amp; Misha Dwyer<br/>Joan Dwyer &amp;<br/>Joan Whitman<br/>Stephen Dwyer<br/>John &amp; Joan Dwyer<br/>Suzanne &amp; Mark Singer<br/>Amy Dwyer-Bowling<br/>Neal Dwyer<br/>Barbara Eilat<br/>Charlotte Dwyer &amp;<br/>Faye Hirschen<br/>Barbara Singer<br/>Rebecca Singer &amp; David Hill and<br/>Robert Finkel &amp; Jennifer Strasser<br/>Joan Dwyer &amp; Ted Dwyer<br/>Ruth &amp; David Park<br/>Tom Finkler &amp; Susan Green<br/>David Finkel<br/>Karin Finkel<br/>Peter Finkelshteyn &amp; Mimi Lutz Fink<br/>Amy Finkler<br/>Lynn &amp; Yehuda Finkler<br/>Pam Finkler &amp; Yehuda Finkler<br/>Joseph Finkler<br/>Gary Gersh<br/>Dennis Goldwasser<br/>Jerry Gorman<br/>Sam Gold &amp; Mimi Gorman<br/>Thelma Gorman<br/>Michael Gorf<br/>Emily Goldstein &amp;<br/>Susan Gorman<br/>Edward Lewis Gorman &amp;<br/>Terry Gorman<br/>Lynn Gorman &amp; Thelma McCarty<br/>Lynn Gorman<br/>Albert Gorman<br/>Andrew Gorn<br/>Stephen Gorman &amp;<br/>Terry Gorman<br/>Marilyn Gorman<br/>Elizabeth Gorn<br/>Peter Gorman &amp; Susan Gorn<br/>Joan Gorman<br/>William Gorman &amp;<br/>T. Tracy Gorman<br/>Gloria Gorman</p> | <p>Michelle Hovav<br/>Annette Jacobson &amp;<br/>Mark &amp; Ruth Jacobson<br/>Ruth Jacobson<br/>Ty Jacobson<br/>Marcy Joffe &amp; May Wulfovich<br/>Linda Jacobson<br/>M. Lynn Johnson<br/>Tilly Jones &amp;<br/>Mary M.E. Johnson<br/>Nathan Joseph<br/>Michelle &amp; Max Kahn<br/>Ruth &amp; George Kaiser<br/>Lori Kalkstein &amp; John Lutz<br/>Marlene Kaplan<br/>Eric Karpman &amp; Mimi Tal<br/>Sharon Kaplan<br/>Mark Karpman &amp;<br/>Wendy Karpman<br/>Anna &amp; Mark Karpman<br/>Dale &amp; Joan Karpman<br/>Jennifer Kutz<br/>Mary Kutz<br/>Jan Kuzin &amp; Joan Kelly<br/>Della &amp; Roger Kuzin<br/>Judy Kuzin &amp; David Green<br/>Paul Kuzmanov<br/>All Lerner<br/>Judith Lerner<br/>Frank Jack Leger<br/>Robert David Leonard<br/>Liz Lerner<br/>John Leonard Lloyd &amp;<br/>Arlene Lerner<br/>Hollander Lerner &amp; Jan White<br/>Mary Lerner &amp; Neil Pearl<br/>Marisa &amp; Peter Lerner<br/>Oleg MacPheer<br/>Heidi MacPheer<br/>Peter Manning<br/>George Marmorstein<br/>Max Mann<br/>Barbara McCraw &amp; Fred Rosen<br/>Paul McCraw<br/>Rosa Morris &amp; Julie Humpal<br/>Judy Miller<br/>Walter Murray<br/>M. &amp; Joan Murgenson<br/>Patricia Murphy &amp; Adam Taylor<br/>Edward Nathan<br/>Kathleen &amp; Robert Neale<br/>Randy &amp; Ruth Neale<br/>Paul Neale<br/>Helen &amp; James Neuberger<br/>Barbara Neuberger<br/>Ellen Neuberger<br/>Carmel<br/>Suzanne<br/>Rosalie O'Rourke &amp; E. Bill Thaler<br/>Charles &amp; Joan Mann Treiser</p> | <p>HR &amp; Juana Perdy<br/>John &amp; Elizabeth Peretz<br/>Thomas Pines<br/>Loren Phillips<br/>Robert &amp; Susan Cotto-Polner<br/>Richard Platt &amp; Robert Webb<br/>Dennis Plummer &amp;<br/>Sally Platt<br/>Christopher Rabinovic<br/>Helen &amp; Peter Rabinovic<br/>Vivian &amp; Lynn Rabinovic<br/>Willy Rabin<br/>Adam Rabinoff<br/>Joseph Rabin<br/>Fred Rabin<br/>The Rabin<br/>Teresa Rabinovich<br/>Rita &amp; Susan Price<br/>Sally &amp; Clifford Price<br/>Joan Rappaport &amp;<br/>Joseph Rappaport<br/>Ruth &amp; Tom Reich<br/>Joan Reichel<br/>David Regel<br/>Diane Gelfand<br/>Tudor Sherry<br/>Jacqueline Sherr<br/>Miguel Sherr<br/>John Shilley<br/>Lisa Sherr<br/>Suzanne Sherrman<br/>Renee Sherr<br/>Joan Sherr<br/>Tara Sherrman &amp;<br/>Arthur Shapiro<br/>David Sherr<br/>Joe Sherr<br/>Catherine Thomas<br/>Fig. Thompson<br/>Joan Weil &amp; John Thorne<br/>Lynn Weissman<br/>Paul Weiss<br/>Wendy Weissman Hovav<br/>John Weissman<br/>Susan Weissman<br/>Emily Weisler<br/>Elizabeth Weissman<br/>Ruth Weissman<br/>Robert Weissman<br/>Barbara &amp; Max Weis<br/>Elizabeth Williams &amp;<br/>Joseph Fort<br/>Max Wilentz<br/>Susan Wilson<br/>David Woodberg<br/>Susan Woodberg<br/>James &amp; Jeffrey Yarn<br/>James &amp; Mary L. Yarnowski<br/>Max Yarn</p> |
|--|--|--|--|

To make your little gift of love last, by which we mean to last well enough, we give you coupons, and a list of useful books.

The 52nd Street Project Presents

# PLAYING WITH FIRE

THE BLOCK ISLAND EDITION!



The Harold and Mimi Steinberg Charitable Trust  
1996 One-on-Ones  
The Ensemble Studio Theater, New York City

July 25 and 26 at 7:30 p.m.  
July 27 at 3:00 and 7:30 p.m.  
July 28 at 3:00 p.m.

# PLAYING WITH FIRE



The 52nd Street Project Presents  
The Harold and Mimi Steinberg  
Charitable Trust  
1996 One-on-Ones

July 25, 26, 27, and 28, 1996  
The Ensemble Studio Theater,  
New York City

## Project Staff

Willie Reale, Artistic Director  
Carol Ochs, Executive Director  
Michael Bernard, Associate Artistic Director  
Sally Bock, Director of Development and Marketing  
George R. Babiak, Production Manager  
Susan J. Vitucci, Development Consultant  
Iris A. Brown, Graphic Designer  
Kischa Miller, Nora Rose - Interns  
Kulondi Frier, Victor Rojas, Brooke and Alexis Frye - Junior Counselors

## Production Staff

Rusty Magee, Music Director  
Kevin Joseph Roach, Set Designer  
Greg MacPherson, Lighting Designer  
Crystal Thompson, Costume Designer  
Noël Dawkins, Stage Manager  
Vanessa Valdes, Sound Designer  
Slide Design  
Angela Dundee, Sharon Scotland,  
Kevin Sibley, Alberta Testanero,  
John Steward, Renato Castilho,  
Tiana Manfred, Eric Quo,  
Katherine Lumb  
Gregor Halenda, Slide Photographer  
Scott Ramsay, Props Design  
Michele Mayas, Colorforms Design  
Flyer/Program illustration by Mike Sell  
Deneka Peniston, Slide Operator  
Production Assistant, Beth Janson  
Furniture Crew  
Tassos Pappas, Kulondi Frier

Props Crew  
Jilly Crook, Victor Rojas  
Colorforms Crew  
Kimberly Kelly Wilson,  
Beth Janson, Jill Barbosa  
Load-in and Light Hang Crew  
Beth Janson, Brian O'Neill,  
Christopher Quinn, Nora Rose,  
Tassos Pappas, Paul Tavumini,  
Joe White  
House Managers  
Mary Pat Walsh,  
Kann Schall  
House Crew  
Beth Emelson, Ileen Getz,  
Nancy Giles, Ray Harold,  
Chefs  
Martha Velle-Gass,  
Pat McQuade,  
Vanessa Valdes

The One-on-One Program is made possible, in part, by public funds from the New York State Council on the Arts, the Department of Youth Services, and the New York City Department of Cultural Affairs.

The 52nd Street Project is a non-profit organization that brings inner-city children from the Clinton neighborhood together with professional theater artists to create theater. PLAYING WITH FIRE is a production of our One-on-One program, which is designed to give children the opportunity to go away for one-week stays in the country and enjoy the undivided attention of a professional theater artist who serves as friend, mentor, and role model.

## Board of Directors

Ben Barenholtz	Lisa Benavides
Rachel Chanoff	Wendy Ettinger, Chair
Louis P. Friedman	Stephen Graham
Larry Jones	Heidi Landesman
James McDaniel	Frances McDormand
Patricia M. Murphy, Esq.	Carol Ochs
Willie Reale	Pamala Tyson
Laura Valeroso	Elizabeth Williams

## Special Thanks To:

Curt, Abigail, and The Ensemble Studio Theatre, Dr. Cristina Biaggi, Pat, Aidan and Noah Walsh, Virginia Dare and Joya Verde, The Host Families: the Blakes, the Drapers, Martha Velle-Gass and Pat McQuade, the Taubmans, the Tierneys, Lyn Reale, George, Natalie, Shayna and Block Island Realty, Ann Hall, Rachel Interstate Navigation, McQuade's Market, Hunter Tracy, Bill Bendokas at New England Airlines, Prudy and the Ice Cream Place, Jimmy Reale, Bob Reale, Ray Keogh and St. Andrew's Parish, Tracy and Sean, Aunt Gail, and The Depot.

## In-Kind Contributions:

Ensemble Studio Theatre, Neil A. Mazzeffa & Hudson Scenic Studios, Inc., David Shedd and Fairway Market, Colorforms, Baron & Baron, Shays & Murphy, Iris A. Brown & Bernhardt/Fudyma Design Group, Ron Kasner, Capital Printing, The Estate of Jonathan Larson, Intuit, Masque Sound, Nickelodeon, The Printing Store, New Dramatists, Playwrights Horizons, Steve Olsen & The West Bank Cafe, Lincoln Center Theater, Materials for the Arts, Rain Restaurant, Port Authority, Mayor's Office of Film & Television, John A. Vassilaros & Son, Paris Chocolates, Scholastic Productions, Yorke Construction, Jomen Electrica, Revlon, Watkins Products, Tom Reale, Eric Karpeles & Mike Sell, Mario Egozzi, Andy Millon, Dr. Cristina Biaggi, Stephen Graham, Emily Grishman, Mark Keoppen, Kevin Joseph Roach, Stephanie Berger.

Once burned, twice shy? Naaaaaaaah! Get ready for...

# PLAYING WITH FIRE



## THE TYLER HILL, PA. EDITION!

In August, we'll be taking eleven kids to Tyler Hill, Pennsylvania for a week to create another evening of plays based on the same theme seen in tonight's show. All new plays, all new songs, all new kids, and some old adults. Be brave! Join us!

August 22 and 23 at 7:30 p.m.  
August 24 at 3:00 and 7:30 p.m.  
August 25 at 3:00 p.m.

Call 642-5052 for reservations

## PLAYING WITH FIRE: ACT I

All music composed by Rusty Magee

The Playing with Fire Theme Song - The Company. Lyrics by Willie Reale

### High Wire Act

Written by Russ Lees for Tanika Parsons, age 11. Directed by Dion Graham.

Ringmaster ..... Tanika Parsons

Sam ..... Dion Graham

"High Wire Act" lyrics by Russ Lees

### ID5

Written and directed by Thomas Babe for Jonathan Brown, age 10.

Newsman ..... Willie Reale

I.I. Jones ..... Jonathan Brown

Native Guide ..... Kulondi Frier

Velocipede Raptor ..... Thomas Babe

"I Be Bad" lyrics by Thom Babe

### Jester Minute

Written and directed by Michael Bernard for Rufus Read, age 10.

Gigliano ..... Michael Bernard

Hiram ..... Rufus Read

The King ..... Victor Rojas

William Shakespeare ..... Thom Babe

"Hey Nonny No" and "The Message" lyrics by Michael Bernard

### Why Spy?

Written and directed by George Babiak for Alex Cooper, age 9.

Patience Wayning ..... Allison Eikerenkoetter

Secret Agent Alex Cooper ..... Alex Cooper

Dr. Korrupto ..... George Babiak

"Why Do I Try to Be a Spy" and "Get The Facts" lyrics by George Babiak

### Keeper of the Flame

Written by Alison Fraser and Rusty Magee for Candy Godoy, age 11.

Directed by Alison Fraser

Zelda ..... Alison Fraser

Madame Zorina ..... Candy Godoy

Pizza Man ..... Nat Magee

"Look into My Flame," "I'm a Fake," "I See a Man," and

"Wicked Good Wicks" lyrics by Rusty Magee

☞ INTERMISSION ☜

## ACT 2

### Melvin at the Midway

Written by Donald Rothschild for Jason Prieto, age 13.

Directed by Joe White

Man ..... Joe White

Melvin ..... Jason Prieto

"It's Your Soul" lyrics by Donald Rothschild

### Buddies

Written by Susan Kim for Osage Lewis, age 9.

Directed by Robert Jimenez

Turk Maverick ..... Osage Lewis

Clem Ratt ..... Robert Jimenez

"Action Movie Treatment" lyrics by Willie Reale

### The Other

Written and directed by Lili Taylor for Marcsi Mysak, age 10.

Dr. Wise One ..... Lili Taylor

Delila Davenport ..... Marcsi Mysak

Frank the Stage Manager ..... Willie Reale

The Other ..... Lili Taylor

"Delila's Lament," and "The Power of Me" lyrics by Willie Reale

### The Most Dangerous Play You Will See This Evening (Or Maybe Ever)

Written and directed by Willie Reale for Jonathan Santiago, age 13.

Himself ..... Jonathan Santiago

Himself ..... Willie Reale

"Let's Make It Up As We Go Along" lyrics by Willie Reale

### Alexandra the Greatest

Written by Cindy Lou Johnson for Charina Corbett, age 9.

Directed by Cecilia Arana

Narrator ..... Thomas Babe

Aristophanetta ..... Cecilia Arana

Alexandra ..... Charina Corbett

"Feels Great to be Good" lyrics by Cindy Lou Johnson



Thank you for coming to PLAYING WITH FIRE. If you are not on our mailing list (or if your address has changed), please fill out this form and give it to us on your way out or mail it to the address below. We would also like to know if you are interested in becoming a volunteer. We are always in need of help in *all areas*, so please fill out your name and phone number, and we'll call you.

#### PLEASE ADD ME TO YOUR MAILING LIST:

NAME \_\_\_\_\_

ADDRESS \_\_\_\_\_

ZIP \_\_\_\_\_

PHONE \_\_\_\_\_

#### YES, I WOULD LIKE TO BE OF HELP:

NAME \_\_\_\_\_

DAYTIME PHONE \_\_\_\_\_

I AM REALLY USEFUL AT (52nd Street Project related things only. Examples: Mailings, backstage help, fundraising, moving heavy items, etc.)...

If you would like to mail this (and you're always welcome to enclose a tax-deductible contribution), you can send it to:  
The 52nd Street Project 500 West 52nd St. New York, NY 10019  
(212) 333-5252

## ON SALE IN THE LOBBY

**Cool Stuff**

The Fabulous Flyer Bar  
(in five mouth-watering flavors!)  
**\$2.00 and \$1.50. \$1.00 for kids**

52nd Street Project T-Shirts  
with Shel Silverstein's logo  
**\$12.00**

52nd Street Project Caps  
**\$15.00**

**52nd Street  
Project Books**

Playmaking: Children Writing and  
Performing Their Own Plays  
by Daniel Judah Sklar **\$14.00**

52 Pick Up: A Practical Guide to  
Doing Theater with Children  
A HOW TO guide by Willie Reale with Playmaking  
lesson plans by Daniel Judah Sklar **\$35.00**



The 52nd Street Project gratefully acknowledges the support of the following foundations and corporations: Barker Welfare Foundation, The BETA Fund, Consolidated Edison, The Dramatists Guild Fund, William and Mary Greve Foundation, The Horace W. Goldsmith Foundation, Heights Partners, Inc., The Hennessy Foundation, The Holland Lodge Foundation, Inc., Rita J. and Stanley H. Kaplan Foundation, Lloyds Bank, The M & T Trust, MCJ Foundation, James A. Macdonald Foundation, Ann M. Marlin Foundation, The Morgan Stanley Foundation, The New York Times Co. Fdn., Northwest Point, Laura Pels Foundation, Carl and Lily Pforzheimer Foundation, Inc., RJM Group, Staging and Design, Inc., Jules and Doris Stein Foundation, The Sordna Foundation, Susquehanna, Time Warner, Inc., Travelers Foundation, Uniworld Group Inc., John A. Vassilacis & Sons, Inc., Wickel, Lipton, Rosen & Katz, Lila Acheson Wallace Funds, West Bank Cafe, Writers & Artists. In addition, the following individuals made gifts of over \$150 to The 52nd Street Project this year:

Wendy Abrams	Joel Coen & Fran McDermid	William Holtzman &	Steve Olsen
Jace Alexander	Barry Cohen	S. Sylvia Shepard	Kevin O'Rourke & Edith Thurber
Brooke Allen	Ruth Cohen	Barbara Howard	Charles & Jean Marie Pease
Julie Ang	Joanne Comerford	Michelle Hurst	Bill & Joanna Persky
Amy Aquino & McGinnis McCoy	Thomas Cott	Annette Isendorf &	Alton & Elizabeth Peters
Alan Arfa & Kay Matschullat	Margaret Crimmins &	Mark Ethan Toponek	Thomas Peters
Nora Arfien & Jake Weber	Pierce Rafferty	Richie Jackson	Ethan Phillips
Susan Atkins & Eben Shapiro	Joan Straus Cuffman	Sy Jacobs	Robert & Susan Ochs Phillips
Jane Ballinger &	Nadia Dajani	Marc Jaffe & May Wulfrich	Nicholas Platt & Roxye Watts
Michael Goldstein	Arthur Dantchik	Linda Janikow	Donna Plummes & Todd Richter
Martha Barata & David Turner	Cathy Dantchik	M. Lynne Johnson	Christopher Randolph
Ben Barenholtz	Judith & Peter Dawkins	Larry Jones &	Helen & Peter Randolph
Jessica Bauman	Georgia & William Delero	Mary McEhrath-Jones	Tim Ray & Tyson Smith-Ray
Lisa Benavides & Tim Nelson	Martina Deppa & Richard Hadar	Nathan Joseph	Wille Razole
Emily Bentin	Donna & William DeSeta	Marcelita & Max Kahn	Adam Reingold
Eleanor Bergstein	Cipa & Misha Dichter	Betty & George Kaiser	Jonathan Reiss
Pamela Berlin & William Carden	Jose Dominguez &	Lee Kaldheim & Julia Lord	Todd Richter
Barry & Myrna Bernard	Lisa Waldman	Maurice Kanbar	Eric Ritter
Alexander Bernstein &	Stephen Dubner	Eric Karpeles & Mike Sell	Tyffraest Robertson
Elizabeth Velazquez	Jack & June Dunbar	Sheila Kehoe	Elhu & Susan Rose
Ron & Susan Black	Darcy Dunn & Mark Singer	Mark Keoppan &	Betsy & Clifford Ross
Audrey Blich &	Amy Dzielonkowska	Wendy Townsend	Jane Sangerman &
Joseph Wiesenhal	Ned Eisenberg	Ania & Mark Kingdon	Joseph Vedapalas
Stuart Bloomberg & Mary Farrell	Barbara Eiran	Beth & Seth Klamman	Karin & Tom Schall
Robi & Ruth Blumenstein	Charlotte Elertson &	Jeremy Koch	Steve Scholoff
Sally Bock & Mark Wurke	Paul Hejman	Mary Kong	Dana Segal
Jane Bolster & Steve Werdmer	Barbara Ettinger	Jan Kroeze & Jacki Ochs	Stefan Selig
Katherine Borowitz &	Wendy Ettinger & Derek McLane	Belle & Roger Kuhn	Timothy Sherry
John Turturo	Adam Felber & Jeanne Simpson	Judy Kuhn & David Schwab	Jacqueline Simon
Christina Butta Singleton	Lisa Finstrom & Tim Sanford	Heidi Landesman	Meg Simon
Bertha & Samuel Britt	Inwin & Sonra Fiach	Jill Larson	John Slattery
Eric Brooks	Tom Fontana & Sagan Lewis	Joshua Lehrer	Lois Smith
Becky Browder & Ted Neustadt	David Frankel	Sarah Jane Leigh	Abigail Solomon
Deborah Brown	Kermit Frazier	Robert Sean Leonard	Warren Spector
Beck & P.J. Brown	Peter Freundlich & Mary Lou Teel	Liza Lerner	Jean Stein
Susan Bruce & Peter Hedges	Amy Friedman	John Bedford Lloyd &	Tim Stephenson & Adriana Tripani
Denise Burse &	Louis & Patrice Friedman	Anne Twomey	Daniel Swee
Peter Jay Fernandez	Peter Fritschel & Pamela Nelson	Katherine Lumb & Joe Vitale	Jay Taras
Kate Burton & Michael Ritchie	Joseph Gazzak	Mary McCann & Neil Pepe	Cathlene Thomas
Cora Cahlan & Bernard Gersten	Gary Gersh	Marsue & Peter MacNicol	Kip Thompson
Daniel & Maureen Cahill	Sirma Gershenson	Greg MacPherson	Joan Vail & John Thome
Steven Callahan &	Jenny Gersten	Bruce MacVitie	Laura Valerico
Christine Dunn	Ileen Getz & Mark Grinnell	Peter Manning	Paul Valley
Camilla Campbell & Oliver Platt	Stephen Graham	George Mavronicolas	Wendy vanden Heuvel
Louisa Campbell	Michael Greif	Max Mayer	John Vassilarios
Colleen Carroll & Mitchell Semel	Emily Gristman &	Barbara McCrane & Paul Reule	Susan Vitucci
Richard & Lisa Cashin	Susan Sampler	Paul McCrane	Emily Wachtel
John Cavello & Lucy Kaplan	Edmund Lewis Grossman &	Brian Merles & Jackie Reingold	Elizabeth Warner
James Cayne	Tracy Thorne	Andy Milton	Sally Weiss
Stockard Channing	Laura Guerra & Tucker McCrady	Walter Mosley	Robert Wiener
Rachel Charoff	Liza Gugenheim	Bill & Jane Muddymann	Barbara & Max Wilk
Peter Cherasia	Albert Gurney	Patricia Murphy & Adam Spilka	Elizabeth Williams &
Larry Cherbil & M. Rose Gasner	Andrew Haas	Edward Nashen	Joseph Forte
Glenda Cheskie	Bill & Linda Halvorsen	Kate Neffigan & Robert Reule	Matt Williams
Marissa Chbas &	Stephen Hamilton &	Randy & Rona Nelson	Valerie Wilson
Travis Preston	Emma Walton	Ruth Nelson	Donald Windham
William Christian	Marcia Gay Harden	Helen & James Neuberger	Joanne Woodward
Joe Christiano & Rande Goodwin	Barnaby Harris	Renee Neuwald	Janine & Jeffrey Yass
Bill & Linda Cobb	Peter Herdrich & Karen Trent	Elen Novack	James & Mary Lin Yoshimura
Ethan Coen & Trish Cooke	Jane Hoffman	Carol Ochs	Neil Youkin

To those who made gifts of less than \$150, for which we have no font small enough, we give humongous, extra bold and heartfelt thanks.

The 52nd Street Project Presents

# PLAYING WITH FIRE

THE  
TYLER  
HILL, PA.  
EDITION!



The Harold and Mimi Steinberg Charitable Trust  
1996 One-on-Ones  
The Ensemble Studio Theater, New York City

August 22 and 23 at 7:30 p.m.  
August 24 at 3:00 and 7:30 p.m.  
August 25 at 3:00 p.m.

# PLAYING WITH FIRE



The 52nd Street Project Presents  
The Harold and Mimi Steinberg  
Charitable Trust  
1996 One-on-Ones

August 22, 23, 24, & 25, 1996  
The Ensemble Studio Theater,  
New York City

## Project Staff

Willie Reale, Artistic Director  
Carol Ochs, Executive Director  
Michael Bernard, Associate Artistic Director  
Sally Bock, Director of Development and Marketing  
George Roman Babiak, Production Manager  
Susan J. Vitucci, Development Consultant  
Iris A. Brown, Graphic Designer  
Kischa Miller, Nora Ule Rose - Interns  
Jeffrey Zambrano, Melanie Heyn - Junior Counselors

## Production Staff

Kysia Bostic, Music Director  
Kevin Joseph Roach, Set Designer  
Greg MacPherson,  
Lighting Designer  
Misty Halliday, Costume Designer  
Vanessa Valdes, Sound Designer  
Mike Sell, Slide Design  
Scott Ramsay, Props Design  
Colorforms Design:  
Mikel Glass, Doug Florian,  
Michael Massen, Cindy Levitz  
Flyer/program illustrations:  
Mike Sell  
Judy Tucker, Stage Manager  
Jessica Lissy, Slide Operator

Furniture Crew:  
Paul Tavianini, Ray Harold  
Props Crew:  
Beth Janson, Victor Rojas  
Colorforms Crew:  
Joanna Lack, Ahmed Attia  
Load-in and Light Hang Crew:  
Ray Harold, Nora Ule Rose,  
Beth Janson, Paul Tavianini  
House Managers:  
Mary Pat Walsh,  
Karin Schall  
House Crew: Beth Emelson,  
Nancy Giles  
Chef: Eric Karpeles

The One-on-One Program is made possible, in part, by public funds from the New York State Council on the Arts, the Department of Youth Services, and the New York City Department of Cultural Affairs.

The 52nd Street Project is a non-profit organization that brings inner-city children from the Clinton neighborhood together with professional theater artists to create theater. PLAYING WITH FIRE is a production of our One-on-One program, which is designed to give children the opportunity to go away for one-week stays in the country and enjoy the undivided attention of a professional theater artist who serves as friend, mentor, and role model.

## Board of Directors

Ben Barenholtz	Lisa Benavides
Rachel Chanoff	Wendy Ettinger, Chair
Louis P. Friedman	Stephen Graham
Larry Jones	Heidi Landesman
James McDaniel	Frances McDormand
Patricia M. Murphy, Esq.	Carol Ochs
Willie Reale	Pamala Tyson
Laura Valeroso	Elizabeth Williams

## Special Thanks To:

Our most gracious hosts Eric Karpeles and Mike Sell; Curt, Abigail, Jamie, and The Ensemble Studio Theatre; The Host Families: Martha Sader; Sally and Lenny Weiss; Fred Van Natta and Michael Post; Linda, Bill, and Sean Cobb; Linda, Bill, Kristen, and Daniel Halvorsen; Chuck, Andrea, Melanie, and Emma Heyn; Sohail Raikhy; Corky, Jeannie, and Susan Rutledge; Chef Donna; Klaus and the Alpine Meat Market; Robin and Clearwater Seafood; Gary Rickard; Keith Benjamin.

## In-Kind Contributions:

Ensemble Studio Theatre; Neil A. Mazzella & Hudson Scenic Studios, Inc.; Marcia Dunsmore; Settler's Inn; David Sneddon and Fairway Market; Sally Weiss; Larry Wolhandler, Sonny Buttiglieri, and Painter's Tavern; Colorforms; Baron & Baron; Shays & Murphy; Iris A. Brown & Bernhardt/Fudyma Design Group; Ron Kastner, Capital Printing; The Estate of Jonathan Larson; Intuit; Masque Sound; Nickelodeon; The Printing Store; New Dramatists; Playwrights Horizons; Steve Olsen & The West Bank Cafe; Lincoln Center Theater; Materials for the Arts; Rain Restaurant; Port Authority; Mayor's Office of Film & Television; John A. Vassilaros & Sons; Paris Chocolates; Scholastic Productions; Yorke Construction; Jomen Electrics; Revlon; Watkins Products; Tom Reale; Eric Karpeles & Mike Sell; Mario Egozzi; Andy Millon; Dr. Cristina Biaggi; Stephen Graham; Emily Grishman; Mark Keoppen; Kevin Joseph Roach.

**Don't miss our upcoming shows!**

# Playback

**Nov. 8, 9, and 10**



First, a kid writes a short play. Then, an adult writes an "answer" play. Then, the two of them perform both plays!

# Playmaking

**Dec. 13, 14, and 15**



In September, 10 kids brand-new to the Project will begin a Playmaking class with Michael Bernard. Come and see their final plays performed by adult professional actors.

# The Two-on-Two's

**Jan. 27 and 28**



In the One-on-One's, a single kid is paired with a single adult. Now you can see two kids perform a play written by an adult and directed by another adult.

## PLAYING WITH FIRE: ACT I

All music composed by Kysia Bostic

**The Playing with Fire Theme Song** - The Company. Lyrics by Willie Reale

### Revisionist History

Written and directed by Michael Bernard for Noel Polanco, age 11

Bob ..... Michael Bernard  
 Bob ..... Noel Polanco  
 The Bunnies ..... George Babiak, Sally Bock,  
 Nora Ule Rose, Jeffrey Zambrano

"Scientists" and "Who Will Save the Bunnies" lyrics by Michael Bernard.

### The Bravest of Heroes

Written by Liz Tuccillo, directed by Jeff Williams for Hakim Latimore, age 10.

Marv ..... Jeff Williams  
 Albert ..... Hakim Latimore  
 Albert's Mom ..... Wendy vanden Heuvel

"No Greater Danger" lyrics by Liz Tuccillo and Willie Reale

### Dangerous When Pregnant

Written by Alex Gersten, directed by Wendy vanden Heuvel for Stephanie Santana, age 13.

Lucille ..... Wendy vanden Heuvel  
 Stephie ..... Stephanie Santana  
 Taxi Driver ..... Jeffrey Zambrano  
 Ice Cream Man ..... Jeff Williams  
 The Sugar Cones ..... Elizabeth Keiser, Eris Migliorini,  
 Robin Morse, Nora Ule Rose

"Soft Ice Cream" lyrics by Willie Reale. "Live Your Life" lyrics by Alex Gersten and Willie Reale

### A Play on Playing with Fire

Written by Carl Capotorto, directed by Gus Rogerson for William Brown, age 13.

Gus ..... Gus Rogerson  
 Billie ..... William Brown  
 Smokey ..... Jeffrey Zambrano

"Billy Boy" lyrics by Carl Capotorto, "Some Trunk Song" lyrics by Willie Reale.

### The Fable of Fearless Fran

Written and directed by Evan Handler for Natalie Musteata, age 10.

Fran ..... Natalie Musteata  
 Dad ..... Evan Handler  
 Announcer ..... George Babiak

"Daddy, I'm Afraid" lyrics by Evan Handler

## ACT 2

### Dependence Day

Written by Adam Felber, directed by Eris Migliorini for  
Hunter Reid-Eaton, age 10.

Commander Gorzak ..... Hunter Reid-Eaton  
Mumph/Brenda ..... Eris Migliorini  
"Fear and Respect" and "One Good Friend" lyrics by Adam Felber

### Dangerously Funny

Written and directed by Robin Morse for  
Tessa John-Connor, age 12.

Veronica ..... Tessa John-Connor  
Sally ..... Robin Morse  
"One Last Meow Before I Go" lyrics by Robin Morse and Willie Reale  
"Sally's Lament" and "Mrs. Katz" lyrics by Willie Reale

### Ain't No Play

Written and directed by Jerry McGill for Carl Moon, age 9.

Carl ..... Carl Moon  
Angel ..... Jerry McGill  
Stagehand ..... Beth Janson  
"Write It In" lyrics by Jerry McGill

### Cool Hair

Written by Eduardo Machado, directed by Elizabeth Keiser for  
Eddie Cooper, age 14.

Joe ..... Eddie Cooper  
Mary ..... Elizabeth Keiser  
"I Ain't Gonna Change" lyrics by Eduardo Machado

### The Value of Zero

Written and directed by Willie Reale for Jaya Rosado, age 12.

The Queen of "O" ..... Lori Tan Chinn  
The Queen of Zero ..... Jaya Rosado  
Panicked letter ..... Victor Rojas  
"Oh, to be an O" and "Without You" lyrics by Willie Reale



Thank you for coming to PLAYING WITH FIRE. If you are not on our mailing list (or if your address has changed), please fill out this form and give it to us on your way out or mail it to the address below. We would also like to know if you are interested in becoming a volunteer. We are always in need of help in *all areas*, so please fill out your name and phone number, and we'll call you.

#### PLEASE ADD ME TO YOUR MAILING LIST:

NAME \_\_\_\_\_

ADDRESS \_\_\_\_\_

ZIP \_\_\_\_\_

PHONE \_\_\_\_\_

#### YES, I WOULD LIKE TO BE OF HELP:

NAME \_\_\_\_\_

DAYTIME PHONE \_\_\_\_\_

I AM REALLY USEFUL AT (52nd Street Project related things only. Examples: Mailings, backstage help, fundraising, moving heavy items, etc.)...

If you would like to mail this (and you're always welcome to enclose a tax-deductible contribution), you can send it to:

The 52nd Street Project 500 West 52nd St. New York, NY 10019  
(212) 333-5252

## ON SALE IN THE LOBBY

**Cool Stuff**

The Fabulous Flyer Bar  
(in five mouth-watering flavors!)  
**\$2.00 and \$1.50. \$1.00 for kids**

52nd Street Project T-Shirts  
with Shel Silverstein's logo  
**\$12.00**

52nd Street Project Caps  
**\$15.00**

**52nd Street  
Project Books**

Playmaking: Children Writing and  
Performing Their Own Plays  
by Daniel Judah Sklar **\$14.00**

52 Pick Up: A Practical Guide to  
Doing Theater with Children  
A HOW TO guide by Willie Reale with Playmaking  
lesson plans by Daniel Judah Sklar **\$35.00**

The 52nd Street Project gratefully acknowledges the support of the following foundations and corporations: Barker Welfare Foundation, Badermann's World of Expression Foundation, The BETA Fund, Consolidated Edison, The Dramatist's Guild Fund, William and Mary Greve Foundation, The Horace W. Goldenfritz Foundation, Heights Partners, Inc., The Hennessy Foundation, The Holland Lodge Foundation, Inc., Rita J. and Stanley H. Kaplan Foundation, Ulysses Bank, The M & T Trust, MCJ Foundation, James A. Macdonald Foundation, Ann M. Martin Foundation, The Morgan Stanley Foundation, The New York Times Co. Fdn., Northwest Point, Laura Pels Foundation, Carl and Lay Pforzheimer Foundation, Inc., RJM Group, Sauro Entertainment, Staging and Design, Inc., Jules and Doris Stein Foundation, The Sundra Foundation, Susquehanna, Time Warner, Inc., Travelers Foundation, Unifworld Group Inc., John A. Vassilano & Sons, Inc., Wachtel, Lipton, Rosen & Katz, Lila Acheson Wallace Funds, West Bank Cafe, Writers & Artists. In addition, the following individuals made gifts of over \$150 to The 52nd Street Project this year:

Wendy Abrams	Joel Coen & Fran McDermid	William Hoffman &	Steve Olsen
Jace Alexander	Barry Cohen	S. Sylvia Shepard	Kevin O'Rourke & Edith Thurber
Brooke Allen	Ruth Cohen	Barbara Howard	Charles & Jean Marie Pease
Jule Ang	Joanne Comerford	Michelle Hurst	Bill & Joanne Parsky
Amy Aquino & McGinnis McCoy	Thomas Cot	Ahnette Insdorf &	Alton & Elizabeth Peters
Alan Arfa & Kay Matichukal	Margaret Commins &	Mark Elhan Toporek	Thomas Peters
Nora Arfin & Jake Weber	Pierre Commins	Richie Jackson	Ethan Phillips
Susan Atkins & Eben Shacoro	Joan Straus Cutman	Sy Jacobs	Robert & Susan Debs Phillips
Jane Balinger &	Nada Dajani	Marc Jaffe & May Wubrich	Nicholas Platt & Robyn Watz
Michael Goldstein	Arthur Danichik	Linda Janikow	Donna Plummes & Todd Richter
Martha Santa & David Turner	Cathy Dacicich	M. Lynne Johnson	Christopher Randolph
Ben Barenholtz	Judith & Peter Dawkins	Larry Jones &	Helen & Peter Randolph
Jessica Bauman	Georgia & William Delano	Mary McGrath-Jones	Tim Ray & Tyson Smith-Ray
Lisa Benavides & Tim Nelson	Mariana Deppe & Richard Hader	Nathan Joseph	Wille Reale
Emily Benton	Donna & William DeSoto	Marcia & Max Kahn	Adam Reingold
Eleanor Bergstein	Cipa & Mistra Dickler	Betty & George Kaiser	Jonathan Reiss
Pamela Berlin & William Carden	Jose Dominguez &	Lee Kalkheim & Julia Lord	Todd Richter
Barry & Myrna Bernard	Lisa Waldman	Maurice Kanbar	Eric Ritter
Alexander Bernstein &	Stephen Dufner	Eric Karpeles & Mike Sell	Tyhurst Robertson
Elizabeth Velazquez	Jack & June Dunbar	Shella Kahoe	Ellie & Susan Rose
Ron & Susan Black	Darcy Dunn & Mark Singer	Mark Kenpoem &	Betsy & Clifford Ross
Audrey Bloch &	Amy Dolewiodowski	Wendy Townsend	Jane Sangerman &
Joseph Wisenthal	Ned Easenberg	Ana & Mark Kingdon	Joseph Vadalukas
Stuart Bloomberg & Mary Farrell	Barbara Eilan	Beth & Seth Klarman	Karin & Tom Schall
Robt & Ruth Blumenstein	Charlotte Elertson &	Jeannine Koch	Steve Schokel
Sally Bock & Mark Wiertel	Paul Hegman	Mary Kong	Dana Segal
Jane Bolser & Steve Wortmer	Barbara Ettinger	Jan Krosze & Jacki Octa	Stefan Selig
Katherine Borowitz &	Wendy Ebinger & Derek McLane	Belle & Roger Kubin	Timothy Sherry
John Turturo	Adam Feiler & Joanne Simpson	Judy Kuhn & David Schwab	Brian Sberoff & Patty Dryden
Cristina Botta Singleton	Lisa Finstrom & Tim Sanford	Held Landerman	Jacqueline Simon
Bertha & Samuel Brit	Inen & Simra Fisch	Jill Larson	Meg Simon
Eric Brooks	Tom Fontana & Sagan Lewis	Joshua Lehrer	John Giebery
Becky Browder & Ted Neustadt	David Frankel	Sarah Jane Leigh	Lois Smith
Deborah Brown	Kermit Frazier	Robert Seati Leonard	Abigail Solomon
Back & P.J. Brown	Peter Freundlich & Mary Lou Teel	Liza Lehrer	Warren Spector
Susan Bruce & Peter Hedges	Amy Friedman	John Bedford Lloyd &	Jean Stein
Denise Burse &	Louis & Patricia Friedman	Annie Twomey	Teri Stephenson & Adriana Trojan
Peter Jay Fernandez	Peter Fritschel & Pamela Nelson	Katherine Lumb & Joe Vitale	Daniel Sweet
Kate Burton & Michael Ritchie	Joseph Gazzdik	Mary McCann & Neil Pope	Jay Tarsas
Cora Cahari & Bernard Gersten	Gary Gersh	Marsue & Peter MacNicol	Catherine Thomas
Daniel & Maureen Cahill	Simma Gerstenson	Greg MacPherson	Kip Thompson
Steven Callahan &	Jenny Gersten	Bruce MacVite	Joan Vail & John Thorne
Christine Dunn	Ileen Getz & Mark Grinnell	Peter Manning	Laura Valeroto
Camilla Campbell & Oliver Platt	Stephen Graham	George Mavronikolas	Paul Valley
Louisa Campbell	Michael Grell	Max Mayer	Wendy vanden Heuvel
Coleen Carroll & Mitchell Samel	Emily Grashman &	Barbara McCrane & Paul Reale	John Vassilano
Richard & Lisa Caslin	Susan Splimier	Paul McCrane	Susan Vitucci
John Cavallo & Lucy Kaplan	Edmund Lewis Ginstaman &	Brian Merles & Jackie Reingold	Emily Wachtel
James Cayne	Tracy Thome	Andy Milon	Elizabeth Warner
Sockard Channing	Laura Guerra & Tucker McCrady	Walter Mosley	Sally Weiss
Rachel Chancoff	Lisa Gugerheim	Bill & Jane Muddyman	Robert Wiener
Peter Charasia	Albert Gurney	Patricia Murphy & Adam Spika	Barbara & Max Wilk
Larry Chernoff & M. Rose Garner	Andrew Haas	Edward Nashen	Elizabeth Williams & Joseph Fone
Glenda Chestler	Bill & Linda Halvorson	Kate Neeligan & Robert Reiss	Matt Williams
Marsal Chibas &	Stephen Hamilton &	Randy & Roma Nelson	Valerie Wilson
Travis Preston	Emma Walton	Ruth Nelson	Donald Windham
William Christian	Marcia Gay Harden	Helen & James Neuberger	Juaine Woodward
Joe Christiano & Raide Goodwin	Birney Harris	Renée Nowald	Janine & Jeffrey Yass
Bill & Linda Cobb	Peter Hendrich & Karen Trout	Elen Nowack	James & Mary Lin Yoshimura
Ethan Coen & Trish Cooke	Jane Hoffman	Carol Octa	Neil Yarkin

as of 7/25/96

To those who made gifts of less than \$150, for which we have no list small enough, we give humongous, extra bold and heartfelt thanks.

The 52nd Street Project Presents

# something's missing



Plays from  
The 52nd Street Project's  
1996 Playback Program

Friday, November 8 at 7:30 p.m.

Saturday, November 9 at 3:00 and 7:30 p.m.

Sunday, November 10 at 3:00 p.m.

Naked Angels' Theater Three, New York City

# something's missing



## The 1996 Playback Plays

Nov. 8, 9, and 10, 1996  
Naked Angels' Theater Three,  
New York City

### Project Staff

Willie Reale, Artistic Director  
Carol Ochs, Executive Director  
Michael Bernard, Associate Artistic Director  
Sally Bock, Director of Development and Marketing  
George Roman Babiak, Production Manager  
Susan J. Vitucci, Development Consultant  
Iris A. Brown, Graphic Designer  
Genevieve Durham, Suzie Overlie - Interns

### Production Staff

Kevin Joseph Roach, Set Designer	Robin Gillette, Stage Manager
Greg MacPherson, Lighting Designer	Rosemary Tavares, Slide Operator
Genevieve Durham, Costume Designer	Furniture Crewhead:
Matthew Schlieff, Sound Designer	Stewart Sarkozy-Banoczy,
Slide Design:	Props Crew: Jon Epstein,
Renato Castilho, Angela Dundee,	Joseph Mohamed
Katherine Lumb, Tiana Manfred,	Colorforms Crew:
Eric Quo, Adam Rodriguez,	Kimberly Kelly Wilson,
Sharon Scotland, Mike Sell,	Diana Rojas
Kevin Sibley, Alberta Testanero,	Load-in and Light Hang Crew:
and John Steward	Genevieve Durham,
(with thanks to Mike Quon Studios)	Bruce MacVittie, Gus Rogerson,
Scott Ramsay and George Babiak,	Matthew Schlieff, Abigail Solomon
Prop Designers	House Manager: Beth Emelson
Michele Mayas, Colorform Designer	House Crew: Liz Days,
Flyer Design/Program Illustration:	Gheree O'Bannon
Joy Kilpatrick	

The Playback Program is made possible, in part, by public funds from the New York State Council on the Arts, the Department of Youth Services, and the New York City Department of Cultural Affairs.

The 52nd Street Project is a non-profit organization that brings inner-city children from the Hell's Kitchen/Clinton neighborhood together with professional theater artists to create theater. **Something's Missing** is a production of our Playback program. In it, an adult actor/playwright is paired with a kid actor/playwright. The duo is charged to invent two characters for the kid to write a play for. The adult then responds with a second play using the same two characters. All of the children are veterans of the Playmaking classes which were adapted for the Project by Daniel Judah Sklar from his book *Playmaking: Children Writing and Performing Their Own Plays*.

### Board of Directors

Ben Barenholtz	Lisa Benavides
Rachel Chanoff	Wendy Ettinger, Chair
Louis P. Friedman	Stephen Graham
Larry Jones	Heidi Landesman
James McDaniel	Frances McDormand
Patricia M. Murphy, Esq.	Carol Ochs
Willie Reale	Pamala Tyson
Laura Valeroso	Elizabeth Williams

### Special Thanks To:

Our most gracious hosts, Helen, Peter and Christopher Randolph of Buzzard's Bay; John McCormack and Naked Angels; Emily Benton; Stephen Haff and New Dramatists; Sheila Kehoe; Lisa Benavides, Evelyn Maldonado, and Tim Nelson; and Ashley Epting.

### In-Kind Contributions:

Naked Angels; Ensemble Studio Theatre, Neil A. Mazzella & Hudson Scenic Studios, Inc.; Colorforms; Baron & Baron; Shays & Murphy; Iris A. Brown & Bernhardt/Fudyma Design Group; Ron Kastner, Capital Printing; The Estate of Jonathan Larson; Intuit; Nickelodeon; The Printing Store; New Dramatists; Playwrights Horizons; Steve Olsen & The West Bank Cafe; Materials for the Arts; Rain Restaurant; Port Authority; Mayor's Office of Film & Television; John A. Vassilaros & Sons; Paris Chocolates; Scholastic Productions; Yorke Construction; Jomen Electrics; Revlon; Watkins Products; Tom Reale; Mario Egozzi; Stephen Graham; Emily Grishman; Mark Keoppen; Kevin Joseph Roach; Simma Gershenson, John Kain, and Mark Topping; and Andy Millon.

**Don't miss our upcoming shows!**

# TIMING IS EVERYTHING



December 13th, 14th, and 15th at the Playwright's Horizons Upstairs Studio

At this moment, 10 kids who are brand-new to the Project are taking a Playmaking class with Michael Bernard. When they are done, they will be hailed as masters of their craft and given their very own writer's retreat in Pennsylvania. Come see their final plays performed by professional adult actors.

## The Two-on-Two's

**Jan. 27 and 28**



In the One-on-One's, a single kid is paired with a single adult. Now you can see two kids perform a play written by an adult and directed by *another* adult.

**WINTER SERIES**

## Playmaking

**March, 1997**

In January, our next batch of newcomers will undertake the 10-week Playmaking program. At the end of the class they will be whisked away to Connecticut for a weekend to fashion a set of plays. The only thing they need: an audience.

### SOMETHING'S MIS ING: ACT I

#### Power Failure

Written by Alex Metzler, age 12

Dramaturg: George Babiak

Directed by Ned Eisenberg

Mike ..... Alex Metzler

Sam ..... Ned Eisenberg

Doctor Fix U. Up ..... Michael Bernard

#### Meltdown

Written and Directed by Ned Eisenberg

Mike ..... Alex Metzler

Sam ..... Ned Eisenberg

Doctor Fix U. Up ..... Michael Bernard

The Rat ..... Kimberly Kelly Wilson

#### Crime and Romance

Written by Amy Barbosa, age 13

Dramaturg: Anne Garcia Romero. Director: Jose Dominguez

Anastasia ..... Amy Barbosa

Juan ..... Jose Dominguez

Captain McCully ..... Jose Dominguez

#### Comedy Cop

Written by Anne Garcia Romero

Directed by Jose Dominguez

Anastasia ..... Amy Barbosa

Juan ..... Jose Dominguez

Captain McCully ..... Jose Dominguez

Runaway Joe ..... Jon Epstein

#### Jaw

Written by Desmond Robertson, age 12

Dramaturg/Director: Willie Reale

Mike Bond ..... Desmond Robertson

Bozo ..... Jeff Williams

The Store Manager ..... Willie Reale

#### Breakthrough

Written and Directed by Willie Reale

Mike Bond ..... Desmond Robertson

Bozo ..... Jeff Williams

The Store Manager ..... Willie Reale

**INTERMISSION**

## ACT 2

### Diamonds Are Forever

Written by Cordell Horsford, age 13

Dramaturg/Director: Julie Boyd

Jhon ..... Cordell Horsford  
Peire ..... Bruce MacVittie  
Voice of Diamond ..... George Babiak

### Brothers Are Forever

Written and Directed by Julie Boyd

Jhon ..... Cordell Horsford  
Peire ..... Bruce MacVittie  
Voice of Diamond ..... George Babiak

### The Power Inside

Written by Elisa Mohamed, age 15

Dramaturg/Director: Peter Jay Fernandez

Fantasia Bacardi ..... Denise Burse  
China ..... Elisa Mohamed  
Sir ..... Joe White

### The Power Inside II

Written by Tim Meadows

Directed by Peter Jay Fernandez

Fantasia Bacardi ..... Denise Burse  
China ..... Elisa Mohamed  
Sir ..... Joe White  
The Judge ..... Stewart Sarkozy-Banoczy

### The Right Thing

Written by Jeffrey Zambrano, age 17

Dramaturg/Director: Anna Li

Guy ..... Jeffrey Zambrano  
Girl ..... Anna Li

### Tutelage

Written and Directed by Anna Li

Guy ..... Jeffrey Zambrano  
Girl ..... Anna Li



Thank you for coming to SOMETHING'S MISSING. If you are not on our mailing list (or if your address has changed), please fill out this form and give it to us on your way out or mail it to the address below. We would also like to know if you are interested in becoming a volunteer. We are always in need of help in *all areas*, so please fill out your name and phone number, and we'll call you.

#### PLEASE ADD ME TO YOUR MAILING LIST:

NAME \_\_\_\_\_

ADDRESS \_\_\_\_\_

ZIP \_\_\_\_\_

PHONE \_\_\_\_\_

#### YES, I WOULD LIKE TO BE OF HELP:

NAME \_\_\_\_\_

DAYTIME PHONE \_\_\_\_\_

I AM REALLY USEFUL AT (52nd Street Project related things only. Examples: Mailings, backstage help, fundraising, moving heavy items, etc.)...

If you would like to mail this (and you're always welcome to enclose a tax-deductible contribution), you can send it to:

The 52nd Street Project 500 West 52nd St. New York, NY 10019  
(212) 333-5252

## ON SALE IN THE LOBBY

**Cool Stuff**

The Fabulous Flyer Bar  
(in five mouth-watering flavors!)  
**\$2.00 and \$1.50. \$1.00 for kids**

52nd Street Project T-Shirts  
with Shel Silverstein's logo  
**\$12.00**

52nd Street Project Caps  
**\$15.00**

**52nd Street  
Project Books**

Playmaking: Children Writing and  
Performing Their Own Plays  
by Daniel Judah Sklar **\$14.00**

52 Pick Up: A Practical Guide to  
Doing Theater with Children  
A HOW TO guide by Willie Reale with Playmaking  
lesson plans by Daniel Judah Sklar **\$35.00**



The 52nd Street Project gratefully acknowledges the support of the following foundations and corporations: Barker Welfare Foundation, Berlebach's World of Expression Foundation, The BETA Fund, Consolidated Edison, The Dramatist's Guild Fund, William and Mary Greve Foundation, The Horace W. Goldsmith Foundation, Heights Partners, Inc., The Hennessy Foundation, The Holland Lodge Foundation, Inc., Rita J. and Stanley H. Kaplan Foundation, Ulysses Bank, The M & T Trust, MCJ Foundation, James A. Macdonald Foundation, Ann M. Martin Foundation, The Morgan Stanley Foundation, Newsman's Own, The New York Times Co. Fdn., Northwest Fund, Laura Pels Foundation, Carl and Lily Pforsheimer Foundation, Inc., FUM Group, Salute Entertainment, Staging and Design, Inc., Jules and Doris Stein Foundation, The Sundra Foundation, Susquehanna, Time Warner, Inc., Travelers Foundation, Unisworld Group Inc., John A. Vazzarolo & Sons, Inc., Wachter, Lighter, Rosen & Katz, Lita Acheson Wallace Funds, West Bank Cafe, Writers & Artists. In addition, the following individuals made gifts of over \$150 to The 52nd Street Project this year:

Wendy Abrams	Joel Coen & Fran McDonnand	William Holtzman &	Steve Olson
Jacq Alexander	Barry Cohen	S. Sylvia Shepard	Kevin O'Rourke & Edith Thorber
Brooke Allen	Ruth Cohen	Barbara Howard	Charles & Jean Marie Pease
Julie Ang	Joanne Comerford	Michelle Hurst	In memory of Francis Peiser
Amy Aquino & McGorrie McCoy	Thomas Cott	Annette Insdorf &	Bill & Joanna Persky
Alan Arfa & Kay Mitzchulski	Margaret Crumess &	Mark Ethan Toporek	Alton & Elizabeth Peters
Nora Arfite & Jale Weber	Pierre Rafferty	Richie Jackson	Thomas Peters
Susan Atkins & Eben Shapiro	Jean Straus Collman	Sy Jacobs	Ethan Philips
Jane Ballinger &	Nadia Dajani	Marc Jaffe & May Wutrich	Robert & Susan Ochs Phillips
Michael Goldstein	Arthur Danklich	Linda Janikow	Nicholas Platt & Robyn Wabi
Martha Banta & David Turner	Cathy Dantnick	M. Lynise Johnson	Donna Plummer & Todd Richter
Ben Bakemholtz	Judith & Peter Dawkins	Larry Jones &	Christopher Randolph
Jessica Bauman	Georgia & William Delano	Mary McElrath-Jones	Helen & Peter Randolph
Lisa Bernales & Tim Nelson	Martina Droppel & Richard Hader	Nathan Joseph	Tim Ray & Tyson Smith-Ray
Emily Benzon	Donna & William DeGeta	Marcello & Max Kahn	Wille Reale
Eleanor Bergstein	Cipa & Michal Dichter	Betty & George Kaiser	Adam Reingold
Patricia Berlin & William Garden	Jose Dominguez &	Lee Kalcheim & Julia Lord	Jonathan Reiss
Bary & Myrna Bernard	Lisa Waldman	Maurice Kanbar	Todd Richter
Alexander Bernstein &	Stephen Dubner	Eric Karples & Mike Sell	Eric Ritter
Elizabeth Velazquez	Jack & June Dunbar	Shella Kehoe	Tylerwest Robertson
Ron & Susan Black	Garcy Dunn & Mark Singer	Mark Kozzpen &	Elihu & Susan Ross
Audrey Bloch &	Amy Drowoskiowski	Wendy Townsend	Betty & Clifford Ross
Joseph Weiszthal	Ned Eisenberg	Aida & Mark Kingdon	Jane Sangerman & Joseph Vadapala
Stuart Bloomberg & Mary Farrell	Barbara Elson	Beth & Seth Klarman	Karin & Tom Schall
Robt & Ruth Blumenstein	Charlene Ekertson &	Jeremy Koch	Steve Schueler
Sally Book & Mark Wurzel	Paul Hegman	Mary Kong	Dana Segal
Jane Botser & Steve Wertmer	Barbara Eltinger	Jan Kroscoe & Jacki Ochs	Skafan Seig
Katherine Borowitz &	Wendy Stinger & Derek McLave	Belle & Roger Kuhn	Timothy Sherry
John Turiano	Adam Felber & Jeannie Simpson	Judy Kuhn & David Schwab	Brian Sibel and Patsy Dryden
Cristina Botta Dingleton	Lisa Finstrom & Teri Sanford	Hedi Linderman	Jacqueline Simon
Bertha & Samuel Hill	rnin & Sima Fish	Jill Larson	Meg Simon
Eric Brooks	Tom Fontana & Sagan Lewis	Joshua Lehrer	John Glatzery
Becky Browder & Ted Nestoroff	David Frankel	Sarah Jane Leigh	Lois Smith
Deborah Brown	Kenneth Frasier	Robert Sean Leonard	Abigail Solomon
Beck & P.J. Brown	Peter Freudlich & Mary Lou Teel	Liza Lerner	Warren Specker
Susan Bruce & Peter Hodgen	Amy Friedman	John Bedford Lloyd &	Jean Stein
Denise Burse &	Louise & Patricia Friedman	Anne Twomey	Tim Stephenson & Adriana Tregiani
Peter Jay Fernandez	Peter Fritschel & Pamela Nelson	Katherine Lumb & Joe Vitale	Daniel Sweet
Kate Burton & Michael Ritchie	Joseph Gazdai	Mary McCann & Neil Pepe	Jay Taras
Cori Cahlan & Bernard Gerstein	Gary Gersh	Marsue & Peter MacNico	Catherine Thomas
Daniel & Maureen Cahill	Silvina Gershenson	Greg MacPherson	Kip Thompson
Steven Callahan &	Jenny Gerstein	Bruce MacVittie	Joan Vail & John Thorne
Christine Durr	Isen Getz & Mark Gonsell	Peter Manning	Laura Valerisco
Camilla Campbell & Oliver Platt	Stephen Graham	George Mavrouncolas	Paul Valley
Louisa Campbell	Michael Gerd	Max Mayer	Wendy vanden Heuvel
Colleen, Carol & Mitchell Sernoi	Emily Griebman &	Barbara McCrane & Paul Reute	John Vazzarolo
Richard & Lisa Cashin	Susan Sampine	Paul McCrane	Susan Vitucci
John Caveller & Lucy Kaplan	Edmund Lewis Grossman &	Brian Merles & Jackie Reingold	Emily Wachtel
James Cayne	Tracy Thome	Andy Milton	Elizabeth Warner
Stockard Channing	Lizora Guerra & Tucker McCrady	Walter Mosley	Sally Weiss
Rachel Charoff	Lisa Guggenheim	Bill & Jane Muddymen	Robert Wiener
Peter Chersias	Albert Gurnay	Patricia Murphy & Adam Spika	Barbara & Max Wik
Lary Chertoff & M. Rose Garner	Andrew Haas	Edward Nashen	Elizabeth Williams & Joseph Fink
Gemita Chester	Bill & Linda Helverson	Kate Neeligan & Robert Reale	Matt Williams
Marissa Chibasi &	Stephen Hamilton &	Randy & Roma Nelson	Valene Wilson
Travis Preston	Erma Walton	Ruth Nelson	Donald Windham
William Christian	Marcia Gay Harden	Helen & James Neuberger	Joanne Woodward
Joe Christand & Randee Gooden	Barnaby Harris	Reecee Newswold	Janine & Jeffrey Yaco
Bill & Linda Cobb	Peter Hershnik & Karen Trot	Elen Novack	James & Mary Lin Yoshimura
Ethan Coen & Trish Cooke	Jane Hoffman	Carol Ochs	Neil Yashin

To those who made gifts of less than \$150, for which we have no room small enough, we give humongous, extra bold and heartfelt thanks.

## The 52nd Street Project Presents



### Nine Plays from The 52nd Street Project's 1996 Playmaking Program

Friday, December 13 at 7:30 p.m.  
Saturday, December 14 at 3:00 and 7:30 p.m.  
Sunday, December 15 at 3:00 and 7:30 p.m.

**Playwrights Horizons Studio Theater,  
New York City**

as of 11/00/96



## Timing Is Everything

### The 1996 Playmaking Plays

Dec. 13, 14, and 15, 1996  
Playwright's Horizons Studio Theater  
New York City

#### Project Staff

Willie Reale, Artistic Director  
Carol Ochs, Executive Director  
Michael Bernard, Associate Artistic Director  
Sally Bock, Director of Development and Marketing  
George Roman Babiak, Production Manager  
Susan J. Vitucci, Development Consultant  
Iris A. Brown, Graphic Designer  
Genevieve Durham, Suzie Overlie, Jessica Milagros - Interns

#### Production Staff

Kevin Joseph Roach, Set Designer	Mary Beth Bentwood, Mia Underwood
Greg MacPherson, Lighting Designer	Slide Operators
Crystal Thompson, Costume Designer	Furniture Crew: Jon Epstein,
Jeremy M. Posner, Sound Designer	Ray Harold
Slide Design:	Props Crew: Jaya Rosado,
Renato Castilho, Eric Kuo,	Stewart Sarkozy-Banoczy,
Katherine Lumb, Tiana Manfred,	Colorforms Chief:
John Steward, and Alberta Testanero	Laura Lee Shink
(with special thanks to	Load-in and Light Hang Crew:
New York Recycled Paper, Inc.)	Desmond Andrews,
Scott Ramsay, Miranda Mercado,	Catherine Brophy, Jilly Crook,
Mia Underwood, Prop Designers	Nedra Gallegos, Jason McCullough,
Joy Kilpatrick and Sarah Hokanson,	Miranda Mercado, Doug Nervik,
Colorform Designers	Tassos Pappas, Gus Rogerson
Simma Gershenson, Stage Manager	House Manager: Sally Bock

The Playmaking Program is made possible, in part, by public funds from the New York State Council on the Arts, the Department of Youth Services, and the New York City Department of Cultural Affairs.

The 52nd Street Project is a non-profit organization that brings inner-city children from the Clinton neighborhood together with professional theater artists to create theater. TIMING IS EVERYTHING is part of our Playmaking program. Young people participate in eight weeks of classes adapted for the Project by Daniel Judah Sklar from his book, *Playmaking: Children Writing and Performing Their Own Plays*. During the class sessions, the participants learn the elements of drama and write their first play. At the end of the class, each child is given two actors, a theme and a director who guides him or her through the writing of a play during a weekend retreat in the country. This show is the fruit of their labors.

#### Board of Directors

Ben Barenholtz	Lisa Benavides
Rachel Chanoff	Wendy Ettinger, Chair
Louis P. Friedman	Stephen Graham
Larry Jones	Heidi Landesman
James McDaniel	Frances McDormand
Patricia M. Murphy, Esq.	Carol Ochs
Willie Reale	Pamala Tyson
Laura Valeroso	Elizabeth Williams

#### Special Thanks To:

Our most gracious hosts Eric Karpeles and Mike Sell, and our host families the Heyns, Sohail Raikhy, Martha Seder, Sally and Lenny Weiss, and the Galilee Bed and Breakfast. Thanks also go to Tim Sanford, Leslie Marcus, Lynn Landis, and everyone at Playwright's Horizons. And we mustn't forget our own Jenny Gersten.

#### In-Kind Contributions:

Playwrights Horizons; Naked Angels; Ensemble Studio Theatre, Neil A. Mazzella & Hudson Scenic Studios, Inc.; Colorforms; Baron & Baron; Shays & Murphy; Iris A. Brown & Bernhardt/Fudyma Design Group; Ron Kastner, Capital Printing; The Estate of Jonathan Larson; Nickelodeon; The Printing Store, New Dramatists; Steve Olsen & The West Bank Cafe; Materials for the Arts; Rain Restaurant; Port Authority; Mayor's Office of Film & Television; John A. Vassilaros & Sons; Paris Chocolates; Scholastic Productions; Yorke Construction; Jomen Electrics; Revlon; Watkins Products; Tom Reale; Mario Egozzi; Stephen Graham; Emily Grishman; Mark Keoppen; Kevin Joseph Roach; Simma Gershenson, John Kain, and Mark Topping; Mary White; Heather Lester; Andy Millon; Reel-to-Real; The Lobster Club; H & H Bagels; Ben and Jerry's Times Square Scoop Shop; and Boylan's Bottling Company.

**Don't miss our upcoming shows!**

# Breaking The Mold II

**Jan. 27 and 28  
at the Westbank Cafe Downstairs Theatre**

In the One-on-One's, a single kid is paired with a single adult. Now you can see two kids perform a play written by an adult and directed by *another* adult.

**WINTER SERIES**



# Playmaking

**March, 1997**

In January, our next batch of newcomers will undertake the 10-week Playmaking program. At the end of the class they will be whisked away to Connecticut for a weekend to fashion a set of plays. The only thing they need: an audience.

THE 52ND STREET PROJECT

# Annual Benefit

**Monday, May 5, 1997**  
at a location to be announced,  
with a theme to be announced.



For information or reservations call Sally Bock,  
our highly intelligent and extremely friendly  
Director of Marketing and Development at 333-5252



## Timing Is Everything: ACT I

### The Little Girl In Trouble

Written by Peter Ventura, age 11  
Dramaturg/Director: Michael Bernard

Girls ..... Genevieve Durham, Sally Bock  
Linda Cat/Mr. Cat..... Astranada Gamsey  
Tom Project ..... Chris McCann

### Rain and Rainbow

Written by Christina Ramirez, age 8  
Dramaturg/Director: George Babiak

Rain ..... Ray Anthony Thomas  
Rainbow ..... Lori Tan-Chinn  
King Color ..... Stewart Sarkozy-Banoczy  
The Alien ..... George Babiak

### Carnival

Written by Aisha Jabour, age 11  
Dramaturg/Director: Michael angel Johnson

Silent Sam ..... Barbara McCrane  
Rip-Off Roxanne ..... Karen Kandel

### Babaloo the Spy

Written by Jaysunn Rosado, age 10  
Dramaturg/Director: Joe White

Babaloo ..... Michael Rogers  
Jos ..... Tom Carrozza  
The Bouncer ..... Ray Harold  
Kissing Man ..... Stewart Sarkozy-Banoczy  
Kissing Woman ..... Genevieve Durham

### True Friends Through Thick and Thin

Written by Isha Rodriguez, age 12  
Dramaturg/Director: Marissa Chibas

Penelope ..... Jessalyn Gilsig  
Sarah ..... Julie Dretzin  
Coke Man/Lottery Agent ..... Michael Bernard

**INTERMISSION**

**ACT 2**

**Who Killed Cupid?**

Written by Matthew Jellison, age 11

Dramaturg/Director: Jonathan Bernstein

Newscaster/Girlfriend..... Genevieve Durham

Ned Gullivan/Detective Detective..... Don Berman

Cupid/Cupid's Mother/Chief Lifus..... Trey Wilson

**Waffles and Barney**

Written by Edith Berko-Nti, age 12

Dramaturg/Director: Judy Goldman

Waffles the Cat..... Jilly Crook

Barney the Dog..... Will Badgett

Deliveryman #1..... Jon Epstein

Deliveryman #2..... Stewart Sarkozy-Banoczy

**Sisters**

Written by Lorraine Zambrano, age 12

Dramaturg/Director: Byam Stevens

Layza..... Leslie Lyles

Porsha..... Myra Lucretia Taylor

Receptionist..... Laura Lee Shink

**The Tree Near The Lake**

Written by Michael Castro, age 11

Dramaturg/Director: Alison Tatlock

Richie..... Jack Gwaltney

Ralphie..... David Wiater

Forest Fairy #1..... Jon Epstein

Forest Fairy #2..... Stewart Sarkozy-Banoczy

Forest Fairy #3..... Ray Harold



Thank you for coming to TIMING IS EVERYTHING. If you are not on our mailing list (or if your address has changed), please fill out this form and give it to us on your way out or mail it to the address below. We would also like to know if you are interested in becoming a volunteer. We are always in need of help in **all areas**, so please fill out your name and phone number, and we'll call you.

**PLEASE ADD ME TO YOUR MAILING LIST:**

NAME \_\_\_\_\_

ADDRESS \_\_\_\_\_

ZIP \_\_\_\_\_

PHONE \_\_\_\_\_

**YES, I WOULD LIKE TO BE OF HELP:**

NAME \_\_\_\_\_

DAYTIME PHONE \_\_\_\_\_

I AM REALLY USEFUL AT (52nd Street Project related things only. Examples: Mailings, backstage help, fundraising, moving heavy items, etc.)...

If you would like to mail this (and you're always welcome to enclose a tax-deductible contribution), you can send it to:  
The 52nd Street Project 500 West 52nd St. New York, NY 10019  
(212) 333-5252

**ON SALE IN THE LOBBY**

**Cool Stuff**

The Fabulous Flyer Bar  
(in five mouth-watering flavors!)  
**\$2.00 and \$1.50. \$1.00 for kids**

52nd Street Project T-Shirts  
with Shel Silverstein's logo  
**\$12.00**

52nd Street Project Caps  
**\$15.00**

**52nd Street  
Project Books**

Playmaking: Children Writing and  
Performing Their Own Plays  
by Daniel Judah Sklar **\$14.00**

52 Pick Up: A Practical Guide to  
Doing Theater with Children  
A How-To guide by Willie Reale with Playmaking  
lesson plans by Daniel Judah Sklar **\$35.00**

**Blunders, Oversights, and Corrections**



**Songs**

*All music composed by Dave Baron*

**True Friends Through Thick and Thin**

For All the Times ..... Lyrics by Isha Rodriguez

**Waffles and Barney**

Working Out the Time ..... Lyrics by Edith Berko-Nti

**The Tree Near the Lake**

Wish Come True Blues ..... Lyrics by Michael Castro

---

At this and all performances, the small but significant role of the teacher in *The Tree Near the Lake* will be played by Laura Lee Shink.

---

**And now, the true ages of the kids:**

Edith Berko-Nti .....	11	Christina Ramirez .....	8
Michael Castro .....	12	Isha Rodriguez .....	12
Aisha Jabour .....	11	Jaysunn Rosado .....	11
Matthew Jellison .....	10	Peter Ventura .....	12
Lorraine Zambrano .....	11		

The 52nd Street Project gratefully acknowledges the support of the following foundations and corporations: Barker Welfare Foundation, Berleiman's World of Expression Foundation, BETA Fund, Consolidated Edison, Cubic B's, Dramatic's Guild Fund, William and Mary Greve Foundation, Horace W. Goldsmith Foundation, Florence Gould Foundation, Heights Partners, Inc., Hennessy Foundation, Holland Lodge Foundation, Inc., Rita J. and Stanley H. Kaplan Foundation, Loyds Bank, M & T Trust, MCI Foundation, James A. Macdonald Foundation, Ann M. Martin Foundation, Morgan Stanley Foundation, J.P. Morgan Charitable Trust, Newman's Own, New World Foundation, The New York Times Co. Foundation, Northwest Point, Laura Pels Foundation, Carl and Lily Plotzheim Foundation, Inc., RJM Group, Fan Fox and Leslie R. Samuels Foundation, Sease Entertainment, Scheman Foundation, Seth Sprague Educational and Charitable Trust, Staging and Design, Inc., Jules and Doris Stein Foundation, Sutzberger Foundation, Sarina Foundation, Susquehanna, Travelers Foundation, Uniwold Group Inc., John A. Vassilios & Sons, Inc., Wachett, Lipson, Rosen & Katz, Life Acheson Wallace Funds, The West Bank Cafe, Writers & Artists. In addition, the following individuals made gifts of over \$150 to The 52nd Street Project this year:

Wendy Abrams	Barry Cohen	Sy Jacobs	Thomas Peters
Jane Alexander	Ruth Cohen	Marc Jaffe & May Wulfrich	Ethan Phillips
Brooke Allen	Thomas Cot	Linda Janklow	Robert & Susan Ochs Phillips
Julie Ang	Margaret Crimmins &	Larry Jones &	Nicholas Platt & Robyn Watts
Amy Aquino & McGinnis McCoy	Pierce Rafferty	Mary McGrath-Jones	Donna Plumrose & Todd Richter
Alan Arfa & Kay Matuschulat	Joan Straus Kulkarn	Nathan Joseph	Richard Polatschek
Nora Arfin & Jake Weber	Nadia Dajani	Marzella & Max Kahn	Christopher Randolph
Susan Adams & Ebon Shapiro	Arthur Dantchik	Betty & George Kaiser	Helen & Peter Randolph
Jane Ballinger & Michael Goldstein	Cathy Dantchik	Lee Kalkheim & Julia Lord	Tim Ray & Tyson Smith-Ray
Ben Barenholtz	Peter & Judith Dawkins	Eric Karpelos & Mike Sell	Wille Reale
Jessica Bauman	Mariama Depepe & Richard Hader	Sheila Kehue	Adam Reingold
Lisa Benavides & Tim Nelson	Donna & William DeGeta	Mark Kozepson &	Jonathan Rees
Emily Benoit	Cpa & Misha Dichter	Wendy Townsend	Alyson Rice-Taylor
Eleanor Bergstein	Stephen Dubner	Ania & Mark Kingdon	Todd Richter
Pamela Berlin & William Carden	Darryl Dunn & Mark Singer	Beth & Seth Klarman	Eric Ritter
Barry & Myrna Bernard	Amy Dzielakowski	Jeremy Koch	Tylnwaat Robertson
Alexander Bernstein &	Ned Eisenberg	Mary Kong	Betsy & Clifford Ross
Elizabeth Weissquez	Barbara Elinan	Jan Kroszka & Jacki Ochs	Jane Sangerman & Joseph Vedepekin
Ron & Susan Black	Barbara Ettinger	Belle & Roger Kohn	Karin & Tom Schall
Audrey Bloch &	Wendy Eltinger & Derek McLane	Judy Kuhn & David Schwab	Steve Schoell
Joseph Wessenthal	Lisa Frostom & Tim Sanford	Heidi Landensman	Dana Segal
Stuart Bloomberg & Mary Fanel	Irin & Sierra Fach	Jill Larson	Stefan Selig
Robi & Ruth Blumenstein	Tom Fontana & Sagan Lewis	Joshua Lehrer	Brian Sibersil and Patty Dryden
Sally Book & Mark Wurtel	Katherine Foster	Sarah Jane Leigh	Jacqueline Simon
Jane Collier & Steve Wertimer	David Frankel	Robert Sean Leonard	Meg Simon
Katherine Borowitz &	Kermit Frazier	Liza Lerner	John Slattery
John Tururo	Peter Freundlich & Mary Lou Teel	John Bedford Lloyd &	Luis Smith
Christina Boda Singleton	Amy Friedman	Ana Twomey	Abigail Solomon
Bertha & Samuel Britt	Louis & Patrice Friedman	Katherine Lumb & Joe Wale	Warren Spector
Eric Brooks	Peter Fritschel & Pamela Nelson	Mary McCann & Neil Pepe	Jean Stein
Becky Browder & Ted Neustadt	Joseph Gazdik	Marsue & Peter MacNicol	Tim Stephenson &
Deborah Brown	Gary Gerst	Greg MacPherson	Adriana Triguani
Susan Bruce & Peter Hodges	Sirma Gershenson	Bruce MacVie and Carol Ochs	Daniel Sween
Denise Burse &	Jenny Gersten	Peter Manning	Manko Tada
Peter Jay Fernandez	Ileen Getz & Mark Grinnell	Constance Mars	Jay Tames
Kate Burton & Michael Ritchie	Stephen and Cathy Graham	George Mavronicolas	Cathlene Thomas
Cora Cahlan & Bernard Gersten	Michael Grif	Max Meyer	Kip Thompson
Daniel & Maureen Cahill	Emily Grotzman &	Barbara McCrane & Paul Reale	Joan Vall & John Thome
Steven Callahan &	Susan Gimpfner	James McDaniel	Laura Valerbo
Christine Durn	Edmund Lewis Grossman &	Brian Merles & Jackie Reingold	Paul Valley
Camilla Campbell & Oliver Platt	Tracy Thome	Andy Milkin	Wendy vanden Heuvel
Louisa Campbell	Laura Guerra & Tucker McCrody	Walter Moskley	John Vassilios
Colleen Carol & Mitchell Semei	Lisa Gugenheim	Bill & Jane Muddyman	Susan Vitucci
Richard & Lisa Caahn	Andrew Haas	Patricia Murphy & Adam Spika	Emily Wachtel
John Cavello & Lucy Kaplan	Bill & Linda Halvonen	Edward Nashen	Elizabeth Warner
James Cayne	Stephen Hamilton &	Kate Neeligan & Robert Reale	Sam Waterston
Stockard Channing	Enma Walton	Randy & Roma Nelson	Sally Weiss
Rachel Chanoff	Marcia Gay Harden	Ruth Nelson	Robert Wiener
Peter Cherasia	Barnaby Harris	Helen & James Neuberger	Barbara & Max Wilk
Larry Cherloff & M. Rose Gasner	David Herdich	Renee Nouweid	Elizabeth Williams & Joseph Forte
Glenda Chesche	Peter Herdich & Karen Trott	Ethan Novack	Matt Williams
Marissa Chibaz &	Jane Hoffman	Steve Olsen	Valerie Wilson
Travis Preston	William Holtzman &	Kevin O'Rourke & Edith Thurber	Donald Windham
William Christian	S. Sylvia Shepard	John Payson	Josanne Woodward
Joe Christiano & Rande Goodwin	Barbara Howard	Charles & Jean Marie Pease	Janine & Jeffrey Yass
Bill & Linda Cobb	Michelle Hurst	In memory of Frances Peiper	James & Mary Lin Yoshimura
Ethan Coen & Trish Cooke	Annette Inradorf &	Bill & Joanna Persky	Neil Yoskin
Joel Coen & Fran McDormand	Mark Ethan Toporek	Alton & Elizabeth Peters	

as of 1/24/97

To those who made gifts of less than \$150, for which we have no font small enough, we give tumongous, extra bold and heartfelt thanks.

## The 52nd Street Project Presents

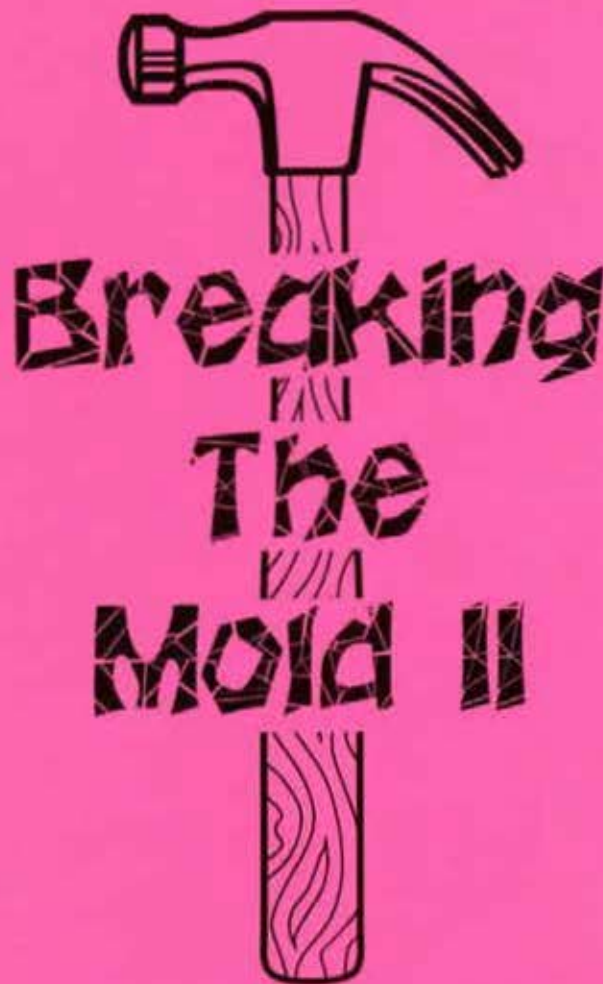

## Six Plays from The 52nd Street Project's 1997 Two-On-Two Program

Monday, January 27 at 6:30 and 8:30 p.m.  
Tuesday, January 28 at 6:30 and 8:30 p.m.

**The West Bank Cafe Downstairs Theater, New York City**



January 27th and 28th, 1997  
The West Bank Cafe Downstairs Theater, New York City

#### Project Staff

Willie Reale, Artistic Director  
Carol Ochs, Executive Director  
Michael Bernard, Associate Artistic Director  
Sally Bock, Director of Development and Marketing  
George Roman Babiak, Production Manager  
Susan J. Vitucci, Development Consultant  
Iris A. Brown, Graphic Designer  
Paola Fantini - Intern

#### Production Staff

Kevin Joseph Roach, Set Designer  
Hank Meiman, Lighting Designer/  
Stage Manager  
Sheila Kehoe, Costume Designer  
Jeremy M. Posner, Sound Designer  
Prop Designers:  
Scott Ramsay, George Babiak  
Light Board Operator:  
Greg Catellier  
Backdrop Scroller:  
Kimberly Kelly Wilson  
Furniture Crew:  
Jean-Paul Gressieux, Ray Harold  
Props Crew:  
Paola Fantini,  
Jonathan Santiago

Load-in and Light Hang Crew:  
Greg Catellier, Paola Fantini,  
Jean-Paul Gressieux, Ray Harold,  
Hank Meiman, Brian O'Neill  
House Managers:  
Beth Emelson, Laura Sametz  
Bartenders:  
Lisa Benavides, Denise Faye,  
Jenny Gersten, Michael Ritchie  
Wait staff:  
Jed Clarke, Jaya Rosado  
Flyer Design: Lisa Billard  
Program Layout: George R. Babiak  
Weekend-away Chefs:  
Daniel Swee,  
Mary Pat Walsh

#### Scrolling Backdrop Design and Paint Team

George Babiak, Renato Castilho, Betsy Foldes, Jannike Hess,  
Mark Kobak, Erick Kuo, Tiana Manfred, Paulo Mendoza, Marcelo Pontes,  
Kevin Joseph Roach, and John Steward  
*Special Design Mention:* Rich D'Agnello and Adam Rodriguez  
and many thanks to Katherine Lumb

The Two-On-Two Program is made possible, in part, by public funds from the New York State Council on the Arts, the Department of Youth Services, and the New York City Department of Cultural Affairs.

The 52nd Street Project is a non-profit organization that brings inner-city children from the Clinton neighborhood together with professional theater artists to create theater. **BREAKING THE MOLD II** is part of our Two-On-Two program, in which two of the Project's more seasoned kids are matched with two adult Project volunteers (one playwright, one director) and given the task of creating a short play. Each year, the duos travel *en masse* to Dutchess County, New York to rehearse the plays over a three-day weekend. This show is the fruit of their labors.

#### Board of Directors

Ben Barenholtz	Lisa Benavides
Rachel Chanoff	Wendy Ettinger, Chair
Louis P. Friedman	Stephen Graham
Larry Jones	Heidi Landesman
James McDaniel	Frances McDormand
Patricia M. Murphy, Esq.	Carol Ochs
Willie Reale	Pamala Tyson
Laura Valeroso	Elizabeth Williams

#### Special Thanks To:

Our most gracious hosts Wendy Ettinger and Derek McLane, Frances McDormand and Joel Coen, Maria Tucci, and Alice Provenson. Thanks also go to New Dramatists, Paul Smithyman and the Women's Interart Center, the Ensemble Studio Theatre, the TDF Costume Collection, and Steve Olsen, Hank Meiman, and The West Bank Cafe.

#### In-Kind Contributions:

Playwrights Horizons; Naked Angels; Ensemble Studio Theatre, Neil A. Mazzella & Hudson Scenic Studios, Inc.; Colorforms; Baron & Baron; Shays & Murphy; Iris A. Brown & Bernhard/Fudyma Design Group; Ron Kastner, Capital Printing; The Estate of Jonathan Larson; Nickelodeon; The Printing Store; New Dramatists; Steve Olsen & The West Bank Cafe; Materials for the Arts; Port Authority; Mayor's Office of Film & Television; John A. Vassilaros & Sons; Paris Chocolates; Scholastic Productions; Yorke Construction; Jomen Electrics; Revlon; Watkins Products; Tom Reale; Mario Egozzi; Stephen Graham; Emily Grishman; Mark Keoppen; Kevin Joseph Roach; Simma Gershenson, John Kain, and Mark Topping; Mary White; Heather Lester; Andy Millon; Reel-to-Real; The Lobster Club; H & H Bagels; Ben and Jerry's Times Square Scoop Shop; Boylan's Bottling Company; D'Agostino Supermarkets Inc.; the Progressive Image Group.

## Don't miss our upcoming shows!

**March 21-23**

Our latest batch of newcomers has just begun the Project's 10-week Playmaking program, taught by Michael Bernard. At the end of the class they will be whisked away to Connecticut for a weekend to fashion a set of plays based on the theme *The Big Question*. The only thing they will need: an audience.



**Monday, May 5**

*Save the Date for...*

# PANTS ON FIRE

Yes, we've finally got a theme for our annual benefit. Continuing the now time-honored tradition of game show spoofs, this year's extravaganza will be a send-up of that old TV standby, *To Tell The Truth*. The location will be announced very shortly, but for other information or reservations call **Sally Bock**, our highly intelligent and extremely friendly Director of Marketing and Development at 333-5252.

*And sometime this Summer (we hope!)...*

William Shakespeare's

## Twelfth Night



*...a musical adaptation performed by the Teens of the 52nd Street Project*

## Breaking the Mold II

*All music composed by Kim Sherman*

**Johnny Eyreco**

Written by Gina Torres

Directed by Stephen Haff

Johnny Eyreco ..... Ray Ocasio

Roxy Chesterfield ..... Sahara Walsh

**Princess In Waiting**

Written by Adrienne Shelly

Directed by Kirsten Sanderson

Hercula ..... Janice Santiago

Princess Jaye ..... Judy Agosto

Prince Dweeb ..... Jonathan Santiago

*Don't Bet On The Prince* lyrics by Adrienne Shelly

**Chained for Life**

Written by Michael Bernard

Directed by Dion Graham

Sam ..... Yull Neri Borda

Sadie ..... Tessa John-Connor

Guard ..... Ray Harold

Man ..... Jean-Paul Gressieux

Sheep ..... Paola Fantini, Jean-Paul Gressieux,

Ray Harold, Kimberly Kelly Wilson

*On The Lam and Old Friend, Old Friend* lyrics by Willie Reale

*(Continued on next page)*

*Breaking the Mold II* has no intermission, so get your Birch Beer Floats before the show starts.

Oh, and tip your waiters!



### Perfect Imperfection

Written by Liz Tuccillo

Directed by Jose Dominguez

Dr. Splock ..... Corinda Smith

Gregory, The Perfect Child ..... Ben Barthelemy

*I've Finally Done It and Love Me Baby* lyrics by Liz Tuccillo

### Women on the Verge

Written by Robert Shaffron

Directed by John Steber

Lena ..... Jonsi Smith

Susan ..... Deshana Hamid

Prison Matron ..... Paola Fantini

*I'm The Man and Crimes of Fashion* lyrics by Robert Shaffron

### God Stuff

Written by Jose Rivera

Directed by Gus Rogerson

God ..... Thomas Santoni

Rabbit, Wolf, and Man ..... Ahmed Attia

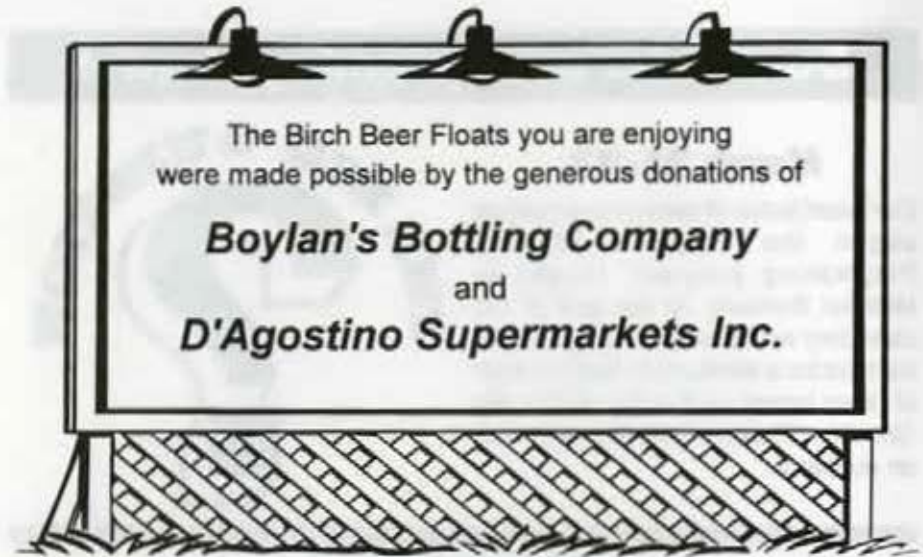

Thank you for coming to BREAKING THE MOLD II. If you are not on our mailing list (or if your address has changed), please fill out this form and give it to us on your way out or mail it to the address below. We would also like to know if you are interested in becoming a volunteer. We are always in need of help in *all areas*, so please fill out your name and phone number, and we'll call you.

#### PLEASE ADD ME TO YOUR MAILING LIST:

NAME \_\_\_\_\_

ADDRESS \_\_\_\_\_

ZIP \_\_\_\_\_

PHONE \_\_\_\_\_

#### YES, I WOULD LIKE TO BE OF HELP:

NAME \_\_\_\_\_

DAYTIME PHONE \_\_\_\_\_

I AM REALLY USEFUL AT (52nd Street Project related things only. Examples: Mailings, backstage help, fundraising, moving heavy items, etc.)...

If you would like to mail this (and you're always welcome to enclose a tax-deductible contribution), you can send it to:  
The 52nd Street Project 500 West 52nd St. New York, NY 10019  
(212) 333-5252

The 52nd Street Project gratefully acknowledges the support of the following foundations and corporations: Barker Welfare Foundation, Bertelmann's World of Expression Foundation, BETA Fund, Consolidated Edison, Cubic R's, Florence Gould Foundation, Drametta's Guild Fund, William and Mary Greve Foundation, Horace W. Goldsmith Foundation, Florence Gould Foundation, Heights Partners, Inc., Hennessy Foundation, Holland Lodge Foundation, Inc., Rita J. and Stanley H. Kaplan Foundation, Jonathan Larson Performing Arts Foundation, Lloyds Bank, M & T Trust, MCJ Foundation, James A. MacDonald Foundation, Ann M. Martin Foundation, Morgan Stanley Foundation, J.P. Morgan Charitable Trust, Newman's Own, New World Foundation, The New York Times Co. Foundation, Northwest Point, Laura Pelt Foundation, Carl and Lily Plotzheimer Foundation, Inc., RJM Group, Fan Fax and Leslie R. Samuels Foundation, Savon Entertainment, Sherman Foundation, Seth Sprague Educational and Charitable Trust, Staging and Design, Inc., Jules and Doris Stein Foundation, Sutzberger Foundation, Sunma Foundation, Sushpanama, Travelers Foundation, Lineworld Group Inc., John A. Vassilatos & Sons, Inc., Wachtel, Lipson, Rosen & Katz, Liz Acheson Wallace Funds, The West Bank Cafe, Writers & Artists, York Construction. In addition, the following individuals made gifts of over \$150 to The 52nd Street Project this year:

Wendy Abrams	Ruth Cohen	Marc Jaffe & May Wulbrich	Ethan Phillips
Jace Alexander	Thomas Cott	Linda Janklow	Robert & Susan Ochs Phillips
Brooke Allen	Margaret Grimes &	Larry Jones &	Nicholas Platt & Robyn Watts
Jule Ang	Pierce Rafferty	Mary McElrath-Jones	Donna Plummer & Todd Richter
Amy Aquino & McGinnis McCoy	Joan Straus Cullman	Nathan Joseph	Richard Polachek
Alan Arfa & Kay Matschulat	Nadia Dajani	Marcella & Max Kahn	Christopher Randolph
Nora Arlin & Jake Weber	Paul Daniels	Betty & George Kaiser	Helen & Peter Randolph
Susan Atkins & Ebon Shapiro	Arthur Danichik	Lee Kalchauer & Julia Lord	Tim Ray & Tyson Smith-Ray
Jane Ballinger & Michael Goldstein	Cathy Danichik	Eric Karpeles & Mike Sell	Wile Reale
Ben Barenholtz	Peter & Judith Dawkins	Sheila Kehoe	Adam Reingold
Jessica Bauman	Marilena Deppe & Richard Hadar	Mark Kacoper &	Jonathan Reiss
Lea Benavides & Tim Nelson	Donna & William DeSeta	Wendy Townsend	Alyson Rice-Taylor
Emily Benton	Cipa & Misha Dichter	Ania & Mark Kingdon	Todd Richter
Eleanor Bergstein	Stephen Dobner	Beth & Seth Klarman	Eric Rider
Pamela Berlin & William Cardon	Darcy Dunn & Mark Singer	Jeremy Koch	Tyfreast Robertson
Barry & Myra Bernard	Amy Drowonkewski	Mary Kong	Betsy & Clifford Ross
Alexander Bernstein &	Ned Eisenberg	Jan Krosz & Jacki Ochs	Jane Sangerman &
Elizabeth Velazquez	Barbara Etkin	Belle & Roger Kuhn	Joseph Vadapalas
Ron & Susan Black	Barbara Etkinger	Judy Kuhn & David Schwab	Karin & Tom Schall
Audrey Bloch &	Wendy Etkinger & Derek McLane	Heidi Landerman	Steve Schollet
Joseph Wiesenfeld	Lisa Finstrom & Tim Sanford	Jill Larson	Dana Segal
Stuart Bloomberg & Mary Farrell	Ineh & Simra Fisch	Joshua Lehrer	Stefan Seig
Robi & Ruth Blumentstein	Tom Fontana & Sagan Lewis	Sarah Jane Leigh	Brian Sibeloff and Patty Dryden
Sally Bock & Mark Wurbl	Katherine Foster	Robert Sean Leonard	Jacqueline Simon
Jane Bolster & Steve Wertimer	David Frankel	Liza Lerner	Meg Simon
Katherine Borowitz & John Turturro	Karmit Frazier	John Bedford Lloyd &	Mark Singer
Cristina Botta Singleton	Peter Freundlich & Mary Lou Teel	Arvi Twomey	John Stabory
Bertha & Samuel Britt	Amy Friedman	Katherine Lumb & Joe Vitale	Lori Smith
Eric Brooks	Louis & Patrice Friedman	Mary McCann & Neil Pepe	Abigail Solomon
Becky Browder & Ted Neustadt	Peter Fritchel & Pamela Nelson	Marsus & Peter MacNeel	Warren Spector
Deborah Brown	Joseph Gazdick	Greg MacPherson	Jan Zain
Susan Bruce & Peter Hedges	Gary Gersh	Bruce MacVine & Carol Ochs	Tim Stephenson & Adriana Tripani
Denise Burse &	Simma Gershtenon	Peter Manning	Eric Stoltz
Peter Jay Fernandez	Jenny Gerstein	Constance Mars	Daniel Sweet
Kate Burton & Michael Fitzhie	Ileen Getz & Mark Grinnel	George Mavronicolas	Marko Tade
Cora Cahen & Bernard Gerster	Stephen and Cathy Graham	Max Mayer	Jay Tarnes
Daniel & Maureen Cahill	Michael Grief	Barbara McCrane & Paul Reale	Cathrine Thomas
Steven Callahan &	Emily Grishman &	James McDaniel	Kip Thompson
Christine Dunn	Susan Sampiner	Brian Merles & Jackie Reingold	Joan Vall & John Thome
Camilla Campbell & Oliver Platt	Edmund Lewis Grossman &	Andy Milon	Laura Valeroso
Louisa Campbell	Tracy Thorne	Water Mosley	Paul Valley
Colleen Carroll & Mitchell Sarnel	Laura Guerra & Tucker McCrady	Bill & Jane Muddyman	Wendy vanden Heuvel
Richard & Lisa Cashin	Lea Gugenheim	Patricia Murphy & Adam Spika	John Vansbars
John Cavello & Lucy Kaplan	Andrew Haas	Edward Nishen	Susan Vitucci
James Cayne	Bill & Linda Halvorsen	Kate Nelligan & Robert Reale	Emily Wachel
Stockard Channing	Stephen Hamilton & Emma Walton	Randy & Rosa Nelson	Elizabeth Warner
Rachel Chanoff	Marcia Gay Harden	Ruth Nelson	Sam Waterston
Schroyer Chapin	Bernady Harro	Helen & James Neuberger	Sally Weiss
Peter Cherasia	David Herdrich	Renae Neuwald	Robert Wiener
Larry Chertoff & M. Rose Gasner	Peter Herdrich & Karen Trot	Elen Novack	Barbara & Max Wilk
Glenda Cheslik	Jane Hoffman	Steve Olan	Elizabeth Williams & Joseph
Martina Chibas & Travis Preston	William Hottzman &	Kevin O'Rourke & Edith Thurber	Matt Williams
William Christian	S. Sylvia Shepard	John Payson	Valerie Wilson
Joe Christiano & Rande Goodman	Barbara Howard	Charles & Jean Marie Pease	Donald Windham
Bill & Linda Cobb	Michelle Hurst	In memory of Frances Peper	Joanne Woodward
Ethan Coen & Trish Cooke	Annette Insdorf &	Bill & Joanna Persky	Janine & Jeffrey Yata
Joel Coen & Fran McDormand	Mark Ethan Toponek	Alton & Elizabeth Peters	James & Mary Lin Yoshimura
Bary Cohen	Sy Jacobs	Thomas Peters	Neil Yoskin

To those who made gifts of less than \$150, for which we have no font small enough, we give humongous, extra bold and heartfelt thanks.

The 52nd Street Project Presents

# THE BIG QUESTION



The Winter, 1997 Playmaking Series

Friday, March 21st at 7:30 p.m.

Saturday, March 22nd at 3:00 and 7:30 p.m.

Sunday, March 23rd at 3:00 p.m.

at The Ensemble Studio Theatre, 549 West 52nd Street

# THE BIG QUESTION

The Winter 1997 Playmaking Plays

March 21-23, 1997 The Ensemble Studio Theatre, New York City

## Project Staff

Willie Reale, Artistic Director  
Carol Ochs, Executive Director  
Michael Bernard, Associate Artistic Director  
Sally Bock, Director of Development and Marketing  
George Roman Babiak, Production Manager  
Susan J. Vitucci, Development Consultant  
Iris A. Brown, Graphic Designer  
Jean-Paul Gressieux, Justin Denmark - Interns



## Production Staff

Kevin Joseph Roach, Set Designer  
Greg MacPherson, Lighting Designer  
Crystal Thompson, Costume Designer  
Jeremy M. Posner, Sound Designer  
Prop Designers:  
Scott Ramsay, George Babiak,  
Jean-Paul Gressieux,  
Nedra Gallegos  
Slide Coordinator: Katherine Lumb  
Slide Designers:  
George Babiak, Rich D'Agnello,  
Adam Rodriguez, John Steward,  
Alberta Testanero  
Doug Nervik, Composer  
Erica Burds, Costume assistant  
Judy Tucker, Stage Manager  
Slide Operator: Jean-Paul Gressieux

Furniture Crew:  
Stewart Sarkozy-Banoczy, Ray Harold  
Props Crew:  
Jilly Crook, Jed Clarke  
Colorformist:  
Kate Ryan  
Load-in and Light Hang Crew:  
Catie Baumer, Kaleda Davis,  
Justin Denmark, Nedra Gallegos,  
Kevin Geer, Simma Gershenson,  
Jean-Paul Gressieux, Gheree O'Bannon,  
Gus Rogerson, Kate Ryan  
House Manager: Karin Schall  
Flyer/Program Artwork: Adam Rodriguez  
Flyer Layout: Rich D'Agnello  
Program Layout: George R. Babiak  
Weekend away chef: Charlotte Armstrong

The Playmaking Program is made possible, in part, by public funds from the New York State Council on the Arts, the Department of Youth Services, and the New York City Department of Cultural Affairs.

The 52nd Street Project is a non-profit organization that brings children from the Hell's Kitchen/Clinton neighborhood together with professional theater artists to create theater. **THE BIG QUESTION** is part of our Playmaking program. Young people participate in eight weeks of classes taught by Michael Bernard and adapted for the Project by Daniel Judah Sklar from his book, *Playmaking: Children Writing and Performing Their Own Plays*. During the class sessions, participants learn the elements of drama and write their first play. At the end of the class, each child is given two actors, a theme and a director who guides him or her through the writing of a play during a weekend retreat in the country. **THE BIG QUESTION** is the fruit of their labors.

The Project is delighted to return to the Ensemble Studio Theatre, where we have been performing since our inception in 1981. We congratulate EST on its 25th anniversary and gratefully acknowledge the fact that if they weren't here we'd be nowhere.

## Board of Directors

Ben Barenholtz	Lisa Benavides
Rachel Chanoff	Ruth Cohen
Wendy Ettinger, Chair	Louis P. Friedman
Stephen Graham	Larry Jones
Heidi Landesman	James McDaniel
Frances McDormand	Patricia M. Murphy, Esq.
Carol Ochs	Willie Reale
Pamala Tyson	Laura Valeroso
Elizabeth Williams	

## Special Thanks To:

Our gracious weekend-away hosts Stephen and Cathy Graham, Wendy vanden Heuvel and Brad Coley, and Laura Eldridge and the Kent School. Thanks also go to Celia and Bonnie, Holly Hynes, and Curt, Jamie, Abigail, and the Ensemble Studio Theatre, and the Mayor's Office of Film and TV.

## In-Kind Contributions:

Neil A. Mazzella & Hudson Scenic Studios, Inc.; Colorforms; Baron & Baron; Shays & Murphy; Christine Dunn; Iris A. Brown & Bernhard/Fudyma Design Group; Ron Kastner, Capital Printing; The Estate of Jonathan Larson; Nickelodeon; The Printing Store, New Dramatists; Materials for the Arts; Port Authority; John A. Vassilaros & Sons, Paris Chocolates, Scholastic Productions, Yorke Construction; Jomen Electrics; Revlon, Watkins Products; Tom Reale; Mario Egozzi; Emily Grishman; Mark Keoppen; Kevin Joseph Roach; Simma Gershenson, John Kain, and Mark Topping; Mary White; Heather Lester; Andy Millon; Reel-to-Real; The Lobster Club; H & H Bagels; Ben and Jerry's Times Square Scoop Shop; the Progressive Image Group.

**Don't miss our upcoming shows!**

**Monday, May 5**

# PANTS ON FIRE

Continuing the now time-honored tradition of game show spoofs, this year's extravaganza will be a send-up of that old TV standby, "To Tell The Truth." It will be at the **Harmony Palace** at 98 Mott Street, and the highlight may well be the 11-course Chinese banquet. For more information or reservations call **Sally Bock**, our very tidy Director of Marketing and Development (who is looking for an apartment) at 333-5252.

*Sometime this summer (with luck!)*...

William Shakespeare's

## Twelfth Night



*...a musical adaptation to be performed in New York and the South of France (yes, the South of France) by the Teens of the 52nd Street Project*

*In July and August...*

The Block Island, R.I. and Tyler Hill, Pa.

# ONE-on-ONES

*So easy you can do it in your own home:* Take a kid; give him or her an adult who writes a play for the two of them to perform; multiply by 10. Take all 10 pairs away for a week in the country to rehearse. Bring them back to the city and set them up with a theatre. Invite an audience. You can do all this, or you can just come and watch the show we produce.

THE BIG QUESTION: THE WINTER 1997 PLAYMAKING PLAYS

**ACT 1**

*All music composed by Doug Nervik*

### Tell Me The Truth

Written by Hallie Gibson, age 11

Dramaturg/Director, Lisa Benavides

Deborah ..... Lois Smith

Josh ..... José Soto

### Love Me or Not?

Written by Vionel Ortiz, age 12

Dramaturg/Director, Diana Son

John J. .... Larry Nathanson

Lilli ..... Michaela Murphy

R.J. .... Jed Clarke

### One Crazy Married Couple

Written by Jaya Rosado, age 12

Dramaturg/Director, Anna Li

Bob ..... Danny Jenkins

Anna ..... Allison Eikerenkoetter

The Boss ..... Danny Johnson

### Friends Don't Pressure You

Written by Jayme Rosado, age 10

Dramaturg/Director, Adrienne Shelley

Boogie ..... Alex Draper

Lizette ..... Elina Löwensohn

Dad/Teacher ..... Michael Bernard

### Wager to Wager to Thirty

Written by Anton Spivack, age 11

Dramaturg/Director, Tim Nelson

Juise ..... Kevin Geer

Jessica Giraffe/Game Show Host ..... Oliver Platt

Telly Vision ..... Arthur French

The Rock ..... George Babiak

**INTERMISSION**

## ACT 2

### Chichi's Big Escape

Written by Mayleen Cancēl, age 11  
Dramaturg/Director, Michael Bernard

Chichi ..... Darrel Carev  
Marylin ..... Lenore Pemberl  
The Evil Zookeeper ..... Stewart Sarkozy-Banoczy  
Richie ..... David Wiater

"Pickin' The Lock" lyrics by Mayleen Cancēl

### Problem Solved

Written by Samantha Soto, age 11  
Dramaturg/Director, Wendy vanden Heuvel

Legs ..... Taro Alexander  
Toon ..... Cecilia Arana

"Friendship" lyrics by Samantha Soto

### Dream Love

Written by Galo Santana, age 14  
Dramaturg/Director, Danny Johnson

John ..... Walker Jones  
Mary ..... Camilia Sanes  
Voice of Mike ..... George Babiak  
Voice of John's Mom ..... Jilly Crook  
Voice of Will Watson ..... Willie Reale

### Tina and Tira's Adventure With The Devil

Written by Mona Lisa Barthelemy, age 10  
Dramaturg/Director, Elizabeth Keiser

Tina ..... Robin Miles  
Tira ..... Angie Phillips  
The Devil ..... Tom Schall



## ON SALE IN THE LOBBY

### Cool Stuff

The Fabulous Flyer Bar  
(in five mouth-watering flavors!)  
\$2.00 and \$1.50. \$1.00 for kids

52nd Street Project T-Shirts  
with Shel Silverstein's logo  
\$12.00

52nd Street Project Caps  
\$15.00

### 52nd Street Project Books

52 Pick Up: A Practical Guide to  
Doing Theater with Children  
A How-To guide by Willie Reale with Playmaking  
lesson plans by Daniel Judah Sklar \$35.00

Playmaking: Children Writing and  
Performing Their Own Plays  
by Daniel Judah Sklar \$14.00

Thank you for coming to THE BIG QUESTION. If you are not on our mailing list (or if your address has changed), please fill out this form and give it to us on your way out or mail it to the address below. We would also like to know if you are interested in becoming a volunteer. We are always in need of help in **all areas**, so please fill out your name and phone number, and we'll call you.

### PLEASE ADD ME TO YOUR MAILING LIST:

NAME \_\_\_\_\_

ADDRESS \_\_\_\_\_

ZIP \_\_\_\_\_

PHONE \_\_\_\_\_

### YES, I WOULD LIKE TO BE OF HELP:

NAME \_\_\_\_\_

DAYTIME PHONE \_\_\_\_\_

I AM REALLY USEFUL AT (52nd Street Project related things only. Examples: Mailings, backstage help, fundraising, moving heavy items, etc.)...

If you would like to mail this (and you're always welcome to enclose a tax-deductible contribution), you can send it to:  
The 52nd Street Project 500 West 52nd St. New York, NY 10019  
(212) 333-5252



# PANTS ON FIRE

THE 52ND STREET PROJECT ANNUAL GALA

**May 5, 1997**

HARMONY PALACE

**Board Chairperson**  
WENDY ETTINGER

**Artistic Director**  
WILLIE REALE

**Executive Director**  
CAROL OCHS

## Honorary Chairs

WHOOPI GOLDBERG & FRANCES MCDORMAND

## Co-Chairs

LISA BENAVIDES, BECKY BROWDER,  
RACHEL CHANOFF, LOUIS P. FRIEDMAN, PATRICE  
FRIEDMAN, KARIN SCHALL &  
LAURA VALEROSO

## The Board of Directors of The 52nd Street Project

BEN BARENHOLTZ, LISA BENAVIDES,  
RACHEL CHANOFF, RUTH COHEN,  
WENDY ETTINGER, CHAIR, LOUIS P. FRIEDMAN,  
STEPHEN GRAHAM, LARRY JONES,  
HEIDI LANDESMAN, JAMES MCDANIEL,  
FRANCES MCDORMAND,  
PATRICIA M. MURPHY, ESQ., PAMALA TYSON,  
LAURA VALEROSO & ELIZABETH WILLIAMS

## The 52nd Street Project Gratefully Acknowledges

BIG APPLE LIGHTS, BMG ENTERTAINMENT, MASQUE  
SOUND, NICKELODEON, PARIS CHOCOLATES,  
SCHOLASTIC PRODUCTIONS VASSILAROS COFFEE,  
FREDERICK WILDMAN AND SONS, LTD.

FOR THEIR GENEROUS DONATIONS OF  
PRODUCTS AND SERVICES TO  
PANTS ON FIRE

## The Pants On Fire Players

### The Host

FRANCES MCDORMAND

### The Celebrity Panel

LEWIS BLACK, JED CLARKE,  
NATASHA RICHARDSON, JOANNE WOODWARD

### The Contestants

OSAGE LEWIS, JAMES MCDANIEL,  
TANIKA PARSONS, RUFUS READ,  
JAYA ROSADO, MARISA TOMEI

### The Spokesmodels

CANDY GODOY, GEOFFREY HOLDER,  
TESSA JOHN-CONNOR

### The Director

MARK LINN-BAKER

### The Composer and Musical Director

HENRY KRIEGER

### The Lyricist

WILLIE REALE  
"LIE-DAY" AND "PLEDGE OF TRUTH"

### The Writers

MICHAEL BERNARD AND WILLIE REALE

## Big Fat Liars

ARTHUR DANTCHIK  
CATHY & STEPHEN GRAHAM\*  
MATT WILLIAMS,  
WIND DANCER PRODUCTION GROUP

## Truth Stretchers

BEN BARENHOLTZ,\*  
BARENHOLTZ PRODUCTIONS  
BLAISE BOX,\*  
STAGING & DESIGN INC.  
DONALDSON, LUFKIN & JENRETTE\*  
LOUIS P. FRIEDMAN\* &  
PATRICE FRIEDMAN\*  
WENDY ETTINGER\* &  
DEREK MCLANE\*  
CHRISTINE CHAMBERS GILFILLAN,  
MCJ FOUNDATION  
MARY KONG

GREG MACPHERSON\* &  
JANE PERLMUTTER\*  
NEW WORLD FOUNDATION  
PETER PHILLIPS,\*  
LLOYDS BANK PLC  
SAUCE ENTERTAINMENT  
JOHN A. VASSILAROS\* &  
SON, INC.  
LAURA VALEROSO\* &  
DAVID SEIDMAN\*  
YORKE CONSTRUCTION CORP.\*

## White Liars

BILL BAGGITT & HILARY GILFORD  
ANDREW & LOUISE BERGMAN  
ELEANOR BERGSTEIN  
BARRY & MYRNA BERNARD\*  
LAURA BLANCO\* &  
ROBERT SHAINHEIT  
CRISTINA BOTTA &  
JAMES SINGLETON  
KATE BURTON\* &  
MICHAEL RITCHIE\*  
KATHLEEN & HENRY CHALFANT\*  
ETHAN COEN\* & TRISH COOKE\*  
RUTH COHEN\*  
JOHN CUNNINGHAM  
PAUL DANIELS\*  
PETER & JUDITH DAWKINS  
STEPHEN DUBNER\*  
BARBARA ELIRAN & PETER GOETZ  
MARCUS ENGLEFIELD  
ERIC & JULI FRANKEL\*  
MACELLIS GLASS  
MARCIA GAY HARDEN &  
THADDEUS SCHEEL  
JANE HOFFMAN\*  
BARBARA HOWARD  
AMY IRVING  
HOPE GLADNEY JESSUP  
M. LYNNE JOHNSON\*  
LARRY & MARY JONES\*  
JAN KROEZE\* & JACKI OCHS\*  
DAVID KUHN

HEIDI LANDESMAN\*  
ELAINE & HOWIE LANGBAUM  
SUE LEIBMAN  
ELLEN LEWIS  
KENNETH AND EVELYN LIPPER  
FOUNDATION  
DAVIEN LITTLEFIELD  
KATHERINE LUMB & JOSEPH VITALE  
LIZ MANNE  
GEORGE MAYER  
JEFFREY & KATINA MAYER  
MAX MAYER\*  
BRIAN MERTES\* & JACKIE REINGOLD\*  
KATE NELLIGAN\* & ROBERT REALE\*  
KEVIN O'ROURKE\* & EDITH THURBER\*  
TODD RICHTER\*  
BETSY & CLIFFORD ROSS  
HOWARD RUBIN  
STEFAN SELIG\*  
JEFFREY SELLER  
KEN SMITH  
DAVID SNEDDON & KRISTINE  
FLEISHER  
WARREN SPECTOR &  
MARGARET WHITTON  
LILI TAYLOR\*  
SUSAN VITUCCI\*  
MARY PAT WALSH\*  
LAURA WEIL  
ELIZABETH WILLIAMS\* &  
JOSEPH FORTE\*

## Fibbers

MICHELE ABELES  
JACE ALEXANDER  
ALEX ALEXANIAN  
BROOKE ALLEN  
MAY AMEEN  
ALAN ARFFA\* & KAY MATSCHULLAT\*  
JUNE BALLINGER\* & MICHAEL  
GOLDSTEIN\*

DREW BARR  
LISA BENAVIDES\* & TIM NELSON\*  
PAMELA BERLIN\* & WILLIAM CARDEN\*  
MICHAEL BERNARD  
ELIZABETH & ALEXANDER BERNSTEIN\*  
OLIVIA BIRKELUND  
LEWIS BLACK  
RICHARD BLACKSTONE\*

AUDREY BLOCH & JOSEPH  
WIESENTHAL  
ROBI & RUTH BLUMENSTEIN  
JANE BOLSTER & STEVE WERTIMER  
PATRICK BREEN  
BECKY BROWDER\* & TED NEUSTADT\*  
ANN BROWN  
LEE BRYANT  
DENISE BURSE\* &  
PETER JAY FERNANDEZ\*  
CORAHAN\* & BERNARD GERSTEN\*  
STEVEN CALLAHAN & CHRISTINE  
DUNN  
CAMILLA CAMPBELL\* & OLIVER PLATT\*  
JOHN CAVELLO & LUCY KAPLAN  
RACHEL CHANOFF\*  
LARRY CHERTOFF & ROSE GASNER  
GLENDA CHESSHIR  
MARISSA CHIBAS\* & TRAVIS  
PRESTON\*  
WILLIAM CHRISTIAN\*  
HELEN COOK  
THOMAS COTT\*  
MARGARET CRIMMINS & PIERCE  
RAFFERTY  
R.J. CUTLER  
JOSIE DE GUZMAN & ANDRE JAECKLE  
MARTHA DEUTSCHER  
RICK DRESSER  
ANN DULYE  
CHARLES & JOSEPHINE DUMAS  
CHRISTOPHER & KAREN EDDOWES  
NED EISENBERG\*  
JANET & BART ELSBACH  
BETH EMELSON\*  
DEE EMMERSON  
?ANN ERNI & DEE TRUSSELL

BARBARA L. ETTINGER  
BETTY FABER  
DENISE FAYE  
ED FIELDS & LISA ZEFF  
IRWIN & SYMRA FISCH  
NAOMI FREUNDLICH & CHARLES  
MILES  
CELIA GERSHENSON  
REBECCA GERSHENSON  
SIMMA GERSHENSON\*  
JENNY GERSTEN\*  
JILIAN CAHAN GERSTEN  
ILEEN GETZ & MARK GRINNELL  
EMILY GRISHMAN\* &  
SUSAN SAMPLINER\*  
LISA GUGENHEIM\*  
EVAN HANDLER\*  
PETER HERDRICH & KAREN TROTT  
WILLIAM HOLTZMAN\* &  
S. SYLVIA SHEPARD\*  
SARAH HOROWITZ  
DANA IVEY  
ALISON JACOBS  
PETER JACOBSON & WHITNEY SCOTT  
MARC JAFFE & MAY WUTHRICH  
ELAINE JENSEN LI  
JAY JOLLY  
LEE KALCHEIM  
ERIC KARPELES\* & MIKE SELL\*  
ALISON KATZ  
MARK KEOPPEN & WENDY TOWNSEND  
RUSTY KING  
WOODIE KING & ELIZABETH VAN DYKE  
JOSEPH & FRAN KOLKER  
JUDY KUHN\* & DAVID SCHWAB\*  
ELIZABETH & JEFFREY LANGE  
JILL LARSON\*

## Contributors

MARK AHERN  
MIRIAM ARIANO & STEVEN JACOBSON  
PETER ASKIN  
STUART BLOOMBERG & MARY  
FARRELL  
SAMUEL & BERTHA BRITT  
LAURA CALLANAN & ROMULUS LINNEY  
STOCKARD CHANNING \*  
JOANNA & TED CHAPIN  
SCHYULER CHAPIN  
MICHAEL CONNELLY  
ANNA CROUSE  
JOAN STRAUS CULLMAN  
PAUL DANIELS \*  
VINCE DEGIAIMO  
CIPA & MISHA DICHTER  
THOMAS DOOLEY  
JOANNE EDGAR  
DEBORAH FEHR  
LISA FINSTROM\* & TIM SANFORD\*  
MARK FRANCIS  
JUDITH GARSON & STEVEN  
RAPPAPORT  
GREG GERMANN & CHRISTINE  
MOURAD  
NANCY GILES  
MARIAN GODFREY

ED & FLAVIA GRIMM  
JEFFREY GROSS  
TERRI GUARNIERI & ABE HOCH  
ALBERT R. GURNEY \*  
BARNARD HUGHES\* & HELEN  
STENBORG\*  
NICHOLAS HYTNER  
ANNETTE INSDORF\* & MARK ETHAN\*  
BENOIT JAMAR  
LINDA JANKLOW  
MAX & MARCY KAHN  
LESLIE KANTOR & HENRY SILVER  
PHYLLIS KAUFMAN\*  
BELLE & ROGER KUHN  
LAWRENCE LAVINE  
ELLIOT LAWRENCE  
JOHN LEIGHTON  
SHIRA LEVIN  
MORTON & GEORGETTE LEVY\*  
BYRON LEWIS, UNIWORLD GROUP  
KENNETH & EVELYN LIPPER  
FOUNDATION  
CAROLYN & BERNIE LIPPERT  
ROMA MAFFIA\*  
PINKS & MARTIN LONDON  
JEFFREY & KATINA MAYER  
NEIL MAZZELLA\* & LAURIE

BEECHMAN\*  
ANNE MEARA & JERRY STILLER  
DANNY & AUDREY MEYER  
CASSANDRA MORGAN  
NILS NILSON & LESLIE SCHINE  
STEVE OLSEN  
??KRISTINE PANKOW &  
KRISTINE SUTHERLAND  
LISA PAWEL & RICK SCHLESINGER  
BUFF & JIM PENROSE  
FREDERICK & JACQUELYN PLATE  
ELIZABETH RIGG  
HERALD RITCH  
DARRYL ROTH  
HOWARD RUBIN  
PATRICIA SARANIERO & BEN THORON

HARVEY & VERA SHAPIRO  
WARREN SPECTOR & MARGARET WHITTON  
PAUL SPERRY  
ERIC STOLTZ  
JEAN & JUSTIN STRAUSS  
ED & LAUREL STRONG  
LINDA SWARTZ  
BOB & SALLY SWITHERS  
GINA TORRES  
TONY WALTON  
WENDY WASSERSTEIN  
ANDY & HANNAH WOLK  
BILL WRUBEL

AS OF APRIL 30, 1997

\* DESIGNATES BENEFIT COMMITTEE MEMBER

## Production Staff

DEREK MCLANE, SET DESIGN  
GREG MACPHERSON, LIGHTING DESIGN  
TOM MORSE, SOUND DESIGN  
SCOTT RAMSAY, SET CONSTRUCTION  
SIMMA GERSHENSON, STAGE MANAGER

## The 52nd Street Project Staff

WILLIE REALE, ARTISTIC DIRECTOR  
CAROL OCHS, EXECUTIVE DIRECTOR  
MICHAEL BERNARD, ASSOCIATE ARTISTIC DIRECTOR  
SALLY BOCK, DIRECTOR OF DEVELOPMENT  
GEORGE R. BABIAK, PRODUCTION MANAGER  
ERIS MIGLIORINI, BENEFIT ASSISTANT  
SUSAN J. VITUCCI, DEVELOPMENT CONSULTANT  
IRIS A. BROWN, STAFF GRAPHIC DESIGNER  
JEAN-PAUL GRESSIEUX, INTERN

## Special Thanks

JENNY BROWN, TOM CAROZZA, BETSY FOLDES,  
JENNY GERSTEN, CHUCK HAROLD, MARK HOOPER,  
HANK MEIMAN, KIM WILSON,

WARREN LEIGHT  
LIZA LERNER \*  
ANNA LI\*  
JOHN BEDFORD LLOYD\* & ANNE TWOMEY\*  
MARJORIE LOGGIA  
JOHN S. LYONS\*  
BRUCE MACVITTIE\*  
SARAH MALIN\*  
PETER MANNING\*  
HARRIET MATSCHULLAT  
MARY MCCANN & NEIL PEPE  
MARY MCCORMACK  
BARBARA MCCRANE\* & PAUL REALE\*  
PAUL MCCRANE\*  
TIM MEADOWS  
MARY LOU & DREW MILITANO  
ANDY MILLON\*  
MICHAELA MURPHY\* &  
LARRY NATHANSON\*  
PATRICIA MURPHY ESQ. & ADAM SPILKA  
CURT & LESLIE MYERS  
FRED NELSON & ELIZABETH WARNER  
JIM NEUWIRTH & LAURIE SUDE  
STEVE OLSEN\*  
SUSAN & ROBERT PHILLIPS\*  
RHONDA PRICE  
CHRISTOPHER RANDOLPH\*  
GENA RAPS  
DANA REEVE  
KEN & MICHELE RICHARDSON  
PETER ROFFMAN  
DAVID ROSENBERG  
CINDY ROSS  
DONALD ROTHSCHILD &  
LOTTCHEN SHIVERS  
DANIEL & JANICE ROUS\*  
JOHN RUBIN  
JANE SANGERMAN & JOSEPH VADAPALAS  
KARIN & TOM SCHALL\*  
MARY ANNE & KEN SCHUSTER  
MARGUIRITE SCOTT  
MITCHELL & COLLEEN SEMEL  
ROBERT SHAFFRON\*  
ADRIENNE SHELLEY\*  
MARC SHOLES & ESTHER TREITEL  
LESLIE SIMITCH  
DARCY DUNN & MARK SINGER  
LOIS SMITH  
ABIGAIL SOLOMON  
JOHN STEBER\*  
FISHER STEVENS  
MICHAEL STOTTS  
ALEXANDRA STYRON  
?SUSANNA STYRON & DARRELL LARSEN  
MARIKO TADA\*  
ALISON TATLOCK & DAVID WIATER  
STEPHEN TOBIAS  
ADRIANA TRIGIANI\* & TIM STEPHENSON\*  
LIZ TUCCILLO  
ELIOT & HARRIET VINES  
EMILY WACHTEL\*  
BORAH & MILDRED WALTON  
AMANDA WEIL  
SUSAN WILLERMAN  
GARY WINICK  
MARK WURFEL



The 52nd Street Project gratefully acknowledges the support of the following foundations and corporations: Banker Welfare Foundation, Berlinsmann's World of Expression Foundation, BETA Fund, Consolidated Edison, Cubic Etc, Florence Gould Foundation, Dramatists Guild Fund, William and Mary Greve Foundation, Horace W. Goldsmith Foundation, Florence Gould Foundation, Heights Partners, Inc., Hennessy Foundation, Holland Lodge Foundation, Inc., Rita J. and Stanley H. Kaplan Foundation, Jonathan Larson Performing Arts Foundation, Lloyds Bank, M & T Trust, MACJ Foundation, James A. Macdonald Foundation, Ann M. Martin Foundation, Morgan Stanley Foundation, J.P. Morgan Charitable Trust, Newman's Own, New World Foundation, The New York Times Co. Foundation, Northwest Plant, Laura Peis Foundation, Carl and Lily Pflanzner Foundation, Inc., RJM Group, Fan Fox and Leslie R. Samuels Foundation, Source Entertainment, Sherman Foundation, Seth Sprague Educational and Charitable Trust, Spicing and Design, Inc., Jules and Doris Stein Foundation, Sutzberger Foundation, Scindia Foundation, Susquehanna, Travelers Foundation, Unworld Group Inc., John A. Vassiaros & Sons, Inc., Wachter, Lipton, Rosen & Katz, Lila Acheson Wallace Funds, The West Bank Cafe, Writers & Artists, Yoda Construction. In addition, the following individuals made gifts of over \$150 to The 52nd Street Project this year:

Wendy Abrams	Ruth Cohen	Marc Jaffe & Mary Wulrich	Ethan Phillips
Jace Alexander	Thomas Coll	Linda Janklow	Robert & Susan Ochs Phillips
Brooke Allen	Margaret Crimmins & Patsy RaBarby	Larry Jones & Mary McElroy Jones	Nicholas Platt & Robyn Walls
JoSe Ang	JoSe Ang	Madhan Joseph	Donna Plummes & Todd Richter
Amy Argon & McGinnis McCoy	JoSe Ang	Manoela & Mia Kahn	Richard Polachek
Alan Arda & Kay Malschafal	NaDee DeJani	Betsy & George Kaiser	Christopher Randolph
Nora Arlin & Jake Weber	Paul Daniels	Lee Kalchheim & Julia Lord	Helen & Peter Randolph
Susan Atkins & Eben Shapiro	Arthur Danthala	Eric Kampel & Mike Sed	Tim Ray & Tyson Smith-Ray
Jane B. Linger & Michael Goldsien	Cathy Danilchik	Sheila Kehoh	WRea Reese
Ben Baranofsky	Peter & Judith Downie	Mark Kauppen & Wendy Townsend	Adam Reingold
Jessica Beneman	Marlene Deppa & Richard Hedar	Anita & Mark Kogdan	Jonathan Reiss
Lisa Benavides & Tim Nelson	Donna & William DeSola	Beth & Beth Klarman	Allyson Rice-Taylor
Emily Benton	Capa & Maha Dichter	Jeremy Koch	Todd Richter
Eleanor Bergsten	Stephen Dolner	Mary Kong	Eric Ricker
Pamela Berlin & William Carden	Dorcy Dunn & Mark Seeger	Jan Krosza & Jacki Ochs	Tyrrus Robertson
Barry & Myrna Borzard	Amy Dzwonkowska	Bella & Roger Kuhn	Ettey & Clifford Ross
Alexander Bramstein & Elizabeth Volozquez	Mad Eisenberg	Judy Kuhn & David Schwab	Joan Sangerson & Joseph Valapotas
Ron & Susan Blatt	Barbara EGran	Heidi Landesman	Karin & Tom Scheel
Audrey Blach & Joseph Wessenthal	Barbara Eltinger	Jill Larson	Slovo Schafel
Suzan Bloomberg & Mary Farrell	Wendy Etlinger & Derek McLane	JosPava Leher	Slatan Stalg
Robt & Ruth Blumensien	Lisa Finstrom & Tim Sanford	Sarah Jane Leigh	Brian Siboret and Prty Dryden
Sally Book & Mark Wunfel	Iwan & Emma Fisch	Robert Sean Leonard	Jacqueline Simon
Jane Bobler & Steve WeGrner	Tom Fontana & Sagan Lewis	Lisa Lerner	Meg Simon
Katherine Borowetz & John Tortum	Katherine Foster	John Bedford Lloyd & Ann Twomey	Mark Singer
Cristina Botta Singleton	David Froskel	Katharine Lumb & Joe Vitale	John Slackery
Bertha & Samuel Britz	Kornel Frazier	Mary McCann & Ned Pepe	Los Smith
Eric Brooks	Peter Freudenth & Mary Lou Teel	Mama & Peter Madhool	Abigail Solomon
Becky Browder & Ted Westfall	Amy Friedman	Greg MacPherson	Walter Spector
Deborah Brown	Louis & Patrice Friedman	Bruce MacVibe and Carol Ochs	John Stein
Susan Bruce & Peter Madges	Peter Fritschel & Pamela Nelson	Peter Manang	Tim Stephenson & Adriana Trogiani
Dorise Burse & Peter Jay Fernandez	Joseph Gazdak	Constance Moss	Eric Stoltz
Kate Burton & Michael Richot	Gary Gersh	George Mavrouzakis	Daniel Svoz
Cora Cahlan & Bernard Gersten	Simma Gershenson	Mit Mayer	Mariko Tada
Daniel & Maureen Cahil	Jonny Gersten	Barbara McCrane & Paul Reese	Jay Takas
Sтивен Callahan & Christine Dunn	Dee Getz & Mark Grinnell	James McDougal	Catherine Thomas
Carroll Campbell & Oliver Platt	Stephen and Cathy Graham	Brian Morley & Jackie Reingold	Ken Thompson
Louisa Campbell	Nichael Greil	Andy Molen	Joan Vail & John Thome
OsZoon Carol & Mashell Semel	Emily Grishman & Susan Sampkour	Walter Moley	Laura Valente
Richard & Lisa Cashin	Edmund Lewis Grossman & Troy Thome	Bill & Jane Muddiman	Paul Valley
John Cavella & Lucy Kaplan	Laura Guerra & Tucker McCrazy	Patricia Murphy & Adam Spick	Wendy vanden Meuvrel
James Coyne	Lesz Gugenheim	Edward Nasten	John Vassilades
Stockard Channing	Andrew Haas	Kate Heltgen & Robert Reska	Susan Vitucci
Rachel Chanoff	Bill & Linda Halvorsen	Randy & Rona Nelson	Emily Wachtel
Schryler Chayn	Stephen Harrelton & Emma Walker	Ruth Nelson	Elizabeth Warner
Peter Cherasia	Mamas Gay Haden	Helen & James Merzberger	Sam Waterston
Larry Cheroff & M Rose Gesser	Bamaby Harris	Renee Neward	Sally Weiss
Glenda Chesnik	David Herdrich	Eben Nowack	Robert Wiener
Marcus Chubas & Travis Preston	Peter Herdrich & Karen Thell	Steve Olsen	Barbara & Max Wlk
William Christian	Jane Hoffman	Kevin O'Rourke & Edith Thurber	Elizabeth Williams & Joseph Force
Joe Christiano & Rando Goodhah	William Hoptzman & S. Sylvia Shepard	John Payson	Matt Williams
Bill & Linda Cobb	Barbara Howard	Charles & Jean Marie Peaso	Vivene Wilson
Ethan Coen & Trish Cooke	Michelle Hurst	In memory of Francis Peiper	Donald Wincham
Joel Coen & Fran McDormand	Arnette Insabari & Mark Ethan Toporet	Bill & Joanna Perdy	Joanne Woodhard
Barry Cohen	Sy Jacobs	Alton & Elizabeth Peters	Janne & Jeffrey Yass
		Thomas Peters	James & Mary Lyn Yoshimura
			Neil Yostan

To those who made gifts of less than \$150, for which we have no form small enough, we give anonymous, extra bold and hearted thanks.

The 52nd Street Project Presents

William Shakespeare's

# What You Will

OR

# Twelfth Night

Performed by the Project's Teen Ensemble,  
direct from their triumphant engagement at  
the Chateau de Berne in Lorgues, France.

**The Ensemble Studio Theatre**

Friday, July 11, 1997 7:00 pm

## The 52nd Street Project Staff

Willie Reale, Artistic Director  
Carol Ochs, Executive Director  
Michael Bernard, Associate Artistic Director  
Sally Bock, Director of Development and Marketing  
George Roman Babiak, Production Manager  
Susan J. Vitucci, Development Consultant  
Iris A. Brown, Graphic Designer  
Liz Flahive and Jean-Paul Gressieux, Interns

## Production Staff

Kevin Joseph Roach, Set Designer  
Neil Mazzella and Hudson Scenic Studio, Set Construction  
Sheila Kehoe, Costume Designer  
Jean-Paul Gressieux, Sound Operator  
Liz Flahive, Light Operator  
Sally Bock, House Manager  
Lorraine Tobias, Backstage Crew

## Notes and Thanks

The Teen Ensemble is the most recent addition to the Project's theatrical curriculum. The youngsters performing this evening have all had between four and ten years of experience writing and performing with the Project. Two years ago they began an acting technique course which led to scene study and, finally, to this production. We are grateful to the **Surdna Foundation** for underwriting the development and implementation of this program, which will be documented and exported to our replication outposts. In addition, we are grateful to **Chris Ceraso** who spent two years helping to design and helping to teach the classes for *bupkis*.

This production would not have been possible without the generosity of **Bill Muddyman**, **Jane Muddyman**, and the staff of the **Chateau de Berne**. We are also immeasurably grateful to the **Florence Gould Foundation** for their sponsorship of the artistic residency in France.

Thanks must also go to artist/volunteers **Lisa Benavides**, **Don Berman**, **Jessalyn Gilsig**, **Barbara McCrane**, **Michaela Murphy**, **Gus Rogerson**, and **Joe White**.

The Project is delighted to return to the **Ensemble Studio Theatre**, where we have been performing since our inception in 1981. We congratulate EST on its 25th anniversary and gratefully acknowledge the fact that if they weren't here we'd be nowhere.

## *What You Will or Twelfth Night*

Mostly by William Shakespeare  
Adapted by Chris Ceraso  
Music by Rob Reale, new lyrics by Willie Reale  
Directed by Michael Bernard

## *The Cast*

Orsino (A noble duke) ..... Victor Rojas  
Valentine (A valentine) ..... Lori Quiñones  
Viola (a lady of Messaline) ..... Kulondi Frier  
A Sea Captain ..... George Babiak  
Sir Toby Belch (Olivia's kinsman) ..... Fernando Ramirez  
Maria (Olivia's waiting-gentlewoman) ..... Tina Vamvoukakis  
Sir Andrew Aguecheek ..... Michael Bernard\*  
Feste (Olivia's Fool) ..... Jill Barbosa  
Olivia (an Illyrian countess) ..... Diana Rojas  
Malvolio (Steward to Olivia) ..... Alex Draper  
Sebastian (Olivia's brother) ..... Luis Santoni  
Antonio (Friend to Sebastian) ..... Chris Ceraso  
Fabiana (Friend to Sir Toby) ..... Lori Quiñones  
Gendarme ..... George Babiak  
Priest ..... Willie Reale

\*Standing in for Jeffrey Zambrano, who fled the country

### The 52nd Street Project Board of Directors

Ben Barenholtz	Stephen Graham	Patricia M. Murphy, Esq.
Lisa Benavides	Larry Jones	Carol Ochs
Rachel Chanoff	Heidi Landesman	Willie Reale
Ruth Cohen	James McDaniel	Pamala Tyson
Wendy Ellinger, chair emeritus	Frances McDomand,	Laura Valeroso
Louis P. Friedman	chairperson	Elizabeth Williams

The 52nd Street Project gratefully acknowledges the support of the following foundations and corporations: Barker-Welless Foundation, Bertelsmann's World of Expression Foundation, BETA Fund, Consolidated Edison, Cubic B's, Florence Gould Foundation, Dramatists' Guild Fund, William and Mary Greve Foundation, Horace W. Goldenrith Foundation, Florence Gould Foundation, Heights Partners, Inc., Hennessy Foundation, Holland Lodge Foundation, Inc., Rita J. and Stanley H. Kaplan Foundation, Jonathan Larson Performing Arts Foundation, Loyds Bank, M & T Trust, MCJ Foundation, James A. Macdonald Foundation, Ann M. Martin Foundation, Morgan Stanley Foundation, J.P. Morgan Charitable Trust, Newman's Own, New World Foundation, The New York Times Co. Foundation, Northwest Point, Laura Pele Foundation, Carl and Lily Plozheimer Foundation, Inc., RJM Group, Fan For and Leslie R. Samuels Foundation, Sauce Entertainment, Sherman Foundation, Seth Sprague Educational and Charitable Trust, Staging and Design, Inc., Jules and Doris Stein Foundation, Sulzberger Foundation, Sundria Foundation, Susquehanna, Travelers Foundation, Uniwold Group Inc., John A. Vassilarios & Sons, Inc., Wachtell, Lipton, Rosen & Katz, Lika Acheson Wallace Funds, The West Bank Cafe, Writers & Artists Construction. In addition, the following individuals made gifts of over \$150 to The 52nd Street Project this year:

Wendy Abrams	Ruth Cohen	Marc Jaffe & May Wubrich	Ethan Phillips
Jace Alexander	Thomas Cott	Linda Janklow	Robert & Susan Ochs Phillips
Brooke Allen	Margaret Crummins &	Larry Jones &	Nicholas Pratt & Robyn Watts
Jolie Ang	Pierce Rafferty	Mary McGrath-Jones	Donna Plummes & Todd Richter
Aoy Aquino & McGinnis McCoy	Joan Straus Cuffman	Nathan Joseph	Richard Polatchek
Alan Arfa & Kay Matichukoff	Nadia Dajani	Marcella & Max Kahn	Christopher Randolph
Nora Arfin & Jake Weber	Paul Daniels	Betty & George Kaiser	Helen & Peter Randolph
Susan Atkins & Eben Shapiro	Arthur Danilchik	Lee Kalkheim & Julia Lord	Tim Ray & Tyson Smith-Ray
Jane Ballinger & Michael Goldstein	Cathy Danilchik	Eric Karpelos & Mike Sell	Wille Reale
Ben Barenholtz	Peter & Judith Dawkins	Sheila Kehoe	Adam Ringgold
Jessica Bauman	Martina Deppe & Richard Hadar	Mark Keoppen &	Jonathan Reiss
Lisa Benavides & Tim Nelson	Donna & William DeSeta	Wendy Townsend	Alyson Rice-Taylor
Emily Bertram	Cipa & Misha Dichter	Ania & Mark Kingdon	Todd Richter
Eleanor Bergstein	Stephen Dubner	Beth & Seth Klarman	Eric Riber
Pamela Berlin & William Garden	Darcy Dunn & Mark Singer	Jeremy Koch	Tyhnast Robertson
Barry & Myra Bernard	Amy Dziwoniowski	Mary Kong	Betsy & Clifford Ross
Alexander Bernstein &	Ned Eisenberg	Jan Krosz & Jacki Ochs	Jane Sangeman &
Elizabeth Velazquez	Barbara Eilan	Bette & Roger Kuhn	Joseph Vadapalas
Ron & Susan Black	Barbara Ellinger	Judy Kuhn & David Schwab	Karin & Tom Schall
Audrey Bloch &	Wendy Ellinger & Derek McLane	Heidi Landsman	Steve Schofield
Joseph Wesenthal	Lisa Finstrom & Tim Sanford	Jill Larson	Dana Segal
Stuart Bloomberg & Mary Farrell	Iwan & Simra Fisch	Joshua Lehrer	Stefan Selig
Robi & Ruth Blumentstein	Tom Fontana & Sagan Lewis	Sarah Jane Leigh	Brian Sberell and Patsy Dryden
Sally Bock & Mark Wurkl	Katherine Foster	Robert Sean Leonard	Jacqueline Simon
Jane Bolker & Steve Wortner	David Frankel	Liza Lerner	Meg Simon
Katherine Borowitz & John Turturro	Kermit Frazier	John Bedford Lloyd &	Mark Singer
Cristina Botta Singleton	Peter Freundlich & Mary Lou Teel	Anne Twomey	John Slattery
Bertha & Samuel Brill	Amy Friedman	Katherine Lumo & Joe Vitale	Lois Smith
Eric Brooks	Louis & Patricia Friedman	Mary McCann & Neil Pepe	Abigail Solomon
Becky Browder & Ted Neustadt	Peter Fritschel & Pamela Nelson	Mansui & Peter MacFicol	Warren Spector
Deborah Brown	Joseph Gazdak	Greg MacPherson	Jean Stein
Susan Bruce & Peter Hedges	Gary Gersh	Bruce MacVibe and Carol Ochs	Tim Stephenson & Adriana Trigliani
Denise Burse &	Simra Gershenson	Peter Manning	Eric Stoltz
Peter Jay Fernandez	Jenny Gersten	Constance Mars	Daniel Sweet
Kate Burton & Michael Ritchie	Reen Getz & Mark Grinnell	George Mavronicolas	Marko Tada
Cora Cahlan & Bernard Gersten	Stephen and Cathy Graham	Max Mayer	Jay Teresi
Daniel & Maureen Cahill	Michael Grail	Barbara McCrane & Paul Reale	Cathlene Thomas
Steven Callahan &	Emily Griesman &	James McDaniel	Kip Thompson
Christine Dunn	Susan Saplimer	Brian Merles & Jackie Rrengold	Joan Vail & John Thome
Camilla Campbell & Oliver Platt	Edmund Lewis Grossman &	Andy Milton	Laura Valeroso
Louisa Campbell	Tracy Thome	Water Mosley	Paul Valley
Coleen Carroll & Mitchell Semel	Laura Guerra & Tucker McCrady	Ril & Jane Muddyman	Wendy vanden Heuvel
Richard & Lisa Cashin	Lisa Gugenheim	Patricia Murphy & Adam Spika	John Vassilarios
John Cavello & Lucy Kaplan	Andrew Haas	Edward Nashen	Susan Vitucci
James Cayne	Bill & Linda Halverson	Kate Nelligan & Robert Reale	Emily Wachtel
Stockard Channing	Stephen Hamilton & Emma Walton	Randy & Rozia Nelson	Elizabeth Warner
Rachel Chanoff	Marcia Gay Harden	Ruth Nelson	Sam Waterston
Schuyler Chapin	Barnaby Haris	Helen & James Neuberger	Sally Weiss
Peter Cherassa	David Herdrich	Renee Neuwald	Robert Wiener
Larry Chertoff & M. Rose Gasner	Peter Herdrich & Karin Trout	Elen Novack	Barbara & Max Wilk
Glenda Chaszir	Jane Hoffman	Steve Osen	Elizabeth Williams & Joseph H.
Marissa Chibas & Travis Preston	William Holtzman &	Kevin O'Rourke & Edith Thurber	Matt Williams
William Christian	S. Sylvia Shepard	John Payson	Valene Wilson
Joe Christiano & Rande Goodwin	Barbara Howard	Charles & Jean Marie Pesse	Donald Wincham
Bill & Linda Cobb	Michelle Hurst	In memory of Frances Peper	Joanne Woodward
Ethan Coen & Trish Cooke	Arnette Insdorf &	Bill & Joanna Perisky	Janine & Jeffrey Yass
Joel Coen & Fran McDormand	Mark Ethan Toponek	Alton & Elizabeth Peters	James & Mary Lin Yoshimura
Barry Cohen	Sy Jacobs	Thomas Peters	Nel Yokin

as of 3/20/97

To those who made gifts of less than \$150, for which we have no font small enough, we give humongous, extra bold and heartfelt thanks.

The 52nd Street Project Presents

The  
Block  
Island  
Collection

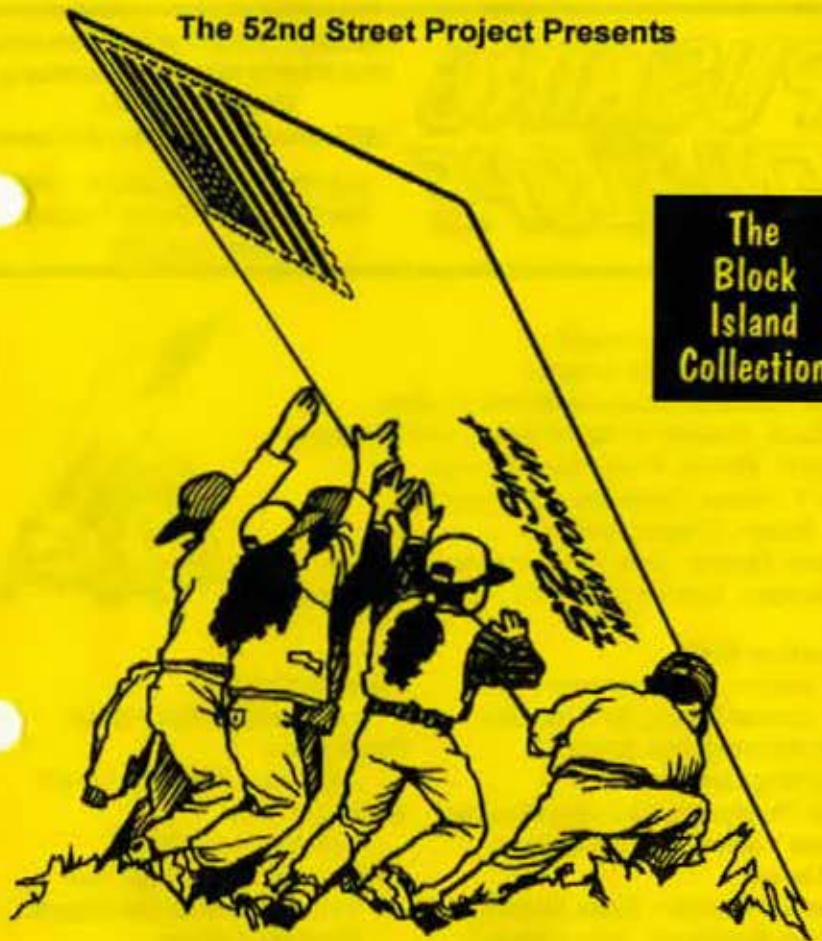

# PUSHING THE ENVELOPE

Plays with no bounds!

The Harold and Mimi Steinberg Charitable Trust 1997 One-on-Ones  
The Ensemble Studio Theater, New York City

July 31 at 7:30 p.m., August 1 at 7:30 p.m.  
August 2 at 3:00 and 7:30 p.m., August 3 at 3:00 p.m.

# PUSHING THE ENVELOPE

The 52nd Street Project Presents  
The Harold and Mimi Steinberg  
Charitable Trust  
1997 Block Island One-on-Ones

July 31, Aug. 1, 2, and 3, 1997  
The Ensemble Studio Theater  
New York City

## Project Staff

Willie Reale, Artistic Director  
Carol Ochs, Executive Director  
Michael Bernard, Associate Artistic Director  
Sally Bock, Director of Development and Marketing  
George R. Babiak, Production Manager  
Susan J. Vitucci, Development Consultant  
Iris A. Brown, Graphic Designer  
Elizabeth Flahive, Jean-Paul Gressieux - Interns  
Luis Santoni, Tina Vamvoukakis - Junior Counselors

## Production Staff

Rusty Magee, Music Director  
Kevin Joseph Roach, Set Designer  
Alistair Wandesforde-Smith,  
Lighting Designer  
Crystal Thompson, Costume Designer  
Vanessa Valdes, Sound Designer  
Slide Design:  
Renato Castilho, Tiana Manfred,  
Adam Rodriguez, John Steward,  
Alberta Testanero, and Eric Quo,  
with special thanks to  
Katherine Lumb  
Props Design:  
Scott Ramsay & George Babiak,  
Colorforms Design  
Sarah Hokanson & Joy Kilpatrick  
Hank Meiman, Stage Manager  
Flyer/Program illustration by Mike Sell  
Jean-Paul Gressieux, Slide Operator

Furniture Crew:  
Luis Santoni, Ray Harold  
Props Crew:  
Jilly Crook, Deshana Hamid  
Colorform Chief:  
Kimberly Kelly Wilson  
Load-in and Light Hang Crew:  
Tara Cook, Jose Dominguez,  
Elizabeth Flahive,  
Jean-Paul Gressieux,  
Jean Lee, Hank Meiman  
House Managers:  
Angela Trento, Mary Pat Walsh  
House Crew:  
Sharon Kay, Arnell Powell III  
Out-of-town Chefs:  
Martha Velie-Gass,  
Pat McQuade,  
Vanessa Valdes, Carol LaVal



Program layout by George Babiak

The One-on-One Program is made possible, in part, by public funds from the New York State Council on the Arts, the Department of Youth Services, and the New York City Department of Cultural Affairs.

The 52nd Street Project is a non-profit organization that brings inner-city children from the Clinton neighborhood together with professional theater artists to create theater. PUSHING THE ENVELOPE is a production of our One-on-One program, which is designed to give children the opportunity to go away for one-week stays in the country and enjoy the undivided attention of a professional theater artist who serves as friend, mentor, and role model.

## The 52nd Street Project Board of Directors

Ben Barenholtz	Stephen Graham	Patricia M. Murphy, Esq.
Lisa Benavides	Larry Jones	Carol Ochs
Rachel Charoff	Heidi Landesman	Willie Reale
Ruth Cohen	James McDaniel	Pamala Tyson
Wendy Ettinger, <i>chair emeritus</i>	Frances McDormand,	Laura Valeroso
Louis P. Friedman	<i>chairperson</i>	Elizabeth Williams

## Special Thanks To:

Curt, Abigail, and The Ensemble Studio Theatre; Dr. Christina Biaggi and Pat Walsh; Virginia Dare and Joya Verde; The Host Families: the Lakes, the Drapers, Martha Velie-Gass and Pat McQuade, the Taubmans, the Tierneys; Lyn Reale; Bob Reale; George, Natalie, Shayna and Block Island Realty; Ann Hall; Rachel; Interstate Navigation; McQuade's Market; Greg MacPherson; Prudy and the Ice Cream Place; Jimmy Reale; Bob Reale; Tracy and Sean; The Depot; the Narragansett Inn; and Adam Felber.

## In-Kind Contributions:

Ensemble Studio Theatre; Neil A. Mazzella & Hudson Scenic Studios, Inc.; David Sneddon and Fairway Market; Colorforms; Baron & Baron; Shays & Murphy; Iris A. Brown & Bernhardt/Fudyma Design Group; Ron Kastner, Capital Printing; The Estate of Jonathan Larson; Masque Sound; Nickelodeon; New Dramatists; Playwrights Horizons; Steve Olsen & The West Bank Cafe; Lincoln Center Theater; Materials for the Arts; Rain Restaurant; Port Authority; Mayor's Office of Film & Television; John A. Vassilaros & Son; Paris Chocolates; Scholastic Productions; Revlon; Coleman, Inc.; Watkins Products; Tom Reale; Eric Karpeles & Mike Sell; Andy Millon; Dr. Cristina Biaggi; Mark Keoppen; Kevin Joseph Roach.

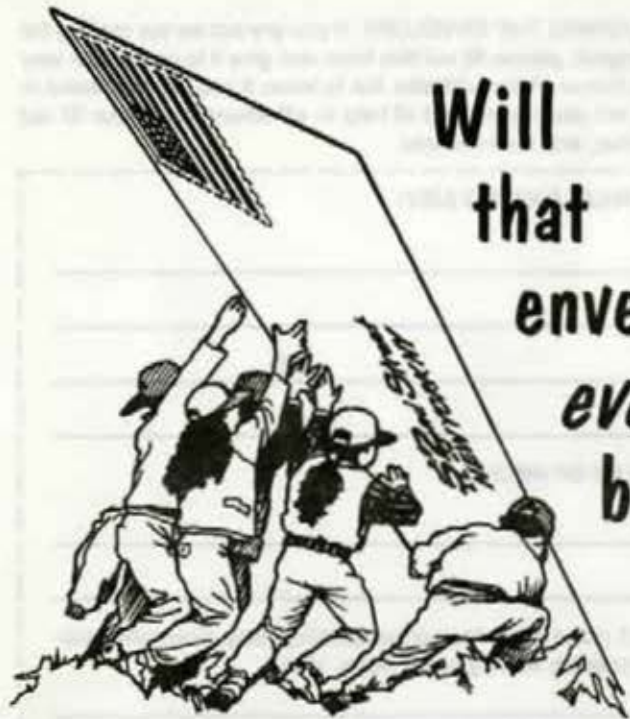

Will  
that  
envelope  
ever  
break?

# PUSHING THE ENVELOPE



## The Tyler Hill, PA. edition!

In August, we'll be taking eleven kids to Tyler Hill, Pennsylvania for a week to create another evening of plays based on the same theme seen in tonight's show. All new plays, all new songs, all new kids, and some old adults. Go on, be pushy! Join us!

August 21 and 22 at 7:30 p.m.  
August 23 at 3:00 and 7:30 p.m.  
August 24 at 3:00 p.m.

Call 642-5052 for reservations

## Pushing The Envelope: ACT I

All music composed by Rusty Magee

**Pushing The Envelope Theme** - The Company. Lyrics by Willie Reale

### Singing Plumbers

Written and directed by George Babiak for Peter Ventura, age 12

Reggie ..... Peter Ventura  
Stan ..... Jose Soto  
Angry Man ..... George Babiak  
Mrs. Holloway ..... Sally Bock

"The Water Heater Opera" and "Do It With Style" lyrics by George Babiak

### Pre-Teen Pusher

Written and directed by Carl Capotorto for Lorraine Lopez, age 12

Linda Lazulli ..... Lorraine Lopez  
Colly DeCarlo ..... Carl Capotorto  
Foreman's Voice ..... Michael Bernard

"The Saga of Poor Linda Lazulli" lyrics by Willie Reale

### The Doctor and the Devil Cat

Written by Chris Ceraso and directed by Wendy vanden Heuvel

Christina Ramirez, age 9.

Dr. Brilliant ..... Christina Ramirez  
Chaser ..... Wendy vanden Heuvel  
Voice of Gladys ..... Elizabeth Flahive

"Dr. Brilliant's Promo" lyrics by Willie Reale

### The Whole Tooth

Written by Susan Kim and directed by Suzen Murakoshi for Isha Rodriguez, age 12

Tooth Fairy ..... Isha Rodriguez  
Muriel ..... Suzen Murakoshi

"Change" lyrics by Willie Reale

### Blue In The Face

Written and directed by Frances McDormand for Gloria Trejo, age 10.

Weepy ..... Gloria Trejo  
Giggles ..... Frances McDormand  
Employment official ..... Eileen Sullivan

Sup ..... Jean-Paul Gressieux, Tina Varnvoukakis,  
Kimberly Kelly Wilson, Luis Santoni

"After the Laughter" lyrics by Willie Reale

☞ INTERMISSION ☜

## ACT 2

### This and That

Written and directed by Michael Bernard for Michael Castro, age 13.

Steve ..... Michael Castro  
King Abreziat ..... Michael Bernard  
General ..... Luis Santo  
Army ..... Assorted Adults

"This and That, Parts 1 and 2" lyrics by Michael Bernard

### Wild In The Sweeps

Written and directed by Rusty Magee and Alison Fraser for Natalie Musteata, age 11

Corporate News Announcer ..... George Babiak  
Amy Forces ..... Alison Fraser  
Haviland Powers ..... Natalie Musteata  
Secretary ..... Tina Vamvoukakis  
WOW YTV Announcer ..... L. Trey Wilson  
Psychic Sidekick ..... Elizabeth Flahive  
Rune Boy ..... Nat Magee

"WOW YTV," "Bambi Amber Teenage Psychic Theme Song," "Judy the Druid Teen Theme Song," and "WOW YTV Reprise" lyrics by Rusty Magee and Alison Fraser

### Take Me Out Into the Ball Game

Written and directed by Lili Taylor for Mayleen Cancel, age 11.

Lucy ..... Mayleen Cancel  
Coach ..... Lili Taylor  
Jack ..... Michael Bernard  
Mean Joe Grandslam Simpson ..... L. Trey Wilson  
Catcher ..... Luis Santoni

"Hold On To Your Dreams" lyrics by Willie Reale

### The Secret Formula

Written by Eduardo Machado and directed by L. Trey Wilson for William Brown, age 13.

Joe ..... William Brown  
Keith ..... L. Trey Wilson

"Keith's Song" lyrics by Willie Reale

### Some Crumb

Written by Willie Reale and directed by Willie Reale and Camilia Sanes for Noel Polanco, age 11.

Crumb ..... Noel Polanco  
Elisabel ..... Camilia Sanes

"Bread Remembers Everything" and "Dancing In The Sugar" lyrics by Willie Reale

Thank you for coming to PUSHING THE ENVELOPE. If you are not on our mailing list (or if your address has changed), please fill out this form and give it to us on your way out or mail it to the address below. We would also like to know if you are interested in becoming a volunteer. We are always in need of help in **all areas**, so please fill out your name and phone number, and we'll call you.

#### PLEASE ADD ME TO YOUR MAILING LIST:

NAME \_\_\_\_\_

ADDRESS \_\_\_\_\_

ZIP \_\_\_\_\_

PHONE \_\_\_\_\_

#### YES, I WOULD LIKE TO BE OF HELP:

NAME \_\_\_\_\_

DAYTIME PHONE \_\_\_\_\_

I AM REALLY USEFUL AT (52nd Street Project related things only. Examples: Mailings, backstage help, fundraising, moving heavy items, etc.)...

If you would like to mail this (and you're always welcome to enclose a tax-deductible contribution), you can send it to:  
The 52nd Street Project 500 West 52nd St. New York, NY 10019  
(212) 333-5252

**Cool Stuff**

**ON SALE IN THE LOBBY**

**The Fabulous Flyer Bar (in five flavors)**  
\$2.00 and \$1.50 (\$1.00 for kids)

And featuring Shel Silverstein's "Fivey and Twoey" logo:

**52nd Street Project T-Shirts**  
\$12.00

**52nd Street Project Caps**  
\$15.00

**52nd Street Project Mugs**  
\$5.00, filled with your choice of beverage!

The 52nd Street Project gratefully acknowledges the support of the following foundations and corporations: Barker Welfare Foundation, Bernstein's World of Expression Foundation, Cubic 8's, Donaldson, Lufkin & Jenrette, Dramassi's Good Fund, Fan Fox & Leslie R. Samuels Foundation, Hixson W. Goldsmith Foundation, Florence Gould Foundation, William & Mary Greve Foundation, Hamtracht & Quast, Rita J. & Stanley H. Kaplan Foundation, Jonathan Laron Performing Arts Foundation, Lloyd's Bank, MCI Foundation, The New York Times Co. Foundation, Northwest Point, Laura Pitt Foundation, Pumpkin Foundation, Sauce Entertainment, Scherman Foundation, Staging & Design, Inc., Jules & Dina Stern Foundation, Harold & Miri Steinberg Charitable Trust, Sulzberger Foundation, Sundra Foundation, Susquehanna, Travelers Foundation, Lila Acheson Wallace Fund, York Construction. In addition, the following individuals made gifts of over \$100 to the 52nd Street Project this year (list current as of 6/21/97):

- |                                    |                                    |                               |                                     |
|------------------------------------|------------------------------------|-------------------------------|-------------------------------------|
| Jace Alexander                     | Paul Davies                        | Benot Jamar                   | Kevin O'Rourke & Edith Thurbe       |
| May Anwar                          | Arthur Dantsch                     | Daniel Jenkins                | Steve Olsen                         |
| Miriam Ariano & Steven Jacobson    | Peter & Judith Deskins             | Hope Jessup                   | Paul Orenderok                      |
| Amy Aquino & Drew McCoy            | Vince DeGaano                      | M. Lynne Johnson              | Kristine Plankow                    |
| Alex Avila & Kay Malachukal        | Cipe & Melba Dichter               | Jay Joffe                     | John Payton                         |
| Peter Askin                        | Jama Dixon                         | Larry & Mary Josias           | Ethan Philips                       |
| Jane Ballinger & Michael Goldstein | Jan Dorn & Robert Maslin           | Marvella & Max Kahn           | Peter Philips                       |
| Stephanie Barber                   | Polly Draper                       | Lee Natheem & Julia Lord      | Richard Posadas                     |
| Ben Barankin                       | John Dryden, Jr.                   | Eric Karpies & Mike Gell      | Christopher Randolph                |
| Angela Bassett                     | Rick & Rebecca Drosser             | Ronald Kasher                 | Peter Randolph                      |
| Janice Baumlin                     | Patty Dryden & Brian Sitaroff      | Phyllis Kaufman               | Gena Rapp                           |
| Laura Beachman & Neal Mazzella     | Stephen Dubner                     | Sheila Kahoe                  | Richard Rauchenberger               |
| Lisa Benardes & Tom Nelson         | Darcy Dunn & Mark Singer           | Mark Kacopian &               | Alyson Rice-Taylor                  |
| Andrew Bergman                     | Ron Doyle                          | Wendy Townsend                | Kati & Michele Richardson           |
| Eleanor Bergman                    | Charles Dumas                      | Rusty King                    | Todd Richter                        |
| James Berkus                       | Christopher & Karen Eddowes        | Woodie King, Jr.              | Herold Rich                         |
| Pamela Berlin & William Corbin     | Ned Eizenberg                      | Beth & Beth Korman            | Jacques Rose & Carol Ue             |
| Sally & Myrna Bernard              | Jacquelyn Ellen                    | Francis & Joseph Folker       | David Rosenberg                     |
| Michael Bernard                    | Barbara Eitan                      | Mary Kong                     | Betty & Clifford Ross               |
| Alexander Bernstein &              | Bert Elsbach & Janet Reich         | Jan Kohn & Jacki Onda         | Donald Rothchild & Lorraine Drivers |
| Elizabeth Velazquez                | Marcia Engelblatt                  | David Kulin                   | Daniel & Janice Ross                |
| In memory of Ron Black             | Michael Engler                     | Judy Kulin & David Schweb     | Howard Rubin                        |
| Richard Blackstone                 | Wendy Elinger & Denise McLane      | Roger & Belle Kulin           | Mary Slater                         |
| Aubrey Block & Joseph Wesenthal    | Bill Fagerbakke &                  | Elsie & Howard Langbaum       | Jane Sangerman & Joseph Valicenti   |
| Stuart Bloomberg and Mary Farrell  | Catherine McDevitt                 | Elizabeth & Jeffrey Lange     | Keri & Tom Schall                   |
| Rob & Ruth Blumenstein             | Lisa Frazzon & Tim Sanford         | Jill Larson                   | Ken & Mary Ann Schuster             |
| Gally Book                         | Christine Fleisher & David Sneedon | Lawrence Levine               | Steven Selig                        |
| Jane Boller & Steve Wertner        | Katherine Foster                   | Sue Libman                    | Jeffrey Seiler                      |
| Orsona Boba Singlete               | David Frankel                      | Byron Lewis                   | Bernor Shale                        |
| Patricia Breen                     | Eric Frankel                       | Elan Lewis                    | James Shanden                       |
| Bonnie & Samuel Britz              | Kenneth Frazer                     | Kenneth & Evelyn Lupper       | Marc Sholes & Esther Trevel         |
| Betsy Browder & Ted Neustadt       | Naomi Freundlich & Charles Miles   | Dawn Littenfeld               | Jacqueline Simon                    |
| Deborah Brook                      | Lynni & Frances Friedman           | John Bedford Lloyd &          | Keri Smith                          |
| Douise Burns &                     | Peter Frutkin & Pamela Nelson      | Alan Twomey                   | Loe Smith                           |
| Peter Jay Fernandez                | David Gubin & Lisa Piazza          | Mayme Loggin                  | Abigail Solomon                     |
| Kate Burton & Robi Reiss           | Joseph Gural                       | Pink & Martin London          | Warren Spector                      |
| Cori Cahlan & Bernard Gersten      | Gene & Hilli Gershenson            | Katherine Lund & Joe Vitak    | Robert Shalton & John Slater        |
| Steve Callahan & Christine Dunn    | Jenny Gersten & Wile Raab          | John Lyons                    | Fisher Stevens                      |
| Danila Campbell & Oliver Platt     | Jean Gersten                       | Harlow McBane & Paul Reiser   | Tim Stephenson & Adriane Tripani    |
| Collen Camill & Mitchell Sichel    | Ivan Geiz & Marc Grinnel           | Peter & Marcus MacHool        | Daniel Sweet                        |
| Richard & Lisa Castle              | Nancy Gery                         | Greg MacPherson               | Makko Tada                          |
| John Cavello & Lucy Kaplan         | Henry Gilford                      | Roni Maffia                   | Jay Tanes                           |
| Kathy Chaffin                      | MacElla Glass                      | Sarah Malkin                  | Maif Tarnes                         |
| Stockard Channing                  | Rubell & Betty Goldberg            | Elizabeth Marne               | Akron Tatrok                        |
| Rachel Charoff                     | Stephen & Cathy Graham             | Mark Marnucci                 | Stephen Tobias                      |
| Ted Chaper                         | Michael Grail                      | Constance Marks               | Gina Tomes                          |
| Larry Cheroff & Rose Casner        | Emily Gristman & Susan Sampson     | Harriet Matshulst             | Liz Tuccillo                        |
| Genda Chasine                      | Lisa J. Guggenheim                 | George Mayer, Jr.             | Laura Valerico & David Seidman      |
| Marissa Chibas & Travis Presbit    | Robert & Leah Hahn                 | Jeffrey & Katrina Mayer       | John Vassilance                     |
| William Christian                  | William Halverson                  | Max Mayer                     | Susan Vilacci                       |
| Bill & Linda Cobb                  | Marcia Gay Harden                  | Bruce MacVittie & Carol Onda  | Mary Pat Walsh                      |
| Ethan Coen & Trish Cooke           | Paul Hejnyas & Chantelle Elerston  | Mary McCain & Neil Pege       | Zorah & Mildred Walton              |
| Jael Coen & Francis McDonnell      | David Hendrich                     | Cene McCoy                    | Philip Weisbaum                     |
| Ruth Cohen                         | Peter Henschel & Karen Trot        | Paul McCrae                   | Laura Weil                          |
| Richard Cohn                       | Jane Hoffman                       | Hanseloni & James McDaniel    | Norman Weinberg                     |
| Suzra Cohe & Inen Facht            | Wly Holtzman & Sylvia Shepard      | Brian Meres & Jackie Piengold | Lenny & Sally Weiss                 |
| Michael Connolly                   | Sarah Hoxwell                      | Audrey Meyer                  | Max Wik                             |
| Thomas Cott                        | Barbara Howard                     | Nancy Meyer & Marc Weiss      | Elizabeth Williams & Joseph Ford    |
| Margaret Cromment &                | Bernard Hughes & Helen Stantorg    | Randy & Ross Nelson           | Matt Williams                       |
| Pierce Raberty                     | Amy Jevig                          | Jim Newirth                   | Donald Wraitham                     |
| Stephen Crutgrington               | Sy Jacobs                          | Paul Newman &                 | Bill Wrubel                         |
| Joak Strauss Cullman               | Marc Jaffe & May Waldreich         | Jeanne Woodward               | Janine & Jeffrey Yazz               |
| John Cunningham                    | Andre Jaenke                       | Elan Novack                   | Janice & Mary Lin Yablonska         |

To those who made gifts of less than \$100, for which we have no form small enough, we give humbly, with love and heartfelt thanks.

The 52nd Street Project Presents

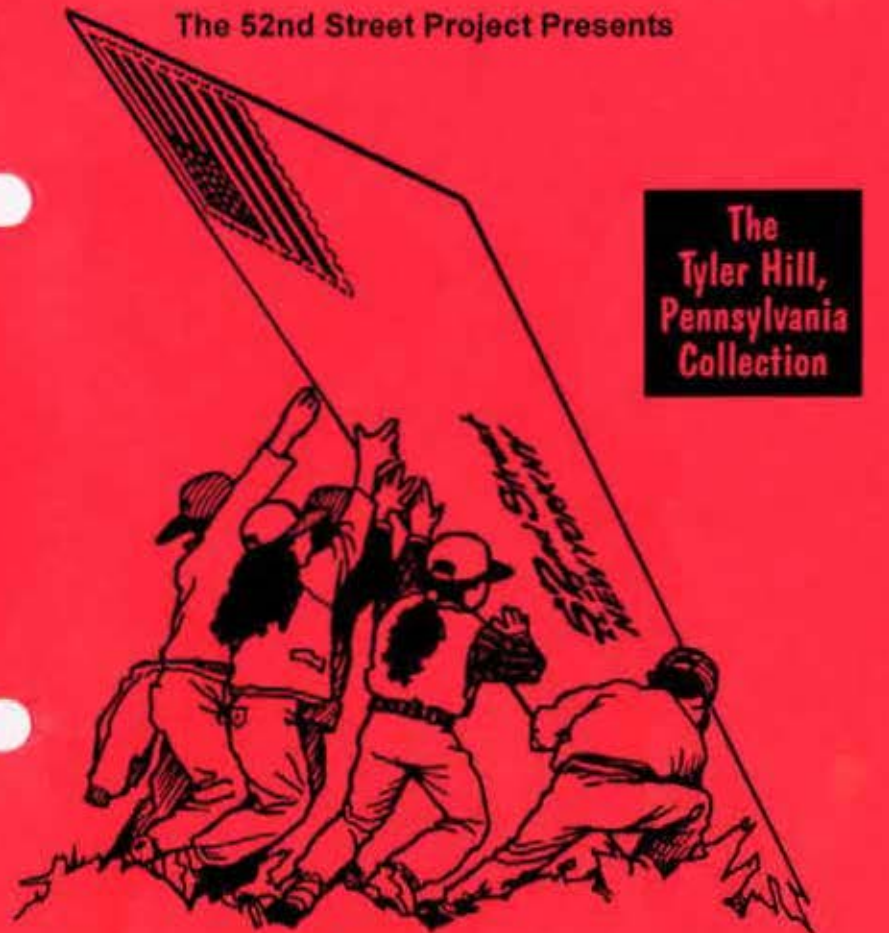

The  
Tyler Hill,  
Pennsylvania  
Collection

# PUSHING THE ENVELOPE II

Plays with no bounds!

The 1997 One-on-Ones

The Ensemble Studio Theater, New York City

August 21 at 7:30 p.m., August 22 at 7:30 p.m.  
August 23 at 3:00 and 7:30 p.m., August 24 at 3:00 p.m.

# PUSHING THE ENVELOPE III

The 52nd Street Project Presents  
The 1997 Tyler Hill, PA  
One-on-Ones

Aug. 21, 22, 23 & 24, 1997  
The Ensemble Studio Theater  
New York City

## Project Staff

Willie Reale, Artistic Director  
Carol Ochs, Executive Director  
Michael Bernard, Associate Artistic Director  
Sally Bock, Director of Development and Marketing  
George R. Babiak, Production Manager  
Susan J. Vitucci, Development Consultant  
Iris A. Brown, Graphic Designer  
Jesse Sneddon - Intern  
Jed Clarke, Diana Rojas - Junior Counselors



## Production Staff

Tim Ray, Music Director  
Tyson Smith-Ray, Music Assistant  
and Singing Coach  
Kevin Joseph Roach, Set Designer  
Alistair Wandesforde-Smith,  
Lighting Designer  
Debbie Lucas, Costume Designer  
Vanessa Valdes, Sound Designer  
Slide Design: Mike Sell  
Props Design: George Babiak  
Colorforms Design:  
Sarah Hokanson & Joy Kilpatrick  
Noël Dawkins, Stage Manager  
Flyer/Program illustration by Mike Sell  
Mike Smith, Slide Operator  
Furniture Crew:  
Jed "Cobra" Clarke,  
Thomas "Grizzly" Santoni

Props Crew:  
Jilly Crook,  
Ray Harold  
Colorform crew:  
Diana Rojas,  
Ahmed Attia  
Load-in and Light Hang Crew:  
Noël Dawkins,  
Ray Harold,  
Christopher Quinn,  
Diana Rojas  
House Managers:  
Beth Emelson,  
Mary Pat Walsh  
House Crew:  
Jesse Sneddon  
Out-of-town Chef:  
Eric Karpeles

Photo layout by George Babiak

The One-on-One Program is made possible, in part, by public funds from the New York State Council on the Arts, the Department of Youth Services, and the New York City Department of Cultural Affairs.

The 52nd Street Project is a non-profit organization that brings inner-city children from the Clinton neighborhood together with professional theater artists to create theater. PUSHING THE ENVELOPE is a production of our One-on-One program, which is designed to give children the opportunity to go away for one-week stays in the country and enjoy undivided attention of a professional theater artist who serves as friend, mentor, and role model.

## The 52nd Street Project Board of Directors

Ben Barenholtz	Stephen Graham	Patricia M. Murphy, Esq.
Lisa Benavides	Larry Jones	Carol Ochs
Rachel Chanoff	Heidi Landesman	Willie Reale
Ruth Cohen	James McDaniel	Pamala Tyson
Wendy Ettinger, <i>chair emeritus</i>	Frances McDormand, <i>chairperson</i>	Laura Valeroso
Louis P. Friedman		Elizabeth Williams

## Special Thanks To:

Our most gracious hosts Eric Karpeles and Mike Sell; Curt, Abigail, Annie, and The Ensemble Studio Theatre; The Host Families: Martha Sader; Sally and Lenny Weiss; Fred Van Natta and Michael Post; Linda, Bill, and Sean Cobb; Roger Brinkerhoff; Bonnie and Ryan Rutledge; Pat and Frank Stoeckle; Sara and Bill Spoerri; Smitty and Marci Smith; Gary Rickard.

## In-Kind Contributions:

Ensemble Studio Theatre; Marcia Dunsmore and Settler's Inn; Larry Wolhandler; Sonny Buttiglieri and Painter's Tavern; Steve Jenkins; Mark Keoppen and Wendy Townsend; David Sneddon and Fairway Market; Colorforms; Neil A. Mazzella & Hudson Scenic Studios, Inc.; Baron & Baron; Shays & Murphy; Iris A. Brown & Bernhardt/Fudyma Design Group; Ron Kastner, Capital Printing; The Estate of Jonathan Larson; Masque Sound; Nickelodeon; New Dramatists; Playwrights Horizons; Olive Olsen & The West Bank Cafe; Lincoln Center Theater; Materials for the Arts; Port Authority; Mayor's Office of Film & Television; John A. Vassilaros & Son; Paris Chocolates; Scholastic Productions; Coleman, Inc.; Watkins Products; Tom Reale; Eric Karpeles & Mike Sell; Bill Muddyman and the Chateau de Berne; The Lobster Club; Boylan's Bottling Company.



**Don't miss our upcoming shows!**

# Playback

**Nov. 7, 8, and 9**

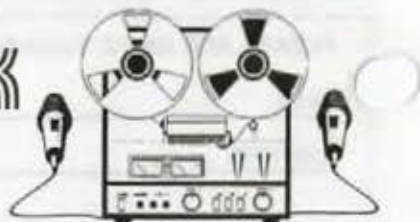

First, a kid writes a short play. Then, an adult writes an "answer" play. Then, the two of them perform both plays!



# Playmaking

**Dec. 12, 13, and 14**

In September, 10 kids brand-new to the Project will begin a Playmaking class with Michael Bernard. Come and see their final plays performed by adult professional actors.

# The Two-on-Two's

**January, '98**



In the One-on-One's, a single kid is paired with a single adult. Now you can see two kids perform a play written by an adult and directed by another adult.

## Pushing The Envelope: ACT I

All music composed by Tim Ray

Pushing The Envelope Theme - The Company. Lyrics by Willie Reale

MARTHA, QUEEN OF STEWARTS, AND THE PERFECT PRINCESS written and directed by Michaela Murphy for Jaya Rosado, age 13

Callope ..... Jaya Rosado  
 Queen Martha ..... Michaela Murphy  
 Prince ..... Robert Sean Leonard  
*"Imperfect Princess Me"* and *"The Martha Magazine Launch Theme"* lyrics by Willie Reale

SESSION WITH A VAMPIRE written and directed by Jerry McGill for Hakim Latimore, age 11

Count Andy ..... Hakim Latimore  
 Dr. Schnellenger ..... Jerry McGill  
 Man on Street ..... Michael Bernard  
*"Vampire Blues (What's A Vampire To Do)"* and *"Change the Tude, Chase the Dream"* lyrics by Jerry McGill

THE MOST KID written and directed by Diana Son for Matthew Jellison, age 11

Bigsley ..... Matthew Jellison  
 Xie ..... Barbara McCrane  
 Jar/Voice-overs ..... George Babiak  
*"What's A Kid"* lyrics by Diana Son

LUNACY written by Evan Handler and directed by Robert Sean Leonard for Alex Cooper, age 10

Spence ..... Alex Cooper  
 Boris ..... Robert Sean Leonard  
*"Brothers"* lyrics by Evan Handler

JUST A NUMBER written by Donald Rothschild and directed by Marissa Chibas for Hallie Gibson, age 9

June ..... Hallie Gibson  
 Lisa ..... Marissa Chibas  
 Mr. Lazlow ..... Jed Clarke  
 Manny ..... George Babiak  
*"Just A Number"* and *"The Crypt"* lyrics by Donald Rothschild and Willie Reale

REFeree SHORTS written and directed by Michael Bernard for Jaysunn Rosado, 12

Tommy Gorgonzola ..... Jaysunn Rosado  
 Malakai "The Bing" Toaster ..... Michael Bernard  
 Referee ..... Jerry McGill  
*"We're Boxing"* and *"Tommy's Message"* lyrics by Michael Bernard

**INTERMISSION**

## ACT 2

**A DARK AND STORMY NIGHT** written and directed by Michael Angel Johnson for Aisha Jabour age 11

Minerva ..... Aisha Jabour  
Lavinia ..... Julie Dre

*"Don't Be Afraid of the Rain in Your Eyes"* lyrics by Willie Reale

**WHAT'S MY SPINE** written by Adam Felber and directed by Larry Nathanson for Tanika Parson, age 12

Dr. Shaniqua Spangle ..... Tanika Parson  
Nurse Jim Crustacean ..... Larry Nathanson  
Andrew Smithers ..... Jed Clarke

*"We Put it Together"* lyrics by Adam Felber

**THE FLEA'S LAMENT** written by David Schwab and directed by Jack Gwaltney for Osage Lewis, age 10

Flea ..... Osage Lewis  
Colonel ..... Jack Gwaltney  
MC ..... Michael Bernard

*"A Flea's Lament"* and *"Fleas Are People Too"* lyrics by Willie Reale

**JILL FORGETS JACK** written and directed by Adrienne Shelly for Jayme Rosado age 10

Jill ..... Adrienne Shelly  
Jack ..... Jayme Rosado  
Renee ..... Sally Bock  
Shnod/John ..... George Babiak

*"Inseparable"* and *"Jack"* lyrics by Adrienne Shelly

**HELMUT'S HOPE** written & directed by Willie Reale for Jonathan Brown, 11

Dr. Helmut Zwiftenfleugen ..... Jonathan Brown  
Richard Kanickie ..... Reg E. Cathey  
Nina Ramsey ..... Marissa Chibas

*"Merengue In Your Dreams"* lyrics by Willie Reale



Thank you for coming to PUSHING THE ENVELOPE. If you are not on our mailing list (or if your address has changed), please fill out this form and give it to us on your way out or mail it to the address below. We would also like to know if you are interested in becoming a volunteer. We are always in need of help in *all areas*, so please fill out your name and phone number, and we'll call you.

### PLEASE ADD ME TO YOUR MAILING LIST:

NAME \_\_\_\_\_

ADDRESS \_\_\_\_\_

ZIP \_\_\_\_\_

PHONE \_\_\_\_\_

### YES, I WOULD LIKE TO BE OF HELP:

NAME \_\_\_\_\_

DAYTIME PHONE \_\_\_\_\_

I AM REALLY USEFUL AT (52nd Street Project related things only. Examples: Mailings, backstage help, fundraising, moving heavy items, etc.)...

If you would like to mail this (and you're always welcome to enclose a tax-deductible contribution), you can send it to:  
The 52nd Street Project 500 West 52nd St. New York, NY 10019  
(212) 333-5252

**Cool Stuff**

**ON SALE IN THE LOBBY**

**The Fabulous Flyer Bar (in five flavors)**

\$2.00 and \$1.50 (\$1.00 for kids)

*And featuring Shel Silverstein's "Fivey and Twoey" logo:*

**52nd Street Project T-Shirts**

\$12.00

**52nd Street Project Caps**

\$15.00

**52nd Street Project Mugs**

\$5.00, filled with seltzer!

The 52nd Street Project gratefully acknowledges the support of the following foundations and corporations: Anonymous, Barker Welfare Foundation, Bertelsmann's World of Expression Foundation, Cubic B's, Donaldson, Luffin & Jenrette, Dramatist's Guild Fund, Fox Fox & Leslie R. Samuels Foundation, Horace W. Goldsmith Foundation, Florence Gould Foundation, William & Mary Greve Foundation, Hambrecht & Quist, Rita J. & Stanley H. Kaplan Foundation, Jonathan Larson Performing Arts Foundation, Lloyd's Bank, M.C.J. Foundation, The New York Times Co. Foundation, Northwest Point, Laura Peis Foundation, Pumpkin Foundation, Sauce Entertainment, Scherman Foundation, Staging & Design, Inc., Jules & Doris Stein Foundation, Harold & Miri Steinberg Charitable Trust, Sultzberger Foundation, Surdna Foundation, Susquehanna, Travelers Foundation, Lila Acheson Wallace Funds, Yorke Construction. In addition, the following individuals made gifts of over \$150 to the 52nd Street Project this year (list current as of 8/21/97):

Jace Alexander	Paul Daniels	Berolt Jamar	Kevin O'Rourke & Edith Thurber
May Ameen	Arthur Dantchik	Daniel Jenkins	Steve Olsen
Miriam Ariano & Steven Jacobson	Peter & Judith Dawkins	Hope Jessup	Paul Onderdonk
Amy Aquino & Drew McCoy	Vince DeGarmo	M. Lynne Johnson	Kristine Pankov
Alan Arfa & Kay Matuschull	Cpa & Misha Dichter	Jay Jolly	John Payson
Peter Askin	Jamie Dimon	Larry & Mary Jones	Ethan Phillips
Jane Ballinger & Michael Goldstein	Jan Donn & Robert Mason	Marcella & Max Kahn	Peter Phillips
Stephane Barber	Polly Draper	Lee Kalcheim & Julia Lord	Richard Polachek
Ben Barenholtz	John Drayton, Jr.	Eric Karzelen & Mike Sell	Christopher Randolph
Angela Bassett	Rick & Rebecca Dresser	Ronald Kastner	Peter Randolph
Jessica Bauman	Patty Dryden & Brian Siberel	Phyllis Kautman	Gena Raps
Laurie Beechman & Neal Mazzella	Stephen Dubner	Sheila Kehoe	Richard Rauchenberger
Lisa Benavides & Tim Nelson	Darcy Dunn & Mark Singer	Mark Kooppen & Wendy Townsend	Alyson Rice-Taylor
Andrew Bergman	Ann Dwyle	Rusty King	Ken & Michele Richardson
Eleanor Bergstein	Charles Dumas	Woody King, Jr.	Todd Richter
James Berkus	Christopher & Karen Eddowes	Seth & Beth Klarman	Herald Ritch
Pamela Berlin & William Carden	Ned Eisenberg	Francis & Joseph Kolker	Jacques Rose & Carol Ue
Barry & Myrna Bernard	Jacquelyn Effert	Mary Kooig	David Rosenberg
Michael Bernard	Barbara Eilran	Jan Kroeze & Jacki Orta	Betsy & Clifford Ross
Alexander Bernstein & Elizabeth Valaquiz	Bart Eibach & Janet Reich	David Kuhn	Donald Rothschild & Lotzchen Shivers
In memory of Ron Black	Marcus Englefeld	Judy Kuhn & David Schwab	Daniel & Janice Rojas
Richard Blackstone	Michael Engler	Roger & Belle Kuhn	Howard Rubin
Audrey Bloch & Joseph Wiesenhal	Wendy Ettinger & Derek McLane	Elsaine & Howard Langbaum	Mary Slater
Stuart Bloomberg and Mary Farrell	Bill Fagerstakka & Catherine McClenahan	Elizabeth & Jeffrey Lange	Jane Sangerman & Joseph Vadapalas
Robt & Ruth Blumenstein	Lisa Finstrom & Tim Sanford	Jill Larson	Karin & Tom Schaal
Sally Book	Christine Fleisher & David Sneddon	Lawrence Lavine	Ken & Mary Ann Schuster
Jane Bolster & Steve Werlimer	Katherine Foster	Sue Leibman	Stefan Selig
Cristina Bota Singleton	David Frankel	Byron Lewis	Jeffrey Sella
Patrick Breen	Eric Frankel	Elen Lewis	Bernice Shavel
Bertha & Samuel Brill	Kermit Frazier	Kenneth & Evelyn Lipper	James Sheridan
Becky Browder & Ted Neustadt	Naomi Freundlich & Charles Miles	Davien Littlefield	Marc Sholes & Esther Treitel
Deborah Brown	Louis & Patrice Friedman	John Bedford Lloyd & Anne Twomey	Jacqueline Simon
Denise Bursic & Peter Jay Fernandez	Peter Fritschel & Pamela Nelson	Marjorie Loggie	Ken Smith
Kate Burton & Michael Ritchie	David Golub & Lisa Piazza	Pinks & Martin London	Lois Smith
Cora Cahlan & Bernard Gerstein	Joseph Gazdak	Katherine Lumb & Joe Vitale	Abigail Solomon
Steve Cahalan & Christine Dunn	Celia & Hillel Gershenson	John Lyons	Warren Spector
Camilla Campbell & Oliver Platt	Jenny Gersten & Willie Reale	Barbara McCrane & Paul Reale	Robert Shaffron & John Steber
Colleen Carroll & Mitchell Germal	Jill Gersten	Peter & Marsue Machicol	Fisher Stevens
Richard & Lisa Cashin	Ileen Getz & Mark Grinnel	Greg MacPherson	Tim Stephenson & Adriana Trijani
John Cavallo & Lucy Kaplan	Nancy Giles	Roma Maffia	Daniel Sweet
Kathy Chalfant	Hilary Gilfort	Sarah Malin	Mariko Tada
Stockard Channing	MacElla Glass	Elizabeth Marine	Jay Tansas
Rachel Chancoff	Robert & Betsy Goldberg	Mark Mannucci	Matt Tansas
Ted Chapin	Stephen & Cathy Graham	Constance Marks	Alison Tallock
Larry Chertoff & Rose Gesner	Michael Gref	Harriet Matuschull	Stephen Tobias
Glenda Chesshir	Emily Grishman & Susan Sampiner	George Mayer, Jr.	Gina Torres
Marissa Chibas & Travis Preston	Lisa J. Guggenheim	Jeffrey & Katrina Mayer	Liz Tuccillo
William Christian	Robert & Leah Haim	Max Mayer	Laura Valeroso & David Seidman
Bill & Linda Cobb	William Halvorsen	Bruce MacVitie & Carol Ochs	John Vassilario
Ethan Coen & Trish Cooke	Marcia Gay Harden	Mary McCann & Neil Pepe	Susan Vilucci
Joel Coen & Frances McDormand	Paul Hejniasi & Charlotte Elertson	Gene McCoy	Mary Pat Walsh
Ruth Cohen	David Herdrich	Paul McCrane	Borah & Mildred Walton
Richard Cohn	Peter Herdrich & Karen Trot	Hannelore & James McDaniel	Philip Waxelbaum
Symra Cohn & Irwin Fisch	Jane Hoffman	Brian Merles & Jackie Reingold	Laura Weil
Michael Connelly	Willy Holtzman & Sylvia Shepard	Audrey Meyer	Norman Weinberg
Thomas Cost	Sarah Horowitz	Nancy Meyer & Marc Weiss	Lenny & Sally Weiss
Margaret Crimmons & Pierre Rafferty	Barbara Howard	Kate Nelligan & Rob Reale	Max Wilk
Stephen Crudgington	Barnard Hughes & Helen Stenberg	Randy & Rona Nelson	Elizabeth Williams & Joseph Forte
Joan Strauss Cuffman	Amy Irving	Jim Neuwirth	Matt Williams
John Cunningham	Sy Jacobs	Paul Newman & Joanne Woodward	Donald Wridham
	Marc Jaffe & May Wittrich	Elen Novack	Bill Wrubel
	Andre Jaecke		Janine & Jeffrey Yass
			James & Mary Lin Yoshimura

To those who made gifts of less than \$150, for which we have no font small enough, we give humorous, extra bold and heartfelt thanks.

The 52nd Street Project Presents

# THE DOMINO EFFECT



PLAYS WITH  
SERIOUS REPERCUSSIONS



The 52nd Street Project's  
1997 Playback Program

Tuesday, November 4 at 7:30 p.m.  
Wednesday, November 5 at 7:30 p.m.  
Thursday, November 6 at 7:30 p.m.

The Directors Company at Theater Three, New York City

---

# THE DOMINO EFFECT



## The 1997 Playback Plays

Nov. 4, 5, & 6, 1997  
The Directors Company at  
Theater Three,  
New York City

---

### Project Staff

Willie Reale, Artistic Director  
Carol Ochs, Executive Director  
Michael Bernard, Associate Artistic Director  
Sally Bock, Director of Development and Marketing  
George Roman Babiak, Production Manager  
Susan J. Vitucci, Development Consultant  
Iris A. Brown, Graphic Designer  
Christina Romero, Jason Valk - Interns

### Production Staff

Kevin Joseph Roach, Set Designer  
Alistair Wandesforde-Smith,  
Lighting Designer  
Rusty Magee, Composer  
Debbie Lucas, Costume Designer  
Jeremy M. Posner, Sound Designer  
Slide Design:  
Renato Castilho, Adam Rodriguez,  
Mike Sell, Susan Vitucci  
Prop Construction Team:  
George Babiak, Jennifer Cummins,  
Sarah Hokanson, Sharon Kay,  
Joy Kilpatrick, Stacey Linden,  
Midge Lucas, Scott Ramsay,  
Eric Schwartz  
Colorform Designers:  
Sarah Hokanson & Joy Kilpatrick  
Flyer Design:  
Sarah Hokanson & Joy Kilpatrick  
Noël Dawkins, Stage Manager  
Paola Fantini, Slide Operator  
Furniture Crew:  
Thomas Santoni  
Props Crew:  
Christopher Quinn,  
Jaysunn Rosado  
Colorforms Crew:  
Sarah Hokanson & Joy Kilpatrick  
Load-in and Light Hang Crew:  
Tara Cook, Nedra Gallegos,  
Stephen Haff, Ellen Melaver,  
Larry Nathanson,  
Gheree O'Bannon, Brian O'Neill,  
Christina Romero, Kate Ryan,  
Tom Schall, Jason Valk,  
Vanessa Vartabedian,  
Ed Vassallo  
House Manager: Beth Emelson

The Playback Program is made possible, in part, by public funds from the National Endowment for the Arts, New York State Council on the Arts, the Department of Youth Services, and the New York City Department of Cultural Affairs.

The 52nd Street Project is a non-profit organization that brings inner-city children from the Hell's Kitchen/Clinton neighborhood together with professional theater artists to create theater. **The Domino Effect** is a production of our Playback program. In it, kid actor/playwrights are taken away for a weekend in the country where they write a play. Their adult actor/playwright partners then write "answer plays" in response. The partners then perform the plays together. All of the children seen tonight are veterans of the Playmaking classes which were adapted for the Project by Daniel Judah Sklar from his book *Playmaking: Children Writing and Performing Their Own Plays*.

---

### The 52nd Street Project Board of Directors

Ben Barenholtz	Stephen Graham	Patricia M. Murphy, Esq.
Lisa Benavides	Larry Jones	Carol Ochs
Rachel Chanoff	Heidi Landesman	Willie Reale
Ruth Cohen	James McDaniel	Pamala Tyson
Wendy Ettinger, <i>chair emeritus</i>	Frances McDormand,	Laura Valeroso
Louis P. Friedman	<i>chairperson</i>	Elizabeth Williams

---

### Special Thanks To:

Our most gracious hosts: Helen, Peter and Christopher Randolph of Wareham, Mass., and The Directors Company.

---

### In-Kind Contributions:

Ensemble Studio Theatre; Larry Wolhandler; Sonny Buttiglieri and Painter's Tavern; Steve Jenkins; Mark Keoppen and Wendy Townsend; Colorforms; Neil A. Mazzella & Hudson Scenic Studios, Inc.; Baron & Baron; Shays & Murphy; Iris A. Brown & Bernhardt/Fudyma Design Group; Ron Kastner, Capital Printing; The Estate of Jonathan Larson; Masque Sound; New Dramatists; Playwrights Horizons; Steve Olsen & The West Bank Cafe; Lincoln Center Theater; Materials for the Arts; Port Authority; Mayor's Office of Film & Television; John A. Vassilaros & Son; Paris Chocolates; Scholastic Productions; Coleman, Inc.; Watkins Products; Tom Reale; Eric Karpeles & Mike Sell; Bill Muddyman and the Chateau de Berne; Boylan's Bottling Company.

---

### And For Painting the Entrance to the Clubhouse on Oct. 18, Special Mention Goes To:

Rose Marie Acevedo, Sarah Bakker, Nina Claire, Nedra Gallegos, Sharon Kay, Midge Lucas, Ray Ocasio, Christina Romero, Amanda Ronconi, Sonya Rzepski, Paul Smithyman, Jesse Sneddon, Vanessa Spina, Dan Truman, and Vanessa Vartabedian.

**Don't miss our upcoming shows!**

# WILD LIFE

## THE UNINHIBITED PLAYS

**Dec. 12, 13, and 14**

At this moment, 10 kids who are brand-new to the Project are taking a Playmaking class with Michael Bernard. When they are done, they will be hailed as masters of their craft and given their very own writer's retreat in Pennsylvania. Come see their final plays performed by professional adult actors at Playwright's Horizons Studio Theater. Call 642-5052 for reservations.

# The Two-on-Two's

**Jan. 26 and 27**



In the One-on-One's, a single kid is paired with a single adult. Now you can see two kids perform a play written by an adult and directed by another adult.

**WINTER SERIES**

# Playmaking

**March, 1997**



In January, our next batch of newcomers will undertake the 10-week Playmaking program. At the end of the class they will be whisked away to Connecticut for a weekend to fashion a set of plays. The only thing they need: an audience.

## THE DOMINO EFFECT: ACT I

### Basketball Dreams

Written by Freddie Matos, 13. Dramaturg: Bruce MacVittie. Director: Keith Reddin

John ..... Freddie Matos  
 Ms. Neda, The Coach ..... Keith Reddin  
 Basketball Players ..... Chris Quinn, Joy Kilpatrick  
 Voice of Announcer ..... Steven Krulwich

### Sprockets

Written and Directed by Keith Reddin

John ..... Freddie Matos  
 Everyone else ..... Keith Reddin

### Cars "R" Us

By Tessa John-Connor, age 13. Dramaturg/Director: Elizabeth Keiser

Al Polka ..... Tessa John-Connor  
 Death ..... Elizabeth Keiser  
 Video Team ..... Chris Quinn, Sarah Hokanson, Joy Kilpatrick  
 Student ..... Thomas Santoni

### Go From The Gut

Written and directed by Elizabeth Keiser

Al Polka ..... Tessa John-Connor  
 Death ..... Elizabeth Keiser  
 Video Team ..... Chris Quinn, Sarah Hokanson, Joy Kilpatrick  
 "Go From The Gut" lyrics by Elizabeth Keiser, music by Rusty Magee.

### Don't Judge a Book By Its Cover

By Zsuzsa Mysak, age 14. Dramaturg: George Babiak. Director: Denise Burse.

Ashley ..... Zsuzsa Mysak  
 Kimmy ..... Denise Burse

### Just Talk

Written by George Babiak. Directed by Denise Burse.

Ashley ..... Zsuzsa Mysak  
 Kimmy ..... Denise Burse  
 Homeless Man ..... Christopher Quinn

### The Girl Who Deserved Better

By Evelyn Maldonado, 16. Dramaturg: Tim Blake Nelson. Director: Alison Tatlock.

Lidija ..... Evelyn Maldonado  
 Mom/Tree ..... Alison Tatlock  
 "I Want To Be Human" lyrics by Evelyn Maldonado, music by Rusty Magee.

### The Girl Who Deserved Better, Part II

Written by Tim Blake Nelson. Director: Alison Tatlock.

Lidija ..... Evelyn Maldonado  
 Mom/Tree ..... Alison Tatlock  
 "When You Take a Friend" lyrics by Tim Blake Nelson, music by Rusty Magee.

# INTERMISSION

## ACT 2

### Change For Rematch

Written by Eddie Zambrano, 16.

Dramaturg: Jacquelyn Reingold. Director: Jack Gwaltney

Ike "Aluminum Jaw" Bytson ..... Eddie Zambrano  
Evander Lobelessfield ..... Jack Gwaltney  
Announcer/Referee ..... Willie Reale

### Bytson and Lobeless

Written by Jacquelyn Reingold. Director: Jack Gwaltney

Ike "Aluminum Jaw" Bytson ..... Eddie Zambrano  
Evander Lobelessfield ..... Jack Gwaltney  
Announcer ..... Willie Reale

"We're Bytson and Lobeless" lyrics by Jacquelyn Reingold, music by Rusty Magee.

### Thoughtful Things

Written by Jonsi Smith, age 13. Dramaturg/Director: Susan Vitucci

Sheba ..... Jonsi Smith  
Esmerelda ..... Susan Vitucci

"Sheba's Samba" lyrics by Jonsi Smith and Susan Vitucci, music by Rusty Magee.

### Truth And Consequences

Written and Directed by Susan Vitucci

Sheba ..... Jonsi Smith  
Prudence ..... Susan Vitucci  
Pilgrims ..... Chris Quinn, Sarah Hokanson, Joy Kilpatrick, Thomas Santoni  
Fedora Pilgrim ..... George Babiak

### The Seventh Commandment

Written by Raymond Ocasio, 15.

Dramaturg/Director: Jose Dominguez

Anthony ..... Ray Ocasio  
Charles ..... Jose Dominguez  
Elena ..... Paola Fantini  
Young Bam-Bam ..... Jaysunn Rosado

### Free

Written and Directed by Jose Dominguez

Charles ..... Jose Dominguez  
Adult Bam-Bam ..... Ray Ocasio  
Guard ..... Thomas Santoni



## Cool Stuff ON SALE IN THE LOBBY

The Fabulous Flyer Bar (in five flavors)

\$2.00 and \$1.50 (\$1.00 for kids)

And featuring Shel Silverstein's "Fivey and Twoey" logo:

Project T-Shirts — \$12.00

Project Caps — \$15.00

Project Mugs — \$5.00, filled with seltzer!

Thank you for coming to THE DOMINO EFFECT. If you are not on our mailing list (or if your address has changed), please fill out this form and give it to us on your way out or mail it to the address below. We would also like to know if you are interested in becoming a volunteer. We need help in *all areas*, so please fill out your name and phone number, and we'll call you.

### PLEASE ADD ME TO YOUR MAILING LIST:

NAME \_\_\_\_\_

ADDRESS \_\_\_\_\_

ZIP \_\_\_\_\_

HOME PHONE \_\_\_\_\_

DAYTIME PHONE \_\_\_\_\_

### YES, I WOULD LIKE TO BE OF HELP. I CAN:

- |   |   |  |
|---|---|--|
| <input type="checkbox"/> Help load in and out for shows | <input type="checkbox"/> Draw and/or paint  | <input type="checkbox"/> Help kids with homework |
| <input type="checkbox"/> Hang lights                    | <input type="checkbox"/> Help with mailings | <input type="checkbox"/> Teach kids a skill      |
| <input type="checkbox"/> Work on a backstage crew       | <input type="checkbox"/> Do office work     | <input type="checkbox"/> Be a chef at an event   |
| <input type="checkbox"/> Other (please specify) _____   |   |  |

### MY SCHEDULE IS:

- Very flexible. I'm often available during weekdays.
- Somewhat flexible. I can help on the occasional morning or afternoon during the week.
- Not very flexible at all, but I've got some free time on evenings and weekends.

If you would like to mail this (and you're always welcome to enclose a tax-deductible contribution), you can send it to: The 52nd Street Project, 500 West 52nd St. New York, NY 10019. Or fax it to: (212) 333-5598.

The 52nd Street Project gratefully acknowledges the support of the following foundations and corporations: Anonymous, Barker Welfare Foundation, Barilman's World of Expression Foundation, Chase Manhattan Bank, Cubie B's, Donaldson, Luken & Jenrette, Dramatists' Guild Fund, Dramatists Play Service, Educational Foundation of America, EPIC, Fan Fox & Leslie R. Samuels Foundation, Horace W. Goddard Foundation, Florence Gould Foundation, Wilam & Mary Greve Foundation, Hambrecht & Quist, Holland Lodge Foundation, Rita J. & Stanley H. Kaplan Foundation, Jonathan Larson Performing Arts Foundation, Lloyd's Bank, MCJ Foundation, James A. MacDonald Foundation, Ann M. Martin Foundation, J. P. Morgan Charitable Trust, Morgan Stanley Foundation, New World Foundation, The New York Times Co. Foundation, Northwest Point, Laura Pels Foundation, Pumpkin Foundation, Saucia Entertainment, Scharman Foundation, Slagging & Design, Inc., Jules & Dore Stein Foundation, Harold & Mimi Steinberg Charitable Trust, Suzberger Foundation, Sunha Foundation, Susquehanna, Travelers Foundation, Lia Acheson Wallace Funds, Wiener Family Foundation, Windarcor, Yankee Construction. In addition, the following individuals made gifts of over \$150 to the 52nd Street Project this year (list current as of 12/29/97):

Jack Alexander	Paul Daniels	Jay Jolly	Kevin O'Rourke & Edith Thrub
May Aasen	Arthur Dantchik	Larry & Mary Jones	Steve Olsen
Miriam Ariano & Steven Jacobson	Peter & Judith Dawkins	Lee Katchem & Julia Lord	Paul Onderdonk
Amy Aquino & Drew McCoy	Vince DeGarcio	Eric Karpales & Mike Sel	Kristine Pankow
Alan Arfa & Kay Matichulat	Cipa & Maha Dichter	Ronald Kastner	John Pinyon
Peter Axon	Jamie Dixon	Phyllis Kaufman	Ethan Phillips
Jane Ballinger & Michael Goldstein	Jan Dorn & Robert Mason	Shelia Kehoe	Peter Phillips
Stephanie Barber	Polly Draper	Mark Keoppen & Wendy Townsend	Michael Pignataro
Ben Barenholtz	John Drayton, Jr.	Rusty King	Richard Polatzhek
Angela Bassett	Rick & Rebecca Dressler	Woodie King, Jr.	Christopher Randolph
Jessica Bauman	Stephen Dubner	Seth & Beth Klarman	Gena Raps
Laurie Breedman & Neal Mazzeia	Darcy Dunn & Mark Singer	Francis & Joseph Kolker	Richard Rauchenberger
Lisa Benavides & Tim Nelson	Ann Doyle	Mary Kong	Jacquelyn Reingold
Andrew Bergman	Charles Dumas	Jan Krosz & Jacki Ochs	Alyson Rice-Taylor
Eleanor Bergstein	Christopher & Karen Eddowes	David Kuhn	Ken & Michele Richardson
James Berkus	Neil Eisenberg	Judy Kuhn & David Schwab	Todd Richter
Pamela Berlin & William Carden	Jacquelyn Ellert	Roger & Belle Kuhn	Herald Rich
Barry & Myrna Bernard	Barbara Elman	Elaine & Howard Langbaum	Jacques Rose & Carol Lie
Michael Bernard	Bart Eabach & Janet Reich	Elizabeth & Jeffrey Lange	David Rosenberg
Alexander Bernstein & Elizabeth Velazquez	Michael Engler	Jill Larson	Betsy & Clifford Riss
In memory of Ron Black	Barbara Ellinger	Laurence Lavine	Donald Rothchild & Lotchen Shivers
Richard Blackstone	Heidi Ellinger	Sue Leibman	Daniel & Janice Rous
Laura Blanco and Robert Shainheit	Wendy Ellinger & Derek McLane	Byron Lewis	Howard Rubin
Audrey Bloch & Joseph Wessenthal	Bill Fagerbakke & Catherine McCannan	Elen Lewis	Jane Sangerman & Joseph Vadapalas
Stuart Bloomberg and Mary Farnel	Christine Feischer & David Sneddon	Kenneth & Evelyn Lipper	Karin & Tom Schall
Roel & Ruth Blumenstein	Mark Francis	Davlen Littlefield	Ken & Mary Ann Schuster
Sally Bock	David Frankel	John Bedford Lloyd & Arne Torsney	Slatan Sekig
Jane Bolster & Steve Westimer	Eric Frankel	Marjorie Loggia	Jeffrey Seler
Cristina Botta Singlein	Kenneth Frasier	Pinks & Martin London	Bernice Shael
Patrick Breen	Naomi Freundlich & Charles Miles	Katherine Lumb & Joe Vitale	James Sheridan
Berthe & Samuel Britt	Louis & Patricia Friedman	John Lyons	Marc Sholes & Esther Trentel
Becky Browder & Ted Neustadt	Peter Fritschel & Pamela Nelson	Barbara McCrane & Paul Reale	Jacqueline Simon
Deborah Brown	David Golub & Lisa Piazza	Peter & Marjorie MacNicol	Ken Smith
Denise Bursz & Peter Jay Fernandez	Joseph Gaudak	Greg MacPherson	Loki Smith
Kate Burton & Michael Ritchie	Celia & Hillel Gershenson	Roma Maffia	Abigail Solomon
Cora Cahen & Bernard Gersten	Jenny Gersten & Willie Reale	Sarah Main	Warren Spector
Steve Callahan & Christine Dunn	Jill Gersten	Elizabeth Manns	Robert Shaffron & John Steber
Camilla Campbell & Oliver Platt	Iwan Getz & Mark Gonnel	Mark Mannucci	Fisher Stevens
Colleen Carroll & Mitchell Samel	Nancy Giles	Constance Marks	Tim Stephenson & Adriana Tripani
Richard & Lisa Cashin	Hilary Gilford	Ann M. Martin	Daniel Sewe
Tim Cavello & Lucy Kaplan	MacElla Glass	George Mayer, Jr.	Marko Tada
Kathy Chaffant	Stephen & Cathy Graham	Jeffrey & Katina Mayer	Jay Tarses
Stockard Channing	Michael Graf	Max Mayer	Matt Tarses
Rachel Charoff	Emily Grishman & Susan Sampner	Bruce MacVitte & Carol Ochs	Alison Tabock
Ted Chapin	Lisa J. Gugenheim	Mary McCann & Neil Pepe	Stephen Tobias
Larry Chertoff & Rose Gasser	Robert & Leah Halmi	Gene McCoy	Liz Tuccillo
Gienda Cheshire	Marcia Gay Harden	Paul McCrane	Adam Urdan
Marissa Chibasi & Travis Preston	Paul Hejman & Charlotte Elerson	Hanslone & James McDaniel	Laura Valeroso & David Soldman
William Christian	David Herdich	Brian Mendes	John Vaccarone
Arnold Chvins	Peter Herdich & Karen Trott	Audrey Meyer	Susan Vilucci
Ethan Coen & Trish Cooke	Jane Hoffman	Nancy Meyer & Marc Weiss	Mary Pat Walsh
Joel Coen & Frances McDormand	Willy Holtzman & Sylvia Shepard	Linda Michaels	Sarah & Milledred Walton
Ruth Cohen	Sarah Horowitz	Andrew & Marylou Milano	Philip Waxbaum
Richard Cohn	Barbara Howard	Kenneth Morrato	Laura Weil
Symia Cohn & Irwin Fuch	Barnard Hughes & Helen Stanborg	Patricia Murphy & Adam Spika	Norman Weinberg
Michael Connelly	Amy Irving	Leslie Myers	Larry & Sally Weiss
Karen Cooper	Ily Jacobs	Kate Nelligan & Rob Reale	Max and Barbara Wilk
Thomas Cott	Marc Jaffe & May Wulfrich	Fred Nelson	Elizabeth Williams & Joseph Forte
Margaret Crimmons & Pierce Rafferty	Andre Jaecke	Randy & Rona Nelson	Matt Williams
Joan Strauss Cullman	Berol Jamar	Jim Neuwirth	Stephen M. Wilson
John Cunningham	Daniel Jenkins	Paul Newman & Joanne Woodward	Donald Windham
	Hope Jessup	Elen Novack	BR Wubel
	M. Lynne Johnson		Janine & Jeffrey Yass
			James & Mary Lin Yoshimura

The 52nd Street Project Presents



The Jonathan Larson Playmaking Plays

Friday, December 12 at 7:30 p.m.

Saturday, December 13 at 3:00 and 7:30 p.m.

Sunday, December 14 at 3:00 p.m.

Primary Stages, 354 W. 45th St., New York City



# WILD LIFE: THE UNINHIBITED PLAYS

The Jonathan Larson Playmaking Plays

Dec. 12, 13, and 14, 1997  
Primary Stages, New York City

## Project Staff

Willie Reale, Artistic Director  
Carol Ochs, Executive Director  
Michael Bernard, Associate Artistic Director  
Sally Bock, Director of Development and Marketing  
George Roman Babiak, Production Manager  
Julie Feldman, Director of Education  
Susan J. Vitucci, Development Consultant  
Iris A. Brown, Graphic Designer  
Christina Romero, Chip Sommer, Jason Valk - Interns

## Production Staff

Dave Baron, Composer  
Kevin Joseph Roach, Set Designer  
Greg MacPherson, Lighting Designer  
Mimi O'Donnell, Costume Designer  
Greg Costas, Costume Assistant  
Jeremy M. Posner, Sound Designer  
Slide Design:  
Renato Castilho, Adam Rodriguez,  
Mike Sell  
Prop Construction Team:  
George Babiak, Lorraine Calderon,  
Aaron Coleman, Jane Conboy,  
Omar Divina, Esther Geller,  
Karen Gusdorf, Henry Hagerty,  
Mary Alice Huggins, May Konfong,  
Midge Lucas, Zaida Natera,  
Betsy Skuda, Yazzy Troche,  
Henry Wishcamper  
Colorform Designers:  
Sarah Hokanson, Katie Dominguez



PROGRAM LAYOUT: GEORGE BABIAK

Snail Illustration: Adam Shanosky  
Anne Lowrie, Stage Manager  
Slide Operator:  
Jean-Paul Gressieux  
Furniture Crew:  
Doug Lockwood, Ray Harold  
Prop Crew:  
Chip Sommer, Luis Santoni  
Colorformist:  
Kate Ryan  
Load-in and Light Hang Crew:  
Buzz Bovshow, Tim Gallagher,  
Jean-Paul Gressieux, Mark Kobak,  
Anne Lowrie, Mark McDonald,  
Ellen Melaver, Jeremy M. Posner,  
Matt Saniac, Chip Sommer,  
Jason Valk, Charlie Wittreich  
House Manager: Karin Schall  
House Crew: Diana Feldman,  
Sarah Bakker, Sharon Kay



NATIONAL  
ENDOWMENT  
FOR THE ARTS

The Playmaking Program is made possible with public funds from the National Endowment for the Arts, New York State Council on the Arts, a state agency, the Department of Youth and Community Development, the New York City Department of Cultural Affairs, and the office of the President of the Borough of Manhattan.



NYSCA

The 52nd Street Project is a non-profit organization that brings children from the Hell's Kitchen/Clinton neighborhood together with professional theater artists to create theater. **WILD LIFE** is part of our Playmaking program. Young people participate in eight weeks of classes taught by Michael Bernard and adapted for the Project by Daniel Judah Sklar from his book, *Playmaking: Children Writing and Performing Their Own Plays*. During the class sessions, the participants learn the elements of drama and write their first play. At the end of the class, each child is given two actors, a theme and a director who guides him or her through the writing of a play during a weekend retreat in the country. **WILD LIFE** is the fruit of their labors.

## The 52nd Street Project Board of Directors

Ben Barenholtz	Louis P. Friedman	Patricia M. Murphy, Esq.
Lisa Benavides	Stephen Graham	Carol Ochs
Rachel Chanoff	Larry Jones	Willie Reale
Ruth Cohen	James McDaniel	Pamala Tyson
Heidi Ettinger	Frances McDormand,	Laura Valeroso
Wendy Ettinger, <i>chair emeritus</i>	<i>chairperson</i>	Elizabeth Williams

## Special Thanks To:

Most gracious hosts Eric Karpeles and Mike Sell and our host families Dan Henry, Sohail Raikhy, Sara and Bill Spoerri, the Cobbs, Fred Van Natta and Michael Post, Bonnie and Ryan Rutledge, the Pursches, Joyce and Bob Ward; Marcia Dunsmore and Settler's Inn. Extra-special thanks also to Casey Childs, Seth Gordon, and the staff of Primary Stages.

## In-Kind Contributions:

Primary Stages; Ensemble Studio Theatre; Playwright's Horizons; Colorforms; Neil A. Mazzella & Hudson Scenic Studios, Inc.; Baron & Baron; Shays & Murphy; Iris A. Brown & Bernhardt/Fudyma Design Group; Ron Kastner, Capital Printing; The Estate of Jonathan Larson; Masque Sound; New Dramatists; Steve Olsen & The West Bank Cafe; Materials for the Arts; Port Authority; Mayor's Office of Film & Television; John A. Vassilaros & Son; Paris Chocolates; Scholastic Productions; Coleman, Inc.; Watkins Products; Eric Karpeles & Mike Sell; Bill Muddyman and the Chateau de Berne; Boylan's Bottling Company, David Sneddon and Fairway Market.

## And for help with our Christmas mailing thanks must also go to:

Peggy Adler, Taro Alexander, Ceci Arana, Stephanie Berger, Buzz Bovshow, Julie Boyd, Lorraine Calderon, Chanel Christiansen, Carol Clarke, Charina Corbett, Noël Dawkins, Ned Eisenberg, Felicita, Kevin Geer, Stephen Haff, Jonathan, Doug Lockwood, Luis Maldonado, Peter Manning, Barbara McCrane, Eris Migliorini, Michaela Murphy, Jeremy M. Posner, Christopher Quinn, Kim Sherman, Paul Taviani, Jason Valk, Sharon Washington, Chris Wigle, Henry Wishcamper, and Mr. Frank Wood.



**Don't miss our upcoming shows!**



Sunday, Dec. 21 at 4:00 and 8:30

## New York Noël

A benefit for the 52nd Street Project with Rosanne Cash, Iris DeMent, Loudon Wainwright III, Suzzy Roche, Andrea Marcovizzi, Dee Carstensen, David Massengill and a special encore performance of a Project play featuring Jayme Rosado and Adrienne Shelly.

Tickets \$20. Call The Bottom Line at (212) 228-6300 to order yours!

## The Two-on-Two's



Jan. 30, Jan. 31, and Feb. 1  
The Ensemble Studio Theatre

In the One-on-One's, a single kid is paired with a single adult. Now you can see two kids perform a play written by an adult and directed by another adult.

**WINTER SERIES**

## Playmaking

March, 1997



In January, our next batch of newcomers will undertake the 10-week Playmaking program. At the end of the class they will be whisked away to Connecticut for a weekend to fashion a set of plays. The only thing they need: an audience.

## WILD LIFE: ACT I

All songs composed by Dave Baron

### A Terrible Day

Written by Steven Vasquez, age 10  
Dramaturg: Max Wilk Director: Michael Bernard

Charlie ..... Reed Birney  
Anna ..... Melody Cooper  
Announcer's voice ..... Jason Valk

### E X A = A (Erica X Adrian = Audition)

Written by Chanel Christiansen, age 10  
Dramaturg/Director, Suzen Murakoshi

Erica Prime, a giraffe ..... Nancy Giles  
Adrian Foots, a monkey ..... Taro Alexander  
Offstage voice ..... Jason Valk

### Cheetah and Bear

Written by Charina Corbett, age 10  
Dramaturg/Director: Julie Boyd

Bear Loose ..... William Christian  
Cheetah Renee Goodsell ..... Ali Marsh  
"Oh, We're A Happy Family" lyrics by Charina Corbett

### I Want Those Sneakers

Written by Yazyzy Troche, age 11  
Dramaturg/Director: Robert Shaffron

Sabrina ..... Laura Jean Smith  
David, her father ..... Alex Draper  
A Dog ..... Doug Lockwood  
Shoe Salesman ..... Tom Carrozza

☞ **INTERMISSION** ☜

**ACT 2**

**The Cat That Taught The Dog and The Dog That Taught the Cat**

Written by Isaac Trujillo, age 10  
Dramaturg/Director: Josh Astrachan

Mikey, a puppy ..... Yusef Bulos  
Joanna, a kitty ..... Kaleda Davis  
Three Dogs ..... Kate Ryan, Chip Sommer, Doug Lockwood  
"Bad To The Bone" lyrics by Isaac Trujillo

**The Friendly Ghost**

Written by Zaida Natera, age 11  
Dramaturg/Director: Jose Dominguez

Maggie, age 13 ..... Sharon Washington  
Lizette, age 12 ..... Patricia Triana  
Ms. Rodriguez ..... Patricia Triana  
The Ghost ..... Arthur French

**Mark and Ashley's Christmas**

Written by Joel Lind, age 11  
Dramaturg/Director: John Steber

Mark, an ordinary grizzly bear ..... Frank Wood  
Ashley, a polar bear ..... Nancy O'Connor  
Mickey the Toy Guy, a crocodile ..... Tom Carrozza

**All About Shopping**

Written by Lorraine Calderon, age 11  
Dramaturg: Willy Holtzman Director: Willie Reale

Melissa ..... Lisa Benavides  
Massiel, her mother ..... Dana Ivey  
Saleswoman ..... Dana Ivey  
Tommy ..... Dana Ivey  
Barbie ..... Dana Ivey  
Dennis ..... Dana Ivey

**Cool Stuff ON SALE IN THE LOBBY**

The Fabulous Flyer Bar (in five flavors)  
\$2.00 and \$1.50 (\$1.00 for kids)

And featuring Shel Silverstein's "Fivey and Twoey" logo:

Project T-Shirts — \$12.00

Project Caps — \$15.00

Project Mugs — \$5.00, filled with seltzer!

Playmaking: Children Writing and Performing Their Own Plays  
by Daniel Judah Sklar \$14.00

Thank you for coming to WILD LIFE. If you are not on our mailing list (or if your address has changed), please fill out this form and give it to us on your way out or mail it to the address below. We would also like to know if you are interested in becoming a volunteer. We need help in *all areas*, so please fill out your name and phone number, and we'll call you.

**PLEASE ADD ME TO YOUR MAILING LIST:**

NAME \_\_\_\_\_

ADDRESS \_\_\_\_\_

ZIP \_\_\_\_\_

HOME PHONE \_\_\_\_\_

DAYTIME PHONE \_\_\_\_\_

**YES, I WOULD LIKE TO BE OF HELP. I CAN:**

- Help load in and out for shows
- Draw and/or paint
- Help kids with homework
- Hang lights
- Help with mailings
- Teach kids a skill
- Work on a backstage crew
- Do office work
- Be a chef at an event
- Other (please specify) \_\_\_\_\_

**MY SCHEDULE IS:**

- Very flexible. I'm often available during weekdays.
- Somewhat flexible. I can help on the occasional morning or afternoon during the week.
- Not very flexible at all, but I've got some free time on evenings and weekends.

If you would like to mail this (and you're always welcome to enclose a tax-deductible contribution), you can send it to: The 52nd Street Project, 500 West 52nd St. New York, NY 10019. Or fax it to (212) 333-5598.

The 52nd Street Project gratefully acknowledges the support of the following foundations and corporations: Anonymous, Barker Welfare Foundation, Berkman's World of Expression Foundation, Chase Manhattan Bank, Citi's 5's, Donations, Lufkin & Jernette, Dramatic's Guild Fund, Dramatic's Play Service, Educational Foundation of America, EPIC, Fan Fun & Laxie R. Semovs Foundation, Helene W. Goldsmith Foundation, Florence Gould Foundation, Wilam & Mary Greve Foundation, Hambrecht & Quist, Holland Lodge Foundation, Rita J. & Stanley H. Kaplan Foundation, Jonathan Leason Performing Arts Foundation, Lloyd's Bank, MCI Foundation, James A. Macdonald Foundation, Ann M. Martin Foundation, J. P. Morgan Charitable Trust, Morgan Stanley Foundation, New World Foundation, The New York Times Co. Foundation, Northwest Point, Laura Fels Foundation, Pumpkin Foundation, Sauss Entertainment, Scherman Foundation, Slings & Design, Inc., Jules & Doris Stein Foundation, Harold & Mimi Steinberg Charitable Trust, Sutcliffe Foundation, Surdna Foundation, Sycamore, Traverses Foundation, UJA Acheam Welfare Fund, Warner Family Foundation, Westcon, York Construction. In addition, the following individuals made gifts of over \$100 to the 52nd Street Project the year (at current as of 12/31/97):

Jack Alexander	Paul Daniels	Jay Jolly	Kevin O'Rourke & Beth Thurber
May Amsen	Arthur Davidson	Larry & Mary Jones	Steve Olson
William Aronov & Steven Jacobson	Peter & Judith Dawkins	Lee Katchem & Julia Lord	Paul Orlowski
Amy Appalo & Drew McCoy	Vince DeGamo	Eric Karpewicz & Mike Sal	Kristina Pankov
Alex Affa & Kay Metzkelet	Cipa & Maha Dichter	Ronald Kadner	John Pappan
Peter Arkin	Jamie Doron	Phyllis Kaufman	Ethan Phillips
Jane Ballinger & Michael Debbian	Jan Don & Robert Mason	Sheila Kenne	Peter Phillips
Stephanie Barber	Polly Draper	Mark Kacopen & Wendy Townsend	Michael Pignataro
Ben Baranofitz	John Drayton, Jr.	Rudy King	Richard Politschek
Angela Belsert	Rick & Rebecca Drexler	Woods King, Jr.	Christopher Reinstein
Jessica Bauman	Stephen Dubois	Seth & Beth Klaman	Gena Rapp
Laura Beechman & Neal Mazzetta	Darryl Dunn & Mark Singer	Francis & Joseph Koker	Richard Raucherberg
Lisa Benavides & Tim Nelson	Ann Doyle	Mary Kong	Jacquelyn Rangold
Andrew Bergman	Charles Dumas	Jill Kovacs & Jacki Gora	Alyson Rose-Taylor
Eleanor Bergstein	Christopher & Karen Edlowes	Dave Kuhn	Ken & Michele Richardson
James Berkus	Ned Eisenberg	Judy Kuhn & David Schwab	Neil Richter
Franca Bellin & Wilam Carden	Jacquelyn Effer	Roger & Belle Kuhn	Harold Rich
Barry & Myra Bernard	Barbara Elkan	Esther & Howard Langbaum	Jacques Risse & Carol Or
Michael Bernard	Dan Eldbach & Janet Reich	Elizabeth & Jeffrey Lange	David Rosenberg
Alexander Bernstein &	Michael Engler	Jill Larson	Wesley & Clifford Ross
Elizabeth Vaccaro	Roberta Edinger	Laurinda Levine	Donald Ruchschid & Lillian Stovers
in memory of Ron Black	Hadi Elberger	Sue Leibman	Daniel & James Ross
Richard Blackstone	Wendy Elberger & Derek Mc Lane	Syren Lewis	Howard Rubin
Laura Blanco and Robert Sharnbat	El Fagerstak &	Ellen Lewis	Jane Sengerman & Joseph Vaccaro
Audrey Booth & Joseph Weinsthal	Catherine McLennan	Kenneth & Evelyn Loper	Karin & Tom Schatz
Burt Bloomberg and Mary Farrell	Christina Fischer & David Sneedon	Dawn Littlefield	Kari & Mary Ann Schuster
Robt & Ruth Dumanian	Mark Franco	John Bedford Lloyd &	Stellan Salk
Sally Dock	David Frankel	Anne Twomey	Jerry Salk
Jane Dolbow & Gave Westner	Eric Frankel	Margot Leggio	Bernice Shawl
Cristina Dotz Englestein	Kenneth Frazier	Phyllis & Martin London	James Sheridan
Patrick Dren	Noam Frensdlich & Charles Miles	Katherine Lumb & Joe Vlah	Marc Shross & Esther Trierl
Bertha & Samuel Erb	Louis & Patricia Friedman	John Lyons	Jacqueline Simon
Becky Bowerly & Ted Neustadt	Peter Fitchard & Pamela Nelson	Barbara McGuire & Paul Raabe	Keri Smith
Deborah Brown	David Gokub & Lisa Pozza	Peter & Marlene Madsen	Les Smith
Denise Burns &	Joseph Gaudin	Greg MacPherson	Angel Sokoren
Peter Jay Fernandez	Cala & Nigel Gershenson	Rama Maffia	Warren Specter
Kara Burton & Michael Rautke	Jenny Gershen & Mike Ragan	Sarah Maffa	Robert Spethin & John Dieber
Cori Cahani & Bernard Gershen	Alan Gershen	Elizabeth Manne	Fisher Stevens
Steve Callahan & Christine Dunn	Reen Gertz & Mark Grinner	Mark Mantucci	Tim Stephenson & Adriana Tragan
Carika Campbell & Oliver Platt	Nancy Giles	Constance Marks	Daniel Weiss
Coleen Campbell & Michael Semei	Henry Gilford	Ann M. Martin	Meliko Tala
Richard & Lisa Cashin	MacEllis Glass	George Meyer, Jr.	Jay Tarses
John Cavella & Lucy Kaplan	Stephan & Cathy Graham	Jeffrey & Katrina Meyer	Matt Tarses
Kathy Chaloff	Michael Orell	Max Mayer	Alison Talbot
Stockard Channing	Emily Grahman & Susan Sempiner	Bruce MacVitt & Carol Ohta	Stephen Toback
Rachael Charoff	Lisa J. Guperman	Mary McCann & Neil Pepe	Lu Tuccio
Ted Chapin	Robert & Leah Hani	Dana McCoy	Adam Ustin
Larry Charoff & Ross Gazler	Maria Gay Harbin	Paul McCrane	Laura Valente & David Swedman
Genita Chesnik	Paul Hegman & Charlotte Elberton	Hannette & James McDonnell	John Vaccaro
Marissa Chibot & Travis Preston	David Herlich	Brian Menko	Susan Vitucci
William Christian	Peter Herlich & Karen Trist	Audrey Meyer	Mary Pat Walsh
Arnold Dine	Jane Hoffman	Nancy Meyer & Marc Weiss	Sarah & Michael Walden
Ethan Dorn & Leah Cooke	Wly Hertzman & Sylvia Shepard	Linda Michaels	Philip Weisbaum
Joel Dorn & Frances McDonnand	Sarah Horowitz	Andrew & Marylou Milano	Laura Weil
Ruth Cohen	Barbara Howard	Kenneth Monro	Norman Weisberg
Richard Cohn	Bernard Hughes & Helen Swarborg	Patricia Murphy & Adam Spika	Larry & Sally West
Zippora Cohn & Iwan Fisch	Any Irving	Leslie Myers	Max and Barbara Wilk
Michael Connelly	Sy Jacobs	Kara Neffgen & Rob Reese	Elizabeth Williams & Joseph Fom
Karen Cooper	Matt Jaffe & May Hufsch	Fred Nelson	Matt Williams
Thomas Cott	Andre Jaacke	Randy & Rhina Nelson	Stephen M. Wilson
Margaret Cimmino &	Benoit Jamar	Jim Newirth	Donald Wodman
Pierce Rafferty	Daniel Jenkins	Paul Newman &	Bill Whaler
John Strauss Culman	Hope Jessup	Janna Woodward	Janine & Jeffrey Yass
John Cunningham	M. Lynn Johnson	Ellen Novack	James & Mary Lin Yonemura

The 52nd Street Project Presents



## Plays of Fortune

The 1998 Two-On-Twos

Friday, January 30 at 7:30 p.m.

Saturday, January 31 at 3:00 and 7:30 p.m.

Sunday, February 1 at 3:00 p.m.

Ensemble Studio Theater, 549 West 52nd St., New York City

---

# The Luck of the Draw: Plays of Fortune

The 1998 Two-On-Twos

Jan. 30 and 31, February 1, Ensemble Studio Theater, New York City

---

## Project Staff

Willie Reale, Artistic Director  
Carol Ochs, Executive Director  
Michael Bernard, Associate Artistic Director  
Sally Bock, Director of Development and Marketing  
George Roman Bablak, Production Manager  
Julie Feldman, Director of Education  
Susan J. Vitucci, Development Consultant  
Iris A. Brown, Graphic Designer  
Christina Romero, Jason Valk, Henry Wishcamper - Interns

## Production Staff

Patrick Barnes, Composer  
Kevin Joseph Roach, Set Designer  
Mark O'Connor, Lighting Designer  
Crystal Thompson, Costume Designer  
Jeremy M. Posner, Sound Designer  
Slide Design Crew Chief: Katherine Lumb  
Slide Design:

Renato Castilho, Adam Rodriguez,  
John Steward, Alberta Testanero

## Slide Colorers:

William Brown, David Dominique,  
Candy Godoy, Hakim Latimore,  
Mark McDonald, Marcsi Mysak,  
Zauza Mysak, Jaya Rosado

## Prop Construction Team:

Annika Ahlstrom, George Bablak,  
William Brown, Aaron Coleman,  
Katie Dominguez, Nedra Gallegos,  
Hillary Gifford, Sarah Hokanson,  
Jennifer Jimenez, Stacey Linden,  
Jenny Maniss, Carla Reyes,  
Jaysunn Rosado, Betsy Skuda,  
Damaris Webb, Zara Wike,  
Henry Wishcamper

## Colorform Designers:

Sarah Hokanson, Katie Dominguez

## Program and Flyer Illustration:

Adam Rodriguez

## Noël Dawkins, Stage Manager

## Slide Operator:

Kimberly Kelly Wilson

## Furniture Crew:

Luis Santoni, Thomas "Grizzly" Santoni

## Prop Crew:

Christopher Quinn, Mark McDonald

## Colorformist: Kate Chaston

## Lighting Technicians:

Dorion Fuchs, Paul Israel,  
Brad Robertson

## Load-in and Light Hang Crew:

Sarah Bakker, John Krupp,  
Barbara Lempel, Anna LI,  
Anne O'Sullivan, Tom Schall,  
Jason Valk, Henry Wishcamper

## House Managers:

Beth Emelson, Mary Pat Walsh

## House Crew:

Sarah Bakker, Marc Grobman

PROGRAM LAYOUT: GEORGE BABLAK

The 52nd Street Project is a non-profit organization that brings inner-city children from the Clinton neighborhood together with professional theater artists to create theater. **THE LUCK OF THE DRAW** is part of our Two-On-Two program, in which two of the Project's more seasoned kids are matched with two adult Project volunteers (one playwright, one director) and given the task of creating a short play. Each year, the duos travel *en masse* to Dutchess County, New York to rehearse the plays over a three-day weekend. This show is the fruit of their labors.

The Project is delighted to return to the Ensemble Studio Theatre, where we have been performing since our inception in 1981. We congratulate EST on its 25th anniversary and gratefully acknowledge the fact that if they weren't here we'd be nowhere.

---

## The 52nd Street Project Board of Directors

Ben Barenholtz	Louis P. Friedman	Patricia M. Murphy, Esq
Lisa Benavides	Stephen Graham	Carol Ochs
Rachel Chanoff	Larry Jones	Willie Reale
Ruth Cohen	James McDaniel	Pamala Tyson
Heidi Ettinger	Frances McDormand,	Laura Valeroso
Wendy Ettinger, <i>chair emeritus</i>	<i>chairperson</i>	Elizabeth Williams

---

## Special Thanks To:

Our most gracious hosts Wendy Ettinger and Derek McLane, Frances McDormand and Joel Coen, Maria Tucci, and Alice Provenson. Thanks also go to New Dramatists, Paul Smithyman and the Women's Interart Center, and Curt, Jamie, Elza, and the Ensemble Studio Theatre.

---

## In-Kind Contributions:

Ensemble Studio Theatre, Primary Stages, Playwright's Horizons, Colorforms; Neil A. Mazzella & Hudson Scenic Studios, Inc.; Baron & Baron; Shays & Murphy; Iris A. Brown & Bernhardt/Fudyma Design Group; Ron Kastner, Capital Printing; The Estate of Jonathan Larson; Masque Sound; New Dramatists; Steve Olsen & The West Bank Cafe; Materials for the Arts; Port Authority; Mayor's Office of Film & Television; John A. Vassilaros & Son; Paris Chocolates; Scholastic Productions; Coleman, Inc.; Watkins Products; Eric Karpeles & Mike Sell; Bill Muddyman and the Chateau de Berne; Boylan's Bottling Company; David Sneddon and Fairway Market.



NATIONAL  
ENDOWMENT  
FOR THE ARTS

The Two-On-Two Program is made possible with public funds from the National Endowment for the Arts, New York State Council on the Arts, a state agency, the Department of Youth and Community Development, the New York City Department of Cultural Affairs, and the office of the President of the Borough of Manhattan.



NYSCA

**Don't miss our upcoming shows!**

# Playmaking

**March 20-22, 1998**



Our next batch of newcomer kids has just begun the 10-week Playmaking program. At the end of the class they will be whisked away to Connecticut for a weekend to fashion a set of plays. The only thing they need: an audience. (Theater to be announced).

## **THE WILD, WILD WEST**



(of 10th  
Avenue!)

## **BAR-BEE-CUE BENEFIT**

May 4th at The Puck Building

The game-show parody has been run out of town on a rail! This year's benefit theme will bring us cowboys, horses, bad guys, and lots of foam-core six-guns. Lasso this date, hog-tie it, and pen it up in your Filofax. For more information or reservations call **Sally Bock**, our Director of Marketing and Development (who looks pretty darn cute in a 10-gallon hat) at 333-5252.

## **The Luck of the Draw: Act I**

All songs composed by Patrick Barnes

### **The Devil's In The Details**

Written by Susan Kim

Directed by Martha Banta

Letitia LeGrand ..... Tanika Parson

Toby Kentish ..... Osage Lewis

*The Devil's In The Details*, lyrics by Willie Reale

### **Saving Luck**

Written by Anne Garcia-Romero

Directed by Seret Scott

Alana Ducane ..... Candy Godoy

Steve Powers ..... David Dominique

Henry "Luck" Ofthuhdraw ..... George Babiak

Sam Dexor ..... George Babiak

*We Saved Luck*, lyrics by Anne Garcia-Romero

### **A Little Soul-Searching**

Written by Willie Reale

Directed by Stephen Haff

Randolph ..... Hakim Latimore

Prudence ..... Marcsi Mysak

The Voice ..... George Babiak

*The Felicity Global Anthem, Mon Amour Jacques, and*

*Maybe Someday Joy*, lyrics by Willie Reale

☞ **INTERMISSION** ☞

## Act 2

### The Button

Written by Michael Bernard  
Directed by Taro Alexander

GXB3 ..... Noel Polanco  
LRT6 ..... William Brown  
KSR2 ..... George Babiak

*Break A Rule*, lyrics by Michael Bernard

### The Ballad of Fast Tony

Written by Richard Dresser  
Directed by Joe White

Fast Tony ..... Tony Santiago  
Really Fast Eddie ..... Eddie Cooper

### How to Win Friends and Influence Others

Written by Adrienne Shelly  
Directed by Lisa Benavides

Betty the Boop ..... Jaya Rosado  
Tipper ..... Zsuzsa Mysak  
Buddy, Aunt Edna ..... Michael Bernard

*Vegas!* and *Have Fun*, lyrics by Adrienne Shelly

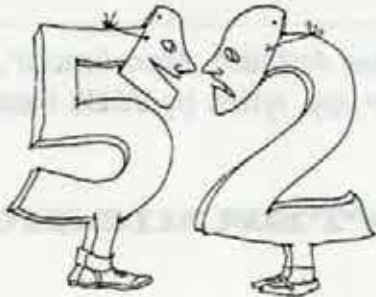

## Cool Stuff ON SALE IN THE LOBBY

The Fabulous Flyer Bar (in five flavors)  
\$2.00 and \$1.50 (\$1.00 for kids)

Playmaking: Children Writing and Performing Their Own Plays  
by Daniel Judah Sklar — \$14.00

And featuring Shel Silverstein's "Fivey and Twoey" logo:

Project Mugs — \$5.00, filled with seltzer!

Project T-Shirts — \$12.00 *New long-sleeve version!* — \$15.00

Project Baseball Caps — \$15.00

Thank you for coming to THE LUCK OF THE DRAW. If you are not on our mailing list (or if your address has changed), please fill out this form and give it to us on your way out or mail it to the address below. We would also like to know if you are interested in becoming a volunteer. We need help in *all areas*, so please fill out your name and phone number, and we'll call you.

#### PLEASE ADD ME TO YOUR MAILING LIST:

NAME \_\_\_\_\_

ADDRESS \_\_\_\_\_

ZIP \_\_\_\_\_

HOME PHONE \_\_\_\_\_

DAYTIME PHONE \_\_\_\_\_

#### YES, I WOULD LIKE TO BE OF HELP. I CAN:

- |   |   |  |
|---|---|--|
| <input type="checkbox"/> Help load in and out for shows | <input type="checkbox"/> Draw and/or paint  | <input type="checkbox"/> Help kids with homework |
| <input type="checkbox"/> Hang lights                    | <input type="checkbox"/> Help with mailings | <input type="checkbox"/> Teach kids a skill      |
| <input type="checkbox"/> Work on a backstage crew       | <input type="checkbox"/> Do office work     | <input type="checkbox"/> Be a chef at an event   |
| <input type="checkbox"/> Other (please specify) _____   |   |  |

#### MY SCHEDULE IS:

- Very flexible: I'm often available during weekdays.  
 Somewhat flexible: I can help on the occasional morning or afternoon during the week.  
 Not very flexible at all, but I've got some free time on evenings and weekends.

If you would like to mail this (and you're always welcome to enclose a tax-deductible contribution), you can send it to: The 52nd Street Project, 500 West 52nd St. New York, NY 10019. Or fax it to (212) 333-5598.

The 52nd Street Project gratefully acknowledges the support of the following foundations and corporations: Anonymous, Barker Welfare Foundation, Berlesemann's World of Expression Foundation, Brittain-Grey Motion Pictures, Chase Manhattan Bank, Creative Artists Agency, Cubic 8's, Donalson, Lukin & Jewette, Dramatist's Guild Fund, Dramatists Play Service, Jean and Louis Dreyfus Foundation, Educational Foundation of America, EPIC, Fairway Market, Fan Fox & Leslie R. Samuels Foundation, Horace W. Goldsmith Foundation, Florence Gould Foundation, William & Mary Greve Foundation, Hambrecht & Quist, Hennessy Foundation, Halted Lodge Foundation, In Style Magazine, Rita J. & Stanley H. Kaplan Foundation, Jonathan Larson Performing Arts Foundation, Lloyd's Bank, MCJ Foundation, James A. Macdonald Foundation, Ann M. Martin Foundation, J. P. Morgan Charitable Trust, Morgan Stanley Foundation, Newman's Own, New World Foundation, The New York Times Co. Foundation, Northwest Point, O'Grady Family Foundation, Laura Pels Foundation, Pumpkin Foundation, Russek Advertising, Sauced Entertainment, Sherman Foundation, Seth Sprague Educational Charitable Foundation, Staging & Design, Inc., Jules & Doris Stein Foundation, Harold & Miri Steinberg Charitable Trust, Galtberger Foundation, Gurdna Foundation, Squawhanna, Technicolor Film Services, Travelers Foundation, United Talent Agency, Inc., Uta Acheson Wallace Funds, Wiener Family Foundation, Wind Dancer, Yorks Construction. In addition, the following individuals made gifts of over \$150 to the 52nd Street Project this year (list current as of 3/17/98):

Jace Alexander  
May Aween  
Miriam Ariano & Steven Jacobson  
Amy Aquino & Drew McCoy  
Cecilia Arena  
Alan Avila & Kay Matschulat  
Peter Askin  
June Ballinger & Michael Goldstein  
Stephanie Barber  
John Barlow  
Ben Barinholtz  
Angela Bassett  
Justica Bauman  
Laurie Becker  
Lisa Benavides & Tim Nelson  
Andrew Bergman  
Eleanor Bergstein  
Pamela Berlin & William Carden  
Barry & Myra Bernard  
Michael Bernard  
Alexander Bernstein &  
Elizabeth Velazquez  
In memory of Ron Black  
Susan Black  
Richard Blackstone  
Laura Bianco and Robert Shainheit  
Audrey Bloch & Joseph Wiesenthal  
Shaun Bloomberg and Mary Farnel  
Robi & Ruth Blumenstein  
Sally Book  
Jane Bolter & Steve Wortimer  
Chandra Botz Singleton  
Patrick Brown  
Bertha & Samuel Brit  
Recky Browder & Ted Neustadt  
Deborah Brown  
Henry Buhl  
Denise Burns &  
Peter Jay Fernandez  
Katie Burton & Michael Ritchie  
Cora Cahlan & Bernard Gersten  
Steve Callahan & Christine Dunn  
Candice Campbell & Oliver Platt  
Coleen Carroll & Michael Semel  
Richard & Lisa Cashin  
John Cavello & Lucy Kaplan  
Kathy Chaffin  
Stockard Channing  
Rachel Charoff  
Ted Chapin  
Ellen Chessworth  
Larry Chertoff & Rose Gasner  
Gwendolyn Chesche  
Melissa Chibas & Travis Preston  
William Christian  
Arnold Civins  
Ellian Coen & Trish Cooke  
Joel Coen & Frances McDormand  
Ruth Cohen  
Richard Cohn  
Suzanne Cohn & Irwin Fisch  
Frank Collins  
Michael Connelly  
Karen Cooper  
Thomas Cott  
Margaret Crammons &  
Pierce Rafferty  
Stephen Crudgington  
Joan Strauss Cullman  
John Cunningham  
William Dabe  
Arthur Dantschik  
Peter & Judith Dawkins

Vince DeGano  
Cipa & Misha Dichter  
James Dixon  
Edward A. Drogons  
Jan Donn & Robert Mason  
John Drayton, Jr.  
Rick & Rebecca Dresser  
Stephen Dubner  
Darcy Dunn & Mark Singer  
Ann Doyle  
Charles Dumas  
Christopher & Karen Eddowes  
Ned Eisenberg  
Jacquelyn Elliott  
Barbara Eilan  
Burt Ezbach & Janet Raich  
Barbara Ellinger  
Heidi Ellinger  
Wendy Ellinger & Derek McLane  
Christine Flischer & David Sneddon  
Katherine C. Foster  
Mark Francis  
David Frankel  
Eric Frankel  
Kermit Frazier  
Naomi Freundlich & Charles Miles  
Louis & Patricia Friedman  
Peter Fritschel & Pamela Nelson  
Joseph Gaudak  
Celia & Hillel Gershenson  
Jenny Gersten & Willie Raabe  
Jill Gersten  
Ileen Getz & Mark Grinnel  
Nancy Giles  
Henry Gillford  
MacEllis Glass  
David Golub & Lisa Piazza  
Stephen & Cathy Graham  
Michael Graf  
Emily Grishman & Susan Sampliner  
Lisa J. Guggenheim  
Robert & Leah Hahn  
Marcia Gray Harden  
Paul Hejman & Charlotte Ellerson  
Peter Herdlich & Karen Trott  
Dr. David Heltalge  
Jane Hoffman  
Willy Hultman & Sylvia Shepard  
Sarah Horowitz  
Barbara Howard  
Bernard Hughes & Helen Starborg  
Amy Irving  
Allison Jacobs  
By Jaculis  
Peter Jacobson  
Marc Jaffe & May Wutrich  
Andre Jackie  
Bevitt Jancar  
Daniel Jenkins  
Hope Jessup  
M. Lynne Johnson  
Neil R. Johnson  
Jay Joffe  
Larry & Mary Jones  
Lee Kalkheim & Julia Lord  
Eric Karpelos & Mike Sell  
Ronald Kasner  
Phyllis Kaufman  
Sheila Kefoe  
Mark Kepppen & Wendy Townsend  
Rusty King  
Woodie King, Jr.  
Richard Kirshenbaum

Seth & Beth Klarman  
Francis & Joseph Kalka  
Mary Kong  
Jan Krolze & Jacki Ochs  
David Kuhn  
Judy Kuhn & David Schwab  
Roger & Belle Kuhn  
Elaine & Howard Langbaum  
Elizabeth & Jeffrey Lange  
Carol Langstaff  
Jill Larson  
Laurence Lavine  
Sue Leibman  
Mickey Leslie  
Daf Lemmon  
Robert Sean Leonard  
Byron Lewis  
Ellen Lewis  
Kenneth & Evelyn Lipper  
Davien Littlefield  
John Bedford Lloyd &  
Anne Twomey  
Maggie Loggie  
Pinky & Martin London  
Katherine Lumb & Joe Vitale  
John Lyons  
Neal Mazzella  
Barbara McCrane & Paul Reale  
Peter & Marcus MacNicol  
Greg MacPherson  
Roma Malia  
Sarah Malin  
Elizabeth Manne  
Mark Mannucci  
Constance Marks  
Ann M. Martin  
Harriet Matschulat  
George Mayer, Jr.  
Jeffrey & Katrina Mayer  
Max Mayer  
Neal Mazzella  
Bruce MacVittie & Carol Ochs  
Mary McCann & Neil Pope  
Gene McCoy  
Paul McCrane  
Hannalore & James McDaniel  
Brian Merles  
Audrey Meyer  
Nancy Meyer & Marc Weiss  
Linda Michaels  
Andrew & Marylou Milano  
Andy Millon  
Kenneth Monteiro  
Patricia Murphy & Adam Spika  
Leslie Myers  
Kate Nelligan & Rob Reale  
Fred Nelson  
Randy & Rona Nelson  
Ruth Nelson  
James A. Newberger  
Renee F. Newbold  
Jim Newirth  
Paul Newman &  
Joanne Woodward  
C.J. Nolan  
Ellen Novack  
Kevin O'Rourke & Edith Thurber  
Steve Olsen  
Paul Onderdonk  
Kristine Pankow  
John Paris  
John Payson  
Arthur Peon

Ethan Phillips  
Peter Phillips  
Michael Pignatelo  
Richard Polatschek  
Christopher Randolph  
Peter & Helen Randolph  
Gene Raps  
Richard Rauchenberger  
Jacquelyn Raingold  
Alyson Rice-Taylor  
Denise Rich  
Ken & Michele Richardson  
Todd Richter  
Herold Ritsh  
Jacquie Rose & Carol Ufe  
David Rosenberg  
Betsy & Clifford Ross  
Donald Rothschild & Lotchen Shivers  
Daniel & Janice Rous  
Howard Rubin  
Lawrence A. Russo  
Steve Sabba  
Mary Saller  
Tim Sanford  
Jane Sangerman & Joseph Vadaratz  
John Sayles  
Karin & Tom Schall  
Ken & Mary Ann Schuster  
Stephen A. Schwarzman  
Campbell Scott  
Seffen Selig  
Jeffrey Sella  
Robert Shafron & John Szabo  
Bernice Shawel  
James Sheridan  
Marc Sholes & Esther Treitel  
Brian Sibernet & Pletty Dryden  
Jacqueline Simon  
Ken Smith  
Lois Smith  
Abigail Solomon  
Warren Spector  
Jeff Stafford  
Fisher Stevens  
Tim Stephenson & Adriana Tropian  
Cynthia Stevens  
Lynn Street  
Daniel Swese  
Maiko Tada  
Jay Teresi  
Alison Talbot  
Stephen Tobias  
Marta Toneri  
Gina Torres  
Liz Tuccillo  
Adam Urdan  
Laura Valeroso & David Seidman  
Wendy vanden Heuvel  
John Vassilarios & Alexandra Gertner  
Susan Vitucci  
Mary Pat Walsh  
Bonah & Mildred Watson  
Laura Weil  
Norman Weinberg  
Lenny & Sally Weiss  
Max and Barbara Wilk  
Elizabeth Williams & Joseph Forte  
Matt Williams  
Stephen M. Wilson  
Donald Windham  
Bill Wurzel  
Janine & Jeffrey Yatz  
James & Mary Lin Yoshimura



Friday, March 20 at 7:30 p.m.  
Saturday, March 21 at 3:00 and 7:30 p.m.  
Sunday, March 22 at 3:00 p.m.





# The Good Old Days: The Nostalgia Plays

March 20, 21, and 22  
Signature Theater Company, New York City

### Project Staff

Willie Reale, Artistic Director  
Carol Ochs, Executive Director  
Michael Bernard, Associate Artistic Director  
Sally Bock, Director of Development and Marketing  
George Roman Babiak, Production Manager  
Julie Feldman, Director of Education  
Susan J. Vitucci, Development Consultant  
Iris A. Brown, Graphic Designer  
Christina Romero, Henry Wishcamper - Interns

### Production Staff

Kim Sherman, Composer  
Kevin Joseph Roach, Set Designer  
Greg MacPherson, Lighting Designer  
Crystal Thompson, Costume Designer  
Jeremy M. Posner, Sound Designer  
Noël Dawkins, Stage Manager  
Slide Design:  
Renato Castilho, John Steward  
Slide Colorists:  
Anissa Albarron, Justin Aponte,  
Lorraine Calderon, Michael Feliciano,  
Marlene Moran, Jayme Rosado,  
Yazzy Troche, Ray Ocasio, Lisa Tracy  
Prop Construction Team:  
Anissa Albarron, George Babiak,  
Lorraine Calderon, Geoff Capes,  
Chris Ceraso, Jane Conboy,  
Jennifer Cummins, Alison Eisendrath,  
Joe Franchere, Nedra Gallegos,  
Karen Gusdorf, Midge Lucas,  
Anthony Orantes, Noel Polanco,  
Lori Scherer, Katy McIntyre, Eric  
Schwartz, Laura Wilson, Yvonne Rossetti

Colorform Designers:  
Sarah Hokanson, Katie Dominguez,  
Joy Kilpatrick  
Good Old Days Illustration: Celia White  
Slide Operator:  
Henry Wishcamper  
Furniture Crew:  
Jennifer Mannis, Nima Shirazi,  
Corinda Smith  
Prop Crew:  
Chris Quinn, Luis Maldonado,  
Alex Metzler  
Colorformists:  
Ray Ocasio, Dana Segal  
Load-in and Light Hang Crew:  
Tara Cook, John Krupp, Kirt Markle,  
Shirstin Olson, Charlton Ruddock,  
Matt Saniac, Liz Shapiro  
Master Electrician: Liz Shapiro  
House Manager: Karin Schall  
House Crew: Barbara Lempel, Andrea  
Nerins, Kim Raver, Charlton Ruddock  
Chef: Charlotte Armstrong

PROGRAM LAYOUT: GEORGE BABIAK

The 52nd Street Project is a non-profit organization that brings children from the Hell's Kitchen/Clinton neighborhood together with professional theater artists to create theater. **THE GOOD OLD DAYS** is part of our Playmaking program. Young people participate in eight weeks of classes taught by Michael Bernard and adapted for the Project by Daniel Judah Sklar from his book, *Playmaking: Children Writing and Performing Their Own Plays*. During the class sessions, the participants learn the elements of drama and write their first play. At the end of the class, each child is given two actors, a theme and a director who guides him or her through the writing of a play during a weekend retreat in the country. **THE GOOD OLD DAYS** is the fruit of their labors.

### The 52nd Street Project Board of Directors

Ben Barenholtz	Louis P. Friedman	Carol Ochs
Lisa Benavides	Stephen Graham	Willie Reale
Rachel Chanoff	Larry Jones	Jose Soto, Jr.
Ruth Cohen	James McDaniel	Pamala Tyson
Heldi Ettinger	Frances McDormand,	Laura Valeroso
Wendy Ettinger,	<i>chairperson</i>	Wendy vanden Heuvel
<i>chair emeritus</i>	Patricia M. Murphy, Esq.	Elizabeth Williams

### Special Thanks To:

Our most gracious hosts Stephen and Kathy Graham, Wendy vanden Heuvel, and Jane Kazmarek and Brad Whitford. More thanks to Charlotte, Celia, and Bonnie and to Vanessa Valdes. Extra-special thanks also to Tom, Jim, Elliott, and the staff of Signature Theater.

### In-Kind Contributions:

Signature Theater, Primary Stages; Ensemble Studio Theatre; Playwright's Horizons; Colorforms; Neil A. Mazzella & Hudson Scenic Studios, Inc.; Shays & Murphy; Iris A. Brown & Bernhardt/Fudyma Design Group; Ron Kastner, Capital Printing; The Estate of Jonathan Larson; Masque Sound; New Dramatists; Steve Olsen & The West Bank Cafe; Materials for the Arts; Port Authority; Mayor's Office of Film & Television; John A. Vassilaros & Son; Paris Chocolates; Scholastic Productions; Coleman, Inc.; Watkins Products; Eric Karpeles & Mike Sell; Bill Muddyman and the Chateau de Berne; Boylan's Bottling Company, BMG, John Steward, Paul Saylor and The Commonwealth Brewing Company, and David Sneddon and Fairway Market.



NATIONAL  
ENDOWMENT  
FOR THE ARTS

The Playmaking Program is made possible with public funds from the National Endowment for the Arts, New York State Council on the Arts, a state agency, the Department of Youth and Community Development, the New York City Department of Cultural Affairs, and the office of the President of the Borough of Manhattan.



NYSCA



## Don't miss our upcoming shows!

### MAY 4TH AT THE PUCK BUILDING

The game-show parody has been run out of town on a rail! This year's benefit theme will have cowboys, horses, bad guys, and lots of foam-core six-guns. Lasso this date, hog-tie it, and pen it up in your Filofax. For more information or reservations call **Sally Bock**, our Director of Marketing and Development (who looks pretty darn cute in a 10-gallon hat) at 333-5252.



The 1998 One-On-Ones  
The Ensemble Studio Theater

Series I: July 30-Aug. 2    Series II: August 27-30

## The Good Old Days: ACT I

All songs composed by Kim Sherman

### Mom And I

Written by Heavyn-Leigh American, age 12  
Dramaturg/Director: Wendy vanden Heuvel

Jenny ..... Julie Dretzin  
George ..... Robert Jimenez  
Fred ..... George Babiak  
Party guests ..... The Crew  
"Groovy Flowers" lyrics by Heavyn-Leigh American

### Nobody's Better Or Worse

Written by Marlene Moran, age 10  
Dramaturg/Director: Denise Burse

Nya Forest ..... Karen Kandel  
Lyciana Woodpickier ..... Lenore Pemberton  
The Director ..... George Babiak  
"Perfection" lyrics by Marlene Moran

### The Man Who Killed A Baby

Written by Justin Aponte, age 10  
Dramaturg/Director: Michael Bernard

Jeffrey ..... Jason Sklar  
Jason ..... Randy Sklar  
Doctor ..... Larry Nathanson  
Jennifer ..... Wendy vanden Heuvel  
Priest ..... Christopher Quinn

### The Birthday Party

Written by Peter Granados, age 10  
Dramaturg/Director: Peter Jay Fernandez

Dino Dog ..... Peter Jay Fernandez  
Bobo Kitt ..... Kimberly Kelly Wilson  
"To Love Each Other" lyrics by Peter Granados

### Regret!

Written by Jennifer Jimenez, age 11  
Dramaturg/Director: Darrell Larson

Emma ..... Martha Plimpton  
Walter ..... Michael Potts

INTERMISSION

## ACT 2

### The Golden Days

Written by Jonathan Villanueva, age 11  
Dramaturg/Director: George Babiak

Mugsy ..... Tom Schall  
The Mayor ..... Buzz Bovshow  
Grandma ..... Tom Schall  
Junior ..... Buzz Bovshow  
Gunman #1 ..... Henry Wishcamper  
Other Gunmen ..... Luis Maldonado, Ray Ocasio,  
Nima Shirazi, Chris Quinn

### The Way I Dress

Written by Anissa Albarron, age 11  
Dramaturg: Stephen Haff Director: Kay Matschullat

Jazmine ..... Cecilia Arana  
Crystal ..... Allison Eikerenkoetter  
Teacher's Voice ..... Chris Quinn

### The Monkey and the Pit Bull

Written by Michael Feliciano, age 11  
Dramaturg/Director: Robin Morse

The Owner ..... Michael Bernard  
The Monkey ..... Alison Tatlock  
The Pit Bull ..... Michael Rogers  
The Animal Catcher ..... Michael Bernard

*"The Cage Song" lyrics by Michael Feliciano*

### A Play of Two Souls

Written by Johnathan Roldan, age 11  
Dramaturg/Director: Larry Nathanson

Ryu ..... Ken Cheeseman  
Kelly ..... Adrienne Shelly

*"Happy Soul Song" lyrics by Johnathan Roldan*



## Cool Stuff ON SALE IN THE LOBBY

The Fabulous Flyer Bar (in five flavors)  
\$2.00 and \$1.50 (\$1.00 for kids)

And featuring Shel Silverstein's "Fivey and Twoey" logo:

Project T-Shirts — \$12.00

Project Caps — \$15.00

Project Mugs — \$5.00, filled with seltzer!

Playmaking: Children Writing and Performing Their Own Plays  
by Daniel Judah Sklar \$14.00

Thank you for coming to THE GOOD OLD DAYS. If you are not on our mailing list (or if your address has changed), please fill out this form and give it to us on your way out or mail it to the address below. We would also like to know if you are interested in becoming a volunteer. We need help in *all areas*, so please fill out your name and phone number, and we'll call you.

### PLEASE ADD ME TO YOUR MAILING LIST:

NAME \_\_\_\_\_

ADDRESS \_\_\_\_\_

ZIP \_\_\_\_\_

HOME PHONE \_\_\_\_\_

DAYTIME PHONE \_\_\_\_\_

### YES, I WOULD LIKE TO BE OF HELP. I CAN:

- |   |   |  |
|---|---|--|
| <input type="checkbox"/> Help load in and out for shows | <input type="checkbox"/> Draw and/or paint  | <input type="checkbox"/> Help kids with homework |
| <input type="checkbox"/> Hang lights                    | <input type="checkbox"/> Help with mailings | <input type="checkbox"/> Teach kids a skill      |
| <input type="checkbox"/> Work on a backstage crew       | <input type="checkbox"/> Do office work     | <input type="checkbox"/> Be a chef at an event   |
| <input type="checkbox"/> Other (please specify) _____   |   |  |

### MY SCHEDULE IS:

- Very flexible. I'm often available during weekdays.  
 Somewhat flexible. I can help on the occasional morning or afternoon during the week.  
 Not very flexible at all, but I've got some free time on evenings and weekends.

If you would like to mail this (and you're always welcome to enclose a tax-deductible contribution), you can send it to: The 52nd Street Project, 500 West 52nd St. New York, NY 10019. Or fax it to (212) 333-5598.

# Yeee



# Haaa!

**CHAIRPERSON**  
Frances McDormand

**ARTISTIC DIRECTOR**  
Willie Reale

**EXECUTIVE DIRECTOR**  
Carol Ochs

## HONORARY CHAIRS

Dan Aykroyd Frances McDormand



## CO-CHAIRS

Lisa Benavides  
Becky Browder  
Rachel Chanoff  
Louis P. Friedman

Patrice Friedman  
Karin Schall  
Laura Valeroso  
Mary Pat Walsh



## THE BOARD OF DIRECTORS OF THE 52ND STREET PROJECT

Ben Barenholtz  
Lisa Benavides  
Rachel Chanoff  
Ruth Cohen  
Heidi Ettinger  
Wendy Ettinger  
**CHAIR EMERITUS**  
Louis P. Friedman  
Stephen Graham

Larry Jones  
James McDaniel  
Frances McDormand  
**CHAIR**  
Patricia M. Murphy, Esq  
Jose Soto, Jr  
Pamala Tyson-Mudd  
Laura Valeroso  
Wendy vanden Heuvel

Elizabeth Williams



## THE 52ND STREET PROJECT GRATEFULLY ACKNOWLEDGES

Big Apple Lights  
BMG Entertainment  
The Body Shop  
Boylan's Bottling Co.  
Coleman  
Chile Today Hot Tamale  
Commonwealth Brewery Co. of New York  
Hudson Scenic Studios  
Masque Sound  
Nickelodeon  
Paris Chocolates  
Seagram Chateau & Estate Wines Company  
Vassilaros Coffee and  
Watkins Incorporated,  
Healthier Living Since 1868.



## STARRING

In order of appearance

Saloon Singer .....Judy Kuhn  
Uncle Tony.....James McDaniel  
Mamma.....Maria Tucci  
Jane .....Roma Maffia  
Jane .....Lili Taylor  
The Sheriff .....Victor Garber  
The Deputy.....Robert Sean Leonard  
Luigis .....Mayleen Cancel, Aisha Jabour,  
Christina Ramirez, Jaysunn Rosado,  
Peter Ventura  
Herschel .....Noel Polanco

## SONGS

"The Ballad of Tony," "Uncle Tony's Favorite Song," and \ "A Lesson From The Cacti"



## DIRECTED BY

Mark Linn-Baker

## MUSIC COMPOSED AND PLAYED BY

Henry Krieger

## LYRICS BY

Willie Reale

## BOOK BY

Willie Reale, Michael Bernard, and Lewis Black

## SET DESIGN

Kevin Joseph Roach

## LIGHTING DESIGN

Greg MacPherson

## COSTUME DESIGN

Crystal Thompson

## SOUND DESIGN

Tom Morse

## STAGE MANAGER

Hank Meiman

## SPONSORS

Matt Williams & Angelina Fiordellisi  
Wind Dancer Production Group

## HEAD HONCHO

Arthur Dantchik

## HONCHOS

Cathy & Stephen Graham  
Ronald J. Kastner  
The New World Foundation

## RANCHERS

American Movie Classics  
Blaise Box, Staging & Design  
Richard & Lisa Cashin  
Johnny Coffeeshopolis & Alexandra  
Gersten-Vassilaros  
Judith & Peter Dawkins  
Donaldson, Lufkin & Jenrette  
Heidi Ettinger  
Wendy Ettinger &  
Derek McLane  
Louis P. Friedman &  
Patrice Friedman  
Robert Goldberg &  
Betsy MacIassac  
Joanne Jacobson

Greg MacPherson &  
Jane Perlmutter  
MCJ Foundation  
Brian Mertes  
Herald & Linda Ritch  
Sauce Entertainment  
Laura Valeroso &  
David Seidman  
Anita & Albert Waxman  
Jenny Wiener,  
Mosaic Entertainment  
Yorke Construction Corp.  
Jim Yoshimura &  
Mary Lin Yoshimura

## PARDNERS

Anonymous  
Alan Arffa &  
Kay Matschullat  
Lucie Amaz &  
Lawrence Luckenbill  
Lisa Belzberg &  
Matthew Bronfman  
Barry & Myrna Bernard  
Eleanor & George Bissenger  
Laura Blanco  
Cristina Botta &  
Jamie Singleton  
Bertha & Samuel Britt  
Kate Burton &  
Michael Ritchie  
Camilla Campbell &  
Oliver Platt  
Tom Carozza  
Rosanne Cash &  
Joe Leventhal  
Stockard Channing  
Ellen Chenoweth  
Kathleen Clark &  
Richard Frankel  
Ruth Cohen  
Catherine Colpenny &  
Max D. Mayer  
Joan Straus Cullman  
Willem DaFoe &  
Liz LeCompte  
Donna & William DeSeta  
Kristine Fleisher &  
David Sneddon

Naomi Freundlich &  
Charles Miles  
Lois Fricke &  
Todd Hollander  
Martha Friedrichs &  
Mike Glass  
Victor Garber  
Emily Grishman &  
Susan Sampliner  
Andrew & Marian Heiskell  
Jane Hoffman  
Ronwyn Ingraham  
Dana Ivey  
Hope G. Jessup  
M. Lynne Johnson  
Neil R. Johnson  
Larry Jones & Mary McElrath-Jones  
Eric Karpeles & Mike Sell  
Beth & Seth A. Klarman  
Alan Klingenstein &  
Kathryn Klingenstein  
Belle & Roger Kuhn  
Kate Lear  
Jerry & Carol Levin  
Loeb & Loeb LLP  
Katherine Lumb &  
Joseph Vitale  
John Lyons  
Roma Maffia  
Donald Margulies &  
Lynn Street  
George W. Mayer, Jr.  
Neil Mazzella

Gene McCoy  
Audrey & Danny Meyer  
Jane Muddyman-Heine  
Fred Nelson &  
Elizabeth Warner  
Maria Norman  
Steve Olsen  
Kevin O'Rourke &  
Edith Thurber  
Tim Patrick &  
Abigail Solomon  
The Laura Pels Foundation  
Arthur Penn  
Tom & Shevi Peters  
Elise Pettus  
Ana Rosa &  
Peter J. Phillips  
Ethan Phillips  
Donna Plumber &  
Todd Richter  
Richard Platckek  
Michael Post &

Fred Van Natta  
Christopher Randolph  
Maggie Renzi &  
John Sayles  
David Rosenberg  
Daniel & Janice Rous  
Steve Sabba, Megatrax  
Campbell Scott  
Stefan M. Seig  
Slane & Slane  
Emily Skinner &  
Robert Wiener  
Judith Tygard &  
Mitch Weitzner  
Wendy vanden Heuvel  
Susan J. Vitucci  
Elizabeth Williams & Joseph  
Forte  
Gary Winick  
Bill Wrubel

## COWPOKES

Mark E. Ahern  
May Ameen  
Cecilia Arana-Grant  
Larry Aronson &  
Lynne Thigpen  
June Ballinger &  
Michael Goldstein  
Stephanie Barber & Arthur Collins  
Ben Barenholtz  
Ed & Frances Barlow  
Lisa Benavides &  
Tim Nelson  
Pamela S. Berlin & William  
Carden  
Olivia Birkelund  
Susan Black  
Joel Bluestein  
Janet & John Bock  
Jane Bolster &  
Steve Wertimer  
Katherine Borowitz & John  
Turturro  
Julie Boyd  
Becky Browder &  
Ted Neustadt  
Chris Bundy &  
Meg Grosswendt  
Denise Burse &  
Peter Jay Fernandez  
Steven Callahan & Christine Dunn  
Colleen Carroll &  
Mitch Semel  
John Cavallo &  
Lucy Kaplan  
Carol Cate  
Rachel Chanoff  
Larry Chertoff &  
Rose Gasner  
Glenda Chesshir  
Marissa Chibas  
Richard Cohn  
Eve Colson & Nelson Obis  
David Copeland &  
Bilha Fish  
Thomas Cott  
Margaret M. Crimmins & Pierce  
Rafferty  
Thomas Deierlein  
Marlaina Deppe & Richard Hadar

Edward DiRugeri  
Joanna Dretzin  
Julie Dretzin  
Susan Drury  
Jack & June Dunbar  
Christopher &  
Karen Eddowes  
Mario Eggozi  
Ned Eisenberg &  
Anna Li  
Beth A. Emelson  
Sarah Fargo  
Eugene & Janet Fierman  
Lisa Finstrom &  
Tim Sanford  
Ron Fiorina  
Alexa L. Fogel  
Tom Fontana  
Peter Freundlich &  
Mary Lou Teel  
Judith Garson &  
Stephen Rappaport  
Celia Gershenson  
Simma Gershenson  
Jenny Cahan Gersten  
Jilian Cahan Gersten  
Nancy Giles  
Paula Goldstein &  
Brian Smith  
Janet L. Grillo &  
David Russell  
Lisa J. Gugenheim  
Albert R. Gurney  
Jack Gwaltney  
Barnaby Harris  
Peter Herdrich &  
Karen Trott  
John Herron, Jr.  
Willy Holtzman &  
Sylvia Shepard  
Abigail Hornik  
Jeffrey Horowitz  
Ken Howe  
Barnard Hughes &  
Helen Stenberg  
Bette & Richard Hyman  
Bill Irwin & Martha Roth  
Peter Jacobson &  
Whitney Scott

Tom Jaycox & Susan Levit  
Jay Jolly  
Marcella & Max Kahn  
Lee Kalcheim &  
Julia Lord  
Michael Karzis  
Mark Keoppen &  
Wendy Townsend  
Rusty King  
Marsha Kirkley &  
David Rockwell  
Mary Kong  
Jan Kroeze & Jacki Ochs  
David Kuhn  
Elaine & Howard Langbaum  
Jill Larson  
Darrell Larson &  
Susanna Styron  
Mickey Lemle  
Liza Lerner  
Bernard & Carolyn Lippert  
John Lloyd &  
Anne Twomey  
Andrew Louca  
Paul MacIassac &  
Ricki Roer  
Sarah Malin  
Mary Bridg McCarthy  
Barbara McCrane &  
Paul Reale  
Anne Meara &  
Jerry Stiller  
Chia Messina  
Andy Millon  
Patricia M. Murphy, Esq. & Adam  
Spilka  
Curt & Leslie Myers  
Kate Nelligan &  
Robert Reale  
James A. Neuberger & Helen  
Stamler  
Peter Neufeld  
Jim Neuwirth  
Bruce Norris

Steven O'Neill &  
Mary Anne Rubacky  
Susan Ochs Phillips  
Nicholas Platt &  
Robyn Watt  
Corliss Preston  
Jeremy Posner  
Dean & Leslie Potashner  
Roseanne Quezada  
Jacquelyn Reingold  
Jill Robbins  
Kristen Roche  
Minna Rose  
Donald Rothschild & Lottchen  
Shivers  
John Gould Rubin  
Richard Rubinstein  
Laura Sametz  
Jane M. Sangerman  
Karin & Tom Schall  
Adrienne Shelly  
Alan & Joan Shore  
Meg Simon  
Ken Smith &  
Cyd Tomack  
Lois Smith  
Sound One  
James Stovall  
Judy & Stephen Sultán  
Daniel Swee  
Anne Swift  
Mariko Tada  
Alison Tatlock  
Juliet Taylor &  
James Walsh  
Mary Pat Walsh  
Borah & Mildred Walton  
Barbara & Max Willk  
Susan Willerman

## PRODUCTION STAFF

### FOAMCORE DESIGN TEAM

Annika Ahlstrom, George Babiak, Dana Bledsoe,  
Dan Carlson, Marissa Copeland, Alison Eisendrath,  
Joe Franchere, Esther Geller, Kilty Gilmour,  
Henry Hagerty, Jenny Pollack, Don Puglisi,  
Chandra Ratner,

### VOLUNTEERS

Taro Alexander, Tom Carozza, Jilly Crook, Julie Dretzin, Liz Flahive,  
Jenny Mannis, Eris Migliorini,  
Jane Muddyman Heine, Christopher Randolph,  
Kate Ryan, Liz Tuocillo,  
Jason Valk, Henry Wishcamper

### THE 52ND STREET PROJECT STAFF

Willie Reale, Artistic Director  
Carol Ochs, Executive Director  
Michael Bernard, Associate Artistic Director  
Sally Bock, Director of Development  
George Babiak, Production Manager  
Julie Feldman, Director of Education

### SPECIAL THANKS

Taro Alexander, Julie Dretzin, Beth Emelson,  
Barbara McCrane, Vanessa Valdes



The 52nd Street Project gratefully acknowledges the support of the following foundations and corporations: American Movie Classics, Anonymous, Baker-Witkop Foundation, BEA Associates, Beresmann's World of Expression Foundation, Brillstein-Grey Motion Pictures, Chase Manhattan Bank, Golgate Patrols, Consolidated Edison, Creative Artists Agency, Cubic Dlx, Dramatist's Guild Fund, Dramatist's Play Service, Jean and Louis Dreyfus Foundation, Educational Foundation of America, EPIC, Farway Market, Fan Fox & Leslie R. Searles Foundation, GLADPZ, Horace W. Goldsmith Foundation, Hambricht & Quist, Hennessy Foundation, Holland Lodge Foundation, In-Style Magazine, Rita J. & Stanley H. Kaplan Foundation, Lloyd's Bank, MCJ Foundation, James A. Macdonald Foundation, Ann M. Martin Foundation, J. P. Morgan Charitable Trust, Morgan Stanley Foundation, William Morris Agency Inc., Newman's Own, New World Foundation, The New York Times Co. Foundation, Northwest Point, O'Grady Family Foundation, Laura Pels Foundation, Polygram Filmed Entertainment, Sauce Entertainment, Scherman Foundation, Seth Sprague Educational Charitable Foundation, Staging & Design, Inc., Jules & Doris Stein Foundation, Harold & Mimi Steinberg Charitable Trust, Suttzberger Foundation, Sundance Channel L.L.C., Surlina Foundation, Susannahs, Technicolor Film Services, Travelers Foundation, United Talent Agency, Inc., Uta-Acheson Wallace Funds, Wiener Family Foundation, Wind Dancer Production Group, Yonke Construction. In addition, the following individuals made gifts of over \$150 to The 52nd Street Project this year (list current as of 7/13/98):

Jace Alexander	Arthur Dantschik	Lee Kalcheim & Julie Lord	Peter and Ana Rosa Phillips
Daniel Alprant & Elise Petrus	Peter & Judith Dawkins	Eric Karpelas & Mike Sell	Robert and Sue Phillips
May Ameen	Thomas Develain	Ronald Kacmar	Nicholas Platt
Cecilia Azana-Grant	Donna & William DeSeta	Mark Kaepfen & Wendy Townsend	Richard Polachek
Lucie Amaz and Laurence Luckinbill	Jim Dicke	Rusty King	Jeremy Posner
Larry Aronson & Lynne Thigpen	Edward A. DiRugiero	Richard Kriehbaum	Michael Post & Fred Van Natta
Alan Arfa & Kay Matichuk	Darcy Dunn & Mark Singer	Seth & Beth Klarman	Mr. and Mrs. Dean E. Potashner
Jane Ballinger & Michael Goldstein	Christopher & Karen Eddowes	Alan and Kathryn Klingstein	Christopher Randolph
Jeremy Barber	Mario Fogel	Mary Kong	Peter & Helen Randolph
Stephanie Barber and Arthur Collins	Neal Eisenberg & Anna Li	Jan Krieger & Jacki Ochs	Dennis Rich
John Barba	Jacquelyn Effert	David Kuhn	Tood Richter
Ben Basenholtz	Bert Etzbach & Janet Reich	Judy Kuhn & David Schweb	Harald Ritch
Jessica Bauman	Tim Emerson & Jan Sidabotham	Roger & Belle Kuhn	JE Robbins
Laure Becker & Rick Swann	Barbara Etlinger	Elaine & Howard Langbaum	Rocki Roer
Lisa Belberg	Heidi Etlinger	Carol Langstaff	Jacques Rose & Carol Ue
Lisa Benavides & Tim Nelson	Wendy Etlinger & Derek McLane	Daniel Larson & Susanna Styron	David Rosenberg
Janie L. Bennett	David and Joan Fahr	JE Larson	Betsy & Clifford Ross
Pamela Berlin & William Garden	Christina Fleisher & David Sneddon	Kate Lear & Jonathan LaPook	Donald Rothschild & Lotchen Shivers
Barry & Myrna Bernard	Dr. Eugene J. Flerman	Mickey Lurie	Daniel & Janice Rous
Eleanor and Gerard Besinger	Ronald C. Florida	Dell Lemmon	John Gould Rubin
Susan Black	Katherine C. Foster	Robert Sean Leonard	James Ruszak
Laura Bianco	David Frankel	Carol and Jerry Levin	Lawrence A. Russo
Robt & Ruth Blumenstein	Naomi Freundlich & Charles Mink	John Bedford Lloyd & Anne Twomey	Steve Sabba
Dr. and Mrs. John Bock	Peter Freundlich & Mary Lou Teel	Marjorie Loggia	Tim Sanford and Lisa Fridson
Jane Bolivar & Steve Welfimer	Lois Fricks and Todd Hollander	Andrew Louca	John Sayles & Maggie Ranz
Cristina Botta Singleton & James Singleton	Louis & Patrice Friedman	Katherine Lumb & Joe Vitale	Karin & Tom Schall
Julie Boyd	MacElla K. Glass and Martha Friedrich	John Lyons	Leslie Schine and Nils Nilsen
Bertha & Samuel Britt	Victor Garber	Peter & Maruse Machiosi	Stephen A. Schwarzman
Catherine Brophy	Judith Garton & Steven Rappaport	Greg MacPherson & Jane Perlmutter	Campbell Scott
Becky Browder & Ted Neustadt	Peter Fritschel & Pamela Nelson	Bruce MacVick & Carol Ochs	Shelbi Selig
Henry BuN	Joseph Gardak & Margaret Norden	Roma Malia	Bernice Shael
Chris Bundy and Meg Groszwend	Alexandra Gersten & John Viskaros	George Mayer, Jr.	Adrienne Shelly
Denise Buns & Peter Jay Fernandez	Jenny Gersten & Willie Roale	Max Mayer	Allen and Joan Shore
Kate Burton & Michael Ritchie	Jilan Gersten	Neil Mazzella	Brian Oberill & Patty Dryden
Cora Cahlan & Bernard Gersten	Nancy Giles	Gene and Mary Ann McCoy	Heath and Landon Stone
Steve Callahan & Christine Dunn	Stephen & Cathy Graham	Barbara McCrane & Paul Raabe	Ken Smith and Cyd Tomack
Camilla Campbell & Oliver Platt	Michael Graf	Hannalore & James McDaniel	Abigail Solomon
Colleen Carroll & Mitchell Semei	Emily Grishman & Susan Sampiner	Brian Martes	Jeff Stafford
Tom Carozza	Lisa J. Gugenheim	Audrey & Danny Meyer	Fisher Stevens
Rosaline Cash & John Laverthal	Mindy and Nicholas Cazzone	Linda Michaels	Cynthia Stevens
Richard & Lisa Cashin	Richard Hader and Marlene Deppe	Andy Milon	Daniel Swee
Phoebe Gates & Kevin Kline	David and Diane Hart	Lawrence Motola	Marko Tadz
Henry and Kathy Chahant	Susan Bruce and Peter Hedges	Patricia Murphy & Adam Spika	Morisa Tomei
Stockard Channing	Jane and Jonathan Heine	Curt & Leslie Myers	Judith Tygard & Mitch Weizner
Rachel Charoff	Peter Herdrich & Karen Trutt	Kate Nelligan & Rob Reale	Adam and Andrea Usdan
Elen Chenoweth	Dr. David Hidalgo	Fred Nelson	Laura Villoroso & David Seidman
Larry Chertoff & Rose Gaaner	Jane Hoffman	Randy & Rona Nelson	Wendy vander Heuvel
Genda Chesler	Willy Holtzman & Sylvia Shepard	Ruth Nelson	Susan Visczi
Marissa Chibas & Travis Preston	Barbara Howard	James A. Neubergler & Helen Stambler	Mary Pat Walsh
Ethan Coen & Trish Cooke	Mr. and Mrs. Richard Hyman	Peter Nauloff	Borah & Mildred Watson
John Coen & Frances McDonnand	Romeyn Ingraham	Ranee F. Newark	Anita Waxman
Ruth Cohen	Bil Irwin & Martha Roth	Jim Newirth	Lenny & Sally Weiss
Richard J. Cohn	Dana Ivey	Paul Newman & Joanne Woodward	Gregory Welch
Mr. and Mrs. Frank Collins	Sy Jacobs	Mr. and Mrs. C. J. Nolan	Michael & Zena Wener
Karen Cooper	Joanne Jacobson	Marie Norman	Robert Wiener
David Copeland	Peter Jacobson & Whitney Scott	Elen Novack	Max and Barbara Wilk
Thomas Cott	Daniel Jenkins & Kathy Hiler	Kevin O'Rourke & Edith Thurber	Elizabeth Williams & Joseph Forte
Margaret Ctrimmons & Pierce Rufferty	Hape Jersup	Steve Olan	Matt Williams
Stephen Cudgigian	M. Lynne Johnson	John Paris	Stephen M. Wilson
Joan Strauss Cullman	Ned R. Johnson	Arthur and Peggy Penn	Donald Windham
William Dabbe	Larry & Mary Jones	Shel and Tom Peters	Bil Wrubel
	Betsy and George Kaiser	Ehan Phillips	Janine & Jeffrey Yaco
			James & Mary Lin Yoshimura



The 52nd Street Project Presents  
The Harold and Mimi Steinberg  
Charitable Trust  
One-on-Ones



# ONE SLIGHT HITCH

THE CAVEAT\* PLAYS

THE BLOCK ISLAND SERIES  
THE ENSEMBLE STUDIO THEATRE,  
NEW YORK CITY

THURS., JULY 30th AT 7:30 P.M.  
FRI., JULY 31st AT 7:30 P.M.  
SAT., AUG. 1st AT 3:00 AND 7:30 P.M.  
SUN., AUG. 2nd AT 3:00 P.M.

\*caveat (kă ve-ät) noun (Latin, "let him beware") - A warning or caution.

# ONE SLIGHT HITCH

## THE CAVEAT PLAYS

July 30 - August 2, The Ensemble Studio Theatre, N.Y.C.

### Project Staff

Willie Reale, Artistic Director  
Carol Ochs, Executive Director  
Michael Bernard, Associate Artistic Director  
John Sheehy, Director of Development and Marketing  
George Roman Babiak, Production Manager  
Julie Feldman, Director of Education  
Iris A. Brown, Graphic Designer  
Perry McBain Daniel, Lucas Fleischer,  
Mona Lipson, Nicole Watson - Interns

### Production Staff

Patrick Barnes, Composer  
Kevin Joseph Roach, Set Designer  
Greg MacPherson, Lighting Designer  
Crystal Thompson, Costume Designer  
Vanessa Valdes, Sound Designer  
Judy Tucker, Stage Manager  
Slide Design Chief: Katherine Lumb  
Slide Design Team:  
Renato Castilho, Adam Rodriguez,  
John Steward, Alberta Testanero  
Prop Construction Team:  
Ty Baldwin, Dan Carlson, Jane Conboy,  
Alison Eisendrath, Lucas Fleischer,  
Joe Franchere, Ray Harold,  
Stacey Linden, Mona Lipson,  
Andrea Nerins, Kate Ryan,  
Nicole Watson  
Colorform Designers:  
Sarah Hokanson, Katie Dominguez,  
Joy Kilpatrick, J.P. Plumez  
One Slight Hitch Illustration: Mike Sell  
Slide Operator: Ray Harold

### Furniture Crew:

Lucas Fleischer, Cullen Wheeler,  
Noel Polanco

### Prop Crew:

Perry McBain Daniel, Dan Carlson,  
Luis Anthony Maldonado

### Colorformists:

Mona Lipson, Annette Myrie

### Load-in and Light Hang Crew:

Perry McBain Daniel,  
Lucas Fleischer, Tim Gallagher,  
Mona Lipson, Kirt Markle,  
Jordan Matter, Leslie Nipkow,  
Charlton Ruddock, Chris Ryan,  
Tom Schall, Judy Tucker,  
Nicole Watson

### House Managers:

Noel Dawkins, Karin Schall

### Week-away Chefs:

Martha Velie-Gass, Pat McQuade

### Teen Counselors:

Jed "Cobra" Clarke, Annette Myrie

PROGRAM LAYOUT: GEORGE BABIAK

The 52nd Street Project is a non-profit organization that brings inner-city children from the Clinton neighborhood together with professional theater artists to create theater. **ONE SLIGHT HITCH** is a production of our One-on-One program, which is designed to give children the opportunity to go away for one-week stays in the country and enjoy the undivided attention of a professional theater artist who serves as friend, mentor, and collaborator.

### The 52nd Street Project Board of Directors

Ben Barenholtz	Louis P. Friedman	Carol Ochs
Lisa Benavides	Stephen Graham	Willie Reale
Rachel Chanoff	Larry Jones	Jose Soto, Jr.
Ruth Cohen	James McDaniel	Pamala Tyson
Heidi Ettinger	Frances McDormand, <i>chairperson</i>	Laura Valeroso
Wendy Ettinger, <i>chair emeritus</i>	Patricia M. Murphy, Esq.	Wendy vanden Heuvel Elizabeth Williams

### Special Thanks To:

Lyn Reale, Shayna, Kate, Ruth & everyone at BI Realty; Amanda Gass; Bob Reale; Jimmy Reale; Interstate Navigation; Annie Reale; Bruce MacVittie; Bill Bendokis & New England Air; Kathy & Keith Suehnholz; Debbie Howarth & Finns; Cindy & Stan Greer of BI Depot; 1661 Inn. Thanks to our hosts; Christina Biaggi & Pat Walsh, Joya Verde & Virginia Dare, Nicole & Brooke Frye; Jennifer & Elliot Taubman, Rita & Steve Draper, Ron, Judy & Kevin Tierney, Martha Gass & Pat McQuade; Shirlene Govern & the Wohl's. Extra-Special thanks to our amazing chefs Martha & Pat.

### In-Kind Contributions:

Curt, Jamie, Christine, and all the staff at Ensemble Studio Theatre; Signature Theater, Primary Stages; Playwright's Horizons; Colorforms; Neil A. Mazzella & Hudson Scenic Studios, Inc.; Shays & Murphy; Iris A. Brown & Bernhardt/Fudyma Design Group; Ron Kastner, Capital Printing; Masque Sound; New Dramatists; Steve Olsen & The West Bank Cafe; Materials for the Arts; Port Authority; Mayor's Office of Film & Television; John A. Vassilaros & Son; Paris Chocolates; Scholastic Productions; Coleman, Inc.; Watkins Products; Eric Karpeles & Mike Sell; Bill Muddyman and the Chateau de Berne; Boylan's Bottling Company, BMG, John Steward, Paul Saylor and The Commonwealth Brewing Company, David Sneddon and Fairway Market, and Andy Millon.



The One-on-One Program is made possible with public funds from the National Endowment for the Arts, New York State Council on the Arts, a state agency, the Department of Youth and Community Development, the New York City Department of Cultural Affairs, and the office of the President of the Borough of Manhattan.



**Don't miss our upcoming shows!**

# ONE SLIGHT HITCH II

THE CAVEAT PLAYS

The Tyler Hill Batch  
of the 1998 One-On-Ones

August 27-30th, right here at  
The Ensemble Studio Theater  
Same great theme, but with  
new kids and new adults,

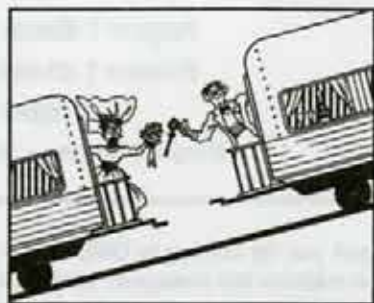

## Playback

November, '98



First, a kid writes a short play. Then, an adult writes an "answer" play. Then, the two of them perform both plays!

## Playmaking

December, '98



In September, 10 kids brand-new to the Project will begin a Playmaking class with Michael Bernard. Come and see their final plays performed by adult professional actors.

## One Slight Hitch: ACT I

All music composed by Patrick Barnes

### What An Angel

by Gus Rogerson for Peter Granados, age 10

Directed by Gus Rogerson

Gabriel ..... Gus Rogerson  
Cupid ..... Peter Granados  
Lucifer ..... Jed "Cobra" Clarke

"Guardian Angels' Pep Song," "Gabriel's Two Cents" and "Cupid's Plea"  
lyrics by Gus Rogerson

### The Penguins' Tale (or "Go Fish")

by Donald Rothschild for Mona Lisa Barthelemy, age 11

Directed by Allison Eikerenkoetter

Chatter ..... Mona Lisa Barthelemy  
Shiver ..... Allison Eikerenkoetter

"Formality" and "Goin' Kazh" lyrics by Donald Rothschild

### Alone At Last

by Jacquelyn Reingold for Christina Ramirez, age 10

Directed by Jacquelyn Reingold and Ali Marsh

Princess Gwen ..... Christina Ramirez  
Merlina ..... Ali Marsh  
Queen ..... Annette Myrie  
King ..... Jed "Cobra" Clarke  
Prince ..... John Sheehy

"Alone at Last" and "Together Again" lyrics by Willie Reale

### Present Lives

by Willie Reale for Lorraine Zambrano, age 13

Directed by Willie Reale

Perka ..... Anne Torsiglieri  
Zerka ..... Lorraine Zambrano

"A Little Paddlin' Music" and "Things We Kind of Knew" lyrics by Willie Reale

### Phil

by Michael Bernard for Isaac Trujillo, age 11

Directed by Michael Bernard

Steve ..... Michael Bernard  
Phil ..... Isaac Trujillo  
Woman ..... Annette Myrie

"The Poets' Lament" and "The Song of Phil" lyrics by Michael Bernard

**INTERMISSION**

## ACT 2

### Beasley

by Tim Nelson for Jayme Rosado, age 11

Directed by Jose Soto

Billy Ray ..... Jose Soto  
Claxy ..... Jayme Rosado  
Beasley ..... Jed "Cobra" Clarke  
Kazoo Chorus ..... Jed "Cobra" Clarke, Perry McBain Daniel,  
Luis Anthony Maldonado, & Annette Myrie

*"Best Darn Feller in the Whole of My Life"* lyrics by Tim Nelson

### Little Poland

by Cindy Caponera for Vionel Ortiz, age 13

Directed by Wendy vanden Huevel

Sashi ..... Wendy vanden Heuvel  
Gloria ..... Vionel Ortiz

*"Gloria's Fabrication"* and *"Polish Restaurant Work Song"*  
lyrics by Willie Reale

### Remoral Dilemma

by George Babiak for Michael Feliciano, age 10

Directed by George Babiak

Timmy ..... Michael Feliciano  
Nigel ..... George Babiak  
Snorkeler ..... Jed "Cobra" Clarke

*"It's Cool to be a Carnivore"* lyrics by George Babiak

### The Great Explorer

by Russell Lees for Candy Godoy, age 13

Directed by Tanya Gingerich

Captain ..... Candy Godoy  
First Mate ..... Tanya Gingerich

*"The Great Explorer"* lyrics by Russell Lees

### Condimentally Yours

by Willie Reale for Chanel Christiansen, age 11

Directed by Willie Reale

Sally ..... Cecilia Arana  
Jill ..... Chanel Christiansen

*"Some Zippy Exposition"* and *"Tiny Things and Pride"* lyrics by Willie Reale

## Cool Stuff ON SALE IN THE LOBBY

The Fabulous Flyer Bar (in five flavors)

\$2.00 and \$1.50 (\$1.00 for kids)

And featuring Shel Silverstein's "Fivey and Twoey" logo:

Project T-Shirts (Short sleeve) — \$12.00

Project T-Shirts (Long sleeve) — \$15.00

Project Caps — \$15.00

Project Mugs — \$5.00 (there aren't many left!)

Thank you for coming to ONE SLIGHT HITCH. If you are not on our mailing list (or if your address has changed), please fill out this form and give it to us on your way out or mail it to the address below. We would also like to know if you are interested in becoming a volunteer. We need help in *all areas*, so please fill out your name and phone number, and we'll call you.

### PLEASE ADD ME TO YOUR MAILING LIST:

NAME \_\_\_\_\_

ADDRESS \_\_\_\_\_

ZIP \_\_\_\_\_

HOME PHONE \_\_\_\_\_

DAYTIME PHONE \_\_\_\_\_

### YES, I WOULD LIKE TO BE OF HELP. I CAN:

- |   |   |  |
|---|---|--|
| <input type="checkbox"/> Help load in and out for shows | <input type="checkbox"/> Draw and/or paint  | <input type="checkbox"/> Help kids with homework |
| <input type="checkbox"/> Hang lights                    | <input type="checkbox"/> Help with mailings | <input type="checkbox"/> Teach kids a skill      |
| <input type="checkbox"/> Work on a backstage crew       | <input type="checkbox"/> Do office work     | <input type="checkbox"/> Be a chef at an event   |
| <input type="checkbox"/> Other (please specify) _____   |   |  |

### MY SCHEDULE IS:

- Very flexible. I'm often available during weekdays.
- Somewhat flexible. I can help on the occasional morning or afternoon during the week.
- Not very flexible at all, but I've got some free time on evenings and weekends.

If you would like to mail this (and you're always welcome to enclose a tax-deductible contribution), you can send it to: The 52nd Street Project, 500 West 52nd St. New York, NY 10019. Or fax it to (212) 333-5598.



The 52nd Street Project gratefully acknowledges the support of the following foundations and corporations: American Movie Classics, Anonymous, Arthur W. Hays Sulzberger Foundation, B&W Associates, Berlesem's World of Expression Foundation, Billstein-Grey Motion Pictures, Chase Manhattan Bank, Cogeco Pantheon, Consultant Edition, Creative Artists Agency, Cuddy Inc., DePaul's Guild Fund, Dramatic Play Services, Jean and Louis Dreyfus Foundation, Educational Foundation of America, EPC, Fairway Market, Fin For & Leslie R., Garsman Foundation, GLADFC, Harold W. Gokoski Foundation, Harwood & Quist, Himmelfarb Foundation, Holland Lodge Foundation, In-Style Magazine, Rita J. & Stanley H. Kaplan Foundation, Lloyd's Bank, MGI Foundation, James A. Macdonald Foundation, Art M. Martin Foundation, J. P. Morgan Charitable Trust, Morgan Stanley Foundation, William Morris Agency Inc., Newman's Own, New York Foundation, The New York Times Co. Foundation, Northwest Philat., O'Grady Family Foundation, Laura Pell Foundation, Polygram Filmed Entertainment, Sausa Entertainment, Scherman Foundation, Seth Sprague Educational Charitable Foundation, Staging & Design, Inc., Jules & Doris Stein Foundation, Harold & Miriam Steinberg Charitable Trust, Sulzberger Foundation, Sundance Channel L.L.C., Suntra Foundation, Susannah Technicolor Film Services, Traverser Foundation, United Talent Agency, Inc., Lisa Acherson Wallace Funds, Warner Family Foundation, West Denver Production Group, York Construction. In addition, the following individuals made gifts of over \$150 to The 52nd Street Project this year (list sorted as of 7/15/98):

Jake Alexander	Arthur Dworkin	Lee Kufshem & Julia Lord	Peter and Ann Rosa Phillips
Daniel Agresti & Elise Peltus	Peter & Judith Dawkins	Eric Kaprielian & Mike Sall	Robert and Sue Phlips
May Aronson	Thomas DeLorain	Ronald Kastner	Nicholas Platt
Caroline Aronson-Grant	Dennis & William DeGisi	Mark Kacoper & Wendy Townsend	Richard Prosschke
Loren Aronson & Lawrence Luckertall	Jim Dickie	Rusty King	Jeremy Posner
Larry Aronson & Lynne Triggiani	Edward A. DiNapoli	Richard Kohnenbaum	Michael Post & Fred Van Matta
Alan Ayala & Kay Matzchulski	Darcy Dunn & Mark Singer	Seh & Beth Korman	Mr. and Mrs. Dean S. Pottshamer
Jane Ballinger & Michael Galsobin	Christopher & Karen Edlowen	Alan and Kathryn Klingenstein	Christopher Randolph
Jennifer Barber	Mario Egoli	Mary Kong	Peter & Helen Ransdign
Stephanie Barber & Arthur Collins	Neil Eisenberg & Anna Li	Jai Kovacs & Jacki O'Lea	Dennis Rich
John Barbo	Jacquelyn Elbert	David Kuhn	Todd Ritter
Ben Bernhardt	Sam Fishbach & Janet Reich	July Kuhn & David Schwab	Harold Riton
Jocelyn Bauman	Tim Emerson & Jan Sakelofham	Roger & Belle Kuhn	Jill Roberts
Laura Becker & Robi Samuels	Barbara Edinger	Eileen & Howard Langhoun	Nick Rose
Lisa Belling	Neil Edinger	Carol Langstaff	Jacques Rose & Carol Oh
Lisa Berkman & Tim Nelson	Wendy Edinger & Derek McLane	Daniel Larson & Susanna Shyon	David Rosenberg
Jamie L. Bennett	David & Joan Feltz	Jill Larson	Betty & Clifford Ross
Penelope Berlin & William Garden	Christina Fleisher & David Sussdorf	Kate Lear & Jonathan LaFook	David Rothchild & Lettcher Shover
Bery & Myrna Bernard	Dr. Eugene J. Fleiman	McBry Larkin	Daniel & Janine Rous
Elleanor & Gerard Biazinger	Ronald C. Finkels	Dell Lamson	John Gould Rubin
Susan Black	Katherine C. Finkin	Rafael Sean Leonard	James Russek
Laura Blanton	David Frankel	Carol and Jerry Levin	Laura Ann Russo
Rita & Ruth Blumenschein	Nancy Freundlich & Charles Mike	John Bedford Lloyd & Anne Teomoy	Steve Seltzer
Dr. & Mrs. John Buck	Peter Freundlich & Mary Lou Teel	Maggie Loppa	Tim Seibert & Lisa Frazzoni
Jane Butler & Steve Westner	Lin Ficks & Todd Holander	Andrew Louca	John Taylor & Maggie Rossi
Christina Datta Singaman & James Singaman	Louis & Patricia Friedman	Katherine Lamb & Joe Vele	Karin & Tom Schul
John Dord	Maxwell K. Glass and Martha Friedman	John Lyons	Leslie Sobers and Nils Nezer
Bertha & Samuel Dini	Walter Galtus	Peter & Marlene MacFool	Stephen A. Schwarzman
Catherine Dinich	Julith Gerson & Steven Happerort	Greg MacPherson & Jane Polmutter	Cynthia Scott
Bobby Dinevari & Ted Neisblatt	Peter Finkelstein & Pamela Nelson	Bruce MacVittie & Carol Ochs	Dafan Selig
Henry Dini	Joseph Daniels & Margaret Nonket	Rena Maffia	Bernice Shiel
Chris Dundy & Meg Grosswendt	Alexandra Gersten & John Vasiliadis	George Mayer, Jr.	Adrienne Shely
Dennis Deane & Peter Jay Fernandez	Jerry Gersten & Mike Raabe	Max Mayer	Alan and Joan Shore
Kate Decker & Michael Ditchik	John Gersten	Neil Mazzella	Brian Stewart & Patsy Dryden
Coni DeGisi & Bernard Gersten	Nancy Giles	Gene and Mary Ann McCoy	Heath and Landon Stone
Steve DeGisi & Christine Dunn	Stephen & Cathy Graham	Balissa McCrae & Paul Reese	Ken South and Cyl Bernack
Camilla Campbell & Oliver Pratt	Michael Givai	Harvick & James McDaniel	Algal Sotomayor
Calvin Carroll & Mitchell David	Billy Glatstein & Susan Sampson	Brian Merba	Jeff Stafford
Tom Carozza	Lisa J. Guggenheim	Auney & Danny Meyer	Flora Stevens
Rustanew Cash & John Leventhal	Mindy and Nicholas Gutzron	Lisa Michaels	Cynthia Stevens
Richard & Lisa Castle	Richard Hader and Barbara Deppo	Andy Milton	Daniel Stone
Phyllis Cates & Kevin Kika	David and Diane Hart	Lawrence Moore	Marko Tade
Henry & Kathy Chabert	Gustav Bruce and Peter Hodges	Patricia Murphy & Adam Spika	Marisa Tanski
Stewart Channing	Jane and Jonathan Haskin	Carl & Leslie Myers	Julie Tygod & Mitch Weizner
Rachel Chanoff	Peter Hardick & Karen Tiedt	Kate Nelligan & Rob Rouse	Adam and Andrea Linder
Eli Chancoweth	Dr. David Halpern	Fred Nelson	Laura Velasco & David Seibman
Lary Charoff & Rose Glaser	Jane Hoffman	Randy & Rose Nelson	Wendy van den Heuvel
Glenda Chevala	Wly Haffman & Sylvia Shepard	Ruth Nelson	Susan Vicari
Marissa Chiles & Tere Preston	Barbara Howard	James A., Neuburger & Helen Zandier	Mary Pat Walsh
Ethan Coen & Trish Cooke	Mr. and Mrs. Richard Hyman	Peter Neuhoff	Brian & Michael Weber
Joel Coen & Frances McDonnater	Rosewyn Ingraham	Ranee F. Newark	Anita Whisman
Ruth Cohen	Bill Davis & Martha Roth	Jill Newark	Lenny & Sally Weiss
Richard J. Cohn	Dana Key	Paul Newman & Juanna Woodward	Gregory Welch
Mr. & Mrs. Frank Collins	Sy Jacobs	Mr. and Mrs. C. J. Nolan	Michael & Zena Wilner
Karen Cooper	Jeanne Jacobson	Maria Norman	Robert Wilson
David Copeland	Peter Jacobson & Whitney Smith	Ellen Novack	Max and Barbara Will
Thomas Cott	Daniel Jenkins & Kathy Hiler	Kevin O'Rourke & Faith Thauber	Elizabeth Wilens & Joseph Fide
Margaret Simmons & Pierce Rafferty	Helen Jessup	Steve Olson	Matt Williams
Stephanie Coadginton	M. Lynne Johnson	John Park	Stephen M. Wilson
Joan Stevas Galtman	Ned R. Johnson	Arthur and Peggy Penn	Donald Whitman
William Delle	Larry & Mary Jones	Shari and Tom Peters	Ed Rhine
	Betty and George Kaiser	Ethan Philips	Janine & Jeffrey Yass
			James & Mary Lin Yosterman



The 52nd Street Project  
presents:  
The 1998 One-on-Ones



ONE SLIGHT HITCH  
THE CAVEAT\* PLAYS

THE TYLER HILL BATCH  
THE ENSEMBLE STUDIO THEATRE,  
NEW YORK CITY

THURS., AUG. 27th AT 7:30 P.M.  
FRI., AUG. 28th AT 7:30 P.M.  
SAT., AUG. 29th AT 7:30 P.M.  
SUN., AUG. 30th AT 3:00 P.M.

\*caveat (kã ve-ãt) noun (Latin, "let him beware") - A warning or caution.

# ONE SLIGHT HITCH

## THE CAVEAT PLAYS

The Tyler Hill Batch: Aug. 27-30, The Ensemble Studio Theatre, N.Y.C.

### Project Staff

Willie Reale, Artistic Director  
Carol Ochs, Executive Director  
Michael Bernard, Associate Artistic Director  
John Sheehy, Director of Development and Marketing  
George Roman Babiak, Production Manager  
Julie Feldman, Director of Education  
Iris A. Brown, Graphic Designer  
Lucas Fleischer and Nicole Watson - Interns  
Ray Ocasio and Vicious Ray Harold - Receptionists

### Production Staff

Patrick Barnes, Composer  
Kevin Joseph Roach, Set Designer  
Lighting Designers:  
Greg MacPherson  
Courtney LeClaire Conway  
Mimi O'Donnell, Costume Designer  
Vanessa Valdes, Sound Designer  
Noël Dawkins, Stage Manager  
Mike Sell, Slide Designer  
Sarah Hokanson, Colorform Designer  
Prop Designers:  
Lucas Fleischer  
George Babiak  
Slide Operator: Vicious Ray Harold  
Furniture Crew:  
Chris Quinn,  
Ray Ocasio,  
Joseph Mohamed

### Prop Crew:

Lucas Fleischer,  
Kimberly Kelly Wilson,  
Osage Lewis

### Colorformists:

Barbara Lempel,  
Nicole Watson,  
Ahmed Attia

### House Managers:

Jilly Crook  
Beth Emelson

### Week-away Chefs:

Eric Karpeles  
Mike Sell

### Teen Counselor:

Ray Ocasio

### One Slight Hitch Illustration:

Mike Sell

PROGRAM LAYOUT: GEORGE BABIAK

The 52nd Street Project is a non-profit organization that brings inner-city children from the Clinton neighborhood together with professional theater artists to create theater. **ONE SLIGHT HITCH** is a production of our One-on-One program, which is designed to give children the opportunity to go away for one-week stays in the country and enjoy the undivided attention of a professional theater artist who serves as friend, mentor, and collaborator.

### The 52nd Street Project Board of Directors

Ben Barenholtz	Louis P. Friedman	Carol Ochs
Lisa Benavides	Stephen Graham	Willie Reale
Rachel Chanoff	Larry Jones	Jose Soto, Jr.
Ruth Cohen	James McDaniel	Pamaia Tyson
Heidi Ettinger	Frances McDormand, <i>chairperson</i>	Laura Valeroso
Wendy Ettinger, <i>chair emeritus</i>	Patricia M. Murphy, Esq.	Wendy vanden Heuvel Elizabeth Williams

### Special Thanks To:

Our host families: Roger and Faun Brinkerhoff; Dan Brinkerhoff, Liz Huntington, Ross and Ruby; Chuck, Andrea, Melanie and Emma Heyn; Sara, Bill, Carl and Sasha Spoerri; Frank and Pat Stoeckle; Linda, Bill and Sean Cobb, Fred Van Natta and Michael Post; Sally and Lenny Weiss; and Myra Winner. Sincere thanks to Wendy Townsend and Mark Keoppen; Martha Sader; the Galilee Fiddlers; David Sneddon, Steve Jenkins and The Fairway Market. Extra-Special thanks to our amazing hosts/chefs Mike Sell and Eric Karpeles (and Knightly & Walter for their extraordinary patience).

### In-Kind Contributions:

Curt, Jamie, Christine, and all the staff at Ensemble Studio Theatre; Signature Theater, Primary Stages; Playwright's Horizons; Colorforms; Neil A. Mazzella & Hudson Scenic Studios, Inc.; Shays & Murphy; Iris A. Brown & Bernhardt/Fudyma Design Group; Ron Kastner, Capital Printing; Masque Sound; New Dramatists; Steve Olsen & The West Bank Cafe; Materials for the Arts; Port Authority; Mayor's Office of Film & Television; John A. Vassilaros & Son; Paris Chocolates; Scholastic Productions; Coleman, Inc.; Watkins Products; Eric Karpeles & Mike Sell; Bill Muddyman and the Chateau de Berne; Boylan's Bottling Company, BMG, John Steward, Paul Saylor and The Commonwealth Brewing Company, David Sneddon and Fairway Market, and Andy Millon.



NATIONAL  
ENDOWMENT  
FOR THE ARTS

The One-on-One Program is made possible with public funds from the National Endowment for the Arts, New York State Council on the Arts, a state agency, the Department of Youth and Community Development, the New York City Department of Cultural Affairs, and the office of the President of the Borough of Manhattan.



NYSCA

**Don't miss our upcoming shows!**

# Playback

**November, '98**



*Playback* is a unique format that tests the literary *and* dramatic powers of our more experienced kids (not to mention our adults). First, a kid writes a short play. Then, an adult writes an "answer" play. Then, the two partners perform both plays back to back.



# Playmaking

**December, '98**

In September, 10 brand-new Project kids will begin a Playmaking class with Michael Bernard. The class culminates with a week-end of writing in the country. Come and see the final plays performed by adult professional actors. A Project favorite!

# The Two-on-Two's

**January, '98**



In the *One-on-One's*, a single kid is paired with a single adult. Now you can see *two* kids perform a play written by an adult and directed by *another* adult.

## One Slight Hitch: ACT I

All music composed by Patrick Barnes

### Roommate Wanted

by Liz Tuccillo for Jaysunn Rosado, age 13. Directed by Wendy vanden Heuvel.

Judith ..... Wendy vanden Heuvel  
 Man of Mystery; Lionel ..... Jaysunn Rosado  
 Pirates, Gangsters, Swordsmen ..... Michael Bernard, Lucas Fleischer, Ray Ocasio  
 Alien ..... Nicole Watson  
 "@ aol.com," "A Closet is a Closet," and "Here's the Hitch" lyrics by Liz Tuccillo

### Singing Out

by Diana Son for Jennifer Jimenez, age 11. Directed by Denise Burse.

Amelia ..... Jennifer Jimenez  
 Lizzie ..... Denise Burse  
 Unicorn ..... John Sheehy  
 Mrs. Leatherbottom ..... Kelly Taffe  
 Andy ..... Osage Lewis  
 "You're the Bear for Me" and "I'm On Your Side" lyrics by Willie Reale

### The Life and Near Mort of Happy Lapin

by Cindy Lou Johnson for Matthew Jellison, age 12. Directed by Michael Potts.

Happy Lapin ..... Matthew Jellison  
 Sly Oak, a snake ..... Michael Potts  
 Maurice ..... Michael Potts  
 "The Happy Lapin Theme Song" and "Now That I Know You By Name" lyrics by Cindy Lou Johnson

### Ticket To Ride

written and directed by Thom Babe for Yazy Troche, age 12.

Tyra ..... Yazy Troche  
 Aiana ..... Jane Bodle  
 The Man ..... Thom Babe  
 "Hawaii" lyrics by Willie Reale

### Liberty 2

by Willy Holtzman for Zaida Natara, age 11. Directed by George Babiak.

Liberty 1 ..... Kelly Taffe  
 Liberty 2 ..... Zaida Natara  
 "Not Miss Liberty" by Willy Holtzman and "The Official Liberty Welcome Song" by Willie Reale

### The Bullfrog and Joe Bob

by David Schwab for Michael Castro, age 14. Directed by Peter Jay Fernandez

Joe Bob ..... Michael Castro  
 A Bullfrog ..... Peter Jay Fernandez  
 Cowboy ..... Ray Ocasio  
 Female Fan ..... Nicole Watson  
 Lady Fans ..... Denise Burse, Wendy vanden Heuvel, Diana Rojas  
 "Rodeo up on the Cloud" lyrics by Willie Reale

**ACT 2**

**One Slight Hitchhiker**

written and directed by Michael Bernard for Mayleen Cancel, age 13

Delores ..... Jane Bodle  
Hitchhiker 1 ..... Ahmed Attia  
Hitchhiker 2 ..... Christopher Quinn  
Marcia ..... Mayleen Cancel  
Alphonse ..... Jerry McGill

"What's My Name" and "Zip, Zap, Zoop" lyrics by Michael Bernard

**The Dons**

written and directed by Jerry McGill for Peter Ventura, age 13

Don Sanchez ..... Peter Ventura  
Don Perro ..... Michael Bernard  
Don Escuela ..... Jerry McGill  
Pat Sajak ..... Ray Ocasio

"The Greatest Swordfighter in Mexico" lyrics by Jerry McGill and "Education" lyrics by Jerry McGill and Peter Ventura

**About Face**

written by Adrienne Shelly for Isha Rodriguez, age 13.

Directed by Eris Migliorini.

Dr. Cindy Lou Love ..... Isha Rodriguez  
Ms. Sally Sweet ..... Eris Migliorini  
Bob, The Flower Delivery Guy ..... Lucas Fleischer  
Frank ..... Lucas Fleischer

"Pretty Stinks" and "Count on Yourself" lyrics by Adrienne Shelly

**What Our Dead Daddy's Deed Done Did**

written and directed by Adam Felber for Aisha Jabour, age 12

Veronica ..... Aisha Jabour  
Buford ..... Adam Felber  
Mr. Scragg ..... Thom Babe

"At Your Side" lyrics by Adam Felber

**Winging Away (A Thinly-veiled Metaphor)**

written and directed by Willie Reale for Jonathan Villanueva, age 12

Carol ..... Carol Ochs  
Repairman ..... Willie Reale  
Jay ..... Jonathan Villanueva

"How Many Angels?" and "A Message for the Angels" lyrics by Willie Reale



**Cool Stuff**

**ON SALE IN THE LOBBY**

**The Fabulous Flyer Bar (in five flavors)**  
\$2.00 and \$1.50 (\$1.00 for kids)

And featuring Shel Silverstein's "Fivey and Twoey" logo:

**Project T-Shirts (Short sleeve) — \$12.00**

**Project T-Shirts (Long sleeve) — \$15.00**

**Project Caps — \$15.00**

**Project Mugs — \$5.00 (there aren't many left!)**

Thank you for coming to ONE SLIGHT HITCH (The Tyler Hill Batch). If you are not on our mailing list (or if your address has changed), please fill out this form and give it to us on your way out or mail it to the address below. We would also like to know if you are interested in becoming a volunteer. We need help in *all areas*, so please fill out your name and phone number, and we'll call you.

**PLEASE ADD ME TO YOUR MAILING LIST:**

NAME \_\_\_\_\_

ADDRESS \_\_\_\_\_

ZIP \_\_\_\_\_

HOME PHONE \_\_\_\_\_

DAYTIME PHONE \_\_\_\_\_

**YES, I WOULD LIKE TO BE OF HELP. I CAN:**

- |   |   |  |
|---|---|--|
| <input type="checkbox"/> Help load in and out for shows | <input type="checkbox"/> Draw and/or paint  | <input type="checkbox"/> Help kids with homework |
| <input type="checkbox"/> Hang lights                    | <input type="checkbox"/> Help with mailings | <input type="checkbox"/> Teach kids a skill      |
| <input type="checkbox"/> Work on a backstage crew       | <input type="checkbox"/> Do office work     | <input type="checkbox"/> Be a chef at an event   |
| <input type="checkbox"/> Other (please specify) _____   |   |  |

**MY SCHEDULE IS:**

- Very flexible. I'm often available during weekdays.
- Somewhat flexible. I can help on the occasional morning or afternoon during the week.
- Not very flexible at all, but I've got some free time on evenings and weekends.

If you would like to mail this (and you're always welcome to enclose a tax-deductible contribution), you can send it to: The 52nd Street Project, 500 West 52nd St. New York, NY 10019. Or fax it to (212) 333-5598.

The 52nd Street Project gratefully acknowledges the support of the following foundations and corporations: American Movie Classics, Anonymous, Barker Welfare Foundation, BEA Associates, Bertelsmann's World of Expression Foundation, Brillstein-Grey Motion Pictures, Chase Manhattan Bank, Colgate Palmolive, Consolidated Edison, Creative Artists Agency, Cubic B's, Dramatist's Guild Fund, Dramatist's Play Service, Jean and Louis Dreyfus Foundation, Educational Foundation of America, EPIC, Fairway Market, Fan Fox & Leslie R. Samuels Foundation, GLADPZ, Horace W. Goldsmith Foundation, Hambrecht & Quist, Hennessey Foundation, Holland Lodge Foundation, In-Style Magazine, Rita J. & Stanley H. Kaplan Foundation, Lloyd's Bank, MCJ Foundation, James A. Macdonald Foundation, Ann M. Martin Foundation, J. P. Morgan Charitable Trust, Morgan Stanley Foundation, William Morris Agency Inc., Newman's Own, New World Foundation, The New York Times Co. Foundation, Northwest Point, O'Grady Family Foundation, Laura Pels Foundation, Polygram Filmed Entertainment, Sauce Entertainment, Scherman Foundation, Seth Sprague Educational Charitable Foundation, Staging & Design, Inc., Jules & Doris Stein Foundation, Harold & Mimi Steinberg Charitable Trust, Sultzberger Foundation, Sundance Channel L.L.C., Surdna Foundation, Susquehanna, Technicolor Film Services, Travelers Foundation, United Talent Agency, Inc., Lila Acheson Wallace Funds, Wiener Family Foundation, Wind Dancer Production Group, Yorke Construction. In addition, the following individuals made gifts of over \$150 to The 52nd Street Project this year (list current as of 7/13/98):

Jace Alexander  
 Daniel Algrant & Elise Pettus  
 May Ameen  
 Cecilia Arana-Grant  
 Lucie Arnaz & Laurence Luckinbill  
 Larry Aronson & Lynne Thigpen  
 Alan Arifa & Kay Matschullat  
 June Ballinger & Michael Goldstein  
 Jeremy Barber  
 Stephanie Barber & Arthur Collins  
 John Barbis  
 Ben Barenholtz  
 Jessica Bauman  
 Laurie Becker & Rick Sweren  
 Lisa Belzberg  
 Lisa Benavides & Tim Nelson  
 Jamie L. Bennett  
 Pamela Berlin & William Carden  
 Barry & Myrna Bernard  
 Eleanor & Gerard Bissinger  
 Susan Black  
 Laura Blanco  
 Robi & Ruth Blumenstein  
 Dr. & Mrs. John Bock  
 Jane Bolster & Steve Wertimer  
 Cristina Botta Singleton & James Singleton  
 Julie Boyd  
 Bertha & Samuel Britt  
 Catherine Brophy  
 Becky Browder & Ted Neustadt  
 Henry Buhl  
 Chris Bundy & Meg Grosswendt  
 Denise Burse & Peter Jay Fernandez  
 Kate Burton & Michael Ritchie  
 Cora Cahan & Bernard Gersten  
 Steve Callahan & Christine Dunn  
 Camilla Campbell & Oliver Platt  
 Colleen Carroll & Mitchell Semel  
 Tom Carozza  
 Roseanne Cash & John Leventhal  
 Richard & Lisa Cashin  
 Phoebe Cates & Kevin Kline  
 Henry & Kathy Chalfant  
 Stockard Channing  
 Rachel Chanoff  
 Ellen Chenoweth  
 Larry Chertoff & Rose Gasner  
 Glenda Chesshir  
 Marissa Chibas & Travis Preston  
 Ethan Coen & Trish Cooke  
 Joel Coen & Frances McDormand  
 Ruth Cohen  
 Richard J. Cohn  
 Mr. & Mrs. Frank Collins  
 Karen Cooper  
 David Copeland  
 Thomas Cott  
 Margaret Crimmons & Pierce Rafferty  
 Stephen Crudgington  
 Joan Strauss Cullman  
 Willem Dafoe

Arthur Dantchik  
 Peter & Judith Dawkins  
 Thomas Deierlein  
 Donna & William DeSeta  
 Jim Dicke  
 Edward A. DiRugis  
 Darcy Dunn & Mark Singer  
 Christopher & Karen Eddowes  
 Mario Egozi  
 Ned Eisenberg & Anna Li  
 Jacquelyn Elfert  
 Bart Eisbach & Janet Reich  
 Tim Emerson & Jan Sidebotham  
 Barbara Ettinger  
 Heidi Ettinger  
 Wendy Ettinger & Derek McLane  
 David & Joan Fehr  
 Christine Fleisher & David Sneddon  
 Dr. Eugene J. Fierman  
 Ronald C. Fiorina  
 Katherine C. Foster  
 David Frankel  
 Naomi Freundlich & Charles Miles  
 Peter Freundlich & Mary Lou Teel  
 Lois Fricke & Todd Hollander  
 Louis & Patrice Friedman  
 MacEllis K. Glass and Martha Friedrick  
 Victor Garber  
 Judith Garson & Steven Rappaport  
 Peter Fritschel & Pamela Nelson  
 Joseph Gazdak & Margaret Norden  
 Alexandra Gersten & John Vassilaros  
 Jenny Gersten & Willie Reale  
 Jilian Gersten  
 Nancy Giles  
 Stephen & Cathy Graham  
 Michael Greif  
 Emily Grishman & Susan Sampliner  
 Lisa J. Gugenheim  
 Mindy and Nicholas Guzzone  
 Richard Hadar and Marlaina Deppe  
 David and Diane Hart  
 Susan Bruce and Peter Hedges  
 Jane and Jonathan Heine  
 Peter Herdrich & Karen Trott  
 Dr. David Hidalgo  
 Jane Hoffman  
 Willy Holtzman & Sylvia Shepard  
 Barbara Howard  
 Mr. and Mrs. Richard Hyman  
 Ronwyn Ingraham  
 Bill Irwin & Martha Roth  
 Dana Ivey  
 Sy Jacobs  
 Joanne Jacobson  
 Peter Jacobson & Whitney Scott  
 Daniel Jenkins & Kathy Hiler  
 Hope Jessup  
 M. Lynne Johnson  
 Neil R. Johnson  
 Larry & Mary Jones  
 Betty and George Kaiser

Lee Kalcheim & Julia Lord  
 Eric Karpeles & Mike Sell  
 Ronald Kastner  
 Mark Keoppen & Wendy Townsend  
 Rusty King  
 Richard Kirshenbaum  
 Seth & Beth Klarman  
 Alan and Kathryn Klingstein  
 Mary Kong  
 Jan Kroeze & Jacki Ochs  
 David Kuhn  
 Judy Kuhn & David Schwab  
 Roger & Belle Kuhn  
 Elaine & Howard Langbaum  
 Carol Langstaff  
 Darrell Larson & Susanna Styron  
 Jill Larson  
 Kate Lear & Jonathan LaPoock  
 Mickey Lemle  
 Dell Lemmon  
 Robert Sean Leonard  
 Carol and Jerry Levin  
 John Bedford Lloyd & Anne Twomey  
 Marjorie Loggia  
 Andrew Louca  
 Katherine Lumb & Joe Vitale  
 John Lyons  
 Peter & Marsue MacNicol  
 Greg MacPherson & Jane Perlmutter  
 Bruce MacVittie & Carol Ochs  
 Roma Maffia  
 George Mayer, Jr.  
 Max Mayer  
 Neil Mazzella  
 Gene and Mary Ann McCoy  
 Barbara McCrane & Paul Reale  
 Hannelore & James McDaniel  
 Brian Mertes  
 Audrey & Danny Meyer  
 Linda Michaels  
 Andy Millon  
 Lawrence Motola  
 Patricia Murphy & Adam Spilka  
 Curt & Leslie Myers  
 Kate Nelligan & Rob Reale  
 Fred Nelson  
 Randy & Rona Nelson  
 Ruth Nelson  
 James A. Neuberger & Helen Stambler  
 Peter Neufeld  
 Renee F. Neuwald  
 Jim Neuwirth  
 Paul Newman & Joanne Woodward  
 Mr. and Mrs. C. J. Nolan  
 Maria Norman  
 Ellen Novack  
 Kevin O'Rourke & Edith Thurber  
 Steve Olsen  
 John Paris  
 Arthur and Peggy Penn  
 Shevi and Tom Peters  
 Ethan Phillips

Peter and Ana Rosa Phillips  
 Robert and Sue Phillips  
 Nicholas Platt  
 Richard Polatchek  
 Jeremy Posner  
 Michael Post & Fred Van Natta  
 Mr. and Mrs. Dean B. Potashner  
 Christopher Randolph  
 Peter & Helen Randolph  
 Denise Rich  
 Todd Richter  
 Herald Ritch  
 Jill Robbins  
 Ricki Roer  
 Jacques Rose & Carol Ule  
 David Rosenberg  
 Betsy & Clifford Ross  
 Donald Rothschild & Lottchen Shivers  
 Daniel & Janice Rous  
 John Gould Rubin  
 James Russek  
 Lawrence A. Russo  
 Steve Sabba  
 Tim Sanford and Lisa Finstrom  
 John Sayles & Maggie Renzi  
 Karin & Tom Schall  
 Leslie Schine and Nils Nielsen  
 Stephen A. Schwarzman  
 Campbell Scott  
 Stefan Selig  
 Bernice Shawl  
 Adrienne Shelly  
 Allen and Joan Shore  
 Brian Siberell & Patty Dryden  
 Heath and Landon Slane  
 Ken Smith and Cyd Tomack  
 Abigail Solomon  
 Jeff Stafford  
 Fisher Stevens  
 Cynthia Stivers  
 Daniel Sweet  
 Mariko Tada  
 Marisa Tomei  
 Judith Tygard & Mitch Weitzner  
 Adam and Andrea Usdan  
 Laura Valeroso & David Seidman  
 Wendy vanden Heuvel  
 Susan Vitucci  
 Mary Pat Walsh  
 Borah & Mildred Walton  
 Anita Waxman  
 Lenny & Sally Weiss  
 Gregory Welch  
 Michael & Zena Wiener  
 Robert Wiener  
 Max and Barbara Wilk  
 Elizabeth Williams & Joseph Forte  
 Matt Williams  
 Stephen M. Wilson  
 Donald Windham  
 Bill Wrubel  
 Janine & Jeffrey Yass  
 James & Mary Lin Yoshimura

The 52nd Street Project presents:



The Ensemble Studio Theatre

Sat., Nov. 7th  
 and  
 Sun., Nov. 8th  
 3:00 and 7:30



# There and Back: The Round Trip Plays



The 1998 Playback Plays: Nov. 7 & 8, The Ensemble Studio Theatre, N.Y.C.

## Project Staff

Willie Reale, Artistic Director  
Carol Ochs, Executive Director  
Michael Bernard, Associate Artistic Director  
John Sheehy, Director of Development and Marketing  
George Roman Babiak, Production Manager  
Julie Feldman, Director of Education  
Iris A. Brown, Graphic Designer  
Ray Ocasio and Mean Ray Harold - Receptionists  
Jeremy Seymour and Eva Minemar - Interns

## Production Staff

Kim Sherman, Composer  
Kevin Joseph Roach, Set Designer  
Matt Staniec, Lighting Designer:  
Carol Pelletier, Costume Designer  
Jeremy Posner, Sound Designer  
Jenny Peek, Stage Manager  
Slide Designers:  
Renato Castilho, Tiana Manfred,  
Adam Rodriguez, John Steward,  
Alberta Testanero  
Colorform Designers:  
Sarah Hokanson, Katie Dominguez  
Foamcore Prop Design Team:  
George Babiak, Dan Carlson,  
Alison Eisendrath, Joe Franchere,  
Kilty Gilmour, Cara Marcous and her  
friend Jill, Jeremy Seymour,  
Nicole Watson.  
Slide Operator: Jessica Lissy

Furniture Crew:  
Jeremy Seymour, Ray Ocasio,  
Noel Polanco  
Prop Crew:  
Eva Minemar, Vionel Ortiz,  
Robert Villanova,  
Colorformists:  
Laura Lee Shink,  
Jaysunn Rosado  
House Manager: Karin Schall  
Load-in & Light Hang Crew:  
Robin Gillette, Stacey Linden,  
Doug Lockwood, Elizabeth Roberts,  
Charlton Ruddock,  
Tom Schall, Lia Yang  
Weekend-away Chef:  
Christopher Randolph  
There and Back Illustration:  
Karen Gusdorf

PROGRAM LAYOUT: GEORGE BABIAK

The Playback Program is made possible with public funds from the New York State Council on the Arts, a state agency, the Department of Youth and Community Development, and the New York City Department of Cultural Affairs.



The 52nd Street Project is a non-profit organization that brings inner-city children from the Hell's Kitchen/Clinton neighborhood together with professional theater artists to create theater. **There and Back** is a production of our Playback program. In it, kid actor/playwrights are taken away for a weekend in the country where they write a play. Their adult actor/playwright partners then write "answer plays" in response. The partners then perform the plays together. All of the children seen tonight are veterans of the Playmaking classes which were adapted for the Project by Daniel Judah Sklar from his book *Playmaking: Children Writing and Performing Their Own Plays*.

## The 52nd Street Project Board of Directors

Ben Barenholtz	Frances McDormand, <i>chairperson</i>
Lisa Benavides	Patricia M. Murphy, Esq.
Rachel Chanoff	Carol Ochs
Ruth Cohen	Willie Reale
Heidi Ettinger	Gus Rogerson
Wendy Ettinger, <i>chair emeritus</i>	Jose Soto, Jr., <i>alumni boardmember</i>
Louis P. Friedman	Pamala Tyson
Stephen Graham	Laura Valeroso
Larry Jones	Wendy vanden Heuvel
James McDaniel	Elizabeth Williams

## Special Thanks To:

Our friends Peter, Helen, and Christopher Randolph, who put us up for the kids' writing retreat over Columbus Day weekend at their home in Wareham, Mass. Extra turbo-charged thanks go to Chris, who did all the cooking.

## In-Kind Contributions:

Curt, Jamie, Christine, and all the staff at Ensemble Studio Theatre; Signature Theatre Company, Primary Stages; Playwright's Horizons; Colorforms; Neil A. Mazzella & Hudson Scenic Studios, Inc.; Shays & Murphy; Iris A. Brown & Bernhardt/Fudyma Design Group; Ron Kastner, Capital Printing; Masque Sound; New Dramatists; Steve Olsen & The West Bank Cafe; Materials for the Arts; Port Authority; Mayor's Office of Film & Television; John A. Vassilaros & Son; Paris Chocolates; Scholastic Productions; Coleman, Inc.; Watkins Products; Eric Karpeles & Mike Sell; Bill Muddyman and the Chateau de Berne; Boylan's Bottling Company, BMG, John Steward, Paul Saylor and The Commonwealth Brewing Company, David Sneddon and Fairway Market, and Andy Millon.

Don't miss our upcoming shows!

# OOPS! The Accidental Plays

Dec. 11, 12, & 13

At this moment, 10 small Project rookies are taking a Playmaking class with Michael Bernard. When they are done, they will be hailed as masters of their craft and given their very own writer's retreat in Connecticut. Come see their final plays performed by professional adult actors right here at **The Ensemble Studio Theatre**. Call 642-5052 for reservations.

## The Two-on-Two's

Jan. 25 and 26, 1999  
The Westbank Cafe Theater

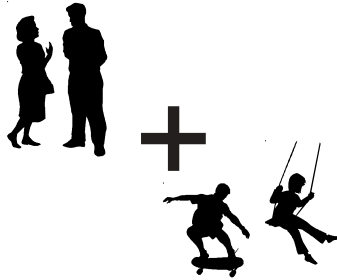

In the One-on-One's, a single kid is paired with a single adult. Now you can see *two* kids (grizzled Project vets, this time) perform a play written by an adult and directed by *another* adult.

WINTER SERIES

## Playmaking

March 19-21, 1999



In January, our next batch of newcomers will undertake the 10-week Playmaking program. At the end of the class they will be whisked away to Pennsylvania for a weekend to fashion a set of plays. The only thing they need: an audience.

## Cool Stuff ON SALE IN THE LOBBY

**The Fabulous Flyer Bar (in five flavors)**  
\$2.00 and \$1.50 (\$1.00 for kids)

And featuring Shel Silverstein's "Fivey and Twoey" logo:

**Project T-Shirts (Short sleeve)** — \$12.00

**Project T-Shirts (Long sleeve)** — \$15.00

**Project Caps** — \$15.00

**Project Mugs** — \$5.00 (there aren't many left!)

Thank you for coming to **THERE AND BACK: THE ROUND-TRIP PLAYS**. If you are not on our mailing list (or if your address has changed), please fill out this form and give it to us on your way out or mail it to the address below. We would also like to know if you are interested in becoming a volunteer. We need help in **all areas**, so please fill out your name and phone number, and we'll call you.

### PLEASE ADD ME TO YOUR MAILING LIST:

NAME \_\_\_\_\_

ADDRESS \_\_\_\_\_

ZIP \_\_\_\_\_

HOME PHONE \_\_\_\_\_

DAYTIME PHONE \_\_\_\_\_

### YES, I WOULD LIKE TO BE OF HELP. I CAN:

- |   |   |  |
|---|---|--|
| <input type="checkbox"/> Help load in and out for shows | <input type="checkbox"/> Draw and/or paint  | <input type="checkbox"/> Help kids with homework |
| <input type="checkbox"/> Hang lights                    | <input type="checkbox"/> Help with mailings | <input type="checkbox"/> Teach kids a skill      |
| <input type="checkbox"/> Work on a backstage crew       | <input type="checkbox"/> Do office work     | <input type="checkbox"/> Be a chef at an event   |
| <input type="checkbox"/> Other (please specify) _____   |   |  |

### MY SCHEDULE IS:

- Very flexible. I'm often available during weekdays.  
 Somewhat flexible. I can help on the occasional morning or afternoon during the week.  
 Not very flexible at all, but I've got some free time on evenings and weekends.

If you would like to mail this (and you're always welcome to enclose a tax-deductible contribution), you can send it to: *The 52nd Street Project*, 500 West 52nd St. New York, NY 10019. Or fax it to (212) 333-5598.

## There and Back: ACT I

All music composed by Kim Sherman

### The Great Mess-Up

by Ahmed Attia, age 14. Dramaturg: Willie Reale. Director: Keith Reddin

Mumbo ..... Ahmed Attia  
Caz ..... Keith Reddin  
The Great Master ..... George Babiak  
Policeman ..... Jeremy Seymour

### The Great Fix-Up

Written and directed by Keith Reddin

Mumbo ..... Ahmed Attia  
Caz ..... Keith Reddin  
The Great Master ..... George Babiak  
Policeman ..... Jeremy Seymour

### Peewee's Imaginary Revenge

by Judy Agosto, age 14. Dramaturg: Kate Coleman. Director: Alison Tatlock.

Precious ..... Judy Agosto  
Star ..... Alison Tatlock  
The Voice of Peewee ..... Jeremy Seymour

### Peewee's Imaginary Revenge, Part II

by Susan Kim. Directed by Alison Tatlock.

Precious ..... Judy Agosto  
Star ..... Alison Tatlock

*"An Imaginative Solution"* lyrics by Willie Reale

### The Case of the Mad Scientist

by Joseph Mohamed, age 14. Dramaturg: Danny Johnson. Director: Dion Graham.

Dr. Bean ..... Dion Graham  
Voice of General Farm, Saddam Hussein, and others ..... Jeremy Seymour  
Delivery Kid ..... Vionel Ortiz  
Jonathan Jones ..... Joseph Mohamed

### The Baker

by Danny Johnson. Director: Dion Graham

Jonathan Jones ..... Joseph Mohamed  
Tim the Baker ..... Dion Graham

### Vice-Versa

by Sahara Walsh, age 14. Dramaturg/Director: Julie Dretzin

Rose Ashenafi ..... Sahara Walsh  
Athena Louise ..... Julie Dretzin

### From Here to Eternity... And Back

by Willie Reale. Directed by Julie Dretzin

Rose Ashenafi ..... Sahara Walsh  
Athena Louise ..... Julie Dretzin

*"Two Epitaphs in Forty-Nine Bars"* lyrics by Willie Reale.

I N T E R M I S S I O N

## There and Back: ACT II

### Jewel's Case

by Luis Maldonado, age 13. Dramaturg: John Sheehy. Director: Melissa Murray

Moby Mike ..... Luis Maldonado  
Jewel Cash ..... Melissa Murray  
Father Cash ..... George Babiak  
Mother Cash ..... Faux McCorr

*"The Best Detective"* and *"Dog and Cat"* lyrics by Luis Maldonado.

### The Button Case

by John Sheehy. Directed by Melissa Murray.

Moby Mike ..... Luis Maldonado  
Jewel Cash ..... Melissa Murray  
Father Cash ..... George Babiak  
Mother Cash ..... Faux McCorr

*"Moby Mike, Amateur Singing Detective Theme Song"* lyrics by Luis Maldonado and John Sheehy

### Best Friends

by Mary Vamvoukakis, 13. Dramaturg/Director: George Babiak

Roseanna ..... Mary Vamvoukakis  
Eric ..... Matt Saldivar  
Mindy Stone/Mom ..... Eva Minemar

*"Come On, Let's Go"* lyrics by Mary Vamvoukakis

### Best Friends II

by Adriana Trigiani. Directed by George Babiak

Roseanna ..... Mary Vamvoukakis  
Eric ..... Matt Saldivar  
Mom ..... Eva Minemar

### The Lonely Cow

by Ben Barthelemy, age 15. Dramaturg/Director: Stephen Haff

Bob ..... Jose Soto  
Stephanie ..... Camilia Sanes  
Cow ..... Ben Barthelemy

*"Lonely Cow Blues"* Lyrics and music by Ben Barthelemy

### Moony

by Alexandra Gersten. Directed by Stephen Haff

Bob ..... Jose Soto  
Stephanie ..... Camilia Sanes  
Cow ..... Ben Barthelemy

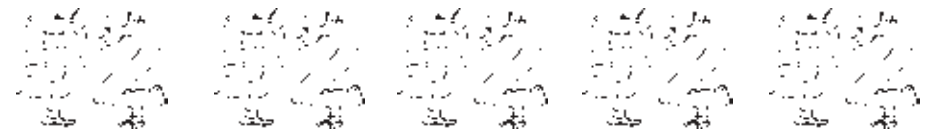



The 52nd Street Project gratefully acknowledges the support of the following foundations and corporations: American Movie Classics, Anonymous, Barker Welfare Foundation, The Blythmour Corporation, Bertelsmann's World of Expression Foundation, Brillstein-Grey Motion Pictures, BT Foundation, Chase Manhattan Foundation, Colgate Inner City Fund, Consolidated Edison, Creative Artists Agency, Crown Equipment Corporation, Cubic B's, The Dammann Fund, The Dramatists Guild Fund, Dramatists Play Service, The Jean & Louis Dreyfus Foundation, Educational Foundation of America, EPIC, Fairway Market, Ford Foundation, The Fan Fox & Leslie R. Samuels Foundation, Gap Inc., GLADPZ Foundation, The Hennessy Foundation, Horace W. Goldsmith Foundation, Hambrecht & Quist, Hudson Scenic Studio, IBM International Foundation, In-Style Magazine, Rita J. and Stanley H. Kaplan Foundation, Lloyds Bank, James A. Macdonald Foundation, Ann M. Martin Foundation, MCJ Foundation, J.P. Morgan Charitable Trust, Morgan Stanley Dean Witter Foundation, William Morris Agency, Inc., Mosaic Entertainment, Newman's Own, New World Foundation, The New York Times Company Foundation, O'Grady Family Foundation, Laura Pels Foundation, Pew Charitable Trust, Polygram Filmed Entertainment, President's Committee on the Arts and the Humanities, RJM Group, Sauce Entertainment, The Scherman Foundation, Schulte Roth & Zabel, Seth Sprague Educational & Charitable Foundation, Sound One Corporation, Staging and Design, Inc., The Harold & Mimi Steinberg Charitable Trust, The Sulzberger Foundation, Sundance Channel LLC, The Surdna Foundation, Susquehanna, Technicolor Film Services, Travelers Foundation, United Talent Agency, Inc., John A. Vassilaros & Sons, Inc., I. Weiss & Sons, Inc., Wiener Family Foundation, Wind Dancer Production Group, Yorke Construction Corporation. In addition, the following individuals made gifts of over \$150 to The 52nd Street Project this year (list current as of 12/8/98):

Jace Alexander	Christopher & Karen Eddowes	Belle & Roger Kuhn	Todd Richter & Donna Plummer
Franco Aller	Mario Egozi	Howard & Elaine Langbaum	Hearld & Linda Ritch
May Ameen	Ned Eisenberg	Carol Langstaff	Jill Robbins
Cecilia Arana-Grant	Jacquelyn Elfert	Jill Larson	Ricki Roer
Lucie Arnaz & Laurence Luckinbill	Barbara Ettinger	Kate Lear & Jonathan LaPook	David Rosenberg
June Ballinger & Michael Goldstein	Heidi Ettinger	Mickey Lemle	Barbara & Chester Ross
Jeremy Barber	Wendy Ettinger & Derek McLane	Dell Lemmon	Betsy & Clifford Ross
Stephanie Barber & Arthur Collins	Patti Ewen	Robert Sean Leonard	Martha Roth & Bill Irwin
Mr. & Mrs. John Barbis	David & Joan Fehr	Carol & Jerry Levin	Donald Rothschild & Lottchen Shivers
Ben Barenholtz	Peter Jay Fernandez & Denise Burse	Anna Li	Daniel & Janice Rous
Jessica Bauman	Eugene Fierman	John Bedford Lloyd & Anne Twomey	John Gould Rubin
Laurie Becker & Rick Sweren	Katherine Foster	Marjorie Loggia	James & Judy Russek
Lisa Belzberg	David Frankel	Andrew Louca	Lawrence Russo
Lisa Benavides & Tim Nelson	Richard Frankel & Kathleen Clark	Katherine Lumb and Joseph Vitale	Steve Sabba
Jamie Bennett	Naomi Freundlich & Charles Miles	John Lyons	Tim Sanford & Lisa Finstrom
Kitty & Nicholas Benton	Lois Fricke & Todd Hollander	Greg MacPherson & Jane Perlmutter	John Sayles & Maggie Renzi
Pam Berlin & Billy Carden	Louis & Patrice Friedman	Roma Maffia	Karin & Tom Schall
Myrna & Barry Bernard	Victor Garber	Donald Margulies & Lynn Street	Leslie Schine & Nils Nilsen
Eleanor & Gerard Bissinger	Judith Garson & Steven Rappoport	Kay Matschullat & Alan Arffa	Mr. & Mrs. Stephen A. Schwarzman
Lewis Black	M. Rose Gasner & Larry Chertoff	George Mayer	Campbell Scott
Susan Black	Alexandra Gersten & John Vassilaros	Max Mayer	Stefan Selig
Laura Blanco	Jenny Gersten & Willie Reale	Neil Mazzella	Mitchell Semel & Colleen Carroll
Robi & Ruth Blumenstein	Jilian Gersten	Gene & Mary Ann McCoy	Bernice Baruch Shawl
Dr. & Mrs. John Bock	Nancy Giles	James & Hannelore McDaniel	Allen & Joan Shore
Cristina Botta & James Singleton	Lloyd & Kilty Gilmour	Frances McDormand & Joel Coen	Brian Siberell & Patty Dryden
Buzz Bovshow	MacEllis Glass & Martha Friedricks	Brian Mertes	Jan Sidebotham & Tim Emerson
Julie Boyd	Jessica Glass Pollack	Audrey & Danny Meyer	Mark Singer & Darcy Dunn
Samuel & Bertha Britt	Stephen & Cathy Graham	Andy Millon	Heath & Landon Slane
Catherine Brophy	Michael Greif	Cassandra Morgan	Ken Smith & Cyd Tomack
Becky Browder & Ted Neustadt	Flavia Grimm	Lawrence Motola	David Sneddon & Krisline Fleisher
Susan Bruce & Peter Hedges	Emily Grishman & Susan Sampliner	Patricia M. Murphy, Esq. & Adam Spilka	Abigail Rose Solomon
Henry Buhl	Lisa Gugenheim	Curt & Leslie Myers	Jeff Stafford
Chris Bundy & Meg Grosswendt	Eileen Guggenheim	Fred Nelson & Elizabeth Warner	Fisher Stevens
Kate Burton & Michael Ritchie	Mindy & Nicholas Guzzone	Pam Nelson & Peter Fritschel	Cynthia Stivers
Cora Cahan & Bernard Gersten	Marlaina Deppe & Richard Hadar	Randy & Rona Nelson	Susanna Styron & Darrell Larson
Steven Callahan & Christine Dunn	David & Diane Hart	Ruth Nelson	Stephen Sultan
Tom Carrozza	Jane & Jonathan Heine	James Neuberger & Helen Stambler	Daniel Swee
Rosanne Cash & John Leventhal	Peter Herdrich & Karen Trott	Peter Neufeld	Mariko Tada
Mr. & Mrs. Richard Cashin	John Herron	Renee Neuwald	Mary Lou Teel & Peter Freundlich
Phoebe Cates & Kevin Kline	David Hidalgo	Jim Neuwirth	Lynne Thigpen & Larry Aronson
Henry & Kathy Chalfant	Jane Hoffman	Paul Newman & Joanne Woodward	Marisa Tomei
Stockard Channing	Willy Holtzman & Sylvia Shepard	Mr. & Mrs. C.J. Nolan	Judith Tygard & Mitch Weitzner
Rachel Chanoff	Barbara Howard	Maria Norman	Laura Valeroso & David Seidman
Ellen Chenoweth	Bette & Richard Hyman	Kevin O'Rourke & Edith Thurber	Fred Van Natta & Michael Post
Glenda Chesshir	Ronwyn Ingraham	Carol Ochs & Bruce MacVittie	Wendy vanden Heuvel
Marissa Chibas & Travis Preston	Dana Ivey	Jacki Ochs & Jan Kroeze	Susan Vitucci
Ethan Coen & Trish Cooke	Allison Jacobs	Steve Olsen	Mary Pat Walsh
Ken & Cindy Cook	Sy Jacobs	John Paris	Borah & Mildred Walton
Ruth Cohen	Joanne Jacobson	Arthur & Peggy Penn	Robyn Watts
Richard Cohn	Peter Jacobson & Whitney Scott	Bat-Sheva & Thomas Peters	Anita Waxman
Frank & Mary Collins	Daniel Jenkins & Kathy Hiler	Elise Pettus & Daniel Algrant	Lenny & Sally Weiss
David Copeland	Hope Jessup	Ethan Phillips	Gregory Welch
Thomas Cott	Larry & Mary Jones	Robert & Sue Phillips	Jane Bolster & Steve Wertimer
Margaret Crimmins & Pierce Rafferty	Lee Kalchein & Julia Lord	Oliver Platt & Camilla Campbell Platt	Jenny Wiener
Joan Straus Cullman	Lucy Kaplan	Richard Polatchek	Michael & Zena Wiener
Willem Dafoe & Liz LeCompte	Ronald J. Kastner	Jeremy Posner	Robert Wiener
Arthur Dantchik	Mark Keoppen & Wendy Townsend	Dean Potashner	Max & Barbara Wilk
Peter & Judith Dawkins	Richard Kirshenbaum	Christopher Randolph	Elizabeth Williams & Joseph Forte
Thomas Deierlein	Beth & Seth Klarman	Peter & Helen Randolph	Matt Williams & Angelina Fiordellisi
William & Donna DeSeta	Alan & Kathryn Klingenstein	Janet Reich & Bart Elsbach	Donald Windham
Mr. & Ms. DiRugeri	Mary Kong	Jacquelyn Reingold	Bill Wrubel
Sue Drury	David Kuhn	Denise Rich	Jeffrey & Janine Yass
Jack & June Dunbar	Judy Kuhn & David Schwab		James & Mary Lin Yoshimura

The 52nd Street Project presents:



## The Accidental plays

### The Fall, 1998 Playmaking Series

Friday, Dec. 11 at 7:30 p.m., Sat., Dec. 12 at 3:00 and 7:30 p.m.

Sun., Dec. 13 at 3:00 p.m.

*The Ensemble Studio Theatre, 549 West 52nd Street*



# OOPS!

## The accidental Plays

The Fall, 1998 Playmaking Plays - Dec. 11-13, 1998  
The Ensemble Studio Theatre, New York City



### Project Staff

Willie Reale, Outgoing Artistic Director  
Gus Rogerson, Incoming Artistic Director  
Carol Ochs, Executive Director  
Michael Bernard, Associate Artistic Director  
John Sheehy, Director of Development and Marketing  
George Roman Babiak, Production Manager  
Julie Feldman, Director of Education  
Iris A. Brown, Graphic Designer  
Nice Ray Ocasio and Mean Ray Harold, Receptionists  
Jeremy Seymour, Intern

### Production Staff

Rusty Magee, Composer  
Kevin Joseph Roach, Set Designer  
Greg MacPherson, Lighting Designer:  
Crystal Thompson, Costume Designer  
Dan Carlson, Sound Designer  
Stage Managers:  
Anne Lowrie and Kelly Fitzpatrick  
Slide Designers:  
Renato Castilho, Katherine Lumb,  
Tiana Manfred, John Steward,  
Alberta Testanero  
Colorform Designers:  
Sarah Hokanson, Katie Dominguez  
Foamcore Prop Design Team:  
George Babiak, Esther Geller,  
Sheila Kehoe, Stacy Linden & her  
husband Scott, Cara Marcous,  
Jenny Peek, Jeremy Seymour,  
John Sheehy, and Jeremy's good  
buddies Sarah & Levi

Slide Operator: Kimberly Mack  
Furniture Crew:  
Chris "Smarty Pantalones" Quinn,  
Alex "Strong Man" Metzler,  
Ben "Cow" Barthelemy  
The Prop Queens:  
Ashby Semple, Zsuzsa Mysak,  
Lorraine Zambrano  
Colorformist: Nikola Smith  
Backstage Bloke: Jeremy Seymour  
House Managers:  
Liz Flahive & Mary Pat Walsh  
Load-in & Light Hang Crew:  
Jilly Crook, Betsy Foldes,  
Bruce MacVittie, Kirt Markle,  
Hank Meiman, Chris Quinn,  
Charlton Ruddock, Tom Schall,  
Jeremy Seymour  
Away Chef: Charlotte Armstrong  
OOPS! Illustration: Lucas Fleischer

PROGRAM LAYOUT: GEORGE BABIAK

The 52nd Street Project is a non-profit organization that brings children from the Hell's Kitchen/Clinton neighborhood together with professional theater artists. **OOPS! The Accidental Plays** is part of our Playmaking program. Young people participate in an eight-week playwriting course taught by Michael Bernard and adapted for the Project by Daniel Judah Sklar from his book, *Playmaking: Children Writing and Performing Their Own Plays*. At the end of the course, each child is given two actors, a theme, and a dramaturg/director who guides him or her through the writing of a play during a weekend retreat in the country. **OOPS! The Accidental Plays** is the end result.

The Project is delighted to return to the Ensemble Studio Theatre, where we have been performing since our inception in 1981. We gratefully acknowledge the fact that if E.S.T. wasn't here, we'd be nowhere.

### The 52nd Street Project Board of Directors

Ben Barenholtz	Frances McDormand, <i>chairperson</i>
Lisa Benavides	Patricia M. Murphy, Esq.
Rachel Chanoff	Carol Ochs
Ruth Cohen	Willie Reale
Heidi Ettinger	Gus Rogerson
Wendy Ettinger, <i>chair emeritus</i>	José Soto, Jr., <i>alumni boardmember</i>
Louis P. Friedman	Pamala Tyson
Stephen Graham	Laura Valeroso
Larry Jones	Wendy vanden Heuvel
James McDaniel	Elizabeth Williams

### Special Thanks To:

Our friends Stephen, Cathy, and Juliet Graham, who hosted us for a weekend writer's retreat in Kent, Connecticut and to Charlotte, Celia, and Bonnie for looking after us while we were there. We're also grateful to Sam and Lynn Waterston, the Fontanas, and Wendy vanden Heuvel for billeting adults over the weekend. We must also thank Vanessa Valdes for her sound advice and everyone who helped us send out our Christmas fundraising mailer last week.

### In-Kind Contributions:

Curt, Jamie, Eliza, Christine, and all the staff at Ensemble Studio Theatre; Primary Stages; Colorforms; Neil A. Mazzella & Hudson Scenic Studios, Inc.; Shays & Murphy; Iris A. Brown & Bernhardt/Fudyma Design Group; Ron Kastner, Capital Printing; Masque Sound; New Dramatists; Steve Olsen & The West Bank Cafe; Materials for the Arts; Port Authority; Mayor's Office of Film & Television; John A. Vassilaros & Son; Paris Chocolates; Scholastic Productions; Coleman, Inc.; Watkins Products; Eric Karpeles & Mike Sell; Bill Muddyman and the Chateau de Berne; Ronald C. Fiorina and Boylan's Bottling Company; BMG; John Steward; Paul Saylor and The Commonwealth Brewing Company; David Sneddon and Fairway Market; and Andy Millon.



The Playmaking Program is made possible with public funds from the National Endowment for the Arts, New York State Council on the Arts, a state agency, the Department of Youth and Community Development, the New York City Department of Cultural Affairs, and the office of the President of the Borough of Manhattan.



Don't miss our upcoming shows!

**ON THE FENCE**  
THE AMBIVALENT PLAYS

January 29, 30, & 31  
at  
The Women's  
Interart Annex  
Right next door to our  
Clubhouse at 500 W. 52nd

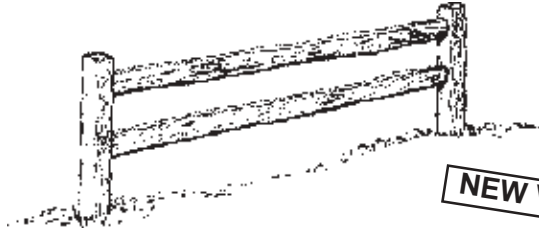

In the One-on-One's, a single kid is paired with a single adult. Now you can see two kids (grizzled Project vets, this time) perform a play written by an adult and directed by another adult. All this, and root beer floats to boot!

**GO  
FIGURE!**

The Inventive Plays



March 19, 20, & 21  
at  
The Ensemble  
Studio Theatre

In January, our next batch of newcomers will undertake the 8-week Playmaking program. At the end of the class they will be whisked away to Pennsylvania for a weekend to fashion a set of plays. The only thing they need: an audience.

THE 52ND STREET PROJECT

**Annual Benefit**

Monday, May 3, 1999  
at the Puck Building  
(Theme to be announced)

For information or reservations call  
**John Sheehy**, our wry but highly amusing  
Director of Marketing and Development, at  
(212) 333-5252



**Cool Stuff** ON SALE IN THE LOBBY

**The Fabulous Flyer Bar (in five flavors)**  
\$2.00 and \$1.50 (\$1.00 for kids)

And featuring Shel Silverstein's "Fivey and Twoey" logo:

**Project T-Shirts (Short sleeve) — \$12.00**

**Project T-Shirts (Long sleeve) — \$15.00**

**Project Caps — \$15.00**

Thank you for coming to **OOPS! The Accidental Plays**. If you are not on our mailing list (or if your address has changed), please fill out this form and give it to us on your way out or mail it to the address below. We would also like to know if you are interested in becoming a volunteer. We need help in **all areas**, so please fill out your name and phone number, and we'll call you.

PLEASE ADD ME TO YOUR MAILING LIST: 12/98

NAME \_\_\_\_\_

ADDRESS \_\_\_\_\_

ZIP \_\_\_\_\_

HOMEPHONE \_\_\_\_\_

DAYTIME PHONE \_\_\_\_\_

YES, I WOULD LIKE TO BE OF HELP. I CAN:

- Help load in and out for shows
- Draw and/or paint
- Help kids with homework
- Hang lights
- Help with mailings
- Teach kids a skill
- Work on a backstage crew
- Do office work
- Be a chef at an event
- Other (please specify) \_\_\_\_\_

MY SCHEDULE IS:

- Very flexible. I'm often available during weekdays.
- Somewhat flexible. I can help on the occasional morning or afternoon during the week.
- Not very flexible at all, but I've got some free time on evenings and weekends.

If you would like to mail this (and you're always welcome to enclose a tax-deductible contribution), you can send it to: The 52nd Street Project, 500 West 52nd St. New York, NY 10019. Or fax it to (212) 333-5598.

# OOPS! The Accidental Plays: ACT I

All original music composed by Rusty Magee

## Friendship

Written by Robert Tomas, age 9  
Dramaturg/Director: Gus Rogerson

Josh ..... Michael Potts  
Anthony ..... Angel David

*Let's Be Friends* lyrics by Robert Tomas

## Who's Sorry Now?

Written by Destiny Rivera, age 13  
Dramaturg/Director: Karen Kandel

Cindy ..... Anne O'Sullivan  
Tray ..... Trey Wilson  
Mr. Goggles ..... Anne O'Sullivan  
Other students ..... Ben Barthelemy, Alex Metzler,  
Lorraine Zambrano

## Mina Murray's Problem

Written by Anju Andre-Bergmann, age 12  
Dramaturg/Director: Lizzie Gottlieb

Lucy ..... Emily Wachtel  
Mina ..... Cecilia Arana  
Grandpa Murray ..... Tom Carrozza

*The Murray Family Epilogue Song* lyrics by Anju Andre-Bergmann

## The Kidnapper

Written by Joanna Santana, age 10  
Dramaturg/Director: Mitchell Lemsky

Jason ..... Jason Sklar  
Sharon ..... Kaleda Davis  
Voice of Brainteaser ..... Michael Bernard  
Mouse vocalizations ..... Jeremy Seymour

👉 I N T E R M I S S I O N 👈

# OOPS! The Accidental Plays: ACT II

## You Get a Lot When You Play Lotto

Written by Jaymaree Rosado, age 9  
Dramaturg/Director: Wendy vanden Heuvel

Billy Ann Sue ..... Jeanne Simpson  
Sue Billy Ann ..... Keira Naughton  
Lotto Announcer ..... Jeremy Seymour  
Waitress ..... Zsuzsa Mysak  
Mom ..... Judy Kuhn

*Big Sister* lyrics by Jaymaree Rosado

## Brother Against Sister

Written by Bryan Socarras, age 9  
Dramaturg/Director: Ed Vassallo

Jeffrey ..... Alex Draper  
Cindy ..... Lori Tan Chinn

## If It Wasn't For Coffee...

Written by Shevonne Hernandez, age 11  
Dramaturg: Lisa Benavides. Director: Michael Bernard

Sasha ..... Zabryna Guevara  
Joey ..... L.B. Williams

*If It Wasn't For Coffee* lyrics by Shevonne Hernandez

## We Love This Pie

Written by Adrian Zambrano, age 9  
Dramaturg: Tim Nelson Director: Gus Rogerson

Darin, a deer ..... Peter Jacobson  
Rian, a bear ..... Paul Butler  
Sebastian, a woodpecker ..... Gus Rogerson  
The Park Ranger ..... George Babiak

*You Are So Funny, I Like To Peck, and We Love This Pie* lyrics by Adrian Zambrano.

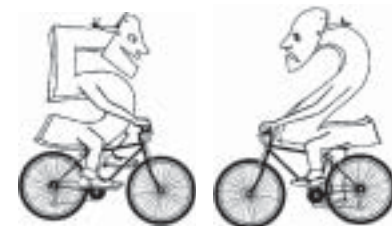

The 52nd Street Project gratefully acknowledges the support of the following foundations and corporations: American Movie Classics; Anonymous; Barker Welfare Foundation; The Blythmour Corporation; Bertelsmann's World of Expression Foundation; Brillstein-Grey Motion Pictures; BT Foundation; Chase Manhattan Foundation; Colgate Inner City Fund; Consolidated Edison; Creative Artists Agency; Crown Equipment Corporation; Cubic B's; The Dammann Fund; The Dramatists Guild Fund; Dramatists Play Service; The Jean & Louis Dreyfus Foundation; Educational Foundation of America; EPIC; Fairway Market; Ford Foundation; The Fan Fox & Leslie R. Samuels Foundation; Gap Inc.; GLADPP Foundation; The Hennessy Foundation; Horace W. Goldsmith Foundation; Hambrecht & Quist; Hudson Scenic Studios; IBM International Foundation; In-Style Magazine; Rita J. and Stanley H. Kaplan Foundation; Lloyds Bank; James A. Macdonald Foundation; Ann M. Martin Foundation; MCJ Foundation; J.P. Morgan Charitable Trust; Morgan Stanley Dean Witter Foundation; William Morris Agency, Inc.; Mosaic Entertainment; Newman's Own; New World Foundation; The New York Times Company Foundation; O'Grady Family Foundation; Laura Pels Foundation; Pew Charitable Trust; Polygram Filmed Entertainment; President's Committee on the Arts and the Humanities; RJM Group; Sauce Entertainment; The Scherman Foundation; Schulte Roth & Zabel; Seth Sprague Educational & Charitable Foundation; Sound One Corporation; Staging and Design, Inc.; The Harold & Mimi Steinberg Charitable Trust; The Sulzberger Foundation; Sundance Channel LLC; The Surdna Foundation; Susquehanna; Technicolor Film Services; Travelers Foundation; United Talent Agency, Inc.; John A. Vassilaros & Sons, Inc.; I. Weiss & Sons, Inc.; Wiener Family Foundation; Wind Dancer Production Group; Yorke Construction Corporation. In addition, the following individuals made gifts of over \$150 to The 52nd Street Project this year (list current as of 1/27/99):

Jace Alexander	Ned Eisenberg	Kate Lear & Jonathan LaPook	Hearld & Linda Ritch
Franco Aller	Jacquelyn Elfert	Mickey Lemle	Jill Robbins
May Ameen	Barbara Ettinger	Jane Bodle & Mitchell Lemsky	Ricki Roer
Cecilia Arana-Grant	Heidi Ettinger	Dell Lemmon	David Rosenberg
Lucie Arnaz & Laurence Luckinbill	Wendy Ettinger & Derek McLane	Robert Sean Leonard	Betsy & Clifford Ross
June Ballinger & Michael Goldstein	Peter Jay Fernandez & Denise Burse	Carol & Jerry Levin	Martha Roth & Bill Irwin
Jeremy Barber	Eugene Fierman	Anna Li	Donald Rothschild & Lottchen Shivers
Stephanie Barber & Arthur Collins	Katherine Foster	John Bedford Lloyd & Anne Twomey	Daniel & Janice Rous
Mr. & Mrs. John Barbis	David Frankel	Marjorie Loggia	John Gould Rubin
Ben Barenholtz	Richard Frankel & Kathleen Clark	Andrew Louca	James & Judy Russek
Jessica Bauman	Naomi Freundlich & Charles Miles	Katherine Lumb and Joseph Vitale	Lawrence Russo
Laurie Becker & Rick Sweren	Lois Fricke & Todd Hollander	John Lyons	Steve Sabba
Lisa Belzberg	Louis & Patrice Friedman	Greg MacPherson & Jane Perlmutter	Tim Sanford & Lisa Finstrom
Lisa Benavides & Tim Nelson	Victor Garber	Roma Maffia	John Sayles & Maggie Renzi
Jamie Bennett	Judith Garson & Steven Rappoport	Donald Margulies & Lynn Street	Karin & Tom Schall
Kitty & Nicholas Benton	M. Rose Gasner & Larry Chertoff	Kay Matschullat & Alan Arfa	George Mayer
Pam Berlin & Billy Carden	Alexandra Gersten & John Vassilaros	Max Mayer	Neil Mazzella
Myrna & Barry Bernard	Jenny Gersten & Willie Reale	Gene & Mary Ann McCoy	James & Hannelore McDaniel
Andre Bishop & Peter Manning	Jillian Gersten	Audrey & Danny Meyer	Frances McDormand & Joel Coen
Eleanor & Gerard Bissinger	Lloyd & Kitty Gilmour	Andy Millon	Amy Merrill
Lewis Black	MacEllis Glass & Martha Friedricks	Lawrence Motola	Brian Mertes
Susan Black	Jessica Glass Pollack	Patricia M. Murphy, Esq. & Adam Spilka	Audrey & Danny Meyer
Laura Blanco	Stephen & Cathy Graham	Curt & Leslie Myers	Andy Millon
Robi & Ruth Blumenstein	Michael Greif	Fred Nelson & Elizabeth Warner	Lawrence Motola
Dr. & Mrs. John Bock	Emily Grishman & Susan Sampliner	Pam Nelson & Peter Fritschel	Patricia M. Murphy, Esq. & Adam Spilka
Cristina Botta & James Singleton	Lisa Gugenheim	Randy & Rona Nelson	Curt & Leslie Myers
Buzz Bovshow	Eileen Guggenheim	Ruth Nelson	Fred Nelson & Elizabeth Warner
Julie Boyd	Mindy & Nicholas Guzzone	James Neuberger & Helen Stambler	Pam Nelson & Peter Fritschel
Samuel & Bertha Britt	Marlaina Deppe & Richard Hadar	Peter Neufeld	Randy & Rona Nelson
Catherine Brophy	David & Diane Hart	Renee Neuwald	Ruth Nelson
Becky Browder & Ted Neustadt	Jane & Jonathan Heine	Jim Neuwirth	James Neuberger & Helen Stambler
Susan Bruce & Peter Hedges	Cheryl Henson	Paul Newman & Joanne Woodward	Peter Neufeld
Henry Buhl	Peter Herdrich & Karen Trott	Mr. & Mrs. C.J. Nolan	Renee Neuwald
Chris Bundy & Meg Grosswendt	David Hidalgo	Maria Norman	Jim Neuwirth
Kate Burton & Michael Ritchie	Jane Hoffman	Kevin O'Rourke & Edith Thurber	Paul Newman & Joanne Woodward
Cora Cahan & Bernard Gersten	Willy Holtzman & Sylvia Shepard	Carol Ochs & Bruce MacVittie	Mr. & Mrs. C.J. Nolan
Steven Callahan & Christine Dunn	Barbara Howard	Jacki Ochs & Jan Kroeze	Maria Norman
Tom Carrozza	Bette & Richard Hyman	Steve Olsen	Kevin O'Rourke & Edith Thurber
Rosanne Cash & John Leventhal	Ronwyn Ingraham	John Paris	Carol Ochs & Bruce MacVittie
Mr. & Mrs. Richard Cashin	Dana Ivey	Arthur & Peggy Penn	Jacki Ochs & Jan Kroeze
Phoebe Cates & Kevin Kline	Allison Jacobs	Bat-Sheva & Thomas Peters	Steve Olsen
Henry & Kathy Chalfant	Sy Jacobs	Elise Pettus & Daniel Algrant	John Paris
Stockard Channing	Joanne Jacobson	Ethan Phillips	Arthur & Peggy Penn
Rachel Chanoff	Peter Jacobson & Whitney Scott	Robert & Sue Phillips	Bat-Sheva & Thomas Peters
Ellen Chenoweth	Daniel Jenkins & Kathy Hiler	Oliver Platt & Camilla Campbell Platt	Elise Pettus & Daniel Algrant
Glenda Chesshir	Hope Jessup	Richard Polatchek	Ethan Phillips
Marissa Chibas & Travis Preston	Andrea Johnson	Jeremy Posner	Robert & Sue Phillips
Ethan Coen & Trish Cooke	Larry & Mary Jones	Dean Potashner	Oliver Platt & Camilla Campbell Platt
Ruth Cohen	Betty & George Kaiser	Christopher Randolph	Richard Polatchek
Richard Cohn	Lee Kalcheim & Julia Lord	Peter & Helen Randolph	Jeremy Posner
David Copeland	Lucy Kaplan	Nancy King & Thomas Bingham Ray, 11	Dean Potashner
Thomas Cott	Ronald J. Kastner	Janet Reich & Bart Elsback	Christopher Randolph
Margaret Crimmins & Pierce Rafferty	Mark Keoppen & Wendy Townsend	Jacquelyn Reingold	Peter & Helen Randolph
Joan Straus Cullman	William Dafoe & Liz Leconte	Denise Rich	Nancy King & Thomas Bingham Ray, 11
Arthur Dantchik	Beth & Seth Klarman	Todd Richter & Donna Plummer	Janet Reich & Bart Elsback
Peter & Judith Dawkins	Alan & Kathryn Klingenstein		Jacquelyn Reingold
Thomas Deierlein	Mary Kong		Denise Rich
William & Donna DeSeta	David Kuhn		Todd Richter & Donna Plummer
Mr. & Ms. DiRugieris	Judy Kuhn & David Schwab		
Sue Drury	Belle & Roger Kuhn		
Christopher & Karen Eddowes	Carol Langstaff		
Mario Egozi	Jill Larson		

The 52nd Street Project presents:

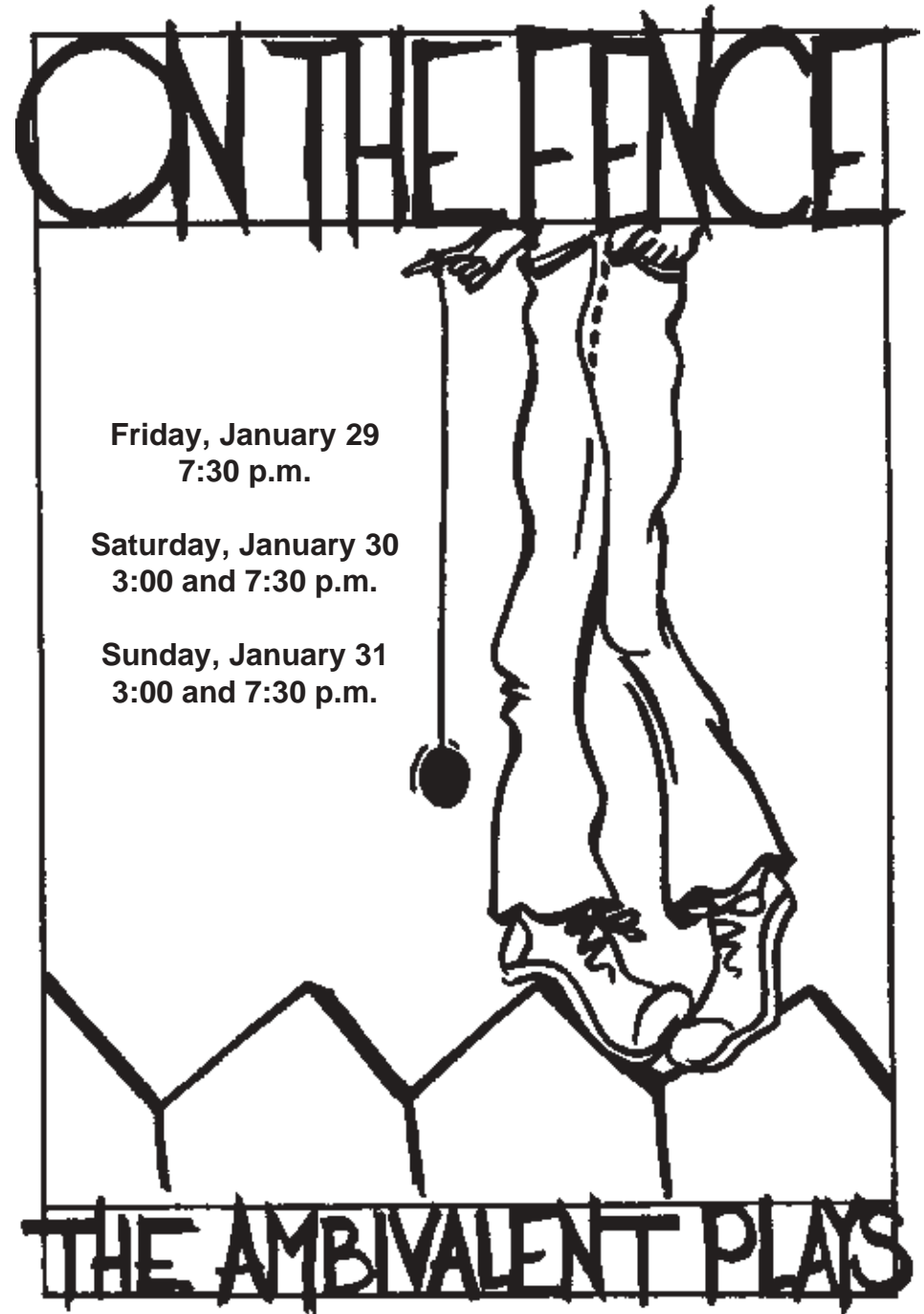

**Friday, July 29  
7:30 p.m.**

**Saturday, January 30  
3:00 and 7:30 p.m.**

**Sunday, January 31  
3:00 and 7:30 p.m.**

**The 1999 Two-On-Twos**

**The Women's Interart Annex, 500 West 52nd St., New York City**

# ON THE FENCE

## THE AMBIVALENT PLAYS



### Project Staff

Gus Rogerson, Artistic Director  
Carol Ochs, Executive Director  
Michael Bernard, Associate Artistic Director  
John Sheehy, Director of Development and Marketing  
George Roman Babiak, Production Manager  
Julie Feldman, Director of Education  
Iris A. Brown, Graphic Designer  
“Sting” Ray Ocasio and “Manta” Ray Harold, Receptionists  
Jeremy Seymour and Annette Metzger-Goehlert, Interns

### Production Staff

Patrick Barnes, Composer  
Kevin Joseph Roach, Set Designer  
Lighting Designers:  
Greg MacPherson & Matt Staniec  
Costume Designer:  
Elizabeth Hope Clancy  
Dan Carlson, Sound Designer  
Robin C. Gillette, Stage Manager  
Slide Designers:  
Renato Castilho & Erick Kuo  
Colorform Designers:  
Sarah Hokanson, Katie Dominguez  
and some of their friends  
Foamcore Prop Design Team:  
Annika Ahlstrom, George Babiak, Jeffrey  
Borkin, Kate Chaston, Scott Emery,  
Katherine Freedman, Esther Geller,  
Stacey Linden, Cara Marcous, Katie  
McIntyre, Jeremy Seymour, John  
Sheehy, Laura S. Wilson and Kari Cane  
Slide Operator: Annette Metzger-Goulart

Furniture Crew:  
Jeremy Seymour, Thomas Santoni  
Prop Crew:  
Elizabeth Timperman, Zsuzsa Mysak  
Colorformists:  
Tessa John-Connor, Alex Metzler  
House Managers:  
Susan McGinnis, Karin Schall, &  
Carol Cate  
Load-in & Light Hang Crew:  
Jeremy Seymour, Annette Metzger-  
Goulart, Edelen McMurray, Michele  
Mullins  
Away Chefs:  
Karin Schall & Mary Pat Walsh  
On The Fence Illustration:  
Esther Geller  
Root Beer Float Servers: “Sting” Ray  
Ocasio and “Manta” Ray Harold,  
Jenny Gersten, Willie Reale,  
Julie Feldman, Kari Cane

PROGRAM LAYOUT: GEORGE BABIAK

The 52nd Street Project is a non-profit organization that brings inner-city children from the Clinton neighborhood together with professional theater artists to create theater. **ON THE FENCE** is part of our Two-On-Two program, in which two of the Project's more seasoned kids are matched with two adult Project volunteers (one playwright, one director) and given the task of creating a short play. Each year, the duos travel *en masse* to Dutchess County, New York to rehearse the plays over a three-day weekend. This show is the fruit of their labors.

### The 52nd Street Project Board of Directors

Ben Barenholtz	Frances McDormand, <i>chairperson</i>
Lisa Benavides	Patricia M. Murphy, Esq.
Rachel Chanoff	Carol Ochs
Ruth Cohen	Willie Reale
Heidi Ettinger	Gus Rogerson
Wendy Ettinger, <i>chair emeritus</i>	José Soto, Jr., <i>alumni boardmember</i>
Louis P. Friedman	Pamala Tyson
Stephen Graham	Laura Valeroso
Larry Jones	Wendy vanden Heuvel
James McDaniel	Elizabeth Williams

### Special Thanks To...

...our friends Margot, Ronnie, Paul and the Women's Interart for donating the use of their performance space; Maria Tucci, Terry Fitzpatrick and Stephen Perpeluk, and Wendy Ettinger and Derek McLane for letting us stay in their homes during our weekend away; Mary Moore and D'Agostino's for the ice cream in the floats tonight; Ron Fiorina and Boylan's Bottling Co. for the soda that we poured onto the ice cream; Sonny's Grocery for storing the ice cream; Sheila Kehoe for helping us out with costumes at the 11th hour; and, finally, Vanessa Valdes for her sound advice.

### In-Kind Contributions:

Curt, Jamie, Eliza, Christine, and all the staff at Ensemble Studio Theatre; Primary Stages; Colorforms; Neil A. Mazzella & Hudson Scenic Studios, Inc.; Shays & Murphy; Iris A. Brown & Bernhardt/Fudyma Design Group; Ron Kastner, Capital Printing; Masque Sound; New Dramatists; Steve Olsen & The West Bank Cafe; Materials for the Arts; Port Authority; Mayor's Office of Film & Television; John A. Vassilaros & Son; Paris Chocolates; Scholastic Productions; Coleman, Inc.; Watkins Products; Eric Karpeles & Mike Sell; Bill Muddyman and the Chateau de Berne; Ronald C. Fiorina and Boylan's Bottling Company; BMG; John Steward; Paul Saylor and The Commonwealth Brewing Company; David Sneddon and Fairway Market; and Andy Millon.



The Two-On-Two Program is made possible with public funds from the National Endowment for the Arts, New York State Council on the Arts, a state agency, the Department of Youth and Community Development, the New York City Department of Cultural Affairs, and the office of the President of the Borough of Manhattan.



Don't miss our upcoming shows!

# GO FIGURE

The Inventive Plays



March 19, 20, & 21

at The Ensemble Studio Theatre

549 West 52nd St., between 10th and 11th Avenues

This month, our next batch of newcomers began the 8-week Playmaking program. At the end of the class they will be whisked away to Pennsylvania for a weekend to fashion a set of plays. The only thing they need: an audience.

It's The 52nd Street Project's Annual Benefit!

Monday,  
May 3, 1999  
The Puck Building

☆  
Co-chairs:  
Stan and Ollie

(i.e., Stanley Tucci  
and Oliver Platt)

☆  
For information call  
John Sheehy at  
(212) 333-5252.

## Cool Stuff ON SALE IN THE LOBBY

The Fabulous Flyer Bar (in five flavors)

\$2.00 and \$1.50 (\$1.00 for kids)

And featuring Shel Silverstein's "Fivey and Twoey" logo:

Project T-Shirts (Short sleeve) — \$12.00

Project T-Shirts (Long sleeve) — \$15.00

Project Caps — \$15.00

Thank you for coming to **On The Fence: The Ambivalent Plays**. If you are not on our mailing list (or if your address has changed), please fill out this form and give it to us on your way out or mail it to the address below. We would also like to know if you are interested in becoming a volunteer. We need help in **all areas**, so please fill out your name and phone number, and we'll call you.

**PLEASE ADD ME TO YOUR MAILING LIST:**

1/99

NAME \_\_\_\_\_

ADDRESS \_\_\_\_\_

ZIP \_\_\_\_\_

HOMEPHONE \_\_\_\_\_

DAYTIME PHONE \_\_\_\_\_

**YES, I WOULD LIKE TO BE OF HELP. I CAN:**

- |   |   |  |
|---|---|--|
| <input type="checkbox"/> Help load in and out for shows | <input type="checkbox"/> Draw and/or paint  | <input type="checkbox"/> Help kids with homework |
| <input type="checkbox"/> Hang lights                    | <input type="checkbox"/> Help with mailings | <input type="checkbox"/> Teach kids a skill      |
| <input type="checkbox"/> Work on a backstage crew       | <input type="checkbox"/> Do office work     | <input type="checkbox"/> Be a chef at an event   |
| <input type="checkbox"/> Other (please specify) _____   |   |  |

**MY SCHEDULE IS:**

- Very flexible. I'm often available during weekdays.  
 Somewhat flexible. I can help on the occasional morning or afternoon during the week.  
 Not very flexible at all, but I've got some free time on evenings and weekends.

If you would like to mail this (and you're always welcome to enclose a tax-deductible contribution), you can send it to: The 52nd Street Project, 500 West 52nd St. New York, NY 10019. Or fax it to (212) 333-5598.

## On The Fence! The Ambivalent Plays: ACT I

All original music composed by Patrick Barnes

### The Kid's Network

Written by Tim Meadows  
Directed by Eris Migliorini

Jaysunn Rosado ..... Himself  
Kevin Hartwick ..... Himself  
Announcer ..... Eris Migliorini  
TV theme singers ..... Patrick Barnes, Holly Nedal  
*My Secret*, lyrics by Tim Meadows

### Azy and Bzy

Written by Leslie Lyles  
Directed by Denise Burse

Azy ..... Edith Berkonti  
Bzy ..... Natalie Musteata  
Mother 1 ..... Elizabeth Timperman  
Mother 2 ..... Tessa John-Connor  
Helen Wiseapple ..... John L. Sheehy  
*Twins*, lyrics by Leslie Lyles

### Not Just Clowning Around

Written by Mo Rocca  
Directed by Ashby Semple

Doctor Mimi Soto ..... Gloria Trejo  
Kelvin Clooney ..... Alex Cooper  
*Be An Evil Clown*, lyrics by Mo Rocca

👉 I N T E R M I S S I O N 👈

## ACT II

### Which and/or A Tale of Two Souls

Written by Neena Beber  
Directed by Kate Ryan

Sarah Sue ..... Lorraine Lopez  
Sylvestra ..... Isha Rodriguez  
*The Decision Song*, lyrics by Neena Beber

### A Little Help

Written by Keith Glover  
Directed by Stephen Haff

She ..... Lorraine Zambrano  
He ..... Michael Castro  
Other Students ..... Zsuzsa Mysak, Thomas Santoni  
Tessa John-Connor, Alex Metzler

*It's In The Can*, lyrics by Willie Reale

### Ice Station Zelda

Written by Michael Bernard  
Directed by Joe White

Professor Fluegenbottom ..... Peter Ventura  
The Yeti ..... Carl Moon  
*The Yeti's Lament* and *Pop Song*, lyrics by Michael Bernard





The 52nd Street Project gratefully acknowledges the support of the following foundations and corporations: American Movie Classics; Anonymous; Barker Welfare Foundation, The Blythmour Corporation, Bertelsmann's World of Expression Foundation, Brillstein-Grey Motion Pictures, BT Foundation, Chase Manhattan Foundation, Colgate Inner City Fund, Consolidated Edison, Creative Artists Agency, Crown Equipment Corporation, Cubic B's, The Dammann Fund, The Dramatists Guild Fund, Dramatists Play Service, The Jean & Louis Dreyfus Foundation, Educational Foundation of America, EPIC, Fairway Market, Ford Foundation, The Fan Fox & Leslie R. Samuels Foundation, Gap Inc., GLADPZ Foundation, The Hennessy Foundation, Horace W. Goldsmith Foundation, Hambrecht & Quist, Hudson Scenic Studios, IBM International Foundation, In-Style Magazine, Rita J. and Stanley H. Kaplan Foundation, Lloyds Bank, James A. Macdonald Foundation, Ann M. Martin Foundation, MCJ Foundation, J.P. Morgan Charitable Trust, Morgan Stanley Dean Witter Foundation, William Morris Agency, Inc., Mosaic Entertainment, Newman's Own, New World Foundation, The New York Times Company Foundation, O'Grady Family Foundation, Laura Pels Foundation, Pew Charitable Trust, Polygram Filmed Entertainment, President's Committee on the Arts and the Humanities, RJM Group, Sauce Entertainment, The Scherman Foundation, Schulte Roth & Zabel, Seth Sprague Educational & Charitable Foundation, Sound One Corporation, Staging and Design, Inc., The Harold & Miri Steinberg Charitable Trust, The Sulzberger Foundation, Sundance Channel LLC, The Surdna Foundation, Susquehanna, Technicolor Film Services, Travelers Foundation, United Talent Agency, Inc., John A. Vassilaros & Sons, Inc., I. Weiss & Sons, Inc., Wiener Family Foundation, Wind Dancer Production Group, Yorke Construction Corporation. In addition, the following individuals made gifts of over \$150 to The 52nd Street Project this year (list current as of 1/27/99):

Jace Alexander  
Franco Aller  
May Ameen  
Cecilia Arana-Grant  
Lucie Arnaz & Laurence Luckinbill  
June Ballinger & Michael Goldstein  
Jeremy Barber  
Stephanie Barber & Arthur Collins  
Mr. & Mrs. John Barbis  
Ben Barenholtz  
Jessica Bauman  
Laurie Becker & Rick Sweren  
Lisa Belzberg  
Lisa Benavides & Tim Nelson  
Jamie Bennett  
Kitty & Nicholas Benton  
Pam Berlin & Billy Carden  
Myrna & Barry Bernard  
Andre Bishop & Peter Manning  
Eleanor & Gerard Bissinger  
Lewis Black  
Susan Black  
Laura Blanco  
Robi & Ruth Blumenstein  
Dr. & Mrs. John Bock  
Cristina Botta & James Singleton  
Buzz Bovshow  
Julie Boyd  
Samuel & Bertha Britt  
Catherine Brophy  
Becky Browder & Ted Neustadt  
Susan Bruce & Peter Hedges  
Henry Buhl  
Chris Bundy & Meg Grosswendt  
Kate Burton & Michael Ritchie  
Cora Cahan & Bernard Gersten  
Steven Callahan & Christine Dunn  
Tom Carrozza  
Rosanne Cash & John Leventhal  
Mr. & Mrs. Richard Cashin  
Phoebe Cates & Kevin Kline  
Henry & Kathy Chalfant  
Stockard Channing  
Rachel Chanoff  
Ellen Chenoweth  
Glenda Chesshir  
Marissa Chibas & Travis Preston  
Ethan Coen & Trish Cooke  
Ruth Cohen  
Richard Cohn  
David Copeland  
Thomas Cott  
Margaret Crimmins & Pierce Rafferty  
Joan Straus Cullman  
Willem Dafoe & Liz Leconte  
Arthur Dantchik  
Peter & Judith Dawkins  
Thomas Deierlein  
William & Donna DeSeta  
Mr. & Ms. DiRugeri  
Sue Drury  
Christopher & Karen Eddowes  
Mario Egozi

Ned Eisenberg  
Jacquelyn Elfert  
Barbara Ettinger  
Heidi Ettinger  
Wendy Ettinger & Derek McLane  
Peter Jay Fernandez &  
Denise Burse  
Eugene Fierman  
Katherine Foster  
David Frankel  
Richard Frankel & Kathleen Clark  
Naomi Freundlich & Charles Miles  
Lois Fricke & Todd Hollander  
Louis & Patrice Friedman  
Victor Garber  
Judith Garson & Steven Rappoport  
M. Rose Gasner & Larry Chertoff  
Alexandra Gersten & John Vassilaros  
Jenny Gersten & Willie Reale  
Jillian Gersten  
Lloyd & Kitty Gilmour  
MacEllis Glass & Martha Friedricks  
Jessica Glass Pollack  
Stephen & Cathy Graham  
Michael Greif  
Emily Grishman & Susan Sampliner  
Lisa Gugenheim  
Eileen Guggenheim  
Mindy & Nicholas Guzzone  
Marlaina Deppe & Richard Hadar  
David & Diane Hart  
Jane & Jonathan Heine  
Cheryl Henson  
Peter Herdrich & Karen Trott  
David Hidalgo  
Jane Hoffman  
Willy Holtzman & Sylvia Shepard  
Barbara Howard  
Bette & Richard Hyman  
Ronwyn Ingraham  
Dana Ivey  
Allison Jacobs  
Sy Jacobs  
Joanne Jacobson  
Peter Jacobson & Whitney Scott  
Daniel Jenkins & Kathy Hiler  
Hope Jessup  
Andrea Johnson  
Larry & Mary Jones  
Betty & George Kaiser  
Lee Kalcheim & Julia Lord  
Lucy Kaplan  
Ronald J. Kastner  
Mark Keoppen & Wendy Townsend  
Richard Kirshenbaum  
Beth & Seth Klarman  
Alan & Kathryn Klingenstein  
Mary Kong  
David Kuhn  
Judy Kuhn & David Schwab  
Belle & Roger Kuhn  
Carol Langstaff  
Jill Larson

Kate Lear & Jonathan LaPook  
Mickey Lemle  
Jane Bodle & Mitchell Lemsky  
Dell Lemmon  
Robert Sean Leonard  
Carol & Jerry Levin  
Anna Li  
John Bedford Lloyd & Anne Twomey  
Marjorie Loggia  
Andrew Louca  
Katherine Lumb and Joseph Vitale  
John Lyons  
Greg MacPherson & Jane Perlmutter  
Roma Maffia  
Donald Margulies & Lynn Street  
Kay Matschullat & Alan Arfa  
George Mayer  
Max Mayer  
Neil Mazzella  
Gene & Mary Ann McCoy  
James & Hannelore McDaniel  
Frances McDormand & Joel Coen  
Jessica Glass Pollack  
Brian Mertes  
Audrey & Danny Meyer  
Andy Millon  
Lawrence Motola  
Patricia M. Murphy, Esq. &  
Adam Spilka  
Curt & Leslie Myers  
Fred Nelson & Elizabeth Warner  
Pam Nelson & Peter Fritschel  
Randy & Rona Nelson  
Ruth Nelson  
James Neuberger & Helen Stambler  
Peter Neufeld  
Renee Neuwald  
Jim Neuwirth  
Paul Newman & Joanne Woodward  
Mr. & Mrs. C.J. Nolan  
Maria Norman  
Kevin O'Rourke & Edith Thurber  
Carol Ochs & Bruce MacVittie  
Jacki Ochs & Jan Kroeze  
Steve Olsen  
John Paris  
Arthur & Peggy Penn  
Bat-Sheva & Thomas Peters  
Elise Pettus & Daniel Algrant  
Ethan Phillips  
Robert & Sue Phillips  
Lucy Kaplan  
Richard Polatchek  
Jeremy Posner  
Richard Kirshenbaum  
Christopher Randolph  
Peter & Helen Randolph  
Nancy King &  
Thomas Bingham Ray, 11  
Janet Reich & Bart Esbach  
Jacquelyn Reingold  
Denise Rich  
Todd Richter & Donna Plummer

Hearld & Linda Ritch  
Jill Robbins  
Ricki Roer  
David Rosenberg  
Betsy & Clifford Ross  
Martha Roth & Bill Irwin  
Donald Rothschild &  
Lottchen Shivers  
Daniel & Janice Rous  
John Gould Rubin  
James & Judy Russek  
Lawrence Russo  
Steve Sabba  
Tim Sanford & Lisa Finstrom  
John Sayles & Maggie Renzi  
Karin & Tom Schall  
Leslie Schine & Nils Nilsen  
Mr. & Mrs. Stephen A. Schwarzman  
Campbell Scott  
Stefan Selig  
Mitchell Semel & Colleen Carroll  
Bernice Baruch Shawl  
Allen & Joan Shore  
Brian Sberell & Patty Dryden  
Jan Sidebotham & Tim Emerson  
Mark Singer & Darcy Dunn  
Heath & Landon Slane  
Ken Smith & Cyd Tomack  
Lois Smith  
David Sneddon & Kristine Fleisher  
Abigail Rose Solomon  
Jeff Stafford  
Jean Stein  
Fisher Stevens  
Cynthia Stivers  
Susanna Styron & Darrell Larson  
Stephen Sultan  
Daniel Sweet  
Mariko Tada  
Mary Lou Teel & Peter Freundlich  
Lynne Thigpen & Larry Aronson  
Marisa Tomei  
Judith Tygard & Mitch Weitzner  
Laura Valeroso & David Seidman  
Fred Van Natta & Michael Post  
Wendy vanden Heuvel  
Susan Vitucci  
Mary Pat Walsh  
Borah & Mildred Walton  
Robyn Watts  
Anita Waxman  
Lenny & Sally Weiss  
Gregory Welch  
Jane Bolster & Steve Wertimer  
Jenny Wiener  
Michael & Zena Wiener  
Robert Wiener  
Max & Barbara Wilk  
Elizabeth Williams & Joseph Forte  
Matt Williams & Angelina Fiordellisi  
Bill Wrubel  
Jeffrey & Janine Yass  
James & Mary Lin Yoshimura

The 52nd Street Project presents

# GO FIGURE



**The Winter, 1999 Playmaking Series**  
Fri., March 26 at 7:30 p.m., Sat., March 27 at 3:00 and 7:30 p.m.  
Sun., March 28 at 3:00 p.m.  
*The Ensemble Studio Theatre, 549 West 52nd Street*

# GO FIGURE

The Inventive Plays

The  
Winter, 1999  
Playmaking  
Plays  
Mar. 26-28  
The Ensemble  
Studio Theatre

PROGRAM LAYOUT: GEORGE BABIAK

## Project Staff

Gus Rogerson, Artistic Director  
Carol Ochs, Executive Director  
Michael Bernard, Associate Artistic Director  
John Sheehy, Director of Development and Marketing  
George "X-acto" Babiak, Production Manager  
Julie Feldman, Director of Education  
Iris A. Brown, Graphic Designer  
"Sting" Ray Ocasio and "Manta" Ray Harold, Receptionists  
Annette Metzger-Goehlert, Intern

## Production Staff

Kevin Joseph Roach, Set Designer  
Greg MacPherson, Lighting Designer  
Katherine Roth, Costume Designer  
Dan Carlson, Sound Designer  
Rusty Magee, Composer  
Jenny Peek, Stage Manager  
Slide Designers:

Renato Castilho, Katherine Lumb,  
Tiana Manfred, John Steward,  
Alberta Testanero

## Colorform Designers:

Sarah Hokanson, Katie Dominguez

## Foamcore Prop Design Team:

George Babiak, Roi Babiak,  
Ursula Babiak, Matt Beisner,  
Heather Carnduff, Mona Lipson,  
Cara Marcous, Jenny Pollack,  
John Sheehy, Nadette Stasa,  
Tim Steiner, Carrie Wilshusen

## Slide Operator:

Annette Metzger-Goehlert

## Furniture Crew:

"Manta" Ray Harold,  
Jayme "Spike-man" Rosado,  
Osage "Dreadhead" Lewis

## Prop Crew:

Kim Mack,  
Aisha "Deus Ex Machina" Jabour

## Colorform Crew:

Carey Kane,  
Vionel "The Sponge" Ortiz

## House Manager: Karin Schall

## House crew: Jane Bernard

## Load-in & Light Hang Crew:

Brad Aldus, Valerie Gotlib, Edelen  
McWilliams, Maureen Mulvany,  
Charlton Ruddock, Maury Schott,  
Cullen Wheeler, and the  
indefatigable Tom Schall

## Week-Away Chef: Eric Karpeles

## Go Figure Illustration:

Mike Sell

The **52nd Street Project** is a non-profit organization that brings children from the Hell's Kitchen/Clinton neighborhood together with professional theater artists. **Go Figure: The Inventive Plays** is part of our Playmaking program. Young people participate in an eight-week playwriting course taught by Michael Bernard and adapted for the Project by Daniel Judah Sklar from his book, *Playmaking: Children Writing and Performing Their Own Plays*. At the end of the course, each child is given two actors, a theme, and a dramaturg/director who guides him or her through the writing of a play during a weekend retreat in the country.

**Go Figure: The Inventive Plays** is the end result.

The Project is delighted to return to the Ensemble Studio Theatre, where we have been performing since our inception in 1981. We gratefully acknowledge the fact that if E.S.T. wasn't here, we'd be nowhere.

## The 52nd Street Project Board of Directors

Ben Barenholtz	Frances McDormand, <i>chairperson</i>
Lisa Benavides	Patricia M. Murphy, Esq.
Rachel Chanoff	Carol Ochs
Ruth Cohen	Willie Reale
Heidi Ettinger	Gus Rogerson
Wendy Ettinger, <i>chair emeritus</i>	José Soto, Jr., <i>alumni boardmember</i>
Louis P. Friedman	Pamala Tyson
Stephen Graham	Laura Valeroso
Larry Jones	Wendy vanden Heuvel
James McDaniel	Elizabeth Williams

## Special Thanks To:

Our friends Eric Karpeles and Mike Sell who hosted us for a weekend writer's retreat in Tyler Hill, Pennsylvania. We're also grateful to Liz Huntington and Dan Brinkerhoff, Mark Keoppen and Wendy Townsend, the Cobb family, Sohail Raikhy, the Pursch family, and Frank and Pat Stoeckle (and their marvelous parents) for billeting adults and children over the weekend.

## In-Kind Contributions:

Curt, Jamie, Eliza, Christine, and all the staff at Ensemble Studio Theatre; Primary Stages; Colorforms; Neil A. Mazzella & Hudson Scenic Studios, Inc.; Shays & Murphy; Iris A. Brown & Bernhardt/Fudyma Design Group; Ron Kastner, Capital Printing; Masque Sound; New Dramatists; Steve Olsen & The West Bank Cafe; Materials for the Arts; Port Authority; Mayor's Office of Film & Television; John A. Vassilaros & Son; Paris Chocolates; Scholastic Productions; Coleman, Inc.; Watkins Products; Eric Karpeles & Mike Sell; Bill Muddyman and the Chateau de Berne; Ronald C. Fiorina and Boylan's Bottling Company; BMG; John Steward; Paul Saylor and The Commonwealth Brewing Company; David Sneddon and Fairway Market; and Andy Millon.



The Playmaking Program is made possible with public funds from the National Endowment for the Arts, New York State Council on the Arts, a state agency, the Department of Youth and Community Development, the New York City Department of Cultural Affairs, and the office of the President of the Borough of Manhattan.



## Don't miss our upcoming shows

It's *The 52nd Street Project's Annual Benefit!*

Monday, May 3, 1999

The Puck Building



Co-chairs: Stan and Ollie  
(i.e., Stanley Tucci and Oliver Platt)



For information call John Sheehy at  
**(212) 333-5252.**

Sometime this summer (with luck!)...

# William Shakespeare's A Midsummer Night's Dream

...a special adaptation to be  
created and performed by the  
Teens of the 52nd Street Project



Coming July 27-August 1 and August 27-29

The Block Island, R.I. and Tyler Hill, Pa.

# ONE-on-ONES

A formula so simple you can prepare it in your own home:

1. Take a kid.
2. Assign an adult to write a play for the two of them to perform.
3. Multiply by 10.
4. Take all 10 pairs away for a week in the country to rehearse. Mix well.
5. Return to the city and pour entire batch into an empty theatre.
6. Garnish with foamcore.
7. Laugh, cry, and cheer.

You can do all this, or you can just come and watch the shows we produce.

## Cool Stuff ON SALE IN THE LOBBY

The Fabulous Flyer Bar (in five flavors)

\$2.00 and \$1.50 (\$1.00 for kids)

And featuring Shel Silverstein's "Fivey and Twoey" logo:

Project T-Shirts (Short sleeve) — \$12.00

Project T-Shirts (Long sleeve) — \$15.00

Project Caps — \$15.00

Thank you for coming to **Go Figure! The Inventive Plays**. If you are not on our mailing list (or if your address has changed), please fill out this form and give it to us on your way out or mail it to the address below. We would also like to know if you are interested in becoming a volunteer. We need help in **all areas**, so please fill out your name and phone number, and we'll call you.

### PLEASE ADD ME TO YOUR MAILING LIST:

NAME \_\_\_\_\_

ADDRESS \_\_\_\_\_

ZIP \_\_\_\_\_

HOMEPHONE \_\_\_\_\_

DAYTIME PHONE \_\_\_\_\_

### YES, I WOULD LIKE TO BE OF HELP. I CAN:

- |   |   |  |
|---|---|--|
| <input type="checkbox"/> Help load in and out for shows | <input type="checkbox"/> Draw and/or paint  | <input type="checkbox"/> Help kids with homework |
| <input type="checkbox"/> Hang lights                    | <input type="checkbox"/> Help with mailings | <input type="checkbox"/> Teach kids a skill      |
| <input type="checkbox"/> Work on a backstage crew       | <input type="checkbox"/> Do office work     | <input type="checkbox"/> Be a chef at an event   |
| <input type="checkbox"/> Other (please specify) _____   |   |  |

### MY SCHEDULE IS:

- Very flexible. I'm often available during weekdays.  
 Somewhat flexible. I can help on the occasional morning or afternoon during the week.  
 Not very flexible at all, but I've got some free time on evenings and weekends.

If you would like to mail this (and you're always welcome to enclose a tax-deductible contribution), you can send it to: The 52nd Street Project, 500 West 52nd St. New York, NY 10019. Or fax it to (212) 333-5598.

## Go Figure: The Inventive Plays: ACT I

### Alien Search

Written by Kathy Tavares, age 10

Dramaturg: Julie Boyd Director: Moira Driscoll

Samantha ..... Angie Phillips  
Zack ..... Josh Lewis  
The Man ..... John Sheehy  
A Waitress ..... Aisha Jabour

### The Giraffe and the Tree

Written by Alejandra Rodriguez, age 13

Dramaturg/Director: Connie Grappo

Spotty, a giraffe ..... Melissa Murray  
Green, a tree ..... Sandra Santiago  
Lion, a lion ..... Larry Nathanson

### Lonely

Written by Matthew Gonzalez, age 10

Dramaturg/Director: Michael Potts

John ..... Michael Stuhlbarg  
Liz ..... Melody Cooper  
Fred ..... Melody Cooper

### Mean Pack vs. Juronka

Written by Tiffany Butler, age 11

Dramaturg/Director: Gus Rogerson

Juronka ..... Teagle Bougere  
Mean Pack ..... Jill Larson  
Voice of Susie ..... Aisha Jabour  
Juronka's Father's Men ..... Jayme Rosado, Ray Harold,  
Osage Lewis

### A Project For School

Written by Jonathan Torres, age 10

Dramaturg/Director: Michael Bernard

Danny ..... Billy Crudup  
JoJo ..... Joe Quintero  
The Teacher ..... George Babiak

## Go Figure: The Inventive Plays: ACT II

### World Series

Written by Steve Bula, age 13

Dramaturg/Director: Liz Tuccillo

Steve Williams ..... William Christian  
Whitney White ..... Phyllis Somerville  
Coach ..... Michael Potts  
Umpire/Announcer ..... Ray Harold

*"Highlights of the Game"* lyrics by Steve Bula, original music composed by Rusty Magee

### Top Secret

Written by Nadya Jabour, age 10

Dramaturg/Director: Eduardo Andino

Simon ..... Randy Sklar  
Winkerbell ..... Vanessa Aspillaga

### The New Girl

Written by Felicita Jerez, age 13

Dramaturg: Evan Handler Director: Mary Pat Walsh

Karen ..... Karen Trott  
Susana ..... Lynn Cohen  
Karen's Mom ..... Phyllis Somerville  
The Principal ..... Michael Potts

### The Portal

Written by Joshua Brown, age 10

Dramaturg/Director: George Babiak

Professor Tito ..... Yusef Bulos  
Professor Eric ..... Akili Prince  
The Aliens ..... The Crew

### The Tragedy With The Girl and Her Mom

Written by Allary Seda, age 12

Dramaturg/Director: Tamara Jenkins

Sara ..... Gwendolyn Mulamba  
Her Mom ..... Larry Nathanson  
A doctor ..... Michael Bernard  
Two cops ..... Ray Harold, Jayme Rosado  
A Cow ..... Larry Nathanson

**The 52nd Street Project Teen Ensemble** is a two-year program for graduates of The Project's writing and acting classes. The Teen Ensemble focuses on advanced acting technique by using both original and existing texts. The culmination of the program is the performance of a play by William Shakespeare as seen through the eyes of the kids in the class. The last teen production, ***What You Will*** or ***Twelfth Night*** (June, 1997), was performed at the **Chateau de Berne** arts center in the town of Lorgues in Provence, France. The teens you are seeing tonight will create and perform their show this summer and bring the production to France in the summer of 2000.

### The Project Staff

Gus Rogerson ..... Artistic Director  
 Carol Ochs ..... Executive Director  
 Michael Bernard ..... Associate Artistic Director  
 John Sheehy ..... Director of Development and Marketing  
 George Roman Babiak ..... Production Manager  
 Julie Feldman ..... Director of Education  
 Iris A. Brown ..... Graphic Designer  
 Ray Ocasio ..... Receptionist  
 Ray Harold ..... Receptionist  
 Annette Metzger-Goehlert ..... Intern

### The 52nd Street Project Board of Directors

Ben Barenholtz	Frances McDormand, <i>chairperson</i>
Lisa Benavides	Patricia M. Murphy, Esq.
Rachel Chanoff	Carol Ochs
Ruth Cohen	Willie Reale
Heidi Ettinger	Gus Rogerson
Wendy Ettinger,	José Soto, Jr.,
<i>chair emeritus</i>	<i>alumni boardmember</i>
Louis P. Friedman	Pamala Tyson
Stephen Graham	Laura Valeroso
Larry Jones	Wendy vanden Heuvel
James McDaniel	Elizabeth Williams

The 52nd Street Project would like to thank **Max Ferra**, **Patricia Miller**, **Jose Sanchez**, and everyone else at **INTAR**. We're also grateful to **Stephen Haff** and **New Dramatists** for their contribution of rehearsal space.

The 52nd Street Project presents



# Sonnet Scenes

Co-written by William Shakespeare  
 and the Teens of The 52nd Street Project

Saturday, March 13 at 7:30 pm

Sunday, Mar. 14 at 3:00 pm

at the INTAR theater

Funded in part by the Surdna Foundation

# Sonnet Scenes

## **No Longer Your Servant**

By Natasha Soto and William Shakespeare

Dramaturg/Director: Chris Ceraso

Natasha ..... Natasha Soto  
Justin ..... Ray Ocasio  
Coffee Man ..... Jed Clarke  
Joe the Cook ..... Ray Harold

## **Star Light, Star Bright**

By Jennifer Socarras and William Shakespeare

Dramaturg/Director: Michael Bernard

Jennifer ..... Jennifer Socarras  
Shivan ..... Natasha Soto  
Ferdinand ..... Eddie Zambrano  
The Devil ..... Jed Clarke  
Roy ..... Ray Ocasio  
Partygoers ..... The Company

## **To Marry or Not To Marry**

By Zsuzsa Mysak and William Shakespeare

Dramaturg: Camilia Sanes Director: Ashby Semple

Bud ..... Ray Ocasio  
Clifford ..... Eddie Zambrano  
Rupert ..... Ray Harold  
Reverend Jackie ..... Zsuzsa Mysak

## **Men Are Dogs, Women Are Dogs, Too**

By Eddie Zambrano and William Shakespeare

Dramaturg/Director: Larry Nathanson

Eddie ..... Eddie Zambrano  
Michelle ..... Jennifer Socarras  
The Jakes ..... Ray Harold and Ray Ocasio  
The Women ..... Annette Myrie and Natasha Soto

## **Sum It Up**

By Annette Myrie and William Shakespeare

Dramaturg/Director: Gus Rogerson

Alex ..... Jed Clarke  
Monica ..... Annette Myrie  
Jasmine ..... Zsuzsa Mysak

## **The Good Day**

By Ray Harold and William Shakespeare

Dramaturg/Director: Patricia Dunnock

Ray ..... Ray Harold  
Cliff ..... Jed Clarke  
Trisch ..... Natasha Soto  
Mother ..... Jennifer Socarras  
Father ..... Eddie Zambrano  
Phone Lady ..... Annette Myrie  
Michael ..... Ray Ocasio  
Ms. Buckman ..... Zsuzsa Mysak

## **Things You Do For Love**

By Ray Ocasio and William Shakespeare

Dramaturg/Director: Mitchell Lemsky

Jojo ..... Ray Ocasio  
Anne ..... Annette Myrie

## **Jesus' Press Conference**

By Jed Clarke and William Shakespeare

Dramaturg/Director: Jacquelyn Reingold

Jesus ..... Jed Clarke  
Mauretta Faye ..... Eddie Zambrano  
Jesus' Publicist ..... Ray Harold  
The Reporters ..... The Company



# EVERYONE'S A COMEDIAN

A BENEFIT FOR THE 52ND STREET PROJECT

MONDAY, MAY 3RD, 1999  
THE DUCK BUILDING

### BOARD CHAIR

Frances McDormand

### ARTISTIC DIRECTOR

Gus Rogerson

### EXECUTIVE DIRECTOR

Carol Ochs

## EVERYONE'S A COMEDIAN

### HONORARY CHAIRS

Oliver Platt and Stanley Tucci

### CO-CHAIRS

Lisa Benavides  
Becky Browder  
Louis P. Friedman  
Patrice Friedman  
Karin Schall  
Laura Valeroso  
Mary Pat Walsh

### THE BOARD OF DIRECTORS

Ben Barenholtz  
Lisa Benavides  
Rachel Chanoff  
Ruth Cohen  
Heidi Ettinger  
Wendy Ettinger,  
*chair emeritus*  
Louis P. Friedman  
Stephen Graham  
Larry Jones  
James McDaniel  
Frances McDormand,  
*chair*  
Patricia M. Murphy, Esq.  
Carol Ochs  
Willie Reale, *founder*  
Gus Rogerson  
Jose Soto, Jr.,  
*alumni boardmember*  
Pamala Tyson  
Laura Valeroso  
Wendy vanden Heuvel  
Elizabeth Williams

### THE 52ND STREET PROJECT GRATEFULLY ACKNOWLEDGES...

Stephanie Berger  
BMG Entertainment  
Iris Brown  
Capital Printing/Ron Kastner  
The Coleman Company,  
*a subsidiary of the Sunbeam corporation*  
Entertainment Weekly  
The Gap  
Hudson Scenic Studios  
Kiehl's Since 1851  
Masque Sound  
Noggin  
Paris Chocolates  
The Printing Store  
Seagram's Chateau & Estate Wines Co.  
Wendy Stulberg  
Time-Life Kids  
Vassilaros Coffee  
Watkins Incorporated  
*Healthier Living Since 1868*



### THE ADULT CAST

Lewis Black  
Roma Maffia  
Fisher Stevens  
Mary Testa  
and Oliver Platt as "Morton Bezzler"

### THE KID CAST

Peter Granados  
Vionel Ortiz  
Jaymaree Rosado  
Jayme Rosado  
Jonathan Torres  
Adrian Zambrano  
and Lorraine Zambrano as "Goldie"

### THE SONG

"We Carry A Torch for the Borscht Belt"

### DIRECTED BY

Mark Linn-Baker

### MUSIC COMPOSED AND PLAYED BY

Henry Krieger

### LYRICS BY

Willie Reale

### BOOK BY

Michael Bernard, Lewis Black,  
Becky Browder, and Willie Reale  
*featuring additional material appropriated from  
the great comic minds of yesteryear.*

### SET DESIGN

Kevin Joseph Roach

### LIGHTING DESIGN

Greg MacPherson

### COSTUME DESIGN

Crystal Thompson

### SOUND DESIGN

Tom Morse

### STAGE MANAGER

Hank Meiman

### RIM-SHOTS

Adam Felber

## KINGS OF COMEDY

Anonymous  
Arthur Dantchik  
Joanne Woodward & Paul Newman  
Jeffrey Yass

## NAMES IN LIGHTS

Entertainment Weekly  
Cathy and Stephen Graham  
Amy Irving  
Nicole Kidman & Tom Cruise  
The New World Foundation  
Jenny Wiener

## HEADLINERS

Lisa Belzberg  
Blaise Box, Staging & Design  
Kathleen & Henry Chalfant  
Comedy Central  
The Dawkins Family Foundation  
Patrice & Louis Friedman  
Alexandra Gersten-Vassilaros &  
Johnny Coffeeshoplis  
Lloyd's Bank  
Betsy MacIsaac & Robert Goldberg,  
Yorke Construction Corp.  
MCJ Foundation  
Nickelodeon  
Jane Perlmutter & Greg MacPherson  
Laura Valeroso & David Seidman

## STAND-UPS

Sondra & Franco Aller	Beth & Seth Klarman
Myrna & Barry Bernard	Loeb & Loeb
Elizabeth & Alexander Bernstein	John S. Lyons
Jane Bodle & Mitchell Lemsky	Roma Maffia
Deborah Brown	Liz Manne
Ruth Cohen & Josh Astrachan	Bette Midler
Stockard Channing	Beth & Ross Moore
Glenda Chesshir	Kathleen O'Grady
Noel Comess	Steve Olsen
Maddie Corman & Jace Alexander	Laura Pels Foundation
Catherine Corpeny & Max Mayer	Margo & Steve Peter
Ned Eisenberg	Shavi & Tom Peters
Wendy Ettinger & Derek McLane	Elise Pettus & Dan Algrant
Kristine Fleisher & David Sneddon	Tracy Pollan & Michael J. Fox
Naomi Freundlich & Charlie Miles	Jeremy Posner
Lois Fricke & Todd Hollander	Christopher Randolph
Michael Greif	Donna & Todd Richter
Emily Grishman & Susan Sampliner	C.C. & Geraldo Rivera
Hallmark, Inc.	Anita & David Rogerson
Heights Partners, Inc.	Steve Sabba
Jane & Jonathan Heine	Don Scardino
Dana Ivey	Bernice Baruch Shawl
Traci Paige Johnson & Bob Mowen	Lois Smith



Jean Stein  
Marjorie & John Tedesco  
Anne Twomey &  
John Bedford Lloyd  
Susan Vitucci  
Mary Pat Walsh

## SECOND BANANAS

May Ameen  
Janet Allen  
Tracy Allen  
Cecilia Arana  
June Ballinger & Michael Goldstein  
Talia Balsam & John Slattery  
Lisa Benavides & Tim Nelson  
Kenneth Bennett  
Dori Berinstein  
Stephen Bernstein  
Heidi Bettini & Stefan Selig  
Tessa Blake & Neal Lerner  
Jane Bolster & Steve Wertimer  
Becky Browder & Ted Neustadt  
Susan Bruce & Peter Hedges  
Michael Buchanan  
Denise Burse &  
Peter Jay Fernandez  
Cora Cahan & Bernard Gersten  
Laura Callahan & Romulus Linney  
Louisa Campbell & Sven Travis  
Colleen Carroll & Mitchell Semel  
Carol Cate  
Diana Cate  
Chris Ceraso  
Rachel Chanoff  
Matt Charlton  
Laurie & Peter Clancy  
Patricia Clarkson & Tommy White  
Stacy Cohen  
Lieta & Richard Cohn  
Penny Collins  
Helen R. Cook  
Thomas Cott  
Margaret Crimmins & Paul Hsu  
Georgia Delano  
Buddy Dikman & Chuck Davis  
Rebecca & Richard Dresser  
Julie Dretzin  
Jeane Drewsen  
Moiria Driscoll & David Pence  
Sue Drury  
Mario Egozi & Brian Milsap  
Beth Emelson  
Linda Ewing O'Connell  
Edie Falco  
Joan Fields  
Liz Fillo  
Hannah Finn & John Wiltshire  
Alexa L. Fogel  
Doreen Frumkin  
The Garson-Rappaport Family  
Rose Gasner & Larry Chertoff  
Kevin Geer  
Jenny Gersten & Willie Reale  
Jilian Cahan Gersten  
Ileen Getz & Mark Grinnell  
Nancy Giles

Mildred & Borah Walton  
Wendy Wasserstein  
Anita Waxman  
Elizabeth Williams &  
Joseph Forte  
Bill Wrubel

Judy Goldman & Michael Pillinger  
Fred Goldstein  
Paula Goldstein  
Vivian & George Gottlieb  
Connie Grappo & Lee Wilkof  
Stacey Greenwald  
Lisa J. Gugenheim  
Margot Harley & Lois Walden  
Jane Harmon  
Joy & Harry Henschel  
Jane Hoffman  
Lauren Howard  
Helen Stenborg Hughes &  
Barnard Hughes  
Michelle Hurst &  
Jeanne Foster  
Andrew Hurwitz  
David Hwang  
Annette Insdorf  
Amy Introcaso-Davis  
Joanne Jacobson  
Linda LeRoy Janklow  
Tom Jaycox  
Tamara Jenkins  
Amanda Johns  
Dante Kaba  
Marcy & Max Kahn  
Eric Karpeles & Mike Sell  
Jerry Kass  
Willie Katz  
Elise Konalian  
Judy Kuhn & David Schwab  
Nile Lanning & Warren Leight  
Cyndi Lee & David Nichtern  
Liza Lerner  
Becky & Steven Lewis  
Anna Li  
Gary Lippman  
Marjorie Loggia  
Julia Lord & Lee Kalcheim  
Steve Mancuso  
Mitchell G. Mandel  
Camryn Manheim  
Dave Marks  
Ali Marsh  
Kay Matschullat & Allan Arffa  
Chris McCann  
Brigid McCarthy  
Mary McCormack  
Barbara McCrane & Paul Reale  
Frances McDormand & Joel Coen  
Mead Paper Division  
Anne Meara & Jerry Stiller  
Andy Millon  
Drew Milstein  
Mala & Sham Mosher  
Suzen Murakoshi  
Patricia Murphy & Adam Spilka

Jane Musky & Tony Goldwyn  
Ricarda O'Conner & Michael Otavi  
Steven & Mabel O'Neill  
Sally Ann O'Reilly & Ben Barenholtz  
Jacki Ochs & Jan Kroeze  
Angie Phillips  
Susan Ochs Phillips  
Sheila & Nicholas Platt  
Martha Plimpton  
Leslie & Dean Potashner  
Michael Potts  
Helen & Peter Randolph  
Anthony Rapp & Josh Safron  
Jocelyn Rappaport  
Robert Reale  
Janice & T. Gorman Reilly  
Jacquelyn Reingold  
Minna Rose  
Stuart Rosenstein  
Martha Roth & Bill Irwin  
Crystal & Michael Sabatino  
Madeline & Richard Salzman  
Laura Sametz  
Camilia Sanes  
Jane Sangerman &  
Joseph Vadapalas  
Karin & Tom Schall  
Whitney Scott & Peter Jacobson  
Cynthia & Paul Scrudato  
Dana Segal  
Ashby Semple & Robert Semple

Juana Serra-Sans & Ken Smith  
Barry Shapiro  
Robert Shaffron & John Steber  
Sylvia Shepard & Willy Holtzman  
Lottchen Shivers &  
Donald Rothschild  
Leslie Simitch  
Meg Simon  
Jeannie Simpson & Adam Felber  
Stephanie Simpson &  
Larry Aeschlimann  
Dawn Spence & Kevin Anderson  
Frank Sposato  
Dana Stanley  
Ben Svetkey  
Daniel Swee  
Mariko Tada  
Tracy Thorne & Edmund Lewis  
Edith Thurber & Kevin O'Rourke  
Anne Torsigliere  
Angela Trento  
Raquel Tresvant  
Karen Trott & Peter Herdrich  
Liz Tuccillo  
Judith Tygard  
Wendy vanden Heuvel  
John Vassallo  
Robyn Watts & Nicholas Platt, Jr.  
Carol J. Whitesides  
Susan Willerman  
Frank Wood

List current as of 4/27/99

## PRODUCTION STAFF

### FOAMCORE DESIGN TEAM

George Babiak, Roi Babiak, Stephanie Borynack,  
Heather Carnduff, Connie Cocroft, Karen Gusdorf,  
Kate McCamy, Grace McCamy-Bonfiglio, Kevin Joseph Roach,  
Jonathan Villanueva, Laura S. Wilson

### VOLUNTEERS

Taro Alexander, Matt Beisner, William Christian, Jilly Crook,  
Liz Flahive, Lucas Fleischer, Susan McGinnis, Eris Migliorini,  
Robin Morse, Keira Naughton, Kim Sherman, Michael Stuhlberg,  
Vanessa Valdes, Ed Vassallo, Kim Wilson

### THE 52ND STREET PROJECT STAFF

Gus Rogerson, Artistic Director  
Carol Ochs, Executive Director  
Michael Bernard, Associate Artistic Director  
John Sheehy, Director of Development and Marketing  
George Babiak, Production Manager and Bingologist  
Julie Feldman, Director of Education

### SPECIAL THANKS

Noël Dawkins, Beth Emelson, Jenny Gersten,  
Barbara McCrane, Max Wilk



The 52nd Street Project gratefully acknowledges the support of the following foundations and corporations: Anonymous, Barker Welfare Foundation, The Blythmour Corporation, Bertelsmann's World of Expression Foundation, BT Foundation, Chase Manhattan Foundation, Colgate Inner City Fund, Consolidated Edison, Crown Equipment Corporation, Cubic B's, The Dammann Fund, The Dramatists Guild Fund, Dramatists Play Service, The Jean & Louis Dreyfus Foundation, Educational Foundation of America, EPIC, Fairway Market, Ford Foundation, The Fan Fox & Leslie R. Samuels Foundation, Gap Inc., GLADPZ Foundation, The Hennessy Foundation, Horace W. Goldsmith Foundation, Hambrecht & Quist, Hudson Scenic Studios, IBM International Foundation, Rita J. and Stanley H. Kaplan Foundation, Lloyds Bank, James A. Macdonald Foundation, Ann M. Martin Foundation, MCJ Foundation, J.P. Morgan Charitable Trust, Morgan Stanley Dean Witter Foundation, William Morris Agency, Inc., Mosaic Entertainment, Newman's Own, New World Foundation, The New York Times Company Foundation, O'Grady Family Foundation, Laura Pels Foundation, Pew Charitable Trust, President's Committee on the Arts and the Humanities, The Scherman Foundation, Sound One Corporation, Staging and Design, Inc., The Harold & Mimi Steinberg Charitable Trust, The Sulzberger Foundation, The Surdna Foundation, Susquehanna, Travelers Foundation, John A. Vassilaros & Sons, Inc., J. Weiss & Sons, Inc., Wiener Family Foundation, Yorke Construction Corporation. In addition, the following individuals made gifts of over \$150 to The 52nd Street Project this year (list current as of 7/28/99):

Jace Alexander & Maddie Corman  
 Franco Aller  
 May Ameen  
 Cecilia Arana-Grant  
 Lucie Arnaz & Laurence Luckinbill  
 June Ballinger & Michael Goldstein  
 Jeremy Barber  
 Stephanie Barber & Arthur Collins  
 Mr. & Mrs. John Barbis  
 Ben Barenholtz  
 Jessica Bauman  
 Laurie Becker & Rick Sweren  
 Lisa Belzberg  
 Lisa Benavides & Tim Nelson  
 Jamie Bennett  
 Kitty & Nicholas Benton  
 Pam Berlin & Billy Carden  
 Myrna & Barry Bernard  
 Andre Bishop & Peter Manning  
 Eleanor & Gerard Bissinger  
 Lewis Black  
 Susan Black  
 Laura Blanco  
 Robi & Ruth Blumenstein  
 Dr. & Mrs. John Bock  
 Cristina Botta & James Singleton  
 Buzz Bovshow  
 Julie Boyd  
 Samuel & Bertha Britt  
 Catherine Brophy  
 Becky Browder & Ted Neustadt  
 Susan Bruce & Peter Hedges  
 Henry Buhl  
 Chris Bundy & Meg Grosswendt  
 Kate Burton & Michael Ritchie  
 Cora Cahan & Bernard Gersten  
 Steven Callahan & Christine Dunn  
 Tom Carozza  
 Rosanne Cash & John Leventhal  
 Mr. & Mrs. Richard Cashin  
 Phoebe Cates & Kevin Kline  
 Henry & Kathy Chalfant  
 Stockard Channing  
 Rachel Chanoff  
 Ellen Chenoweth  
 Glenda Chesshir  
 Marissa Chibas & Travis Preston  
 Elhan Coen & Trish Cooke  
 Ruth Cohen  
 Richard Cohn  
 David Copeland  
 Thomas Cott  
 Margaret Crimmins & Pierce Rafferty  
 Joan Straus Cullman  
 Willem Dafoe & Liz Lecompte  
 Arthur Danchik  
 Peter & Judith Dawkins  
 Thomas Deierlein  
 William & Donna DeSeta  
 Mr. & Ms. DiRuggeris  
 Sue Drury  
 Christopher & Karen Eddowes  
 Mario Egozi  
 Ned Eisenberg

Jacquelyn Elfert  
 Barbara Ettinger  
 Heidi Ettinger  
 Wendy Ettinger & Derek McLane  
 Peter Jay Fernandez &  
 Denise Burse  
 Eugene Fierman  
 Katherine Foster  
 David Frankel  
 Richard Frankel & Kathleen Clark  
 Naomi Freundlich & Charles Miles  
 Lois Fricke & Todd Hollander  
 Louis & Patrice Friedman  
 Victor Garber  
 Judith Garson & Steven Rappoport  
 M. Rose Gasner & Larry Chertoff  
 Alexandra Gersten & John Vassilaros  
 Jenny Gersten & Willie Reale  
 Jilian Gersten  
 Lloyd & Kilty Gilmour  
 MacEllis Glass & Martha Friedricks  
 Jessica Glass Pollack  
 Stephen & Cathy Graham  
 Michael Greif  
 Emily Grishman & Susan Sampliner  
 Lisa Gugenheim  
 Eileen Guggenheim  
 Mindy & Nicholas Guzzone  
 Marlaina Deppe & Richard Hadar  
 David & Diane Hart  
 Jane & Jonathan Heine  
 Cheryl Henson  
 Peter Herdrich & Karen Trott  
 David Hidalgo  
 Jane Hoffman  
 Willy Holtzman & Sylvia Shepard  
 Barbara Howard  
 Bette & Richard Hyman  
 Ronwyn Ingraham  
 Dana Ivey  
 Allison Jacobs  
 Sy Jacobs  
 Joanne Jacobson  
 Peter Jacobson & Whitney Scott  
 Daniel Jenkins & Kathy Hiler  
 Hope Jessup  
 Andrea Johnson  
 Larry & Mary Jones  
 Betty & George Kaiser  
 Lee Kalcheim & Julia Lord  
 Lucy Kaplan  
 Ronald J. Kastner  
 Mark Keoppen & Wendy Townsend  
 Richard Kirshenbaum  
 Beth & Seth Klarman  
 Alan & Kathryn Klingenstein  
 Mary Kong  
 David Kuhn  
 Judy Kuhn & David Schwab  
 Belle & Roger Kuhn  
 Carol Langstaff  
 Jill Larson  
 Kate Lear & Jonathan LaPook  
 Mickey Lemle

Jane Bodle & Mitchell Lemsky  
 Dell Lemmon  
 Robert Sean Leonard  
 Carol & Jerry Levin  
 Anna Li  
 John Bedford Lloyd &  
 Anne Twomey  
 Marjorie Loggia  
 Andrew Louca  
 Katherine Lumb and Joseph Vitale  
 John Lyons  
 Greg MacPherson &  
 Jane Perlmutter  
 Roma Maffia  
 Donald Margulies & Lynn Street  
 Kay Matschullat & Alan Arffa  
 George Mayer  
 Max Mayer  
 Neil Mazzella  
 Gene & Mary Ann McCoy  
 James & Hannelore McDaniel  
 Frances McDormand & Joel Coen  
 Amy Merrill  
 Brian Mertes  
 Audrey & Danny Meyer  
 Andy Millon  
 Robin Morse & Gus Rogerson  
 Lawrence Motola  
 Patricia M. Murphy, Esq. &  
 Adam Spilka  
 Curt & Leslie Myers  
 Fred Nelson & Elizabeth Warner  
 Pam Nelson & Peter Fritschel  
 Randy & Rona Nelson  
 Ruth Nelson  
 James Neuberger & Helen Stambler  
 Peter Neufeld  
 Renee Neuwald  
 Jim Neuwirth  
 Paul Newman & Joanne Woodward  
 Mr. & Mrs. C.J. Nolan  
 Maria Norman  
 Kevin O'Rourke & Edith Thurber  
 Carol Ochs & Bruce MacVittie  
 Jacki Ochs & Jan Kroeze  
 Steve Olsen  
 John Paris  
 Arthur & Peggy Penn  
 Bat-Sheva & Thomas Peters  
 Elise Pettus & Daniel Algrant  
 Ethan Phillips  
 Robert & Sue Phillips  
 Oliver Platt & Camilla Campbell Platt  
 Richard Polatchek  
 Jeremy Posner  
 Dean Potashner  
 Christopher Randolph  
 Peter & Helen Randolph  
 Nancy King &  
 Thomas Bingham Ray, 11  
 Janet Reich & Bart Eysbach  
 Jacquelyn Reingold  
 Denise Rich  
 Todd Richter & Donna Plummer

Heard & Linda Ritch  
 Jill Robbins  
 Ricki Roer  
 David Rosenberg  
 Betsy & Clifford Ross  
 Martha Roth & Bill Irwin  
 Donald Rothschild &  
 Lotichen Shivers  
 Daniel & Janice Rous  
 John Gould Rubin  
 James & Judy Russek  
 Lawrence Russo  
 Steve Sabba  
 Tim Sanford & Lisa Finstrom  
 John Sayles & Maggie Renzi  
 Karin & Tom Schall  
 Leslie Schine & Nils Nilsen  
 Mr. & Mrs. Stephen A. Schwarzman  
 Campbell Scott  
 Stefan Selig  
 Mitchell Semel & Colleen Carroll  
 Bernice Baruch Shawl  
 Allen & Joan Shore  
 Brian Siberell & Patty Dryden  
 Jan Sidebotham & Tim Emerson  
 Mark Singer & Darcy Dunn  
 Heath & Landon Slane  
 Ken Smith & Cyd Tomack  
 Lois Smith  
 David Sneddon & Kristine Fleisher  
 Abigail Rose Solomon  
 Jeff Stafford  
 Jean Stein  
 Fisher Stevens  
 Cynthia Stivers  
 Susanna Styron & Darrell Larson  
 Stephen Sultan  
 Daniel Swee  
 Mariko Tada  
 Mary Lou Teel & Peter Freundlich  
 Lynne Thigpen & Larry Aronson  
 Marisa Tomei  
 Judith Tygard & Mitch Weitzner  
 Pamala Tyson-Mudd  
 Laura Valeroso & David Seidman  
 Fred Van Natta & Michael Post  
 Wendy vanden Heuvel  
 Susan Vitucci  
 Mary Pat Walsh  
 Borah & Mildred Walton  
 Robyn Watts  
 Anita Waxman  
 Lenny & Sally Weiss  
 Gregory Welch  
 Jane Bolster & Steve Wertimer  
 Jenny Wiener  
 Michael & Zena Wiener  
 Robert Wiener  
 Max & Barbara Wilk  
 Elizabeth Williams & Joseph Forte  
 Matt Williams & Angelina Fiordellisi  
 Bill Wrubel  
 Jeffrey & Janine Yass  
 James & Mary Lin Yoshimura

## The 52nd Street Project Presents The 1999 Harold and Mimi Steinberg Charitable Trust One-on-Ones

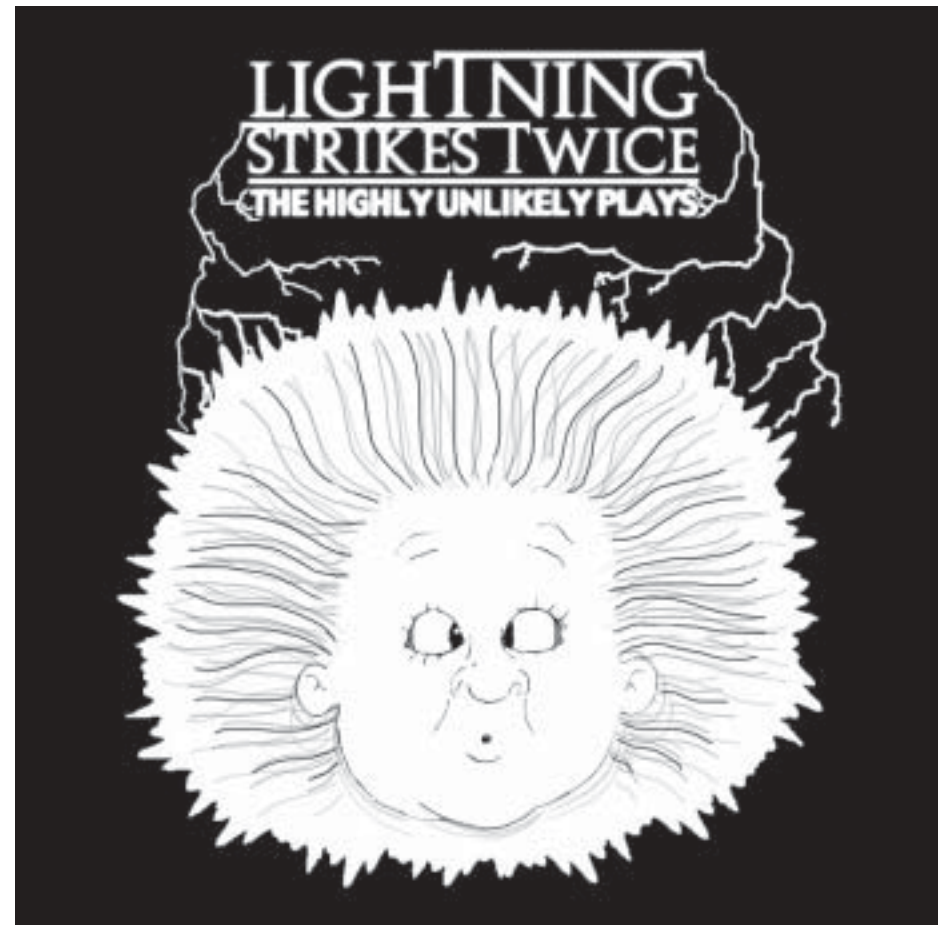

## THE BLOCK ISLAND BATCH

The Ensemble Studio Theatre  
 New York City

Thurs., July 29th at 7:30 p.m.  
 Fri., July 30th at 7:30 p.m.  
 Sat., July 31st at 3:00 & 7:30 p.m.  
 Sun., Aug. 1st at 3:00 p.m.



The 52nd Street Project

---

# Lightning Strikes Twice

 **The Block Island Batch** 

July 29-August 1, The Ensemble Studio Theatre, N.Y.C.

---

## Project Staff

Gus Rogerson, Artistic Director  
Carol Ochs, Executive Director  
Michael Bernard, Associate Artistic Director  
John Sheehy, Director of Development and Marketing  
George Roman Babiak, Production Manager  
Julie Feldman, Director of Education  
Iris A. Brown, Graphic Designer  
Perry McBain Daniel - Centurion  
Bree Elrod, Valerie Gotlib, Jon-Paul Pedergrana - Interns  
Shirley Rumierk - Special Guest Intern

## Production Staff

Kirsten Childs, Composer  
Virginia Pike, Musical Director and Pianist  
Kevin Joseph Roach, Set Designer  
Greg MacPherson, Lighting Designer  
Crystal Thompson, Costume Designer  
Vanessa Valdes, Sound Designer  
Jenny Peek, Stage Manager  
Slide Design Chief: Katherine Lumb  
Slide Design Team:

George Babiak, Renato Castillo,  
Adam Rodriguez, John Steward,  
Alberta Testanero

### Prop Construction Team:

Annika Ahlstrom, Anju Andre-Bergmann,  
George Babiak, Roi Babiak, Caroline,  
Heather Carnduff, Kirstin Cummings,  
Perry McBain Daniel, Bree Elrod,  
Laura Flanagan, Esther Geller,  
Valerie Gotlib, Jennifer Jimenez,  
J.P. Pedergrana, Jenny Peek,  
Jenny Pollack, John Sheehy

### Lightning Strikes Twice Illustration:

Lucas Fleischer

### Slide Operator: Devon Spaght

### Furniture Crew:

J.P. Pedergrana, Kim Mack

### Prop Crew:

Bree Elrod, Valerie Gotlib,  
Chanel Christiansen

### Wall Props:

Jenny Pollack, Kirstin Cummings

### Load-in and Light Hang Crew:

Perry Daniel, Bree Elrod, Robert  
Sean Leonard, Josh Lewis, Jenny  
Peek, J.P. Pedergrana,  
Devon Spaght and Caroline

### House Managers:

Jilly Crook & Laura Sametz

### Week-away Chefs:

Martha Velie-Gass, Pat McQuade,  
Chip Frye

### Teen Counselor: Tessa John-Connor

PROGRAM LAYOUT: GEORGE BABIAK



*The One-on-One Program is made possible with public funds from the National Endowment for the Arts, the New York State Council on the Arts, a state agency, the Department of Youth and Community Development, and the New York City Department of Cultural Affairs.*



The 52nd Street Project is a non-profit organization that brings inner-city children from the Hell's Kitchen neighborhood together with professional theater artists to create theater. **LIGHTNING STRIKES TWICE** is a production of our One-on-One program, which is designed to give children the opportunity to go away for one-week stays in the country and enjoy the undivided attention of a professional theater artist who serves as friend, mentor, and collaborator.

The Project is delighted to return to the Ensemble Studio Theatre, where we have been performing since our inception in 1981. We gratefully acknowledge the fact that if E.S.T. wasn't here, we'd be nowhere.

---

## The 52nd Street Project Board of Directors

Ben Barenholtz	Frances McDormand, <i>chairperson</i>
Lisa Benavides	Patricia M. Murphy, Esq.
Rachel Chanoff	Carol Ochs
Ruth Cohen	Willie Reale
Heidi Ettinger	Gus Rogerson
Wendy Ettinger, <i>chair emeritus</i>	José Soto, Jr., <i>alumni boardmember</i>
Louis P. Friedman	Pamala Tyson
Stephen Graham	Laura Valeroso
Larry Jones	Wendy vanden Heuvel
James McDaniel	Elizabeth Williams

---

## Special Thanks To:

Dr. Christina Biaggi and Pat Walsh, Joya Verde, Virginia Dare and Chip Frye. Our Host Families: Sarah Barkley, Rita & Steve Draper, Elliot & Jennifer Taubman, Martha Velie-Gass & Pat McQuade and Toubé & Bennet Wohl: Lynn Reale, Kate, and everyone at Block Island Realty, Ruth and Carl Kauffman, Prudy and The Ice Cream Place, The Chefs: Martha Velie-Gass and Pat McQuade, Interstate Navigation, Bob Reale, McQuade's Market, Kirk Littlefield, Jane Musky & Tony, Tess and Anna Goldwyn, Greg MacPherson for the air-plane rides, Todd Corayer, Bill Bendokas and New England Air, Block Island Depot, and Howie Rice.

---

## In-Kind Contributions:

Curt, Edgar, Jamie, Eliza, and all the staff at Ensemble Studio Theatre; Neil A. Mazzella & Hudson Scenic Studios, Inc.; Shays & Murphy; Iris A. Brown & Bernhardt/Fudyma Design Group; Ron Kastner, Capital Printing; Masque Sound; New Dramatists; Steve Olsen & The West Bank Cafe; Materials for the Arts; Port Authority; Mayor's Office of Film & Television; John A. Vassilaros & Son; Paris Chocolates; Scholastic Productions; Coleman, Inc.; Watkins Products; Noggin; The Gap; Kiehl's Since 1891; Eric Karpeles & Mike Sell; Bill Muddyman and the Chateau de Berne; Boylan's Bottling Company, BMG, David Sneddon and Fairway Market, and Andy Millon.

Don't miss our upcoming shows!



**The Tyler Hill, Pa. Batch  
of the 1999  
One-On-Ones**

August 26-29, right here at  
The Ensemble Studio Theater.

Same great theme, but with  
new kids, new adults,  
and new plays!

# Playback

November, '99

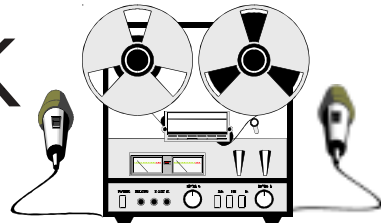

First, a kid writes a short play. Then, an adult writes an "answer" play. Then, the two of them perform both plays!



# Playmaking

December, '99

In September, 10 kids brand-new to the Project will begin a Playmaking class with Michael Bernard. Come and see their final plays performed by adult professional actors.

## Cool Stuff ON SALE IN THE LOBBY

**The Fabulous Flyer Bar (in five flavors)**  
\$2.00 and \$1.50 (\$1.00 for kids)

*And featuring Shel Silverstein's "Fivey and Twoey" logo:*

**Project T-Shirts (Short sleeve) — \$12.00**

**Project T-Shirts (Long sleeve) — \$15.00**

**Project Caps — \$15.00**

**Project Mugs — \$5.00 (NEW COLOR AND DESIGN!)**

Thank you for coming to **LIGHTNING STRIKES TWICE**. If you are not on our mailing list (or if your address has changed), please fill out this form and give it to us on your way out or mail it to the address below. We would also like to know if you are interested in becoming a volunteer. We need help in **all areas**, so please fill out your name and phone number, and we'll call you.

**PLEASE ADD ME TO YOUR MAILING LIST:**

7/99

NAME \_\_\_\_\_

ADDRESS \_\_\_\_\_

ZIP \_\_\_\_\_

HOME PHONE \_\_\_\_\_

DAYTIME PHONE \_\_\_\_\_

**YES, I WOULD LIKE TO BE OF HELP. I CAN:**

- |   |   |  |
|---|---|--|
| <input type="checkbox"/> Help load in and out for shows | <input type="checkbox"/> Draw and/or paint  | <input type="checkbox"/> Help kids with homework |
| <input type="checkbox"/> Hang lights                    | <input type="checkbox"/> Help with mailings | <input type="checkbox"/> Teach kids a skill      |
| <input type="checkbox"/> Work on a backstage crew       | <input type="checkbox"/> Do office work     | <input type="checkbox"/> Be a chef at an event   |
| <input type="checkbox"/> Other (please specify) _____   |   |  |

**MY SCHEDULE IS:**

- Very flexible. I'm often available during weekdays.  
 Somewhat flexible. I can help on the occasional morning or afternoon during the week.  
 Not very flexible at all, but I've got some free time on evenings and weekends.

*If you would like to mail this (and you're always welcome to enclose a tax-deductible contribution), you can send it to: The 52nd Street Project, 500 West 52nd St. New York, NY 10019. Or fax it to (212) 333-5598.*

## Lightning Strikes Twice: ACT I

Music by Kirsten Childs, except where noted. Musical direction by Virginia Pike.  
"Lightning Strikes Twice" theme song lyrics by John Sheehy

### New Neighbor

written and directed by Josh Lewis for Peter Granados, age 11

Ned ..... Peter Granados  
Argh ..... Josh Lewis  
Dinosaurs ..... Tessa John-Connor, Shirley Rumierk  
*"I'm a Caveman"* music and lyrics by Josh Lewis

### Pet Sounds

written by Laurence Klavan, directed by Chris McCann for Zaida Natera, 12

Ben ..... Chris McCann  
Jody ..... Gus Rogerson  
Alice ..... Zaida Natera  
Neighborhood Mongrels ..... Backstage crew  
*"Listen Up"* lyrics by Laurence Klavan

### Let Us Eat Cake

written and directed by Ashby Semple for Jennifer Jimenez, 12

The Queen ..... Jennifer Jimenez  
"Ferdinand" and The Weather Wizard ..... Ashby Semple  
The Royal Seamstress ..... Tessa John-Connor  
The Court Jester ..... Josh Lewis  
Chef ..... George Babiak  
*"Just Say Please"* lyrics by Ashby Semple

### Mall Girl

written by Jacquelyn Reingold, directed by Keira Naughton for Felicita Jerez, 13

Pearl ..... Keira Naughton  
Merle ..... Felicita Jerez  
Witless shoppers ..... Ashby Semple, Robin Morse, Tessa John-Connor  
*"Mall Girl"* and *"Girls Rule"* lyrics by Jacquelyn Reingold

### The Slippery Eel

written and directed by George Babiak for Johnathan Roldan, 12

The Eel ..... Johnathan Roldan  
Dumbley ..... George Babiak  
J. Wellington Piccadilly ..... John Sheehy  
Cops ..... Tessa John-Connor, Shirley Rumierk,  
Robert Sean Leonard, Josh Lewis, J.P. Pedergrana  
*"Please Consider the Consequences"* lyrics by George Babiak

## ACT 2

### Mental Patient

written by Michael Bernard and directed by Matt Saldívar  
for Anju Andre-Bergmann, 12

Petulia ..... Anju Andre-Bergmann  
Aaron ..... Matt Saldívar  
Nurse ..... Shirley Rumierk  
Minions ..... George Babiak, Joe Quintero, John Sheehy  
*"Crazy Lady and Jiggly Man"* lyrics by Michael Bernard

### Phineas' Waterloo

written by Susan Kim  
and directed by Joe Quintero for Steven Vasquez, 12

Hank ..... Steven Vasquez  
Phineas ..... Joe Quintero  
*"Napoleon, Ghost of France"* lyrics by Kirsten Childs

### It Takes Two

written and directed by Robert Sean Leonard for Marlene Moran, 13

Doc ..... Robert Sean Leonard  
Samantha ..... Marlene Moran  
Animal Catcher ..... George Babiak  
*"It Takes Two"* lyrics by Robert Sean Leonard

### Flora's Story

written by Gus Rogerson  
and directed by Robin Morse for Anissa Albarron, 13

Flora ..... Anissa Albarron  
Mother ..... Robin Morse  
All Ears ..... Robin Morse  
The Singing Jailer ..... Gus Rogerson  
Two Armed Guards ..... George Babiak, John Sheehy  
*"The Singing Jailer"* and *"Singing is a Piece of Cake"* lyrics by Gus Rogerson

### Short John Copper

written by Willie Reale, directed by Patrice Johnson  
for Adrian Zambrano, 10

Short John Copper ..... Adrian Zambrano  
Brandy ..... Patrice Johnson  
Pirate Chorus ..... "Menery"  
*"The Saga of Short John Copper," "I Love a Little Man,"* and *"The Artichoke Song"* lyrics by Willie Reale

The 52nd Street Project gratefully acknowledges the support of the following foundations and corporations: The Blythmour Corporation, Bertelsmann's World of Expression Foundation, Chase Manhattan Foundation, Comedy Central, Cubic B's, The Dammann Fund, The Dramatists Guild Fund, Dramatists Play Service, The Educational Foundation Of America, Ensemble Studio Theatre, Entertainment Weekly, EPIC, The Jean & Louis Dreyfus Foundation, Fairway Market, Louis Feraud Paris, The Good Neighbor Committee of the Ford Foundation, The Fan Fox & Leslie R. Samuels Foundation, Gap Inc., GLADPZ Foundation, The Horace W. Goldsmith Foundation, The William and Mary Greve Foundation, Hambrecht & Quist, The Hennessy Foundation, Betty E. & George B. Kaiser Foundation, La Jolla Playhouse, Lloyds Bank, MCJ Foundation, James A. Macdonald Foundation, Ann M. Martin Foundation, J.P. Morgan Charitable Trust, Morgan Stanley Dean Witter Foundation, The William Morris Agency, National Endowment for the Arts, The New World Foundation, Newman's Own, Nickelodeon, O'Grady Family Foundation, Laura Pels Foundation, Pew Charitable Trust, President's Committee on Arts & Humanities, The Rockefeller Foundation, The Scherman Foundation, Inc., Staging and Design, Inc., The Harold & Mimi Steinberg Charitable Trust, Susquehanna, Travelers Foundation, John A. Vassilaros & Sons, Inc., The Wiener Family Foundation, Yorke Construction Corporation. In addition, the following individuals made gifts of over \$150 to the 52nd Street Project this year (list current as of 8/24/99):

Anonymous	Michael J. Fox & Tracy Pollan	John Bedford Lloyd &	Martha Roth & Bill Irwin
Jace Alexander & Maddie Corman	David Frankel	Anne Twomey	Donald Rothschild &
Franco Aller	Eric & Juli Frankel	Greg MacPherson &	Lottchen Shivers
May Ameen	Naomi & Charles Freundlich	Jane Perlmutter	Crystal & Michael Sabatino
Kevin Anderson & Dawn Spence	Lois Fricke & Todd Hollander	Roma Maffia	Steve Sabba
June Ballinger &	Louis & Patrice Friedman	Paul & Lauren Mandell	Richard & Madeline Salzman
Michael Goldstein	Victor Garber	Elizabeth Manne	Vir Hugo & Rosemarie Samson
Jeremy Barber	Judith Garson &	Peter Manning &	Jane & Joseph Sangerman
Ben Barenholtz	Steven Rappoport	André Bishop	Don Scardino
Jessica Bauman	M. Rose Gasner & Larry Chertoff	Ali Marsh	Karin & Tom Schall
Neena Beber	Jillian Gersten	Kay Matschullat & Alan Arffa	Leslie Schine & Nils Nilsen
Laurie Becker & Rick Sweren	Ileen Getz & Mark Grinnell	Max Mayer & Catherine Corpeny	Jeffrey Schwartz
Lisa Belzberg	Nancy Giles	Chris McCann	Cynthia & Paul Scrudato
Lisa Benavides & Tim Nelson	Lloyd & Kilty Gilmour	James & Hannelore McDaniel	Stefan Selig
Kenneth Bennett	Jessica Glass Pollack	Frances McDormand &	Mitchell Semel & Colleen Carroll
Scott Bergman	Judy Goldman & Michael Pillingier	Joel Coen	Robert Semple
Barry & Myrna Bernard	Tony Goldwyn & Jane Musky	Andrew McKeon	Bernice Baruch Shawl
Alexander & Elizabeth Bernstein	Vivian & Georges Gotlib	Amy Merrill	Jan Sidebotham & Tim Emerson
Lewis Black	Stephen & Cathy Graham	Audrey & Danny Meyer	Leslie Simitch
Tessa Blake	Connie Grappo & Lee Wilkof	Bette Midler	Stephanie Simpson &
Buzz Bovshow	L. Stacy Greenwald	Judy Minor	Larry Aeschlimann
Catherine Brophy	Emily Grishman &	Ross Moore & Beth Moore	Randy Sklar & Jason Sklar
Becky Browder & Ted Neustadt	Susan Sampliner	Robin Morse & Gus Rogerson	Tia Balsam & John Slattery
Deborah Brown	Eileen Guggenheim &	Mala & Sham Mosher	Ken Smith
Susan Bruce & Peter Hedges	Russell Wilkinson	Patricia M. Murphy, Esq. & Adam	Lois Smith
Cora Cahan & Bernard Gersten	Thomas Halkias	Spilka	David Sneddon & Kristine Fleisher
Louisa Campbell & Sven Travis	Margot Harley	James Neuberger & Helen	Abigail Rose Solomon
Kathy & Henry Chalfant	Jane & Jonathan Heine	Stambler	Jeff Stafford
Stockard Channing	Cheryl Henson	Jim Neuwirth	Jean Stein
Rachel Chanoff	Peter Herdrich & Karen Trott	Steven O'Neill	Jerry Stiller & Anne Merra
Glenda Chesshir	William Holtzman &	Kevin O'Rourke & Edith Thurber	Daniel Sweet
Peter & Laurie Clancy	S. Sylvia Shepard	Carol Ochs & Bruce MacVittie	Mariko Tada
Patricia Clarkson & Tommy White	Barbara Howard	Jacki Ochs & Jan Kroeze	John & Marjorie Tedesco
Ruth Cohen	Lauren Howard	Paul & Maria Onderdonk	Joan Vail & John Thorne
Richard Cohn	Michelle Hurst	Steven & Margot Peter	Tracy & Edmund Thorne
Noel Comess	Andrew Hurtwiz	Bat-Sheva & Thomas Peters	Marisa Tomei
Thomas Cott	David Henry Hwang	Ethan Phillips	Anne Torsiglieri
Margaret Crimmins	Amy Irving	Nicholas Platt & Robyn Watts	Pamala Tyson & Séan Mudd
Tom Cruise & Nicole Kidman	Dana Ivey	Oliver Platt &	Laura Valeroso & David Seidman
Michael Curcio	Whitney Scott & Peter Jacobson	Camilla Campbell Platt	Wendy vanden Heuvel
Arthur Dantchik	Donna & Thomas Jaycox	Martha Plimpton	John A. Vassilaros & Alexandra
Peter & Judith Dawkins	Andrea Johnson	Richard Polatchek	Gersten
Edward & Joanne DiRugieris	Traci Paige Johnson &	Jeremy M. Posner	Mary Pat Walsh
Stephen Dubner	Robert Mowen	Dean & Leslie Potashner	Borah & Mildred Walton
Christopher & Karen Eddowes	Larry & Mary Jones	Michael Potts	Wendy Wasserstein
Mario Egozi	Lee Kalcheim & Julia Lord	Christopher Randolph	Anita Waxman
Ned Eisenberg	Eric Karpeles & Mike Sell	Peter & Helen Randolph	Sally & Lenny Weiss
Jacquelyn Elfert	Ronald Kastner	Anthony Rapp	Jane Bolster & Steve Wertimer
Heidi Ettinger	Seth & Beth Klarman	Thomas Bingham Ray	Jenny Wiener
Wendy Ettinger & Derek McLane	Mary Kong	Paul Reale & Barbara McCrane	Michael & Zena Wiener
Adam Felber & Jeannie Simpson	Judy Kuhn & David Schwab	Willie Reale & Jenny Gersten	Elizabeth Williams & Joseph Forte
Peter Jay Fernandez &	Carol Langstaff	Keith Reddin & Leslie Lyles	Matt Williams & Angelina Fiordellisi
Denise Burse	Kate Lear & Jonathan LaPook	Gorman & Janice Reilly	Donald Windham
Joan Fields	Cyndi Lee	Jacquelyn Reingold	Joanne Woodward & Paul Newman
Hannah Finn	Warren Leight	Todd Richter & Donna Plummer	Bill Wrubel
Alexa Fogel	Mitchell Lemsky & Jane Bodle	C. C. & Geraldo Rivera	Jeffrey & Janine Yass
Katherine Foster	Becky & Steven Lewis	David & Anita Rogerson	James & Mary Lin Yoshimura

## The 52nd Street Project Presents The 1999 Wiener Family Foundation One-on-Ones

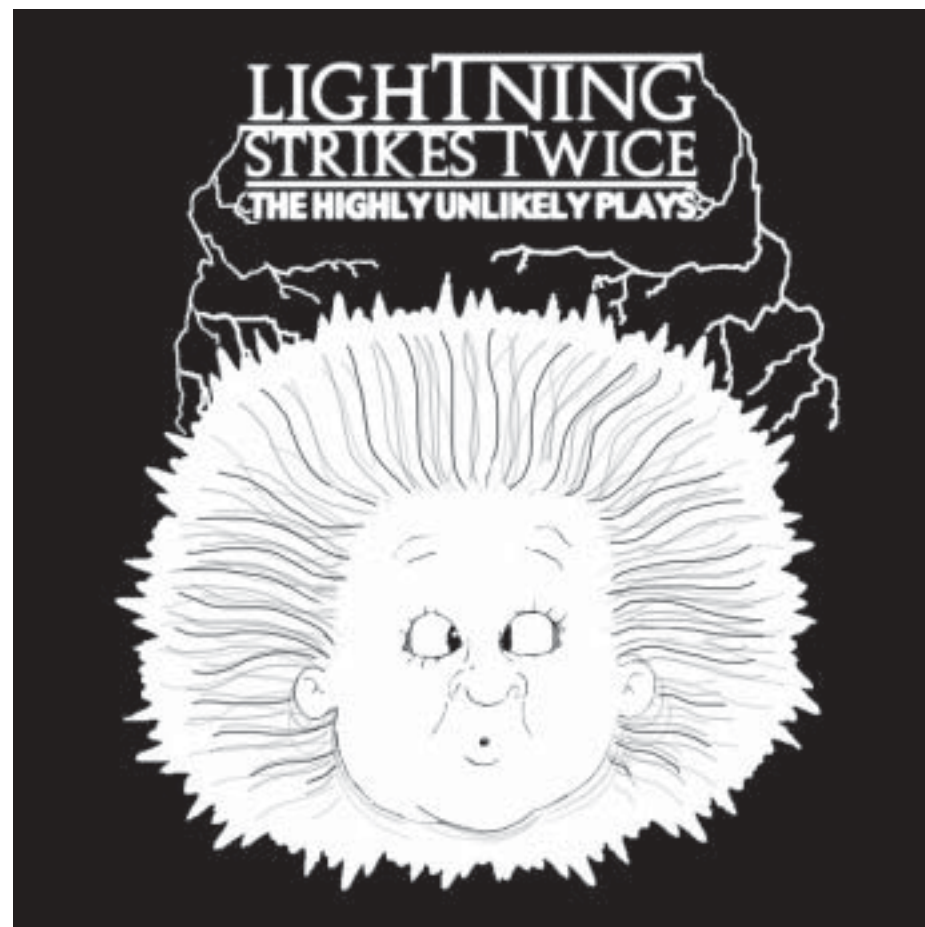

### ***THE TYLER HILL, PA. BATCH***

**The Ensemble Studio Theatre**  
New York City

Thurs., August 26th at 7:30 p.m.

Fri., August 27th at 7:30 p.m.

Sat., August 28th 7:30 p.m.

Sun., August 29th at 3:00 p.m.



The 52nd Street Project

---

# Lightning Strikes Twice

 **The Tyler Hill Batch** 

August 26-29, The Ensemble Studio Theatre, N.Y.C.

---

## Project Staff

Gus Rogerson, Artistic Director  
Carol Ochs, Executive Director  
Michael Bernard, Associate Artistic Director  
John Sheehy, Director of Development and Marketing  
George Roman Babiak, Production Manager  
Julie Feldman, Director of Education  
Iris A. Brown, Graphic Designer  
Bree Elrod, Valerie Gotlib - Interns of Excellence

## Production Staff

Kim D. Sherman, Composer  
Doug Nervik, Pianist  
Kevin Joseph Roach, Set Designer  
Greg MacPherson, Lighting Designer  
Crystal Thompson, Costume Designer  
Jeremy M. Posner, Sound Designer  
Noël Dawkins, Stage Manager  
Mike Sell, Slide Artist  
Prop Construction Team:  
George Babiak, Lorraine Calderon,  
Bree Elrod, Valerie Gotlib,  
Ray Harold, Heidi James,  
Hakim Latimore, Stacey Linden and  
Scott, Katy McIntyre, Jenny Pollack,  
Alejandra Rodriguez, John Sheehy,  
Lisa Tracy  
Lightning Strikes Twice Illustration:  
Lucas Fleischer

Slide Operator: Caroline Goldrich  
Furniture Crew:  
Dina Mandes-Pfister,  
Ray Ocasio, Joseph Mohamed  
Prop Crew:  
Bree Elrod, Jenny Pollack,  
Mayleen Cancel  
Wall Props:  
Valerie Gotlib, Ben Barthelemy  
Load-in and Light Hang Crew:  
Bree Elrod, Caroline Goldrich,  
Valerie Gotlib, Charlton Ruddock,  
Chris Ryan, Tom Schall and Jill  
House Manager:  
Karin Schall  
Week-away Chef: Eric Karpeles  
Teen Counselor:  
Ben Barthelemy

PROGRAM LAYOUT: GEORGE BABIAK

The 52nd Street Project is a non-profit organization that brings inner-city children from the Hell's Kitchen neighborhood together with professional theater artists to create theater. **LIGHTNING STRIKES TWICE** is a production of our One-on-One program, which is designed to give children the opportunity to go away for one-week stays in the country and enjoy the undivided attention of a professional theater artist who serves as friend, mentor, and collaborator.

The Project is delighted to return to the Ensemble Studio Theatre, where we have been performing since our inception in 1981. We gratefully acknowledge the fact that if E.S.T. wasn't here, we'd be nowhere.

---

## The 52nd Street Project Board of Directors

Ben Barenholtz	Frances McDormand, <i>chairperson</i>
Lisa Benavides	Patricia M. Murphy, Esq.
Rachel Chanoff	Carol Ochs
Ruth Cohen	Willie Reale
Heidi Ettinger	Gus Rogerson
Wendy Ettinger, <i>chair emeritus</i>	José Soto, Jr., <i>alumni boardmember</i>
Louis P. Friedman	Pamala Tyson
Stephen Graham	Laura Valeroso
Larry Jones	Wendy vanden Heuvel
James McDaniel	Elizabeth Williams

---

## Special Thanks

First of all, thanks to our host families: Dan Brinkerhoff & Liz Huntington, Ross & Ruby; Sohail Raikhy; Bonnie, Ryan, Chelsea & Ben Rutledge; Sarah & Bill Spoerri, Carl, Sasha & Michael; Frank & Pat Stoeckle; Linda & Bill Cobb; Linda & Bill Halvorsen; Fred van Natta & Michael Post; Sally & Lenny Weiss.

Sincere thanks to Wendy Townsend and Mark Keoppen, Martha Sader, Joan Henry, Debbie, Frosty & Rio Myers; Robin Morse, Vanessa Valdes, David Sneddon, Steve Jenkins & The Fairway Market.

And finally, a round of extra-special thanks to our amazing hosts/chefs Mike Sell & Eric Karpeles (and Walter the Cat and Toadie, the toad in the pond, too).

---

## In-Kind Contributions:

Curt, Edgar, Jamie, Eliza, and all the staff at Ensemble Studio Theatre; Neil A. Mazzella & Hudson Scenic Studios, Inc.; Shays & Murphy; Iris A. Brown & Bernhardt/Fudyma Design Group; Ron Kastner, Capital Printing; Masque Sound; New Dramatists; Steve Olsen & The West Bank Cafe; Materials for the Arts; Port Authority; Mayor's Office of Film & Television; John A. Vassilaros & Son; Paris Chocolates; Scholastic Productions; Coleman, Inc.; Watkins Products; Noggin; The Gap; Kiehl's Since 1891; Bill Muddyman and the Chateau de Berne; Boylan's Bottling Company, BMG, Fairway Market, Jenny Wiener and Andy Millon.



The One-on-One Program is made possible with public funds from the National Endowment for the Arts, the New York State Council on the Arts, a state agency, the Department of Youth and Community Development, and the New York City Department of Cultural Affairs.



Don't miss our upcoming shows!

# Playback

November, 1999

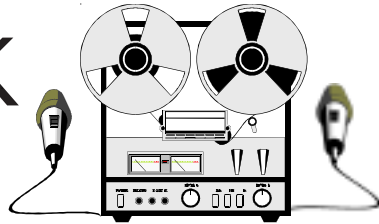

First, a kid writes a short play. Then, an adult writes an "answer" play. Then, the two of them perform both plays!



# Playmaking

December, 1999

In September, 10 kids brand-new to the Project will begin a Playmaking class with Michael Bernard. Come and see their final plays performed by adult professional actors.

# The Two-on-Two's

January, 2000

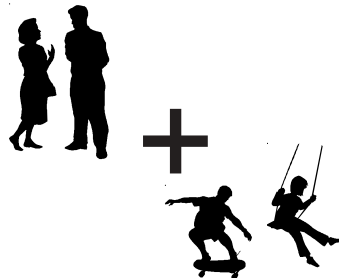

In the One-on-One's, a single kid is paired with a single adult. Now you can see two kids (grizzled Project vets, this time) perform a play written by an adult and directed by another adult.

## Cool Stuff ON SALE IN THE LOBBY

**The Fabulous Flyer Bar (in five flavors)**

\$2.00 and \$1.50 (\$1.00 for kids)

And featuring Shel Silverstein's "Fivey and Twoey" logo:

**Project T-Shirts (Short sleeve) — \$12.00**

**Project T-Shirts (Long sleeve) — \$15.00**

**Project Caps — \$15.00**

**Project Mugs — \$5.00 (NEW COLOR AND DESIGN!)**

Thank you for coming to **LIGHTNING STRIKES TWICE**. If you are not on our mailing list (or if your address has changed), please fill out this form and give it to us on your way out or mail it to the address below. We would also like to know if you are interested in becoming a volunteer. We need help in **all areas**, so please fill out your name and phone number, and we'll call you.

**PLEASE ADD ME TO YOUR MAILING LIST:**

899

NAME \_\_\_\_\_

ADDRESS \_\_\_\_\_

ZIP \_\_\_\_\_

HOME PHONE \_\_\_\_\_

DAYTIME PHONE \_\_\_\_\_

**YES, I WOULD LIKE TO BE OF HELP. I CAN:**

- |   |   |  |
|---|---|--|
| <input type="checkbox"/> Help load in and out for shows | <input type="checkbox"/> Draw and/or paint  | <input type="checkbox"/> Help kids with homework |
| <input type="checkbox"/> Hang lights                    | <input type="checkbox"/> Help with mailings | <input type="checkbox"/> Teach kids a skill      |
| <input type="checkbox"/> Work on a backstage crew       | <input type="checkbox"/> Do office work     | <input type="checkbox"/> Be a chef at an event   |
| <input type="checkbox"/> Other (please specify) _____   |   |  |

**MY SCHEDULE IS:**

- Very flexible. I'm often available during weekdays.
- Somewhat flexible. I can help on the occasional morning or afternoon during the week.
- Not very flexible at all, but I've got some free time on evenings and weekends.

If you would like to mail this (and you're always welcome to enclose a tax-deductible contribution), you can send it to: The 52nd Street Project, 500 West 52nd St. New York, NY 10019. Or fax it to (212) 333-5598.

## Lightning Strikes Twice: ACT I

Music by Kim D. Sherman

"Lightning Strikes Twice" theme song lyrics by John Sheehy

### Tomorrow Never Quacks

Written and directed by Adam Felber for Joshua Brown, age 11

Dr. Ernst von Hagen Dáz ..... Adam Felber  
Agent Neville Slate ..... Joshua Brown  
Agent James Bonk ..... Michael Bernard  
Henchmen ..... Backstage crew

"That's What Enemies Are For" lyrics by Adam Felber, Beat Box by Jerry

"Death By Chocolate" McGill

### Chloe and Ziggy Tackle the Big Questions

By Liz Tuccillo. Directed by Anne Torsiglieri for Isaac Trujillo, age 12

Ziggy the Zapper ..... Isaac Trujillo  
Chloe the Cloud ..... Anne Torsiglieri  
Sally Anne, a girl scout ..... Bree Elrod  
Bad Luck Bennigan ..... John Sheehy  
Big Obnoxious Kid ..... George Babiak  
Cute Little Girl ..... Eris Migliorini

"Ziggy the Zapper" & "Don't Take it Personally" lyrics by Liz Tuccillo

### The Incredibly Strange But Incredibly

#### True Case of the Missing Kawinky-Dinkies

By Neena Beber. Directed by Camilia Sanes for Alejandra Rodriguez, age 12

Vivian ..... Alejandra Rodriguez  
Sally ..... Camilia Sanes

"That's A Coincidence" lyrics by Neena Beber and John Sheehy

### Nikki Spillane: Hard Boiled Gumshoe With A Heart of Gold

Written and directed by Robert Shaffron for Mona-Lisa Barthelemy, age 12

Nikki ..... Mona-Lisa Barthelemy  
Johnny ..... John Steber

"Married to My Job" lyrics by Robert Shaffron

### The Brothers Mendoza

Written by Willie Reale and directed by Ed Vassallo for Justin Aponte, age 11

Jose ..... Ed Vassallo  
Ricardo ..... Justin Aponte

"There's Gold in Them Thar Hills," & "I Will Not Let You Fall" lyrics by Willie Reale

## ACT 2

### Heavenly Bodies

Written and directed by Gus Rogerson for Lorraine Zambrano, age 14

Stella Star ..... Lorraine Zambrano  
Connie Constellation ..... Gwendolyn Mulamba  
Sparky ..... Gus Rogerson

"The Life of a Star," and "Back in Black" lyrics by Gus Rogerson

### The Silence of the Clowns

Written and directed by Jerry McGill for Joel Lind, age 12

Lt. Clown ..... Ben Barthelemy  
Jethro T. Clown ..... Joel Lind  
Orpheus T. Clown ..... Jerry McGill

"Why Make 'Em Laugh?" lyrics by Jerry McGill

### Time Storm

Written and directed by John Sheehy for Michael Feliciano, age 11

Dr. Hornswaggle ..... Zabryna Guevara  
Dr. Cornbuckle ..... Michael Feliciano  
Omar ..... George Babiak

"Lost In Time Blues" and "Don't Ever Give Up" lyrics by John Sheehy

### The Most Valuable Thing

By Cindy Lou Johnson. Directed by Eris Migliorini for

Lorraine Calderon, age 13

Jumpers ..... Lorraine Calderon  
Jennie ..... Eris Migliorini

"I Like You" lyrics by Cindy Lou Johnson

### Pot O'Gold

Written and directed by Michael Bernard for Robert Tomas, age 10

Chester ..... Robert Tomas  
Binky ..... Michael Bernard  
Papa Grumpy ..... Adam Felber  
Lady ..... Bree Elrod

"Here We Are," and "Chester's Song" lyrics by Michael Bernard





The 52nd Street Project gratefully acknowledges the support of the following foundations and corporations: The Blythmour Corporation, Bertelsmann's World of Expression Foundation, Chase Manhattan Foundation, Comedy Central, Crosby Fund, Cubic B's, The Dammann Fund, The Dramatists Guild Fund, Dramatists Play Service, The Educational Foundation Of America, Ensemble Studio Theatre, Entertainment Weekly, EPIC, The Jean & Louis Dreyfus Foundation, Fairway Market, Louis Feraud Paris, The Good Neighbor Committee of the Ford Foundation, The Holland Lodge Foundation, Inc., The Fan Fox & Leslie R. Samuels Foundation, Gap Inc., GLADPZ Foundation, The Horace W. Goldsmith Foundation, The William and Mary Greve Foundation, Hambrecht & Quist, The Hennessy Foundation, Betty E. & George B. Kaiser Foundation, La Jolla Playhouse, Lloyds Bank, MCJ Foundation, James A. Macdonald Foundation, Ann M. Martin Foundation, J.P. Morgan Charitable Trust, Morgan Stanley Dean Witter Foundation, The William Morris Agency, The New World Foundation, Newman's Own, Nickelodeon, O'Grady Family Foundation, Laura Pels Foundation, Pew Charitable Trust, President's Committee on Arts & Humanities, The Rockefeller Foundation, The Scherman Foundation, Inc., Staging and Design, Inc., The Harold & Mimi Steinberg Charitable Trust, Susquehanna, Travelers Foundation, John A. Vassilaros & Sons, Inc., The Wiener Family Foundation, Yorke Construction Corporation. In addition, the following individuals made gifts of over \$150 to the 52nd Street Project this year (list current as of 8/24/99):

Anonymous	Katherine Foster	Becky & Steven Lewis	Martha Roth & Bill Irwin
Jace Alexander & Maddie Corman	Michael J. Fox & Tracy Pollan	John Bedford Lloyd & Anne Twomey	Donald Rothschild & Lottchen Shivers
Franco Aller	Eric & Juli Frankel	Greg MacPherson & Jane Perlmutter	Crystal & Michael Sabatino
May Ameen	Naomi & Charles Freundlich	Roma Maffia	Steve Sabba
Kevin Anderson & Dawn Spence	Lois Fricke & Todd Hollander	Paul & Lauren Mandell	Richard & Madeline Salzman
June Ballinger & Michael Goldstein	Victor Garber	Elizabeth Manne	Vir Hugo & Rosemarie Samsom
Jeremy Barber	Judith Garson & Steven Rappoport	Peter Manning & André Bishop	Jane & Joseph Sangerman
Ben Barenholtz	M. Rose Gasner & Larry Chertoff	Ali Marsh	Don Scardino
Jessica Bauman	Jilian Gersten	Kay Matschullat & Alan Arffa	Karin & Tom Schall
Neena Beber	Ileen Getz & Mark Grinnell	Max Mayer & Catherine Corpeny	Leslie Schine & Nils Nilsen
Laurie Becker & Rick Sweren	Nancy Giles	Chris McCann	Jeffrey Schwartz
Lisa Belzberg	Lloyd & Kitty Gilmour	James & Hannelore McDaniel	Cynthia & Paul Scrudato
Lisa Benavides & Tim Nelson	Jessica Glass Pollack	Frances McDormand & Joel Coen	Stefan Selig
Kenneth Bennett	Judy Goldman & Michael Pillinger	Andrew McKeon	Mitchell Semel & Colleen Carroll
Scott Bergman	Tony Goldwyn & Jane Musky	Amy Merrill	Robert Semple
Barry & Myrna Bernard	Vivian & Georges Gotlib	Audrey & Danny Meyer	Bernice Baruch Shawl
Alexander & Elizabeth Bernstein	Stephen & Cathy Graham	Bette Midler	Jan Sidebotham & Tim Emerson
Lewis Black	Connie Grappo & Lee Wilkof	Judy Minor	Leslie Simith
Tessa Blake	L. Stacy Greenwald	Ross Moore & Beth Moore	Stephanie Simpson & Larry Aeschlimann
Buzz Bovshow	Emily Grishman & Susan Sampliner	Robin Morse & Gus Rogerson	Randy Sklar & Jason Sklar
Catherine Brophy	Eileen Guggenheim & Russell Wilkinson	Mala & Sham Mosher	Tia Balsam & John Slattery
Becky Browder & Ted Neustadt	Thomas Halikias	Patricia M. Murphy, Esq. & Adam Spilka	Ken Smith
Deborah Brown	Margot Harley	James Neuberger & Helen Stambler	Lois Smith
Susan Bruce & Peter Hedges	Jane & Jonathan Heine	Jim Neuwirth	David Sneddon & Kristine Fleisher
Cora Cahan & Bernard Gersten	Cheryl Henson	Steven O'Neill	Abigail Rose Solomon
Louisa Campbell & Sven Travis	Peter Herdrich & Karen Trott	Kevin O'Rourke & Edith Thurber	Jeff Stafford
Kathy & Henry Chalfant	William Holtzman & S. Sylvia Shepard	Carol Ochs & Bruce MacVittie	Jean Stein
Stockard Channing	Barbara Howard	Jacki Ochs & Jan Kroeze	Jerry Stillier & Anne Merra
Rachel Chanoff	Lauren Howard	Paul & Maria Onderdonk	Daniel Swee
Glenda Chesshir	Michelle Hurst	Steven & Margot Peter	Mariko Tada
Peter & Laurie Clancy	Andrew Hurtwiz	Bat-Sheva & Thomas Peters	John & Marjorie Tedesco
Patricia Clarkson & Tommy White	David Henry Hwang	Ethan Phillips	Joan Vail & John Thome
Ruth Cohen	Amy Irving	Nicholas Platt & Robyn Watts	Tracy & Edmund Thorne
Richard Cohn	Dana Ivey	Oliver Platt & Camilla Campbell Platt	Marisa Tomei
Noel Comess	Whitney Scott & Peter Jacobson	Martha Plimpton	Anne Torsiglieri
Thomas Cott	Donna & Thomas Jaycox	Richard Polatchek	Pamala Tyson & Séan Mudd
Margaret Crimmins	Andrea Johnson	Jeremy M. Posner	Laura Valeroso & David Seidman
Tom Cruise & Nicole Kidman	Traci Paige Johnson & Robert Mowen	Dean & Leslie Potashner	Wendy vanden Heuvel
Michael Curcio	Larry & Mary Jones	Michael Potts	John A. Vassilaros & Alexandra Gersten
Arthur Dantchik	Lee Kalcheim & Julia Lord	Christopher Randolph	Mary Pat Walsh
Peter & Judith Dawkins	Eric Karpeles & Mike Sell	Peter & Helen Randolph	Borah & Mildred Walton
Edward & Joanne DiRugieris	Ronald Kastner	Anthony Rapp	Wendy Wasserstein
Stephen Dubner	Seth & Beth Klarman	Thomas Bingham Ray	Anita Waxman
Christopher & Karen Eddowes	Mary Kong	Seth & Beth Klarman	Sally & Lenney Weiss
Mario Egodzi	Judy Kuhn & David Schwab	Willie Reale & Jenny Gersten	Jane Bolster & Steve Wertimer
Ned Eisenberg	Carol Langstaff	Keith Reddin & Leslie Lyles	Jenny Wiener
Jacquelyn Elfert	Kate Lear & Jonathan LaPook	Gorman & Janice Reilly	Michael & Zena Wiener
Heidi Ettinger	Cyndi Lee	Jacquelyn Reingold	Elizabeth Williams & Joseph Forte
Wendy Ettinger & Derek McLane	Warren Leight	Todd Richter & Donna Plummer	Matt Williams & Angelina Fiordellisi
Adam Felber & Jeannie Simpson	Mitchell Lemsky & Jane Bodle	C.C. & Geraldo Rivera	Donald Windham
Peter Jay Fernandez & Denise Burse		David & Anita Rogerson	Joanne Woodward & Paul Newman
Joan Fields			Bill Wrubel
Hannah Finn			Jeffrey & Janine Yass
Alexa Fogel			James & Mary Lin Yoshimura

The 52nd Street Project presents

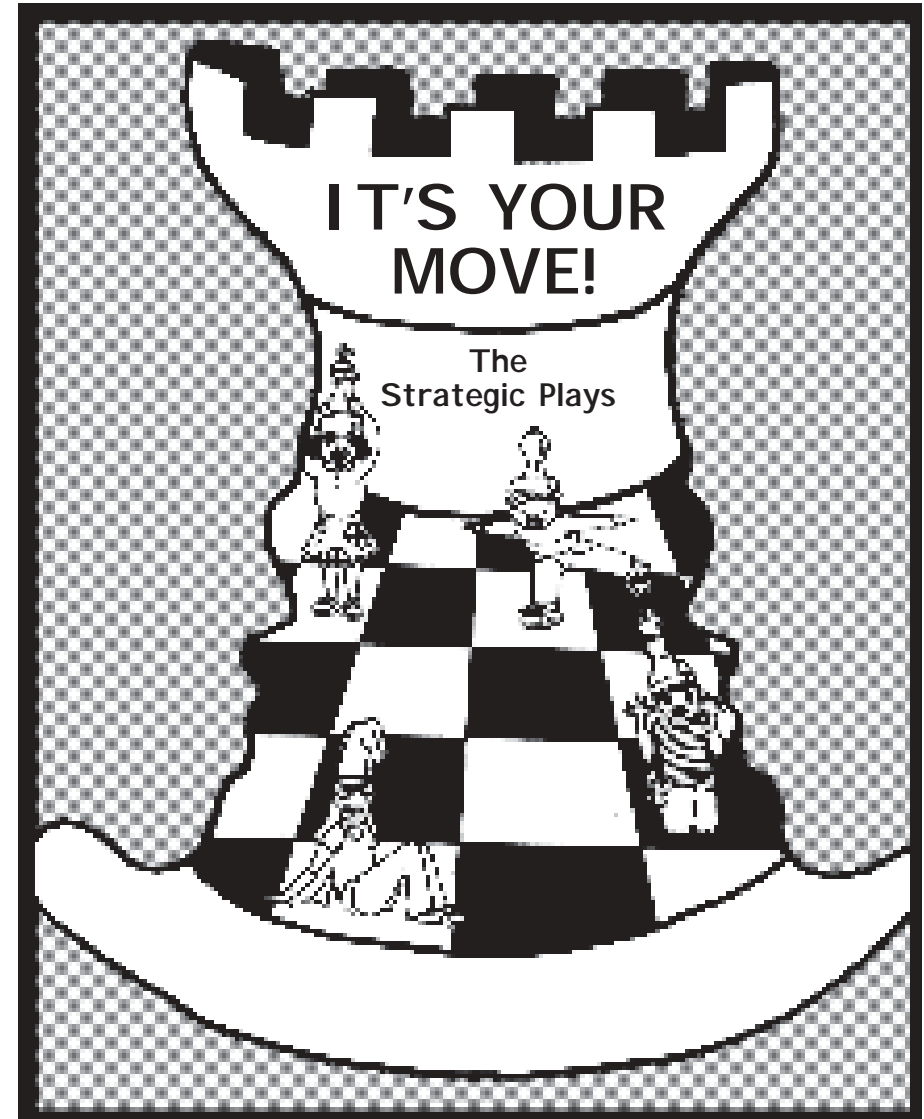

The Hudson Guild Theater

441 W. 26th St., New York City

Fri, Nov. 5th at 7:30

Sat, Nov. 6th at 3:00 and 7:30

Sun, Nov. 7th at 3:00



# It's Your Move: The Strategic Plays

The 1999 Playback Plays: Nov. 5, 6, & 7, The Hudson Guild Theater, NYC



## Project Staff

Gus Rogerson, Artistic Director  
 Carol Ochs, Executive Director  
 Michael Bernard, Associate Artistic Director  
 John Sheehy, Director of Development and Marketing  
 George Roman Babiak, Production Manager  
 Julie Feldman, Director of Education  
 Iris A. Brown, Graphic Designer  
 Ray Ocasio and Mayleen Cancel - Receptionists  
 Ariel Aver - Intern

## Production Staff

Rusty Magee, Composer  
 Kevin Joseph Roach, Set Designer  
 Lighting Designers:  
 Greg MacPherson and  
 Courtney LeClaire-Conway  
 Julie Fischhoff, Costume Designer  
 Caroline Goldrick, Costume Assistant  
 Vanessa Valdes, Sound Designer  
 Noël Dawkins, Stage Manager  
 Katherine Lumb, Slide Design Chief  
 Slide Designers:  
 Renato Castilho, Tiana Manfred,  
 Adam Rodriguez, John Steward,  
 Alberta Testanero  
 Foamcore Prop Design Team:  
 Ariel Aver, George Babiak,  
 Alex Buccino, Kate and Matt Chaston,  
 Lisa Diamond, Elissa Errick, Melissa  
 Fowler, Cara Marcous, Jill Raleigh,

Kevin Roach, John Sheehy.  
 Slide Operator: Ariel Aver  
 Furniture Crew:  
 Jonathan Goldblatt,  
 Grace Eboigbe  
 Prop Crew:  
 Paola Fantini, Zsuzsa Mysak  
 Wall Props:  
 Lisa Hamel  
 House Manager: Carol Cate  
 Load-in & Light Hang Crew:  
 Ariel Aver, Bill Charlton,  
 Tim Gallagher, Jennifer Horton,  
 Frank Marty, Tom Schall,  
 Maury Schott, Patty Spahn  
 Weekend-away Chef:  
 Christopher Randolph  
 It's Your Move Illustration:  
 Heidi James

PROGRAM LAYOUT: GEORGE BABIAK



NATIONAL  
ENDOWMENT  
FOR THE ARTS

The Playback Program is made possible with public funds from the National Endowment for the Arts; the New York State Council on the Arts, a state agency; the Department of Youth and Community Development; and the New York City Department of Cultural Affairs.



The 52nd Street Project is a non-profit organization that brings inner-city children from the Hell's Kitchen/Clinton neighborhood together with professional theater artists to create theater. **It's Your Move** is a production of our Playback program, in which kid actor/playwrights are taken away for a weekend in the country where they write a play. Their adult actor/playwright partners then write "answer plays" in response. For the final production, the partners perform both plays back-to-back. All of the children seen tonight are veterans of the Play-making classes which were adapted for the Project by Daniel Judah Sklar from his book *Playmaking: Children Writing and Performing Their Own Plays*.

## The 52nd Street Project Board of Directors

Ben Barenholtz	Frances McDormand, <i>chairperson</i>
Lisa Benavides	Patricia M. Murphy, Esq.
Rachel Chanoff	Carol Ochs
Ruth Cohen	Willie Reale
Heidi Ettinger	Gus Rogerson
Wendy Ettinger, <i>chair emeritus</i>	José Soto, Jr., <i>alumni boardmember</i>
Louis P. Friedman	Pamala Tyson
Stephen Graham	Laura Valeroso
Larry Jones	Wendy vanden Heuvel
James McDaniel	Elizabeth Williams

## Special Thanks To:

Our friends Peter, Helen, and Christopher Randolph, who put us up for the kids' writing retreat over Columbus Day weekend at their home in Wareham, Mass. An extra helping of vitamin-enriched thanks go to Chris, who did all the cooking. A big thank-you also goes out to Jim Furlong and the Hudson Guild Theater

## In-Kind Contributions:

Colorforms; Neil A. Mazzella & Hudson Scenic Studios, Inc.; Shays & Murphy; Iris A. Brown & Bernhardt/Fudyma Design Group; Ron Kastner, Capital Printing; Masque Sound; New Dramatists; Steve Olsen & The West Bank Cafe; Materials for the Arts; Port Authority; Mayor's Office of Film & Television; John A. Vassilaros & Son; Paris Chocolates; Scholastic Productions; Coleman, Inc.; Watkins Products; Eric Karpeles & Mike Sell; Bill Muddyman and the Chateau de Berne; Boylan's Bottling Company; BMG; David Sneddon and Fairway Market; Noggin; The Gap; Kiehl's Since 1891; Jenny Wiener; and Andy Millon.

Don't miss our upcoming shows!

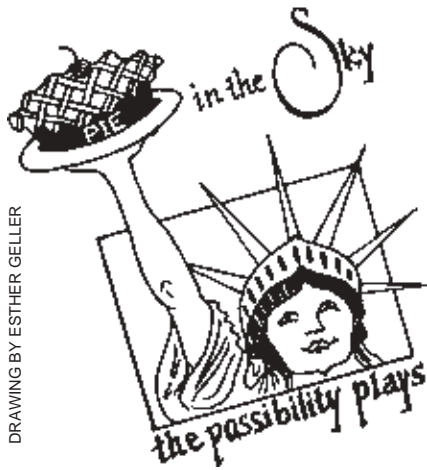

DRAWING BY ESTHER GELLER

Dec. 17, 18, & 19  
The Ensemble  
Studio Theater

At this moment, 10 small Project rookies are taking a Playmaking class with Michael Bernard. When they are done, they will be hailed as masters of their craft and given their very own writer's retreat in Pennsylvania. Come see their final plays performed by professional adult actors at **The Ensemble Studio Theatre**. Call 642-5052 for reservations.

## The Two-on-Two's

January, 2000

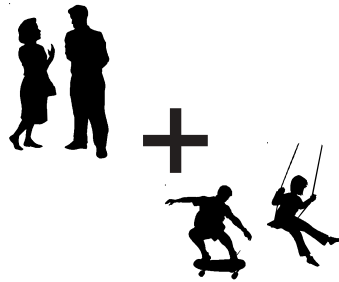

In the One-on-One's, a single kid is paired with a single adult. Now you can see *two* kids (grizzled Project vets, this time) perform a play written by an adult and directed by *another* adult.

WINTER SERIES

## Playmaking

March, 2000



In January, our next batch of newcomers will undertake the 10-week Playmaking program. At the end of the class they will be whisked away to Kent, Ct. for a weekend to fashion a set of plays. The only thing they need: an audience.

## Cool Stuff ON SALE IN THE LOBBY

**The Fabulous Flyer Bar (in five flavors)**  
\$2.00 and \$1.50 (\$1.00 for kids)

And featuring Shel Silverstein's "Fivey and Twoey" logo:

**Project T-Shirts (Short sleeve)** — \$12.00

**Project T-Shirts (Long sleeve)** — \$15.00

**Project Caps** — \$15.00

**Project Mugs** — \$5.00 (NEW COLOR AND DESIGN!)

**Project Pencils** — 3 for \$1.00

Thank you for coming to **IT'S YOUR MOVE**. If you are not on our mailing list (or if your address has changed), please fill out this form and give it to us on your way out or mail it to the address below. We would **also** like to know if you are interested in becoming a volunteer. We need help in **all areas**, so please fill out your name and phone number, and we'll call you.

PLEASE ADD ME TO YOUR MAILING LIST: 11/99

NAME \_\_\_\_\_

ADDRESS \_\_\_\_\_

ZIP \_\_\_\_\_

HOME PHONE \_\_\_\_\_

DAYTIME PHONE \_\_\_\_\_

**YES, I WOULD LIKE TO BE OF HELP. I CAN:**

- |   |   |  |
|---|---|--|
| <input type="checkbox"/> Help load in and out for shows | <input type="checkbox"/> Draw and/or paint  | <input type="checkbox"/> Help kids with homework |
| <input type="checkbox"/> Hang lights                    | <input type="checkbox"/> Help with mailings | <input type="checkbox"/> Teach kids a skill      |
| <input type="checkbox"/> Work on a backstage crew       | <input type="checkbox"/> Do office work     | <input type="checkbox"/> Be a chef at an event   |
| <input type="checkbox"/> Other (please specify) _____   |   |  |

**MY SCHEDULE IS:**

- Very flexible. I'm often available during weekdays.
- Somewhat flexible. I can help on the occasional morning or afternoon during the week.
- Not very flexible at all, but I've got some free time on evenings and weekends.

If you would like to mail this (and you're always welcome to enclose a tax-deductible contribution), you can send it to: *The 52nd Street Project*, 500 West 52nd St. New York, NY 10019. Or fax it to (212) 333-5598.

## It's Your Move: ACT I

All original music composed by Rusty Magee

### The Pigeon Decision

by Candy Godoy, 14. Dramaturg: Jacquelyn Reingold  
Director: John Sheehy

### Coo-Dependency

Written by Jacquelyn Reingold. Directed by John Sheehy

Pingeo ..... José Soto  
Polly Pigeon ..... Candy Godoy  
Gang members ..... Ariel Aver and Zsuzsa Mysak  
“*We’re Having Problems*” lyrics by Jacquelyn Reingold

---

### A Day In The Life of an Agent

by Hakim Latimore, age 13. Dramaturg/Director: Suzen Murakoshi

### Afraid 2...

Written and directed by Suzen Murakoshi

Cheeseman (and assorted radio voices) ..... George Babiak  
Bravo Johansen ..... Hakim Latimore  
Agent Boss/Chris, a taxi passenger ..... Suzen Murakoshi  
Cheese soldier ..... John Sheehy  
“*Unpretentious Spy Song*” lyrics by Suzen Murakoshi

---

### Stepsisters

by Tanika Parson, age 14. Dramaturg/Director: Jonathan Bernstein

### Maria, Susan, and Jessica Say Grace

Written and directed by Jonathan Bernstein

Susan ..... Tanya Gingerich  
Maria ..... Tanika Parson  
Jessica ..... Denise Burse

---

### Wacky Burger

by Marcsi Mysak, age 14. Dramaturg/Director: Robert Sean Leonard

### Wacky Burger II

Written and directed by Robert Sean Leonard

Mean Mouse ..... Marcsi Mysak  
The Dude/Mr. Dude, Sr. .... Robert Sean Leonard  
Customers ..... Michael Bernard, John Sheehy

## It's Your Move: ACT II

### The Most Interesting Day

by Noel Polanco, age 14. Dramaturg/Director: Gus Rogerson.

### Surgeons!!

Written and directed by Gus Rogerson

Bob ..... Noel Polanco  
Sally ..... Gus Rogerson  
Jessica ..... George Babiak  
Rodney ..... Ariel Aver  
Esther ..... Jonathan Goldblatt  
Orderly 1 ..... John Sheehy  
Orderly 2 ..... Zsuzsa Mysak  
“*My Life*,” “*Surgical Pep Rally*,” and “*Friends*” lyrics by Noel Polanco.  
“*Surgeons Save Lives*” lyrics by Gus Rogerson

---

### Masters by Osage Lewis-Ashley, age 13.

Dramaturg/Director: Danyon Davis

### Masters II: The Revenge of the Begonians

Written by Keith Reddin and directed by Danyon Davis

Justin ..... Osage Lewis-Ashley  
Jeremy ..... Danyon Davis  
Master Jules/Gamith ..... Keith Reddin  
Begonian 1 ..... Ariel Aver  
Begonian 2 ..... Jonathan Goldblatt

---

### Sisters Make a Move

by Jaya Rosado, age 15. Dramaturg/Director: Jeanne Simpson.

### Sisters Tell The Truth

Written by Adriana Trigiani. Directed by Jeanne Simpson.

Amy ..... Jaya Rosado  
Jasmine ..... Jeanne Simpson  
Papa ..... Michael Bernard  
Counselor ..... Ariel Aver

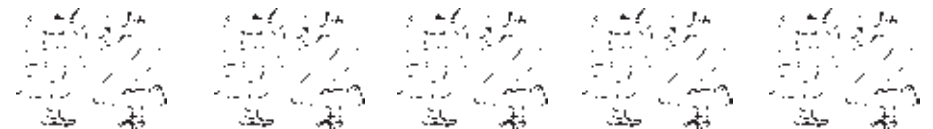

The 52nd Street Project gratefully acknowledges the support of the following foundations and corporations: The Blythmour Corporation, Bertelsmann's World of Expression Foundation, Chase Manhattan Foundation, Comedy Central, Crosby Fund, Cubic B's, The Dammann Fund, The Dramatists Guild Fund, Dramatists Play Service, The Educational Foundation Of America, Ensemble Studio Theatre, Entertainment Weekly, EPIC, The Jean & Louis Dreyfus Foundation, Fairway Market, Louis Feraud Paris, The Good Neighbor Committee of the Ford Foundation, The Holland Lodge Foundation, Inc., The Fan Fox & Leslie R. Samuels Foundation, Gap Inc., GLADPZ Foundation, The Horace W. Goldsmith Foundation, The William and Mary Greve Foundation, Hambrecht & Quist, Heights Partners, Inc., The Hennessy Foundation, Betty E. & George B. Kaiser Foundation, Lloyds Bank, MCJ Foundation, James A. Macdonald Foundation, Ann M. Martin Foundation, J.P. Morgan Charitable Trust, Morgan Stanley Dean Witter Foundation, The William Morris Agency, The New World Foundation, Newman's Own, Nickelodeon, O'Grady Family Foundation, Laura Pels Foundation, Pew Charitable Trust, President's Committee on Arts & Humanities, The Rockefeller Foundation, The Scherman Foundation, Inc., Staging and Design, Inc., The Harold & Mimi Steinberg Charitable Trust, Susquehanna, Travelers Foundation, John A. Vassilaros & Sons, Inc., The Wiener Family Foundation, Yorke Construction Corporation. In addition, the following individuals made gifts of over \$150 to the 52nd Street Project this year (list current as of 12/15/99):

Anonymous	Gerald Fernandez	Judy Kuhn & David Schwab	Todd Richter & Donna Plummer
Jace Alexander & Maddie Corman	Peter Jay Fernandez & Denise Burse	Roger & Belle Kuhn	C.C. & Geraldo Rivera
Franco Aller	Joan Fields	Carol Langstaff	David & Anita Rogerson
May Ameen	Hannah Finn	Kate Lear & Jonathan LaPook	Martha Roth & Bill Irwin
Kevin Anderson & Dawn Spence	Alexa Fogel	Cyndi Lee	Donald Rothschild & Lottchen Shivers
June Ballinger & Michael Goldstein	Katherine Foster	Warren Leight	Crystal & Michael Sabatino
Jeremy Barber	Michael J. Fox & Tracy Pollan	Mitchell Lemsky & Jane Bodle	Steve Sabba
Ben Barenholtz	David Frankel	Becky & Steven Lewis	Richard & Madeline Salzman
Jessica Bauman	Eric & Juli Frankel	John Bedford Lloyd & Anne Twomey	Hugo & Rosemarie Samson
Neena Beber	Naomi & Charles Freundlich	Greg MacPherson & Jane Perlmutter	Jane & Joseph Sangerman
Laurie Becker & Rick Sweren	Lois Fricke & Todd Hollander	Roma Maffia	Don Scardino
Lisa Belzberg	Louis & Patrice Friedman	Paul & Lauren Mandell	Karin & Tom Schall
Lisa Benavides & Tim Nelson	Victor Garber	Elizabeth Manne	Leslie Schine & Nils Nilsen
Kenneth Bennett	Judith Garson & Steven Rappoport	Peter Manning & André Bishop	Jeffrey Schwartz
Scott Bergman	M. Rose Gasner & Larry Chertoff	Ali Marsh	Cynthia & Paul Scrudato
Barry & Myrna Bernard Alexander & Elizabeth Bernstein	Jilian Gersten	Kay Matschullat & Alan Arffa	Stefan Selig
Lewis Black	Ileen Getz & Mark Grinnell	Max Mayer & Catherine Corpeny	Mitchell Semel & Colleen Carroll
Tessa Blake	Nancy Giles	Chris McCann	Robert Semple
Sally Bock & Mark Wurfel	Lloyd & Kitty Gilmour	James & Hannelore McDaniel	Bernice Baruch Shawl
Buzz Bovshow	Jessica Glass Pollack	Frances McDormand & Joel Coen	Sloane Shelton
Catherine Brophy	Judy Goldman & Michael Pillingier	Andrew McKeon	Jan Sidebotham & Tim Emerson
Becky Browder & Ted Neustadt	Tony Goldwyn & Jane Musky	Caitlin McLaughlin	Leslie Simitch
Deborah Brown	Vivian & Georges Gotlib	Amy Merrill	Stephanie Simpson & Larry Aeschlimann
Susan Bruce & Peter Hedges	Stephen & Cathy Graham	Audrey & Danny Meyer	Randy Sklar & Jason Sklar
Cora Cahan & Bernard Gersten	Connie Grappo & Lee Wilkof	Bette Midler	Tia Balsam & John Slattery
Louisa Campbell & Sven Travis	L. Stacy Greenwald	Judy Minor	Ken Smith
Kathy & Henry Chalfant	Colin Greer & Frances LaBarre	Ross Moore & Beth Moore	Lois Smith
Stockard Channing	Michael Greif	Robin Morse & Gus Rogerson	David Sneddon & Kristine Fleisher
Rachel Chanoff	Emily Grishman & Susan Sampliner	Mala & Sham Mosher	Abigail Rose Solomon
Glenda Chesshir	Eileen Guggenheim & Russell Wilkinson	Patricia M. Murphy, Esq. & Adam Spilka	Jeff Stafford
Peter & Laurie Clancy	Thomas Halikias	James Neuberger & Helen Stambler	Jean Stein
Patricia Clarkson & Tommy White	Evan Handler & Liz Timperman	Helen Stambler	Jerry Stillier & Anne Meara
Ruth Cohen	Margot Harley	Jim Neuwirth	Daniel Swee
Richard Cohn	Jane & Jonathan Heine	Steven O'Neill	Mariko Tada
Noel Comess	Cheryl Henson	Kevin O'Rourke & Edith Thurber	John & Marjorie Tedesco
Thomas Cott	Peter Herdrich & Karen Trott	Carol Ochs & Bruce MacVittie	Joan Vail & John Thorne
Margaret Crimmins	William Holtzman & S. Sylvia Shepard	Jacki Ochs & Jan Kroeze	Tracy & Edmund Thorne
Tom Cruise & Nicole Kidman	Barbara Howard	Paul & Maria Onderdonk	Marisa Tomei
Michael Curcio	Lauren Howard	Steven & Margot Peter	Anne Torsiglieri
Arthur Dantchik	Michelle Hurst	Bat-Sheva & Thomas Peters	Pamala Tyson & Séan Mudd
Peter & Judith Dawkins	Andrew Hurtwiz	Ethan Phillips	Laura Valeroso & David Seidman
Edward & Joanne DiRugieris	David Henry Hwang	Nicholas Platt & Robyn Watts	Wendy vanden Heuvel
Stephen Dubner	Amy Irving	Oliver Platt & Camilla Campbell Platt	John A. Vassilaros & Alexandra Gersten
Christopher & Karen Eddowes	Dana Ivey	Martha Plimpton	Mary Pat Walsh
Mario Egozi	Whitney Scott & Peter Jacobson	Richard Polatchek	Borah & Mildred Walton
David Eigenberg	Donna & Thomas Jaycox	Jeremy M. Posner	Wendy Wasserstein
Ned Eisenberg	Andrea Johnson	Dean & Leslie Potashner	Anita Waxman
Jacquelyn Elfert	Traci Paige Johnson & Robert Mowen	Michael Potts	Sally & Lenny Weiss
Heidi Ettinger	Robert Mowen	Christopher Randolph	Jane Bolster & Steve Wertimer
Wendy Ettinger & Derek McLane	Larry & Mary Jones	Peter & Helen Randolph	Jenny Wiener
Adam Felber & Jeannie Simpson	Lee Kalcheim & Julia Lord	Anthony Rapp	Michael & Zena Wiener
	Eric Karpeles & Mike Sell	Thomas Bingham Ray	Elizabeth Williams & Joseph Forte
	Ronald Kastner	Paul Reale & Barbara McCrane	Matt Williams & Angelina Fiordellisi
	Seth & Beth Klarman	Willie Reale & Jenny Gersten	Donald Windham
	May Kong	Keith Reddin & Leslie Lyles	Joanne Woodward & Paul Newman
		Gorman & Janice Reilly	Bill Wrubel
		Jacquelyn Reingold	Jeffrey & Janine Yass
			James & Mary Lin Yoshimura

The 52nd Street Project presents:



## The Fall 1999 Playmaking Series

Friday, Dec. 17 at 7:30 p.m.

Sat., Dec. 18 at 3:00 and 7:30 p.m.

Sun., Dec. 19 at 3:00 p.m.

*The Ensemble Studio Theatre, 549 West 52nd Street*



# Pie In The Sky: The Possibility Plays

The Fall, 1999 Playmaking Plays - Dec. 17-19, 1999  
The Ensemble Studio Theatre, New York City

## Project Staff

Gus Rogerson, Artistic Director  
Carol Ochs, Executive Director  
Michael Bernard, Associate Artistic Director  
John Sheehy, Director of Development and Marketing  
George Roman Babiak, Production Manager  
Julie Feldman, Director of Education  
Iris A. Brown, Graphic Designer  
Chris Ceraso, Guest Teacher  
Ray Ocasio and Mayleen Cancel - Receptionists  
Ariel Aver - Head Intern  
Jenny Campbell, Julissa Santana - Interns

## Production Staff

Rusty Magee, Composer  
Kevin Joseph Roach, Set Designer  
Greg MacPherson, Lighting Designer  
Crystal Thompson, Costume Designer  
Kurt Kellenberger, Sound Designer  
Jenny Peek, Stage Manager  
Slide Designers:  
George Babiak, Renato Castilho,  
Katherine Lumb, Adam Rodriguez,  
John Steward  
Foamcore Prop Design Team:  
Ariel Aver, George Babiak,  
Marta Espitia, Kilty Gilmour,  
Heidi James, Kevin Roach,  
Jeremy Seymour, Julissa Santana,  
Tom Schall, John Sheehy  
Slide Operator: Maury Schott

Furniture Crew:  
Jonathan Goldblatt,  
Johnathan Roldan  
Prop Crew:  
Grace Eboigbe, Mayleen Cancel  
Wall and Floor Props:  
Kim Mack, Julissa Santana  
House Managers:  
Karin Schall  
House Crew:  
Lisa Hamel  
Load-in & Light Hang Crew:  
Ariel Aver, Bill Charlton,  
J.D. Walsh, Vanessa Valdes  
Away Chef: Eric Karpeles  
Pie In The Sky illustration:  
Esther Geller

PROGRAM LAYOUT: GEORGE BABIAK

The 52nd Street Project is a non-profit organization that brings children from the Hell's Kitchen/Clinton neighborhood together with professional theater artists. **Pie In The Sky: The Possibility Plays** is part of our Playmaking program. Young people participate in an eight-week playwriting course taught by Michael Bernard and adapted for the Project by Daniel Judah Sklar from his book, *Playmaking: Children Writing and Performing Their Own Plays*. At the end of the course, each child is given two actors, a theme, and a dramaturg/director who guides him or her through the writing of a play during a weekend retreat in the country. Tonight's performance is the end result.

The Project is delighted to return to the Ensemble Studio Theatre where we have been performing since our inception in 1981. We gratefully acknowledge the fact that if E.S.T. wasn't here, we'd be nowhere.

## The 52nd Street Project Board of Directors

Ben Barenholtz	Patricia M. Murphy, Esq.
Lisa Benavides	Carol Ochs
Rachel Chanoff	Willie Reale
Ruth Cohen	Gus Rogerson
Heidi Ettinger	José Soto, Jr., <i>alumni boardmember</i>
Wendy Ettinger, <i>chair emeritus</i>	
Louis P. Friedman	Pamala Tyson
Stephen Graham	Laura Valeroso
Larry Jones	Wendy vanden Heuvel
James McDaniel	Jenny Wiener
Frances McDormand, <i>chairperson</i>	Elizabeth Williams

## Special Thanks To:

Our dear friends Eric Karpeles and Mike Sell who hosted all of us for a weekend writer's retreat in Tyler Hill, Pennsylvania. We're also grateful to Fred van Natta and Michael Post, Bonnie and Ryan Rutledge, Muriel and Bob Lindgren, the Cobb family, Sohail Raikhy, the Pursch family, and Frank and Pat Stoeckle for billeting adults and children over the weekend. Curt, Jamie, Eliza, and all the staff at Ensemble Studio Theatre get kudos as well, and we'd also like to thank everyone who recently helped us send out our Christmas fundraising mailer.

## In-Kind Contributions:

The Ensemble Studio Theatre; Neil A. Mazzella & Hudson Scenic Studios, Inc.; Shays & Murphy; Iris A. Brown & Bernhardt/Fudyma Design Group; Ron Kastner, Capital Printing; Masque Sound; New Dramatists; Steve Olsen & The West Bank Cafe; Materials for the Arts; Port Authority; Mayor's Office of Film & Television; John A. Vassilaros & Son; Paris Chocolates; Scholastic Productions; Coleman, Inc.; Watkins Products; Eric Karpeles & Mike Sell; Bill Muddyman and the Chateau de Berne; Ronald C. Fiorina and Boylan's Bottling Company; BMG; David Sneddon and Fairway Market; and Andy Millon.



The Playmaking Program is made possible with public funds from the National Endowment for the Arts; the New York State Council on the Arts, a state agency; the Department of Youth and Community Development; and the New York City Department of Cultural Affairs.



Don't miss our upcoming shows!

# The Two-on-Two's

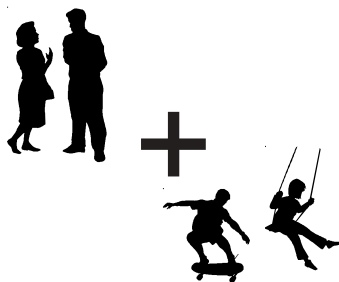

January 28-30, 2000  
at the Women's Interart Annex

In the One-on-One's, a single kid is paired with a single adult. Now you can see two kids (grizzled Project vets, this time) perform a play written by an adult and directed by *another* adult.

WINTER SERIES

# Playmaking



March 24-26, 2000  
at the Signature Theatre

In January, our next batch of newcomers will undertake the 10-week Playmaking program. At the end of the class they will be whisked away to Kent, Ct. for a weekend to fashion a set of plays. The only thing they need: an audience.

THE 52ND STREET PROJECT

# Annual Benefit

Monday, May 8, 1999  
at the Puck Building  
(Theme to be announced)

For information or reservations call  
**John Sheehy**, our wry but highly amusing  
Director of Marketing and Development, at  
(212) 333-5252



## Cool Stuff ON SALE IN THE LOBBY

**The Fabulous Flyer Bar (in five flavors)**  
\$2.00 and \$1.50 (\$1.00 for kids)

And featuring Shel Silverstein's "Fivey and Twoey" logo:

**Project T-Shirts (Short sleeve)** — \$12.00

**Project T-Shirts (Long sleeve)** — \$15.00

**Project Caps** — \$15.00

**Project Mugs** — \$5.00 (NEW COLOR AND DESIGN!)

**Project Pencils** — 3 for \$1.00

Thank you for coming to **PIE IN THE SKY: THE POSSIBILITY PLAYS**. If you are not on our mailing list (or if your address has changed), please fill out this form and give it to us on your way out or mail it to the address below. We would also like to know if you are interested in becoming a volunteer. We need help in **all areas**, so please fill out your name and phone number, and we'll call you.

PLEASE ADD ME TO YOUR MAILING LIST: 12/99

NAME \_\_\_\_\_

ADDRESS \_\_\_\_\_

ZIP \_\_\_\_\_

HOME PHONE \_\_\_\_\_

DAYTIME PHONE \_\_\_\_\_

YES, I WOULD LIKE TO BE OF HELP. I CAN:

- |   |   |  |
|---|---|--|
| <input type="checkbox"/> Help load in and out for shows | <input type="checkbox"/> Draw and/or paint  | <input type="checkbox"/> Help kids with homework |
| <input type="checkbox"/> Hang lights                    | <input type="checkbox"/> Help with mailings | <input type="checkbox"/> Teach kids a skill      |
| <input type="checkbox"/> Work on a backstage crew       | <input type="checkbox"/> Do office work     | <input type="checkbox"/> Be a chef at an event   |
| <input type="checkbox"/> Other (please specify) _____   |   |  |

MY SCHEDULE IS:

- Very flexible. I'm often available during weekdays.  
 Somewhat flexible. I can help on the occasional morning or afternoon during the week.  
 Not very flexible at all, but I've got some free time on evenings and weekends.

If you would like to mail this (and you're always welcome to enclose a tax-deductible contribution), you can send it to: The 52nd Street Project, 500 West 52nd St. New York, NY 10019. Or fax it to (212) 333-5598.

## Pie In the Sky: The Possibility Plays - ACT I

All original music composed by Rusty Magee

### Bully

By Ivana Lugo, age 10. Dramaturg/Director: Susan J. Vitucci  
Angel ..... L.Trey Wilson  
Maxine ..... Nedra Gallegos  
Budda ..... Jonathan Goldblatt  
Schoolkids ..... Backstage Crew

### Bad Good Luck Coins

By Giovanna Mendez, age 11. Dramaturg/Director: Cecilia Arana  
Tim ..... Paul Butler  
Betty Sue ..... Liliana Amador  
Painter ..... George Babiak  
Dog ..... Jonathan Goldblatt  
Firewoman ..... Julissa Santana

### Bob, The Hero of the Day

By Jonathan Hagemeyer, age 11. Dramaturg/Director: Greg Allen  
Agueman ..... Buzz Bovshow  
Bob ..... Jack Gwaltney  
*“Let’s All Go to the Hospital”* lyrics by Jonathan Hagemeyer

### The One Who Slept In The Doghouse

By Adalberto Rodriguez, age 10. Dramaturg/Director: Jyllian Gunther  
Cowboy Dog ..... Ray Anthony Thomas  
Test/Mr. Gray/Worker man ..... Tom Carozza

### Underwear Man and Kathy Get Married and Kathy Wins

By Frankie Ventura, age 9. Dramaturg/Director: Michael Bernard  
Kathy ..... Catherine Mueller  
Underwearman ..... Angel David  
Underwearmom ..... Annie Torsiglieri  
Crush, the champion wrestler ..... George Babiak  
Crazyman ..... Jonathan Goldblatt  
Unnamed wrestler ..... Gus Rogerson  
Teacher/Ref ..... Michael Bernard  
Cop ..... John Sheehy  
*“Underwearman and Kathy”* lyrics by Frankie Ventura

👉 I N T E R M I S S I O N 👈

## ACT II

### Alice and Ida

By Amelia Whitney, age 12. Dramaturg/Director: Kate Ryan  
Ida ..... Messeret Stroman  
Alice ..... Angelina Phillips  
Mr. Smith/Joe ..... George Babiak  
*“City Gals and a City Cow”* lyrics by Amelia Whitney

### Change of Life

By Marilyn Sanchez, age 10. Dramaturg/Director: Melissa Murray  
Wangaloo ..... Myra Lucretia Taylor  
Vangaleer ..... Angelina Fiordellisi  
Their moms ..... Grace Eboigbe  
Mosquitoes ..... Mayleen Cancel, Kim Mack  
French snobs ..... Jonathan Goldblatt, Johnathan Roldan,  
Julissa Santana

*“We’re Going Back”* lyrics by Marilyn Sanchez

### Dealing With The Principal

By Jason Bula, age 11. Dramaturg/Director: Josh Lewis  
Iceman ..... Alex Draper  
Crackerjack ..... Anna Li  
Principal ..... Gus Rogerson

### The Weird Battle Between Space Weirdo and Mr. Hunter

By Johnathan Ladines, age 9. Dramaturg/Director: David Schwab  
Space Weirdo ..... Yul Vazquez  
Mr. Hunter ..... Jenny Pollack  
*“The Ballad of Mr. Hunter and Space Weirdo”* lyrics by Johnathan Ladines.

### Nerds Strike Back

By Oscar Padilla, age 11. Dramaturg/Director: Tom Schall  
Wayne Nezbit ..... Billy Crudup  
Fat Bob/Mrs. Nezbit ..... Florencia Lozano  
Fat Bob’s Mom ..... Mayleen Cancel





The 52nd Street Project gratefully acknowledges the support of the following foundations and corporations: ABNY Foundation, Blythmour Corporation, Bertelsmann's World of Expression Foundation, Chase Manhattan Foundation, Comedy Central, The Crosby Fund, Cubic B's, The Dammann Fund, The Dramatists Guild Fund, Dramatists Play Service, The Educational Foundation of America, Ensemble Studio Theatre, Entertainment Weekly, EPIC, Fairway Market, The Fan Fox & Leslie R. Samuels Foundation, Gap Inc., GLADPPZ Foundation, The Horace W. Goldsmith Foundation, The William and Mary Greve Foundation, Heights Partners, The Hennessy Foundation, The Holland Lodge Foundation, Inc., Jeopardy!, Betty E. and George B. Kaiser Foundation, Rita J. and Stanley H. Kaplan Foundation, Lloyds Bank, MCJ Foundation, James A. Macdonald Foundation, Ann M. Martin Foundation, The Morris and Helen Messing Foundation, J.P. Morgan Charitable Trust, The Morgan Stanley Dean Witter Foundation, The William Morris Agency, The New World Foundation, Newman's Own, Nickelodeon, O'Grady Family Foundation, Laura Pels Foundation, Pew Charitable Trust, The Rockefeller Foundation, Staging and Design, Inc., The Harold & Mimi Steinberg Charitable Trust, Susquehanna, John A. Vassilaros & Sons, Inc, The Wiener Family Foundation, Yorke Construction Corporation. In addition the following individuals made gifts of over \$150 to The 52nd Street Project this year (list is current as of 1/25/00):

Anonymous  
Jace Alexander & Maddie Corman  
Franco Aller  
May Ameen  
Kevin Anderson & Dawn Spence  
June Ballinger & Michael Goldstein  
Jeremy Barber  
Ben Barenholtz  
Jessica Bauman  
Neena Beber  
Laurie Becker & Rick Sweren  
Meredith Beuwkes  
Steve Belber  
Lisa Belzberg  
Lisa Benavides & Tim Nelson  
Kenneth Bennett  
Scott Bergman  
Barry & Myrna Bernard  
Alexander & Elizabeth Bernstein  
Lewis Black  
Tessa Blake  
Sally Bock & Mark Wurfel  
Buzz Bovshow  
Catherine Brophy  
Becky Browder & Ted Neustadt  
Deborah Brown  
Susan Bruce & Peter Hedges  
Cora Cahan & Bernard Gersten  
Louisa Campbell & Sven Travis  
Kathy & Henry Chalfant  
Stockard Channing  
Rachel Chanoff  
Glenda Chesshir  
Peter & Laurie Clancy  
Patricia Clarkson & Tommy White  
Ruth Cohen  
Richard Cohn  
Noel Comess  
Thomas Cott  
Margaret Crimmins  
Tom Cruise & Nicole Kidman  
Michael Curcio  
Arthur Dantchik  
Peter & Judith Dawkins  
Edward & Joanne DiRuggeris  
Stephen Dubner  
Christopher & Karen Eddowes  
Mario Egozi  
David Eigenberg  
Ned Eisenberg  
Barbara Ettinger  
Heidi Ettinger  
Wendy Ettinger & Derek McLane  
Adam Felber & Jeanne Simpson  
Gerald Fernandez  
Peter Jay Fernandez &  
Denise Burse  
Joan Fields  
Hannah Finn  
Alexa Fogel

Katherine Foster  
Michael J. Fox & Tracy Pollan  
David Frankel  
Eric & Juli Frankel  
Naomi & Charles Freundlich  
Lois Fricke & Todd Hollander  
Louis & Patrice Friedman  
Judith Garson &  
Steven Rappoport  
Rose Gasner & Larry Chertoff  
Jillian Gersten  
Ileen Getz & Mark Grinnell  
Nancy Giles  
Lloyd & Kilty Gilmour  
Judy Goldman & Michael Pillinger  
Tony Goldwyn & Jane Musky  
Vivian & Georges Gottlieb  
Stephen & Cathy Graham  
Connie Grappo & Lee Wilkof  
Myrna & Stephen Greenberg  
L. Stacy Greenwald  
Colin Greer & Frances LaBarre  
Michael Greif  
Emily Grishman &  
Susan Sampliner  
Lisa Gugenheim  
Eileen Guggenheim &  
Russell Wilkinson  
Thomas Halikias  
Evan Handler &  
Elizabeth Timperman  
Louis Feraud Paris  
Margot Harley  
Jane & Jonathan Heine  
Cheryl Henson  
Peter Herdrich & Karen Trott  
William Holtzman &  
S. Sylvia Shepard  
Barbara Howard  
Lauren Howard  
Michelle Hurst  
Andrew Hurtwiz  
David Henry Hwang  
Amy Irving  
Dana Ivey  
Sy Jacobs  
Whitney Scott & Peter Jacobson  
Donna & Thomas Jaycox  
Traci Paige Johnson &  
Robert Mowen  
Larry & Mary Jones  
Betty E. &  
George B. Kaiser Foundation  
Lee Kalcheim & Julia Lord  
Eric Karpelas & Mike Sell  
Ronald Kasner  
Seth & Beth Klarman  
Mary Kong  
Judy Kuhn & David Schwab  
Roger & Belle Kuhn

Kate Lear & Jonathan LaPook  
Cyndi Lee  
Warren Leight  
Mitchell Lemsky & Jane Bodle  
Becky & Steven Lewis  
John Bedford Lloyd &  
Anne Twomey  
Greg MacPherson &  
Jane Perlmutter  
Roma Maffia  
Paul & Lauren Mandell  
Elizabeth Manne  
Peter Manning & André Bishop  
Ali Marsh  
Kay Matschullat & Alan Arffa  
Max Mayer & Catherine Corpeny  
Chris McCann  
Paul McCrane & Dana Kellin  
James & Hannelore McDaniel  
Fran McDormand & Joel Coen  
Andrew McKeon  
Caitlin McLaughlin  
Audrey & Danny Meyer  
Bette Midler  
Judy Minor  
Ross Moore & Beth Moore  
Mala & Sham Mosher  
Patricia M. Murphy, Esq. &  
Adam Spilka  
Randy & Rona Nelson  
Ruth Nelson  
James Neuberger &  
Helen Stambler  
Steven O'Neill  
Kevin O'Rourke & Edith Thurber  
Carol Ochs & Bruce MacVittie  
Jacki Ochs & Jan Kroeze  
Paul & Maria Onderdonk  
Steven & Margot Peter  
Bal-Sheva & Thomas Peters  
Virginia Pike  
Nicholas Platt &  
Robyn Watts  
Oliver Platt &  
Camilla Campbell Platt  
Martha Plimpton  
Richard Polatchek  
Jeremy Posner  
Dean & Leslie Potashner  
Michael Potts  
Christopher Randolph  
Peter & Helen Randolph  
Anthony Rapp  
Thomas Bingham Ray  
Paul Reale & Barbara McCrane  
Willie Reale & Jenny Gersten  
Gorman & Janice Reilly  
Todd Richter & Donna Plummer  
C.C. & Geraldo Rivera  
David & Anita Rogerson

Robin Morse & Gus Rogerson  
Martha Roth & Bill Irwin  
Donald Rothschild &  
Lottchen Shivers  
Crystal & Michael Sabatino  
Steve Sabba  
Richard & Madeline Salzman  
Vir Hugo & Rosemarie Samson  
Jane & Joseph Sangerman  
Don Scardino  
Karin & Tom Schall  
Leslie Schine & Nils Nielsen  
Maury Schott  
Jeffrey Schwartz  
Cynthia & Paul Scrudato  
Stefan Selig  
Mitchell Semel & Colleen Carroll  
Robert Semple  
Bernice Baruch Shawl  
Sloane & Jan Shelton  
Jan Sidebotham & Tim Emerson  
Leslie Simitch  
Meg Simon  
Stephanie Simpson &  
Larry Aeschlimann  
Randy Sklar & Jason Sklar  
Tia Balsam & John Slattery  
Ken Smith  
Lois Smith  
David Sneddon & Kristine Fleisher  
Abigail Rose Solomon  
Jean Stein  
Anne Meara & Jerry Stiller  
Daniel Sweet  
Marko Tada  
John & Marjorie Tedesco  
Joan Vail & John Thome  
Tracy & Edmund Thorne  
Sean & Pamela Tyson-Mudd  
Laura Valeroso & David Seidman  
Wendy vanden Heuvel  
John A. Vassilaros &  
Alexandra Gersten  
Mary Pat Walsh  
Borah & Mildred Walton  
Wendy Wasserstein  
Anita Waxman  
Sally & Lenny Weiss  
Jane Bolster & Steve Wertimer  
Jenny Wiener  
Michael & Zena Wiener  
Elizabeth Williams &  
Joseph Forte  
Donald Wintham  
Joanne Woodward &  
Paul Newman  
Anne & Charles Wright  
Bill Wrubel  
Jeffrey & Janine Yass  
James & Mary Lin Yoshimura

The 52nd Street Project Presents:



## The 2000 Two-On-Twos

The Women's Interart Annex,  
500 West 52nd St., New York City

Friday, January 28, 7:30 p.m.  
Saturday, January 29, 3:00 and 7:30 p.m.  
Sunday, January 30, 3:00 and 7:30 p.m.



# Through Thick and Thin

## The Reliable Plays

The 2000 Two-on-Twos - January 28-30, 2000  
The Women's Interart Annex, New York City

### Project Staff

Gus Rogerson, Artistic Director  
Carol Ochs, Executive Director  
Michael Bernard, Associate Artistic Director  
John Sheehy, Director of Development and Marketing  
George "X-Acto" Babiak, Production Manager  
Julie "7 X 8" Feldman-Abe, Director of Education  
Iris A. Brown, Graphic Designer  
Mayleen Cancel, Zsuzsa Mysak, and Ray Ocasio - Receptionists  
Liz Lord, Caroline Sharman, Julissa Santana, Jenny Campbell - Interns

### Production Staff

Patrick Barnes, Composer  
Greg MacPherson, Lighting Designer  
Kevin Joseph Roach, Set Designer  
Sheila Kehoe, Costume Designer  
Dan Carlson, Sound Designer  
Carol Cate, Stage Manager  
Robin C. Gillette,  
Stand-by Stage Manager  
Slide Design Chief: Katherine Lumb  
Slide Designers:  
George Babiak, Renato Castilho,  
Katherine Lumb, Adam Rodriguez,  
John Steward  
Foamcore Prop Design Team:  
Annika Ahlstrom, George Babiak,  
Heather Carnduff, Elissa Errick,  
Michael Kleats, Liz Lord,  
Susan McGinnis, Yvonne Pollack,  
Jeremy Seymour, John Sheehy  
Slide Operator: Maury Schott

Furniture Crew:  
Stephen Barker Turner,  
Jonathan Roldan, Noel Polanco  
Prop Crew: Liz Lord, Steven Bula  
Wall Props: Jed Clarke  
House Managers:  
Mary Pat Walsh,  
Karin Schall, Jenny Peek  
Load-in & Light Hang Crew:  
Bill Charlton, Liz Lord, Tom Schall,  
Caroline Sharman, John Sheehy  
Away Chefs:  
Daniel Swee, Carol Ochs, and  
John Sheehy  
*Thick and Thin* Illustration:  
Adam Rodriguez  
Root Beer Float Servers:  
"Sting" Ray Ocasio, Sahara Walsh,  
Susan McGinnis, Jenny Peek,  
Angela Trento

PROGRAM LAYOUT: GEORGE BABIAK

The 52nd Street Project is a non-profit organization that brings inner-city children from the Clinton neighborhood together with professional theater artists to create theater. **THROUGH THICK AND THIN** is part of our Two-On-Two program, in which two of the Project's more seasoned kids are matched with two adult Project volunteers (one playwright, one director) and given the task of creating a short play. Each year, the duos travel *en masse* to Dutchess County, New York to rehearse the plays over a three-day weekend. This show is the fruit of their labors.

### The 52nd Street Project Board of Directors

Ben Barenholtz	Patricia M. Murphy, Esq.
Lisa Benavides	Carol Ochs
Rachel Chanoff	Willie Reale
Ruth Cohen	Gus Rogerson
Heidi Ettinger	José Soto, Jr., <i>alumni boardmember</i>
Wendy Ettinger, <i>chair emeritus</i>	Pamala Tyson
Louis P. Friedman	Laura Valeroso
Stephen Graham	Wendy vanden Heuvel
Larry Jones	Jenny Wiener
James McDaniel	Elizabeth Williams
Frances McDormand, <i>chairperson</i>	

### Special Thanks To...

...our friends Margot, Ronnie, Paul and the Women's Interart for donating the use of their performance space; Fran McDormand and Joel Coen, Maria Tucci, and Wendy Ettinger and Derek McLane for letting us stay in their homes during our weekend away; Mary Moore and D'Agostino's for the ice cream in the floats tonight; Ron Fiorina and Boylan's Bottling Co. for the soda that we poured onto the ice cream; and, finally, Vanessa Valdes for her sound advice.

### In-Kind Contributions:

Curt, Jamie, Eliza, Christine, and all the staff at Ensemble Studio Theatre; Primary Stages; Colorforms; Neil A. Mazzella & Hudson Scenic Studios, Inc.; Shays & Murphy; Iris A. Brown & Bernhardt/Fudyma Design Group; Ron Kastner, Capital Printing; Masque Sound; Steve Olsen & The West Bank Cafe; Materials for the Arts; Port Authority; Mayor's Office of Film & Television; John A. Vassilaros & Son; Paris Chocolates; Scholastic Productions; Coleman, Inc.; Watkins Products; Eric Karpeles & Mike Sell; Bill Muddyman and the Chateau de Berne; Ronald C. Fiorina and Boylan's Bottling Company; BMG; John Steward; David Sneddon and Fairway Market; and Andy Millon.



The Two-On-Two Program is made possible with public funds from the National Endowment for the Arts, New York State Council on the Arts, a state agency, the Department of Youth and Community Development, and the New York City Department of Cultural Affairs.



Don't miss our upcoming shows!

# Playmaking



March 24, 25, & 26

at The Peter Norton Space

(Hosted by Signature Theatre Company)

555 W. 42nd St., between 10th and 11th Avenues



This month, our next batch of newcomers began the 8-week Playmaking program. At the end of the class they will be whisked away to Kent, Connecticut for a weekend to fashion a set of plays. The only thing they need: an audience.

Just when you thought it was safe to go to the benefit...

# AARGH!!

The 52nd Street Project's  
Piratical Benefit!

Monday, May 8, 2000  
The Puck Building

Honorary Co-chairs: Kevin Kline  
and a special guest  
to be named later

For information call  
Capt. Long John Sheehy  
at (212) 333-5252.



## Cool Stuff

ON SALE IN THE LOBBY

The Fabulous Flyer Bar (in five flavors)

\$2.00 and \$1.50 (\$1.00 for kids)

And featuring Shel Silverstein's "Fivey and Twoey" logo:

Project T-Shirts (Short sleeve) — \$12.00

Project T-Shirts (Long sleeve) — \$15.00

Project Caps — \$15.00

Project Mugs — \$5.00 (NEW COLOR AND DESIGN!)

Project Pencils — 3 for \$1.00 (NEW COLOR AND DESIGN!)

Thank you for coming to **Through Thick & Thin: The Reliable Plays**. If you are not on our mailing list (or if your address has changed), please fill out this form and give it to us on your way out or mail it to the address below. We would also like to know if you are interested in becoming a volunteer. We need help in **all areas**, so please fill out your name and phone number, and we'll call you.

**PLEASE ADD ME TO YOUR MAILING LIST:**

1/00

NAME \_\_\_\_\_

ADDRESS \_\_\_\_\_

ZIP \_\_\_\_\_

HOME PHONE \_\_\_\_\_

DAYTIME PHONE \_\_\_\_\_

**YES, I WOULD LIKE TO BE OF HELP. I CAN:**

- |   |   |  |
|---|---|--|
| <input type="checkbox"/> Help load in and out for shows | <input type="checkbox"/> Draw and/or paint  | <input type="checkbox"/> Help kids with homework |
| <input type="checkbox"/> Hang lights                    | <input type="checkbox"/> Help with mailings | <input type="checkbox"/> Teach kids a skill      |
| <input type="checkbox"/> Work on a backstage crew       | <input type="checkbox"/> Do office work     | <input type="checkbox"/> Be a chef at an event   |
| <input type="checkbox"/> Other (please specify) _____   |   |  |

**MY SCHEDULE IS:**

- Very flexible. I'm often available during weekdays.
- Somewhat flexible. I can help on the occasional morning or afternoon during the week.
- Not very flexible at all, but I've got some free time on evenings and weekends.

If you would like to mail this (and you're always welcome to enclose a tax-deductible contribution), you can send it to: The 52nd Street Project, 500 West 52nd St. New York, NY 10019. Or fax it to (212) 333-5598.

## Through Thick & Thin: ACT I

All original music composed by Patrick Barnes

### The Northern Line

Written by Tim Blake Nelson

Directed by Eris Migliorini

Ole Sammy ..... Aisha Jabour

Beuford ..... Isaac Trujillo

Railroad Bull ..... Noel Polanco

Hobo Chorus ..... The crew

*The Ballad of Beuford and Crazy Like A Bunny*, lyrics by

Tim Blake Nelson

### The Mirror

Written by Tim and Michelle Meadows

Directed by Liz Tuccillo

Dad ..... Jonathan Villanueva

Lucia ..... Alejandra Rodriguez

Mirror dancers ..... featuring Jed Clarke

with Liz Lord, Steven Barker Turner, and Noel Polanco

*Letter from Aunt Patsy, The Mirror, Letter from Lucia* lyrics by

Tim Meadows

### Speak Up!

Written by Regina Porter

Directed by Anne Torsiglieri

Colette Diaz ..... Mayleen Cancel

Anna Fuentes ..... Vionel Ortiz

Voice ..... Carol Ochs

Radio announcer ..... Stephen Barker Turner

*My Best Girl*, lyrics by Regina Porter

☞ I N T E R M I S S I O N ☜

## Through Thick & Thin: ACT II

### She's Da Bomb

Written by Susan Kim

Directed by Zabryna Guevara

Agent QX-5 ..... Zaida Natera

Agent G3-7 ..... Yazzy Troche

Molasses Pirelli ..... Johnathan Roldan

Subway passengers ..... The crew

*The Spy Who Liked Me*, lyrics by Adam Felber

Note: The credits for the above show contain every letter in the alphabet. *Believe It Or Not!*

### Unexpected Tail

Written by Mo Rocca

Directed by Adam Felber

Judy Hack ..... Christina Ramirez

Brad Rat ..... Jayme Rosado

*A Rat With A Bat*, lyrics by Mo Rocca

### The Blue Carlotta

Written by Willie Reale

Directed by Gus "The Big Chainring" Rogerson

Quimby ..... Matthew Jellison

Rumbleton ..... Joel Lind

Computer Voice ..... Stephen Barker Turner

*The Old Ennui, Zelda, and The Blue Carlotta*, lyrics by Willie

Reale

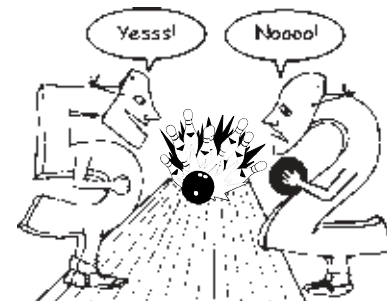

The 52nd Street Project gratefully acknowledges the support of the following foundations and corporations: ABNY Foundation, Blythmour Corporation, Bertelsmann's World of Expression Foundation, Chase Manhattan Foundation, Comedy Central, The Crosby Fund, Cubic B's, The Dammann Fund, The Dramatists Guild Fund, Dramatists Play Service, The Educational Foundation of America, Ensemble Studio Theatre, Entertainment Weekly, EPIC, Fairway Market, The Fan Fox & Leslie R. Samuels Foundation, Gap Inc., GLADPPZ Foundation, The Horace W. Goldsmith Foundation, The William and Mary Greve Foundation, Heights Partners, The Hennessy Foundation, The Holland Lodge Foundation, Inc., Jeopardy!, Betty E. and George B. Kaiser Foundation, Rita J. and Stanley H. Kaplan Foundation, Lloyds Bank, MCJ Foundation, James A. Macdonald Foundation, Ann M. Martin Foundation, The Morris and Helen Messing Foundation, J.P. Morgan Charitable Trust, The Morgan Stanley Dean Witter Foundation, The William Morris Agency, The New World Foundation, Newman's Own, Nickelodeon, O'Grady Family Foundation, Laura Pels Foundation, Pew Charitable Trust, The Rockefeller Foundation, Staging and Design, Inc., The Harold & Mimi Steinberg Charitable Trust, Susquehanna, John A. Vassilaros & Sons, Inc, The Wiener Family Foundation, Yorke Construction Corporation. In addition the following individuals made gifts of over \$150 to The 52nd Street Project this year (list is current as of 1/25/00):

Anonymous  
Jace Alexander & Maddie Corman  
Franco Aller  
May Ameen  
Kevin Anderson & Dawn Spence  
June Ballinger & Michael Goldstein  
Jeremy Barber  
Ben Barenholtz  
Jessica Bauman  
Neena Beber  
Laurie Becker & Rick Sweren  
Meredith Beuwkes  
Steve Belber  
Lisa Belzberg  
Lisa Benavides & Tim Nelson  
Kenneth Bennett  
Scott Bergman  
Barry & Myrna Bernard  
Alexander & Elizabeth Bernstein  
Lewis Black  
Tessa Blake  
Sally Bock & Mark Wurfel  
Buzz Bovshow  
Catherine Brophy  
Becky Browder & Ted Neustadt  
Deborah Brown  
Susan Bruce & Peter Hedges  
Cora Cahan & Bernard Gersten  
Louisa Campbell & Sven Travis  
Kathy & Henry Chalfant  
Stockard Channing  
Rachel Chanoff  
Glenda Chesshir  
Peter & Laurie Clancy  
Patricia Clarkson & Tommy White  
Ruth Cohen  
Richard Cohn  
Noel Comess  
Thomas Cott  
Margaret Crimmins  
Tom Cruise & Nicole Kidman  
Michael Curcio  
Arthur Dantchik  
Peter & Judith Dawkins  
Edward & Joanne DiRuggeris  
Stephen Dubner  
Christopher & Karen Eddowes  
Mario Egozi  
David Eigenberg  
Ned Eisenberg  
Barbara Ettinger  
Heidi Ettinger  
Wendy Ettinger & Derek McLane  
Adam Felber & Jeanne Simpson  
Gerald Fernandez  
Peter Jay Fernandez &  
Denise Burse  
Joan Fields  
Hannah Finn  
Alexa Fogel

Katherine Foster  
Michael J. Fox & Tracy Pollan  
David Frankel  
Eric & Juli Frankel  
Naomi & Charles Freundlich  
Lois Fricke & Todd Hollander  
Louis & Patrice Friedman  
Judith Garson &  
Steven Rappoport  
Rose Gasner & Larry Chertoff  
Jillian Gersten  
Ileen Getz & Mark Grinnell  
Nancy Giles  
Lloyd & Kilty Gilmour  
Judy Goldman & Michael Pillinger  
Tony Goldwyn & Jane Musky  
Vivian & Georges Gollib  
Stephen & Cathy Graham  
Connie Grappo & Lee Wilkof  
Myrna & Stephen Greenberg  
L. Stacy Greenwald  
Colin Greer & Frances LaBarre  
Michael Greif  
Emily Grishman &  
Susan Sampliner  
Lisa Gugenheim  
Eileen Guggenheim &  
Russell Wilkins  
Thomas Halikias  
Evan Handler &  
Elizabeth Timperman  
Louis Feraud Paris  
Margot Harley  
Jane & Jonathan Heine  
Cheryl Henson  
Peter Herdrich & Karen Trott  
William Holtzman &  
S. Sylvia Shepard  
Barbara Howard  
Lauren Howard  
Michelle Hurst  
Andrew Hurtwiz  
David Henry Hwang  
Amy Irving  
Dana Ivey  
Sy Jacobs  
Whitney Scott & Peter Jacobson  
Donna & Thomas Jaycox  
Traci Paige Johnson &  
Robert Mowen  
Larry & Mary Jones  
Betty E. &  
George B. Kaiser Foundation  
Lee Kalcheim & Julia Lord  
Eric Karpelas & Mike Sell  
Ronald Kastner  
Seth & Beth Klarman  
Mary Kong  
Judy Kuhn & David Schwab  
Roger & Belle Kuhn

Kate Lear & Jonathan LaPook  
Cyndi Lee  
Warren Leight  
Mitchell Lemsky & Jane Bodle  
Becky & Steven Lewis  
John Bedford Lloyd &  
Anne Twomey  
Greg MacPherson &  
Jane Perlmutter  
Roma Maffia  
Paul & Lauren Mandell  
Elizabeth Manne  
Peter Manning & André Bishop  
Ali Marsh  
Kay Matschullat & Alan Arffa  
Max Mayer & Catherine Corpeny  
Chris McCann  
Paul McCrane & Dana Kellin  
James & Hannelore McDaniel  
Fran McDormand & Joel Coen  
Andrew McKeon  
Caitlin McLaughlin  
Audrey & Danny Meyer  
Bette Midler  
Judy Minor  
Ross Moore & Beth Moore  
Mala & Sham Mosher  
Patricia M. Murphy, Esq. &  
Adam Spilka  
Randy & Rona Nelson  
Ruth Nelson  
James Neuberger &  
Helen Stambler  
Steven O'Neill  
Kevin O'Rourke & Edith Thurber  
Carol Ochs & Bruce MacVittie  
Jacki Ochs & Jan Kroeze  
Paul & Maria Onderdonk  
Steven & Margot Peter  
Bal-Sheva & Thomas Peters  
Virginia Pike  
Nicholas Platt &  
Robyn Watts  
Oliver Platt &  
Camilla Campbell Platt  
Martha Plimpton  
Richard Polatchek  
Jeremy Posner  
Dean & Leslie Potashner  
Michael Potts  
Christopher Randolph  
Peter & Helen Randolph  
Anthony Rapp  
Thomas Bingham Ray  
Paul Reale & Barbara McCrane  
Willie Reale & Jenny Gersten  
Gorman & Janice Reilly  
Todd Richter & Donna Plummer  
C.C. & Geraldo Rivera  
David & Anita Rogerson

Robin Morse & Gus Rogerson  
Martha Roth & Bill Irwin  
Donald Rothschild &  
Lottchen Shivers  
Crystal & Michael Sabatino  
Steve Sabba  
Richard & Madeline Salzman  
Vir Hugo & Rosemarie Samson  
Jane & Joseph Sangerman  
Don Scardino  
Karin & Tom Schall  
Leslie Schine & Nils Nielsen  
Maury Schott  
Jeffrey Schwartz  
Cynthia & Paul Scrudato  
Stefan Selig  
Mitchell Semel & Colleen Carroll  
Robert Semple  
Bernice Baruch Shawl  
Sloane & Jan Shelton  
Jan Sidebotham & Tim Emerson  
Leslie Simitch  
Meg Simon  
Stephanie Simpson &  
Larry Aeschlimann  
Randy Sklar & Jason Sklar  
Tia Balsam & John Slattery  
Ken Smith  
Lois Smith  
David Sneddon & Kristine Fleisher  
Abigail Rose Solomon  
Jean Stein  
Anne Meara & Jerry Stiller  
Daniel Sweet  
Mariko Tada  
John & Marjorie Tedesco  
Joan Vail & John Thorne  
Tracy & Edmund Thorne  
Sean & Pamela Tyson-Mudd  
Laura Valeroso & David Seidman  
Wendy vanden Heuvel  
John A. Vassilaros &  
Alexandra Gersten  
Mary Pat Walsh  
Borah & Mildred Walton  
Wendy Wasserstein  
Anita Waxman  
Sally & Lenny Weiss  
Jane Bolster & Steve Wertimer  
Jenny Wiener  
Michael & Zena Wiener  
Elizabeth Williams &  
Joseph Forte  
Donald Windham  
Joanne Woodward &  
Paul Newman  
Anne & Charles Wright  
Bill Wrubel  
Jeffrey & Janine Yass  
James & Mary Lin Yoshimura

The 52nd Street Project Presents:



ESTHER GELLER

## The Winter, 2000 Playmaking Plays

The Peter Norton Space  
*Home of the Signature Theatre Company*  
555 West 42nd St., New York City

Friday, March 24, 7:30 p.m.  
Saturday, March 25, 3:00 and 7:30 p.m.  
Sunday, March 26, 3:00



# Follow Your Nose Plays of Instinct

The Winter, 2000 Playmaking Plays - March 24-26  
The Peter Norton Space, New York City



## PROJECT STAFF

Gus Rogerson, Artistic Director  
Carol Ochs, Executive Director  
Michael Bernard, Associate Artistic Director  
John Sheehy, Director of Development and Marketing  
George "X-Acto" Babiak, Production Manager  
Julie "7 X 8" Feldman-Abe, Director of Education  
Iris A. Brown, Graphic Designer  
Mayleen Cancel, Zsuzsa Mysak, and Ray Ocasio - Receptionists  
Liz Lord, Amy Johnston, Caroline Sharman, Jenny Campbell - Interns

## PRODUCTION STAFF

**Composer:** Rusty Magee

**Lighting Designers:**

Greg MacPherson, Elissa Errick

**Set Designer:** Kevin Joseph Roach

**Costume Designer:** Julie Ann Fiscoff

**Sound Designer:** Vanessa Valdes

**Stage Manager:** Jenny Peek

**Slide Design Chief:** Katherine Lumb

**Slide Designers:**

George Babiak, Renato Castilho,

Adam Rodriguez, John Steward

**Foamcore Prop Design Team:**

George Babiak, Heather Carnduff,

Elissa Errick, Mary Grieco,

Amy Johnston, Michael Kleats,

Mona Lipson, Liz Lord, John Sheehy

**Slide Operator:** Maury Schott

**Furniture Crew:**

Jaime Sandoz, Johnathan Roldan,

Mary Vamvoukakis

**Prop Crew:**

Caroline Sharman,

Osage Ashley-Lewis

**Wall Props:**

Amy Johnston

**House Managers:**

Beth Emelson,

Mary Pat Walsh

**Electricians:**

Mona Arriola

Sybil Killian

**Load-in/Light Hang Volunteer Crew:**

Alan Bernstein, Amy Johnston,

Liz Lord, Cellis Mills,

Kevin Joseph Roach, Jill Robbins,

Tom Schall, Caroline Sharman,

John Sheehy, Patty Spahn,

Vanessa Valdes

**Follow Your Nose Illustration:**

Esther Geller

PROGRAM LAYOUT: GEORGE BABIAK

The **52nd Street Project** is a non-profit organization that brings children from the Hell's Kitchen/Clinton neighborhood together with professional theater artists. **Follow Your Nose: Plays of Instinct** is part of our Playmaking program. Young people participate in an eight-week playwriting course taught by Michael Bernard and adapted for the Project by Daniel Judah Sklar from his book, *Playmaking: Children Writing and Performing Their Own Plays*. At the end of the course, each child is given two actors, a theme, and a dramaturg/director who guides him or her through the writing of a play during a weekend retreat in the country. Tonight's performance is the end result.

## The 52nd Street Project Board of Directors

Ben Barenholtz

Lisa Benavides

Rachel Chanoff

Ruth Cohen

Heidi Ettinger

Wendy Ettinger,  
*chair emeritus*

Louis P. Friedman

Stephen Graham

Larry Jones

James McDaniel

Frances McDormand, *chairperson*

Patricia M. Murphy, Esq.

Carol Ochs

Willie Reale

Gus Rogerson

José Soto, Jr.,

*alumni boardmember*

Pamala Tyson

Laura Valeroso

Wendy vanden Heuvel

Jenny Wiener

## Special Thanks

We're very grateful to Stephen and Kathy Graham and to Jenny Wiener and her family for hosting the kids and their Dramaturg/Directors in Connecticut over the weekend of March 4-6. Thanks also to James Houghton, Brian Duea, Richard Kuranda, Andrew Hancock, Carol Lee, and all the other staff members of the Signature Theater.

## In-Kind Contributions:

Neil A. Mazzella & Hudson Scenic Studios, Inc.; Shays & Murphy; Iris A. Brown; Ron Kastner, Capital Printing; Masque Sound; Steve Olsen & The West Bank Cafe; Materials for the Arts; Port Authority; Mayor's Office of Film & Television; John A. Vassilaros & Son; Paris Chocolates; Scholastic Productions; Coleman, Inc.; Watkins Products; Eric Karpeles & Mike Sell; Bill Muddyman and the Chateau de Berne; Ronald C. Fiorina and Boylan's Bottling Company; BMG; John Steward; David Sneddon and Fairway Market; and Andy Millon.



The Playmaking Program is made possible with public funds from the National Endowment for the Arts, New York State Council on the Arts, a state agency, the Department of Youth and Community Development, and the New York City Department of Cultural Affairs.



## Don't miss our upcoming shows!

Just when you thought it was safe to go to the benefit...

# AARGH!!

The 52nd Street Project's  
Piratical Benefit!

**Monday, May 8, 2000**  
**The Puck Building**

**Honorary Co-chairs:**  
**Edie Falco and Kevin Kline**

For information call  
Capt. Long John Sheehy  
at (212) 333-5252.



*Coming (July dates) and (August dates)*

The Block Island, R.I. and Tyler Hill, Pa.

# ONE-on-ONES

*A recipe so simple you can prepare it in your own home:*

1. Take a kid.
2. Assign an adult to write a play for the two of them to perform.
3. Multiply by 10.
4. Take all 10 pairs away for a week in the country to rehearse. Mix well.
5. Return to the city and pour entire batch into an empty theatre.
6. Garnish with foamcore.
7. Laugh, cry, and cheer liberally.
8. Do it all again a month later with fresh ingredients

*Do it all yourself, or just come and watch the shows **we** produce!*

## Cool Stuff ON SALE IN THE LOBBY

**The Fabulous Flyer Bar (in five flavors)**

\$2.00 and \$1.50 (\$1.00 for kids)

*And featuring Shel Silverstein's "Fivey and Twoey" logo:*

**Project T-Shirts (Short sleeve) — \$12.00**

**Project T-Shirts (Long sleeve) — \$15.00**

**Project Caps — \$15.00**

**Project Mugs — \$5.00 (NEW COLOR AND DESIGN!)**

**Project Pencils — 3 for \$1.00 (NEW COLOR AND DESIGN!)**

Thank you for coming to **Follow Your Nose: Plays of Instinct**. If you are not on our mailing list (or if your address has changed), please fill out this form and give it to us on your way out or mail it to the address below. We would also like to know if you are interested in becoming a volunteer. We need help in **all areas**, so please fill out your name and phone number, and we'll call you.

**PLEASE ADD ME TO YOUR MAILING LIST:**

3/00

NAME \_\_\_\_\_

ADDRESS \_\_\_\_\_

ZIP \_\_\_\_\_

HOME PHONE \_\_\_\_\_

DAYTIME PHONE \_\_\_\_\_

**YES, I WOULD LIKE TO BE OF HELP. I CAN:**

- |   |   |  |
|---|---|--|
| <input type="checkbox"/> Help load in and out for shows | <input type="checkbox"/> Draw and/or paint  | <input type="checkbox"/> Help kids with homework |
| <input type="checkbox"/> Hang lights                    | <input type="checkbox"/> Help with mailings | <input type="checkbox"/> Teach kids a skill      |
| <input type="checkbox"/> Work on a backstage crew       | <input type="checkbox"/> Do office work     | <input type="checkbox"/> Be a chef at an event   |
| <input type="checkbox"/> Other (please specify) _____   |   |  |

**MY SCHEDULE IS:**

- Very flexible. I'm often available during weekdays.
- Somewhat flexible. I can help on the occasional morning or afternoon during the week.
- Not very flexible at all, but I've got some free time on evenings and weekends.

*If you would like to mail this (and you're always welcome to enclose a tax-deductible contribution), you can send it to: The 52nd Street Project, 500 West 52nd St. New York, NY 10019. Or fax it to (212) 333-5598.*

## Follow Your Nose: Plays of Instinct - Act I

All original music composed by Rusty Magee

### A Vacation in Miami

By Margarita Gueorgueva, age 10.

Dramaturg: Jenny Wiener Director: John Steber

Serafin ..... Lenore Pemberton  
Cashier/Christopher ..... Chris Welch  
Bellhop ..... Osage Ashley-Lewis

### The Stolen Purse

By Britney Castro, age 9. Dramaturg/Director: Jessica Bauman

Jackie ..... Abigail Lopez  
Agent 1-2-3 ..... Vanessa Aspillaga  
The Robber ..... Johnathan Roldan

### Sister and Brother

By Jeremy Butler, age 9. Dramaturg/Director: Joe White

Natasha ..... Grace Eboigbe  
Wilup ..... John Conlee  
Sneaker store customer ..... George Babiak  
Boss ..... Gus Rogerson  
Mom ..... Heidi Hunter Batz

### The Booger Boy and Janie

By Samantha Padilla, age 9. Dramaturg/Director: Linda White

Booger Boy ..... Carlo Alban  
Janie ..... Lisa Benavides  
Friends ..... The Crew

### The Truth About Friendship

By Kimani Ashley-Lewis, age 10. Dramaturg/Director: Darrell Larson

Tena, an opera-singing clown ..... Sharon Washington  
Sam, a lotto-playing clown ..... Ted Neustadt  
Lotto number announcer ..... George Babiak

*"I Am The Best"* and *"I'm All Alone"* lyrics by Kimani Ashley-Lewis

☞ I N T E R M I S S I O N ☜

## Follow Your Nose: Plays of Instinct - ACT II

### Can You Feel The Crossover?

By Akeem Frazier, age 9. Dramaturg/Director: Peter Herdrich

Ill Crossover ..... Michael Dolan  
Papa Tulle ..... Joe Quintero  
Announcer ..... Peter Herdrich  
The Team ..... Osage Ashley-Lewis, Johnathan Roldan  
Liz Lord, John Sheehy

*"We Won"* lyrics by Akeem Frazier

### The Mystery of the Petersins

By Lizette Natera, age 10. Dramaturg/Director: Keira Naughton

Lisa ..... Kaitlyn Kenney  
Landlord ..... Mary Vamvoukakis  
Michelle ..... Deirdre O'Connell  
Mr. and Mrs. Green ..... John Sheehy, Caroline Sharman  
Mr. and Mrs. Petersin ..... John Sheehy, Caroline Sharman

*"A Change of Weather"* lyrics by Lizette Natera

### Friends or Not

By Ariel Duran, age 9. Dramaturg/Director: Karen Trott

Michele ..... Kathy Hiler  
Jose ..... Arthur French  
Kenny ..... Gus Rogerson

*"Becoming Best of Friends"* lyrics by Ariel Duran

### The Brothers That Didn't Get Along

By David "Cito" Wagner, age 9. Dramaturg/Director: Lizzie Gottlieb

Tom, a dog ..... Malcolm Gets  
Trouble, his brother ..... Reg Flowers  
Jack the Bum ..... George Babiak  
Bob, a policeman ..... Mary Vamvoukakis

*"The Brother Song"* lyrics by David "Cito" Wagner





Jenny Wiener and the Board of Directors present



The 52nd Street Project's  
Piratical Benefit  
Monday, May 8th, 2000  
The Puck Building

Board Chair

Frances McDormand

Artistic Director

Gus Rogerson

Executive Director

Carol Ochs

Honorary Chairs

Edie Falco and Kevin Kline

Co-Chairs

Lisa Benavides  
Becky Browder  
Louis P. Friedman  
Patrice Friedman

Karin Schall  
Laura Valeroso  
Mary Pat Walsh  
Jenny Wiener

The Board of Directors

Ben Barenholtz  
Lisa Benavides  
Rachel Chanoff  
Ruth Cohen  
Heidi Ettinger  
Wendy Ettinger,  
*chair emeritus*  
Louis P. Friedman  
Stephen Graham  
Larry Jones  
James McDaniel

Frances McDormand,  
*chair*  
Patricia M. Murphy, Esq.  
Carol Ochs  
Willie Reale, *founder*  
Gus Rogerson  
Jose Soto, Jr.,  
*alumni boardmember*  
Pamala Tyson  
Laura Valeroso  
Wendy vanden Heuvel  
Jenny Wiener

The 52nd Street Project  
gratefully acknowledges...

Big Apple Lights  
Iris Brown  
Capital Printing/Ron Kastner  
The Children's Television Workshop  
The Coleman Company,  
*a subsidiary of the Sunbeam corporation*  
Entertainment Weekly  
Gap, Inc.  
The Jim Henson Company Shadow Projects  
Hudson Scenic Studios  
Kiehl's Since 1851  
Noggin  
Paris Chocolates, Inc.  
The Printing Store  
Promix  
Robert's American Gourmet  
Joseph E. Seagram & Sons, Inc.  
Seagram Chateau & Estate Wines Co.  
Wendy Stulberg  
John A. Vassilaros & Sons, Inc.  
Watkins Incorporated  
*Healthier Living Since 1868*



The Cast of Aargh! □

The Merry Minnows

Adults: Billy Crudup, Mary Louise Parker  
Kids: Anju Andre-Bergmann,  
Johnathan Roldan, Robert Tomas,  
Frankie Ventura

The Pirates

Adults: Roma Maffia, Jesse L. Martin,  
Martha Plimpton, Michael Potts  
Kids: Zaida Natera, Yazzy Troche

Special Guest Star

Lee Wilkof

The Songs

"Merry Minnows," "There Must Be Something  
More," "Yo Ho Ho," and "Sail Around the World"



Directed by

Jonathan Bernstein

With special thanks to Becky Browder

Original music composed by

Henry Krieger

Lyrics by

Willie Reale

Book by

Willie Reale, John Sheehy  
Michael Bernard, and Lewis Black

Music Directors

Virginia Pike and Kim Sherman

Set Design

Kevin Joseph Roach

Lighting Design

Greg MacPherson

Costume Design

Crystal Thompson

Sound Design

Scott Lehrer

Stage Manager

Hank Meiman

Foamcore Design Team

George Roman Babiak, Heather Carnduff,  
Amy Johnston, Liz Lord



## Cap'n Blackbeards

Arthur Dantchik  
Heidi Ettinger  
Wendy Ettinger & Derek McLane  
Cathy & Stephen Graham  
Jenny Wiener  
Jeffrey Yass

## Jolly Rogers

Comedy Central  
Entertainment Weekly  
Gap Inc.  
The Dawkins Family Foundation  
Angelina Fiordellisi & Matt Williams  
Frances & Colin Greer

## Salty Dogs

Blaise R. Box, Staging & Design, Inc.  
Kathleen Clark & Richard Frankel  
Karen & Christopher Eddowes  
Patrice & Louis Friedman  
Alexandra Gersten-Vassilaros &  
Johnny Coffeeshopolis  
Byron Lewis, Uniworld Group Inc.  
Betsy MacIsaac & Robert Goldberg,  
Yorke Construction Corp.  
Brian Mertes  
Jane Perlmutter & Greg MacPherson  
Laura Valeroso & David Seidman  
John Vassallo  
Joanne Woodward & Paul Newman



## Cutthroats

Elizabeth & Alexander Bernstein	Catherine Mueller & John Kirtley
Kate Burton & Michael Ritchie	Margot & Steve Peter
Tricia Cooke & Ethan Coen	Donna Plummer & Todd Richter
Thomas Cott	Jeremy M. Posner
Lisa Finstrom & Tim Sanford	Theresa Rebeck & Jess Lynn
Michael Greif & Jonathan Fried	Linda & Herald Ritch
Julia A. Johns	Steve Sabba
Mary & Larry Jones	Maury Schott
Liz LeCompte & Willem Dafoe	Elaine & Aaron Shapiro,
Mary Kong	Shapiro & Lobel LLP
John S. Lyons	Jean Stein
Dana & Paul McCrane	Katrina vanden Heuvel
Fran McDormand & Joel Coen	Melinda &
Bette Midler	William vanden Heuvel
Janet Momjian & Steve Olsen	Dr. Mildred Walton

## Swashbucklers

Peter Askin  
Myrna & Barry Bernard  
Vicky Bijur & Ed Levine  
Tessa Blake & Neal Lerner  
Jane Bodle & Mitchell Lemsky  
Colleen Carroll &  
Mitchell Semel  
Linda & Arthur Carter  
Ruth Cohen  
Ned Eisenberg  
Victor Garber  
M. Rose Gasner & Larry Chertoff  
Rebecca & Peter Grunwald  
Heights Partners, Inc.  
Dana Ivey  
Traci Paige Johnson & Bob Mowen  
Maurice Kanbar  
Beth S. & Seth A. Klarman  
Belle & Roger Kuhn  
Michael Lane  
Kay Matschullat & Allan Arffa

## Swabbies

Alexis Alexanian  
May Ameen  
Alice & Oswald Arana  
Cecilia Arana-Grant & Kevin Grant  
Debbon Ayer & Rob Morrow  
June Ballinger & Michael Goldstein  
Talia Balsam & John Slattery  
Audrey Bartner  
Lisa Benavides & Tim Nelson  
Stephanie Berger & Paul King  
Pamela Berlin & William Carden  
Sondra & Arthur Bernard  
Stephen Bernstein  
Audrey Bloch & Joe Wiesenthal  
Susan Bolotin & John Rothman  
Jane Bolster & Steve Wertimer  
Kathy Borowitz & John Turturro  
Buzz Bovshow  
Allan Braverman  
Adele & Edward Brody  
Becky Browder & Ted Neustadt  
Deborah Brown  
Michael Buchanan  
Denise Burse &  
Peter Jay Fernandez  
John Burt  
Lea Carpenter  
Carol Cate & Darran Foster  
Diana Cate  
Chris Ceraso  
Lia Chang  
Rachel Chanoff  
Glenda Chesshir  
William Christian  
Penny Collins  
David Copeland  
Maddie Corman & Jace Alexander  
Margaret Crimmins  
Colleen Croft & Louis Balducci  
Saula Cutter & Jan Wilson  
Dramatists Play Service

Anne Meara & Jerry Stiller  
Jane Musky & Tony Goldwyn  
Rona & Randolph Nelson  
Mark Nesselson M.D. &  
Elliott Rosenblum  
Elizabeth Peters  
Shevi & Tom Peters  
Ethan Phillips  
Sue Ochs Phillips  
Christopher Randolph  
Anita & David Rogerson  
Daryl Roth  
Karin & Tom Schall  
Leslie Schine & Nils Nilsen  
Jeff Stafford  
Helen Stenborg Hughes &  
Barnard Hughes  
Meg Simon  
Anne Twomey &  
John Bedford Lloyd  
Mary Pat Walsh



Eric Karpeles & Mike Sell  
Mark Keoppen  
Woodie King  
Judy Kuhn & David Schwab  
Deborah Landesman  
Jill Larson  
Kate Lear & Jonathan LaPook  
Dana & Jesse Lehman  
Mickey Lemle  
Liza Lerner  
Michael Lerner  
Reva Levin  
Joshua Lewis  
Anna Li  
Joseph A. Maffia  
Sarah Malin  
Jeanne & Dave Marks  
Ali Marsh  
Tory & Howie Masters  
George Mayer  
Brigid McCarthy  
Colleen McCourtney  
Dean Michaels  
Pam Miller  
Isaac Mizrahi  
Laura, Rob, Eibet, Kat &  
Grace Moore  
Robert Morse  
Walter Mosley  
Suzen Murakoshi  
Michaela Murphy &  
Lawrence Nathanson  
Patricia Murphy & Adam Spilka  
Ricarda O'Conner  
Steven O'Neill  
Jacki Ochs & Jan Kroeze  
Janet Perles & Stephen Jablonsky  
Susan Perrin  
Leslie & Dean Potashner  
Robert Reale  
Jackie Reingold  
Maggie Renzi & John Sayles  
Stuart Rosenstein

Gaylen Ross  
Mary Anne Rubacky  
Madeline & Richard Salzman  
Laura Sametz  
Stacey Schaffer & Eric Schwartz  
Beth Schneider &  
Steve McFarland  
Whitney Scott & Peter Jacobson  
Dana Segal  
Robert Shaffron & John Steber  
Barry Shapiro  
Helen & Andrew Sheinman  
Sylvia Shepard & Willy Holtzman  
Jan Sidebotham & Tim Emerson  
Jeanne Simpson & Adam Felber  
Slane & Slane  
Lois Smith  
Abigail Rose Solomon  
Ivy & David Solowiejczyk  
Don Spalding  
Dorothy Spears & Vance Brown  
James Stovall  
Lynn Street & Donald Margulies  
Susanna Styron & Darrell Larson  
Daniel Swee  
Martin Tandler  
The Tardis Group, Inc.  
Andy Taylor  
Mary Lou Teel & Peter Freundlich  
Joan Vail Thorne &  
John W. Thorne, III  
Tracy Thorne & Edmund Lewis  
Edith Thurber & Kevin O'Rourke  
Lorraine Tobias & Alex Draper  
Patricia Triana  
Karen Trott & Peter Herdrich  
Liz Tuccillo  
Cynthia Vance & Robert Abrams  
Elizabeth Van Dyke  
Carol J. Whitesides  
Donna & Walter Wick  
Susan Willerman  
Yildiz Yuksek & Richard Blackstone

List current as of May 2, 2000



## Volunteers

Heather Carnduff, Jilly Crook, Liz Flahive,  
Dale Ho, Eris Migliorini, Jenny Peek, Kim Sherman

## The 52nd Street Project Staff

Gus Rogerson, Artistic Director  
Carol Ochs, Executive Director  
Michael Bernard, Associate Artistic Director  
John Sheehy, Director of Development and Marketing  
George Babiak, Production Manager  
Julie Feldman, Director of Education  
Liz Lord, Amy Johnston, Caroline Sharman, Interns

## Special Thanks

Beth Emelson, Jenny Gersten, Jyllian Gunther, Josh Lewis,  
Robin Morse, Christopher Randolph, Maury Schott, Vanessa Valdes



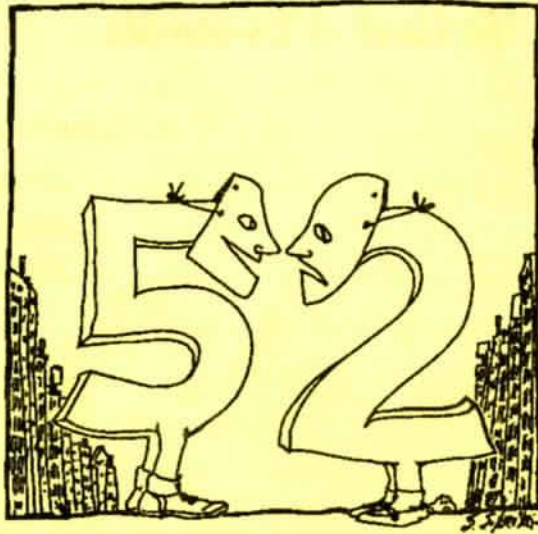

## The 52nd Street Project

The following foundations and government agencies  
have generously supported the Teen Program  
through their contributions:

City of New York Department of Cultural Affairs

Dammann Foundation

Department of Youth and Community Development

Florence Gould Foundation

National Endowment for the Arts

New York State Council on the Arts

The Surdna Foundation

Gus Rogerson, Artistic Director

Carol Ochs, Executive Director

The 52nd Street Project Presents

# Midsummer Night's Dream (Le Songe d'une Nuit d'Été)

By William Shakespeare

Directed by Michael Bernard

Adapted by Chris Ceraso and The 52nd Street Project Teen Ensemble



**New York City:** June 28 - Ensemble Studio Theatre  
**London, England:** July 4 - Scene and Heard/Theatro Technis  
**Lorgues, France:** July 9 - Chateau de Berne

### The 52nd Street Project

The 52nd Street Project (The Project) is dedicated to the creation and production of new plays for, and often by, kids between the ages of ten and eighteen who reside in the Hell's Kitchen neighborhood in New York City. The Project does this through a unique mentoring program that matches kids with professional (and volunteer!) theater artists.

The Project is about making children proud of themselves. The Project is not about teaching children to act, although they will learn to. It is not about teaching them to write plays, although they will learn that as well. What it is about is giving a kid an experience of success. It is about giving a kid an opportunity to prove that he or she has something of value to offer, something that comes from within that he or she alone possesses, something that cannot be taken away.

The Project's Teen Ensemble is the final step in the kids' training: a two-year acting class that culminates in the production of a full-length play by William Shakespeare, the very one you are seeing tonight. This year's show, the most ambitious one to date, takes us to three cities in three countries. We are very grateful to our gracious European hosts for enabling this tour.

### Le Projet de la 52ème Rue

Le Projet de la 52ème Rue est consacré à la création et production de nouvelles pièces de théâtre écrites pour, et souvent par, des jeunes de dix à dix-huit ans qui habitent le quartier de Hell's Kitchen (Cuisine de L'enfer) à New York. Le Projet apparie ces jeunes avec des artistes de théâtre professionnels qui leur servent de mentor.

Le Projet a pour but principal l'épanouissement de l'amour-propre des enfants. Ce n'est pas une école de théâtre, bien que les enfants deviennent souvent de très bons comédiens et auteurs dramatiques. Le Projet vise plutôt à créer une ambiance dans laquelle l'enfant peut ressentir ce que c'est de réussir. En donnant aux enfants l'occasion de s'exprimer, le Projet les encourage à reconnaître qu'ils ont une voix unique, qu'elle a de la valeur, et qu'elle mérite d'être entendue.

L'Ensemble Adolescent du Projet représente la dernière étape dans la formation des jeunes: un cours de théâtre de deux ans sur l'art de jouer la comédie, menant à la production de la pièce de William Shakespeare à laquelle vous allez assister ce soir. C'est de loin la production la plus ambitieuse que nous avons montée. Elle sera jouée dans trois villes, et trois pays, différents. Nous remercions nos hôtes Européens pour leur générosité, sans laquelle cette tournée n'aurait pas été possible.

### The Cast - L'Ensemble

Theseus/Oberon	Ray Harold
Demetrius/Polita/Titania	Jennifer Socarras
Puck	Zsuzsa Mysak
Demetrius	Eddie Zambrano
Helena	Annette Myrie
Lysander	Ray Ocasio
Hermia	Cecilia Arana
Nick Bottom	Jed Clarke
Peter Quince	Chris Ceraso
Francis Flute	Michael Bernard
Egeus/Snug	George Babiak
Snout (N.Y., France)	Gus Rogerson
Snout (London)	Selina Boyack
Fairies (New York)	Michael Bernard
Fairies (London)	Louisa Lawrenson
Fairies (France)	Jane Muddyman Heine

Stage Manager: Noël Dawkins

Costume Design: Katherine Roth

Backdrops: Caroline Goldrich and John Sheehy

Puppet design: Perry McBain Daniel

The 52nd Street Project would also like to thank Ensemble Studio Theatre, Scene and Heard -- Kate Coleman and Sophie Boyack, Bill Muddyman, Jane Muddyman-Heine, the staff of the Chateau de Berne, J.P. Pedergrana, Perry McBain Daniel, and  
Natasha Soto

## A Midsummer Night's Dream by William Shakespeare

A Midsummer Night's Dream takes place in Athens. Theseus, the Duke of Athens, is planning his marriage with Hippolyta, and as a result he is planning a large festival. Egeus enters, followed by his daughter Hermia, her beloved Lysander, and her suitor Demetrius. Egeus tells Theseus that Hermia refuses to marry Demetrius, wanting instead to marry Lysander. He asks for the right to punish Hermia with death if she refuses to obey.

Theseus agrees that Hermia's duty is to obey her father, and threatens her with either entering a nunnery or marrying the man her father chooses. Lysander protests, but is overruled by the law. He and Hermia then decide to flee by night into the woods surrounding Athens, where they can escape the law and get married. They tell their plan to Helena, a girl who is madly in love with Demetrius. Hoping to gain favor with Demetrius, Helena decides to tell him about the plan.

Some local artisans and workmen have decided to perform a play for Theseus as a way to celebrate his wedding. They choose Pyramus and Thisbe for their play, and meet to assign the roles. Nick Bottom gets the role of Pyramus, and Flute takes the part of Thisbe. They agree to meet the next night in the woods to rehearse the play.

Robin Goodfellow, a puck, meets a fairy who serves Queen Titania. He tells the fairy that his King Oberon is in the woods, and that Titania should avoid Oberon because they will quarrel again. However, Titania and Oberon soon arrive and begin arguing about a young boy Titania has stolen and is caring for. Oberon demands that she give him the boy, but she refuses.

Oberon decides to play a trick on Titania and put some pansy juice on her eyes. The magical juice will make her fall in love with first person she sees upon waking up. Soon after Puck is sent away to fetch the juice, Oberon overhears Demetrius and Helena in the woods.

Demetrius deserts Helena in the forest, leaving her alone. Oberon decides that he will change this situation, and commands Robin to put the juice onto Demetrius's eyes when he is sleeping. He then finds Titania and drops the juice onto her eyelids. Robin goes to find Demetrius, but instead comes across Lysander and accidentally uses the juice on him.

By accident He comes across Lysander and wakes him. He immediately falls in love with her and sets out to chase her through the woods. Together they arrive where Oberon is watching, and he realizes the mistake. Oberon then puts the pansy juice onto Demetrius's eyelids, who upon waking up also falls in love with Helena. She thinks that the two men are trying to torment her for being in love with Demetrius, and becomes furious at their protestations of love.

The workmen are in the woods and start to practice their play. They constantly ruin the lines of the play and pronounce the words. Out of fear of censorship, they decide to make the play less realistic. Therefore the lion is supposed to announce that he is not a lion, but only a common man. Bottom also feels obliged to tell the audience that he is not really going to die, but will only pretend to do so. Puck, watching this silly scene, catches Bottom alone and puts an asses head on him. When Bottom returns to his troupe, they run away out of fear. Bottom then comes across Titania, and succeeds in waking her up. She falls in love with him due to the juice on her eyes, and takes him with her.

Lysander and Demetrius prepare to fight one another for Helena. Puck intervenes and leads them through the woods in circles until they collapse onto the ground in exhaustion. He then brings the two women to same area and puts them to sleep as well.

Oberon finds Titania and releases her from the spell. He then tells the audience that Bottom will think is all a dream when he wakes up. He further releases Lysander from the spell. Theseus arrives with a hunting party and finds the lovers stretched out on the ground. He orders the hunting horns blown in order to wake them up.

The lovers explain why they are in the woods, at which point Egeus demands that he be allowed to exercise the law on Hermia. However, Demetrius intervenes and tells them that he no longer loves Hermia, but rather only loves Helena. Theseus decides to overbear Egeus and let the lovers get married that day with him. Together they return to Athens.

Bottom wakes up and thinks that he has dreamed the entire episode. He swiftly returns to Athens where he meets his friends. Together they head over to Theseus's palace. Theseus looks over the list of possible entertainment for that evening and settles on the play of Pyramus and Thisbe. Bottom and the rest of his company perform the play, after which everyone retires to bed.

Oberon and Titania briefly bless the couples and their future children. After they leave Puck asks the audience to forgive the actors if they were offended. He then tells the audience that if anyone disliked the play, they should imagine that it was only a dream.

## Le Songe d'une Nuit d'Été par M. William Shakespeare

Songe d'une Nuit d'Été se déroule à Athènes, où Theseus, le Duc, organise un festival en célébration de son Mariage avec Hyppolite. Egeus arrive au palais avec sa fille Hermia, Lysander, l'homme que sa fille aime, et Demetrius, l'homme que Egeus veut que sa fille épouse. Egeus se plaint au Duc que sa fille refuse d'épouser Demetrius, et demande le droit de mettre sa fille à mort si elle refuse de lui obéir.

Le Duc proclame que la loi oblige Hermia à respecter les vœux de son Père, faute de quoi elle sera envoyée dans un couvent. Lysander proteste, mais doit se soumettre à la volonté du duc. Les amoureux décident de faire une fugue, et de se cacher dans le bois qui entoure Athènes. Là, ils seront hors de portée et des lois d'Athènes, et de la volonté d'Egeus. Ils font part de leur projet à Helena, une jeune fille follement amoureuse de Demetrius. Helena, espérant se rendre plus désirable aux yeux de celui qu'elle aime, divulge le plan à Demetrius.

Pour fêter le mariage du Duc, quelques artisans et ouvriers décident de monter une pièce. Ils choisissent "Pyramus et Thisbe", et se réunissent pour répartir les rôles. Nick Bottom jouera Pyramus, et Flute jouera Thisbe. Ils décident de répéter le lendemain soir dans le bois.

Robin Goodfellow, un lutin, (Puck) rencontre une fée au service de la reine Titania. Il la prévient que le roi Oberon est dans le bois, et qu'il serait souhaitable que la reine ne le rencontre pas de peur qu'ils se querellent de nouveau. Malheureusement c'est trop tard. Le Roi et la Reine arrivent et sont vite en pleine dispute, Oberon insistant que Titania lui rende un jeune garçon qu'elle lui a volé. Titania refuse.

Oberon décide de jouer un tour à Titania. Quand elle sera endormie, il lui mettra un élixir à base de jus de pensée sur les paupières. Cet élixir magique la rendra follement amoureuse de la première personne qu'elle verra en se réveillant. Oberon envoie Puck à la recherche de l'élixir, puis surprend Demetrius et Helena dans le bois.

Demetrius abandonne Helena. Oberon dit à Puck de mettre Demetrius sous le charme de l'élixir aussi. Puck retrouve Titania endormie, lui administre l'élixir, et part à la recherche de Demetrius. Il trouve Lysander endormie et, croyant qu'il est Demetrius, lui met quelques gouttes sur les paupières.

Helena trouve Lysander et le réveille. Le charme prend effet, il est complètement amoureux, et la poursuit à travers le bois. Oberon les voit et se rend compte de son erreur. Il administre quelques gouttes à Demetrius, qui lui aussi poursuit Helena. Helena est furieuse, croyant que les deux hommes se moquent d'elle et la tourmentent à cause de son amour pour Demetrius.

Les ouvriers arrivent dans le bois et commencent à répéter la pièce. Ayant peur d'être censuré, ils décident de rendre la pièce moins réaliste. Les spectateurs seront donc prévenus que le lion n'est pas un vrai lion, et que la mort de Pyramus à la fin de la pièce n'est qu'une illusion. Puck observe tout ceci, et, profitant d'un moment où Bottom se trouve seul, lui met une tête d'âne. Quand Bottom rejoint les autres, la troupe, effrayée, s'enfuit.

Bottom se promène dans le bois et trouve Titania endormie. Il la réveille, et elle tombe amoureuse de lui.

Lysander et Demetrius décident de se battre pour l'amour de Helena. Puck intervient et les fait tourner en ronds dans la forêt jusqu'à ce qu'ils s'endorment, épuisés. Puck trouve ensuite Helena et Hermia, qu'il endort près des deux hommes.

Oberon trouve Titania et la libère du charme. Il explique aux spectateurs que Bottom, en se réveillant, pensera que tout n'était qu'un rêve. Il libère ensuite Lysander du charme.

Le Duc arrive dans le bois pour chasser et trouve les quatre amoureux endormis. Il les réveille. Les amoureux expliquent la raison de leur fuite, et Egeus demande que la loi soit exercée. Demetrius intervient, expliquant qu'il n'est plus amoureux d'Helena, et préférerait épouser Hermia. Le Duc décide alors que les deux couples, Lysander et Helena, et Demetrius et Hermia, seront mariés en même temps que lui et Hyppolite. Ils rentrent tous à Athènes.

Bottom se réveille et pense que tout n'était qu'un rêve. Il rentre à Athènes et retrouve ses amis. Ils se rendent au palais et jouent la pièce qu'ils ont répétée pour le Duc. Après la pièce, tout le monde rentre se coucher.

Oberon et Titania bénissent les nouveaux mariés et leurs futures enfants. Puck demande aux spectateurs de pardonner les comédiens si ces derniers les ont offensés, et ajoute que si la pièce leur a déplu, ils n'ont qu'à s'imaginer que tout n'était qu'un rêve.

The 52nd Street Project gratefully acknowledges the support of the following foundations and corporations: ABNY Foundation, Blythmour Corporation, Broadway Play Publishing, Carnegie Corporation of New York, Chase Manhattan Foundation, Comedy Central, The Crosby Fund, The Dammann Fund, The Dramatists Guild Fund, Dramatists Play Service, The Educational Foundation Of America, Entertainment Weekly, The Fan Fox & Leslie R. Samuels Fdn., Gap Inc., GLADPZ Foundation, The Horace W. Goldsmith Foundation, The Florence Gould Foundation, The William and Mary Greve Foundation, Heights Partners, The Holland Lodge Foundation, Inc., Jeopardy!, Betty E. & George B. Kaiser Foundation, Rita J. & Stanley H. Kaplan Foundation, Lloyds Bank, Luca, Inc., James A. Macdonald Foundation, Ann M. Martin Foundation, The Morris and Helen Messing Foundation, J.P. Morgan Charitable Trust, The Morgan Stanley Dean Witter Foundation, Newman's Own, The New World Foundation, O'Grady Family Foundation, Laura Pels Foundation, The Harold & Mimi Steinberg Charitable Trust, Susquehanna, Staging and Design, Inc., The Surdna Foundation, Uniworld Group Inc., John A. Vassilaros & Sons, Inc., West Bank Cafe, The Wiener Family Foundation, Yorke Construction Corp. In addition the following individuals made gifts of over \$150 to The 52nd Street Project this year (list is current as of 6/30/00).

Anonymous  
 Jace Alexander & Maddie Corman  
 May Ameen  
 Peter Askin  
 June Ballinger & Michael Goldstein  
 Ben Barenholtz  
 Jessica Bauman  
 Laurie Becker & Rick Sweren  
 Meredith Beuwkes  
 Steve Belber  
 Lisa Benavides & Tim Nelson  
 Stephanie Berger  
 Scott Bergman  
 Brett Berk  
 Pamela Berlin & William Cardin  
 Arthur & Sandra Bernard  
 Barry & Myrna Bernard  
 Alexander & Elizabeth Bernstein  
 Vicky Bjur & Ed Levine  
 Lewis Black  
 Richard Blackstone & Yldeez Yuksek  
 Tessa Blake  
 Audrey Bloch & Joseph Weisenthal  
 Robi & Ruth Blumenstein  
 Sally Bock & Mark Wurfel  
 Buzz Bovshow  
 Becky Browder & Ted Neustadt  
 Deborah Brown  
 Susan Bruce & Peter Hedges  
 John Burt  
 Kate Burton & Michael Ritchie  
 Joseph & Hilary Califano  
 Linda & Arthur Carter  
 Rachel Chanoff  
 Glenda Chesshir  
 Ethan Coen & Trish Cooke  
 Lieta Hesen-Cohen & Richard Chorn  
 Ruth Cohen  
 Thomas Cott  
 Margaret Crimmins  
 Colleen Croft & Louis Balducci  
 Willem Dafeo & Liz Lecompte  
 Arthur Danlchik  
 Peter & Judith Dawkins  
 Edward & Joanne DiRugeri  
 Alex Draper & Lorraine Tobias  
 Stephen Dubner  
 Christopher & Karen Eddowes  
 Mario Egozi  
 David Eigenberg  
 Ned Eisenberg  
 Barbara Ettinger  
 Heidi Ettinger  
 Wendy Ettinger & Derek McLane  
 Adam Felber & Jeanne Simpson  
 Gerald Fernandez  
 Peter Jay Fernandez &  
 Denise Burse  
 Hannah Finn & John Wiltshire  
 Alexa Fogel  
 Tom Fontana & Sagan Lewis

Katherine Foster  
 David Frankel  
 Eric & Juli Frankel  
 Richard Frankel & Kathleen Clark  
 Naomi Freundlich & Charles Miles  
 Geraldine R. Frey  
 Lois Fricke & Todd Hollander  
 Louis & Patrice Friedman  
 Victor Garber  
 Rose Gasner & Larry Chertoff  
 Ileen Getz & Mark Grinnell  
 Lloyd & Killy Gilmour  
 Judy Goldman & Michael Pillinger  
 Tony Goldwyn & Jane Musky  
 Stephen & Cathy Graham  
 Myrna & Stephen Greenberg  
 Colin & Frances Greer  
 Michael Greif & Jonathan Fried  
 Emily Grishman & Susan Sampliner  
 Rebecca & Peter Grunwald  
 Lisa Gugenheim  
 Evan Handler &  
 Elizabeth Timperman  
 Stuart & Lorna Hayim  
 Salter Herdrich & Karen Trott  
 William Holtzman &  
 S. Sylvia Shepard  
 Barnard Hughes &  
 Helen Stenborg Hughes  
 Andrew Hurtwitz & Dana Segal  
 Dana Ivey  
 Sy Jacobs  
 Whitney Scott & Peter Jacobson  
 Macon R. & Michael B. Jessop  
 Amanda Johns  
 Julia A. Johns  
 Traci Paige Johnson &  
 Robert Mowen  
 Cherry Jones & Mary O'Connor  
 Larry & Mary Jones  
 Maurice Kanbar  
 Eric Karpeles & Mike Sell  
 Ronald Kastner  
 Susan Kaufman  
 Mark Keoppen & Wendy Townsend  
 John Kirtley  
 Seth & Beth Klarman  
 Joana & Jason Kliot  
 Mary Kong  
 Judy Kuhn & David Schwab  
 Roger & Belle Kuhn  
 Michael A. Lane  
 Jill Larson  
 Kate Lear & Jonathan LaPook  
 Mitchell Lemsky & Jane Bodle  
 Joshua Lewis  
 Mark & Adrienne Linn-Baker  
 John Bedford Lloyd & Anne Twomey  
 John Lyons  
 Greg MacPherson &  
 Jane Perlmutter

Joseph Maffia  
 Roma Maffia  
 Rusty Magee & Alison Fraser  
 Paul & Lauren Mandell  
 Peter Manning & Andre Bishop  
 Donald Margulies & Lynn  
 All Marsh  
 Tory & Howie Masters  
 Kay Matschullat & Allan Arffa  
 Max Mayer & Catherine Corpeny  
 Ileen Getz & Mark Grinnell  
 Paul McCrane & Dana Kellin  
 James & Hannelore McDaniel  
 Fran McDormand & Joel Coen  
 Caitlin McLaughlin  
 Brian Mertes  
 Audrey & Danny Meyer  
 Bette Midler  
 Patricia Miller & Chris McFarland  
 Judy Minor  
 Isaac Mizrahi  
 Ross & Beth Moore  
 Walter Mosley  
 Michaela Murphy &  
 Larry Nathanson  
 Patricia M. Murphy, Esq. &  
 Adam Spilka  
 Randy & Rona Nelson  
 Ruth Nelson  
 Mark Nesselson, M.D. &  
 Elliott Rosenblum  
 Steven O'Neill  
 Kevin O'Rourke & Edith Thurber  
 Carol Ochs & Bruce MacVittie  
 Jacki Ochs & Jan Kroeze  
 Paul & Maria Onderdonk  
 Steven & Margot Peter  
 Bat-Sheva & Thomas Peters  
 Elizabeth Peters  
 Ethan Phillips  
 Susan Ochs Phillips  
 Virginia Pike  
 Oliver Platt & Camilla Campbell Platt  
 Richard Polatchek  
 Jeremy Posner  
 Dean & Leslie Potashner  
 Michael Potts  
 Christopher Randolph  
 Peter & Helen Randolph  
 Anthony Ranieri  
 Paul Reale & Barbara McCrane  
 Willie Reale & Jenny Gersten  
 Theresa Rebeck & Jess Lynn  
 Jacquelyn Reingold  
 Todd Richter & Donna Plummer  
 Herald & Linda Ritsh  
 David & Anita Rogerson  
 Robin Morse & Gus Rogerson  
 Daryl Roth  
 Steve Sabba  
 Richard & Madeline Salzman

Laura Sametz  
 Tim & Lisa Sanford  
 Joshua Sapan  
 Stacey Schaffer & Eric Schwartz  
 Karin & Tom Schall  
 Leslie Schine & Nils Nilsen  
 Glyna & Neil Schlesinger  
 Beth Schneider  
 Maury Schott  
 Mitchell Semel & Colleen Carroll  
 Aaron & Elaine Shapiro  
 Bernice Baruch Shawl  
 Andrew & Helen Sheinman  
 Sloane Shelton & Jan Buckaloo  
 Jan Sidebotham & Tim Emerson  
 Meg Simon  
 Landon Slane  
 Ken Smith  
 Lois Smith  
 David Sneddon & Kristine Fleisher  
 Abigail Rose Solomon  
 Dr. David Solowiejczyk  
 Dorothy Spears & Vance Brown  
 Jeff Stafford  
 John Steber & Robert Shaffron  
 Jean Stein  
 Anne Meara & Jerry Stiller  
 Susanna Styron & Darrell Larson  
 Daniel Sweet  
 Matin Tandler  
 Mary Lou Teel & Peter Freundlich  
 Joan Vail & John Thorne  
 Tracy Thorne & Edmund Lewis  
 John Turturro & Katherine Borowitz  
 Sean & Pamala Tyson-Mudd  
 Laura Valeroso & David Seidman  
 Katrina vanden Heuvel  
 Wendy vanden Heuvel &  
 Brad Coley  
 William & Melinda vanden Heuvel  
 John A. Vassallo  
 John A. Vassilaros &  
 Alexandra Gersten  
 Mary Pat Walsh  
 Borah & Mildred Walton  
 Sally & Lenny Weiss  
 Gregory Welch  
 Jane Bolster & Steve Wertimer  
 Donna & Walter Wick  
 Jenny Wiener  
 Michael & Zena Wiener  
 Elizabeth Williams & Joseph Forte  
 Matt Williams & Angelina Fiordellisi  
 Jan Wilson & Saula Cutter  
 Donald Windham  
 Joanne Woodward & Paul Newman  
 Anne & Charles Wright  
 Bill Wrubel  
 Jeffrey & Janine Yass  
 James & Mary Lin Yoshimura  
 Aylin Yuksek

The 52nd Street Project Presents  
 The 2000 Harold and Mimi Steinberg Charitable Trust One-on-Ones

# PACKAGE DEAL

## The Block Island Bundle

## The Ensemble Studio Theatre New York City



Thursday, July 27  
 7:30 p.m.

Friday, July 28  
 7:30 p.m.

Saturday, July 29  
 7:30 p.m.

Sunday, July 30  
 3:00 p.m.

# PACKAGE DEAL

## The Block Island Bundle

July 27-30, The Ensemble Studio Theatre, N.Y.C.

### Project Staff

Gus Rogerson, Artistic Director  
Carol Ochs, Executive Director  
Michael Bernard, Associate Artistic Director  
John Sheehy, Director of Development and Marketing  
George Roman Babiak, Production Manager  
Julie Feldman, Director of Education  
Megan Sandberg-Zakian, Volunteer Coordinator  
Liz Bell, Nellie Moody - Interns

### Production Staff

Kim Sherman, Composer  
Kevin Joseph Roach, Set Designer  
Greg MacPherson, Lighting Designer  
Julie Fischhoff, Costume Designer  
Vanessa Valdes, Sound Designer  
Jenny Peek, Stage Manager  
Slide Design Team:  
George Babiak, Renato Castilho,  
Katherine Lumb, Kim Snow,  
John Steward, Monica Tórréjón.  
Prop Design Team:  
George Babiak, Liz Bell,  
Heather Carnduff, Martin Goobee,  
Janet Kenney, Megan Sandberg-  
Zakian, John Sheehy, Kathy Taveras  
Package Deal Illustration: Mike Sell  
Slide Operator:  
Maury Schott

Furniture Crew:  
Mary Grieco, Noel Polanco  
Prop Crew:  
Liz Bell, Peter Granados  
Wall Props:  
Megan Sandberg-Zakian  
Load-in and Light Hang Crew:  
Tom Schall, Josh Lewis, Liz Bell,  
Julie Feldman, Ray Harold,  
Janet Kenney, Nellie Moody,  
Jenny Peek, Megan Sandberg-  
Zakian, John Sheehy  
House Managers:  
Susan McGinnis, Mary Pat Walsh  
Block Island Chefs:  
Martha Velie-Gass  
Pat McQuade  
Program Layout: George Babiak



NATIONAL  
ENDOWMENT  
FOR THE ARTS

The One-on-One Program is made possible with public funds from the National Endowment for the Arts, the New York State Council on the Arts, a state agency, the Department of Youth and Community Development, and the New York City Department of Cultural Affairs.



## Cool Stuff ON SALE IN THE LOBBY

### The Fabulous Flyer Bar (in five flavors)

\$2.00 and \$1.50 (\$1.00 for kids)

And featuring Shel Silverstein's "Fivey and Twoey" logo:

**NEW! Project Tank Tops** — \$12.00

**Project T-Shirts (Short sleeve)** — \$12.00

**Project Caps** — \$15.00

**Project Mugs** — \$5.00

**Project Pencils** — 3 for \$1.00

Thank you for coming to **PACKAGE DEAL**. If you are not on our mailing list (or if your address has changed), please fill out this form and give it to us on your way out or mail it to the address below. We would also like to know if you are interested in becoming a volunteer. We need help in **all areas**, so please fill out your name and phone number, and we'll call you.

### PLEASE ADD ME TO YOUR MAILING LIST:

7/00

NAME \_\_\_\_\_

ADDRESS \_\_\_\_\_

ZIP \_\_\_\_\_

HOME PHONE \_\_\_\_\_

DAYTIME PHONE \_\_\_\_\_

### YES, I WOULD LIKE TO BE OF HELP. I CAN:

- |   |   |  |
|---|---|--|
| <input type="checkbox"/> Help load in and out for shows | <input type="checkbox"/> Draw and/or paint  | <input type="checkbox"/> Help kids with homework |
| <input type="checkbox"/> Hang lights                    | <input type="checkbox"/> Help with mailings | <input type="checkbox"/> Teach kids a skill      |
| <input type="checkbox"/> Work on a backstage crew       | <input type="checkbox"/> Do office work     | <input type="checkbox"/> Be a chef at an event   |
| <input type="checkbox"/> Other (please specify) _____   |   |  |

### MY SCHEDULE IS:

- Very flexible. I'm often available during weekdays.  
 Somewhat flexible. I can help on the occasional morning or afternoon during the week.  
 Not very flexible at all, but I've got some free time on evenings and weekends.

If you would like to mail this (and you're always welcome to enclose a tax-deductible contribution), you can send it to: The 52nd Street Project, 500 West 52nd St. New York, NY 10019. Or fax it to (212) 333-5598.



## PACKAGE DEAL: ACT I

All music composed by Kim D. Sherman except where noted(\*)  
“The Package Deal” theme song lyrics by John Sheehy

### Wendy and Beebo

written and directed by Alex Draper for Tiffany Butler, age 11

Wendy ..... Tiffany Butler  
Jim, Beebo ..... Alex Draper  
Muluk the High Priest ..... George Babiak  
“*The Big Song*” lyrics by Alex Draper

### Mickey and The Really Bad Magician

written and directed by Angel David for Oscar Padilla, age 12

Mickey ..... Oscar Padilla  
The Great Frenchie ..... Angel David  
The Great Whodidit ..... George Babiak  
“*Thank the Box*” lyrics by Angel David

### I-Shadow

written by Lisi Gottlieb and James Greenberg and directed by  
Catherine Mueller for Anju Andre-Bergmann, age 13

Viola ..... Anju Andre-Bergmann  
Announcer ..... George Babiak  
Sponsor, Delivery Guy, Shadow ..... Catherine Mueller  
Audience Members ..... John Sheehy, Gus Rogerson, Josh Lewis  
“*Ultimate Gas*” lyrics by Lisi Gottlieb and James Greenberg

### Don't Let Them Know

written by Oni Faida Lampley and directed by Roma Maffia for  
Samantha Padilla, age 10

Lillian ..... Roma Maffia  
Rosa ..... Samantha Padilla  
“*Rosa's Song*” lyrics by Oni Faida Lampley

### Doctor Ford McClain - Cowboy M.D.

written and directed by Josh Lewis for Akeem Frazier, age 9

Dr. Ford McClain ..... Akeem Frazier  
Stimey, Mitch Dakota ..... Josh Lewis  
Townsperson ..... Liz Bell  
Sniffly Jim Rivers ..... Evan Handler  
Cowboy Chorus ..... MENERGY

“*Dr. Ford McClain*” music and lyrics by Josh Lewis\*

## ACT 2

### Defining Moment

written by Michael Bernard and directed by Joe Quintero  
for Johnathan Ladines, age 10

Dictionary ..... Johnathan Ladines  
Umbrella ..... Joe Quintero  
Guard ..... John Sheehy  
“*Dictionary and Umbrella*” lyrics by Michael Bernard

### Someone Like You

written and directed by Jyllian Gunther for Kathy Taveras, age 11

Heather ..... Kathy Taveras  
Dydee ..... Jyllian Gunther  
Feather ..... Gus Rogerson  
Radio Announcer, Ricola ..... John Sheehy  
Crowd People ..... Liz Bell, Megan Sandberg-Zakian  
“*It's Great Having Someone Like You*” lyrics by Jyllian Gunther

### Percival Barrington-Smythe and the Petition of Zamoria

written and directed by George Babiak for Nadya Jabour, age 12

Miss Crone ..... Nadya Jabour  
Faldrick ..... Nadya Jabour  
Gronff ..... Nadya Jabour  
Princess Belinda ..... Nadya Jabour  
Percival Barrington-Smythe ..... George Babiak  
Villagers ..... Noel Polanco,  
Megan Sandberg-Zakian, John Sheehy

“*The Things You Make Yourself*” lyrics by George Babiak

### Sydney and The Nine-Toed Sultan of Sulimahoo

written by David Schwab and directed by Evan Handler for Robert Tomas, 11

Sydney ..... Robert Tomas  
Sultan ..... Evan Handler  
Pickers ..... Liz Bell, Megan Sandberg-Zakian  
Henchman ..... John Sheehy  
Mother ..... Jyllian Gunther  
“*The Pomegranate Pickers Plight,*” & “*Babaloo & Zippety Doo*” lyrics by John Sheehy

### Closure at the Meadow

written by Willie Reale and directed by Florencia Lozano for Lizette Naterra, 12

Felicia ..... Lizette Naterra  
Perdina ..... Florencia Lozano  
“*A Dawning at the Meadow*” lyrics by Willie Reale

Don't miss our upcoming shows!

# PACKAGE DEAL



The Tyler Hill,  
Pa. Bundle  
of the 2000  
One-On-Ones

August 24-27, right here at  
The Ensemble  
Studio Theatre.

Same great theme, but  
with new kids, new adults,  
and all new plays!

# Playback

November, 2000

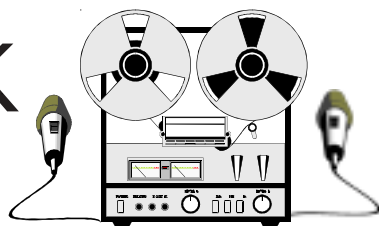

First, a kid writes a short play. Then, an adult writes an "answer" play. Then, the two of them perform both plays!

# Playmaking

December, 2000



In September, 10 kids brand-new to the Project will begin a Playmaking class with Michael Bernard. Come and see their final plays performed by adult professional actors.

The 52nd Street Project is a non-profit organization that brings inner-city children from the Hell's Kitchen neighborhood together with professional theater artists to create original theater. **PACKAGE DEAL** is a production of our One-on-One program, which is designed to give children the opportunity to go away for one-week stays in the country and enjoy the undivided attention of a professional theater artist who serves as friend, mentor, and collaborator.

The Project is delighted to return to the Ensemble Studio Theatre, where we have been performing since our inception in 1981. We gratefully acknowledge the fact that if E.S.T. wasn't here, we'd be nowhere.

## The 52nd Street Project Board of Directors

Ben Barenholtz	Patricia M. Murphy, Esq.
Lisa Benavides	Carol Ochs
Rachel Chanoff	Willie Reale
Ruth Cohen Heidi Ettinger	Gus Rogerson
Wendy Ettinger, <i>chair emeritus</i>	José Soto, Jr., <i>alumni boardmember</i>
Louis P. Friedman	Pamala Tyson
Stephen Graham	Laura Valeroso
Larry Jones	Wendy vanden Heuvel
James McDaniel	Jenny Wiener
Frances McDormand, <i>chairperson</i>	

## Special Thanks To:

Our Host Families – Sarah Barkley; Pat McQuade and Martha Velie-Gass; Josie Merck and Jim Stevenson; Jane Muskey and Tony, Tess and Anna Goldwyn; Jennifer and Elliot Taubman; Ron, Judy and Kevin Tierney; Joya Verde and Virginia Dare. Our chefs Pat McQuade and Martha Velie-Gass; our hosts Dr. Christina Biaggi and Pat Walsh; Lynn Reale, Kate, Ruth and Harold at Block Island Realty; Prudy and The Ice Cream Place; Glenn and Annie Hall; McQuade's Market; Interstate Navigation; Bill Bendokis and New England Air; Robin Morse and Lucia May Rogerson; Bruce MacVittie and Sophia Ochs MacVittie; Wendy vanden Heuvel, Brad Coley and Lila Blue Coley; Greg MacPherson and Jane Perlmutter.

## In-Kind Contributions:

Curt, Edgar, Jamie, Eliza, and all the staff at Ensemble Studio Theatre; Neil A. Mazzella & Hudson Scenic Studios, Inc.; Shays & Murphy; Iris A. Brown; Ron Kastner, Capital Printing; Masque Sound; New Dramatists; Steve Olsen & The West Bank Cafe; Mayor's Office of Film & Television; John A. Vassilaros & Son; Paris Chocolates; Scholastic Productions; Coleman, Inc.; Watkins Products; Noggin; The Gap; Kiehl's Since 1891; Eric Karpeles & Mike Sell; Bill Muddyman and the Chateau de Berne; Boylan's Bottling Company, BMG, David Sneddon and Fairway Market, and Andy Millon.

The 52nd Street Project gratefully acknowledges the support of the following foundations and corporations: ABNY Foundation, Blythmour Corporation, Broadway Play Publishing, Carnegie Corporation of New York, Chase Manhattan Foundation, Comedy Central, The Crosby Fund, The Dammann Fund, The Dramatists Guild Fund, Dramatists Play Service, The Educational Foundation Of America, Entertainment Weekly, The Fan Fox & Leslie R. Samuels Fdn., Gap Inc., GLADPZ Foundation, The Horace W. Goldsmith Foundation, The Florence Gould Foundation, The William and Mary Greve Foundation, Heights Partners, The Holland Lodge Foundation, Inc., Jeopardy!, Betty E. & George B. Kaiser Foundation, Rita J. & Stanley H. Kaplan Foundation, Lloyds Bank, Luca, Inc., James A. Macdonald Foundation, Ann M. Martin Foundation, The Morris and Helen Messing Foundation, J.P. Morgan Charitable Trust, The Morgan Stanley Dean Witter Foundation, Newman's Own, The New World Foundation, O'Grady Family Foundation, Laura Pels Foundation, The Harold & Mimi Steinberg Charitable Trust, Susquehanna, Staging and Design, Inc., The Surdna Foundation, Uniworld Group Inc., John A. Vassilaros & Sons, Inc., West Bank Cafe, The Wiener Family Foundation, Yorke Construction Corp. In addition the following individuals made gifts of over \$150 to The 52nd Street Project this year (list is current as of 6/30/00).

Anonymous  
 Jace Alexander & Maddie Corman  
 May Ameen  
 Peter Askin  
 June Ballinger & Michael Goldstein  
 Ben Barenholtz  
 Jessica Bauman  
 Laurie Becker & Rick Sweren  
 Meredith Beuwkes  
 Steve Belber  
 Lisa Benavides & Tim Nelson  
 Stephanie Berger  
 Scott Bergman  
 Brett Berkin  
 Pamela Berlin & William Cardin  
 Arthur & Sandra Bernard  
 Barry & Myrna Bernard  
 Alexander & Elizabeth Bernstein  
 Vicky Bjur & Ed Levine  
 Lewis Black  
 Richard Blackstone & Yldez Yuksek  
 Tessa Blake  
 Audrey Bloch & Joseph Weisenthal  
 Robi & Ruth Blumenstein  
 Sally Bock & Mark Wurfel  
 Buzz Bovshow  
 Becky Browder & Ted Neustadt  
 Deborah Brown  
 Susan Bruce & Peter Hedges  
 John Burt  
 Kate Burton & Michael Ritchie  
 Joseph & Hilary Califano  
 Linda & Arthur Carter  
 Rachel Chanoff  
 Glenda Chesshir  
 Ethan Coen & Trish Cooke  
 Lieta Hesen-Cohen & Richard Chohn  
 Ruth Cohen  
 Thomas Cott  
 Margaret Crimmins  
 Colleen Croft & Louis Balducci  
 Willem Dafeo & Liz Lecompte  
 Arthur Danchik  
 Peter & Judith Dawkins  
 Edward & Joanne DiRugeri  
 Alex Draper & Lorraine Tobias  
 Stephen Dubner  
 Christopher & Karen Eddowes  
 Mario Egozi  
 David Eigenberg  
 Ned Eisenberg  
 Barbara Ettinger  
 Heidi Ettinger  
 Wendy Ettinger & Derek McLane  
 Adam Felber & Jeanne Simpson  
 Gerald Fernandez  
 Peter Jay Fernandez &  
 Denise Burse  
 Hannah Finn & John Wiltshire  
 Alexa Fogel  
 Tom Fontana & Sagan Lewis

Katherine Foster  
 David Frankel  
 Eric & Juli Frankel  
 Richard Frankel & Kathleen Clark  
 Naomi Freundlich & Charles Miles  
 Geraldine R. Frey  
 Lois Fricke & Todd Hollander  
 Louis & Patrice Friedman  
 Victor Garber  
 Rose Gasner & Larry Chertoff  
 Ileen Getz & Mark Grinnell  
 Lloyd & Killy Gilmour  
 Judy Goldman & Michael Pillinger  
 Tony Goldwyn & Jane Musky  
 Stephen & Cathy Graham  
 Myrna & Stephen Greenberg  
 Colin & Frances Greer  
 Michael Greif & Jonathan Fried  
 Emily Grishman & Susan Sampliner  
 Rebecca & Peter Grunwald  
 Lisa Gugenheim  
 Evan Handler &  
 Elizabeth Timperman  
 Stuart & Lorna Hayim  
 Pater Herdrich & Karen Trott  
 William Holtzman &  
 S. Sylvia Shepard  
 Barnard Hughes &  
 Helen Stenborg Hughes  
 Andrew Hurtwitz & Dana Segal  
 Dana Ivey  
 Sy Jacobs  
 Whitney Scott & Peter Jacobson  
 Macon R. & Michael B. Jessop  
 Amanda Johns  
 Julia A. Johns  
 Traci Paige Johnson &  
 Robert Mowen  
 Cherry Jones & Mary O'Connor  
 Larry & Mary Jones  
 Maurice Kanbar  
 Eric Karpeles & Mike Sell  
 Ronald Kastner  
 Susan Kaufman  
 Mark Keoppen & Wendy Townsend  
 John Kirtley  
 Seth & Beth Klarman  
 Joana & Jason Kliot  
 Mary Kong  
 Judy Kuhn & David Schwab  
 Roger & Belle Kuhn  
 Michael A. Lane  
 Jill Larson  
 Kate Lear & Jonathan LaPook  
 Mitchell Lemsky & Jane Bodle  
 Joshua Lewis  
 Mark & Adrienne Linn-Baker  
 John Bedford Lloyd & Anne Twomey  
 John Lyons  
 Greg MacPherson &  
 Jane Perlmutter

Joseph Maffia  
 Roma Maffia  
 Rusty Magee & Alison Fraser  
 Paul & Lauren Mandell  
 Peter Manning & Andre Bishop  
 Donald Margulies & Lynn  
 All Marsh  
 Tory & Howie Masters  
 Kay Matschullat & Allan Arffa  
 Max Mayer & Catherine Corpeny  
 Ileen Getz & Mark Grinnell  
 Paul McCrane & Dana Kellin  
 James & Hannelore McDaniel  
 Fran McDormand & Joel Coen  
 Caitlin McLaughlin  
 Brian Mertes  
 Audrey & Danny Meyer  
 Bette Midler  
 Patricia Miller & Chris McFarland  
 Judy Minor  
 Isaac Mizrahi  
 Ross & Beth Moore  
 Walter Mosley  
 Michaela Murphy &  
 Larry Nathanson  
 Patricia M. Murphy, Esq. &  
 Adam Spilka  
 Randy & Rona Nelson  
 Ruth Nelson  
 Mark Nesselson, M.D. &  
 Elliott Rosenblum  
 Steven O'Neill  
 Kevin O'Rourke & Edith Thurber  
 Carol Ochs & Bruce MacVittie  
 Jacki Ochs & Jan Kroeze  
 Paul & Maria Onderdonk  
 Steven & Margot Peter  
 Bat-Sheva & Thomas Peters  
 Elizabeth Peters  
 Ethan Phillips  
 Susan Ochs Phillips  
 Virginia Pike  
 Oliver Platt & Camilla Campbell Platt  
 Richard Polatchek  
 Jeremy Posner  
 Dean & Leslie Potashner  
 Michael Potts  
 Christopher Randolph  
 Peter & Helen Randolph  
 Anthony Ranieri  
 Paul Reale & Barbara McCrane  
 Willie Reale & Jenny Gersten  
 Theresa Rebeck & Jess Lynn  
 Jacquelyn Reingold  
 Todd Richter & Donna Plummer  
 Herald & Linda Ritsh  
 David & Anita Rogerson  
 Robin Morse & Gus Rogerson  
 Daryl Roth  
 Steve Sabba  
 Richard & Madeline Salzman

Laura Sametz  
 Tim & Lisa Sanford  
 Joshua Sapan  
 Stacey Schaffer & Eric Schwartz  
 Karin & Tom Schall  
 Leslie Schine & Nils Nilsen  
 Glynna & Neil Schlesinger  
 Beth Schneider  
 Maury Schott  
 Mitchell Semel & Colleen Carroll  
 Aaron & Elaine Shapiro  
 Bernice Baruch Shawl  
 Andrew & Helen Sheinman  
 Sloane Shelton & Jan Buckaloo  
 Jan Sidebotham & Tim Emerson  
 Meg Simon  
 Landon Slane  
 Ken Smith  
 Lois Smith  
 David Sneddon & Kristine Fleisher  
 Abigail Rose Solomon  
 Dr. David Solowiejczyk  
 Dorothy Spears & Vance Brown  
 Jeff Stafford  
 John Steber & Robert Shaffron  
 Jean Stein  
 Anne Meara & Jerry Stiller  
 Susanna Styron & Darrell Larson  
 Daniel Swee  
 Matin Tandler  
 Mary Lou Teel & Peter Freundlich  
 Joan Vail & John Thorne  
 Tracy Thorne & Edmund Lewis  
 John Turturro & Katherine Borowitz  
 Sean & Pamala Tyson-Mudd  
 Laura Valeroso & David Seidman  
 Katrina vanden Heuvel  
 Wendy vanden Heuvel &  
 Brad Coley  
 William & Melinda vanden Heuvel  
 John A. Vassallo  
 John A. Vassilaros &  
 Alexandra Gersten  
 Mary Pat Walsh  
 Borah & Mildred Walton  
 Sally & Lenny Weiss  
 Gregory Welch  
 Jane Bolster & Steve Wertimer  
 Donna & Walter Wick  
 Jenny Wiener  
 Michael & Zena Wiener  
 Elizabeth Williams & Joseph Forte  
 Matt Williams & Angelina Fiordellisi  
 Jan Wilson & Saula Cutter  
 Donald Windham  
 Joanne Woodward & Paul Newman  
 Anne & Charles Wright  
 Bill Wrubel  
 Jeffrey & Janine Yass  
 James & Mary Lin Yoshimura  
 Aylin Yuksek

The 52nd Street Project Presents  
 The 2000 Wiener Family Foundation One-on-Ones



The  
 Tyler  
 Hill, Pa.  
 Bundle

The  
 Ensemble  
 Studio  
 Theatre  
 New York City



Thursday, Aug. 24  
 7:30 p.m.

Friday, Aug. 25  
 7:30 p.m.

Saturday, Aug. 26  
 7:30 p.m.

Sunday, Aug. 27  
 3:00 p.m.

# PACKAGE DEAL II

## The Tyler Hill, Pa. Bundle

August 24-27, The Ensemble Studio Theatre, N.Y.C.

### Project Staff

Gus Rogerson, Artistic Director  
Carol Ochs, Executive Director  
Michael Bernard, Associate Artistic Director  
John Sheehy, Director of Development and Marketing  
George Roman Babiak, Production Manager  
Julie Feldman, Director of Education  
Megan Sandberg-Zakian, Volunteer Coordinator  
Liz Bell, Nellie Moody, Caroline Sharman - Interns

### Production Staff

Patrick Barnes, Composer  
Kevin Joseph Roach, Set Designer  
Greg MacPherson, Lighting Designer  
Moe Schell, Costume Designer  
(with thanks to Crystal Thompson  
and Julie Fischhoff)

Maury Schott, Sound Designer  
Elissa Errick, Stage Manager  
Mike Sell, Slide Designer

#### Prop Design Team:

George Babiak, Liz Bell,  
Heather Carnduff, Elissa Errick,  
Nellie Moody, Sasha Paladino,  
Johnathan Roldan, Megan Sandberg-  
Zakian, John Sheehy, Melanie Smith,  
Andrea Wong

Package Deal Illustration: Mike Sell

Slide Operator:

Autumn Dornfeld

#### Furniture Crew:

Jaime Sandoz,  
Noel Polanco

#### Prop Crew:

Liz Bell, Andrea Wong,  
Zaida Natera

#### Wall Props:

Mayleen Cancél,  
Hakim Latimore

#### Load-in and Light Hang Crew:

Tom Schall, Ray Harold,  
Nellie Moody, Ray Ocasio,  
Megan Sandberg-Zakian,  
John Sheehy, Andrea Wong

#### House Manager:

Karin Schall

#### Tyler Hill Chef:

Eric Karpeles

Program Layout: George Babiak



NATIONAL  
ENDOWMENT  
FOR THE ARTS

The One-on-One Program is made possible with public funds from the National Endowment for the Arts, the New York State Council on the Arts, a state agency, the Department of Youth and Community Development, and the New York City Department of Cultural Affairs.



## Cool Stuff ON SALE IN THE LOBBY

### The Fabulous Flyer Bar (in five flavors)

\$2.00 and \$1.50 (\$1.00 for kids)

And featuring Shel Silverstein's "Fivey and Twoey" logo:

**NEW! Project Tank Tops** — \$12.00

**Project T-Shirts (Short sleeve)** — \$12.00

**Project Caps** — \$15.00

**Project Mugs** — \$5.00

**Project Pencils** — 3 for \$1.00

Thank you for coming to **PACKAGE DEAL II**. If you are not on our mailing list (or if your address has changed), please fill out this form and give it to us on your way out or mail it to the address below. We would also like to know if you are interested in becoming a volunteer. We need help in **all areas**, so please fill out your name and phone number, and we'll call you.

### PLEASE ADD ME TO YOUR MAILING LIST:

8/00

NAME \_\_\_\_\_

ADDRESS \_\_\_\_\_

ZIP \_\_\_\_\_

HOME PHONE \_\_\_\_\_

DAYTIME PHONE \_\_\_\_\_

### YES, I WOULD LIKE TO BE OF HELP. I CAN:

- |   |   |  |
|---|---|--|
| <input type="checkbox"/> Help load in and out for shows | <input type="checkbox"/> Draw and/or paint  | <input type="checkbox"/> Help kids with homework |
| <input type="checkbox"/> Hang lights                    | <input type="checkbox"/> Help with mailings | <input type="checkbox"/> Teach kids a skill      |
| <input type="checkbox"/> Work on a backstage crew       | <input type="checkbox"/> Do office work     | <input type="checkbox"/> Be a chef at an event   |
| <input type="checkbox"/> Other (please specify) _____   |   |  |

### MY SCHEDULE IS:

- Very flexible. I'm often available during weekdays.  
 Somewhat flexible. I can help on the occasional morning or afternoon during the week.  
 Not very flexible at all, but I've got some free time on evenings and weekends.

If you would like to mail this (and you're always welcome to enclose a tax-deductible contribution), you can send it to: The 52nd Street Project, 500 West 52nd St. New York, NY 10019. Or fax it to (212) 333-5598.

## PACKAGE DEAL: ACT 1

All music composed by Patrick Barnes except where noted(\*)  
“The Package Deal” theme song lyrics by John Sheehy

### SCIENCE FAIR

written by John Sheehy and directed by Susan McGinnis and John Sheehy for Jeremy Butler, age 10

Orlando ..... Jeremy Butler  
Piper ..... Susan McGinnis  
Mr. Karbingle ..... George Babiak

“A Box of Possibilities” lyrics by John Sheehy

### IT GETS COLD IN THE DESERT AT NIGHT

written and directed by Matt Saldivar for Johnathan Roldan, age 13

Nacho ..... Johnathan Roldan  
Flaco ..... Matt Saldivar

“Let The Bells Ding Dong,” \*music and lyrics by Matt Saldivar

### HELLO WORLD

written by Liz Tuccillo and directed by Zabryna Guevara for Allary Seda, age 12

Angela ..... Allary Seda  
Lola ..... Zabryna Guevara

“Hello World” lyrics by Liz Tuccillo and music based on a melody written by Allary Seda

### THE MYSTERIOUS GOLDEN CHEETAH

written and directed by Dan Berrett for Adrian Zambrano, age 11

Jack Danger ..... Adrian Zambrano  
Larry ..... Dan Berrett  
The Mysterious Golden Cheetah ..... George Babiak

“A Truly Great Adventurer” lyrics by Dan Berrett

### DOGS’ LIFE

written and directed by Michael Bernard for Adalberto Rodriguez, age 11

Pete ..... Michael Bernard  
Ted ..... Adalberto Rodriguez

“Open the Box” lyrics by Michael Bernard

## ACT 2

### QUEENS

written by Adam Felber and directed by Jeanne Simpson for Ariel Duran, age 9

Queen Myrna ..... Ariel Duran  
Queen Ida ..... Jeanne Simpson  
Prime Minister ..... Adam Felber  
Servants ..... Mayleen Cancél and Zaida Naterra

“Two Queens,” lyrics by Adam Felber

### SECRET POWER

written by Keli Garrett and directed by Keli Garrett and Caroline Sharman for Kimani Ashley-Lewis, age 10

Super Hero ..... Kimani Ashley-Lewis  
Damsel/Postal Teller ..... Caroline Sharman  
Villain/Customer ..... Hakim Latimore  
Off Stage Voice ..... John Sheehy

“I’ve Got Spunk” lyrics by Keli Garrett

### FIRE AND ICE

written and directed by Josh Lewis for Marilyn Sanchez, age 11

Hailey Winter ..... Marilyn Sanchez  
Drake Taylor ..... Josh Lewis  
Barry the Olympic Official ..... Noel Polanco

“Triple Lutz” \*music and lyrics by Josh Lewis

### THE GHOUL CAN’T HELP IT

written and directed by Anne Torsiglieri for Ivana Granados, age 10

Sally ..... Ivana Granados  
Cornelia ..... Anne Torsiglieri  
The Claw ..... Gus Rogerson

“On Our Honor” and “I Wanna Be Nice” lyrics by Anne Torsiglieri

### WOO WOO

written by Willie Reale and directed by José Soto for Frankie Ventura, 10

Don Pedro ..... José Soto  
Don Miguel ..... Frankie Ventura  
Contessa ..... Mayleen Cancél

“Heart Burn,” and “That’s The Deal” lyrics by Willie Reale

Don't miss our upcoming shows!

# Playback

November, 2000

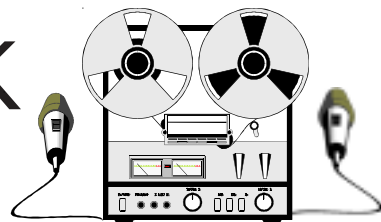

First, a kid writes a short play. Then, an adult writes an "answer" play. Then, the two of them perform both plays!



# Playmaking

December, 2000

In September, 10 kids brand-new to the Project will begin a Playmaking class with Michael Bernard. Come and see their final plays performed by adult professional actors.

# The Two-on-Two's

January, 2001



In the One-on-One's, a single kid is paired with a single adult. Now you can see *two* kids (grizzled Project vets, this time) perform a play written by an adult and directed by *another* adult.

The 52nd Street Project is a non-profit organization that brings inner-city children from the Hell's Kitchen neighborhood together with professional theater artists to create original theater. **PACKAGE DEAL II** is a production of our One-on-One program, which is designed to give children the opportunity to go away for one-week stays in the country and enjoy the undivided attention of a professional theater artist who serves as friend, mentor, and collaborator.

The Project is delighted to return to the Ensemble Studio Theatre, where we have been performing since our inception in 1981. We gratefully acknowledge the fact that if E.S.T. wasn't here, we'd be nowhere.

## The 52nd Street Project Board of Directors

Ben Barenholtz	Patricia M. Murphy, Esq.
Lisa Benavides	Carol Ochs
Rachel Chanoff	Willie Reale
Ruth Cohen Heidi Ettinger	Gus Rogerson
Wendy Ettinger, <i>chair emeritus</i>	José Soto, Jr., <i>alumni boardmember</i>
Louis P. Friedman	Pamala Tyson
Stephen Graham	Laura Valeroso
Larry Jones	Wendy vanden Heuvel
James McDaniel	Jenny Wiener
Frances McDormand, <i>chairperson</i>	

## Special Thanks To:

Our Host Families: Linda, Bill & Sean Cobb; Linda, Bill & Daniel Halvorsen; Andrea, Chuck, Melanie & Emma Heyn; Deborah, David, Imogen, Benita & Sam Pursch; Sarah, Bill & Sasha Spoerri, Frank & Pat Stoeckle; Sally & Lenny Weiss; Debbie, Frosty & Rio Myers; Sally & Joseph Russo; Richard Grunn & Tasha Williams; Jeanne & Corky & Susan Rutledge.

Sincere thanks to Wendy Townsend and Mark Keoppen, Martha Sader; David Sneddon & Steve Jenkins and The Fairway Market, & Marcia Dunsmore. Extra-special thanks to our amazing hosts/chefs Mike Sell & Eric Karpeles (and Walter too.)

## In-Kind Contributions:

Curt, Edgar, Jamie, Eliza, and all the staff at Ensemble Studio Theatre; Neil A. Mazzella & Hudson Scenic Studios, Inc.; Shays & Murphy; Iris A. Brown; Ron Kastner, Capital Printing; Masque Sound; New Dramatists; Steve Olsen & The West Bank Cafe; Mayor's Office of Film & Television; John A. Vassilaros & Son; Paris Chocolates; Scholastic Productions; Coleman, Inc.; Watkins Products; Noggin; The Gap; Kiehl's Since 1891; Eric Karpeles & Mike Sell; Bill Muddyman and the Chateau de Berne; Boylan's Bottling Company, BMG, David Sneddon and Fairway Market, and Andy Millon.

The 52nd Street Project gratefully acknowledges the support of the following foundations and corporations: ABNY Foundation, Barker Welfare Foundation, Broadway Play Publishing, Carnegie Corporation of New York, Comedy Central, Consolidated Edison, The Crosby Fund, The Dammann Fund, The Dramatists Guild Fund, Dramatists Play Service, The Educational Foundation of America, Entertainment Weekly, The Fan Fox & Leslie R. Samuels Foundation, Gap Inc., GLADPZ Foundation, The Horace W. Goldsmith Foundation, The Florence Gould Foundation, The William and Mary Greve Foundation, Heights Partners, The Holland Lodge Foundation, Inc., Jeopardy!, Betty E. and George B. Kaiser Foundation, Rita J. and Stanley H. Kaplan Foundation, Lloyds TSB Bank plc, James A. Macdonald Foundation, Ann M. Martin Foundation, The Morris and Helen Messing Foundation, J.P. Morgan Charitable Trust, The Morgan Stanley Dean Witter Foundation, Mosaic Entertainment, The New World Foundation, The New York Times Company Foundation, Newman's Own, Nickelodeon, O'Grady Family Foundation, Laura Pels Foundation, M.H. Segan & Company, Inc., The Surdna Foundation, Staging and Design, Inc., The Harold & Mimi Steinberg Charitable Trust, Susquehanna, The Tardis Group, Inc., Uniworld Group Inc., John A. Vassilaros & Sons, Inc., West bank Cafe, The Wiener Family Foundation, Yorke Construction Corporation. In addition the following individuals made gifts of over \$150 to The 52nd Street Project this year (list is current as of 10/31/00):

Anonymous	Katherine Foster	John Lyons	Kenneth Rothstein
May Ameen	David Frankel	Greg MacPherson & Jane Perlmutter	Steve Sabba
Peter Askin	Eric & Juli Frankel	Joseph Maffia	Richard & Madeline Salzman
June Ballinger & Michael Goldstein	Richard Frankel & Kathleen Clark	Roma Maffia	Laura Sametz
Ben Barenholtz	Naomi Freundlich & Charles Miles	Rusty Magee & Alison Fraser	Tim & Lisa Sanford
Jessica Bauman	Geraldine R. Frey	Paul & Lauren Mandell	Joshua Sapan
Laurie Becker & Rick Sweren	Lois Fricke & Todd Hollander	Brian & Marsha Mannain	Stacey Schaffer & Eric Schwartz
Meredith Beeuwkes	Louis & Patrice Friedman	Peter Manning & André Bishop	Karin & Tom Schall
Steve Belber	Hank Gallo	Donald Margulies & Lynn Street	Leslie Schine & Nils Nilsen
Lisa Benavides & Tim Nelson	Victor Garber	Ali Marsh	Glyna & Neil Schlesinger
Stephanie Berger	Rose Gasner & Larry Chertoff	Tory & Howie Masters	Beth Schneider
Scott Bergman	Joseph & Margaret Gazdak	Kay Matschullat & Allan Arffa	Maury Schott
Brett Berk	Ileen Getz & Mark Grinnell	Max Mayer & Catherine Corpeny	Mitchell Semel & Colleen Carroll
Pam Berlin & Billy Carden	Nancy Giles	Drew McCoy & Amy Aquino	Aaron & Elaine Shapiro
Arthur & Sandra Bernard	Lloyd & Kilty Gilmour	Paul McCrane & Dana Kellin	Bernice Baruch Shawl
Barry & Myrna Bernard	Judy Goldman & Michael Pillinger	James & Hanelore McDaniel	Andrew & Helen Sheiman
Alexander & Elizabeth Bernstein	Tony Goldwyn & Jane Musky	Fran McDormand & Joel Coen	Sloane Shelton & Jan Buckaloo
Vicky Bijur & Ed Levine	Stephen & Cathy Graham	Caitlin McLaughlin	Jan Sidebotham & Tim Emerson
Lewis Black	Myrna & Stephen Greenberg	Brian Mertes	Meg Simon
Jeanette & Samuel Black	Colin & Frances Greer	Bette Midler	Landon Slane
Richard Blackstone & Yldeez Yuksek	Michael Greif & Jonathan Fried	Patricia Miller & Chris McFarland	Tom Slaughter & Marthe Jocelyn
Tessa Blake	Emily Grishman & Susan Sampliner	Judy Minor	Abigail Rose Solomon
Audrey Bloch & Joseph Wiesenthal	Rebecca & Peter Grunwald	Isaac Mizrahi	Dr. David Solowiejczyk
Robi & Ruth Blumenstein	Lisa Gugenheim	Ross & Beth Moore	José & Michelle Soto
Sally Bock & Mark Wurfel	Evan Handler &	Walter Mosley	Dorothy Spears & Vance Brown
Buzz Bovshow	Elizabeth Timperman	Michaela Murphy & Larry Nathanson	Jeff Stafford
Becky Browder & Ted Neustadt	Stuart & Lorna Hayim	Patricia M. Murphy, Esq. &	John Steber & Robert Shaffron
Deborah Brown	Peter Herdrich & Karen Trott	Adam Spilka	Jean Stein
Susan Bruce & Peter Hedges	William Holtzman & S. Sylvia Shepard	Randy & Rona Nelson	Anne Meara & Jerry Stillier
John Burt	Barnard Hughes &	Ruth Nelson	Susanna Styron & Darrell Larson
Kate Burton & Michael Ritchie	Helen Stenborg Hughes	Mark Nesselson, M.D. & Elliott	Daniel Swee
Joseph & Hilary Califano	Andrew Hurtwiz & Dana Segal	Rosenblum	Mariko Tada
Linda & Arthur Carter	Dana Ivey	Cynthia Nixon	Mr. & Mrs. Martin Tandler
Rachel Chanoff	Sy Jacobs	Steven O'Neill	Jay & Rachel Tarses
Glenda Chesshir	Whitney Scott & Peter Jacobson	Kevin O'Rourke & Edith Thurber	Mary Lou Teel & Peter Freundlich
Ethan Coen & Trish Cooke	Macon R. & Michael B. Jessop	Paul & Maria Onderdonk	Carol Ochs & Bruce MacVittie
Ruth Cohen	Amanda Johns	Steven & Margot Peter	Joan Vail & John Thorne
Lieta Hesen-Cohen & Richard Cohn	Julia A. Johns	Elizabeth Peters	Tracy Thorne & Edmund Lewis
Thomas Cott	Traci Paige Johnson & Robert Mowen	Bat-Sheva & Thomas Peters	John & Katherine Turturo
Margaret Crimmins	Cherry Jones & Mary O'Connor	Ethan Phillips	Laura Valeroso & David Seidman
Colleen Croft & Louis Balducci	Larry & Mary Jones	Susan Ochs Phillips	Katrina vanden Heuvel
Stephen & Sandra Crudgington	Maurice Kanbar	Virginia Pike	Wendy vanden Heuvel & Brad Coley
Willem Dafoe & Liz Lecompte	Ronald Kastner	Oliver Platt & Camilla Campbell Platt	William & Melinda vanden Heuvel
Arthur Dantchik	Susan Kaufman	Richard Polatckeh	John A. Vassallo
Peter & Judith Dawkins	Mark Keoppen & Wendy Townsend	Jeremy Posner	Mary Pat Walsh
Edward & Joanne DiRugieris	John Kirtley	Dean & Leslie Potashner	Borah & Mildred Walton
Alex Draper & Lorraine Tobias	Seth & Beth Klarman	Gigi Pritzker Pucker & Michael Pucker	Sally & Lenny Weiss
Richard & Rebecca Dresser	Joana & Jason Kliot	Christopher Randolph	Gregory Welch
Christopher & Karen Eddowes	Mary Kong	Peter & Helen Randolph	Jane Bolster & Steve Wertimer
Mario Egozi	Judy Kuhn & David Schwab	Anthony Ranieri	Donna & Walter Wick
David Eigenberg	Roger & Belle Kuhn	Paul Reale & Barbara McCrane	Jenny Wiener
Ned Eisenberg	Michael A. Lane	Willie Reale & Jenny Gersten	Michael & Zena Wiener
Barbara Ettinger	Mark Lanow & Joanne Asrtow	Theresa Rebeck & Jess Lynn	Matt Williams & Angelina Fiordellisi
Heidi Ettinger	Jill Larson	Jacquelyn Reingold	Jan Wilson & Saula Cutter
Wendy Ettinger & Derek McLane	Kate Lear & Jonathan LaPook	Todd Richter & Donna Plummer	Donald Windham
Adam Felber & Jeannie Simpson	Mitchell Lemsky & Jane Bodle	Herald & Linda Ritch	Joanne Woodward & Paul Newman
Gerald Fernandez	Robert Leonard	David & Anita Rogerson	Anne & Charles Wright
Peter Jay Fernandez & Denise Busby	Joshua Lewis	Robin Morse & Gus Rogerson	Jeffrey & Janine Yass
Hannah Finn & John Wiltshire	Mark & Adrienne Linn-Baker	Daryl Roth	James & Mary Lin Yoshimura
Alexa Fogel	Jessica Lissy	Donald Rothschild & Lottchen Shivers	Aylin Yuksek
Tom Fontana & Sagan Lewis	John Bedford Lloyd & Anne Twomey		Yldeez Yuksek
			Virginia Zakian & Robert Sandberg

The 52nd Street Project Presents

# Two Heads

## The Better than One

### PLAYS

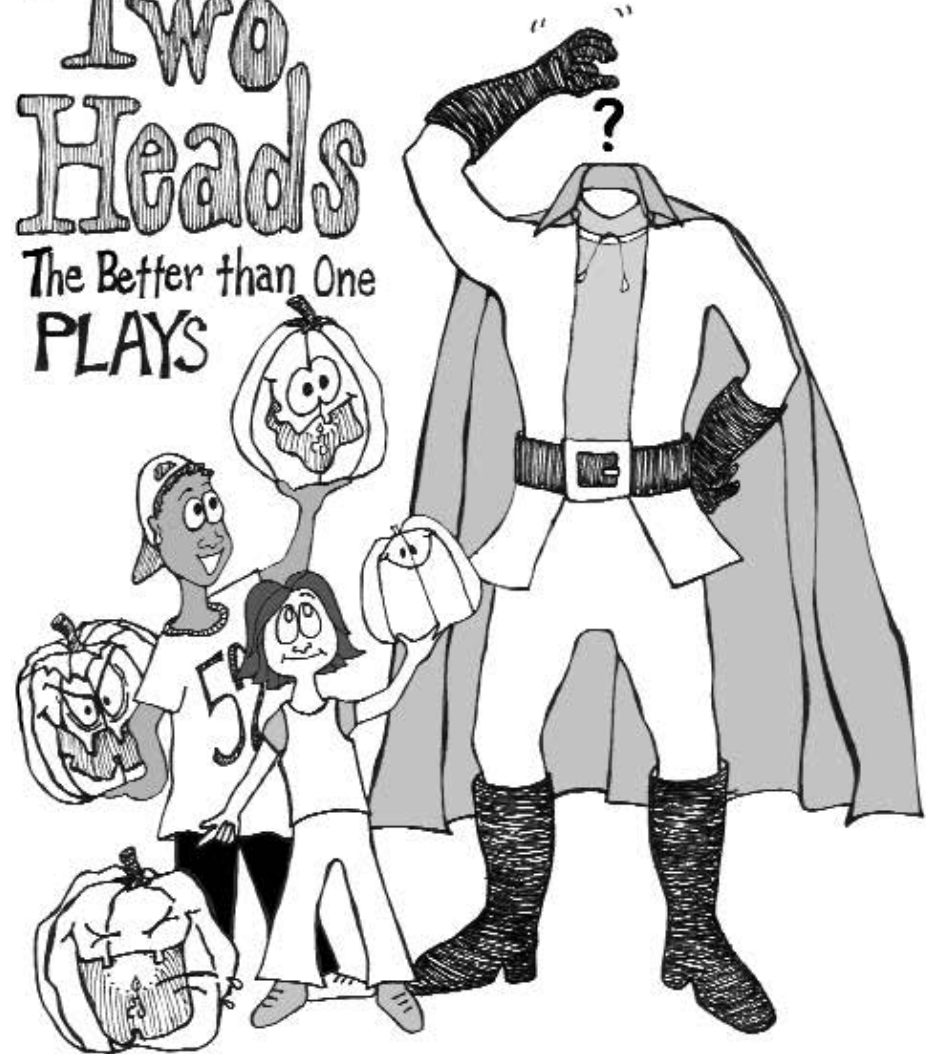

The 2000 Playback Program

New York Performance Works, 128 Chambers St.

Fri, Nov. 3 at 7:30 p.m.

Sat, Nov. 4 at 3:00 and 7:30 p.m.

Sun, Nov. 5 at 3:00 p.m.



The 2000 Playback Program

# Two Heads:

The Better-Than-One Plays

N.Y. Performance Works - Nov. 3-5, 2000



## The 52nd Street Project Staff

Gus Rogerson, Artistic Director  
 Carol Ochs, Executive Director  
 Michael Bernard, Associate Artistic Director  
 John Sheehy, Director of Development and Marketing  
 George Roman Babiak, Production Manager  
 Julie Feldman, Director of Education  
 Megan Sandberg-Zakian, Volunteer Coordinator  
 Chris Ceraso, Teen Dean  
 Iris A. Brown, Graphic Designer  
 Mayleen Cancel and Lorraine Zambrano, Receptionists  
 Interns: Liz Bell, Rocio Galarza, Jessica Greif, and Yufen Kung

## Production Staff

**Composer:** Virginia Pike  
**Set Designer:** Kevin Joseph Roach  
**Lighting Designers:**  
 Greg MacPherson and Matt Staniec  
**Costume Designer:** Erin Billings  
**Sound Designer:** Rebecca White,  
**Stage Manager:** Noël Dawkins  
**Prop Design Team:**

Justin Aponte, George Babiak, Kate Hancock, Miranda Hoffman, Heesoo Kim, Bob Leonard, Katherine Lumb, Robin and Mike Marshall, Monty Nicol, Johnathan Roldan, Jeremy Seymour, Kim Snow, Iwona Waluk, Jody Zoyes  
**"Two Heads" Illustrations:**  
 Heather Carnduff

**Furniture Crew:**  
 Maury Schott, Johnathan Roldan, Adrian Zambrano

**Prop Crew:**  
 Jessica Greif, Marcsi Mysak

**Wall Prop Crew:**  
 Rocio Galarza, Zsuzsa Mysak  
**Load-in and Light-hang Crew:**  
 Mona Arriola, Rocio Galarza, David Galido, Jessica Greif, Jack Gwaltney, Amy Johnston, Jaime Sandoz

**Weekend-Away Chef:**  
 Christopher Randolph

**House Managers:**  
 Mary Pat Walsh,  
 Susan McGinnis



The Playback Program is made possible with public funds from the National Endowment for the Arts; The New York State Council on the Arts, a state agency; the Department of Youth and Community Development; and the New York City Department of Cultural Affairs. The 52nd Street Project is a member of Art/NY.



## COOL STUFF ON SALE IN THE LOBBY!

The Fabulous Flyer Bar .....\$2.00 & \$1.50  
*and featuring Shel Silverstein's "Fivey and Twoey" logo:*  
 Project T-shirts (short sleeve) .....\$12.00  
 Project Tank Tops .....\$12.00  
 Project Caps .....\$15.00  
 Project Mugs .....\$5.00  
 Project Pencils (3-pack) .....\$1.00

Thank you for coming to **TWO HEADS**. If you are not on our mailing list (or if your address has changed), please fill out this form and give it to us on your way out or mail it to the address below. We would also like to know if you are interested in becoming a volunteer. We need help in **all areas**, so be sure to fill out the entire form.

### PLEASE ADD ME TO YOUR MAILING LIST:

10/00

NAME: \_\_\_\_\_

ADDRESS: \_\_\_\_\_  
 \_\_\_\_\_  
 \_\_\_\_\_ ZIP \_\_\_\_\_

HOME PHONE: \_\_\_\_\_

DAYTIME PHONE: \_\_\_\_\_

E-MAIL ADDRESS: \_\_\_\_\_

MY OCCUPATION: \_\_\_\_\_

MY HOBBIES: \_\_\_\_\_

### YES, I WOULD LIKE TO BE OF HELP. I CAN:

- |   |   |  |
|---|---|--|
| <input type="checkbox"/> Help load in and out for shows | <input type="checkbox"/> Draw and/or paint  | <input type="checkbox"/> Help kids with homework |
| <input type="checkbox"/> Hang lights                    | <input type="checkbox"/> Help with mailings | <input type="checkbox"/> Teach kids a skill      |
| <input type="checkbox"/> Work on a backstage crew       | <input type="checkbox"/> Do office work     | <input type="checkbox"/> Be a chef at an event   |
| <input type="checkbox"/> Do graphic design              | <input type="checkbox"/> Design sound       | <input type="checkbox"/> Design and sew costumes |
| <input type="checkbox"/> Other (please specify) _____   |   |  |

### MY SCHEDULE IS:

- Very flexible. I'm often available during weekdays.  
 Somewhat flexible. I can help on the occasional morning or afternoon during the week.  
 Not very flexible at all, but I've got some free time on evenings and weekends.

If you would like to mail this (and you're always welcome to enclose a tax-deductible contribution), you can send it to: **The 52nd Street Project**, 500 West 52nd St., New York, NY 10019. Or fax it to (212) 333-5598.



## Don't Miss Our Upcoming Shows!



### **LOOK MA: NO HANDS!**

The Wild Ride Plays

CAP21 Theater, 15 West 28th Street

Dec. 8-10, 2000

At this moment, 11 young Project rookies are taking a Playmaking class with **Michael Bernard**. When they are done, they will be hailed as masters of their craft and given their very own writer's retreat in Pennsylvania. Come see their final plays performed by professional adult actors! Call 642-5052 for reservations.

## Talking Shop

Plays That Work: The 2001 Two-on-Two's

January, 2001

Theater to be announced

In the summertime One-on-One's, a single kid is paired with a single adult. Now you can see *two* kids (grizzled Project vets, this time) perform a play written by an adult and directed by *another* adult.

The 52nd Street Project is a non-profit organization that brings inner-city children from the Hell's Kitchen neighborhood together with professional theater artists to create original theater. **TWO HEADS** is a production of our Playback program, in which kid actor/playwrights are taken away for a weekend in Wareham, Massachusetts (very close to Cape Cod) where they write a play. Their adult actor/playwright partners then write "answer plays" in response. For the final production, which you see here tonight, the partners perform both plays back-to-back. All of the kids involved are veterans of the Playmaking classes which were adapted for the Project by Daniel Judah Sklar from his book *Playmaking: Children Writing and Performing Their Own Plays*.

### The 52nd Street Project Board of Directors

Ben Barenholtz

Lisa Benavides

Rachel Chanoff

Ruth Cohen

Heidi Ettinger

Wendy Ettinger,

*chair emeritus*

Louis P. Friedman

Stephen Graham

Larry Jones

James McDaniel

Frances McDormand, *chair*

Patricia M. Murphy, Esq.

Carol Ochs

Willie Reale

Gus Rogerson

José Soto, Jr.,

*alumni boardmember*

Pamala Tyson

Laura Valeroso

Wendy vanden Heuvel

Jenny Wiener

### Special Thanks

We'd like to thank Christopher Randolph and his terrific parents Peter and Helen for putting us up in their beautiful home in Wareham, Mass. John McCormack, Andrew McTiernan, Pat Blake and Cold Productions and the rest of the staff of New York Performance Works have also earned our gratitude. Alicia Matthewson is a peach for recording Ginny Pike's original compositions. Theresa Bruck and Playwright's Horizons were kind enough to loan us a bunch of costumes. Vanessa Valdes contributed a number of tunes and sound effects. A sailor's thank-you goes to Donna and Dave aboard the good ship Persistence of Framingham, Ma. for their daring open-sea rescue of our young playwrights when the Randolph motorboat's engine failed.

## Two Heads: The Better Than One Plays - ACT I

### The Magic Genie

By Alex Cooper, age 14. Dramaturg/Director: Robert Jimenez

### A Genie's Undying Wish

By Jerome Hairston. Director: Robert Jimenez.

Dumbo .....Alex Cooper  
Bobo the Genie .....Robert Jimenez  
Mom .....Zsuzsa Mysak  
Potato Man/Dan .....John Sheehy

### Come Back With Me to My Galaxy

By Lorraine Zambrano, age 15

Dramaturg: Jackie Reingold. Director: Camilia Sanes.

### A Super Nova of a Wish

By Jackie Reingold - Directed by Camilia Sanes

Lipadolytistic .....Lorraine Zambrano  
Her Mom .....Rocio Galarza  
Da Fairest Of Them All .....Camilia Sanes  
Planets .....Megan Sandberg-Zakian, George Babiak,  
Jessica Greif, Johnathan Roldan

*Come Back With Me* lyrics by Lorraine Zambrano

### The Curious Coyote

By Joel Lind, age 14

Dramaturg: Megan Sandberg-Zakian. Directed by Megan and Michael Bernard.

### The Curious Coyote II

By Michael Bernard. Directed by Michael and Megan Sandberg-Zakian

Mighty .....Joel Lind  
Mom .....Lenore Pemberton  
Sheila .....Marcsi Mysak

### Trevor and His Mom

By Natalie Musteata, age 14

Dramaturg/Director: Gus Rogerson

### Trevor and Mary Lou

Written and directed by Gus Rogerson

Mom/Mary Lou .....Natalie Musteata  
Trevor .....Christopher Randolph

*All Alone In This World* lyrics by Natalie Musteata, *Better By Myself*,  
*Mary Lou's Dilemma*, and *Goodbye and Hello* lyrics by Gus Rogerson

## Two Heads: The Better Than One Plays - ACT II

### The Message

By Mayleen Cancel, age 15

Dramaturg/Director: Robert Sean Leonard

### Mount Olympus

Written and directed by Robert Sean Leonard.

Amanda .....Mayleen Cancel  
Mom .....Megan Sandberg-Zakian  
Dad/Zeus .....John Sheehy  
Sister .....Zsuzsa Mysak  
Friend .....Marcsi Mysak  
Greek Dude .....Robert Sean Leonard

### Doomsday

By Kevin Hartwick, age 14. Dramaturg: George Babiak. Director: Keith Reddin

### Doomsday II

Written and directed by Keith Reddin.

Evil Scientist Guy .....Kevin Hartwick  
Super Nerd .....Keith Reddin  
President Clinton/Dr. George .....George Babiak  
Woman .....Marcsi Mysak  
Guards .....Adrian Zambrano, Johnathan Roldan  
Voice of Angel .....Rocio Galarza  
Voice of Devil .....Maury Schott  
Cop .....Johnathan Roldan

### Cry, Baby, Cry

By Vionel Ortiz, age 15

Dramaturg/Director: Martha Plimpton

### Isn't She Lovely?

Written and directed by Martha Plimpton.

Illyana .....Vionel Ortiz  
Elizabeth/Abby .....Martha Plimpton



The 52nd Street Project gratefully acknowledges the support of the following foundations and corporations: ABNY Foundation, Barker Welfare Foundation, Broadway Play Publishing, Carnegie Corporation of New York, Comedy Central, Consolidated Edison, The Crosby Fund, The Dammann Fund, The Dramatists Guild Fund, Dramatists Play Service, The Educational Foundation of America, Entertainment Weekly, The Fan Fox & Leslie R. Samuels Foundation, Gap Inc., GLADPZ Foundation, The Horace W. Goldsmith Foundation, The Florence Gould Foundation, The William and Mary Greve Foundation, Heights Partners, The Holland Lodge Foundation, Inc., Jeopardy!, Betty E. and George B. Kaiser Foundation, Rita J. and Stanley H. Kaplan Foundation, Lloyds TSB Bank plc, James A. Macdonald Foundation, Ann M. Martin Foundation, The Morris and Helen Messing Foundation, J.P. Morgan Charitable Trust, The Morgan Stanley Dean Witter Foundation, Mosaic Entertainment, The New World Foundation, The New York Times Company Foundation, Newman's Own, Nickelodeon, O'Grady Family Foundation, Laura Pels Foundation, M.H. Segan & Company, Inc., The Surdna Foundation, Staging and Design, Inc., The Harold & Mimi Steinberg Charitable Trust, Susquehanna, The Tardis Group, Inc., Uniwold Group Inc., John A. Vassilaros & Sons, Inc., West bank Cafe, The Wiener Family Foundation, Yorke Construction Corporation. In addition the following individuals made gifts of over \$150 to The 52nd Street Project this year (list is current as of 10/31/00):

Anonymous	Eric & Juli Frankel	Greg MacPherson & Jane Perlmutter	Donald Rothschild & Lottchen Shivers
May Ameen	Richard Frankel & Kathleen Clark	Joseph Maffia	Kenneth Rothstein
Peter Askin	Naomi Freundlich & Charles Miles	Roma Maffia	Steve Sabba
June Ballinger & Michael Goldstein	Geraldine R. Frey	Rusty Magee & Alison Fraser	Richard & Madeline Salzman
Ben Barenholtz	Lois Fricke & Todd Hollander	Paul & Lauren Mandell	Laura Sametz
Jessica Bauman	Louis & Patrice Friedman	Brian & Marsha Mannain	Tim & Lisa Sanford
Laurie Becker & Rick Sweren	Hank Gallo	Peter Manning & André Bishop	Joshua Sapan
Meredith Beuwkes	Victor Garber	Donald Margulies & Lynn Street	Stacey Schaffer & Eric Schwartz
Steve Belber	Rose Gasner & Larry Chertoff	Ali Marsh	Karin & Tom Schall
Lisa Benavides & Tim Nelson	Joseph & Margaret Gazdak	Tory & Howie Masters	Leslie Schine & Nils Nilsen
Stephanie Berger	Ileen Getz & Mark Grinnell	Kay Matschullat & Allan Arffa	Glyna & Neil Schlesinger
Scott Bergman	Nancy Giles	Max Mayer & Catherine Corpeny	Beth Schneider
Brett Berk	Lloyd & Kilty Gilmour	Drew McCoy & Amy Aquino	Maury Schott
Pam Berlin & Billy Carden	Judy Goldman & Michael Pillinger	Paul McCrane & Dana Kellin	Mitchell Semel & Colleen Carroll
Arthur & Sandra Bernard	Tony Goldwyn & Jane Musky	James & Hanelore McDaniel	Aaron & Elaine Shapiro
Barry & Myrna Bernard	Stephen & Cathy Graham	Fran McDormand & Joel Coen	Bernice Baruch Shawl
Alexander & Elizabeth Bernstein	Myrna & Stephen Greenberg	Caitlin McLaughlin	Andrew & Helen Sheinman
Vicky Bijur & Ed Levine	Colin & Frances Greer	Brian Mertes	Sloane Shelton & Jan Buckaloo
Lewis Black	Michael Greif & Jonathan Fried	Bette Midler	Jan Sidebotham & Tim Emerson
Jeanette & Samuel Black	Emily Grishman & Susan Sampliner	Patricia Miller & Chris McFarland	Meg Simon
Richard Blackstone & Yldeez Yuksek	Tessa Blake	Judy Minor	Landon Slane
Audrey Bloch & Joseph Wiesenthal	Lisa Gugenheim	Isaac Mizrahi	Tom Slaughter & Marthe Jocelyn
Robi & Ruth Blumenstein	Evan Handler & Elizabeth Timperman	Ross & Beth Moore	Abigail Rose Solomon
Sally Bock & Mark Wurfel	Stuart & Lorna Hayim	Walter Mosley	Dr. David Solowiejczyk
Buzz Bovshow	Peter Herdrich & Karen Trott	Michaela Murphy & Larry Nathanson	José & Michelle Soto
Becky Browder & Ted Neustadt	William Holtzman & S. Sylvia Shepard	Patricia M. Murphy, Esq. & Adam Spilka	Dorothy Spears & Vance Brown
Deborah Brown	Barnard Hughes & Helen Stenborg Hughes	Randy & Rona Nelson	Jeff Stafford
Susan Bruce & Peter Hedges	Andrew Hurtwitz & Dana Segal	Ruth Nelson	John Steber & Robert Shaffron
John Burt	Dana Ivey	Mark Nesselson, M.D. & Elliott Rosenblum	Jean Stein
Kate Burton & Michael Ritchie	Sy Jacobs	Cynthia Nixon	Anne Meara & Jerry Stiller
Joseph & Hilary Califano	Whitney Scott & Peter Jacobson	Steven O'Neill	Susanna Styron & Darrell Larson
Linda & Arthur Carter	Macon R. & Michael B. Jessop	Kevin O'Rourke & Edith Thurber	Daniel Swee
Rachel Chanoff	Amanda Johns	Carol Ochs & Bruce MacVittie	Mariko Tada
Glenda Chesshir	Julia A. Johns	Paul & Maria Onderdonk	Mr. & Mrs. Martin Tandler
Ethan Coen & Trish Cooke	Traci Paige Johnson & Robert Mowen	Steven & Margot Peter	Jay & Rachel Tarses
Ruth Cohen	Cherry Jones & Mary O'Connor	Elizabeth Peters	Mary Lou Teel & Peter Freundlich
Lietla Hesen-Cohen & Richard Cohn	Larry & Mary Jones	Bat-Sheva & Thomas Peters	Joan Vail & John Thorne
Thomas Cott	Maurice Kanbar	Ethan Phillips	Tracy Thorne & Edmund Lewis
Margaret Crimmins	Ronald Kastner	Susan Ochs Phillips	John & Katherine Turturro
Colleen Croft & Louis Balducci	Susan Kaufman	Virginia Pike	Laura Valeroso & David Seidman
Stephen & Sandra Crudgington	Mark Keoppen & Wendy Townsend	Oliver Platt & Camilla Campbell Platt	Katrina vanden Heuvel
Willem Dafoe & Liz Lecompte	John Kirtley	Richard Polatchek	Wendy vanden Heuvel & Brad Coley
Arthur Dantchik	Seth & Beth Klarman	Jeremy Posner	William & Melinda vanden Heuvel
Peter & Judith Dawkins	Joana & Jason Kliot	Dean & Leslie Potashner	John A. Vassallo
Edward & Joanne DiRuggeris	Mary Kong	Gigi Pritzker Pucker & Michael Pucker	Mary Pat Walsh
Alex Draper & Lorraine Tobias	Judy Kuhn & David Schwab	Christopher Randolph	Borah & Mildred Walton
Richard & Rebecca Dresser	Roger & Belle Kuhn	Peter & Helen Randolph	Sally & Lenny Weiss
Christopher & Karen Eddowes	Michael A. Lane	Anthony Ranieri	Gregory Welch
Mario Egozi	Mark Lanow & Joanne Astrow	Paul Reale & Barbara McCrane	Jane Bolster & Steve Wertimer
David Eigenberg	Jill Larson	Willie Reale & Jenny Gersten	Donna & Walter Wick
Ned Eisenberg	Kate Lear & Jonathan LaPook	Theresa Rebeck & Jess Lynn	Jenny Wiener
Barbara Ettinger	Mitchell Lemsky & Jane Bodle	Jacquelyn Reingold	Michael & Zena Wiener
Heidi Ettinger	Robert Leonard	Todd Richter & Donna Plummer	Matt Williams & Angelina Fiordellisi
Wendy Ettinger & Derek McLane	Joshua Lewis	Herald & Linda Ritch	Jan Wilson & Saula Cutter
Adam Felber & Jeannie Simpson	Mark & Adrienne Linn-Baker	David & Anita Rogerson	Donald Windham
Gerald Fernandez	Jessica Lissy	Robin Morse & Gus Rogerson	Joanne Woodward & Paul Newman
Peter Jay Fernandez & Denise Burse	John Bedford Lloyd & Anne Twomey	Daryl Roth	Anne & Charles Wright
Hannah Finn & John Wiltshire	John Lyons		Jeffrey & Janine Yass
Alexa Fogel			James & Mary Lin Yoshimura
Tom Fontana & Sagan Lewis			Aylin Yuksek
Katherine Foster			Yldeez Yuksek
David Frankel			Virginia Zakian & Robert Sandberg

## The 52nd Street Project Presents



The  
Fall 2000  
Playmaking  
Plays

Cap 21 Theater, 15 West 28th St.

Friday, Dec. 8 at 7:30 p.m.

Saturday, Dec. 9 at 3:00 p.m. and 7:30 p.m.

Sunday, Dec. 10 at 3:00 p.m.



# The 2000 Playmaking Plays Look Ma, No Hands!

The Wild Ride Plays  
CAP 21 Theater - Dec. 8-10, 2000

### The 52nd Street Project Staff

Gus Rogerson, Artistic Director  
Carol Ochs, Executive Director  
Michael Bernard, Associate Artistic Director  
John Sheehy, Director of Development and Marketing  
George Roman Babiak, Production Manager  
Julie Feldman, Director of Education  
Megan Sandberg-Zakian, Volunteer Coordinator  
Chris Ceraso, Teen Dean  
Iris A. Brown, Graphic Designer  
Mayleen Cancel and Lorraine Zambrano, Receptionists  
Interns: Liz Bell, Rocio Galarza, Jessica Greif, and Yufen Kung

### Production Staff

**Composer:** Rusty Magee  
**Set Designer:** Kevin Joseph Roach  
**Lighting Designers:**  
Greg MacPherson and Matt Staniec  
**Costume Designer:**  
Crystal Thompson  
**Sound Designer:** Alicia Mathewson  
**Stage Manager:** Anne Lowrie  
**Slide Design Team:**  
Lee Kimble, Mike Marshall,  
John Steward, Kim Snow,  
Monty Nicol, Iwona Waluk

**Prop Design Team:**  
George Babiak, Anna Belknap,  
Colleen Berry, Kristen Buchanan,  
Heather Carnduff, Kate Hancock,  
Yufen Kung, Matt Maher, Rick Meese,  
Jo-an Peralto, Eric Siegel, Daniel  
Stern, Susan Vitucci

**"Look Ma" Illustration:**  
Chesley MacLaren

**Furniture Crew:**  
Barclay Stiff, Matthew Jellison,  
Alex Cooper  
**Prop Crew:**  
Rocio Galarza,  
Candy Godoy  
**Wall Props:**  
Jessica Greif  
**Slide Projector Apparatus  
Manager (SPAM):**  
Yufen Kung  
**Load-in and Light-hang Crew:**  
Angel David, Bill Charlton, Jenny  
Saunders, David Eigenberg, Anne  
Lowrie, Matt Maher, Betsy Rhodes,  
Tom Schall, Maury Schott  
**Weekend-Away Hosts:**  
Eric Karpeles and Mike Sell  
**House Managers:**  
Karin Schall,  
Mary Pat Walsh



The Playmaking Program is made possible with public funds from the National Endowment for the Arts; The New York State Council on the Arts, a state agency; the Department of Youth and Community Development; and the New York City Department of Cultural Affairs. The 52nd Street Project is a member of Art/NY.



## COOL STUFF ON SALE IN THE LOBBY!

The Fabulous Flyer Bar .....\$2.00 & \$1.50  
and featuring Shel Silverstein's "Fivey and Twoey" logo:  
Project T-shirts (short sleeve) .....\$12.00  
Project T-shirts (long sleeve) .....\$15.00  
Project Caps .....\$15.00  
Project Mugs .....\$5.00

Thank you for coming to **LOOK MA, NO HANDS!** If you are not on our mailing list (or if your address has changed), please fill out this form and give it to us on your way out or mail it to the address below. We would also like to know if you are interested in becoming a volunteer. We need help in **all areas**, so be sure to fill out the entire form.

### PLEASE ADD ME TO YOUR MAILING LIST:

12/00

NAME: \_\_\_\_\_

ADDRESS: \_\_\_\_\_

ZIP \_\_\_\_\_

HOME PHONE: \_\_\_\_\_

DAYTIME PHONE: \_\_\_\_\_

E-MAIL ADDRESS: \_\_\_\_\_

MY OCCUPATION: \_\_\_\_\_

MY HOBBIES: \_\_\_\_\_

### YES, I WOULD LIKE TO BE OF HELP. I CAN:

- |   |   |  |
|---|---|--|
| <input type="checkbox"/> Help load in and out for shows | <input type="checkbox"/> Draw and/or paint  | <input type="checkbox"/> Help kids with homework |
| <input type="checkbox"/> Hang lights                    | <input type="checkbox"/> Help with mailings | <input type="checkbox"/> Teach kids a skill      |
| <input type="checkbox"/> Work on a backstage crew       | <input type="checkbox"/> Do office work     | <input type="checkbox"/> Be a chef at an event   |
| <input type="checkbox"/> Do graphic design              | <input type="checkbox"/> Design sound       | <input type="checkbox"/> Design and sew costumes |
| <input type="checkbox"/> Other (please specify) _____   |   |  |

### MY SCHEDULE IS:

- Very flexible. I'm often available during weekdays.  
 Somewhat flexible. I can help on the occasional morning or afternoon during the week.  
 Not very flexible at all, but I've got some free time on evenings and weekends.

If you would like to mail this (and you're always welcome to enclose a tax-deductible contribution), you can send it to: **The 52nd Street Project**, 500 West 52nd St., New York, NY 10019. Or fax it to (212) 333-5598.

## Don't Miss Our Upcoming Shows!

# TALKING SHOP:

# PLAYS THAT WORK



ILLUSTRATION BY JAMES STEVENSON

### THE 2001 TWO-ON TWOS

January 26-28 at

The Ensemble Studio Theater, 549 W. 52nd St.

In the summertime One-on-One's, a single kid is paired with a single adult. Now you can see *two* kids (grizzled Project vets, this time) perform a play written by an adult and directed by *another* adult. Root beer floats at intermission!



The Winter Edition: March, 2001 at  
a theater to be announced.

If you're enjoying the show tonight, you'll want to come see the work of our next batch of Project newcomers! Call 642-5052 for reservations.

The 52nd Street Project is a non-profit organization that brings inner-city children from the Hell's Kitchen neighborhood together with professional theater artists to create original theater. **Look Ma, No Hands!** is a production of our Playmaking program. Young people participate in an eight-week playwriting course taught by Michael Bernard and adapted for the Project by Daniel Judah Sklar from his book *Playmaking: Children Writing and Performing Their Own Plays*. At the end of the course, each child is given two actors, a theme, and a dramaturg/director who guides him or her through the writing of a play during a weekend retreat in the country. Tonight's performance is the end result.

### The 52nd Street Project Board of Directors

Ben Barenholtz

Lisa Benavides

Rachel Chanoff

Ruth Cohen

Heidi Ettinger

Wendy Ettinger,

*chair emeritus*

Louis P. Friedman

Stephen Graham

Larry Jones

James McDaniel

Frances McDormand, *chair*

Patricia M. Murphy, Esq.

Carol Ochs

Willie Reale

Gus Rogerson

José Soto, Jr.,

*alumni boardmember*

Pamala Tyson

Laura Valeroso

Wendy vanden Heuvel

Jenny Wiener

### Special Thanks

Mike Sell and Eric Karpeles allowed us to use their beautiful home in Tyler Hill, Pennsylvania as our headquarters. Eric also contributed his considerable talents as a chef during our weekend away. Meanwhile, the Cobb, Grunn, and Russo families provided adult housing while the Halvorsens, the Stoeckles, the Lindgrens, the Rutledges, and Sohail Raikhy put up our kids. Also deserving of thanks are Sharon, Bradford, and all the other folks at CAP21. Rescue Diver Vanessa Valdes contributed a number of tunes and sound effects.



Help build the Clubhouse Library! Buy us a book or two from **Amazon.com** by logging on to our on-line "wish list." Scroll down the right side of their home page and click on WISHLIST, then type "project52@aol.com" into the email search field. Then just click away to stack our shelves!

**Bad Boy**

By Mike Grullon, age 11. Dramaturg/Director: Joel de la Fuente

Dan .....Jonathan Goldblatt  
 Brian/Cashier/Cop .....Lee Wilkof  
 Dan’s Mom .....Denise Burse  
 Friends .....Gus Rogerson, George Babiak, John Sheehy

**The Lonely Hearts**

By Sacha Centeno, age 13. Dramaturg/Director: Liz Flahive

Danny .....Phillip Christian  
 Cindy .....Gwendolyn Mulamba  
 Mrs. Cruz .....Candy Godoy  
 Other kids .....The crew

**The Day the Boy Answered His Mom Back**

By Stephen Galimidi, age 10. Dramaturg/Director: Michael Young

Brittney .....Caroline Hall  
 Jason .....Robert Montano  
 Jaime .....Angel David  
 Jaime’s girlfriend .....Rocio Galarza

**Good Friends, Best Friends, and True Friends**

By Kamila Jacob, age 11. Dramaturg/Director: Susan Vitucci

Beccy .....Emily Wachtel  
 Charlette .....Nancy Giles  
 Holly the Helper .....Emily Wachtel  
*What Should I Do?* lyrics by Kamila Jacob, music by Rusty Magee

**The Daring Cut**

By Mark Gamero, age 10. Dramaturg/Director: Larry Nathanson

Amy .....Natasha Lyonne  
 Joey .....Reg Flowers  
 Max .....John Sheehy  
 Rachel .....Rocio Galarza

**Always and Forever**

By Wendy Rivera, age 12. Dramaturg/Director: Greg Allen

Ace Duffy .....Angel David  
 Julieana Peterson .....Phyllis Somerville  
 Trevor/Information Lady .....Greg Allen  
 Casey/Bus Driver/Father Frank .....John Sheehy

☞ **Intermission!** ☞

**Bandits**

By Angel Matta, age 12. Dramaturg/Director: Sascha Paladino

Jim .....Sam Wright  
 Bolo .....Tom Carrozza  
 Other players .....The crew  
 Cheerleaders .....Rocio Galarza and Jessica Greif

**Gabby and the Puppy David**

By Octavia Rodriguez, age 9. Dramaturg/Director: Lizzie Gottlieb

Gabby .....Stephen De Rosa  
 David .....David Grillo  
 The Cat .....Rocio Galarza  
*There’s A Cat* lyrics by Octavia Rodriguez, music by Rusty Magee

**Give Me My Baby, Give Me My Bike**

By Leah Galimidi, age 12. Dramaturg/Director: Kate Ryan

Antonio/Bam .....Kim Sykes  
 Berthame/Randy .....Denise Burse  
 Antonio’s Mom .....Gwendolyn Mulamba

**The Blind Man That Was Teased**

By Anthony Mejia, age 10. Dramaturg/Director: Megan Sandberg-Zakian

Blind Man .....Reg E. Cathey  
 Pickimz .....Priya Ayyar  
 Blind people .....The crew

**The Biggest Lie**

By Shakeema Green, age 11. Dramaturg/Director: George Babiak

Diamond .....Adina Porter  
 Krystal .....Heather Carnduff  
 Man .....Gus Rogerson  
 Customers .....John Sheehy, Jessica Greif,  
 Matthew Jellison, Alex Cooper, Candy Godoy





# SHOW PROGRAMS 2001-2005

The 52nd Street Project gratefully acknowledges the support of the following foundations and corporations: ABNY Foundation, Barker Welfare Foundation, The Bamsley Foundation, Broadway Play Publishing, Carnegie Corporation of New York, Comedy Central, Consolidated Edison, The Dammann Fund, The Dramatists Guild Fund, Dramatists Play Service, Eleanor, Adam & Mel Dubin Foundation, The Educational Foundation Of America, Entertainment Weekly, Ford Foundation, The Fan Fox & Leslie R. Samuels Fdn., Gap Inc., GLADPZ Foundation, The Horace W. Goldsmith Foundation, The Florence Gould Foundation, The William & Mary Greve Foundation, Heights Partners, The Holland Lodge Foundation, Inc., Hudson Scenic Studio, Betty E. & George B. Kaiser Foundation, Rita J. and Stanley H. Kaplan Foundation, Lloyds TSB Bank plc, Luca, Inc., James A. Macdonald Foundation, Ann M. Martin Foundation, J.P. Morgan Charitable Trust, Mosaic Entertainment, The New World Foundation, The New York Times Co. Fdn., Newman's Own, O'Grady Family Foundation, Laura Pels Foundation, Staging and Design, Inc., Harold & Mimi Steinberg Charitable Trust, The Surdna Foundation, Susquehanna, Tandler Textile Inc., Uniwold Group Inc., John A. Vassilaros & Sons, Inc, The Vervane Foundation, West Bank Cafe, The Wiener Family Foundation, Yorke Construction Corporation. In addition the following individuals made gifts of over \$150 this year (list is current as of 1/24/01)

Anonymous	Eric & Juli Frankel	Chris & Sally Lutz	Daryl Roth
Liliana Amador-Martí	Richard Frankel & Kathleen Clark	John Lyons	Donald Rothschild
& Frank Marty	Naomi Freundlich & Charles Miles	Marsue & Peter MacNicol	& Lottchen Shivers
May Ameen	Geraldine R. Frey	Greg MacPherson	Kenneth Rothstein
Peter Askin	Louis & Patrice Friedman	& Jane Perlmutter	Steve Sabba
June Ballinger & Michael Goldstein	Hank Gallo	Joseph Maffia	Richard & Madeline Salzmann
Ben Barenholtz	Victor Garber	Roma Maffia	Laura Sametz
Jessica Bauman	Beth Gardiner	Rusty Magee & Alison Fraser	Tim & Lisa Sanford
Laurie Becker & Rick Sweren	Rose Gasner & Larry Chertoff	Paul & Lauren Mandell	Joshua Sapan
Meredith Beeuwkes	Joseph & Margaret Gazzdak	Brian & Marsha Mannain	Stacey Schaffer & Eric Schwartz
Lisa Benavides & Tim Nelson	John A. Vassilaros	Elizabeth Manne	Karin & Tom Schall
Stephanie Berger & Paul King	& Alexandra Gersten	Peter Manning & André Bishop	Leslie Schine & Nils Nilsen
Scott Bergman	Ileen Getz & Mark Grinnell	Donald Margulies & Lynn Street	Glyna & Neil Schlesinger
Brett Berk	Nancy Giles	Ali Marsh	Beth Schneider
Pam Berlin & Billy Carden	Lloyd & Kilty Gilmour	Tory & Howie Masters	Maury Schott
Arthur & Sandra Bernard	Judy Goldman & Michael Pillingier	Kay Matschullat & Allan Arffa	Marc Segan
Barry & Myrna Bernard	Tony Goldwyn & Jane Musky	Max Mayer & Catherine Corpeny	Mitchell Semel & Colleen Carroll
Alexander & Elizabeth Bernstein	Stephen & Cathy Graham	Drew McCoy & Amy Aquino	Aaron & Elaine Shapiro
Vicky Bijur & Ed Levine	Connie Grappo & Lee Wilkof	Paul McCrane & Dana Kellin	Bernice Baruch Shawl
Lewis Black	Michael Greif & Jonathan Fried	James & Hannelore McDaniel	Andrew & Helen Sheinman
Jeanette & Samuel Black	Emily Grishman	Fran McDormand & Joel Coen	Jan Sidebotham & Tim Emerson
Richard Blackstone	& Susan Sampliner	Brian Mertes	Meg Simon
& Yldez Yuksek	Rebecca & Peter Grunwald	Bette Midler	Landon Slane
Tessa Blake	Lisa Gugenheim	Patricia Miller & Chris McFarland	Tom Slaughter & Marthe Jocelyn
Audrey Bloch & Joseph Wiesenthal	Evan Handler	Isaac Mizrahi	Ken Smith
Robi & Ruth Blumenstein	Stuart & Lorna Hayim	Ross & Beth Moore	Phillip K. & Gloria W. Smith
Buzz Bovshow	Peter Herdrich & Karen Trott	Walter Mosley	Abigail Rose Solomon
Becky Browder & Ted Neustadt	William Holtzman	Michaela Murphy	Dr. David Solowiejczyk
Deborah Brown	& S. Sylvia Shepard	& Larry Nathanson	José & Michelle Soto
Susan Bruce & Peter Hedges	Barnard Hughes	Patricia M. Murphy, Esq.	Dorothy Spears & Vance Brown
John Burt	& Helen Stenborg Hughes	& Adam Spilka	Jeff Stafford
Kate Burton & Michael Ritchie	Andrew Hurwitz & Dana Segal	Randy & Rona Nelson	John Steber & Robert Shaffron
Joseph & Hilary Califano	Dana Ivey	Ruth Nelson	Jean Stein
Linda & Arthur Carter	Sy Jacobs	Mark Nesselson, M.D.	Anne Meara & Jerry Stiller
Rachel Chanoff	Whitney Scott & Peter Jacobson	& Elliott Rosenblum	Susanna Styron & Darrell Larson
Glenda Chesshir	Macon R. & Michael B. Jessop	Cynthia Nixon	Daniel Sweet
Ethan Coen & Trish Cooke	Amanda Johns	Steven O'Neill	Mariko Tada
Lietla Hesen-Cohen & Richard Cohn	Julia A. Johns	Kevin O'Rourke & Edith Thurber	Jay & Rachel Tarses
Thomas Cott	Andrea Johnson	Carol Ochs & Bruce MacVittie	Mary Lou Teel & Peter Freundlich
Margaret Crimmins	Traci Paige Johnson	Paul & Maria Onderdonk	Joan Vail & John Thorne
Colleen Croft & Louis Balducci	& Robert Mowen	Steven & Margot Peter	Tracy Thorne & Edmund Lewis
Stephen & Sandra Crudgington	Cherry Jones & Mary O'Connor	Elizabeth Peters	Jan & Katherine Turturro
Willem Dafeo & Liz Lecompte	Larry & Mary Jones	Bat-Sheva & Thomas Peters	Laura Valeroso & David Seidman
Arthur Dantchik	Maurice Kanbar	Ethan Phillips	Katrina vanden Heuvel
Peter & Judith Dawkins	Ronald Kastner	Susan Ochs Phillips	Wendy vanden Heuvel
Edward & Joanne DiRugieris	Susan Kaufman	Virginia Pike	& Brad Coley
Alex Draper & Lorraine Tobias	Mark Keoppen & Wendy Townsend	Oliver Platt	William & Melinda vanden Heuvel
Richard & Rebecca Dresser	John Kirtley	& Camilla Campbell Platt	John A. Vassallo
Christopher & Karen Eddowes	Seth & Beth Klarman	Richard Polatchek	Mary Pat Walsh
Mario Egozi	Joana & Jason Klot	Jeremy Posner	Borah & Mildred Walton
David Eigenberg	Mary Kong	Dean & Leslie Potashner	Sally & Lenny Weiss
Ned Eisenberg	Judy Kuhn & David Schwab	Gigi Pritzker Pucker	Gregory Welch
Barbara Ettinger	Roger & Belle Kuhn	& Michael Pucker	Jane Bolster & Steve Wertimer
Barbara Ettinger & Sven Huseby	Michael A. Lane	Christopher Randolph	Donna & Walter Wick
Heidi Ettinger	Mark Lanow & Joanne Astrow	Peter & Helen Randolph	Jenny Wiener
Wendy Ettinger & Derek McLane	Allan & Nanette Larson	Anthony Ranieri	Michael & Zena Wiener
Adam Felber & Jeanne Simpson	Jill Larson	Paul Reale & Barbara McCrane	Matt Williams & Angelina Fiordellisi
Gerald Fernandez	Kate Lear & Jonathan LaPook	Willie Reale & Jenny Gersten	Jan Wilson & Saula Cutter
Peter Jay Fernandez	Mitchell Lemsky & Jane Bodle	Theresa Rebeck & Jess Lynn	Donald Windham
& Denise Burse	Robert Sean Leonard	Alysia Reiner & David Basche	Joanne Woodward & Paul Newman
Hannah Finn & John Wiltshire	Joshua Lewis	Jacquelyn Reingold	Anne & Charles Wright
Alexa Fogel	Mark Linn-Baker & Adrienne Lobel	Todd Richter & Donna Plummer	Jeffrey & Janine Yass
Tom Fontana & Sagan Lewis	Jessica Lissy	Herald & Linda Ritch	James & Mary Lin Yoshimura
Katherine Foster	John Bedford Lloyd	David & Anita Rogerson	Ailyn Yuksek
David Frankel	& Anne Twomey	Robin Morse & Gus Rogerson	Virginia Zakian & Robert Sandberg

## The 52nd Street Project Presents

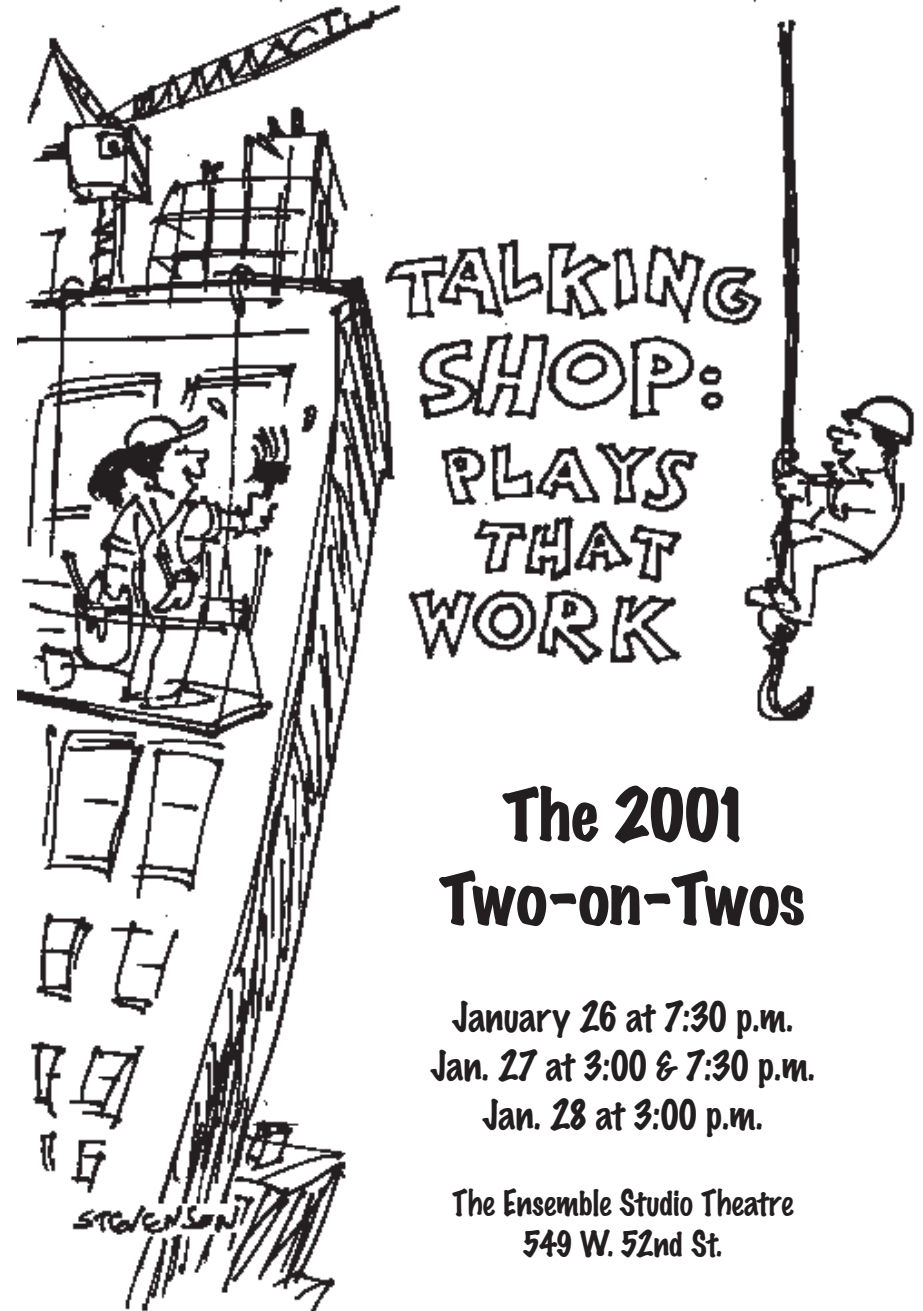

TALKING  
SHOP:  
PLAYS  
THAT  
WORK

The 2001  
Two-on-Twos

January 26 at 7:30 p.m.  
Jan. 27 at 3:00 & 7:30 p.m.  
Jan. 28 at 3:00 p.m.

The Ensemble Studio Theatre  
549 W. 52nd St.



*The 2001 Two-on-Twos*  
**Talking Shop: Plays that Work**  
 The Ensemble Studio Theatre - Jan. 26-28, 2001



**The 52nd Street Project Staff**

Gus Rogerson, Artistic Director  
 Carol Ochs, Executive Director  
 Michael Bernard, Associate Artistic Director  
 John Sheehy, Director of Development and Marketing  
 George Roman Babiak, Production Manager  
 Julie Feldman, Director of Education  
 Megan Sandberg-Zakian, Volunteer Coordinator  
 Chris Ceraso, Teen Dean  
 Iris A. Brown, Graphic Designer  
 Mayleen Cancel and Lorraine Zambrano, Receptionists  
 Interns: Liz Bell, Jennifer Boring, Emily Crow

**Production Staff**

**Composer:** Patrick Barnes  
**Set Designer:** Kevin Joseph Roach  
**Lighting Designer:**  
 Greg MacPherson  
**Costume Designer:**  
 Anney McKilligan  
**Sound Designer:** Maury Schott  
**Stage Manager:** Jenny Peek  
**Slide Design Team:**  
 Monty Nicol, Kim Snow, Kevin Coffey,  
 Katherine Lumb, Vickie Clarke

**Prop Design Team:**

Megan Bartholomay, Jennifer Boring,  
 Emily Crow, Kate Hancock,  
 Jenny Peek,

**"Talking Shop" Illustrations:**

James Stevenson

**Furniture Crew:**

Emily Crow, Luis Anthony Maldonado

**Prop Crew:**

Kate Hancock, Diana Rojas

**Slide Projector Apparatus**

**Manager (SPAM):**

Jennifer Boring

**Load-in and Light-hang Crew:**

Jennifer Boring, Bill Charlton,  
 Emily Crow, Doug Lockwood,  
 Matt Maher, Jill Robbins, Tom Schall,  
 John Sheehy, Vanessa Valdes,  
 Becky White

**House Managers:**

Karin Schall, Mary Pat Walsh,  
 Beth Emelson

**Weekend-away Host & Guest Chef:**

Maria Tucci

**Weekend-away chefs:**

Carol Ochs,  
 John Sheehy



NATIONAL  
 ENDOWMENT  
 FOR THE ARTS

The Two-on-Two Program is made possible with public funds from the National Endowment for the Arts; The New York State Council on the Arts, a state agency; the Department of Youth and Community Development; and the New York City Department of Cultural Affairs. The 52nd Street Project is a member of Art/NY.

State of the Arts



NYSCA

**COOL STUFF ON SALE  
 IN THE LOBBY!**

The Fabulous Flyer Bar .....\$2.00 & \$1.50  
*and featuring Shel Silverstein's "Fivey and Twoey" logo:*  
 Project T-shirts (short sleeve) .....\$12.00  
 Project T-shirts (long sleeve) .....\$15.00  
 Project Caps .....\$15.00  
 Project Mugs .....\$5.00  
 Project Pencil 3-pack (now in RED!) .....\$1.00

Thank you for coming to **TALKING SHOP!** If you are not on our mailing list (or if your address has changed), please fill out this form and give it to us on your way out or mail it to the address below. We would also like to know if you are interested in becoming a volunteer. We need help in *all areas*, so be sure to fill out the entire form.

**PLEASE ADD ME TO YOUR MAILING LIST:**

1/01

NAME: \_\_\_\_\_

ADDRESS: \_\_\_\_\_

ZIP \_\_\_\_\_

HOME PHONE: \_\_\_\_\_

DAYTIME PHONE: \_\_\_\_\_

E-MAIL ADDRESS: \_\_\_\_\_

MY OCCUPATION: \_\_\_\_\_

MY HOBBIES: \_\_\_\_\_

**YES, I WOULD LIKE TO BE OF HELP. I CAN:**

- |   |   |  |
|---|---|--|
| <input type="checkbox"/> Help load in and out for shows | <input type="checkbox"/> Draw and/or paint  | <input type="checkbox"/> Help kids with homework |
| <input type="checkbox"/> Hang lights                    | <input type="checkbox"/> Help with mailings | <input type="checkbox"/> Teach kids a skill      |
| <input type="checkbox"/> Work on a backstage crew       | <input type="checkbox"/> Do office work     | <input type="checkbox"/> Be a chef at an event   |
| <input type="checkbox"/> Do graphic design              | <input type="checkbox"/> Design sound       | <input type="checkbox"/> Design and sew costumes |
| <input type="checkbox"/> Other (please specify) _____   |   |  |

**MY SCHEDULE IS:**

- Very flexible. I'm often available during weekdays.  
 Somewhat flexible. I can help on the occasional morning or afternoon during the week.  
 Not very flexible at all, but I've got some free time on evenings and weekends.

If you would like to mail this (and you're always welcome to enclose a tax-deductible contribution), you can send it to: **The 52nd Street Project**, 500 West 52nd St., New York, NY 10019. Or fax it to (212) 333-5598.

## Don't Miss Our Upcoming Shows!

### 2001 Sonnet Scenes

Co-written by William Shakespeare and  
the teens of the 52nd Street Project

Saturday, Feb. 10th at 7:30 p.m. and  
Sunday, Feb. 11th at 3:00 p.m.

at the Women's Interart Annex  
500 W. 52nd St., #2A

(Just across the hall from the Clubhouse)

Call (212) 333-5252 for reservations.

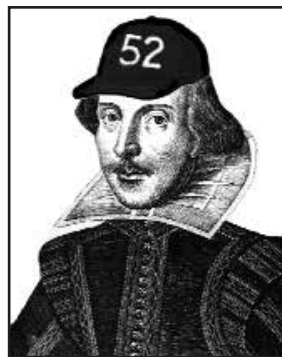

## JUST ASKIN'! THE CURIOSITY PLAYS

The Winter Playmaking Plays  
March 23-25 at  
HB Playwright's Foundation

This month, a fresh batch of newcomers began our 8-week Playmaking program. At the end of the class they will be whisked away to Kent, Connecticut for a weekend in which they will fashion 10 brand new plays featuring your favorite Project adult actors.

HONORARY CO-CHAIRS GINA TORRES AND LAURENCE FISHBURNE INVITE YOU TO

**SAVE THE STARDATE: MAY 7, 2001**

# 52001:



THE 52ND STREET PROJECT'S  
**SPACE BENEFIT**

**IN SPACE NO ONE CAN HEAR YOU SCREAM WITH LAUGHTER!**

For information or reservations call

Commander John Sheehy at (212) 333-5252.

The 52nd Street Project is a non-profit organization that brings inner-city children from the Hell's Kitchen neighborhood together with professional theater artists to create original theater. **Talking Shop** is a production of our Two-on-Two program, in which two of the Project's more seasoned kids are matched with two adult volunteers (one playwright, one director) and given the task of creating a short play. After the writers presented their contributions, the actors and directors traveled to Dutchess County earlier this month to rehearse the plays over a three-day weekend. Tonight's performance is the final result.

The Project is delighted to return to the **Ensemble Studio Theatre**, where we have been performing since our inception in 1981. We gratefully acknowledge that if E.S.T. wasn't here, we'd be nowhere.

### The 52nd Street Project Board of Directors

Ben Barenholtz

Lisa Benavides

Rachel Chanoff

Heidi Ettinger

Wendy Ettinger, *chair emeritus*

Louis P. Friedman

Stephen Graham

Larry Jones

James McDaniel

Frances McDormand, *chair*

Patricia M. Murphy, Esq.

Carol Ochs

Willie Reale

Gus Rogerson

José Soto, Jr.,

*alumni boardmember*

Pamala Tyson

Laura Valeroso

Wendy vanden Heuvel

Jenny Wiener

### Special Thanks

We're grateful to Curt, Jamie, Eliza, Tim, and the rest of the staff at The Ensemble Studio Theater for making their theater available to us. Maria Tucci, Alice Provenson, Stephen Perpeluk and Terry Fitzpatrick, and Derek McLane and Wendy Ettinger graciously allowed us to use their upstate homes for three tumultuous, but fun-filled days.



Help build the Clubhouse Library! Buy us a book or two from **Amazon.com** by logging on to our on-line "wish list." Scroll down the right side of their home page and click on WISHLIST, then type "project52@aol.com" into the email search field. Then just click away to stock our stacks!

# Talking Shop: Plays That Work - ACT I

All music composed by Patrick Barnes

## Jest Friends

By Robert Shaffron. Directed by John Steber.

Larry ..... Peter Granados  
Moe ..... Johnathan Roldan  
Princess ..... Diana Rojas  
Herald ..... Gus Rogerson

“Put The Fun in Funny” lyrics by Robert Shaffron.

## What’s In Your Shopping Bag?

By Regina Porter. Directed by Martha Banta.

Mannequin ..... Mona Lisa Barthelemy  
Solace ..... Felicita Jerez  
Boy ..... Luis Anthony Maldonado

“Being Truly Glamorous” lyrics by Regina Porter & John Sheehy.

## Betty and The Brute

By George Babiak. Directed by Josh Lewis.

Betty ..... Anju Andre-Bergmann  
The Brute ..... Steven Vasquez  
Vince ..... Josh Lewis  
Manny from Massapequa ..... Luis Anthony Maldonado  
Wendy from Weehawken ..... Keira Naughton  
Pete from Piscataway ..... George Babiak

“Betty and The Brute Theme” and “Maintain Your Equilibrium” lyrics by George Babiak.

☞ **Intermission!** ☜

# ACT II

## Do The Math

by Theresa Rebeck. Directed by Jenny Pollack.

Bibi ..... Lorraine Calderon  
Nina ..... Marlene Moran  
Store clerk ..... Emily Crow

“Friends Forever” lyrics by Theresa Rebeck.

## Work With Me

by Oni Faida Lampley. Directed by Keira Naughton.

Louis ..... Justin Aponte  
Violetta ..... Shevonne Hernandez  
Nurse ..... Luis Anthony Maldonado

“A Reggae Rage” lyrics by John Sheehy.

## The Legend of Duke Hogwallar

By Jerome Hairston. Directed by Jonathan Bernstein.

Duke Hogwallar/Piglet Paul ..... Robert Tomas  
Piglet Pete/Duke Hogwallar II ..... Michael Feliciano  
The Farmer ..... George Babiak  
Vern ..... Josh Lewis

“There Ain’t No Spokin’ The Duke” lyrics by Jerome Hairston.

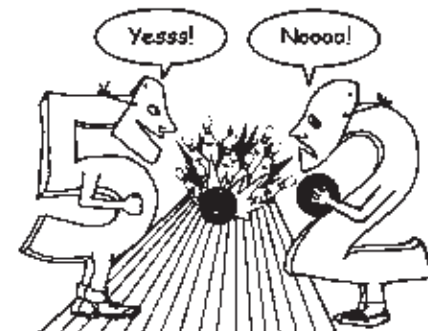

The **52nd Street Project Teen Ensemble** is a two-year program for graduates of The Project's writing and acting classes. The Teen Ensemble focuses on professional level acting technique by using both original and existing texts. The culmination of the program is the performance of a play by William Shakespeare as seen through the eyes of the kids in the class. The most recent teen production, **Midsummer Night's Dream**, was performed in the summer of 2000 at **Theatro Technis** in London and the **Chateau de Berne** in Lorgues, France. The teens you see tonight will journey to London this summer to present their own version of **The Tempest**.

### The Project Staff

Gus Rogerson .....Artistic Director  
 Carol Ochs .....Executive Director  
 Michael Bernard .....Associate Artistic Director  
 John Sheehy .....Director of Development  
 George Roman Babiak .....Production Manager  
 Julie Feldman .....Director of Education  
 Megan Sandberg-Zakian .....Volunteer Coordinator  
 Chris Ceraso .....Teen Dean  
 Iris A. Brown .....Graphic Designer  
 Mayleen Cancel, Lorraine Zambrano .....Receptionists  
 Jennifer Boring, Emily Crow, Kate Hancock .....Interns

### The 52nd Street Project Board of Directors

Ben Barenholtz	Patricia M. Murphy, Esq.
Lisa Benavides	Carol Ochs
Rachel Chanoff	Willie Reale
Heidi Ettinger	Gus Rogerson
Wendy Ettinger, <i>chair emeritus</i>	José Soto, Jr., <i>alumni boardmember</i>
Louis P. Friedman	Pamala Tyson
Stephen Graham	Laura Valeroso
Larry Jones	Wendy vanden Heuvel
James McDaniel	Jenny Wiener
Frances McDormand, <i>chair</i>	

The Project would like to thank: Fran McDormand and Susan Ross for hosting us upstate during a weekend of writing; Margot Lewitin, Paul Smithyman, and all the folks at Women's Interart for generously allowing us to use their space.

## The 52nd Street Project Presents

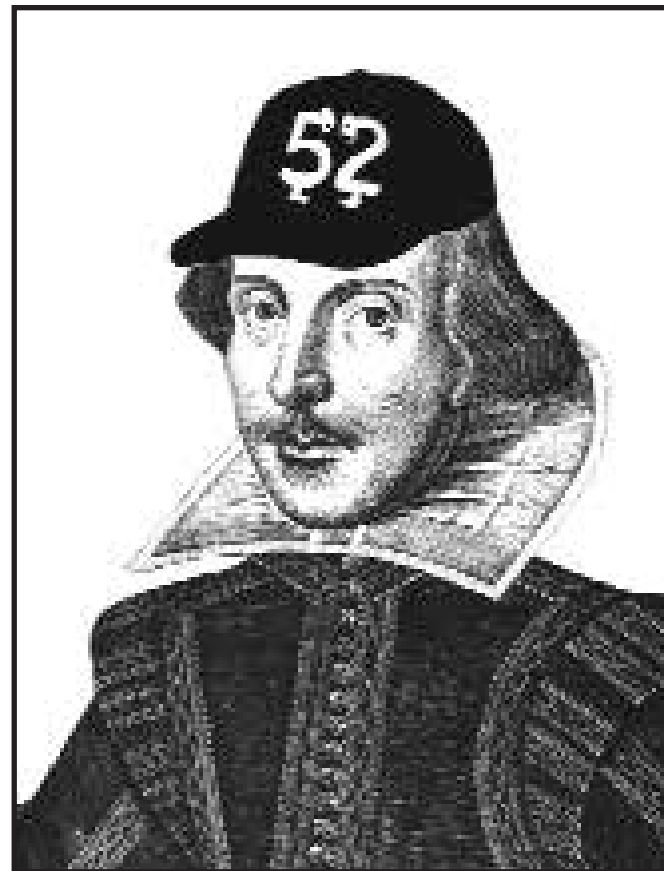

# 2001 Sonnet Scenes

*Co-written by William Shakespeare  
 and the Teens of the 52nd Street Project*

*Saturday, Feb. 10th at 7:30 p.m.*

*Sunday, Feb. 11th at 3:00 p.m.*

*at the Women's Interart Annex*

*Funded in part by The Surdna Foundation*

# 2001 Teen Sonnet Scenes

## The Sun and the Rainbow

By Sahara Walsh from Sonnet #26

Directed by Melissa Bowen, Dramaturgy by Abigail Lopez

Soleil .....Sahara Walsh  
Suzette .....Catherine Mueller  
Kevin .....Alex Metzler

## White Lady

By Deshana Hamid from Sonnet #147

Dramaturg/Directors: Roz Coleman and Megan Sandberg-Zakian

Ebony .....Deshana Hamid  
Alexis .....Roz Coleman  
Rosaria .....Judy Agosto  
Michelle .....Tessa John-Connor

## Learning To Trust

By Alex Metzler from Sonnet #23

Dramaturg/Director: Buzz Bovshow

Rob .....Alex Metzler  
Alice .....Tessa John-Connor  
Nick .....Thomas Santoni  
Nina .....Melissa Bowen

## As the Kingdom Turns

By Mary Vamvoukakis from Sonnet #35

Directed by Catherine Mueller, Dramaturgy by Enid Graham

Princess .....Mary Vamvoukakis  
Inventor .....George Babiak  
King .....Buzz Bovshow  
Guard .....John Sheehy  
People of Kingdom .....Ensemble

## The Telegram

By Tessa John-Connor from Sonnet #64

Directed by Chris Ceraso, Dramaturgy by Annie Torsiglieri

Carrie .....Tessa John-Connor  
Miguel .....Thomas Santoni  
Postal Worker .....Melissa Bowen

## Crushes

By Judy Agosto from Sonnet #29

Dramaturg/Director: Megan Sandberg-Zakian

Haze .....Judy Agosto  
Victoria .....Deshana Hamid  
Damion .....Alex Metzler

## My First Love

By Thomas Santoni from Sonnet #44

Directed by Michael Bernard & Chris Ceraso,

Dramaturgy by Chris Ceraso

Thomas .....Thomas Santoni  
Jake .....Alex Metzler  
Marissa .....Mary Vamvoukakis  
Carmen .....Judy Agosto  
Teacher (offstage) .....Chris Ceraso  
Fly Honey 1 .....Roz Coleman  
Fly Honey 2 .....Deshana Hamid

Stage Manager and Sound Designer:

Jennifer Boring

Light Operator and Prop Handler:

Emily Crow

**Intermission!**

The 52nd Street Project gratefully acknowledges the support of the following foundations and corporations: ABNY Foundation, Barker Welfare Foundation, The Bamsley Foundation, Broadway Play Publishing, Carnegie Corporation of New York, Comedy Central, Consolidated Edison, The Dammann Fund, The Dramatists Guild Fund, Dramatists Play Service, Eleanor, Adam & Mel Dubin Foundation, The Educational Foundation Of America, Entertainment Weekly, Ford Foundation, The Fan Fox & Leslie R. Samuels Fdn., Gap Inc., GLADPZ Foundation, The Horace W. Goldsmith Foundation, The Florence Gould Foundation, The William & Mary Greve Foundation, Heights Partners, The Holland Lodge Foundation, Inc., Hudson Scenic Studio, Betty E. & George B. Kaiser Foundation, Rita J. and Stanley H. Kaplan Foundation, Lloyds TSB Bank plc, Luca, Inc., James A. Macdonald Foundation, Ann M. Martin Foundation, J.P. Morgan Charitable Trust, Mosaic Entertainment, The New World Foundation, The New York Times Co. Fdn., Newman's Own, O'Grady Family Foundation, Laura Pels Foundation, Staging and Design, Inc., Harold & Mimi Steinberg Charitable Trust, The Surdna Foundation, Susquehanna, Tandler Textile Inc., Uniwold Group Inc., John A. Vassilaros & Sons, Inc, The Vervane Foundation, West Bank Cafe, The Wiener Family Foundation, Yorke Construction Corporation. In addition the following individuals made gifts of over \$150 this year (list is current as of 1/24/01)

Anonymous	Eric & Juli Frankel	Chris & Sally Lutz	Daryl Roth
Liliana Amador-Martí	Richard Frankel & Kathleen Clark	John Lyons	Donald Rothschild
& Frank Marty	Naomi Freundlich & Charles Miles	Marsue & Peter MacNicol	& Lottchen Shivers
May Ameen	Geraldine R. Frey	Greg MacPherson	Kenneth Rothstein
Peter Askin	Louis & Patrice Friedman	& Jane Perlmutter	Steve Sabba
June Ballinger & Michael Goldstein	Hank Gallo	Joseph Maffia	Richard & Madeline Salzman
Ben Barenholtz	Victor Garber	Roma Maffia	Laura Sametz
Jessica Bauman	Beth Gardiner	Rusty Magee & Alison Fraser	Tim & Lisa Sanford
Laurie Becker & Rick Sweren	Rose Gasner & Larry Chertoff	Paul & Lauren Mandell	Joshua Sapan
Meredith Beeuwkes	Joseph & Margaret Gazzdak	Brian & Marsha Mannain	Stacey Schaffer & Eric Schwartz
Lisa Benavides & Tim Nelson	John A. Vassilaros	Elizabeth Manne	Karin & Tom Schall
Stephanie Berger & Paul King	& Alexandra Gersten	Peter Manning & André Bishop	Leslie Schine & Nils Nilsen
Scott Bergman	Ileen Getz & Mark Grinnell	Donald Margulies & Lynn Street	Glyna & Neil Schlesinger
Brett Berk	Nancy Giles	Ali Marsh	Beth Schneider
Pam Berlin & Billy Carden	Lloyd & Kilty Gilmour	Tory & Howie Masters	Maurly Schott
Arthur & Sandra Bernard	Judy Goldman & Michael Pillingier	Kay Matschullat & Allan Arffa	Marc Segan
Barry & Myrna Bernard	Tony Goldwyn & Jane Musky	Max Mayer & Catherine Corpeny	Mitchell Semel & Colleen Carroll
Alexander & Elizabeth Bernstein	Stephen & Cathy Graham	Drew McCoy & Amy Aquino	Aaron & Elaine Shapiro
Vicky Bijur & Ed Levine	Connie Grappo & Lee Wilkof	Paul McCrane & Dana Kellin	Bernice Baruch Shawl
Lewis Black	Michael Greif & Jonathan Fried	James & Hannelore McDaniel	Andrew & Helen Sheinman
Jeanette & Samuel Black	Emily Grishman	Fran McDormand & Joel Coen	Jan Sidebotham & Tim Emerson
Richard Blackstone	& Susan Sampliner	Brian Mertes	Meg Simon
& Yldez Yukse	Rebecca & Peter Grunwald	Bette Midler	Landon Slane
Tessa Blake	Lisa Gugenheim	Patricia Miller & Chris McFarland	Tom Slaughter & Marthe Jocelyn
Audrey Bloch & Joseph Wiesenthal	Evan Handler	Isaac Mizrahi	Ken Smith
Robi & Ruth Blumenstein	Stuart & Lorna Hayim	Ross & Beth Moore	Phillip K. & Gloria W. Smith
Buzz Bovshow	Peter Herdrich & Karen Trott	Walter Mosley	Abigail Rose Solomon
Becky Browder & Ted Neustadt	William Holtzman	Michaela Murphy	Dr. David Solowiejczyk
Deborah Brown	& S. Sylvia Shepard	& Larry Nathanson	José & Michelle Soto
Susan Bruce & Peter Hedges	Barnard Hughes	Patricia M. Murphy, Esq.	Dorothy Spears & Vance Brown
John Burt	& Helen Stenborg Hughes	& Adam Spilka	Jeff Stafford
Kate Burton & Michael Ritchie	Andrew Hurwitz & Dana Segal	Randy & Rona Nelson	John Steber & Robert Shaffron
Joseph & Hilary Califano	Dana Ivey	Ruth Nelson	Jean Stein
Linda & Arthur Carter	Sy Jacobs	Mark Nesselson, M.D.	Anne Meara & Jerry Stiller
Rachel Chanoff	Whitney Scott & Peter Jacobson	& Elliott Rosenblum	Susanna Styron & Darrell Larson
Glenda Chesshir	Macon R. & Michael B. Jessop	Cynthia Nixon	Daniel Swee
Ethan Coen & Trish Cooke	Amanda Johns	Steven O'Neill	Mariko Tada
Lietla Hesen-Cohen & Richard Cohn	Julia A. Johns	Kevin O'Rourke & Edith Thurber	Jay & Rachel Tarses
Thomas Cott	Andrea Johnson	Carol Ochs & Bruce MacVittie	Mary Lou Teel & Peter Freundlich
Margaret Crimmins	Traci Paige Johnson	Paul & Maria Onderdonk	Joan Vail & John Thorne
Colleen Croft & Louis Balducci	& Robert Mowen	Steven & Margot Peter	Tracy Thorne & Edmund Lewis
Stephen & Sandra Crudgington	Cherry Jones & Mary O'Connor	Elizabeth Peters	John & Katherine Turturro
Willem Dafeo & Liz Lecompte	Larry & Mary Jones	Bat-Sheva & Thomas Peters	Laura Valeroso & David Seidman
Arthur Dantchik	Maurice Kanbar	Ethan Phillips	Katrina vanden Heuvel
Peter & Judith Dawkins	Ronald Kastner	Susan Ochs Phillips	Wendy vanden Heuvel
Edward & Joanne DiRugieris	Susan Kaufman	Virginia Pike	& Brad Coley
Alex Draper & Lorraine Tobias	Mark Keoppen & Wendy Townsend	Oliver Platt	William & Melinda vanden Heuvel
Richard & Rebecca Dresser	John Kirtley	& Camilla Campbell Platt	John A. Vassallo
Christopher & Karen Eddowes	Seth & Beth Klarman	Richard Polatchek	Mary Pat Walsh
Mario Egozi	Joana & Jason Kliot	Jeremy Posner	Borah & Mildred Walton
David Eigenberg	Mary Kong	Dean & Leslie Potashner	Sally & Lenny Weiss
Ned Eisenberg	Judy Kuhn & David Schwab	Gigi Pritzker Pucker	Gregory Welch
Barbara Ettinger	Roger & Belle Kuhn	& Michael Pucker	Jane Bolster & Steve Wertimer
Barbara Ettinger & Sven Huseby	Michael A. Lane	Christopher Randolph	Donna & Walter Wick
Heidi Ettinger	Mark Lanow & Joanne Astrow	Peter & Helen Randolph	Jenny Wiener
Wendy Ettinger & Derek McLane	Allan & Nanette Larson	Anthony Ranieri	Michael & Zena Wiener
Adam Felber & Jeanne Simpson	Jill Larson	Paul Reale & Barbara McCrane	Matt Williams & Angelina Fiordellisi
Gerald Fernandez	Kate Lear & Jonathan LaPook	Willie Reale & Jenny Gersten	Jan Wilson & Saula Cutter
Peter Jay Fernandez	Mitchell Lemsky & Jane Bodle	Theresa Rebeck & Jess Lynn	Donald Windham
& Denise Burse	Robert Sean Leonard	Alysia Reiner & David Basche	Joanne Woodward & Paul Newman
Hannah Finn & John Wiltshire	Joshua Lewis	Jacquelyn Reingold	Anne & Charles Wright
Alexa Fogel	Mark Linn-Baker & Adrienne Lobel	Todd Richter & Donna Plummer	Jeffrey & Janine Yass
Tom Fontana & Sagan Lewis	Jessica Lissy	Herald & Linda Ritch	James & Mary Lin Yoshimura
Katherine Foster	John Bedford Lloyd	David & Anita Rogerson	Aylin Yuksek
David Frankel	& Anne Twomey	Robin Morse & Gus Rogerson	Virginia Zakian & Robert Sandberg

## THE 52ND STREET PROJECT PRESENTS



# JUST ASKIN': THE CURIOSITY PLAYS

## THE WINTER 2001 PLAYMAKING PLAYS

HB PLAYWRIGHT'S FOUNDATION

124 BANK ST.

FRIDAY, MAR. 23 AT 7:30 P.M.

SATURDAY, MAR. 24 AT 3:00 P.M. AND 7:30 P.M.

SUNDAY, MAR. 25 AT 3:00 P.M.

# JUST ASKIN'

THE CURIOSITY PLAYS

The Winter 2001  
Playmaking Plays  
HB Playwright's Foundation  
Mar. 23-25, 2001

**The 52nd Street Project Staff:**

Gus Rogerson, Artistic Director  
Carol Ochs, Executive Director  
Michael Bernard, Associate Artistic Director  
John Sheehy, Director of Development and Marketing  
George "X-Acto" Babiak, Production Manager  
Julie Feldman, Director of Education  
Megan Sandberg-Zakian, Volunteer Coordinator  
Chris Ceraso, Teen Dean  
Iris A. Brown, Graphic Designer  
Mayleen Cancel and Lorraine Zambrano, Receptionists  
Interns: Liz Bell, Jennifer Boring, Emily Crow, Kate Hancock



**Production Staff**

**Composer:** Rusty Magee  
**Set Designer:** Kevin Joseph Roach  
**Lighting Designer:** Greg MacPherson  
**Costume Designer:** Crystal Thompson  
**Sound Designer:** Jennifer Boring  
**Stage Manager:** Noël Dawkins  
**Slide Design Team:** Kevin Coffey, Kim Snow, Iwona Waluk, Monty Nicol, Richard Hicks, Vickie Clarke, Katherine Lumb

**Prop Design Team:** George Babiak, Jennifer Boring, Heather Carnduff, Jodi Cohen, Stacy Cohen, Emily Crow, Lucas Fleischer, Martin Gobbée, Kate Hancock, Cara Marcous, John Sheehy

**"Just Askin'" Illustrations:** Cara Marcous

**Furniture Crew:** Doug Lockwood, Johnathan "Big J" Roldan  
**Prop Crew:** Emily Crow, Jeni Saunders  
**Slide Projector Apparatus Manager:** Kate Hancock  
**Load-in and Light-hang Crew:** Mona Arriola, Jennifer Boring, Emily Crow, Elissa Errick, Tim Gallagher, Kate Hancock, Allison Kyle, Christopher Randolph, Chris Ryan, Tom Schall, John Sheehy, Matt Staniec, Vanessa Valdes, Becky White

**House Manager:** Karin Schall, Susan McGinniss

**Weekend-away Host:** Stephen and Cathy Graham

**Weekend-away chef:** Kimberly Diamond Mines



NATIONAL  
ENDOWMENT  
FOR THE ARTS

The Playmaking Program is made possible with public funds from the National Endowment for the Arts; The New York State Council on the Arts, a state agency; the Department of Youth and Community Development; and the New York City Department of Cultural Affairs. The 52nd Street Project is a member of Art/NY.

State of the Arts



NYSCA

## COOL STUFF ON SALE IN THE LOBBY!

The Fabulous Flyer Bar .....\$2.00 & \$1.50  
and featuring Shel Silverstein's "Fivey and Twoey" logo:  
Project T-shirts (short sleeve) .....\$12.00  
Project Tank Tops .....\$12.00  
Project Caps .....\$15.00  
Project Mugs .....\$5.00  
Project Pencil 3-pack (now in RED!) .....\$1.00

Thank you for coming to **JUST ASKIN'**! If you are not on our mailing list (or if your address has changed), please fill out this form and give it to us on your way out or mail it to the address below. We would also like to know if you are interested in becoming a volunteer. We need help in **all areas**, so be sure to fill out the entire form.

**PLEASE ADD ME TO YOUR MAILING LIST:**

3/01

NAME: \_\_\_\_\_

ADDRESS: \_\_\_\_\_

ZIP \_\_\_\_\_

HOME PHONE: \_\_\_\_\_

DAYTIME PHONE: \_\_\_\_\_

E-MAIL ADDRESS: \_\_\_\_\_

MY OCCUPATION: \_\_\_\_\_

MY HOBBIES: \_\_\_\_\_

**YES, I WOULD LIKE TO BE OF HELP. I CAN:**

- |   |   |  |
|---|---|--|
| <input type="checkbox"/> Help load in and out for shows | <input type="checkbox"/> Draw and/or paint  | <input type="checkbox"/> Help kids with homework |
| <input type="checkbox"/> Hang lights                    | <input type="checkbox"/> Help with mailings | <input type="checkbox"/> Teach kids a skill      |
| <input type="checkbox"/> Work on a backstage crew       | <input type="checkbox"/> Do office work     | <input type="checkbox"/> Be a chef at an event   |
| <input type="checkbox"/> Do graphic design              | <input type="checkbox"/> Design sound       | <input type="checkbox"/> Design and sew costumes |
| <input type="checkbox"/> Other (please specify) _____   |   |  |

**MY SCHEDULE IS:**

- Very flexible. I'm often available during weekdays.  
 Somewhat flexible. I can help on the occasional morning or afternoon during the week.  
 Not very flexible at all, but I've got some free time on evenings and weekends.

If you would like to mail this (and you're always welcome to enclose a tax-deductible contribution), you can send it to: **The 52nd Street Project**, 500 West 52nd St., New York, NY 10019. Or fax it to (212) 333-5598.

## Don't Miss Our Upcoming Shows!

HONORARY CO-CHAIRS GINA TORRES AND LAURENCE FISHBURNE INVITE YOU TO  
**SAVE THE STARDATE: MAY 7, 2001**

# 52001:



THE 52ND STREET PROJECT'S  
**SPACE BENEFIT**

**IN SPACE NO ONE CAN HEAR YOU SCREAM WITH LAUGHTER!**

For information or reservations call  
Commander John Sheehy at (212) 333-5252.

William Shakespeare's

# THE TEMPEST

Adapted by Chris Ceraso and  
the Project's Teen Ensemble

Directed by  
Michael Bernard



NEW YORK  
PERFORMANCE:  
June 29th

LONDON, ENGLAND  
PERFORMANCE:  
July 4th

IPSWICH, ENGLAND  
PERFORMANCE:  
July 6th

The 52nd Street Project is a non-profit organization that brings inner-city children from the Hell's Kitchen neighborhood together with professional theater artists to create original theater. **Just Askin'!** is a production of our Playmaking program. Young people participate in an eight-week playwriting course taught by Michael Bernard and adapted for the Project by Daniel Judah Sklar from his book *Playmaking: Children Writing and Performing Their Own Plays*. At the end of the course, each child is given two actors, a theme, and a dramaturg/director who guides him or her through the writing of a play during a weekend retreat in the country. Tonight's performance is the end result.

### The 52nd Street Project Board of Directors

Ben Barenholtz	Patricia M. Murphy, Esq.
Lisa Benavides	Carol Ochs
Rachel Chanoff	Willie Reale
Heidi Ettinger	Gus Rogerson
Wendy Ettinger, <i>chair emeritus</i>	José Soto, Jr., <i>alumni boardmember</i>
Louis P. Friedman	Pamala Tyson
Stephen Graham	Laura Valeroso
Larry Jones	Wendy vanden Heuvel
James McDaniel	Jenny Wiener
Frances McDormand, <i>chair</i>	

### Special Thanks

We're grateful to Stephen and Cathy Graham for graciously allowing us to bring the chaos of a Playmaking weekend to their lovely home in Kent, Connecticut. Thanks also go to Sam and Lynn Waterston, and Dave and Susie Ott for providing overnight accommodations. A thousand thanks to Wendy vanden Heuvel for making a thousand phone calls to find us places to stay. Finally, Billy Carden, David and all the hard-working interns at HB Playwright's Foundation earn our thanks for making us feel so welcome on Bank St.



Help build the Clubhouse Library! Buy us a book or two from **Amazon.com** by logging on to our on-line "wish list." Scroll down the right side of their home page and click on WISHLIST, then type "project52@aol.com" into the email search field. Then just click away to stock our stacks!



## JUST ASKIN': THE CURIOSITY PLAYS— ACT I

All original music composed by Rusty Magee

### Friendship

by Anastasia Kehr, age 11. Dramaturg/Director: Liz Tuccillo.

Billiard ..... Josh Lewis  
Summer ..... Maria Tucci

### Gonlap Disagrees

by Wonkezeh Newenle, age 12. Dramaturg/Director: Maury Schott.

Myta ..... Reed Birney  
Gonlap ..... Arthur French  
Pota ..... Myra Lucretia Taylor  
Contestants ..... Johnathan Roldan, John Sheehy  
Referee ..... Teagle Bougere

*“To Keep the Family Together”* lyrics by Wonkezeh Newenle

### I Want, You Want

by Katherine Acosta, age 10. Dramaturg/Director: Liliana Amador.

Taina ..... Tanya Gingerich  
Jessica ..... Keira Naughton  
Clerk ..... Doug Lockwood  
Operator ..... Jeni Saunders  
Police Officer ..... Johnathan Roldan

### The Drain

by Edwin Toro, age 12. Dramaturg/Director: Michael Dolan.

Mike ..... Teagle Bougere  
Melissa ..... Marissa Copeland  
Announcer ..... Doug Lockwood

### Single Beauties

by Suzette Santana, age 10. Dramaturg/Director: Peter Jay Fernandez.

Nayomi ..... Edie Falco  
Britney ..... Lisa Leguillou  
Announcer ..... Doug Lockwood

*“Single Beauties”* lyrics by Suzette Santana

👉 **Intermission!** 👈

## ACT II

### The Woodsman and The Tree

by Barry Myers, age 10. Dramaturg/Director: Gus Rogerson.

Spikey Life ..... Anthony Barrile  
Ring ..... Robert Colston

### If You Could Understand Me

by Evelyn "Nicky" Rosario, age 10. Directed by Ashby Semple.

Elvea ..... Nedra Gallegos  
Alabama ..... Jennifer Ostrega  
James ..... Johnathan Roldan  
Dr. Cutwig ..... John Sheehy  
Crystal ..... Emily Crow

*“If You Could Understand Me”* lyrics by Evelyn “Nicky” Rosario

### The Diseased Monkey

by Alex Kehr, age 10. Dramaturg: Michael Bernard  
Director: Jessica Bauman.

Koo Koo ..... James Naughton  
Spot ..... Frank Wood

### Amanda and J.J.

by Ariana Casablanca, age 11. Dramaturg/Director: Saudia Young.

Amanda ..... Myra Lucretia Taylor  
J.J. ..... Godfrey L. Simmons, Jr.  
David ..... Joe White

*“Amanda’s Song”* lyrics by Ariana Casablanca

### Paint Brush

by Joshua Joya, age 11. Dramaturg/Director: Joe White.

Winston ..... Arthur French  
Roger ..... Kevin Geer  
Anna ..... Stephanie Bast

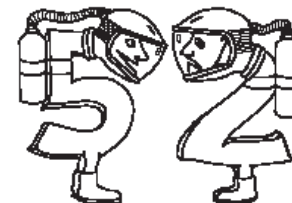

Jenny Wiener, Mosaic Entertainment and the Board of Directors of The 52nd Street Project present

# 52001: A SPACE BENEFIT



**BOARD CHAIR**

Frances McDormand

**ARTISTIC DIRECTOR**

Gus Rogerson

**EXECUTIVE DIRECTOR**

Carol Ochs

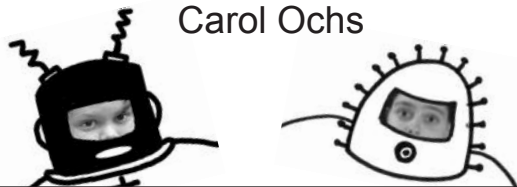

## Honorary Chairs

Laurence Fishburne and Gina Torres

## Co-Chairs

Lisa Benavides  
Becky Browder  
Louis P. Friedman  
Patrice Friedman

Karin Schall  
Laura Valeroso  
Mary Pat Walsh  
Jenny Wiener

## The Board of Directors

Ben Barenholtz  
Lisa Benavides  
Rachel Chanoff  
Heidi Ettinger  
Wendy Ettinger,  
*chair emeritus*  
Louis P. Friedman  
Stephen Graham  
Larry Jones  
James McDaniel  
Frances McDormand,  
*chair*

Patricia M. Murphy, Esq.  
Carol Ochs  
Willie Reale,  
*founder*  
Gus Rogerson  
Jose Soto, Jr.,  
*alumni boardmember*  
Pamala Tyson  
Laura Valeroso  
Wendy vanden Heuvel  
Jenny Wiener



The 52nd Street Project  
gratefully acknowledges...

Au'Some Candies Inc.  
Big Apple Lights  
Iris A. Brown  
Capital Printing/Ron Kastner  
The Coleman Company,  
*A subsidiary of the Sunbeam corporation*  
Entertainment Weekly  
The Gap  
Hudson Scenic Studios  
Noggin  
The Printing Store  
Scholastic, Inc.  
Seagram's Chateau & Estate Wines Co.  
Sesame Workshop  
Wendy Stulberg  
John A. Vassilaros & Sons  
Watkins Incorporated  
*Healthier Living Since 1868*



## The Cast

General Leigh Speaking . . . . . Tiffany Butler  
Major Spacecase . . . . . Frances McDormand  
Borax . . . . . Oliver Platt  
Chore Boy . . . . . Michael Feliciano  
Lestoil . . . . . Maria Tucci  
Spongemop . . . . . Jeremy Butler  
The Bearer . . . . . Lewis Black  
The Assistant . . . . . Octavia Rodriguez

Plus a special vocal appearance by  
Dan Castellaneta

### THE SONGS

"Funny Stuff from Outer Space,"  
and "An Important Message from Borax"

### DIRECTED BY

Jonathan Bernstein

### CREATIVE CONSULTANT

Becky Browder

### MUSIC COMPOSED AND PERFORMED BY

Rusty Magee

With additional musical direction by Ginny Pike

### LYRES BY

Willie Reale

### BOOK BY

Michael Bernard, Willie Reale, & John Sheehy

### SET DESIGN

Kevin Joseph Roach

### LIGHTING DESIGN

Greg MacPherson

### COSTUME DESIGN

Crystal Thompson

### SOUND DESIGN

Tom Morse

### STAGE MANAGER

Hank Meiman

### PROP AND SET DESIGN TEAM

George Babiak, Jen Boring, Heather Carduff,  
Emily Crow, Kate Hancock, Cara Marcous,  
Rick Meese, Alice Moss, Kevin Roach

## SUPERNOVAE

Arthur Dantchik  
Heidi Ettinger  
Wendy Ettinger & Derek McLane  
Patrice & Louis Friedman  
Cathy & Stephen Graham  
Jenny Wiener, Mosaic Entertainment  
Jeffrey Yass

## RED GIANT TABLES

Tom Cruise  
The Dawkins Family Foundation  
Angelina Fiordellisi & Matt Williams  
Fred Nelson, Entertainment Weekly  
The New World Foundation  
Jeremy M. Posner

## INTERPLANETARY TABLES

Blaise R. Box/Staging & Design, Inc.  
Rachel Chanoff  
Comedy Central  
Robert Goldberg, Yorke Construction  
Jane Perlmutter & Greg MacPherson  
Maury Schott  
Laura Valeroso & David Seidman  
Alexandra & John Vassilaros

## FIRST OFFICERS

Lisa Finstrom & Tim Sanford  
Terry Fitzpatrick & Stephen Perepeluk  
Alexa L. Fogel  
Frank Frattaroli  
Michael Greif & Jonathan Fried  
Jane & Jonathan Heine  
Julia Johns  
Maurice Kanbar  
Dana Kellin & Paul McCrane  
Kate Lear & Jonathan LaPook  
John S. Lyons  
Jesse L. Martin  
Audrey & Danny Meyer  
Janet Momjian & Steve Olsen  
Jane Musky & Tony Goldwyn  
Anita & David Rogerson  
Elaine & Aaron Shapiro, Shapiro & Lobel LLP  
Jonathan Sheffer  
Brian Swardstrom  
Drs. Mildred & B.W. Walton  
Anita Waxman  
Joanne Woodward & Paul Newman  
Mary Lin & Jim Yoshimura



## COSMNAUTS

Ben Barenholtz  
Lisa Benavides & Tim Nelson  
Elizabeth & Alexander Bernstein  
André Bishop & Peter Manning  
Susan Bruce & Peter Hedges  
Kate Burton & Michael Ritchie  
Colleen Carroll & Mitchell Semel  
Glenda Chesshir  
Cynthia & Jerome Congress  
Maddie Corman & Jace Alexander  
Barbara Ettinger & Sven Huseby  
Victor Garber  
Jilian Cahan Gersten  
Lisa J. Gugenheim  
Cherry Jones & Mary O'Connor  
Linda LeRoy Janklow  
Traci Paige Johnson & Bob Mowen  
George Kaiser Family Foundation

Judy Kuhn & David Schwab  
Susan & Richard Lobel  
Margo Lion  
Adrienne Lobel & Mark Linn-Baker  
Ali Marsh & Fred Weller  
Dr. Mark Nesselson & Elliot Rosenblum  
Shevi & Tom Peters  
Sue Ochs Phillips  
Leslie & Dean Potashner  
Christopher Randolph  
Theresa Rebeck & Jess Lynn  
Daryl Roth  
Steve Sabba  
Laura Sametz  
Lynn Street & Donald Margulies  
Susanna Styron & Darrell Larson  
Daniel Swee

## ROCKETMEN AND ROCKETWOMEN

Beth & Ray Abbott  
Amy Aquino & Drew McCoy  
June Ballinger & Michael Goldstein  
Talia Balsam & John Slattery  
Benny Bartley  
Stephanie Berger & Paul King  
Stephen Bernstein  
Dan Berrett  
Colleen Berry  
Vicky Bijur & Ed Levine  
Tessa Blake & Neal Lerner  
Audrey Bloch  
Jane Bodle & Mitchell Lemsky  
Jane Bolster & Steve Wertimer  
Kathy Briggs  
Becky Browder & Ted Neustadt  
Denise Burse & Peter Jay Fernandez  
Lea Carpenter  
Isabel Charles  
Kathleen Clark & Richard Frankel  
David Copeland  
Margaret Crimmins & Vytas Nagisetty  
Anna Crouse  
Cathy & George Crow  
Saula Cutter & Jan Wilson  
Nadia Dajani  
Rebecca & Richard Dresser  
Dianne Dreyer  
Moirra Driscoll & David Pence  
Anthony Dub  
C.C. Dyer  
Karen & Christopher Eddowes  
Alon Egozi  
Mario Egozi  
Ned Eisenberg  
Billy Finnegan  
Ellie Freudenheim & Daniel Wiener  
Geraldine Frey  
Doreen Frumkin  
Rose Gasner & Larry Chertoff  
Kevin Geer  
Jenny Gersten & Willie Reale  
Ileen Getz & Mark Grinnell

Kilty & Lloyd Gilmour  
Bryan Gmitter  
Judy Goldman & Michael Pillinger  
Wendy Goldman  
Robyn Goodman  
Connie Grappo & Lee Wilkof  
Mary Grieco  
Flavia & Edward Grimm  
Amanda Guinzburg  
Marianne Hagan  
Evan Handler  
Elizabeth & David Herdrich  
Lieta Hesen-Cohn & Richard Cohn  
John Benjamin Hickey  
Katherine Homans & Patterson Sims  
Caroline Hon  
Michelle Hurst  
Amy Introcaso-Davis  
Virginia & Richard Irwin  
Dana Ivey  
Latanya & Samuel L. Jackson Foundation  
Joanne Jacobson  
Macon & Michael Jessop  
Amanda Johns  
Julia Judge  
Marcella & Max Kahn  
Jay Kane  
Eric Karpeles & Mike Sell  
Mark Keoppen  
Al Klingenstein  
Mary Kong  
Christine Kromer  
Renée Landau  
Jill Larson  
Howard Leifman  
Liza Lerner  
Jane Lew  
Joshua Lewis  
Line Lillevik & James Waterston  
Jessica Lissy  
Chip Loutrel  
Brigid McCarthy  
Betsy McClelland & Chia Messina

Edelen McWilliams  
Anne Meara & Jerry Stiller  
Janis & Alan Menken  
Dean Michaels  
Beth & Ross Moore  
Bob Morris  
Meg Mortimer  
Suzen Murakoshi  
Patricia Murphy & Adam Spilka  
Beth & Tim Murtha  
Eileen Nash  
Heather Nash  
Rona & Randy Nelson  
Margaret Norden & Joseph Gazdak  
Ellen Novack  
Ricarda O'Conner  
Steven O'Neill  
Jacki Ochs & Jan Kroeze  
Kimberly Ochs  
Maria & Paul Onderdonk  
Jeff Otis  
Juli Pari-Frankel & Eric Frankel  
Paris Chocolate  
Stacie & Alyson Passon Shapero  
Jodi Peikoff  
Margot & Steve Peters  
Lindsay Porter  
Michael Potts  
Roger Raines  
Anthony Rapp  
Lucy Retan & Tom Sapien  
Loree Rodkin  
Janice & Daniel Rous  
Mary Anne Rubacky  
Richard Rubinstein  
Josh Safran  
Zeborah Schachtel  
Stacey Schaffer & Eric Schwartz

Karin & Thomas Schall  
Beth Schneider & Steve McFarland  
Whitney Scott & Peter Jacobson  
Stefan Selig  
Robert Shaffron & John Steber  
Sylvia Shepard & Willy Holtzman  
Connie Shulman & Reed Birney  
Meg Simon  
Landon Slane  
Lois Smith  
Abigail Rose Solomon  
Ivy & David Solowiejczyk  
Dorothy Spears & Vance Brown  
Frank Sposato  
Don Summa  
Mary Lou Teel & Peter Freundlich  
Edith Thurber & Kevin O'Rourke  
Anne Torsiglieri  
Patricia Triana  
Karen Trott & Peter Herdrich  
Maria Tucci & Robert Gottlieb  
Liz Tuccillo  
Christine Vachon  
Joyce Van Patten  
Cynthia Vance  
John Vassallo  
Joanna Vicente & Jason Kliot  
William Voelkel  
Jon Patrick Walker  
Mary Pat Walsh  
Carol J. Whitesides  
Elizabeth Williams & Joseph Forte  
Hannah & John Wiltshire  
Sarah Winkler & Simon Leopold  
Kurt Wottan  
Joey Xanders  
Vincent Yen  
Yildiz Yuksek & Richard Blackstone

List current as of 5/2/01



## THE 52ND STREET PROJECT STAFF

Gus Rogerson, Artistic Director  
Carol Ochs, Executive Director  
Michael Bernard, Associate Artistic Director  
John Sheehy, Director of Development and Marketing  
George Babiak, Production Manager and Helmsman  
Julie Feldman-Abe, Director of Education  
Megan Sandberg-Zakian, Volunteer Coordinator  
Liz Bell, Jennifer Boring, Emily Crow, Kate Hancock; Interns

## BENEFIT VOLUNTEERS

Heather Carnduff-Gobbée, Betsy Foldes, Rocio Galarza,  
Eris Migliorini, Doug Nervik, Jenny Peek

## SPECIAL THANKS

Mona Arriola, Jenny Gersten, Bryan Gmitter, Allison Kyle,  
Barbara McCrane, Christopher Randolph, Laura Sametz,  
Kim Sherman, Vanessa Valdes, Elizabeth Williams, Dan Wojner

Gus Rogerson, Artistic Director

Carol Ochs, Executive Director

The 52nd Street Project Presents



The 52nd Street Project

The 52nd Street Project is dedicated to the creation and production of new plays for, and often by, kids between the ages of ten and eighteen who reside in the Hell's Kitchen neighborhood in New York City. The Project does this through a unique mentoring program that matches kids with professional (and volunteer!) theater artists.

The Project is about making children proud of themselves. The Project is not about teaching children to act, although they will learn to. It is not about teaching them to write plays, although they will learn that as well. What it is about is giving a kid an experience of success. It is about giving a kid an opportunity to prove that he or she has something of value to offer, something that comes from within that he or she alone possesses, something that cannot be taken away.

The Project's Teen Ensemble is the final step in the kids' training: a two-year acting class that culminates in the production of a full-length play by William Shakespeare, the very one you are seeing tonight. We are very grateful to our gracious British hosts for enabling this tour.

*The following foundations and government agencies have generously supported the Teen Program through their contributions:*

**City of New York Department of Cultural Affairs  
Dammann Foundation  
Department of Youth and Community Development  
National Endowment for the Arts  
New York State Council on the Arts  
The Surdna Foundation**

# THE TEMPEST

By William Shakespeare

The 2001 British/American Tour

Directed by Greg Allen

Adapted by Chris Ceraso and  
The 52nd Street Project  
Teen Ensemble

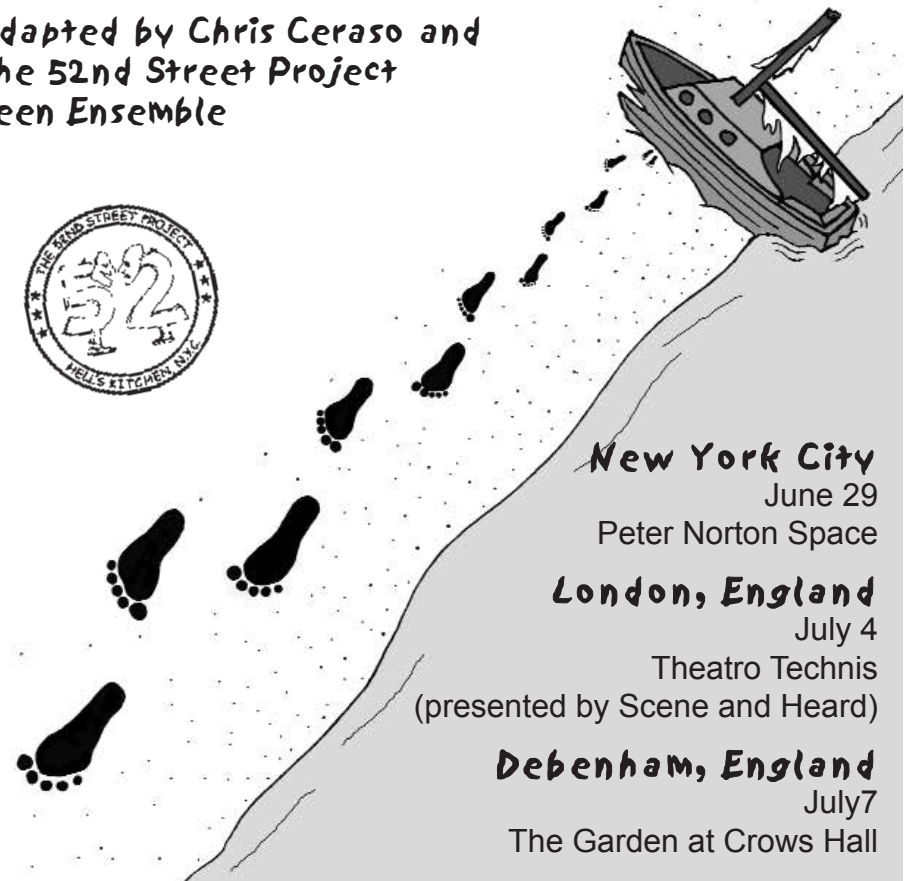

**New York City**

June 29

Peter Norton Space

**London, England**

July 4

Theatro Technis

(presented by Scene and Heard)

**Debenham, England**

July 7

The Garden at Crows Hall

## The Story of The Tempest

Prospero, a sorcerer and the rightful Duke of Milan, dwells on an enchanted isle with his daughter, Miranda. Twelve years earlier, the duke's sister, Antonia, and the King of Naples, Alonso, conspired to usurp Prospero's throne. Prospero and Miranda were set adrift in a boat, and they eventually found themselves marooned on the island. Prospero is served on his island by Ariel, a spirit whom he freed from a tree with magic, and Caliban, son of the witch Sycorax. When magic reveals that a ship bearing his old enemies is sailing near the island, Prospero summons a storm to wreck the ship. The survivors make it to shore in scattered groups. Among these is Ferdinand, the son of Alonso. He is lured to Prospero's abode by the singing of Ariel; there he meets Miranda, who is enthralled with the young prince.

Meanwhile, Antonia, Alonso, Sebastienne, and Gonzala wander the island in search of Ferdinand. Antonia now plots with Sebastienne to murder Alonso, but this plot is thwarted by Ariel. Elsewhere on the island, Stephano and Trincula encounter Caliban. After sharing a few drinks, Caliban tries to enlist the two in a plot to kill Prospero and rule the island himself. He even promises Miranda to Stephano. Ariel, however, reports all these goings-on to Prospero. In the meantime, Miranda and Ferdinand pledge their troth to each other.

Prospero isn't finished with his sport of Antonia and Alonso, either. He sends Ariel in the guise of a harpy to hound them for their crimes against him. Later, at a masque to celebrate the upcoming marriage of Miranda and Ferdinand, Prospero remembers Caliban's plot and abruptly calls the revels to a halt. He sends Ariel to punish Caliban, Trincula, and Stephano; the spirit does so by first luring them with some fancy clothes, then setting other island spirits upon them in the shape of hunting dogs that chase them around the island.

Finally, Prospero confronts his sister and Alonso, revealing his true identity as the rightful Duke of Milan. He demands that Antonia restore his throne; he also rebukes Sebastienne for plotting against her own brother. To Alonso, he reveals Ferdinand alive and well, playing a game with Miranda. As a final act, Prospero abandons his magic and releases Ariel and Caliban from their servitude. From Ariel, Prospero asks for one last boon: calm seas and favorable winds for their trip back to Naples.

*-adapted from J.M. Pressley, The Shakespeare Resource Center*

## The Cast

Alonso, King of Naples	Chris Ceraso
Sebastienne, his sister	Tessa John-Connor
Prospero, Duke of Milan	Larry Nathanson
Antonia, his sister, Duchess of Milan	Deshana Hamid
Ferdinand, son to the King of Naples	Alex Metzler
Gonzala, an honest Counsellor	Michaela Murphy
Caliban, a savage and deformed Slave	Thomas Santoni
Trincula, a Jester	Mary Vamvoukakis
Stephano, a Cook	Ahmed Attia
Miranda, daughter to Prospero	Judith Agosto
Ariel, an airy spirit	Sahara Walsh
Boatswain	Gus Rogerson
Mariners	Megan Sandberg-Zakian, Greg Allen, George Babiak
Nymphs and other spirits	The Company

Stage Manager: George Babiak

Costume Design: Sarah Iams

Choreography: Jeanne Simpson

For their help on the **New York** show, The 52nd Street Project would like to thank Michael Bernard, Cecilia Arana, Roz Coleman, Alex Draper, Catherine Mueller, Anne Torsilieri, Abigail Lopez, Susan McGinnis, Becky White, Jonathan Babicka, Pam Traynor, Paul Olmer, George Cortez, and The Signature Theatre. In **London**, we're grateful to Kate Coleman, Sophie Boyack and Scene and Heard, Ben Moor, Althea Stewart, Rachel Flint, Selina Boyack, and Vanessa Kastner. Finally, in **Debenham**, we are indebted to Oliver and Eleonora Knowland and Crows Hall, Mrs. Lennie Knowland, and John and Ann Knowland.

The 52nd Street Project gratefully acknowledges the support of the following foundations and corporations: Barker Welfare Foundation, The Bamsley Foundation, Blythmore Corporation, Capital Research Company, Carnegie Corporation of New York, Comedy Central, Consolidated Edison, The Dammann Fund, Deutsche Bank of Americas Foundation, The Dramatists Guild Fund, Eleanor, Dramatists Play Service, Adam & Mel Dubin Foundation, Doris Duke Charitable Foundation, The Educational Foundation of America, Entertainment Weekly, Ford Foundation, The Fan Fox & Leslie R. Samuels Foundation, The Horace W. Goldsmith Foundation, The Hennessy Foundation, Hudson Soenic Studio, Betty E. & George B. Kaiser Foundation, Rita J. and Stanley H. Kaplan Foundation, Lloyds TSB Bank plc, James A. Macdonald Foundation, Ann M. Martin Foundation, The Andrew W. Mellon Foundation, Helen Merrill, Ltd., J.P. Morgan Charitable Trust, The William Morris Agency, Mosaic Entertainment, The New World Foundation, The New York Times Company Foundation., Newman's Own, Paramount Pictures, Laura Pels Foundation, Staging and Design, Inc., Harold & Mimi Steinberg Charitable Trust, The Surdna Foundation, Susquehanna, Theater Communications Group, John A. Vassiliaros & Sons, Inc., The Vervane Foundation, West Bank Cafe, Yorke Construction Corporation. In addition the following individuals made gifts of over \$150 this year (list is current as of 7/25/01)

Anonymous	Terry Fitzpatrick & Liliانا Amador-Marty & Frank Marty	James Waterston & Line Lillevik	Donald Rothschild & Lottchen Shivers
Mark Lanow & Joanne Astrow	Alexa Fogel	Stephen Perepeluk	Kenneth Rothstein
Mary Bacon & Andrew Leynse	Katherine Foster	Jessica Lissy	Alexander Roy
June Ballinger & Michael Goldstein	David Frankel	Adrienne Lobel & Mark Linn Baker	Steve Sabba
Talia Balsam & John Slattery	Eric & Juli Frankel	Richard & Susan Lobel	Laura Sametz
Ben Barenholtz	Naomi Freundlich & Charles Miles	Charles Loutrell	Tim & Lisa Sanford
Benny Bartley	Louis & Patrice Friedman	Chris & Sally Lutz	Karin & Tom Schall
Jessica Bauman	Hank Gallo	John Lyons	Beth Schneider
Laurie Becker & Rick Sweren	Victor Garber	Marsue & Peter MacNicol	Maurly Schott
Gregory Bello	Beth Gardiner	Paul & Lauren Mandell	Marc Segan
Lisa Benavides & Tim Nelson	Rose Gasner & Larry Chertoff	Brian & Marsha Mannain	Stefan Selig
Barry & Myrna Bernard	Joseph & Margaret Gazdak	Elizabeth Manne	Jeffrey Soller & Joshua Lehrer
Brian Swardstrom & Bonnie Bernstein	Hillel & Celia Gershenson	Peter Manning & André Bishop	Alyson Shapero
Alexander & Elizabeth Bernstein	Alexandra Gersten & John A. Vassiliaros	Ali Marsh	Aaron & Elaine Shapiro
Stephen Bernstein	Willie Reale & Jenny Gersten	Jesse L. Martin	Jonathan Sheffer
Vicky Bijur & Ed Levine	Jilian Cahan Gersten	Dave & Alicia Matthews	William Holtzman & S. Sylvia Shepard
Jeanette & Samuel Black	Ileen Getz & Mark Grinnell	Drew McCoy & Amy Aquino	Reed Birney & Connie Shulman
Lewis Black	Nancy Giles	Paul Reale & Barbara McCrane	Meg Simon
Tessa Blake	Lloyd & Kilty Gilmour	Timothy Murtha & Elizabeth McDermott	Adam Felber & Jeanne Simpson
Mitchell Lemsky & Jane Bodle	Bob Glennon	Fran McDormand & Joel Coen	Phillip K. & Gloria W. Smith
Jane Bolster & Steve Wertimer	Judy Goldman & Michael Pillingier	Anne Meara & Jerry Stillier	Abigail Rose Solomon
Buzz Bovshow	Stephen & Cathy Graham	Alan & Janis Menken	Dr. David Solowiejczyk
Alan Braverman	Connie Grappo & Lee Wilkof	Chia Messina	John Steber & Robert Shaffron
Kathy Briggs	Michael Greif & Jonathan Fried	Audrey & Danny Meyer	James Neuberger & Helen Stambler
Becky Browder & Ted Neustadt	Mary Grieco	Dean Michaels	Jean Stein
Susan Bruce & Peter Hedges	Emily Grishman & Susan Sampliner	Ross & Beth Moore	Ben & Christine Stillier
Peter Jay Fernandez & Denise Burse	Lisa Gugenheim	John Morning	Abbot B. Stranahan
Kate Burton & Michael Ritchie	Evan Handler	Robin Morse & Gus Rogerson	Donald Margulies & Lynn Street
Cora Cahan & Bernard Gersten	Jane & Jonathan Heine	Patricia M. Murphy, Esq. & Adam Spilka	Susanna Styron & Darrell Larson
Mitchell Semel & Colleen Carroll	Amy Henkels	Tony Goldwyn & Jane Musky	Daniel Swee
Linda & Arthur Carter	David Herdrich & Elizabeth Palmer Herdrich	Geoffrey Nauffts	Mariko Tada
Rachel Chanoff	Peter Herdrich & Karen Trott	Randy & Rona Nelson	Jay & Rachel Tarses
Ellen Chenoweth	Lieta Hesen-Cohen & Richard Cohn	Rurth Nelson	Mary Lou Teel & Peter Freundlich
Glenda Chesshir	Caroline Hon	Mark Nesselson, M.D. & Elliott Rosenblum	Tracy Thorne & Edmund Lewis
Marissa & Travis Chibas	Michelle Hurst	Cynthia Nixon	Kevin O'Rourke & Edith Thurber
Richard Frankel & Kathleen Clark	Virginia & Richard Irwin	Steven O'Neill	Gina Torres
Jerome Cohen Congress	Sy Jacobs	Carol Ochs & Bruce MacVittie	Anne Torsiglieri
Jace Alexander & Maddie Corman	Whitney Scott & Peter Jacobson	Jacki Ochs & Jan Kroeze	Joan Vail & John Thorne
Max Mayer & Catherine Corpeny	Linda Janklow	Paul & Maria Onderdonk	Laura Valeroso & David Seidman
Margaret Crimmins	Macon R. & Michael B. Jessop	Greg MacPherson & Jane Perlmutter	Robert Abrams & Cynthia Vance
George & Cathy Crow	Tom Slaughter & Marthe Jocelyn	Steven & Margot Peter	Wendy vanden Heuvel & Brad Coley
Cameron Crowe	Amanda Johns	Bat-Sheva & Thomas Peters	John A. Vassallo
Stephen & Sandra Crudgington	Julia A. Johns	Peter & Ana Rosa Phillips	Borah & Mildred Walton
Tom Cruise	Andrea Johnson	Susan Ochs Phillips	Anita Waxman
Arthur Dantchik	Traci Paige Johnson & Robert Mowen	Oliver Platt & Camilla Campbell Platt	Sally & Lenny Weiss
Peter and Judith Dawkins	Cherry Jones & Mary O'Connor	Richard Polatchek	Daniel Wiener
Edward & Joanne DiRugeri	Larry & Mary Jones	Jeremy Posner	Jenny Wiener
Jon Divis & Gene Reilly	Maurice Kanbar	Dean & Leslie Potashner	Michael & Zena Wiener
Richard & Rebecca Dresser	Lisa A. Kauffman	Gigi Pritzker Pucker & Michael Pucker	Elizabeth Williams & Joseph Forte
Christopher & Karen Eddowes	Paul McCrane & Dana Kellin	Christopher Randolph	Jan Wilson & Saula Cutter
Mario Egozi	Seth & Beth Klarman	Peter & Helen Randolph	Donald Windham
David Eigenberg	Joana & Jason Kliot	Alysia Reiner & David Basche	Sarah Winkler & Simon Leopold
Ned Eisenberg	Mary Kong	Lucy E. Retan	John Woo
Sophia & Gordon Elliott	Judy Kuhn & David Schwab	Kate & Chris Robinson	Joanne Woodward & Paul Newman
Barbara Ettinger	Allan & Nanette Larson	Loree Rodkin	Jeffrey & Janine Yass
Barbara Ettinger & Sven Huseby	Kate Lear & Jonathan LaPook	David & Anita Rogerson	James & Mary Lin Yoshimura
Heidi Ettinger	Robert Sean Leonard	Clifford & Betsy Ross	Richard Blackstone & Yldez Yuksek
Wendy Ettinger & Derek McLane	Becky & Steven Lewis	Daryl Roth	Virginia Zakian & Robert Sandberg
Hannah Finn & John Wiltshire			Stuart Zicherman
Billy Finnegan			
Matt Williams & Angelina Fiordellisi			

The 52nd Street Project presents  
The 2001 Harold and Mimi Steinberg Charitable Trust One-on-Ones

# PUNS IN THE OVEN



JULY 26-29, 2001

## THE ENSEMBLE STUDIO THEATRE

549 WEST 52ND ST., NEW YORK CITY

# PUNS IN THE OVEN

## PLAYS ON WORDS

The 2001 Block Island  
One-on-Ones  
July 26-29  
The Ensemble Studio Theatre

### The 52nd Street Project Staff:

Gus Rogerson, Artistic Director  
Carol Ochs, Executive Director  
Michael Bernard, Associate Artistic Director  
John Sheehy, Director of Development and Marketing  
George "X-Acto" Babiak, Production Manager  
Julie Feldman, Director of Education  
Megan Sandberg-Zakian, Volunteer Coordinator  
Chris Ceraso, Teen Dean  
Liz Bell, Education Assistant  
Iris A. Brown, Graphic Designer  
Mayleen Cancel and Lorraine Zambrano, Receptionists  
Interns: Jonathan Babicka, Sarah Petersiel

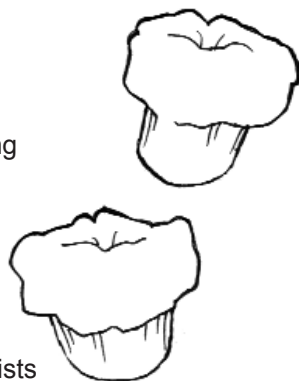

### Production Staff

**Composer:** Kim D. Sherman  
**Set Designer:** Kevin Joseph Roach  
**Lighting Designer:** Greg MacPherson  
**Costume Designer:** Erin Billings  
**Sound Designer:** Vanessa Valdes  
**Stage Manager:** Allison Kyle  
**Slide Design Team:**  
Kevin Coffey, Kim Snow, Iwona  
Waluk, Monty Nicol, Richard Hicks,  
Vickie Clarke, Katherine Lumb

### Prop Design Team:

Ceci Arana, George Babiak, Benny  
Bartley, Eileen Hecker, Alex and Ani  
Kehr, Scott and Stacey Linden, Mona  
Lipson, Kevin Roach, Abigail  
Ransmeier, Alison Rogers, John  
Sheehy, Frankie Ventura, Maja  
Wampuszyc

**"Puns" Illustration:** Mike Sell

### Furniture Crew:

Jonathan Babicka, Noel Polanco

### Prop Crew:

Sarah Petersiel, Mayleen Cancel,  
Mary Vamvoukakis,  
Johnathan "Big J" Roldan

### Load-in and Light-hang Crew:

Mona Arriola, Jonathan Babicka, Tim  
Gallagher, Nedra Gallegos, Allison  
Kyle, Rick Meese, Sarah Petersiel,  
Tom Schall

### House Managers:

Karin Schall, Liz Flahive

### Chefs:

Pat McQuade and Martha Velie-Gass

### Teen Counselor:

Mayleen Cancel



NATIONAL  
ENDOWMENT  
FOR THE ARTS

The One-on-One Program is made possible with public funds from the National Endowment for the Arts; The New York State Council on the Arts, a state agency; the Department of Youth and Community Development; and the New York City Department of Cultural Affairs Cultural Challenge Program. The 52nd Street Project is a member of Art/NY and a participant in the New Generations Program, funded by Doris Duke Charitable Foundation/The Andrew W. Mellon Foundation and administered by Theatre Communications Group, the national organization for the American Theater.

State of the Arts



NYSCA

## COOL STUFF ON SALE IN THE LOBBY!

The Fabulous Flyer Bar .....\$2.00 & \$1.50  
and featuring Shel Silverstein's "Fivey and Twoey" logo:  
Project T-shirts (NEW design) .....\$12.00  
Project Tank Tops .....\$12.00  
Project Caps (NEW design) .....\$15.00  
Project Mugs .....\$5.00  
Project Pencil 3-pack (now in RED!) .....\$1.00

Thank you for coming to **PUNS IN THE OVEN!** If you are not on our mailing list (or if your address has changed), please fill out this form and give it to us on your way out or mail it to the address below. We would also like to know if you are interested in becoming a volunteer. We need help in **all areas**, so be sure to fill out the entire form.

### PLEASE ADD ME TO YOUR MAILING LIST:

7/01

NAME: \_\_\_\_\_

ADDRESS: \_\_\_\_\_

ZIP \_\_\_\_\_

HOME PHONE: \_\_\_\_\_

DAYTIME PHONE: \_\_\_\_\_

E-MAIL ADDRESS: \_\_\_\_\_

MY OCCUPATION: \_\_\_\_\_

MY HOBBIES: \_\_\_\_\_

### YES, I WOULD LIKE TO BE OF HELP. I CAN:

- |   |   |  |
|---|---|--|
| <input type="checkbox"/> Help load in and out for shows | <input type="checkbox"/> Draw and/or paint  | <input type="checkbox"/> Help kids with homework |
| <input type="checkbox"/> Hang lights                    | <input type="checkbox"/> Help with mailings | <input type="checkbox"/> Teach kids a skill      |
| <input type="checkbox"/> Work on a backstage crew       | <input type="checkbox"/> Do office work     | <input type="checkbox"/> Be a chef at an event   |
| <input type="checkbox"/> Do graphic design              | <input type="checkbox"/> Design sound       | <input type="checkbox"/> Design and sew costumes |
| <input type="checkbox"/> Other (please specify) _____   |   |  |

### MY SCHEDULE IS:

- Very flexible. I'm often available during weekdays.  
 Somewhat flexible. I can help on the occasional morning or afternoon during the week.  
 Not very flexible at all, but I've got some free time on evenings and weekends.

If you would like to mail this (and you're always welcome to enclose a tax-deductible contribution), you can send it to: **The 52nd Street Project**, 500 West 52nd St., New York, NY 10019. Or fax it to (212) 333-5598.

## Don't Miss Our Upcoming Shows!

# PUNS IN THE OVEN "TOO"

The Tyler Hill, PA Batch of  
the 2001 One-on-Ones

August 23-26  
right here at E.S.T.

Same great theme, but with new  
kids, new adults, and all-new plays.



# PLAYBACK

November, 2001

First a kid writes a short play. Then, an adult writes an "answer" play. Then, the two of them perform both plays. Multiply this equation by seven and you've got an entire show.



December, 2001

In September, 10 kids brand-new to the Project will begin a Playmaking class taught by Project Playmaking Director Michael Bernard. Come and see their final plays performed by adult professional actors.

The 52nd Street Project is a non-profit organization that brings children from the Hell's Kitchen neighborhood together with professional theater artists to create original theater. **Puns In The Oven** is a production of our One-on-One program, which is designed to give children the opportunity to go away for one-week stays in the country and enjoy the undivided attention of a professional theater artist who serves as friend, mentor, and collaborator. The Project is delighted to return to the Ensemble Studio Theatre, where we have been performing since our inception in 1981. We gratefully acknowledge the fact that if E.S.T. wasn't here, we'd be nowhere.

### The 52nd Street Project Board of Directors

Ben Barenholtz

Lisa Benavides

Rachel Chanoff

Heidi Ettinger

Wendy Ettinger, *chair emeritus*

Louis P. Friedman

Stephen Graham

Larry Jones

James McDaniel

Frances McDormand, *chair*

Patricia M. Murphy, Esq.

Carol Ochs

Willie Reale

Gus Rogerson

José Soto, Jr.,

*alumni boardmember*

Pamala Tyson

Laura Valeroso

Wendy vanden Heuvel

Jenny Wiener

### Special Thanks

First of all, a hearty helping of gratitude to these folks for housing adults and kids: Pat McQuade & Martha Velie-Gass; Jane Muskey & Tony Goldwyn; Rita & Steve Draper, Jennifer & Elliot Taubman; Ron, Judy & Kevin Tierney; Virginia Dare, Joya Verde & Anthony; Josie Merck & Jim Stevenson. Sincere thanks to our chefs Pat McQuade & Martha Velie-Gass; our main house hosts Dr. Christina Biaggi & Pat Walsh; Lynn Reale, Kate, Ruth & Harold at Block Island Realty; Aldo's; Prudy & The Ice Cream Place for the free treats; Glenn & Annie Hall; McQuade's Market; Interstate Navigation; Bill Bendokis & New England Air; Robin Morse & Lucia May Rogerson; Bruce MacVittie & Sophia Ochs MacVittie; Wendy vanden Heuvel, Brad Coley & Lila Blue Coley; Greg MacPherson & Jane Perlmutter for the air excursions; Jenny Ritter; Amanda Gass; John & Joanne Warfel; Kirk Littlefield; and finally, Joe and Cam at Smuggler's Cove Sailing School.

### In-Kind Contributions

Curt, Jamie, Matt, Tim, and everyone at E.S.T. Neil A. Mazzella and Hudson Scenic Studios, the Murphy Law Office, Iris A. Brown, Ron Kastner and Capital Printing, Au'Some Candies, Big Apple Lights, Coleman, The Gap, Noggin, The Printing Store, Scholastic, Inc., Seagram's Chateau & Estate Wines, Shapiro & Lobel, Sesame Workshop, Watkins, Inc., Mayor's Office of Film & Television, Boylan's Bottling Co., David Sneddon & Fairway Market, Women's Interart, Andy Millon, Steve Olsen & The Westbank Cafe, Imaginary Studios, Robert Goldberg and Yorke Construction.



## PUNS IN THE OVEN - ACT I

All original music composed by Kim D. Sherman except where noted (\*)  
"Puns In The Oven Theme Song" lyrics by John L. Sheehy

### BETTY BOLD AND THE COOTIE CAPER

Written & Directed by Josh Lewis for Ani Kehr, age 11

Betty Bold ..... Ani Kehr  
Principal ..... Gus Rogerson  
Jerry/Weez/Randy ..... Josh Lewis  
Susie ..... Mayleen Cancel  
Other kids ..... Mary Vamvoukakis, Noel Polanco, Johnathan Roldan

*"Betty Bold"* music & lyrics by Josh Lewis

### THE JOKE'S ON YOU

Written & Directed by Priya Ayyar for Suzette Santana, age 10

Asia/Princess ..... Suzette Santana  
Coco/Maid ..... Priya Ayyar  
Peasants ..... Mayleen Cancel and Sarah Petersiel  
Announcer ..... John Sheehy

*"Right Under My Nose"* lyrics by Priya Ayyar and *"Tell A Joke"* lyrics by Priya Ayyar, music by Kim D. Sherman and Suzette Santana.

### GRAMMA LESSON

Written by Willie Reale. Directed by Willie Reale & Cecilia Arana for Octavia Rodriguez, age 10

Nonalita ..... Octavia Rodriguez  
Angie ..... Cecilia Arana

*"According To St. Anthony"* lyrics by Willie Reale

### I NEVER FANGED FOR MY FATHER

Written by Chris Regan. Directed by Godfrey L. Simmons, Jr. for Wonkezeh Newenle, age 12

Harry Wolf ..... Wonkezeh Newenle  
Howland Wolf ..... Godfrey L. Simmons, Jr.  
Mosquito Man ..... Josh Lewis  
Lycanthrope Singers ..... Sarah Petersiel, Mary Vamvoukakis

*"When the Moon is Full"* lyrics by Susannah Keagle

### THE MYSTERY OF THE SOBBING SISTER

By Theresa Rebeck. Directed by Susan McGinnis for Katherine Acosta, 11

Detective Maura Marino ..... Katherine Acosta  
Lola Pennymaker ..... Susan McGinnis  
Monster ..... Gus Rogerson

*"In the Dead of Night"* lyrics by Theresa Rebeck

👉 **Intermission!** 👈

## ACT II

### MOUNTAIN MAN

Written & Directed by Robert Sean Leonard for Jeremy Butler, age 10

Mountain Man ..... Jeremy Butler  
Clark ..... Robert Sean Leonard  
Mountain Men Chorus ..... MENERGY III

*\*\*"Sublime, the Mountain"* music & lyrics by Robert Sean Leonard, *"Solitude"* lyrics by Robert Sean Leonard

### JASMINE OF THE SQUARES

Written & Directed by Kim Sykes for Ariana Casablanca, age 11

Jasmine ..... Ariana Casablanca  
Jasmine's Mom/ Kathy ..... Kim Sykes  
Carlos ..... John Sheehy

*"I Like It"* lyrics by Kim Sykes; *"Without Math"* lyrics by John Sheehy

### WITCHES!

Written by Megan Sandberg-Zakian, Directed by Megan Sandberg-Zakian & Zabryna Guevara for Britney Castro, age 11

Margaret ..... Britney Castro  
Agnes ..... Zabryna Guevara  
Evil Mob ..... Mayleen Cancel, Noel Polanco,  
Mary Vamvoukakis, and Gus Rogerson

*"Witches!"* lyrics by Megan Sandberg-Zakian

### BOB THE DRAGON

Written by Joe Mihalow. Directed by Doug Lockwood for Alex Kehr, age 10

Bob ..... Alex Kehr  
Announcer ..... Sarah Petersiel  
Chet Rockman ..... Doug Lockwood  
Alfredo Duchamp ..... John Sheehy

*"The Game"* lyrics by John Sheehy & Joe Mihalow

### THE ANGEL ON EIGHTEEN WHEELS

Written & Directed by George Babiak for Frankie Ventura, age 11

Nevada Joe Farnsworth ..... Frankie Ventura  
Trooper Wayne Ledbetter ..... George Babiak  
Cookie ..... Sarah Petersiel  
Butch Rawlins ..... Noel Polanco  
Little Girl ..... Mayleen Cancel

*"Ballad of a Trucker"* lyrics by George Babiak

The 52nd Street Project gratefully acknowledges the support of the following foundations and corporations: Barker Welfare Foundation, The Bamsley Foundation, Blythmour Corporation, Capital Research Company, Carnegie Corporation of New York, Comedy Central, Consolidated Edison, The Dammann Fund, Deutsche Bank of Americas Foundation, The Dramatists Guild Fund, Eleanor, Dramatists Play Service, Adam & Mel Dubin Foundation, Doris Duke Charitable Foundation, The Educational Foundation of America, Entertainment Weekly, Ford Foundation, The Fan Fox & Leslie R. Samuels Foundation, The Horace W. Goldsmith Foundation, The Hennessy Foundation, Hudson Scenic Studio, Betty E. & George B. Kaiser Foundation, Rita J. and Stanley H. Kaplan Foundation, Lloyds TSB Bank plc, James A. Macdonald Foundation, Ann M. Martin Foundation, The Andrew W. Mellon Foundation, Helen Merrill, Ltd., J.P. Morgan Charitable Trust, The William Morris Agency, Mosaic Entertainment, The New World Foundation, The New York Times Company Foundation., Newman's Own, Paramount Pictures, Laura Pels Foundation, Staging and Design, Inc., Harold & Mimi Steinberg Charitable Trust, The Surdna Foundation, Susquehanna, Theater Communications Group, John A. Vassiliaros & Sons, Inc., The Vervane Foundation, West Bank Cafe, Yorke Construction Corporation. In addition the following individuals made gifts of ove \$150 this year (list is current as of 7/25/01)

Anonymous	Terry Fitzpatrick & Liliانا Amador-Marty & Frank Marty	James Waterston & Line Lillevik	Donald Rothschild & Margo Lion
Mark Lanow & Joanne Astrow	Alexa Fogel	Stephen Perepeluk	Lottchen Shivers
Mary Bacon & Andrew Leynse	Katherine Foster	Jessica Lissy	Kenneth Rothstein
June Ballinger & Michael Goldstein	David Frankel	Adrienne Lobel & Mark Linn Baker	Alexander Roy
Talia Balsam & John Slattery	Eric & Juli Frankel	Richard & Susan Lobel	Steve Sabba
Ben Barenholtz	Naomi Freundlich & Charles Miles	Charles Loutrell	Laura Sametz
Benny Bartley	Louis & Patrice Friedman	Chris & Sally Lutz	Tim & Lisa Sanford
Jessica Bauman	Hank Gallo	John Lyons	Karin & Tom Schall
Laurie Becker & Rick Sweren	Victor Garber	Marsue & Peter MacNicol	Beth Schneider
Gregory Bello	Beth Gardiner	Paul & Lauren Mandell	Maury Schott
Lisa Benavides & Tim Nelson	Rose Gasner & Larry Chertoff	Brian & Marsha Mannain	Marc Segan
Barry & Myrna Bernard	Joseph & Margaret Gazdak	Elizabeth Manne	Stefan Selig
Brian Swardstrom & Bonnie Bernstein	Hillel & Celia Gershenson	Peter Manning & André Bishop	Jeffrey Soper & Joshua Lehrer
Alexander & Elizabeth Bernstein	Alexandra Gersten & John A. Vassiliaros	Ali Marsh	Alyson Shapero
Stephen Bernstein	Willie Reale & Jenny Gersten	Jesse L. Martin	Aaron & Elaine Shapiro
Vicky Bijur & Ed Levine	Jilian Cahan Gersten	Dave & Alicia Matthews	Jonathan Sheffer
Jeanette & Samuel Black	Ileen Getz & Mark Grinnell	Drew McCoy & Amy Aquino	William Holtzman & S. Sylvia Shepard
Lewis Black	Nancy Giles	Paul Reale & Barbara McCrane	Reed Birney & Connie Shulman
Tessa Blake	Lloyd & Kilty Gilmour	Timothy Murtha & Elizabeth McDermott	Meg Simon
Mitchell Lemsky & Jane Bodle	Bob Glennon	Fran McDormand & Joel Coen	Adam Felber & Jeanne Simpson
Jane Bolster & Steve Wertimer	Judy Goldman & Michael Pillingier	Anne Meara & Jerry Stillier	Phillip K. & Gloria W. Smith
Buzz Bovshow	Stephen & Cathy Graham	Alan & Janis Menken	Abigail Rose Solomon
Alan Braverman	Connie Grappo & Lee Wilkof	Chia Messina	Dr. David Solowiejczyk
Kathy Briggs	Michael Greif & Jonathan Fried	Audrey & Danny Meyer	John Steber & Robert Shaffron
Becky Browder & Ted Neustadt	Mary Grieco	Dean Michaels	James Neuberger & Helen Stambler
Susan Bruce & Peter Hedges	Emily Grishman & Susan Sampliner	Ross & Beth Moore	Jean Stein
Peter Jay Fernandez & Denise Burse	Lisa Gugenheim	John Morning	Ben & Christine Stillier
Kate Burton & Michael Ritchie	Evan Handler	Robin Morse & Gus Rogerson	Abbot B. Stranahan
Cora Cahan & Bernard Gersten	Jane & Jonathan Heine	Patricia M. Murphy, Esq. & Adam Spilka	Donald Margulies & Lynn Street
Mitchell Semel & Colleen Carroll	Amy Henkels	Tony Goldwyn & Jane Musky	Susanna Styron & Darrell Larson
Linda & Arthur Carter	David Herdrich & Elizabeth Palmer Herdrich	Geoffrey Nauffts	Daniel Sweeney
Rachel Chanoff	Peter Herdrich & Karen Trott	Randy & Rona Nelson	Mariko Tada
Ellen Chenoweth	Lieta Hesen-Cohen & Richard Cohn	Rurth Nelson	Jay & Rachel Tarses
Glenda Chesshir	Caroline Hon	Mark Nesselson, M.D. & Elliott Rosenblum	Mary Lou Teel & Peter Freundlich
Marissa & Travis Chibas	Michelle Hurst	Cynthia Nixon	Tracy Thorne & Edmund Lewis
Richard Frankel & Kathleen Clark	Virginia & Richard Irwin	Steven O'Neill	Kevin O'Rourke & Edith Thurber
Jerome Cohen Congress	Sy Jacobs	Carol Ochs & Bruce MacVittie	Gina Torres
Jace Alexander & Maddie Corman	Whitney Scott & Peter Jacobson	Jacki Ochs & Jan Kroeze	Anne Torsiglieri
Max Mayer & Catherine Corpeny	Linda Janklow	Paul & Maria Onderdonk	Joan Vail & John Thorne
Margaret Crimmins	Macon R. & Michael B. Jessop	Greg MacPherson & Jane Perlmutter	Laura Valeroso & David Seidman
George & Cathy Crow	Tom Slaughter & Marthe Jocelyn	Steven & Margot Peter	Robert Abrams & Cynthia Vance
Cameron Crowe	Amanda Johns	Bat-Sheva & Thomas Peters	Wendy vanden Heuvel & Brad Coley
Stephen & Sandra Crudgington	Julia A. Johns	Peter & Ana Rosa Phillips	John A. Vassallo
Tom Cruise	Andrea Johnson	Susan Ochs Phillips	Borah & Mildred Walton
Arthur Dantchik	Traci Paige Johnson & Robert Mowen	Oliver Platt & Camilla Campbell Platt	Anita Waxman
Peter and Judith Dawkins	Cherry Jones & Mary O'Connor	Richard Polatchek	Sally & Lenny Weiss
Edward & Joanne DiRugeri	Larry & Mary Jones	Jeremy Posner	Daniel Wiener
Jon Divis & Gene Reilly	Maurice Kanbar	Dean & Leslie Potashner	Jenny Wiener
Richard & Rebecca Dresser	Lisa A. Kauffman	Gigi Pritzker Pucker & Michael Pucker	Michael & Zena Wiener
Christopher & Karen Eddowes	Paul McCrane & Dana Kellin	Christopher Randolph	Elizabeth Williams & Joseph Forte
Mario Egozi	Seth & Beth Klarman	Peter & Helen Randolph	Jan Wilson & Saula Cutter
David Eigenberg	Joana & Jason Kliot	Alysia Reiner & David Basche	Donald Windham
Ned Eisenberg	Mary Kong	Lucy E. Retan	Sarah Winkler & Simon Leopold
Sophia & Gordon Elliott	Judy Kuhn & David Schwab	Kate & Chris Robinson	John Woo
Barbara Ettinger	Allan & Nanette Larson	Loree Rodkin	Joanne Woodward & Paul Newman
Barbara Ettinger & Sven Huseby	Kate Lear & Jonathan LaPook	David & Anita Rogerson	Jeffrey & Janine Yass
Heidi Ettinger	Robert Sean Leonard	Clifford & Betsy Ross	James & Mary Lin Yoshimura
Wendy Ettinger & Derek McLane	Becky & Steven Lewis	Daryl Roth	Richard Blackstone & Yldez Yuksek
Hannah Finn & John Wiltshire			Virginia Zakian & Robert Sandberg
Billy Finnegan			Stuart Zicherman
Matt Williams & Angelina Fiordellisi			

The 52nd Street Project presents The Wiener Family Foundation One-on-Ones

# PUNS IN THE OVEN "TOO"



AUGUST 23-26, 2001

## THE ENSEMBLE STUDIO THEATRE

549 WEST 52ND ST., NEW YORK CITY

# PUNS IN THE OVEN

## PLAYS ON WORDS

The 2001 Tyler Hill  
One-on-Ones  
August 23-26  
The Ensemble Studio Theatre

### The 52nd Street Project Staff:

Gus Rogerson, Artistic Director  
Carol Ochs, Executive Director  
Michael Bernard, Associate Artistic Director  
John Sheehy, Director of Development and Marketing  
George "X-Acto" Babiak, Production Manager  
Julie Feldman, Director of Education  
Megan Sandberg-Zakian, Volunteer Coordinator  
Chris Ceraso, Teen Dean  
Liz Bell, Education Assistant  
Iris A. Brown, Graphic Designer  
Mayleen Cancel and Lorraine Zambrano, Receptionists  
Sarah Petersiel, Intern

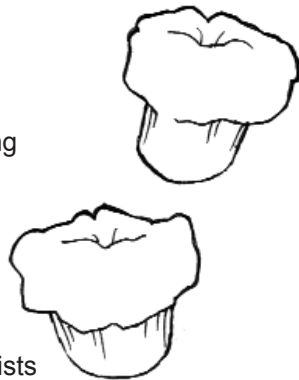

### Production Staff

#### Composer:

Kim D. Sherman

#### Music Director:

David Gaines

#### Set Designer:

Kevin Joseph Roach

#### Lighting Designer:

Greg MacPherson

#### Costume Designer:

Crystal Thompson

#### Sound Designer: Maury Schott

#### Stage Manager:

Elissa Errick

#### Slide Designer:

Mike Sell

#### "Puns" Illustration:

Mike Sell

#### Prop Design Team:

George Babiak, Elissa Errick,  
Julie Gold, Ivana Granados,  
Sarah Petersiel, Shirley Rumierk,  
John Sheehy

#### Furniture Crew:

Rick Meese and Alex Metzler

#### Prop Crew:

Judy Agosto, Wonkezeh  
Newenle, Sarah Petersiel,

#### Load-in Crew:

Elissa Errick, Amy Johnston,  
Sarah Petersiel

#### House Managers:

Karin Schall, Liz Flahive

#### Chef: Eric Karpeles

#### Proj Grad Counselor: Diana Rojas



NATIONAL  
ENDOWMENT  
FOR THE ARTS

The One-on-One Program is made possible with public funds from the National Endowment for the Arts; The New York State Council on the Arts, a state agency; the Department of Youth and Community Development; and the New York City Department of Cultural Affairs Cultural Challenge Program. The 52nd Street Project is a member of Art/NY and a participant in the New Generations Program, funded by Doris Duke Charitable Foundation/The Andrew W. Mellon Foundation and administered by Theatre Communications Group, the national organization for the American Theater.

State of the Arts



NYSCA

## COOL STUFF ON SALE IN THE LOBBY!

The Fabulous Flyer Bar .....\$2.00 & \$1.50  
and featuring Shel Silverstein's "Fivey and Twoey" logo:  
Project T-shirts (NEW design) .....\$12.00  
Project Tank Tops .....\$12.00  
Project Caps (NEW design) .....\$15.00  
Project Mugs .....\$5.00  
Project Pencil 3-pack (now in RED!) .....\$1.00

Thank you for coming to **PUNS IN THE OVEN!** If you are not on our mailing list (or if your address has changed), please fill out this form and give it to us on your way out or mail it to the address below. We would also like to know if you are interested in becoming a volunteer. We need help in **all areas**, so be sure to fill out the entire form.

### PLEASE ADD ME TO YOUR MAILING LIST:

8/01

NAME: \_\_\_\_\_

ADDRESS: \_\_\_\_\_

ZIP \_\_\_\_\_

HOME PHONE: \_\_\_\_\_

DAYTIME PHONE: \_\_\_\_\_

E-MAIL ADDRESS: \_\_\_\_\_

MY OCCUPATION: \_\_\_\_\_

MY HOBBIES: \_\_\_\_\_

### YES, I WOULD LIKE TO BE OF HELP. I CAN:

- |   |   |  |
|---|---|--|
| <input type="checkbox"/> Help load in and out for shows | <input type="checkbox"/> Draw and/or paint  | <input type="checkbox"/> Help kids with homework |
| <input type="checkbox"/> Hang lights                    | <input type="checkbox"/> Help with mailings | <input type="checkbox"/> Teach kids a skill      |
| <input type="checkbox"/> Work on a backstage crew       | <input type="checkbox"/> Do office work     | <input type="checkbox"/> Be a chef at an event   |
| <input type="checkbox"/> Do graphic design              | <input type="checkbox"/> Design sound       | <input type="checkbox"/> Design and sew costumes |
| <input type="checkbox"/> Other (please specify) _____   |   |  |

### MY SCHEDULE IS:

- Very flexible. I'm often available during weekdays.  
 Somewhat flexible. I can help on the occasional morning or afternoon during the week.  
 Not very flexible at all, but I've got some free time on evenings and weekends.

If you would like to mail this (and you're always welcome to enclose a tax-deductible contribution), you can send it to: **The 52nd Street Project**, 500 West 52nd St., New York, NY 10019. Or fax it to (212) 333-5598.

## Don't Miss Our Upcoming Shows!

👂 **PLAYBACK 2001** 👂

# Wha' Happen?

PLAYS WITH TWO

SIDES

November, 2001

First a kid writes a short play. Then, an adult writes an "answer" play. Then, the two of them perform both plays. Multiply this equation by seven and you've got an entire

# FORK IN THE ROAD

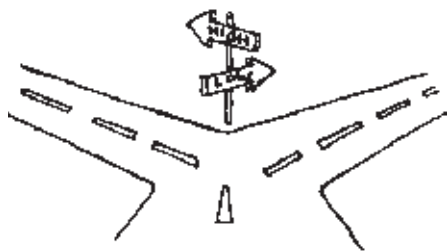

**10 CHOICE PLAYS**

December,  
2001

In September, 10 kids brand-new to the Project will begin a Playmaking class taught by Project Playmaking Director Michael Bernard. Come and see their final plays performed by adult professional actors.

The 52nd Street Project is a non-profit organization that brings children from the Hell's Kitchen neighborhood together with professional theater artists to create original theater. **Puns In The Oven** is a production of our One-on-One program, which is designed to give children the opportunity to go away for one-week stays in the country and enjoy the undivided attention of a professional theater artist who serves as friend, mentor, and collaborator. The Project is delighted to return to the Ensemble Studio Theatre, where we have been performing since our inception in 1981. We gratefully acknowledge the fact that if E.S.T. wasn't here, we'd be nowhere.

### The 52nd Street Project Board of Directors

Ben Barenholtz	Patricia M. Murphy, Esq.
Lisa Benavides	Carol Ochs
Rachel Chanoff	Willie Reale
Heidi Ettinger	Gus Rogerson
Wendy Ettinger, <i>chair emeritus</i>	José Soto, Jr., <i>alumni boardmember</i>
Louis P. Friedman	Pamala Tyson
Stephen Graham	Laura Valeroso
Larry Jones	Wendy vanden Heuvel
James McDaniel	Jenny Wiener
Frances McDormand, <i>chair</i>	

### Special Thanks

Our trip to Pennsylvania wouldn't have been possible if it weren't for our stalwart host families, who put up both kids and adults at their homes. Thanks go to Linda, Bill & Sean Cobb; Linda, Bill & Daniel Halvorsen; Andrea, Chuck, Melanie & Emma Heyn; Deborah, David, Imogen, Benita & Sam Pursch; Frank & Pat Stoeckle; Sally & Lenny Weiss; Debbie, Frosty & Rio Myers; Richard Grunn & Tasha Williams; Katie Homans & Patterson Sims & Mardette & Lally ; & Pete Snyder & Cathy Dodge.

Sincere thanks to Wendy Townsend and Mark Keoppen, Martha Sader; David Sneddon & Steve Jenkins and The Fairway Market, Vanessa Valdes & Marcia Dunsmore. Extra-special thanks to our amazing hosts Mike Sell & Eric Karpeles (and Walter the Cat, too.)

### In-Kind Contributions

Curt, Jamie, Matt, Tim, and everyone at E.S.T. Neil A. Mazzella and Hudson Scenic Studios, the Murphy Law Office, Iris A. Brown, Ron Kastner and Capital Printing, Au'Some Candies, Big Apple Lights, Coleman, The Gap, Noggin, The Printing Store, Scholastic, Inc., Seagram's Chateau & Estate Wines, Shapiro & Lobel, Sesame Workshop, Watkins, Inc., Mayor's Office of Film & Television, Boylan's Bottling Co., David Sneddon & Fairway Market, Women's Interart, Andy Millon, Steve Olsen & The Westbank Cafe, Imaginary Studios, Robert Goldberg and Yorke Construction.

## PUNS IN THE OVEN, TOO - ACT I

All original music composed by Kim D. Sherman except where noted (\*)  
"Puns In The Oven Theme Song" lyrics by John L. Sheehy

### A COD PIECE

written by Jackie Reingold & directed by Jackie Reingold & Lisa Leguillo for Marilyn Sanchez, age 12

Ima Cod .....Marilyn Sanchez  
Bea A. Starfish .....Lisa Leguillo  
Lobster Mobster .....Ed Vassallo  
Mussel Man .....Wonkezeh Newenle, Mike Sell (8/23 only)

"Sad to Be a Cod Song" & "Happy to Be a Cod Song" lyrics by Jackie Reingold

### END OF THE LINE

written by Gus Rogerson & directed by Catherine Mueller for Anthony Mejia, age 11

Red Green .....Anthony Mejia  
Eunice/Paleontologist/Woman .....Catherine Mueller  
Thirsty woman .....Judy Agosto

"Red's Big Problem" lyrics by Gus Rogerson

### SHOWDOWN IN SEVILLA

written & directed by Matt Saldívar for Berto Rodriguez, age 12

Benjamin .....Berto Rodriguez  
Julio .....Matt Saldívar  
Beatrice .....Sarah Petersiel  
Pancakes .....Michael Potts  
Desperados .....Male Company

"Cielito Lindo" \*traditional

### ONE TOUGH COOKIE CRUMBLES

written by John Sheehy & directed by Denise Burse for Lizette Natera, age 13

Ella .....Lizette Natera  
Madam Borgia .....Denise Burse

"Just Dessert" lyrics by John Sheehy

### BOLT

written by Dan Berrett & directed by Michael Potts for Stephen Galimidi, 11

Bolt .....Stephen Galimidi  
Parker/Announcer .....Michael Potts  
Racehorses .....The backstage crew

"In the World Out There," lyrics by Dan Berrett

☞ **Intermission!** ☜

## ACT II

### A SHAGGY FLY STORY

written by Tim Blake Nelson & directed by Ed Vassallo for Jonathan Hagemeyer, age 13

Spivey .....Jonathan Hagemeyer  
Flem .....Ed Vassallo  
Judge .....Peter Jay Fernandez  
Court officer .....Alex Metzler

"My Best Friend," & "Sing-a-Long" lyrics by Tim Blake Nelson

### SLASHDANCE

written & directed by Adam Felber for Ivana Granados, age 11

Nicole .....Ivana Granados  
Cindy .....Jeanne Simpson  
Big Steve/Cactus .....John Sheehy

"We Can Dance," lyrics by Adam Felber, Beatbox by Ed Vassallo & Justin Aponte

### MELLOW DRAMA

written by Willie Reale & directed by Peter Jay Fernandez for Leah Galimidi, age 13

Widow Bizby .....Leah Galimidi  
Mr. Lechermiser/Leopold .....Peter Jay Fernandez

"Woe Is Me" & "Whoa, Not A Clown" lyrics by Willie Reale

### TAKING THE CAKE

written & directed by Anne Torsiglieri for Wendy Rivera, age 13

Lulu .....Wendy Rivera  
Ethel .....Anne Torsiglieri  
Doctor .....Michael Bernard

"I Bake" & "Cooking Lesson" lyrics by Anne Torsiglieri

### CONJOINED TWIN PRISON BREAK

written & directed by Michael Bernard for Justin Aponte, age 13

Schmill .....Justin Aponte  
Bill .....Michael Bernard  
Prison Guard .....Alex Metzler

"Sometimes" lyrics by Michael Bernard



The 52nd Street Project gratefully acknowledges the support of the following foundations and corporations: Barker Welfare Foundation, The Bamsley Foundation, Blythmour Corporation, Capital Research Company, Carnegie Corporation of New York, Comedy Central, Consolidated Edison, The Dammann Fund, Deutsche Bank of Americas Foundation, The Dramatists Guild Fund, Eleanor, Dramatists Play Service, Adam & Mel Dubin Foundation, Doris Duke Charitable Foundation, The Educational Foundation of America, Entertainment Weekly, Ford Foundation, The Fan Fox & Leslie R. Samuels Foundation, The Horace W. Goldsmith Foundation, The Hennessy Foundation, Holland Lodge Foundation, Hudson Scenic Studio, Betty E. & George B. Kaiser Foundation, Rita J. and Stanley H. Kaplan Foundation, Lloyds TSB Bank plc, James A. Macdonald Foundation, Ann M. Martin Foundation, The Andrew W. Mellon Foundation, Helen Merrill, Ltd., J.P. Morgan Charitable Trust, The William Morris Agency, Mosaic Entertainment, The New World Foundation, The New York Times Company Foundation, Newman's Own, Paramount Pictures, Laura Pels Foundation, Roulette Entertainment Staging and Design, Inc., Harold & Mimi Steinberg Charitable Trust, The Surdna Foundation, Susquehanna, Theater Communications Group, John A. Vassiliaros & Sons, Inc., The Vervane Foundation, West Bank Cafe, Yorke Construction Corporation. In addition the following individuals made gifts of over \$150 this year (list is current as of 10/30/01)

- |                                      |  |  |                                      |
|--------------------------------------|--|--|--------------------------------------|
| Anonymous                            | Terry Fitzpatrick & Stephen Perrepelek     | Becky & Steven Lewis                     | Loree Rodkin                         |
| Liliana Amador-Marty & Frank Marty   | Stephen Perrepelek                         | James Waterston & Line Lillevik          | David & Anita Rogerson               |
| Mark Lanow & Joanne Astrow           | Alexa Fogel                                | Margo Lion                               | Clifford & Betsy Ross                |
| Mary Bacon & Andrew Leynse           | Katherine Foster                           | Jessica Lissy                            | Daryl Roth                           |
| June Ballinger & Michael Goldstein   | David Frankel                              | Adrienne Lobel & Mark Linn Baker         | Donald Rothschild & Lottchen Shivers |
| Talia Balsam & John Slattery         | Eric & Juli Frankel                        | Richard & Susan Lobel                    | Kenneth Rothstein                    |
| Ben Barenholtz                       | Naomi Freundlich & Charles Miles           | Charles Loutrell                         | Alexander Roy                        |
| Benny Bartley                        | Louis & Patrice Friedman                   | Chris & Sally Lutza                      | Steve Sabba                          |
| Jessica Bauman                       | Hank Gallo                                 | John Lyons                               | Laura Sameletz                       |
| Laurie Becker & Rick Sweren          | Victor Garber                              | Marsue & Peter MacNicol                  | Tim & Lisa Sanford                   |
| Gregory Bello                        | Beth Gardiner                              | Paul & Lauren Mandell                    | Karin & Tom Schall                   |
| Lisa Benavides & Tim Nelson          | Rose Gasner & Larry Chertoff               | Brian & Marsha Mannain                   | Beth Schneider                       |
| Barry & Myrna Bernard                | Joseph & Margaret Gazdak                   | Elizabeth Manne                          | Maury Schott                         |
| Brian Swardstrom & Bonnie Bernstein  | Jonathan Gazdak                            | Peter Manning & André Bishop             | Marc Segan                           |
| Alexander & Elizabeth Bernstein      | Hillel & Celia Gershenson                  | Richard P. Martin                        | Stefan Selig                         |
| Stephen Bernstein                    | Alexandra Gersten & John A. Vassilaros     | Ali Marsh                                | Jeffrey Sella & Joshua Lehrer        |
| Vicky Bijur & Ed Levine              | Willie Reale & Jenny Gersten               | Jesse L. Martin                          | Alyson Shapero                       |
| Jeanette & Samuel Black              | Jillian Cahan Gersten                      | Dave & Alicia Matthews                   | Aaron & Elaine Shapiro               |
| Lewis Black                          | Ileen Getz & Mark Grinnell                 | Drew McCoy & Amy Aquino                  | Bernice Baruch Shawl                 |
| Tessa Blake                          | Nancy Giles                                | Paul Reale & Barbara McCrane             | Jonathan Sheffer                     |
| Mitchell Lemsky & Jane Bodle         | Lloyd & Kilty Gilmour                      | Timothy Murtha & Elizabeth McDermott     | William Holtzman & S. Sylvia Shepard |
| Jane Bolster & Steve Wertimer        | Bob Glennon                                | Fran McDormand & Joel Coen               | Reed Birney & Connie Shulman         |
| Buzz Bovshow                         | Judy Goldman & Michael Pillingier          | Anne Meara & Jerry Stiller               | Meg Simon                            |
| Alan Braverman                       | Fredrick & Nancy Goldman                   | Alan & Janis Menken                      | Adam Felber & Jeanne Simpson         |
| Kathy Briggs                         | Stephen & Cathy Graham                     | Chia Messina                             | Phillip K. & Gloria W. Smith         |
| Becky Browder & Ted Neustadt         | Connie Grappo & Lee Wilkof                 | Audrey & Danny Meyer                     | Abigail Rose Solomon                 |
| Susan Bruce & Peter Hedges           | Michael Greif & Jonathan Fried             | Dean Michaels                            | Dr. David Solowiejczyk               |
| Peter Jay Fernandez & Denise Burse   | Mary Grieco                                | Janet Mornjian & Steve Olsen             | John Steber & Robert Shaffron        |
| Kate Burton & Michael Ritchie        | Emily Grishman & Susan Sampliner           | Ross & Beth Moore                        | James Neuberger & Helen Stambler     |
| Cora Cahan & Bernard Gersten         | Lisa Gugenheim                             | John Morning                             | Jean Stein                           |
| Mitchell Semel & Colleen Carroll     | Evan Handler                               | Alfred Morris                            | Ben & Christine Stiller              |
| Linda & Arthur Carter                | Lynn Harris                                | Robin Morse & Gus Rogerson               | Abbot B. Stranahan                   |
| Rachel Chanoff                       | Jane & Jonathan Heine                      | Patricia M. Murphy, Esq. & Adam Spilka   | Donald Margulies & Lynn Street       |
| Ellen Chenoweth                      | Amy Henkels                                | Tony Goldwyn & Jane Musky                | Susanna Styron & Darrell Larson      |
| Glenda Cheshir                       | David Herdrich & Elizabeth Palmer Herdrich | Geoffrey Nauffts                         | Daniel Swee                          |
| Marissa & Travis Chibas              | Peter Herdrich & Karen Trott               | Pam Nelson                               | Mariko Tada                          |
| Richard Frankel & Kathleen Clark     | Lieta Hesen-Cohen & Richard Cohn           | Randy & Rona Nelson                      | Jay & Rachel Tarses                  |
| Jerome Cohen Congress                | Caroline Hon                               | Rurth Nelson                             | Mary Lou Teel & Peter Freundlich     |
| Jace Alexander & Maddie Corman       | Michelle Hurst                             | Mark Nesselson, M.D. & Elliott Rosenblum | Tracy Thorne & Edmund Lewis          |
| Max Mayer & Catherine Corpeny        | Virginia & Richard Irwin                   | Cynthia Nixon                            | Kevin O'Rourke & Edith Thurber       |
| Margaret Crimmins                    | Sy Jacobs                                  | Steven O'Neill                           | Shane Tilson-L'Estrange              |
| George & Cathy Crow                  | Whitney Scott & Peter Jacobson             | Carol Ochs & Bruce MacVittie             | Gina Torres                          |
| Cameron Crowe                        | Linda Janklow                              | Jacki Ochs & Jan Kroeze                  | Anne Torsiglieri                     |
| Stephen & Sandra Crudgington         | Macon R. & Michael B. Jessop               | Paul & Maria Onderdonk                   | Joan Vail & John Thome               |
| Tom Cruise                           | Tom Slaughter & Marthe Jocelyn             | Greg MacPherson & Jane Perlmutter        | Laura Valeroso & David Seidman       |
| Arthur Dantchik                      | Amanda Johns                               | Steven & Margot Peter                    | Robert Abrams & Cynthia Vance        |
| Cathy Dantchik                       | Julia A. Johns                             | Bat-Sheva & Thomas Peters                | Wendy vanden Heuvel & Brad Coley     |
| Peter and Judith Dawkins             | Andrea Johnson                             | Peter & Ana Rosa Phillips                | John A. Vassallo                     |
| Cameron Diaz                         | Traci Paige Johnson & Robert Mowen         | Susan Ochs Phillips                      | Borah & Mildred Walton               |
| Edward & Joanne DiRugeri             | Cherry Jones & Mary O'Connor               | Oliver & Camilla Platt                   | Anita Waxman                         |
| Jon Divis & Gene Reilly              | Larry & Mary Jones                         | Richard Polatohck                        | Sally & Lenny Weiss                  |
| Richard & Rebecca Dresser            | Maurice Kanbar                             | Jeremy Posner                            | Daniel Wiener                        |
| Christopher & Karen Eddowes          | Lisa A. Kauffman                           | Dean & Leslie Potashner                  | Jenny Wiener                         |
| Mario Egozi                          | Paul McCrane & Dana Kellin                 | Gigi Pritzker Pucker & Michael Pucker    | Michael & Zena Wiener                |
| David Eigenberg                      | Stephen Kepniss                            | Christopher Randolph                     | Elizabeth Williams & Joseph Forte    |
| Ned Eisenberg                        | Seth & Beth Klarman                        | Peter & Helen Randolph                   | Jan Wilson & Saula Cutter            |
| Sophia & Gordon Elliott              | Joana & Jason Kilot                        | Theresa Rebeck & Jess Lynn               | Donald Windham                       |
| Barbara Ettinger                     | Mary Kong                                  | Alysia Reiner & David Basche             | Sarah Winkler & Simon Leopold        |
| Barbara Ettinger & Sven Huseby       | Judy Kuhn & David Schwab                   | Lucy E. Retan                            | John Woo                             |
| Heidi Ettinger                       | Allan & Nanette Larson                     | Anthony Rhulen                           | Joanne Woodward & Paul Newman        |
| Wendy Ettinger & Derek McLane        | Kate Lear & Jonathan LaPook                | Kate Hudson & Chris Robinson             | Jeffrey & Janine Yass                |
| Hannah Finn & John Wiltshire         | Robert Sean Leonard                        |  | James & Mary Lin Yoshimura           |
| Billy Finnegan                       |  |  | Richard Blackstone & Yldeez Yuksek   |
| Matt Williams & Angelina Fiordellisi |  |  | Virginia Zakian & Robert Sandberg    |
|                                      |  |  | Stuart Zicherman                     |

The 52nd Street Project presents The 2001 Playback Shows

# WHA' HAPPEN?

PLAYS WITH 2 SIDES



Fri., Nov. 2 and Sat., Nov. 3 at 7:30 p.m.

Sun., Nov. 4 at 3:00 p.m.

Theater at St. Clement's Church

423 W. 46th St., New York City

# WHA' HAPPEN?

**PLAYS WITH TWO SIDES**

*The 2001 Playback Shows*  
November 2-4  
Theater at  
St. Clement's Church

**The 52nd Street Project Staff:**

Gus Rogerson, Artistic Director  
Carol Ochs, Executive Director  
Michael Bernard, Associate Artistic Director  
John Sheehy, Director of Development and Marketing  
George "X-Acto" Babiak, Production Manager  
Julie Feldman, Director of Education  
Megan Sandberg-Zakian, Volunteer Coordinator  
Chris Ceraso, Teen Dean  
Liz Bell, Education Assistant  
Iris A. Brown, Graphic Designer  
Mayleen Cancel and Jayme Rosado, Receptionists  
Claire Sother, Intern



**Production Staff**

**Composer:**

Virginia Hart Pike

**Music Director:**

Douglas Nervik

**Set Designer:**

Kevin Joseph Roach

**Lighting Designer:**

Greg MacPherson

**Costume Designer:**

Sheila Kehoe

**Sound Designer:** Maury Schott

**Stage Manager:**

Noël Dawkins

**Slide Designers:**

Christopher Bonanos, Renato Castilho,  
Vickie Clarke, Johann Conforme,  
Katherine Lumb, Tiana Manfred, Monty  
Nicol, Kim Snow, Iwona Waluk

**"Wha' Happen?" Illustrations:**

James Stevenson

**Prop Design Team:**

Anju Andre-Bergmann, George Babiak,  
Chris Bonanos, Jason Gots, Richard  
Hicks, Katherine Lumb, Cara Marcous,  
Natalie Musteata, Monty Nicol, Noel  
Polanco, Christina Ramirez, Iwona  
Waluk

**Furniture Crew:**

Emily Crow and Noel Polanco

**Prop Crew:**

Claire Sother, Anju Andre-Bergmann,  
and Natalie Musteata

**Load-in and Light Hang Crew:**

Mona Arriola, Emily Crow, Moira  
MacDonald, Betsy Rhodes, John  
Salzman, Claire Sother, Jason Wells

**House Managers:** Cara Marcous,  
Susan McGinnis, and Mary Pat Walsh

**Chefs:** Christopher Randolph,  
Karin Schall, and Mary Pat Walsh



NATIONAL  
ENDOWMENT  
FOR THE ARTS

The Playback Program is made possible with public funds from the National Endowment for the Arts; The New York State Council on the Arts, a state agency; the Department of Youth and Community Development; and the New York City Department of Cultural Affairs Cultural Challenge Program. The 52nd Street Project is a member of Art/NY and a participant in the New Generations Program, funded by Doris Duke Charitable Foundation/The Andrew W. Mellon Foundation and administered by Theatre Communications Group, the national organization for the American Theater.

State of the Arts



NYSCA

## COOL STUFF ON SALE IN THE LOBBY!

The Fabulous Flyer Bar .....\$2.00 & \$1.50  
*and featuring Shel Silverstein's "Fivey and Twoey" logo:*  
Project T-shirts (NEW design) .....\$12.00  
Project T-shirts, long sleeve .....\$15.00  
Project Caps (NEW design) .....\$15.00  
Project Mugs .....\$5.00  
Project Pencil 3-pack (now in RED!) .....\$1.00

Thank you for coming to **WHA' HAPPEN?** If you are not on our mailing list (or if your address has changed), please fill out this form and give it to us on your way out or mail it to the address below. We would also like to know if you are interested in becoming a volunteer. We need help in **all areas**, so be sure to fill out the entire form.

**PLEASE ADD ME TO YOUR MAILING LIST:**

11/01

NAME: \_\_\_\_\_

ADDRESS: \_\_\_\_\_

ZIP \_\_\_\_\_

HOME PHONE: \_\_\_\_\_

DAYTIME PHONE: \_\_\_\_\_

E-MAIL ADDRESS: \_\_\_\_\_

MY OCCUPATION: \_\_\_\_\_

MY HOBBIES: \_\_\_\_\_

**YES, I WOULD LIKE TO BE OF HELP. I CAN:**

- |   |   |  |
|---|---|--|
| <input type="checkbox"/> Help load in and out for shows | <input type="checkbox"/> Draw and/or paint  | <input type="checkbox"/> Help kids with homework |
| <input type="checkbox"/> Hang lights                    | <input type="checkbox"/> Help with mailings | <input type="checkbox"/> Teach kids a skill      |
| <input type="checkbox"/> Work on a backstage crew       | <input type="checkbox"/> Do office work     | <input type="checkbox"/> Be a chef at an event   |
| <input type="checkbox"/> Do graphic design              | <input type="checkbox"/> Design sound       | <input type="checkbox"/> Design and sew costumes |
| <input type="checkbox"/> Other (please specify) _____   |   |  |

**MY SCHEDULE IS:**

- Very flexible. I'm often available during weekdays.  
 Somewhat flexible. I can help on the occasional morning or afternoon during the week.  
 Not very flexible at all, but I've got some free time on evenings and weekends.

If you would like to mail this (and you're always welcome to enclose a tax-deductible contribution), you can send it to: **The 52nd Street Project**, 500 West 52nd St., New York, NY 10019. Or fax it to (212) 333-5598.

## Don't Miss Our Upcoming Shows!

# FORK IN THE ROAD

December 14-16,  
Ensemble  
Studio Theatre

In September, 10 kids brand-new to the Project began a Playmaking class taught by Playmaking Director Michael Bernard. Come and see their final plays performed by adult professional actors.

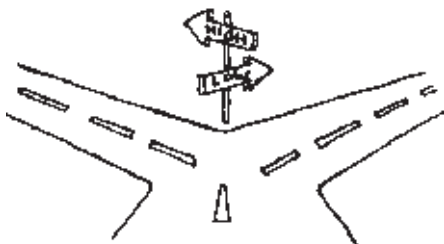

**10 CHOICE PLAYS**

# Table For Two

THE RESTAURANT PLAYS



## THE 2002 TWO-ON-TWOS

In the One-on-One's, a single kid is paired with a single adult. Now you can see *two* kids perform a play written by an adult and directed by *another* adult. Theater to be announced.

The 52nd Street Project is a non-profit organization that brings inner-city children from the Hell's Kitchen neighborhood together with professional theater artists to create original theater. **Wha' Happen?** is a production of our Playback program, in which kid actor/playwrights are taken away for a weekend in Wareham, Massachusetts (very close to Cape Cod) where they write a play. Their adult actor/playwright partners then write "answer plays" in response. For the final production, which you see here tonight, the partners perform both plays back-to-back. All of the kids involved are veterans of the Playmaking classes which were adapted for the Project by Daniel Judah Sklar from his book *Playmaking: Children Writing and Performing Their Own Plays*.

### The 52nd Street Project Board of Directors

Ben Barenholtz  
Lisa Benavides  
Rachel Chanoff  
Heidi Ettinger  
Wendy Ettinger  
Louis P. Friedman  
Stephen Graham, *chair*  
Larry Jones  
James McDaniel  
Frances McDormand

Patricia M. Murphy, Esq.  
Carol Ochs  
Willie Reale  
Gus Rogerson  
José Soto, Jr.,  
*alumni boardmember*  
Pamala Tyson  
Laura Valeroso  
Wendy vanden Heuvel  
Jenny Wiener

### Special Thanks

We're extremely grateful to Peter, Helen, and Christopher Randolph, who made their lovely home in Wareham, Massachusetts available to us over the Columbus Day Weekend. Thanks also to Anita Flanagan for her help with costumes, Vanessa Valdes for her sound advice, and Mother Crafton, Seth, Clarence, Wendy and the rest of the great staff at St. Clement's.

### In-Kind Contributions

Ensemble Studio Theatre, Neil A. Mazzella and Hudson Scenic Studios, the Murphy Law Office, Iris A. Brown, Ron Kastner and Capital Printing, Au'Some Candies, Big Apple Lights, Coleman, The Gap, Noggin, The Printing Store, Scholastic, Inc., Seagram's Chateau & Estate Wines, Shapiro & Lobel, Sesame Workshop, Watkins, Inc., Mayor's Office of Film & Television, Boylan's Bottling Co., David Sneddon & Fairway Market, Women's Interart, Andy Millon, Steve Olsen & The Westbank Cafe, Imaginary Studios, Robert Goldberg and Yorke Construction.



The 52nd Street Project is proud to participate in the NYC Arts Coalition's efforts to "Take Back Our City."



## WHA' HAPPEN? - ACT I

All original music composed by Virginia Pike

### Acceptance Speech

By Christina Ramirez, age 13. Dramaturg: Seret Scott. Director: Kim Sykes

### The Wonderful Adventures of One Rotten Banana

Written by Kim Sykes. Directed by Kim Sykes and Seret Scott

Georgia/Nana .....Christina Ramirez

June/Georgia (part 2)/Susan Lucci/Plantan .....Kim Sykes

"The Green Grass Grows All Around" lyrics by Christina Ramirez, "A Cure For Elmocitis" lyrics by Kim Sykes

### Double Take

By Zaida Natera, age 14 (15 next wk.) Dramaturg/Director: Lenore Pemberton

### Mother Take

By Adriana Trigiani. Director: Lenore Pemberton

Envy/Pride .....Zaida Natera

Jada/Ruby .....Lenore Pemberton

Speaker .....John Sheehy

SYZ .....Natalie Musteata, Anju Andre-Bergmann, Claire Sother

"Two Fly Girls" and "I'm Sorry" lyrics by Zaida Natera

### The Spirit

By Jayme Rosado, age 14. Dramaturg/Director: Liz Tuccillo

### The Spirit, Part II

Written and Directed by Liz Tuccillo

Allan/Andy .....Jayme Rosado

Mom/Mary .....Liz Tuccillo

### Identity Crisis

By Shevonne Hernandez, age 14. Dramaturg: Megan Sandberg-Zakian.

Directed by Gus Rogerson

### Clem 'N' Clementine

Written and Directed by Gus Rogerson

Jayana Rogerson/Clementine .....Shevonne Hernandez

Marco Hernandez/Clem .....Gus Rogerson

Flight attendant .....Emily Crow

The Boss .....Noel Polanco

Cigar Guy .....John Sheehy

Model Girl .....Claire Sother

"Clem 'n' Clementine's Reveille" and "Young In The Mind" lyrics by Gus Rogerson

👉 **Intermission!** 👈

## WHA' HAPPEN? - ACT II

### Foul Play

By Isaac Trujillo, age 14. Dramaturg/Director: Keith Reddin

### Over Overtime

Written and directed by Keith Reddin

Allen .....Isaac Trujillo

Mike .....Keith Reddin

Lewis .....Noel Polanco

Manager .....George Babiak

### Dance, Dance, and Why Not Dance?

By Yazy Troche, age 15. Dramaturg/Director: Liz Flahive

### I'll Tell You Why Not

Written and Directed by Liz Flahive

Yaaliyah/Mrs. Graziela Garcia Romero Schwartz .....Yazy Troche

Da Serious One/Manny the Flyer Guy .....Matt Saldívar

Another Flyer Guy .....Noel Polanco

Club People .....The Crew

Announcer/Kid .....Michael Bernard

"Winning or Losing" lyrics by Yazy Troche, "Mrs. Schwartz's Lament" lyrics by Liz Flahive

### That's The Way Life Is

By Michael Feliciano, age 14. Dramaturg/Director: Carlo Alban

### Life Is That Way

Written by Michael Bernard. Directed by Carlo Alban

Charlie .....Michael Feliciano

Maxwell .....Carlo Alban

Sam .....Natalie Musteata

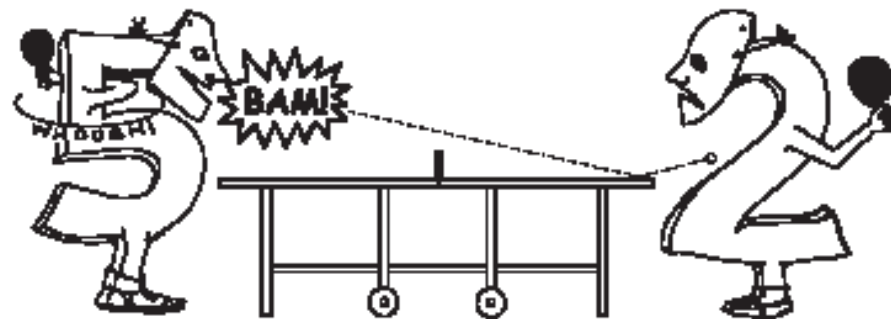

The 52nd Street Project gratefully acknowledges the support of the following foundations and corporations: Barker Welfare Foundation, The Bamsley Foundation, Blythmour Corporation, Capital Research Company, Carnegie Corporation of New York, Comedy Central, Consolidated Edison, The Dammann Fund, Deutsche Bank of Americas Foundation, The Dramatists Guild Fund, Eleanor, Dramatists Play Service, Adam & Mel Dubin Foundation, Doris Duke Charitable Foundation, The Educational Foundation of America, Entertainment Weekly, Ford Foundation, The Fan Fox & Leslie R. Samuels Foundation, The J. Paul Getty Trust, The Horace W. Goldsmith Foundation, The Hennessy Foundation, Holland Lodge Foundation, Hudson Scenic Studio, Betty E. & George B. Kaiser Foundation, Rita J. and Stanley H. Kaplan Foundation, Lloyds TSB Bank plc, James A. Macdonald Foundation, Ann M. Martin Foundation, The Andrew W. Mellon Foundation, Helen Merrill, Ltd., J.P. Morgan Charitable Trust, The William Morris Agency, Mosaic Entertainment, The New World Foundation, The New York Times Company Foundation., Newman's Own, Paramount Pictures, Roulette Entertainment Staging and Design, Inc., Harold & Mimi Steinberg Charitable Trust, The Surdna Foundation, Susquehanna, Theatre Communications Group, John A. Vassilaros & Sons, Inc., The Vervane Foundation, West Bank Cafe, Yorke Construction Corporation. In addition the following individuals made gifts of over \$150 this year (list is current as of 12/10/01)

Anonymous	Alexa Fogel	Robert Sean Leonard	Kate Hudson & Chris Robinson
Liliana Amador-Marty & Frank Marty	Katherine Foster	Becky & Steven Lewis	Loree Rodkin
Mark Lanow & Joanne Astrow	David Frankel	James Waterston & Line Lillevik	David & Anita Rogerson
Mary Bacon & Andrew Leynse	Eric & Juli Frankel	Margo Lion	Clifford & Betsy Ross
June Ballinger & Michael Goldstein	Naomi Freundlich & Charles Miles	Jessica Lissy	Daryl Roth
Talia Balsam & John Slattery	Louis & Patrice Friedman	Adrienne Lobel & Mark Linn Baker	Donald Rothschild & Lottchen Shivers
Ben Barenholtz	Hank Gallo	Richard & Susan Lobel	Kenneth Rothstein
Benny Bartley	Victor Garber	Charles Loutrell	Alexander Roy
Jessica Bauman	Beth Gardiner	Chris & Sally Lutz	Steve Sabba
Laurie Becker & Rick Sweren	Janeanne Garofalo	John Lyons	Laura Sametz
Gregory Bello	Rose Gasner & Larry Chertoff	Grace Lyu-Volckhausen	Tim & Lisa Sanford
Lisa Benavides & Tim Nelson	Joseph & Margaret Gazdak	Marsue & Peter MacNicol	Karin & Tom Schall
Barry & Myrna Bernard	Jonathan Gazdak	Paul & Lauren Mandell	Beth Schneider
Brian Swardstrom & Bonnie Bernstein	Hillel & Celia Gershenson	Brian & Marsha Mannain	Maury Schott
Alexander & Elizabeth Bernstein	Alexandra Gersten & John A. Vassilaros	Elizabeth Manne	Marc Segan
Stephen Bernstein	Willie Reale & Jenny Gersten	Peter Manning & André Bishop	Stefan Selig
Vicky Bijur & Ed Levine	Jilian Cahan Gersten	Richard P. Martin	Jeffrey Seller & Joshua Lehrer
Jeanette & Samuel Black	Ileen Getz & Mark Grinnell	Ali Marsh	Alyson Shapero
Lewis Black	Nancy Giles	Richard Marin	Aaron & Elaine Shapiro
Tessa Blake	Lloyd & Kilty Gilmour	Jesse L. Martin	Bernice Baruch Shawl
Mitchell Lemsky & Jane Bodle	Bob Glennon	Dave & Alicia Matthews	Jonathan Sheffer
Jane Bolster & Steve Wertimer	Judy Goldman & Michael Pillingier	Drew McCoy & Amy Aquino	William Holtzman & S. Sylvia Shepard
Buzz Bovshow	Fredrick & Nancy Goldman	Paul Reale & Barbara McCrane	Reed Birney & Connie Shulman
Alan Braverman	Nancy & Fred Goodman	Timothy Murtha & Elizabeth McDermott	Meg Simon
Kathy Briggs	Stephen & Cathy Graham	Fran McDormand & Joel Coen	Adam Felber & Jeanne Simpson
Becky Browder & Ted Neustadt	Connie Grappo & Lee Wilkof	Anne Meara & Jerry Stiller	Phillip K. & Gloria W. Smith
Susan Bruce & Peter Hedges	Michael Greif & Jonathan Fried	Alan & Janis Menken	Abigail Rose Solomon
Peter Jay Fernandez & Denise Burse	Mary Grieco	Chia Messina	Dr. David Solowiejczyk
Kate Burton & Michael Ritchie	Emily Grishman & Susan Sampliner	Audrey & Danny Meyer	John Steber & Robert Shaffron
Cora Cahan & Bernard Gersten	Lisa Gugenheim	Dean Michaels	James Neuberger & Helen Stambler
Mitchell Semel & Colleen Carroll	Evan Handler	Janet Mornjian & Steve Olsen	Jean Stein
Linda & Arthur Carter	Lynn Harris	Ross & Beth Moore	Ben & Christine Stiller
Rachel Chanoff	Jane & Jonathan Heine	John Morning	Abbot B. Stranahan
Ellen Chenoweth	Amy Henkels	Alfred Morris	Donald Margulies & Lynn Street
Glenda Chesshir	David Herdrich & Elizabeth Palmer Herdrich	Robin Morse & Gus Rogerson	Susanna Styron & Darrell Larson
Marissa & Travis Chibas	Peter Herdrich & Karen Trott	Patricia M. Murphy, Esq. & Adam Spilka	Daniel Swee
Richard Frankel & Kathleen Clark	Lieta Hesen-Cohen & Richard Cohn	Tony Goldwyn & Jane Musky	Mariko Tada
Jerome Cohen Congress	Nan & George Hirst	Geoffrey Nauftts	Jay & Rachel Tarses
Jace Alexander & Maddie Corman	Caroline Hon	Pam Nelson & Peter Fritschel	Mary Lou Teel & Peter Freundlich
Max Mayer & Catherine Corpeny	Michelle Hurst	Randy & Rona Nelson	Tracy Thorne & Edmund Lewis
Margaret Crimmins	Virginia & Richard Irwin	Rurth Nelson	Kevin O'Rourke & Edith Thurber
George & Cathy Crow	Sy Jacobs	Mark Nesselson, M.D. & Elliott Rosenblum	Shane Tilson-L'Estrange
Cameron Crowe	Whitney Scott & Peter Jacobson	Cynthia Nixon	Gina Torres
Stephen & Sandra Crudgington	Linda Janklow	Steven O'Neill	Anne Torsiglieri
Tom Cruise	Macon R. & Michael B. Jessop	Carol Ochs & Bruce MacVittie	Joan Vail & John Thorne
Arthur Dantchik	Tom Slaughter & Marthe Jocelyn	Jacki Ochs & Jan Kroeze	Laura Valeroso & David Seidman
Cathy Dantchik	Amanda Johns	Paul & Maria Onderdonk	Robert Abrams & Cynthia Vance
Peter and Judith Dawkins	Julia A. Johns	Greg MacPherson & Jane Perlmutter	Wendy vanden Heuvel & Brad Coley
Cameron Diaz	Andrea Johnson	Steven & Margot Peter	John A. Vassallo
Edward & Joanne DiRugeri	Traci Paige Johnson & Robert Mowen	Bat-Sheva & Thomas Peters	Borah & Mildred Walton
Jon Divis & Gene Reilly	Cherry Jones & Mary O'Connor	Peter & Ana Rosa Phillips	Anita Waxman
Richard & Rebecca Dresser	Larry & Mary Jones	Susan Ochs Phillips	Sally & Lenny Weiss
Christopher & Karen Eddowes	Maurice Kanbar	Richard Polatchek	Daniel Wiener
Mario Egozi	Lisa A. Kauffman	Jeremy Posner	Jenny Wiener
David Eigenberg	Paul McCrane & Dana Kellin	Dean & Leslie Potashner	Michael & Zena Wiener
Ned Eisenberg	Stephen Kepniss	Gigi Pritzker Pucker & Michael Pucker	Elizabeth Williams & Joseph Forte
Sophia & Gordon Elliott	Seth & Beth Klarman	Christopher Randolph	Jan Wilson & Saula Cutter
Barbara Ettinger	Joana & Jason Klot	Peter & Helen Randolph	Donald Windham
Barbara Ettinger & Sven Huseby	Mary Kong	Theresa Rebeck & Jess Lynn	Sarah Winkler & Simon Leopold
Heidi Ettinger	Belle & Roger Kuhn	Alysia Reiner & David Basche	John Woo
Wendy Ettinger & Derek McLane	Judy Kuhn & David Schwab	Lucy E. Retan	Joanne Woodward & Paul Newman
Hannah Finn & John Wiltshire	Allan & Nanette Larson	Anthony Rhulen	Jeffrey & Janine Yass
Billy Finnegan	Kate Lear & Jonathan LaPook		James & Mary Lin Yoshimura
Matt Williams & Angelina Fiordellisi			Richard Blackstone & Yldeez Yuksek
Terry Fitzpatrick & Stephen Perelopuk			Virginia Zakian & Robert Sandberg
			Stuart Zicherman

The 52nd Street Project  
presents the Fall 2001 Playmaking Series

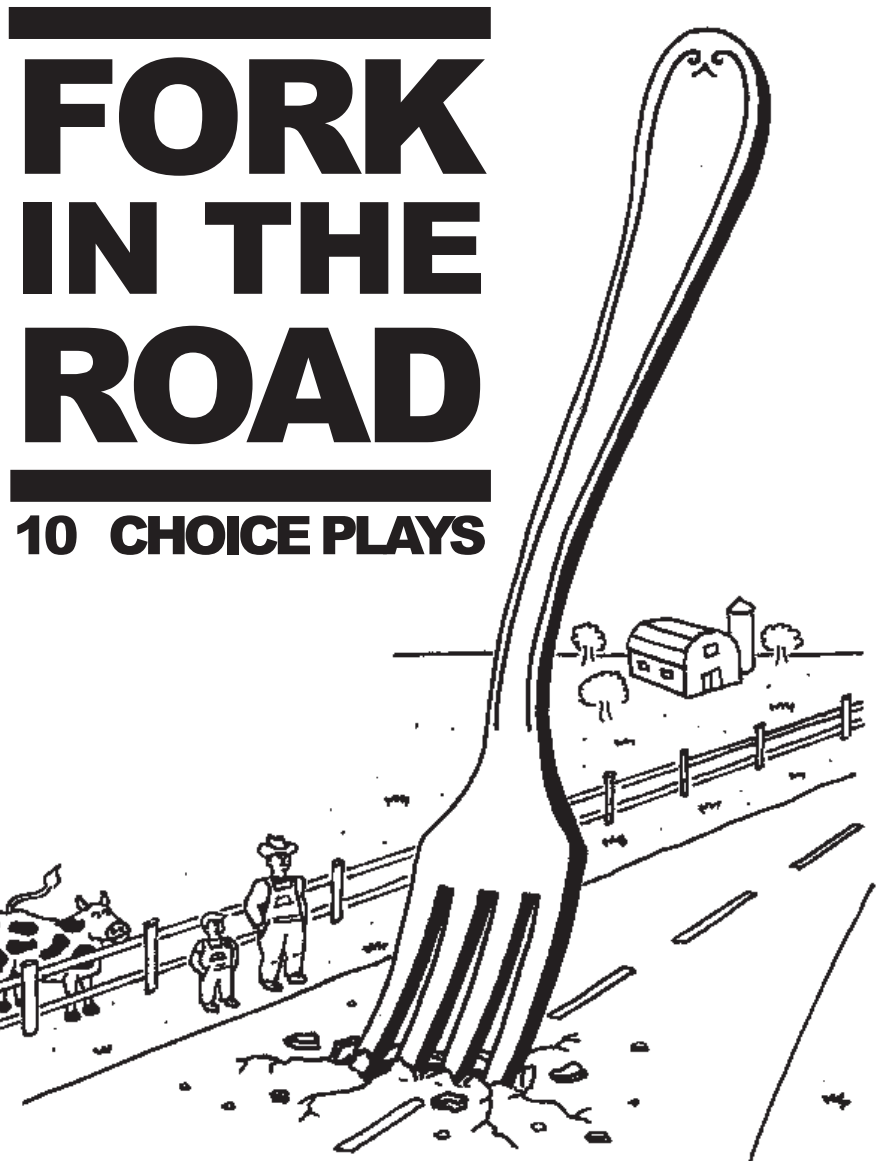

Fri., Dec. 14 at 7:30 p.m., Sat., Dec. 15 at 3:00 p.m. and 7:30 p.m.  
and Sun., Dec. 16 at 3:00 p.m.

**The Ensemble Studio Theatre**

549 West 52nd St., New York City

# FORK IN THE ROAD

The Fall 2001 Playmaking Plays - Dec. 14-16, The Ensemble Studio Theatre

## The 52nd Street Project Staff:

Gus Rogerson, Artistic Director  
 Carol Ochs, Executive Director  
 Michael Bernard, Associate Artistic Director  
 John Sheehy, Director of Development and Marketing  
 George "X-Acto" Babiak, Production Manager  
 Julie Feldman, Director of Education  
 Megan Sandberg-Zakian, Volunteer Coordinator  
 Chris Ceraso, Teen Dean  
 Liz Bell, Education Assistant  
 Diana Rojas, Executive Assistant  
 Iris A. Brown, Graphic Designer  
 Mayleen Cancel and Jayme Rosado, Receptionists  
 Claire Sather, Intern



## Production Staff

**Composer:** Rusty Magee  
**Set Designer:** Kevin Joseph Roach  
**Lighting Designer:**  
 Greg MacPherson  
**Costume Designer:** Janet Edwards  
**Sound Designer:**  
 Betsy Rhodes  
**Stage Manager:**  
 Perry McBain Daniel  
**Slide Designers:**  
 Katherine Lumb, Richard Hicks,  
 Monty Nicol, Kim Snow,  
 John Steward, Alberta Testanero,  
 Iwona Waluk  
**"Fork" Illustrations:** George Babiak  
**Prop Design Team:**  
 Anju Andre-Bergmann, George  
 Babiak, Heather Carnduff,  
 Virginia Gifford, Jennifer Getzinger,

Cara Marcous, Natalie Musteata,  
 Leigh Pennebaker, Christina  
 Ramirez, Megan Sandberg-Zakian,  
 Claire Sather, John Sheehy, Kurt  
 Wootton  
**Furniture Crew:**  
 Ritch Duncan, Shirley Rumierk,  
 Johnathan Roldan  
**Prop Crew:**  
 Abigail Solomon, Claire Sather,  
 Frankie Ventura, Adrian Zambrano  
**Load-in and Light Hang Crew:**  
 Doug Lockwood, Perry McBain  
 Daniel, Betsy Rhodes, Samara  
 Rifkin, Claire Sather, Tom Schall,  
 Maury Schott  
**House Manager:** Maury Schott  
**Hosts:** Eric Karpeles and Mike Sell  
**Master Chef:** Eric Karpeles



NATIONAL  
 ENDOWMENT  
 FOR THE ARTS

The Playmaking Program is made possible with public funds from the National Endowment for the Arts; The New York State Council on the Arts, a state agency; the Department of Youth and Community Development; and the New York City Department of Cultural Affairs Cultural Challenge Program. The 52nd Street Project is a member of Art/NY and a participant in the New Generations Program, funded by Doris Duke Charitable Foundation/The Andrew W. Mellon Foundation and administered by Theatre Communications Group, the national organization for the American Theater.

State of the Arts



NYSCA

## COOL STUFF ON SALE IN THE LOBBY!

The Fabulous Flyer Bar .....\$2.00 & \$1.50  
*and featuring Shel Silverstein's "Fivey and Twoey" logo:*  
 Project Sweatshirts (NEW ITEM!) .....\$20.00  
 Project T-shirts, long sleeve .....\$15.00  
 Project Caps (NEW design) .....\$15.00  
 Project Mugs .....\$5.00  
 Project Pencil 3-pack (now in RED!) .....\$1.00

Thank you for coming to **FORK IN THE ROAD**. If you are not on our mailing list (or if your address has changed), please fill out this form and give it to us on your way out or mail it to the address below. We would also like to know if you are interested in becoming a volunteer. We need help in **all areas**, so be sure to fill out the entire form.

### PLEASE ADD ME TO YOUR MAILING LIST:

12/01

NAME: \_\_\_\_\_

ADDRESS: \_\_\_\_\_

ZIP \_\_\_\_\_

HOME PHONE: \_\_\_\_\_

DAYTIME PHONE: \_\_\_\_\_

E-MAIL ADDRESS: \_\_\_\_\_

MY OCCUPATION: \_\_\_\_\_

MY HOBBIES: \_\_\_\_\_

### YES, I WOULD LIKE TO BE OF HELP. I CAN:

- |   |   |  |
|---|---|--|
| <input type="checkbox"/> Help load in and out for shows | <input type="checkbox"/> Draw and/or paint  | <input type="checkbox"/> Help kids with homework |
| <input type="checkbox"/> Hang lights                    | <input type="checkbox"/> Help with mailings | <input type="checkbox"/> Teach kids a skill      |
| <input type="checkbox"/> Work on a backstage crew       | <input type="checkbox"/> Do office work     | <input type="checkbox"/> Be a chef at an event   |
| <input type="checkbox"/> Do graphic design              | <input type="checkbox"/> Design sound       | <input type="checkbox"/> Design and sew costumes |
| <input type="checkbox"/> Other (please specify) _____   |   |  |

### MY SCHEDULE IS:

- Very flexible. I'm often available during weekdays.  
 Somewhat flexible. I can help on the occasional morning or afternoon during the week.  
 Not very flexible at all, but I've got some free time on evenings and weekends.

If you would like to mail this (and you're always welcome to enclose a tax-deductible contribution), you can send it to: **The 52nd Street Project**, 500 West 52nd St., New York, NY 10019. Or fax it to (212) 333-5598.

**Don't Miss Our Upcoming Shows!**

# Table For Two

## THE RESTAURANT PLAYS



### THE 2002 TWO-ON-TWOS

Feb. 1-3, 2002 at The Women's Interart Annex  
(Right across the hall from the Clubhouse)

In the One-on-One's, a single kid is paired with a single adult. Now you can see *two* kids perform a play written by an adult and directed by *another* adult. Call 642-5052 for reservations

# Heart of The Matter

(Basically Ten Plays)

The Winter Playmaking Series

March, 2002 at a theater to be announced.

If you're enjoying the show tonight, you'll want to come see the work of our next batch of Project newcomers! Theater to be announced.

The 52nd Street Project is a non-profit organization that brings children from the Hell's Kitchen neighborhood together with professional theater artists to create original theater. **FORK IN THE ROAD** is a production of our Playmaking program. Young people participate in an eight-week playwriting course taught by Michael Bernard and adapted for the Project by Daniel Judah Sklar from his book *Playmaking: Children Writing and Performing Their Own Plays*. At the end of the course, each child is given two actors, a theme, and a dramaturg/director who guides him or her through the writing of a play during a weekend retreat in the country (Tyler Hill, Pennsylvania, for this show). Tonight's performance is the end result.

The Project is delighted to return to the Ensemble Studio Theatre, where we have been performing since our inception in 1981. We gratefully acknowledge the fact that if E.S.T. wasn't here, we'd be nowhere.

### The 52nd Street Project Board of Directors

Ben Barenholtz	Patricia M. Murphy, Esq.
Lisa Benavides	Carol Ochs
Rachel Chanoff	Willie Reale
Heidi Ettinger	Gus Rogerson
Wendy Ettinger, <i>chair emeritus</i>	José Soto, Jr., <i>alumni boardmember</i>
Louis P. Friedman	Pamala Tyson
Stephen Graham, <i>chair</i>	Laura Valeroso
Larry Jones	Wendy vanden Heuvel
James McDaniel	Jenny Wiener
Frances McDormand	

### Special Thanks

We're extremely grateful to Eric Karpeles and Mike Sell, who graciously allowed us to use their beautiful home in Pennsylvania as our base of operations for the writer's retreat. Thanks also to our terrific host families, the Cobbs, the Grunns, the Halvorsens, the Pursches, the Russos, the Rutledges, Sohail Raikhy, and the Stoeckles.

### In-Kind Contributions

Ensemble Studio Theatre, Neil A. Mazzella and Hudson Scenic Studios, the Murphy Law Office, Iris A. Brown, Ron Kastner and Capital Printing, Au'Some Candies, Big Apple Lights, Coleman, The Gap, Noggin, The Printing Store, Scholastic, Inc., Seagram's Chateau & Estate Wines, Shapiro & Lobel, Sesame Workshop, Watkins, Inc., Mayor's Office of Film & Television, Boylan's Bottling Co., David Sneddon & Fairway Market, Women's Interart, Andy Millon, Steve Olsen & The Westbank Cafe, Imaginary Studios, Robert Goldberg and Yorke Construction, Prime Films, and Cubic B's.

## FORK IN THE ROAD - ACT I

All original music composed by Rusty Magee

### A So-Called Family

By Michael Velez, age 11. Dramaturg/Director: Rick Meese

Joseph .....David Zayas  
Jasmine .....Larry Nathanson  
Crazy the Monkey .....Michael Bernard  
Baby voices .....Ritch Duncan

“One Time Ago” lyrics by Michael Velez. Choreography by Jeanne Simpson.

### Step By Step

by Madelyne Ross, age 12. Dramaturg/Director: Jessica Bauman

Keisha .....Lizzy Davis  
Mr. Williams .....Michael Potts  
Principal .....Kevin Jackson  
Students .....Frankie Ventura and Adrian Zambrano

### Ruby and Buddy’s Big Deal: Be Yourself

by Alex Tomas, age 11. Dramaturg/Director: Angel David

Ruby .....Zabryna Guevara  
Buddy .....Ray Thomas  
Mr. James .....Ritch Duncan  
A Waiter .....Abigail Solomon

“Be Yourself” lyrics by Alex Tomas.

### The Crystal Hunt

by Victor Ariel Cortes, age 9. Dramaturg/Director: Sascha Paladino

Zack .....David Eigenberg  
Ricky .....David Costabile  
Slime People .....Crew

### A Date For Mom

by Johanna Vidal, age 11. Dramaturg/Director: George Babiak

Angie .....Niambi Nataka  
Mom .....Phyllis Somerville  
Jimmy .....Christopher Randolph  
Man in Store .....Lee Wilkof  
Cops .....Frankie Ventura and Adrian Zambrano

👉 **Intermission!** 👈

## FORK IN THE ROAD - ACT II

### To Sing Or Not To Sing

by Solangee Acosta, age 12. Dramaturg/Director: Lizzie Gottlieb

Stephanie .....Judy Kuhn  
Nancy Babushka .....Lois Smith  
Sam .....Frankie Ventura  
Burger King Patrons .....Johnathan Roldan and Adrian Zambrano  
Steve .....John Sheehy

“Emotions” and “Money” lyrics by Solangee Acosta.

### Sneezing Andrea

by Katie Grullon, age 11. Dramaturg/Director: Kay Matschullat

Andrea .....Abigail Lopez  
Sasha .....Leslie Lyles

### One Night at the Heavenly Hotel

By Lilli Cooper, age 11. Dramaturg/Director: Susan Vitucci

Shannon .....Mercedes Herrero  
Lisa .....Phyllis Somerville  
Mrs. Perry .....Shirley Rumierk

“What People Think When They’re Alone” lyrics by Lilli Cooper

### Jack and Jill

by Zebulun Santiago, age 11. Dramaturg/Director: Glynis Rigby

Jack .....Phillip Christian  
Jill .....Anita Flanagan  
Preacher .....Shirley Rumierk

### A Classroom Breakout

by Spencer Lopez, age 11. Dramaturg/Director: Lee Wilkof

Jhon .....Billy Crudup  
Mr. Lowell .....Kevin Jackson  
Dad .....Lee Wilkof  
Announcer .....Michael Bernard

“Friendship” lyrics by Spencer Lopez



The 52nd Street Project gratefully acknowledges the support of the following foundations and corporations: Barker Welfare Foundation, The Barnsley Foundation, Capital Research Company, Carnegie Corporation of New York, Comedy Central, Deutsche Bank of Americas Foundation, The Dramatists Guild Fund, Dramatists Play Service, Eleanor, Adam & Mel Dubin Foundation, Doris Duke Charitable Foundation, Entertainment Weekly, The Fan Fox & Leslie R. Samuels Foundation, The J. Paul Getty Trust, The Horace W. Goldsmith Foundation, The Hennessy Foundation, Holland Lodge Foundation, Hudson Scenic Studio, Betty E. & George B. Kaiser Foundation, Lloyds TSB Bank plc, James A. Macdonald Foundation, Helen Merrill, Ltd., Milbrook School, The Cynthia & George Mitchell Foundation, The William Morris Agency, Mosaic Entertainment, The National Board of Review, The New World Foundation, The New York Times Company Foundation, Newman's Own, Paramount Pictures, Laura Pels Foundation, Roulette Entertainment, Staging & Design, Inc., Harold & Mimi Steinberg Charitable Trust, The Surdna Foundation, Susquehanna, Theatre Communications Group, Inc., John A. Vassilaros & Son, Inc., The Vervane Foundation, West Bank Cafe, The Wiener Family Foundation, Yorke Construction Corporation In addition the following individuals made gifts of over \$150 this year (list is current as of 1/30/02)

Anonymous	Hannah Finn & John Wiltshire	Judy Kuhn & David Schwab	David & Anita Rogerson
Liliana Amador-Marty & Frank Marty	Billy Finnegan	Roger & Belle Kuhn	Clifford & Betsy Ross
Drew McCoy & Amy Aquino	Matt Williams & Angelina Fiordellisi	Lynn Landis	Daryl Roth
Mary Bacon & Andrew Leynse	Terry Fitzpatrick & Stephen Perrepeluk	Allan & Nanette Larson	Alexander Roy
June Ballinger & Michael Goldstein	Alexa Fogel	Kate Lear & Jonathan LaPook	Shirley Rumierk
Talia Balsam & John Slattery	Katherine Foster	Courtney LeClaire-Conway	Steve Sabba
Ben Barenholtz	David Frankel	Willem Dafoe & Liz Lecompte	Laura Sametz
Benny Bartley	Eric & Juli Frankel	Becky & Steven Lewis	Tim & Lisa Sanford
Jessica Bauman	Naomi Freundlich & Charles Miles	James Waterston & Line Lillevik	Karin & Tom Schall
Laurie Becker & Rick Sweren	Louis & Patrice Friedman	Margo Lion	Beth Schneider
Meredith Beeuwkes	Victor Garber	Jessica Lissy	Maury Scott
Gregory Bello	Beth Gardiner	Adrienne Lobel & Mark Linn Baker	Whitney Scott & Peter Jacobson
Lisa Benavides & Tim Nelson	Jeanne Garofalo	Richard & Susan Lobel	Stefan Selig
Barry & Myrna Bernard	Rose Gasner & Larry Chertoff	Charles Loutrell	Jeffrey Seller & Joshua Lehrer
Brian Swardstrom & Bonnie Bernstein	Jonathan Gazdak	John Lyons	Alyson Shapero
Alexander & Elizabeth Bernstein	Alexandra Gersten & John Vassilaros	Grace Lyu-VolckHausen	Aaron & Elaine Shapiro
Stephen Bernstein	Willie Reale & Jenny Gersten	Marsue & Peter MacNicol	Jonathan Sheffer
Vicky Bijur & Ed Levine	Jilian Cahan Gersten	Paul & Lauren Mandell	William Holtzman & S. Sylvia Shepard
Lewis Black	Ileen Getz & Mark Grinnell	Elizabeth Manne	Reed Birney & Connie Shulman
Tessa Blake	Nancy Giles	Peter Manning & André Bishop	Meg Simon
Mitchell Lemsky & Jane Bodle	Lloyd & Kilty Gilmour	Richard Marin	Abigail Rose Solomon
Jane Bolster & Steve Wertimer	Bob Glennon	Ali Marsh	Dr. David Solowiejczyk
Buzz Bovshow	Judy Goldman & Michael Pillingier	Jesse L. Martin	José & Michelle Soto
Alan Braverman	Fred & Nancy Goodman	Dave & Alicia Matthews	James Neuberger & Helen Stambler
Kathy Briggs	Stephen & Cathy Graham	Paul Reale & Barbara McCrane	Fran McDormand & Joel Coen
Becky Browder & Ted Neustadt	Connie Grappo & Lee Wilkof	James & Hannelore McDaniel	Anne Meara & Jerry Stiller
Susan Bruce & Peter Hedges	Michael Greif & Jonathan Fried	Dean Michaels	Alan & Janis Menken
Peter Jay Fernandez & Denise Burse	Emily Grishman & Susan Sampliner	Ross & Beth Moore	Chia Messina
Kate Burton & Michael Ritchie	Lisa Gugenheim	John Morning	Audrey & Danny Meyer
Cora Cahan & Bernard Gersten	Evan Handler	Alfred H. Morris	Nancy Meyer & Marc Weiss
Mitchell Semel & Colleen Carroll	Lynn E. Harris	Robin Morse & Gus Rogerson	John Steber & Robert Shaffron
Linda & Arthur Carter	Jane & Jonathan Heine	Patricia M. Murphy, Esq. & Adam Spilka	Jean Stein
Rachel Chanoff	Amy Henkels	Timothy Murtha & Elizabeth McDermott	Ben & Christine Stiller
Ellen Chenoweth	David Herdrich & Elizabeth Palmer Herdrich	Tony Goldwyn & Jane Musky	Abbot B. Stranahan
Glenda Chesshir	Lieta Hesen-Cohen & Richard Cohn	Geoffrey Nauffts	Donald Margulies & Lynn Street
Marissa & Travis Chibas	Katy Homans & Patterson Sims	Pamela & Peter Nelson	Susanna Styron & Darrell Larson
Richard Frankel & Kathleen Clark	Caroline Hon	Ruth Nelson	Daniel Sweet
Jerome Cohen Congress	Kate Hudson & Chris Robinson	Mark Nesselson, M.D. & Elliott Rosenblum	Mary Lou Teel & Peter Freundlich
Elizabeth Cooper-Davis & Gordon Davis	Michelle Hurst	Steven O'Neill	Tracy Thorne & Edmund Lewis
Jace Alexander & Maddie Corman	Virginia & Richard Irwin	Carol Ochs & Bruce MacVittie	Kevin O'Rourke & Edith Thurber
Margaret Crimmins	Sy Jacobs	Jacki Ochs & Jan Kroeze	Gina Torres
Bill Wrubel & Jennifer Crittenden	Linda Janklow	Paul & Maria Onderdonk	Anne Torsiglieri & Michael Bernard
George & Cathy Crow	Macon R. & Michael B. Jessop	Greg MacPherson & Jane Perlmutter	Peter Herdrich & Karen Trott
Cameron Crowe	Amanda Johns	Steven & Margot Peter	Pamala Tyson & Sean Mudd
Tom Cruise	Julia A. Johns	Bat-Sheva & Thomas Peters	Joan Vail & John Thorne
Arthur Dantchik	Andrea Johnson	Peter & Ana Rosa Phillips	Laura Valeroso & David Seidman
Cathy Dantchik	Traci Paige Johnson & Robert Mowen	Susan Ochs Phillips	Robert Abrams & Cynthia Vance
Peter & Judith Dawkins	Cherry Jones & Mary O'Connor	Jeremy Posner	Wendy vanden Heuvel & Brad Coley
Noël Dawkins	Larry & Mary Jones	Dean & Leslie Potashner	John A. Vassallo
Cameron Diaz	Maurice Kanbar	Christopher Randolph	Borah & Mildred Walton
Buddy Dikman & Chuck Davis	Lisa A. Kauffman	Peter & Helen Randolph	Anita Waxman
Edward & Joanne DiRugieris	Paul McCrane & Dana Kellin	Alysia Reiner & David Basche	Sally & Lenny Weiss
Jon Divis & Gene Reilly	Stephen & Sharon Kepniss	Lucy E. Retan	Daniel Wiener
Richard & Rebecca Dresser	Seth & Beth Klarman	Loree Rodkin	Jenny Wiener
Mario Egozi	Joana & Jason Klot		Michael & Zena Wiener
Ned Eisenberg	Mary Kong		Elizabeth Williams & Joseph Forte
Sophia & Gordon Elliott			Jan Wilson & Saula Cutter
Barbara Ettinger & Sven Huseby			Donald Windham
Wendy Ettinger & Derek McLane			Gary Winick

*The 52nd Street Project Presents*

# TABLE FOR TWO

## THE RESTAURANT PLAYS



## *The 2002 Two-on-Tuos*

*Friday, February 1 at 7:30 p.m.*

*Saturday, February 2 at 3:00 & 7:30 p.m.*

*Sunday, February 3 at 3:00 p.m.*

*The Women's Interart Annex*

*500 W. 52nd St., #2A (2nd Floor)*

*The 2002 Two-on-Two*  
**Table for Two: The Restaurant Plays**  
*The Women's Interart Annex - Feb. 1-3, 2002*

**The 52nd Street Project Staff:**

Gus Rogerson, Artistic Director  
 Carol Ochs, Executive Director  
 Michael Bernard, Associate Artistic Director  
 John Sheehy, Director of Development and Marketing  
 George "X-Acto" Babiak, Production Manager  
 Julie Feldman, Director of Education  
 Megan Sandberg-Zakian, Volunteer Coordinator  
 Chris Ceraso, Teen Dean  
 Liz Bell, Education Assistant  
 Diana "The Kid" Rojas, Executive Assistant  
 Iris A. Brown, Graphic Designer  
 Mayleen Cancel and Jayme Rosado, Receptionists  
 Catherine Glenn, Britta Jensen, Julia Walk Miller, Interns



**Composer:**

Deborah Abramson

**Music Director:**

Joe Rubenstein

**Set Designer:**

Kevin Joseph Roach

**Lighting Designer:**

Greg MacPherson

**Costume Designer:**

Melissa Toth

**Sound Designer:** Britta Jensen

**Stage Manager:**

Dawn Reynolds

**Slide Designers:**

Katherine Lumb, Richard Hicks,  
 Monty Nicol, Kim Snow, Iwona  
 Waluk, and George Babiak

**"Table for Two" Illustration:**

Chesley McLaren

**Prop Design Team:**

George Babiak, Heather Carnduff,  
 Catherine Glenn, Britta Jensen,  
 Annette Madden, Cara Marcous,  
 Julia Walk Miller, Jay Patterson,  
 Leigh Pennebaker, Diana Rojas

**Furniture Crew:**

Kevin Heisler

**Prop Crew:**

Julia Walk Miller, Catherine Glenn,  
 Judy Agosto, Ivana Granados

**Load-in and Light Hang Crew:**

Dale Ho, Frauke Levin, Anna Li,  
 Jay Patterson, Becky White

**House Manager:** Maury Schott

**Host and Guest Chef:**

Maria Tucci

**Master Chefs:**

Carol Ochs & John Sheehy



NATIONAL  
 ENDOWMENT  
 FOR THE ARTS

The Two-on-Two Program is made possible with public funds from the National Endowment for the Arts; The New York State Council on the Arts, a state agency; the Department of Youth and Community Development; and the New York City Department of Cultural Affairs. The 52nd Street Project is a member of Art/NY.

State of the Arts



**COOL STUFF ON SALE IN THE LOBBY!**

The Fabulous Flyer Bar .....\$2.00 & \$1.50  
*and featuring Shel Silverstein's "Fivey and Twoey" logo:*  
 Project Sweatshirts (NEW ITEM!) .....\$20.00  
 Project T-shirts, long sleeve .....\$15.00  
 Project Caps (NEW design) .....\$15.00  
 Project Mugs .....\$5.00  
 Project Pencil 3-pack (now in RED!) .....\$1.00

Thank you for coming to **TABLE FOR TWO!** If you are not on our mailing list (or if your address has changed), please fill out this form and give it to us on your way out or mail it to the address below. We would also like to know if you are interested in becoming a volunteer. We need help in *all areas*, so be sure to fill out the entire form.

**PLEASE ADD ME TO YOUR MAILING LIST:**

1/02

NAME: \_\_\_\_\_

ADDRESS: \_\_\_\_\_

ZIP

HOME PHONE: \_\_\_\_\_

DAYTIME PHONE: \_\_\_\_\_

E-MAIL ADDRESS: \_\_\_\_\_

MY OCCUPATION: \_\_\_\_\_

MY HOBBIES: \_\_\_\_\_

**YES, I WOULD LIKE TO BE OF HELP. I CAN:**

- |   |   |  |
|---|---|--|
| <input type="checkbox"/> Help load in and out for shows | <input type="checkbox"/> Draw and/or paint  | <input type="checkbox"/> Help kids with homework |
| <input type="checkbox"/> Hang lights                    | <input type="checkbox"/> Help with mailings | <input type="checkbox"/> Teach kids a skill      |
| <input type="checkbox"/> Work on a backstage crew       | <input type="checkbox"/> Do office work     | <input type="checkbox"/> Be a chef at an event   |
| <input type="checkbox"/> Do graphic design              | <input type="checkbox"/> Design sound       | <input type="checkbox"/> Design and sew costumes |
| <input type="checkbox"/> Other (please specify) _____   |   |  |

**MY SCHEDULE IS:**

- Very flexible. I'm often available during weekdays.  
 Somewhat flexible. I can help on the occasional morning or afternoon during the week.  
 Not very flexible at all, but I've got some free time on evenings and weekends.

If you would like to mail this (and you're always welcome to enclose a tax-deductible contribution), you can send it to: **The 52nd Street Project**, 500 West 52nd St., New York, NY 10019. Or fax it to (212) 333-5598.

## Don't Miss Our Upcoming Shows!

# Heart of The Matter (Basically Ten Plays)

The Winter Playmaking Series

**March 22-24 at a theater to be announced.**

This month, a fresh batch of newcomers began our 8-week Playmaking program. At the end of the class they will be whisked away to Kent, Connecticut for a weekend in which they will fashion 10 brand new plays featuring your favorite Project adult actors.

**Honorary Chairman Tom Cruise invites you to  
SAVE THE DATE & THE LAST DANCE**

**MONDAY,  
MAY 13, 2002**

**STILL  
STAYIN'  
ALIVE**



**The 52nd Street Project's 20th Anniversary**

**DISCO BENEFIT**

For more information or reservations call John "Dancin' Machine" Sheehy  
@ 212/333-5252.

The 52nd Street Project is a non-profit organization that brings children from the Hell's Kitchen neighborhood together with professional theater artists to create original theater. **Table for Two** is a production of our Two-on-Two program, in which two of the Project's more seasoned kids are matched with two adult volunteers (one playwright, one director) and given the task of creating a short play. After the writers presented their contributions, the actors and directors traveled to Dutchess County earlier this month to rehearse the plays over a three-day weekend. Tonight's performance is the final result.

### The 52nd Street Project Board of Directors

Ben Barenholtz

Lisa Benavides

Rachel Chanoff

Cathy Dantchik

Noël Dawkins

Wendy Ettinger,

*chair emeritus*

Louis P. Friedman

Stephen Graham,

*chair*

Larry Jones

James McDaniel

Frances McDormand

Patricia M. Murphy, Esq.

Carol Ochs

Willie Reale

Shirley Rumierk,

*alumni boardmember*

Gus Rogerson

José Soto, Jr.,

*alumni boardmember*

Pamala Tyson

Laura Valeroso

Wendy vanden Heuvel

John A. Vassilaros

Jenny Wiener

### Special Thanks

We're grateful to **Margot, Ronnie, Paul, Sonya**, and the rest of the staff at **Women's Interart Annex** for making their extremely convenient space available to us. We also owe big-time to **Maria Tucci** and **Robert Gottlieb**, **Stephen Perpeluk** and **Terry Fitzpatrick**, and **Derek McLane** and **Wendy Ettinger**, all of whom graciously allowed us to use their upstate homes for three tumultuous and fun-filled days. Our gratitude also goes to Super Project Pal **Ron Fiorina** of **Boylan Bottling Co.**, **Mary Moore** and **D'Agostino's Supermarkets**, and brand-spanking new board member **John A. Vassilaros** (a.k.a. Johnny Coffeeshopolis) for contributing our intermission refreshments.



## Table for Two: The Restaurant Plays - Act One

All original music composed by Deborah Abramson  
and performed by Joe Rubenstein

### Crazy Larry's Squid Hut

By Susan Kim. Directed by Joel de la Fuente.

Crazy Larry .....Adalberto Rodriguez  
Dolores/Jessica .....Wendy Rivera

"I Want a Restaurant" lyrics by John Sheehy.

### The King Ain't the Thing

by Jerome Hairston. Directed by Gus Rogerson.

King Diggity .....Oscar Padilla  
Brotha Bubba .....Akeem Frazier  
Mister Ed .....Ed Vassallo  
Groupies .....The crew

"The King Ain't the Thing" and "I'm Gonna Chomp the Chump"  
lyrics by Jerome Hairston.

### Hungry for Heaven

By Alexandra Gersten. Directed by Megan Sandberg-Zakian.

Angela ..... Kathy Taveras  
Cherie .....Lizette Natera  
Maria Coffeeshopolis .....Diana Rojas  
Little Roach .....Judy Agosto  
Roach Chorus .....Ivana Granados, John Sheehy,  
and Nancy Giles

"It Is a Pleasure to Serve" lyrics by Willie Reale.

 **Intermission!** 

Root Beer Floats, Coffee,  
and Flyer Bars in the lobby!

## Act Two

### The Luckiest Men in the World

By Michaela Murphy. Directed by Ed Vassallo.

Lou Gehrig .....Frankie Ventura  
Babe Ruth .....Adrian Zambrano  
Announcer .....Ed Vassallo  
Patron .....Ed Vassallo

"Step Up to the Plate" lyrics by Michaela Murphy.

### The Right Place

by John Sheehy. Directed by Nancy Giles.

Tamara .....Allary Seda  
Crystal .....Tiffany Butler

"The Right Place" lyrics by John Sheehy.

### Short-Order Crook

By Adam Felber. Directed by Jeanne Simpson.

Lenny Knuckles .....Jeremy Butler  
Margaret .....Jaymaree Rosado  
The Police .....Jeanne Simpson, Adam Felber

"You Grabbed a Fork" lyrics by Adam Felber.



The 52nd Street Project gratefully acknowledges the support of the following foundations and corporations: Barker Welfare Foundation, The Barnsley Foundation, Capital Research Company, Carnegie Corporation of New York, Comedy Central, Deutsche Bank of Americas Foundation, The Dramatists Guild Fund, Dramatists Play Service, Eleanor, Adam & Mel Dubin Foundation, Doris Duke Charitable Foundation, Entertainment Weekly, The Fan Fox & Leslie R. Samuels Foundation, The J. Paul Getty Trust, The Horace W. Goldsmith Foundation, The Hennessy Foundation, Holland Lodge Foundation, Hudson Scenic Studio, Betty E. & George B. Kaiser Foundation, Lloyds TSB Bank plc, Lucent Technologies, James A. Macdonald Foundation, The Andrew W. Mellon Foundation, Helen Merrill, Ltd., Milbrook School, The Cynthia & George Mitchell Foundation, The William Morris Agency, Mosaic Entertainment, The National Board of Review, The New World Foundation, The New York Times Company Foundation, Newman's Own, Paramount Pictures, Laura Pels Foundation, Roulette Entertainment, Staging & Design, Inc., Harold & Mimi Steinberg Charitable Trust, The Surdna Foundation, Susquehanna, Tiger Baron Foundation, Theatre Communications Group, Inc., John A. Vassilaros & Son, Inc., The Vervane Foundation, West Bank Cafe, The Wiener Family Foundation, Yorke Construction Corporation. In addition the following individuals made gifts of over \$150 this year (list is current as of 3/21/02)

Anonymous	Hannah Finn & John Wiltshire	Judy Kuhn & David Schwab	David & Anita Rogerson
Liliana Amador-Marty & Frank Marty	Billy Finnegan	Roger & Belle Kuhn	Clifford & Betsy Ross
Drew McCoy & Amy Aquino	Matt Williams & Angelina Fiordellisi	Lynn Landis	Daryl Roth
Mary Bacon & Andrew Leynse	Terry Fitzpatrick & Stephen Perrepelek	Allan & Nanette Larson	Alexander Roy
June Ballinger & Michael Goldstein	Alexa Fogel	Kate Lear & Jonathan LaPook	Shirley Rumierk
Talia Balsam & John Slattery	Katherine Foster	Courtney LeClaire-Conway	Steve Sabba
Ben Barenholtz	David Frankel	Willem Dafoe & Liz Lecompte	Laura Sametz
Benny Bartley	Eric & Juli Frankel	Becky & Steven Lewis	Tim & Lisa Sanford
Jessica Bauman	Naomi Freundlich & Charles Miles	James Waterston & Line Lillevik	Karin & Tom Schall
Laurie Becker & Rick Sweren	Louis & Patrice Friedman	Margo Lion	Beth Schneider
Meredith Beeuwkes	Victor Garber	Jessica Lissy	Maury Schott
Gregory Bello	Beth Gardiner	Adrienne Lobel & Mark Linn Baker	Whitney Scott & Peter Jacobson
Lisa Benavides & Tim Nelson	Jeanne Garofalo	Richard & Susan Lobel	Stefan Selig
Barry & Myrna Bernard	Rose Gasner & Larry Chertoff	Charles Loutrell	Jeffrey Sellar & Joshua Lehrer
Brian Swardstrom & Bonnie Bernstein	Jonathan Gazdak	John Lyons	Alyson Shapero
Alexander & Elizabeth Bernstein	Alexandra Gersten & John Vassilaros	Grace Lyu-VolckHausen	Aaron & Elaine Shapiro
Stephen Bernstein	Willie Reale & Jenny Gersten	Marsue & Peter MacNicol	Jonathan Sheffer
Vicky Bijur & Ed Levine	Jilian Cahan Gersten	Paul & Lauren Mandell	William Holtzman & S. Sylvia Shepard
Lewis Black	Ileen Getz & Mark Grinnell	Elizabeth Manne	Reed Birney & Connie Shulman
Tessa Blake	Nancy Giles	Peter Manning & André Bishop	Meg Simon
Mitchell Lemsky & Jane Bodle	Lloyd & Kilty Gilmour	Richard Marin	Abigail Rose Solomon
Jane Bolster & Steve Wertimer	Bob Glennon	Ali Marsh	Dr. David Solowiejczy
Buzz Bovshow	Judy Goldman & Michael Pillingier	Jesse L. Martin	José & Michelle Soto
Alan Braverman	Fred & Nancy Goodman	Dave & Alicia Matthews	James Neuberger & Helen Stambler
Kathy Briggs	Stephen & Cathy Graham	Paul Reale & Barbara McCrane	John Steber & Robert Shaffron
Becky Browder & Ted Neustadt	Connie Grappo & Lee Wilkof	James & Hannelore McDaniel	Fran McDormand & Joel Coen
Susan Bruce & Peter Hedges	Michael Greif & Jonathan Fried	Anne Meara & Jerry Stiller	Alan & Janis Menken
Peter Jay Fernandez & Denise Burse	Mary Grieco	Chia Messina	Audrey & Danny Meyer
Kate Burton & Michael Ritchie	Emily Grishman & Susan Sampliner	Dean Michaels	Nancy Meyer & Marc Weiss
Cora Cahan & Bernard Gersten	Lisa Gugenheim	Ross & Beth Moore	John Morning
Mitchell Semel & Colleen Carroll	Evan Handler	John Morning	Alfred H. Morris
Linda & Arthur Carter	Lynn E. Harris	Robin Morse & Gus Rogerson	Patricia M. Murphy, Esq. & Adam Spilka
Rachel Chanoff	Jane & Jonathan Heine	David Herdrich & Elizabeth Palmer Herdrich	Timothy Murtha & Elizabeth McDermott
Ellen Chenoweth	Amy Henkels	Lieta Hesen-Cohen & Richard Cohn	Tony Goldwyn & Jane Musky
Glenda Chesshir	David Herdrich & Elizabeth Palmer Herdrich	Geoffrey Nauffts	Geoffrey Nauffts
Marissa Chibas & Travis Preston	Lieta Hesen-Cohen & Richard Cohn	Pamela & Peter Nelson	Pamela & Peter Nelson
Richard Frankel & Kathleen Clark	Katy Homans & Patterson Sims	Ruth Nelson	Ruth Nelson
Jerome Cohen Congress	Caroline Hon	Mark Nesselson, M.D. & Elliott Rosenblum	Mark Nesselson, M.D. & Elliott Rosenblum
Elizabeth Cooper-Davis & Gordon Davis	Kate Hudson & Chris Robinson	Steven O'Neill	Steven O'Neill
Jace Alexander & Maddie Corman	Michelle Hurst	Carol Ochs & Bruce MacVittie	Carol Ochs & Bruce MacVittie
Margaret Crimmins	Virginia & Richard Irwin	Jacki Ochs & Jan Kroeze	Jacki Ochs & Jan Kroeze
Bill Wrubel & Jennifer Crittenden	Sy Jacobs	Paul & Maria Onderdonk	Paul & Maria Onderdonk
George & Cathy Crow	Linda Janklow	Greg MacPherson & Jane Perlmutter	Greg MacPherson & Jane Perlmutter
Cameron Crowe	Macon R. & Michael B. Jessop	Steven & Margot Peter	Steven & Margot Peter
Tom Cruise	Amanda Johns	Bat-Sheva & Thomas Peters	Bat-Sheva & Thomas Peters
Arthur Dantchik	Julia A. Johns	Peter & Ana Rosa Phillips	Peter & Ana Rosa Phillips
Cathy Dantchik	Andrea Johnson	Susan Ochs Phillips	Susan Ochs Phillips
Peter & Judith Dawkins	Traci Paige Johnson & Robert Mowen	Jeremy Posner	Jeremy Posner
Noël Dawkins	Cherry Jones & Mary O'Connor	Dean & Leslie Potashner	Dean & Leslie Potashner
Cameron Diaz	Larry & Mary Jones	Christopher Randolph	Christopher Randolph
Buddy Dikman & Chuck Davis	Maurice Kanbar	Peter & Helen Randolph	Peter & Helen Randolph
Edward & Joanne DiRuggeris	Lisa A. Kauffman	Alysia Reiner & David Basche	Alysia Reiner & David Basche
Jon Divis & Gene Reilly	Paul McCrane & Dana Kellin	Lucy E. Retan	Lucy E. Retan
Richard & Rebecca Dresser	Stephen & Sharon Kepniss	Loree Rodkin	Loree Rodkin
Mario Egozi	Seth & Beth Klarman		
Ned Eisenberg	Joana & Jason Klit		
Sophia & Gordon Elliott	Mary Kong		
Heidi Ettinger			
Barbara Ettinger & Sven Huseby			
Wendy Ettinger & Derek McLane			

## The 52nd Street Project presents the Winter 2002 Playmaking Production

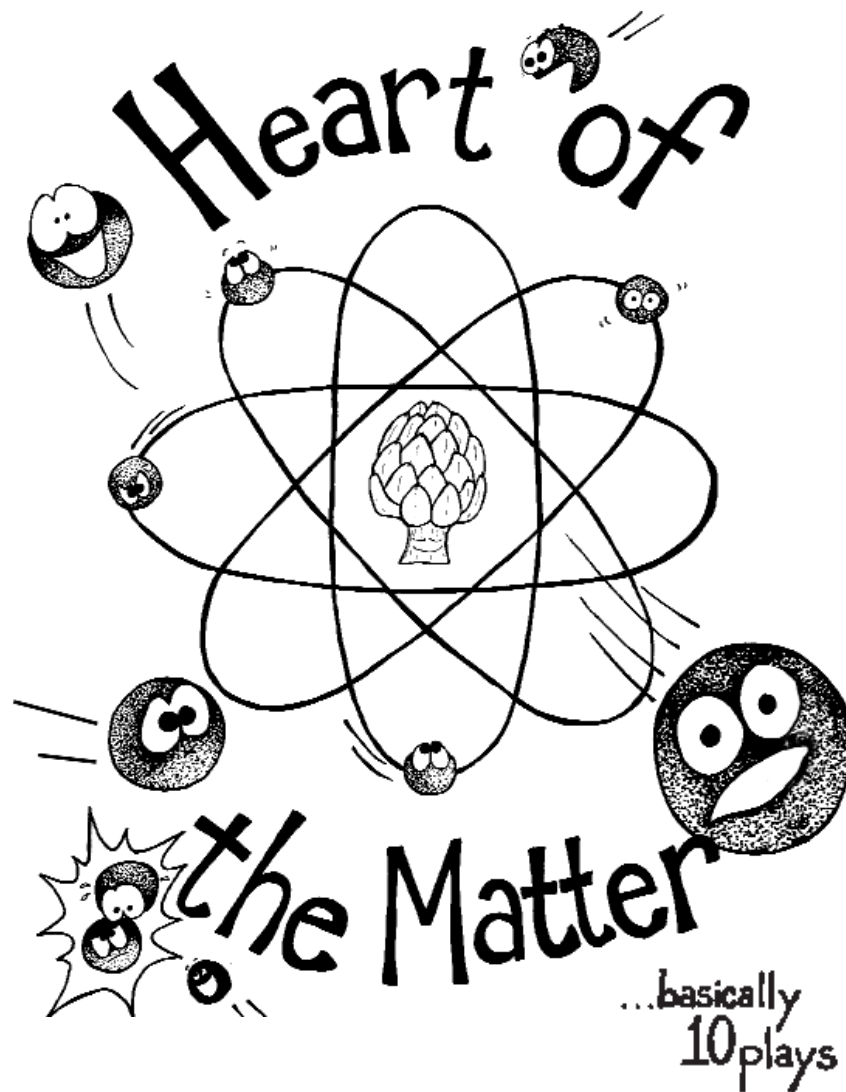

Fri., Mar., 22 at 7:30 p.m., Sat., Mar. 23 at 3:00 p.m. and 7:30 p.m.  
and Sun., Mar. 24 at 3:00 p.m.

**Theater at St. Clement's**  
423 West 46th St., New York City

# Heart of the Matter

The Winter 2002 Playmaking Plays: Mar. 22-24, Theater at St. Clement's

## The 52nd Street Project Staff:

Gus Rogerson, Artistic Director  
Carol Ochs, Executive Director  
Michael Bernard, Associate Artistic Director/Playmaking Director  
John Sheehy, Director of Development and Marketing  
George "X-Acto" Babiak, Production Manager  
Julie Feldman, Director of Education  
Megan Sandberg-Zakian, Volunteer Coordinator  
Chris Ceraso, Teen Dean  
Liz Bell, Education Assistant  
Diana Rojas, Executive Assistant  
Iris A. Brown, Graphic Designer  
Mayleen Cancel and Jayme Rosado, Receptionists  
Britta Jensen, Catherine Glenn, and Julia Walk Miller, Interns



## Production Staff

**Composer:** Rusty Magee  
**Set Designer:** Kevin Joseph Roach  
**Lighting Designer:** Greg MacPherson  
**Costume Designer:** Crystal Thompson  
**Costume Assistant:** Remy Pearce  
**Sound Designer:** Roger Raines  
**Stage Manager:** Karen Munkel  
**Slide Designers:**  
Katherine Lumb, Richard Hicks,  
Monty Nicol, Kim Snow,  
John Steward, Alberta Testanero,  
Iwona Waluk, George Babiak

## "Heart" Illustrations:

Heather Carnduff-Gobée

## Prop Design Team:

George Babiak, Liz Bell,  
Catherine Glenn, Britta Jensen, Amy  
Johnston, Cara Marcous, Julia Walk  
Miller, Karen Munkel, John Sheehy

## Furniture Crew:

Britta Jensen, Osage Lewis-Ashley,  
Joel Lind, Steven Vasquez

## Prop Crew:

Julia Walk Miller, Julie Gold,  
Ivana Granados

## Wall Props:

## Load-in and Light Hang Crew:

Mona Arriola, Britta Jensen,  
Moirra MacDonald, Julia Walk Miller,  
Karen Munkel, Chris Ryan,  
John Salzman, Jason Wells,  
Alistair Wandesforde-Smith

## House Managers:

Mary Pat Walsh,  
Susan McGinnis

## Hosts:

Stephen and Kathy Graham,  
Sam and Lynn Waterston,  
Liz and Paul Giamatti



NATIONAL  
ENDOWMENT  
FOR THE ARTS

The Playmaking Program is made possible with public funds from the National Endowment for the Arts; The New York State Council on the Arts, a state agency; the Department of Youth and Community Development; and the New York City Department of Cultural Affairs. The 52nd Street Project is a member of Art/NY and a participant in the New Generations Program, funded by Doris Duke Charitable Foundation/The Andrew W. Mellon Foundation and administered by Theatre Communications Group, the national organization for the American Theater.

State of the Arts



NYSCA

## COOL STUFF ON SALE IN THE LOBBY!

The Fabulous Flyer Bar . . . . . \$2.00 & \$1.50  
*and featuring Shel Silverstein's "Fivey and Twoey" logo:*  
Project Sweatshirts (NEW ITEM!) . . . . . \$20.00  
Project T-shirts, long sleeve . . . . . \$15.00  
Project Caps (NEW design) . . . . . \$15.00  
Project Mugs . . . . . \$5.00  
Project Pencil 3-pack (now in RED!) . . . . . \$1.00

Thank you for coming to **HEART OF THE MATTER**. If you are not on our mailing list (or if your address has changed), please fill out this form and give it to us on your way out or mail it to the address below. We would also like to know if you are interested in becoming a volunteer. We need help in **all areas**, so be sure to fill out the entire form.

### PLEASE ADD ME TO YOUR MAILING LIST:

03/02

NAME: \_\_\_\_\_

ADDRESS: \_\_\_\_\_

ZIP \_\_\_\_\_

HOME PHONE: \_\_\_\_\_

DAYTIME PHONE: \_\_\_\_\_

E-MAIL ADDRESS: \_\_\_\_\_

MY OCCUPATION: \_\_\_\_\_

MY HOBBIES: \_\_\_\_\_

### YES, I WOULD LIKE TO BE OF HELP. I CAN:

- |   |   |  |
|---|---|--|
| <input type="checkbox"/> Help load in and out for shows | <input type="checkbox"/> Draw and/or paint  | <input type="checkbox"/> Help kids with homework |
| <input type="checkbox"/> Hang lights                    | <input type="checkbox"/> Help with mailings | <input type="checkbox"/> Teach kids a skill      |
| <input type="checkbox"/> Work on a backstage crew       | <input type="checkbox"/> Do office work     | <input type="checkbox"/> Be a chef at an event   |
| <input type="checkbox"/> Do graphic design              | <input type="checkbox"/> Design sound       | <input type="checkbox"/> Design and sew costumes |
| <input type="checkbox"/> Other (please specify) _____   |   |  |

### MY SCHEDULE IS:

- Very flexible. I'm often available during weekdays.  
 Somewhat flexible. I can help on the occasional morning or afternoon during the week.  
 Not very flexible at all, but I've got some free time on evenings and weekends.

If you would like to mail this (and you're always welcome to enclose a tax-deductible contribution), you can send it to: **The 52nd Street Project**, 500 West 52nd St., New York, NY 10019. Or fax it to (212) 333-5598.

**Honorary Chairman Tom Cruise  
invites you to  
SAVE THE DATE & THE LAST DANCE  
MONDAY, MAY 13, 2002**



**STILL STAYIN' ALIVE**

**The 52nd Street Project's 20th Anniversary**

**DISCO BENEFIT**

**For information, call  
John "Dancin' Machine" Sheehy  
at (212) 333-5252**

The 52nd Street Project is a non-profit organization that brings children from the Hell's Kitchen neighborhood together with professional theater artists to create original theater. **HEART OF THE MATTER** is a production of our Playmaking program. Young people participate in an eight-week playwriting course taught by Michael Bernard and adapted for the Project by Daniel Judah Sklar from his book *Playmaking: Children Writing and Performing Their Own Plays*. At the end of the course, each child is given two actors, a theme, and a dramaturg/director who guides him or her through the writing of a play during a weekend retreat in the country (Kent, Connecticut, for this show). Tonight's performance is the end result.

---

**The 52nd Street Project Board of Directors**

Ben Barenholtz	Patricia M. Murphy, Esq.
Lisa Benavides	Carol Ochs
Rachel Chanoff	Willie Reale
Cathy Dantchik	Gus Rogerson
Noël Dawkins	Shirley Rumierk, <i>alumni member</i>
Wendy Ettinger, <i>chair emeritus</i>	José Soto, Jr., <i>alumni member</i>
Louis P. Friedman	Pamala Tyson
Stephen Graham, <i>chair</i>	Laura Valeroso
Larry Jones	Wendy vanden Heuvel
James McDaniel	John A. Vassilaros
Frances McDormand	Jenny Wiener

---

**Special Thanks**

We're grateful to Stephen and Cathy Graham for graciously allowing us to bring the chaos of a Playmaking weekend to their lovely home in Kent, Connecticut. Their staff, including Chef Eric and Jeannie, get a round of applause, too. Thanks also go to Sam and Lynn Waterston, and Liz and Paul Giamatti for providing overnight accommodations.

---

**In-Kind Contributions**

Ensemble Studio Theatre; Neil A. Mazzella and Hudson Scenic Studios; the Murphy Law Office; Iris A. Brown; Ron Kastner and Capital Printing; Big Apple Lights; Coleman; Noggin; The Printing Store; Scholastic, Inc.; Seagram's Chateau & Estate Wines; Shapiro & Lobel; Sesame Workshop; Watkins, Inc.; Mayor's Office of Film & Television; Boylan's Bottling Co.; David Sneddon & Fairway Market; Andy Millon; Steve Olsen & The Westbank Cafe; Lorraine Tobias & Imaginary Studios; Robert Goldberg and Yorke Construction; Jive Records, part of Zomba Music Group; Prime Films; and Cubic B's.

## HEART OF THE MATTER - ACT I

All original music composed by Rusty Magee

### Emotions

By Tiffany Paget, age 9. Dramaturg/Director: Megan Sandberg-Zakian  
Angel .....Angel Desai  
Jenny .....Rebecca White  
Other kids .....The Crew  
Bus Driver .....Osage Lewis-Ashley  
Miss Wonder .....Diana Rojas

*“Be Friends Forever”* lyrics by Tiffany Paget.

### Reddy’s Evil Plan

by Joshua Omana, age 10. Dramaturg/Director: Joe White

Reddy .....Dale Ho  
Jumpy .....Jonathan Goldblatt  
Bossy .....Kevin Geer

### On and Off

by Jazzlyn Hernandez, age 10. Dramaturg/Director: Peter Herdrich

Jessica Rodriguez .....Kaitlyn Kenney  
Julissa Cordero .....Karen Trott  
Partygoers .....The Crew

*“New Girl”* lyrics by Jazzlyn Hernandez

### A Football Player’s Dream

by John Cuevas, age 11. Dramaturg/Director: Marcella André

Tara Kwan .....Anna Li  
Jayson .....Jay Patterson  
Casper .....Joel Lind  
Bullies & Cheerleaders .....The Crew

*“A Song for an Angel”* lyrics by John Cuevas

### Cloudman and Sun vs. Meltman

by Chassity Damiani, age 10. Dramaturg/Director: Connie Grappo

Meltman .....Alex Draper  
Sun .....Femi Plimpton  
Cloudman .....John Sheehy  
Reporter/Dark Cat .....Catherine Glenn

*“Livin’ in Light”* lyrics by Chassity Damiani

👉 **Intermission!** 👈

## HEART OF THE MATTER - ACT II

### The Child Who Found His Mom

by Paul Dixon, age 11. Dramaturg/Director: Gus Rogerson

Tommy .....Kenajuan Bentley  
Carl .....Danyon Davis  
Tia .....Lenore Pemberton  
Security Guard .....Britta Jensen

### Chains of Love

By Megan Cruz, age 11. Dramaturg/Director: Liliana Amador

Dr. Pink .....Jennifer Ostrega  
Waitress .....Julia Walk Miller  
White Dove .....Stephanie Bast  
Robbers .....Joel Lind, Osage Lewis-Ashley, Steven Vasquez  
Love .....Catherine Glenn

*“Evil Pink”* and *“Girl Heroes”* lyrics by Megan Cruz

### The Fight Between Friends

by Caroline Rodriguez, age 11. Dramaturg/Director: Elizabeth Giamatti

Mac .....Kevin Geer  
Maranda .....Shirley Rumierk  
Team Captain .....Osage Lewis-Ashley

*“In My Tap Shoes”* lyrics by Caroline Rodriguez

### Let Me Stay

by Eddie Cuevas, age 12. Dramaturg/Director: Danny Goldstein

Greg .....David Grillo  
Barry .....Duane Boutté  
Claude .....Gus Rogerson  
Crowd .....The Crew  
Nurse .....Julie Gold

*“I Like Your House”* lyrics by Eddie Cuevas

### The Parrot and the Old House

by Christian Alvarez, age 11. Dramaturg/Director: Jace Alexander

Patty .....Maddie Corman  
Charles .....P.J. Brown  
T.V. Contest Announcer .....Gus Rogerson  
Danny Hamster .....John Sheehy  
Hollywood Man .....Michael Bernard

*“The Fat Cat”* and *“Charles and Me”* lyrics by Christian Alvarez

Corporate Hosts **Bear Stearns, Mosaic Entertainment, Tobak-Dantchik Events and Promotions** and the **Board of Directors of The 52nd Street Project** present



**BOARD CHAIR**

Stephen Graham

**ARTISTIC DIRECTOR EXECUTIVE DIRECTOR**

Gus Rogerson

Carol Ochs

## HONORARY CHAIR

Tom Cruise

## CO-CHAIRS

Lisa Benavides	Patrice Friedman
Becky Browder	Karin Schall
Cathy Dantchik	Laura Valeroso
Louis P. Friedman	Mary Pat Walsh
Jenny Wiener	

## THE BOARD OF DIRECTORS

Ben Barenholtz	Patricia M. Murphy, Esq.
Lisa Benavides	Carol Ochs
Rachel Chanoff	Willie Reale,
Cathy Dantchik	<i>founder</i>
Noël Dawkins	Gus Rogerson
Wendy Ettinger,	Shirley Rumierk
<i>chair emeritus</i>	José Soto, Jr.,
Louis P. Friedman	Pamala Tyson
Stephen Graham, <i>chair</i>	Laura Valeroso
Larry Jones	Wendy vanden Heuvel
James McDaniel	John Vassilaros
Frances McDormand	Jenny Wiener

### *The 52nd Street Project gratefully acknowledges...*

Giorgio Armani Parfums  
 Peter Contarino and Backstage Productions  
 Big Apple Lights  
 Iris A. Brown  
 Capital Printing/Ronald J. Kastner  
 Kenneth Cole Productions  
 Entertainment Weekly  
 Hudson Scenic Studios  
 Jive Records/A division of Zomba Music Group  
 Noggin  
 Kevin O'Shea and Jack Morton Williams, Inc.  
 The Post Factory  
 The Printing Store  
 Scholastic, Inc.  
 Diageo Chateau & Estate Wines Co.  
 Sesame Workshop  
 Wendy Stulberg  
 Ultimate Impressions  
 John A. Vassilaros & Sons  
 Watkins Incorporated  
*Healthier Living Since 1868*

## STILL STAYIN' ALIVE: THE SHOW THE ADULTS

Lewis Black, Kate Burton, Billy Crudup,  
 Peter Jay Fernandez, Peter Herdrich,  
 Michael Potts, Diana Rojas, Shirley Rumierk,  
 José Soto, Anne Torsiglieri and Karen Trott

### THE KIDS

Paul Dixon, Stephen Galimidi  
 and Suzette Santana

### LYRICS BY

Willie Reale

### MUSIC BY

Robert Reale

### DIRECTED BY

Jonathan Bernstein

### MUSIC DIRECTOR

Irwin Fisch

### WRITTEN BY

Willie Reale and John Sheehy

### DANCE CHOREOGRAPHER

Jeanne Simpson

### SET AND RIGGING CHOREOGRAPHER

Kevin Joseph Roach

### LIGHTING DESIGN

Greg MacPherson

### COSTUME DESIGN

Crystal Thompson

### SOUND DESIGN

Scott Lehrer

### STAGE MANAGER

Hank Meiman

### STILL STAYIN' ALIVE: THE FILM

Directed by Noël Dawkins and Wendy Ettinger

Edited by Tricia Cooke

Mixed by Dog Bark Sound

### FOAMCORE DESIGNS

George Babiak

### DISCO D.J.

Max Salpetrier

## THE HUSTLE TABLES

Bear Stearns  
 Arthur Dantchik  
 Cathy Dantchik  
 Patrice & Louis Friedman  
 Jenny Wiener & Jon Steingart,  
 Mosaic Entertainment  
 Jeffrey Yass

## THE ELECTRIC SLIDE TABLES

Wendy Ettinger & Derek McLane  
 Angelina Fiordellisi & Matt Williams  
 Cathy & Stephen Graham  
 Joanne Woodward & Paul Newman

## THE ROLLER BOOGIE TABLES

Vanessa Boeye & Ronald J. Kastner  
 Bob Boyett  
 Rachel Chanoff  
 Davis Polk & Wardwell  
 The Dawkins Family Foundation  
 Alexandra Gersten-Vassilaros &  
 Johnny Coffeeshopolis  
 Tricia & Mark Jacobs, Watkins Products  
 Fred Nelson, Entertainment Weekly  
 The New World Foundation  
 Ana Rosa & Peter Phillips  
 Jeremy M. Posner  
 Maury Schott  
 Laura Valeroso & David Seidman  
 Wendy vanden Heuvel  
 John & Ed Vassallo

## THE BUS STOP SEATS

Ben Barenholtz	Andrea L. Johnson
Tanya & Andrew Blackman, Shapiro & Lobel LLP	Traci Paige Johnson & Bob Mowen
Alfred C. Cerullo III Comedy Central	Elizabeth LeCompte & Willem Dafoe
Hyla & Rick Crane	John S. Lyons
Jennifer Crittendon & Bill Wrubel	Kay Matschullat & Allan Arffa
Rebecca & Richard Dresser	Fran McDormand & Pedro Coen
David Eigenberg Endeavor	Jane Musky & Tony Goldwyn
Nora Ephron	Sara & Don Nelson
Tom Feeney & Paul Parzuchowski	Jane Perlmutter & Greg MacPherson
Frank Frattaroli	Leslie & Dean Potashner
Janeane Garofalo	Linda & Hal Ritch
Jenny Gersten & Willie Reale	Anita A. & David S. Rogerson
Elizabeth & Paul Giamatti	Steve Sabba
Michael Greif & Jonathan Fried	Leslie Schine & Nils Nilsen
Lisa J. Gugenheim	Daniel Swee
Nyree Hartman & Mark Saad	Karen Trott & Peter Herdrich
Dana Ivey	Wendy Wasserstein
	Mary Lin & Jim Yoshimura



## THE BUMP SEATS

Joanne Akalaitis Alexis Alexanian Amazon Pixels Alice A. Arana	Judy Goldman & Michael Pillinger Robyn Goodman
Cecilia Arana-Grant & Kevin Grant Lucie Arnaz & Larry Luckinbill	Lizzie Gottlieb & Michael Young Flavia Grimm
June Ballinger & Michael Goldstein Talia Balsam & John Slattery	Jane & Jonathan Heine Kathy Hiler & Daniel Jenkins
Arija Bareikis Benny Bartley Terry Belanger Stephen Bernstein	Katheryn Holt & Kirk Citron Katy Homans & Patterson Sims
Vicky Bijur & Ed Levine Jane Bolster & Steve Wertimer	Matt Houston Amanda Johns Marcy & Max Kahn
Kathy Borowitz & John Turturro Buzz Bovshow Julie Boyd	Eric Karpeles & Mike Sell Evelyn Kenvin & Arthur Rosenbloom
Becky Browder & Ted Neustadt Susan Bruce & Peter Hedges	Woodie King, Jr. Judy Kuhn & David Schwab
Denise Burse & Peter Jay Fernandez	Jill Larson Nanette & Allan Larson
Alison Fraser & Rusty Magee & Nat Magee	Kate Lear & Jonathan LaPook Warren Leight Mickey Lemle Liza Lerner
Cora Cahan & Bernard Gersten Camilla Campbell & Oliver Platt	Aimee Levine Josh Lewis Anna Antonia Li Linda Li
Colleen Carroll & Mitchell Semel Phoebe Cates & Kevin Kline	Vince Liebhart Jessica Lissy Adrienne Lobel & Mark Linn-Baker
Sharon Chantiles Glenda Chesshir Darrah Cloud & Dave Owens	Barry Lee Mackall Wendy Makkena & Bob Krakower
Ruth Cohen David Copeland Maddie Corman & Jace Alexander	Sonya Martin John Matoian George Mayer Brigid McCarthy
Catherine Corpeny & Max D. Mayer Margaret Crimmins Peter Cross	Sandra McClain Barbara McCrane & Paul Reale
Anna E. Crouse Emily Crow	Jerry McGill Rick Meese Danny Meisner
Catherine Curtin & Randy Myler Georgia & Billy Delano	Josie Merck & James Stevenson Bob Morris Meg Mortimer
Stephen V. DeRosa Dramatists Play Service	Suzen Murakoshi & Mark Temme
Moira Driscoll & David Pence Christine Dunn & Steve Callahan	Patricia Murphy & Adam Spilka Dr. Mark Nesselson & Elliot Rosenblum
Patricia Dunnock & Ned Eisenberg	Ricarda O'Connor Lori O'Connor
Karen & Christopher Eddowes Mario Egozi	Carol Ochs & Bruce MacVittie Jacki Ochs & Jan Kroeze
Josephine Eke & Jason Valk Beth Emelson Martin Ross Fetner	Susan Ochs Phillips Lu Ann S. & William M. Polk
Anita Flanagan Alexa L. Fogel	Christopher Randolph Theresa Rebeck & Jess Lynn
Deborah Freedman & Bill Woods Katherine Freedman & Brian Beirne	Alysia Reiner & David Alan Basche
Rose Gasner & Larry Chertoff Jilian Cahan Gersten	LaTanya R. Richardson & Samuel L. Jackson
Ileen Getz & Mark Grinnell Toni Giamatti	Daryl Roth Martha Roth & Bill Irwin
Nancy Giles Kilty & Lloyd Gilmour	Esther & Stan Royce



PHOTOS BY WENDY STULBERG

Caroline Ryan Laura Sametz Zeborah Schachtel Karin & Thomas Schall Mary Anne & Ken Schuster Richard Schwartz	Paola Styron Susanna Styron & Darrell Larson Mariko Tada Crystal Thompson & Chris Ryan Edith Thurber & Kevin O'Rourke Suzanne Tobak
Whitney Scott & Peter Jacobson Dana Segal & Andrew Hurwitz Stefan M. Selig Sylvia Shepard & Willy Holtzman	Lorraine Tobias & Alex Draper Liz Tuccillo Susan J. Vitucci Mary Pat Walsh Mildred & Borah Walton
Kim D. Sherman Abby Sigal Meg Simon Landon Slane Lois Smith	Maja Wampuszyc Anita Waxman Anne Weiss Carol Whitesides Elizabeth Williams & Joseph Forte
Abigail Rose Solomon Frank Sposato Erena Stennett Sara & David Stone	Ellis Williams Hannah & Andy Wolk Yildiz Yuksek & Richard Blackstone
Abbott Stranahan & David Ward Lynn Street & Donald Margulies	Ginger Zakian & Bob Sandberg

List current as of 5/8/02

## THE 52ND STREET PROJECT STAFF

Gus Rogerson, Artistic Director  
 Carol Ochs, Executive Director  
 Michael Bernard, Associate Artistic Director  
 John Sheehy, Director of Development and Marketing  
 George Babiak, Production Manager  
 Julie Feldman-Abe, Director of Education  
 Megan Sandberg-Zakian, Volunteer Coordinator  
 Chris Ceraso, Teen Dean  
 Liz Bell, Education Assistant  
 Diana Rojas, Executive Assistant  
 Iris A. Brown, Graphic Designer  
 Catherine Glenn, Britta Jensen,  
 Julia Walk Miller; Interns

## BENEFIT VOLUNTEERS

Heather Carnduff-Gobbée, Tim Gallagher,  
 Martin Gobbée, Dale Ho,  
 Doug Lockwood, Perry McBain Daniel,  
 Susan McGinnis, Chris Ryan,  
 Vanessa Valdes

## SPECIAL THANKS

Willem Dafoe, Beth Emelson,  
 Jenny Gersten, Joe Mihalow,  
 Hank Rogerson, Karin Schall,  
 Jilann Spitzmiller, Mary Pat Walsh

LAYOUT BY GEORGE BABIAK

The 52nd Street Project gratefully acknowledges the support of the following foundations and corporations: Barker Welfare Foundation, The Barnsley Foundation, Capital Research Company, Carnegie Corporation of New York, Comedy Central, Consolidated Edison, The Dammann Fund, Davis Polk & Wardwell, The Dramatists Guild Fund, Dramatists Play Service, Eleanor, Adam & Mel Dubin Foundation, The Educational Foundation Of America, Entertainment Weekly, Ford Foundation, The J. Paul Getty Trust, The Horace W. Goldsmith Foundation, The Hennessy Foundation, Holland Lodge Foundation, Hudson Scenic Studio, Betty E. & George B. Kaiser Foundation, Rita J. and Stanley H. Kaplan Foundation, Lloyds TSB Bank, Lucille Lortel Foundation, Lucent Technologies, Mellon Bank, Helen Merrill, The Cynthia & George Mitchell Foundation, J.P. Morgan Charitable Trust, The National Board of Review, Newman's Own, The New World Foundation, The New York Times, Paramount Pictures, Laura Pels Foundation, Roulette Entertainment, The Fan Fox & Leslie R. Samuels Foundation, Staging and Design, The Surdna Foundation, Susquehanna Partners, Theatre Communications Group, The Vervane Foundation, West Bank Cafe, Yorke Construction Corp., Felix Zaremba & Co. Inc. (List current as of 7/24/02)

Robert Abrams & Cynthia Vance  
 Jace Alexander & Maddie Corman  
 Cecilia Arana-Grant & Kevin Grant  
 Lucie Amaz & Laurence Luckinbill  
 Debbon Ayer  
 Mary Bacon & Andrew Leynse  
 June Ballinger & Michael Goldstein  
 Ben Barenholtz  
 Benny Bartley  
 Jessica Bauman  
 Laurie Becker & Rick Sweren  
 Meredith Beeuwkes  
 Gregory Bello  
 Lisa Benavides & Tim Nelson  
 Barry & Myma Bernard  
 Alexander & Elizabeth Bernstein  
 Stephen Bernstein  
 Vicky Bijur & Ed Levine  
 Reed Birney & Connie Shulman  
 Lewis Black  
 Jeanette & Samuel Black  
 Richard Blackstone & Yldeez Yuksek  
 Tessa Blake  
 Buzz Boyshov  
 Bob Boyett  
 Alan Braverman  
 Kathy Briggs  
 Becky Browder & Ted Neustadt  
 Susan Bruce & Peter Hedges  
 Kate Burton & Michael Ritchie  
 Linda & Arthur Carter  
 Alfred C. Cerullo III  
 Rachel Chanoff  
 Sharon Chantile  
 Ellen Chenoweth  
 Glenda Chesshir  
 Marissa & Travis Chibas  
 Kirk & Katherine Holt Citron  
 Darah Cloud & Dave Owens  
 Ethan Coen & Trish Cooke  
 Ruth Cohen  
 Jerome Cohen Congress  
 Lieta Hesen-Cohen & Richard Cohn  
 David Copeland  
 Hyla & Richard Crane  
 Margaret Cimmins  
 George & Cathy Crow  
 Cameron Crowe  
 Stephen & Sandra Crudgington  
 Tom Cruise  
 Catherine Curtin  
 Willem Dafoe & Liz Lecompte  
 Arthur Dantchik  
 Cathy Dantchik  
 Peter & Judith Dawkins  
 Georgia & William Delano  
 Jonathan Demme  
 Buddy Dikman & Chuck Davis  
 Edward & Joanne DiRugieris  
 Jon Divis & Gene Reilly  
 Richard & Rebecca Dresser  
 Moira & David Driscoll  
 Christopher & Karen Eddowes  
 Mario Egozi  
 David Eigenberg  
 Ned Eisenberg & Patricia Dunnock  
 Nora Ephron  
 Barbara Ettinger & Sven Huseby  
 Barbara Ettinger  
 Heidi Ettinger  
 Wendy Ettinger & Derek McLane  
 Tom Feeney & Paul Parzuchowski  
 Adam Felber & Jeanne Simpson  
 Peter Jay Fernandez & Denise Burse  
 Martin Ross Fetner  
 Hannah Finn & John Wiltshire  
 Billy Finnegan  
 Angelina Fiordellisi  
 Terry Fitzpatrick & Stephen Perpeluk  
 Anita Flanagan & Jeff Potter

Alexa Fogel  
 David Frankel  
 Eric & Juli Frankel  
 Richard Frankel & Kathleen Clark  
 Frank Frattaroli  
 Katherine Freedman  
 Naomi Freundlich & Charles Miles  
 Louis & Patrice Friedman  
 Victor Garber  
 Janeane Garofalo  
 Rose Gasner & Larry Chertoff  
 Joseph & Margaret Gazdak  
 Cora Cahan & Bernard Gersten  
 Jillian Cahan Gersten  
 Ileen Getz & Mark Grinnell  
 Paul & Elizabeth Giamatti  
 Nancy Giles  
 Lloyd & Kilty Gilmour  
 Bob Glennon  
 Bryan Gmitter  
 Judy Goldman & Michael Pillingner  
 Wendy Goldman  
 Tony Goldwyn & Jane Musky  
 Fred & Nancy Goodman  
 Stephen & Cathy Graham  
 Connie Grappo & Lee Wilkof  
 Michael Greif & Jonathan Fried  
 Mary Grieco  
 Emily Grishman & Susan Sampliner  
 Lisa Lugenheim  
 Mark & Valerie Hadjipateras  
 James A. Macdonald Foundation  
 Evan Handler  
 Lynn E. Harris  
 Jane & Jonathan Heine  
 Amy Henkels  
 David Herdrich & Elizabeth Palmer  
 Herdrich  
 Peter Herdrich & Karen Trott  
 William Holtzman & S. Sylvia Shepard  
 Katy Homans & Patterson Sims  
 Barbara Howard  
 Kate Hudson & Chris Robinson  
 Michelle Hurst  
 Dana Ivey  
 Mark Evan Jacobs  
 Sy Jacobs  
 Whitney Scott & Peter Jacobson  
 Linda LeRoy Janklow  
 Macon R. & Michael B. Jessop  
 Amanda Johns  
 Julia A. Johns  
 Andrea Johnson  
 Traci Paige Johnson & Robert Mowen  
 Cherry Jones & Mary O'Connor  
 Larry & Mary Jones  
 Marcy & Max Kahn  
 Maurice Kanbar  
 Eric Karpeles & Mike Sell  
 Ronald Kastner & Vanessa Boeys  
 Lisa A. Kauffman  
 Stephen & Sharon Kepniss  
 Seth & Beth Klarman  
 Alan & Kathryn Klingenstein  
 Joana & Jason Klot  
 Mary Kong  
 Judy Kuhn & David Schwab  
 Roger & Belle Kuhn  
 Lynn Landis  
 Mark Lanow & Joanne Astrow  
 Allan & Nanette Larson  
 Jill Larson  
 Michael P. Lawrence  
 Kate Lear & Jonathan LaPook  
 Mary Ann Lefort  
 Howard Leifman  
 Warren Leight  
 Mitchell Lemsky & Jane Bodle  
 Liza Lerner  
 Becky & Steven Lewis

Joshua Lewis  
 Anna Li  
 Linda Li  
 Mark Linn-Baker & Adrienne Lobel  
 Margo Lion  
 Jessica Lissy  
 Adrienne Lobel & Mark Linn Baker  
 Richard & Susan Lobel  
 John Lyons  
 Grace Lyu-Volkhausen  
 Barry Mackall & Bill Schwinghammer  
 Marsue & Peter MacNicol  
 Greg MacPherson & Jane Perlmutter  
 Rusty Magee & Alison Fraser  
 Wendy Makkena & Bob Krakower  
 Paul & Lauren Mandell  
 Elizabeth Manne  
 Peter Manning & André Bishop  
 Donald Margulies & Lynn Street  
 Richard Marin  
 Ali Marsh  
 Jesse L. Martin  
 Kay Matschullat & Allan Arfa  
 Dave & Alicia Matthews  
 Stephen & Cathy Graham  
 Brigid McCarthy  
 Michael Greif & Jonathan Fried  
 Paul McCrane & Dana Kellan  
 Fran McDormand & Joel Coen  
 William Michael McMahon & Meg  
 McMahon  
 Rick Meese & Dan Lori  
 Richard & Denise Menelly  
 Lynn E. Harris  
 Jane & Jonathan Heine  
 Amy Henkels  
 David Herdrich & Elizabeth Palmer  
 Herdrich  
 Peter Herdrich & Karen Trott  
 William Holtzman & S. Sylvia Shepard  
 Katy Homans & Patterson Sims  
 Barbara Howard  
 Kate Hudson & Chris Robinson  
 Michelle Hurst  
 Dana Ivey  
 Mark Evan Jacobs  
 Sy Jacobs  
 Whitney Scott & Peter Jacobson  
 Linda LeRoy Janklow  
 Macon R. & Michael B. Jessop  
 Amanda Johns  
 Julia A. Johns  
 Andrea Johnson  
 Traci Paige Johnson & Robert Mowen  
 Cherry Jones & Mary O'Connor  
 Larry & Mary Jones  
 Marcy & Max Kahn  
 Maurice Kanbar  
 Eric Karpeles & Mike Sell  
 Ronald Kastner & Vanessa Boeys  
 Lisa A. Kauffman  
 Stephen & Sharon Kepniss  
 Seth & Beth Klarman  
 Alan & Kathryn Klingenstein  
 Joana & Jason Klot  
 Mary Kong  
 Judy Kuhn & David Schwab  
 Roger & Belle Kuhn  
 Lynn Landis  
 Mark Lanow & Joanne Astrow  
 Allan & Nanette Larson  
 Jill Larson  
 Michael P. Lawrence  
 Kate Lear & Jonathan LaPook  
 Mary Ann Lefort  
 Howard Leifman  
 Warren Leight  
 Mitchell Lemsky & Jane Bodle  
 Liza Lerner  
 Becky & Steven Lewis

Herald & Linda Ritch  
 Loree Rodkin  
 David & Anita Rogerson  
 Robin Morse & Gus Rogerson  
 Clifford & Betsy Ross  
 Gaylen Ross  
 Daryl Roth  
 Alexander Roy  
 Mark Saad  
 Steve Sabba  
 Laura Sametz  
 Tim & Lisa Sanford  
 Zeborah Schachtel  
 Stacey Schaffer & Eric Schwartz  
 Karin & Tom Schall  
 Leslie Schine & Nils Nilsen  
 Beth Schneider  
 Maury Schott  
 Ken & Mary Ann Schuster  
 Stefan Selig  
 Jeffrey Seller & Joshua Lehrer  
 Mitchell Semel & Colleen Carroll  
 Alyson Shapero  
 Aaron & Elaine Shapiro  
 Jonathan Sheffer  
 Abby Jo Sigal & Matt Turner  
 Meg Simon  
 Landon Slane  
 Talia Balsam & John Slattery  
 Lois Smith  
 Phillip K. & Gloria W. Smith  
 Abigail Rose Solomon  
 Dr. David Solowiejczyk  
 John Steber & Robert Shaffron  
 Jean Stein  
 Ben & Christine Stiller  
 David & Sara Stone  
 Abby Stranahan & Dave Ward  
 Susanna Styron & Darrell Larson  
 Brian Swardstrom  
 & Bonnie Bernstein  
 John Morning  
 Bob Morris  
 Meg Mortimer  
 Suzen Murakoshi  
 Patricia M. Murphy, Esq. & Adam Spilka  
 Timothy Murtha & Elizabeth McDermott  
 Heather & Eileen Nash  
 Don & Sara Nelson  
 Pamela & Peter Nelson  
 Randy & Rona Nelson  
 Ruth Nelson  
 Mark Nesselson, M.D. & Elliott  
 Rosenblum  
 James Neuberger & Helen Stambler  
 Ricarda O'Connor & Michael Ottavi  
 Lori O'Connor  
 Steven O'Neill  
 Kevin O'Rourke & Edith Thurber  
 Carol Ochs & Bruce MacVittie  
 Jacki Ochs & Jan Kroeze  
 Paul & Maria Onderdonk  
 Steven & Margot Peter  
 Elizabeth Peters  
 Bat-Sheva & Thomas Peters  
 Peter & Ana Rosa Phillips  
 Susan Ochs Phillips  
 Oliver Platt & Camilla Campbell Platt  
 Richard Potatchek  
 Jeremy Posner  
 Dean & Leslie Potashner  
 Michael Potts  
 Gigi Pritzker Pucker & Michael Pucker  
 Christopher Randolph  
 Peter & Helen Randolph  
 Paul Reale & Barbara McCrane  
 Willie Reale & Jenny Gersten  
 Theresa Rebeck & Jess Lynn  
 Alysia Reiner & David Basche  
 Lucy E. Retan

The 52nd Street Project presents  
 The 2002 Harold and Mimi Steinberg Charitable Trust One-on-Ones

# TEN FOR THE ROAD: THE TRAVELING PLAYS

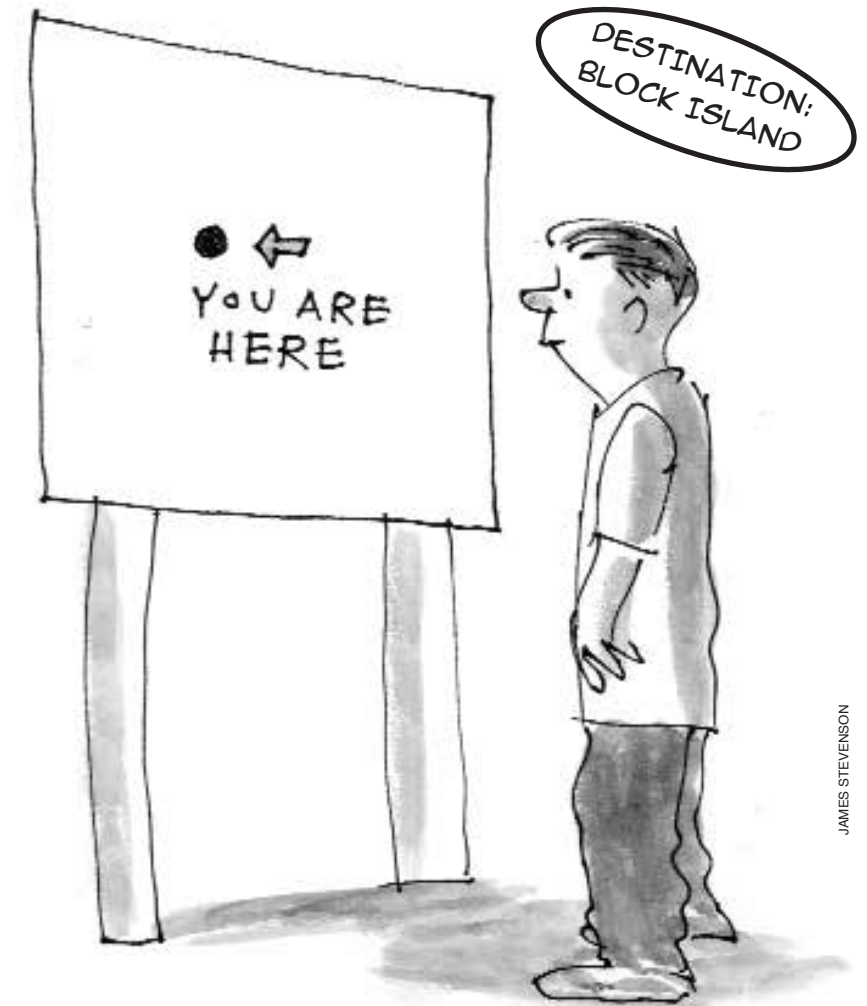

JAMES STEVENSON

JULY 25-28, 2002  
 THE ENSEMBLE STUDIO THEATRE  
 549 WEST 52ND ST., NEW YORK CITY



# TEN FOR THE ROAD: THE TRAVELING PLAYS

The 2002 Block Island  
One-on-Ones  
July 25-28  
The Ensemble Studio Theatre

## The 52nd Street Project Staff:

Gus Rogerson, Artistic Director  
Carol Ochs, Executive Director  
John Sheehy, Director of Development and Marketing  
Megan Sandberg-Zakian, Associate Artistic Director  
George "X-Acto" Babiak, Production Manager  
Liz Bell, Director of Education  
Diana Rojas, Executive Assistant  
Chris Ceraso, Teen Dean  
Iris A. Brown, Graphic Designer  
Mayleen Cancel and Zsuzsa Mysak, Receptionists  
Interns: Conor Fetting-Smith, Charlotte Howard, Beth McMahon

## Production Staff

**Composer:** Kim D. Sherman  
**Set Designer:** Kevin Joseph Roach  
**Lighting Designer:** Abigail Felder  
**Asst. Lighting Designer:**  
Kelly Blackwell  
**Costume Designer:** Janet Edwards  
**Costume Assistant:** Lee Harper  
**Sound Designer:** Vanessa Valdes  
**Stage Manager:** Perry McBain-Daniel  
**Slide Design Team:**  
Katherine Lumb, Monty Nicol, Kim  
Snow, John Steward, Iwona Waluk  
**Prop Design Team:**  
George Babiak, Stephanie Bast,  
Heather Carnduff, Monique Curnen,  
Conor Fetting-Smith, Charlotte  
Howard, Beth McMahon, Rick  
Meese, Niambi Nataki, Rachel  
Schroeder, John Sheehy

## Flyer/Program Illustrations:

James Stevenson

## Furniture Crew:

Conor Fetting-Smith, Adalberto  
Rodriguez, Johnathan "Big J" Roldan

## Prop Crew:

Charlotte Howard, Jennifer Jimenez,  
Beth McMahon

## Load-in and Light-hang Crew:

Conor Fetting-Smith, Charlotte  
Howard, Beth McMahon, Tim  
Gallagher, Noel Polanco, Tom Schall

## House Managers:

Liz Bell, Karin Schall, Mary Pat Walsh

## Chefs:

Pat McQuade and Martha Velie-Gass

## Teen Counselor:

Jennifer Jimenez



NATIONAL  
ENDOWMENT  
FOR THE ARTS

The One-on-Ones Program is made possible with public funds from the National Endowment for the Arts; The New York State Council on the Arts, a state agency; the Department of Youth and Community Development; and the New York City Department of Cultural Affairs. The 52nd Street Project is a member of Art/NY and a participant in the New Generations Program, funded by Doris Duke Charitable Foundation/The Andrew W. Mellon Foundation and administered by Theatre Communications Group, the national organization for the American Theater.

State of the Arts



NYSCA

# COOL STUFF ON SALE IN THE LOBBY!

The Fabulous Flyer Bar . . . . . \$2.00 & \$1.50  
and featuring Shel Silverstein's "Fivey and Twoey" logo:  
Project T-shirts . . . . . \$12.00  
Project Tank Tops . . . . . \$12.00  
Project Caps (NEW design) . . . . . \$15.00  
Project Mugs (now in BLUE!) . . . . . \$5.00  
Project Pencil 3-pack (now in RED!) . . . . . \$1.00

Thank you for coming to **TEN FOR THE ROAD!** If you are not on our mailing list (or if your address has changed), please fill out this form and give it to us on your way out or mail it to the address below. We would also like to know if you are interested in becoming a volunteer. We need help in **all areas**, so be sure to fill out the entire form.

## PLEASE ADD ME TO YOUR MAILING LIST:

7/02

NAME: \_\_\_\_\_

ADDRESS: \_\_\_\_\_

ZIP \_\_\_\_\_

HOME PHONE: \_\_\_\_\_

DAYTIME PHONE: \_\_\_\_\_

E-MAIL ADDRESS: \_\_\_\_\_

MY OCCUPATION: \_\_\_\_\_

MY HOBBIES: \_\_\_\_\_

## YES, I WOULD LIKE TO BE OF HELP. I CAN:

- |   |   |  |
|---|---|--|
| <input type="checkbox"/> Help load in and out for shows | <input type="checkbox"/> Draw and/or paint  | <input type="checkbox"/> Help kids with homework |
| <input type="checkbox"/> Hang lights                    | <input type="checkbox"/> Help with mailings | <input type="checkbox"/> Teach kids a skill      |
| <input type="checkbox"/> Work on a backstage crew       | <input type="checkbox"/> Do office work     | <input type="checkbox"/> Be a chef at an event   |
| <input type="checkbox"/> Do graphic design              | <input type="checkbox"/> Design sound       | <input type="checkbox"/> Design and sew costumes |
| <input type="checkbox"/> Other (please specify) _____   |   |  |

## MY SCHEDULE IS:

- Very flexible. I'm often available during weekdays.  
 Somewhat flexible. I can help on the occasional morning or afternoon during the week.  
 Not very flexible at all, but I've got some free time on evenings and weekends.

If you would like to mail this (and you're always welcome to enclose a tax-deductible contribution), you can send it to: **The 52nd Street Project**, 500 West 52nd St., New York, NY 10019. Or fax it to (212) 333-5598.

## Don't Miss Our Upcoming Shows!

### TEN MORE FOR THE ROAD



THE SECOND OUTING OF THE 2002 ONE-ON-ONES  
AUGUST 22-25 RIGHT HERE AT E.S.T.  
SAME GREAT THEME, BUT WITH NEW KIDS,  
NEW ADULTS, AND ALL-NEW PLAYS.

## **PLAYBACK**

November, 2002

First a kid writes a short play. Then, an adult writes an "answer" play. Then, the two of them perform both plays. Multiply this equation by seven and you've got an entire show.



December, 2002

In September, 10 kids brand-new to the Project will begin a Playmaking class taught by Project Playmaking Director Megan Sandberg-Zakian. Come and see their final plays performed by adult professional actors.

The 52nd Street Project is a non-profit organization that brings children from the Hell's Kitchen neighborhood together with professional theater artists to create original theater. **TEN FOR THE ROAD** is a production of our One-on-One program, which is designed to give children the opportunity to go away for one-week stays in the country and enjoy the undivided attention of a professional theater artist who serves as friend, mentor, and collaborator. The Project is delighted to return to the Ensemble Studio Theatre, where we have been performing since our inception in 1981. We gratefully acknowledge the fact that if E.S.T. wasn't here, we'd be nowhere.

### The 52nd Street Project Board of Directors

Ben Barenholtz

Lisa Benavides

Rachel Chanoff

Cathy Dantchik

Noël Dawkins

Wendy Ettinger, *chair emeritus*

Louis P. Friedman

Stephen Graham, *chair*

Larry Jones

James McDaniel

Frances McDormand

Patricia M. Murphy, Esq.

Carol Ochs

Willie Reale, *founder*

Gus Rogerson

Shirley Rumierk, *alumni member*

José Soto, Jr., *alumni member*

Pamala Tyson

Laura Valeroso

Wendy vanden Heuvel

John A. Vassilaros

Jenny Wiener

### Special Thanks

Our Host Families – Pat McQuade & Martha Velie-Gass; Josie Merck & Jim Stevenson; Eliot & Amy Nerenberg; Jennifer & Elliot Taubman; Diane Trippler & Don Frageau; Ron, Judy & Kevin Tierney; Joya Verde & Anthony & Nicole Frye & Virginia Dare; Thomas Frye and our headquarters host Dr. Christina Biaggi. Sincere thanks also go to Lynn Reale, Kate & Harold at Block Island Realty; Prudy & The Ice Cream Place; Rita & Steve Draper; Jane Muskey & Tony Goldwyn ; Glenn & Annie Hall; McQuade's Market; Interstate Navigation; Sophia Ochs MacVittie; Jenny Ritter; Amanda Gass; Kirk Littlefield; Joe and Pat at Smuggler's Cove Sailing School; Finns, Block Island Grocery.

### In-Kind Contributions

Curt, Jamie, Suzanne, Carl, Tim, and everyone at the Ensemble Studio Theatre; Neil A. Mazzella and Hudson Scenic Studios; the Murphy Law Office; Iris A. Brown; Ron Kastner and Capital Printing; Big Apple Lights; Coleman; Noggin; The Printing Store; Scholastic, Inc.; Diageo Chateau & Estate Wines; Sesame Workshop; Watkins, Inc.; Mayor's Office of Film & Television; Boylan's Bottling Co.; David Sneddon & Fairway Market; Andy Millon; Steve Olsen & The Westbank Cafe; Lorraine Tobias & Imaginary Studios; Robert Goldberg and Yorke Construction; Jive Records, part of Zomba Music Group; and Prime Films.

## TEN FOR THE ROAD – ACT I

All original music composed by Kim D. Sherman  
“Ten for the Road Theme Song” lyrics by John Sheehy

### SHERMIE THE WORMIE

Written by Michael Bernard & Directed by Jessalyn Gilsig  
for Jazzy Hernandez, age 11

Shermie .....Jazzy Hernandez  
Purdy .....Jessalyn Gilsig

*“The Song of Shermie” & “Birds & Worms”* by Michael Bernard

### A THING FOR ISLANDS

Written by Julie McKee & Directed by Susan McGinnis  
for Leah Galimidi, age 14

Sharon .....Susan McGinnis  
Leilani .....Leah Galimidi  
Pilot’s Voice .....Jennifer Jimenez  
Radio Announcer .....John Sheehy

*“State Song”* by Julie McKee & Susan Vitucci; *“Real Hawaii”* by Julie McKee

### J’AI PEUR ... MOI AUSSI

Written by David Schwab & Directed by Carlo Alban  
for Anthony Mejia, age 12

Bellhop .....Anthony Mejia  
George .....Carlo Alban  
Iguana .....Beth McMahon

*“I’m Afraid So” & “Feel Your Fear”* by John Sheehy

### HAPPY TRAILS

Written by Jim Stevenson & Directed by Niambi Nataki  
for Suzette Santana, age 11

Marilyn .....Suzette Santana  
Angelica’s Mom .....Diana Rojas  
Angelica .....Jennifer Jimenez  
Sundown .....Niambi Nataki

*“Teddy Bear Blues” & “Friend Around the Bend”* by Jim Stevenson

### HAVING SEEN THE LIGHT

Written by Willie Reale & Directed by Kenajuan Bentley  
for Kimani Lewis-Ashley, age 12

Heathcliff .....Kimani Lewis-Ashley  
Norbert .....Kenajuan Bentley

*“Shooting the Breeze in Limbo”* by Willie Reale

 **Intermission!** 

## TEN FOR THE ROAD – ACT II

### BIRTH OF A SALESMAN

Written By Susan Kim & Directed by Stephanie Bast  
for Solangee Acosta, age 13

Jessica .....Solangee Acosta  
Apartment voices .....Crew  
Rozonda .....Stephanie Bast  
Betty Faye .....Diana Rojas

*“The Sell Spiel”* by John Sheehy

### DEEP TROUBLE

Written & Directed by George Babiak  
for Alex Tomas, age 11

Sandy Shortz .....Beth McMahon  
Fin Harper .....George Babiak  
Johnny Ramos .....Alex Tomas  
The Visitor .....Charlotte Howard

*“The Deep, Deep Blues”* by George Babiak

### BAGGAGE

Written & Directed by Doug Lockwood  
for Megan Cruz, age 11

Jana, Rocket LaVoom,  
Toots McKenzie, and Connie Caboose .....Megan Cruz  
Swiftly LaVoom .....Doug Lockwood  
Announcer .....John Sheehy  
Two Bad Kids .....Jennifer Jimenez, Diana Rojas  
Lita .....Jennifer Jimenez

*“Unpack”* by Doug Lockwood & John Sheehy

### COFFEE, TEA OR MY LEFT FOOT

Written by John Sheehy & Directed by Monique Curnen  
for Tiffany Paget, age 10

Krissy .....Tiffany Paget  
Helga .....Monique Curnen

*“Having a Friend”* by John Sheehy

### STILL WAITING FOR ...

Written by Bruce MacVittie & Directed by David Costabile  
for Stephen Galimidi, age 12

Didi .....Stephen Galimidi  
Gogo .....David Costabile

*“Next to You”* by Bruce MacVittie

These shows are performed in celebration of the lives of our dear friends  
Pat Walsh and Bob Reale.

The 52nd Street Project gratefully acknowledges the support of the following foundations and corporations: Barker Welfare Foundation, The Barnsley Foundation, Capital Research Company, Carnegie Corporation of New York, Comedy Central, Consolidated Edison, The Dammann Fund, Davis Polk & Wardwell, The Dramatists Guild Fund, Dramatists Play Service, Eleanor, Adam & Mel Dubin Foundation, The Educational Foundation Of America, Entertainment Weekly, Ford Foundation, The J. Paul Getty Trust, The Horace W. Goldsmith Foundation, The Hennessy Foundation, Holland Lodge Foundation, Hudson Scenic Studio, Betty E. & George B. Kaiser Foundation, Rita J. and Stanley H. Kaplan Foundation, Lloyds TSB Bank, Lucille Lortel Foundation, Lucent Technologies, Mellon Bank, Helen Merrill Ltd., The Cynthia & George Mitchell Foundation, J.P. Morgan Charitable Trust, The National Board of Review, Newman's Own, The New World Foundation, The New York Times, Paramount Pictures, Laura Pels Foundation, Roulette Entertainment, The Fan Fox & Leslie R. Samuels Entertainment, Staging and Design, The Surdna Foundation, Susquehanna Partners, Theatre Communications Group, The Vervane Foundation, West Bank Cafe, Yorke Construction Corp., Felix Zarembo & Co. Inc. (List current as of 7/24/02)

Robert Abrams & Cynthia Vance  
 Jace Alexander & Maddie Corman  
 Cecilia Arana-Grant & Kevin Grant  
 Lucie Amaz & Laurence Luckinbill  
 Debbon Ayer  
 Mary Bacon & Andrew Leynse  
 June Ballinger & Michael Goldstein  
 Ben Barenholtz  
 Benny Bartley  
 Jessica Bauman  
 Laurie Becker & Rick Sweren  
 Meredith Beeuwkes  
 Gregory Bello  
 Lisa Benavides & Tim Nelson  
 Barry & Myrna Bernard  
 Alexander & Elizabeth Bernstein  
 Stephen Bernstein  
 Vicky Bijur & Ed Levine  
 Reed Birney & Connie Shulman  
 Lewis Black  
 Jeanette & Samuel Black  
 Richard Blackstone & Yldeez Yuksek  
 Tessa Blake  
 Buzz Boyshov  
 Bob Boyett  
 Alan Braverman  
 Kathy Briggs  
 Becky Browder & Ted Neustadt  
 Susan Bruce & Peter Hedges  
 Kate Burton & Michael Ritchie  
 Linda & Arthur Carter  
 Alfred C. Cerullo III  
 Rachel Chanoff  
 Sharon Chantile  
 Ellen Chenoweth  
 Glenda Chesshir  
 Marissa & Travis Chibas  
 Kirk & Katherine Holt Citron  
 Darah Cloud & Dave Owens  
 Ethan Coen & Trish Cooke  
 Ruth Cohen  
 Jerome Cohen Congress  
 Lieta Hesen-Cohen & Richard Cohn  
 David Copeland  
 Hyla & Richard Crane  
 Margaret Cimmins  
 George & Cathy Crow  
 Cameron Crowe  
 Stephen & Sandra Crudgington  
 Tom Cruise  
 Catherine Curtin  
 Willem Dafoe & Liz Lecompte  
 Arthur Dantchik  
 Cathy Dantchik  
 Peter & Judith Dawkins  
 Georgia & William Delano  
 Jonathan Demme  
 Buddy Dikman & Chuck Davis  
 Edward & Joanne DiRugieris  
 Jon Davis & Gene Reilly  
 Richard & Rebecca Dresser  
 Moira Driscoll & David Pence  
 Christopher & Karen Eddowes  
 Mario Egozi  
 David Eigenberg  
 Ned Eisenberg & Patricia Dunnock  
 Nora Ephron  
 Barbara Ettinger & Sven Huseby  
 Barbara Ettinger  
 Heidi Ettinger  
 Wendy Ettinger & Derek McLane  
 Tom Feeney & Paul Parzuchowski  
 Adam Felber & Jeanne Simpson  
 Peter Jay Fernandez & Denise Burse  
 Martin Ross Fetner  
 Hannah Finn & John Wiltshire  
 Billy Finnegan  
 Angelina Fiordellisi & Matt Williams  
 Terry Fitzpatrick & Stephen Persepeluk  
 Anita Flanagan & Jeff Potter

Alexa Fogel  
 David Frankel  
 Eric & Juli Frankel  
 Richard Frankel & Kathleen Clark  
 Frank Frattaroli  
 Katherine Freedman  
 Naomi Freundlich & Charles Miles  
 Louis & Patrice Friedman  
 Victor Garber  
 Janeane Garofalo  
 Rose Gasner & Larry Chertoff  
 Joseph & Margaret Gazdak  
 Cora Cahlan & Bernard Gersten  
 Jillian Cahlan Gersten  
 Ileen Getz & Mark Grinnell  
 Paul & Elizabeth Giamatti  
 Nancy Giles  
 Lloyd & Kilty Gilmour  
 Bob Glennon  
 Bryan Gmitter  
 Judy Goldman & Michael Pillingner  
 Wendy Goldman  
 Tony Goldwyn & Jane Musky  
 Fred & Nancy Goodman  
 Stephen & Cathy Graham  
 Connie Grappo & Lee Wilkof  
 Michael Greif & Jonathan Fried  
 Mary Grieco  
 Emily Grishman & Susan Sampliner  
 Lisa Gugenheim  
 Mark & Valerie Hadjipateras  
 James A. Macdonald Foundation  
 Evan Handler  
 Lynn E. Harris  
 Jane & Jonathan Heine  
 Amy Henkels  
 David Herdrich & Elizabeth Palmer  
 Herdrich  
 Peter Herdrich & Karen Trott  
 William Holtzman & S. Sylvia Shepard  
 Katy Homans & Patterson Sims  
 Barbara Howard  
 Kate Hudson & Chris Robinson  
 Michelle Hurst  
 Dana Ivey  
 Mark Evan Jacobs  
 Sy Jacobs  
 Whitney Scott & Peter Jacobson  
 Linda LeRoy Janklow  
 Macon R. & Michael B. Jessop  
 Amanda Johns  
 Julia A. Johns  
 Andrea Johnson  
 Traci Paige Johnson & Robert Mowen  
 Cherry Jones & Mary O'Connor  
 Larry & Mary Jones  
 Marcy & Max Kahn  
 Maurice Kanbar  
 Eric Karpeles & Mike Sell  
 Ronald Kastner & Vanessa Boeys  
 Lisa A. Kauffman  
 Stephen & Sharon Kepniss  
 Seth & Beth Klarman  
 Alan & Kathryn Klingenstein  
 Joana & Jason Klot  
 Mary Kong  
 Judy Kuhn & David Schwab  
 Roger & Belle Kuhn  
 Lynn Landis  
 Mark Lanow & Joanne Astrow  
 Allan & Nanette Larson  
 Jill Larson  
 Michael P. Lawrence  
 Kate Lear & Jonathan LaPook  
 Mary Ann Lefort  
 Howard Leifman  
 Warren Leight  
 Mitchell Lemsky & Jane Bodle  
 Liza Lerner  
 Becky & Steven Lewis

Joshua Lewis  
 Anna Li  
 Linda Li  
 Mark Linn-Baker & Adrienne Lobel  
 Margo Lion  
 Jessica Lissy  
 Adrienne Lobel & Mark Linn Baker  
 Richard & Susan Lobel  
 John Lyons  
 Grace Lyu-Volkhausen  
 Barry Mackall & Bill Schwinghammer  
 Marsue & Peter MacNicol  
 Greg MacPherson & Jane Perlmutter  
 Rusty Magee & Alison Fraser  
 Wendy Makkena & Bob Krakower  
 Paul & Lauren Mandell  
 Elizabeth Manne  
 Peter Manning & André Bishop  
 Donald Margulies & Lynn Street  
 Richard Marin  
 Ali Marsh  
 Jesse L. Martin  
 Kay Matschullat & Allan Arfa  
 Dave & Alicia Matthews  
 Stephen & Cathy Graham  
 Brigid McCarthy  
 Michael Greif & Jonathan Fried  
 Paul McCrane & Dana Kellin  
 Fran McDormand & Joel Coen  
 William Michael McMahon & Meg  
 McMahon  
 Rick Meese & Dan Lori  
 Richard & Denise Menelly  
 Lynn E. Harris  
 Jane & Jonathan Heine  
 Amy Henkels  
 David Herdrich & Elizabeth Palmer  
 Herdrich  
 Peter Herdrich & Karen Trott  
 William Holtzman & S. Sylvia Shepard  
 Katy Homans & Patterson Sims  
 Barbara Howard  
 Kate Hudson & Chris Robinson  
 Michelle Hurst  
 Dana Ivey  
 Mark Evan Jacobs  
 Sy Jacobs  
 Whitney Scott & Peter Jacobson  
 Linda LeRoy Janklow  
 Macon R. & Michael B. Jessop  
 Amanda Johns  
 Julia A. Johns  
 Andrea Johnson  
 Traci Paige Johnson & Robert Mowen  
 Cherry Jones & Mary O'Connor  
 Larry & Mary Jones  
 Marcy & Max Kahn  
 Maurice Kanbar  
 Eric Karpeles & Mike Sell  
 Ronald Kastner & Vanessa Boeys  
 Lisa A. Kauffman  
 Stephen & Sharon Kepniss  
 Seth & Beth Klarman  
 Alan & Kathryn Klingenstein  
 Joana & Jason Klot  
 Mary Kong  
 Judy Kuhn & David Schwab  
 Roger & Belle Kuhn  
 Lynn Landis  
 Mark Lanow & Joanne Astrow  
 Allan & Nanette Larson  
 Jill Larson  
 Michael P. Lawrence  
 Kate Lear & Jonathan LaPook  
 Mary Ann Lefort  
 Howard Leifman  
 Warren Leight  
 Mitchell Lemsky & Jane Bodle  
 Liza Lerner  
 Becky & Steven Lewis

Herald & Linda Ritch  
 Loree Rodkin  
 David & Anita Rogerson  
 Robin Morse & Gus Rogerson  
 Clifford & Betsy Ross  
 Gaylen Ross  
 Daryl Roth  
 Alexander Roy  
 Mark Saad  
 Steve Sabba  
 Laura Sametz  
 Tim & Lisa Sanford  
 Zeborah Schachtel  
 Stacey Schaffer & Eric Schwartz  
 Karin & Tom Schall  
 Leslie Schine & Nils Nilsen  
 Beth Schneider  
 Maury Schott  
 Ken & Mary Ann Schuster  
 Stefan Selig  
 Jeffrey Seller & Joshua Lehrner  
 Mitchell Semel & Colleen Carroll  
 Alyson Shapero  
 Aaron & Elaine Shapiro  
 Jonathan Sheffer  
 Abby Jo Sigal & Matt Turner  
 Meg Simon  
 Landon Slane  
 Talia Balsam & John Slattery  
 Lois Smith  
 Phillip K. & Gloria W. Smith  
 Abigail Rose Solomon  
 Dr. David Solowjczyk  
 John Steber & Robert Shaffron  
 Jean Stein  
 Ben & Christine Stiller  
 David & Sara Stone  
 Abby Stranahan & Dave Ward  
 Susanna Styron & Darrell Larson  
 Brian Swardstrom  
 & Bonnie Bernstein  
 Daniel Swee  
 Mariko Tada  
 Jay & Rachel Tarses  
 Mary Lou Teel & Peter Freundlich  
 Joan Vail & John Thorne  
 Tracy Thorne & Edmund Lewis  
 Gina Torres  
 Anne Torsiglieri & Michael Bernard  
 Liz Tuocillo  
 Laura Valeroso & David Seidman  
 Josephine Eke & Jason Valk  
 Wendy vanden Heuvel & Brad Coley  
 Ed Vassallo  
 John A. Vassallo  
 John A. Vassilaros & Son, Inc  
 Mary Pat Walsh  
 Borah & Mildred Walton  
 Wendy Wasserstein  
 James Waterston & Line Lillevik  
 Anita Waxman  
 Sally & Lenny Weiss  
 Jane Bolster & Steve Wertimer  
 Carol Whitesides  
 Daniel Wiener  
 Jenny Wiener  
 Michael & Zena Wiener  
 Elizabeth Williams & Joseph Forte  
 Matt Williams & Angelina Fiordellisi  
 Jan Wilson & Saula Cutter  
 Donald Windham  
 Sarah Winkler & Simon Leopold  
 John Woo  
 Joanne Woodward & Paul Newman  
 Bill Wrubel & Jennifer Crittenden  
 Jeffrey & Janine Yass  
 James & Mary Lin Yoshimura  
 Virginia Zakian &  
 Robert Sandberg  
 Stuart Zicherman

The 52nd Street Project presents  
 The 2002 Wiener Family Foundation One-on-Ones

# TEN (MORE) FOR THE ROAD: THE TRAVELING PLAYS



JAMES STEVENSON

AUGUST 22-25, 2002  
 THE ENSEMBLE STUDIO THEATRE  
 549 WEST 52ND ST., NEW YORK CITY

**TEN (MORE)  
FOR THE ROAD:  
THE TRAVELING PLAYS**

*The 2002 Wareham, MA  
One-on-Ones  
August 22-25  
The Ensemble Studio Theatre*

**The 52nd Street Project Staff:**

Gus Rogerson, Artistic Director  
 Carol Ochs, Executive Director  
 John Sheehy, Director of Development and Marketing  
 Megan Sandberg-Zakian, Associate Artistic Director  
 George "X-Acto" Babiak, Production Manager  
 Liz Bell, Director of Education  
 Diana Rojas, Executive Assistant  
 Chris Ceraso, Teen Dean  
 Iris A. Brown, Graphic Designer  
 Mayleen Cancel and Zsuzsa Mysak, Receptionists  
 Interns: Conor Fetting-Smith, Charlotte Howard, Beth McMahon

**Production Staff**

**Composer:** Amy Kohn  
**Set Designer:** Kevin Joseph Roach  
**Lighting Designer:** Kelly Blackwell  
**Costume Designer:**  
 Crystal Thompson  
**Costume Assistant:**  
 Jennifer Tatum Jimenez  
**Sound Designer:** Chris Ryan  
**Sound Operator:** Ray Harold  
**Stage Manager:** Karen Munkel  
**Slide Design Team:**  
 Katherine Lumb, Monty Nicol, Kim  
 Snow, John Steward, Iwona Waluk  
**Prop Design Team:**  
 George Babiak, Liz Bell,  
 Conor Fetting-Smith,  
 Charlotte Howard, Ani Kehr,  
 Cara Marcous, Beth McMahon,  
 Karen Munkel, John Sheehy

**Flyer/Program Illustrations:**

James Stevenson

**Furniture Crew:**

Conor Fetting-Smith, Noel Polanco,  
 Stephen Galimidi

**Prop Crew:**

Charlotte Howard, Beth McMahon,  
 Leah Galimidi, Anthony Mejia

**Load-in and Light-hang Crew:**

Conor Fetting-Smith, Charlotte  
 Howard, Beth McMahon, Tim  
 Gallagher

**House Managers:**

Liz Bell, Karin Schall

**Chefs:**

Christopher Randolph, Bruce  
 MacVittie, Carol Ochs, John Sheehy

**Teen Counselor:**

Noel Polanco

**COOL STUFF ON SALE IN THE LOBBY!**

The Fabulous Flyer Bar . . . \$2.00, \$1.50 & \$1.00  
*and featuring Shel Silverstein's "Fivey and Twoey" logo:*  
 Project T-shirts . . . . . \$12.00  
 Project Tank Tops . . . . . \$12.00  
 Project Caps (NEW design) . . . . . \$15.00  
 Project Mugs (now in BLUE!) . . . . . \$5.00  
 Project Pencil 3-pack (now in RED!) . . . . . \$1.00

Thank you for coming to **TEN FOR THE ROAD!** If you are not on our mailing list (or if your address has changed), please fill out this form and give it to us on your way out or mail it to the address below. We would also like to know if you are interested in becoming a volunteer. We need help in **all areas**, so be sure to fill out the entire form.

**PLEASE ADD ME TO YOUR MAILING LIST:**

8/02

NAME: \_\_\_\_\_

ADDRESS: \_\_\_\_\_

ZIP \_\_\_\_\_

HOME PHONE: \_\_\_\_\_

DAYTIME PHONE: \_\_\_\_\_

E-MAIL ADDRESS: \_\_\_\_\_

MY OCCUPATION: \_\_\_\_\_

MY HOBBIES: \_\_\_\_\_

**YES, I WOULD LIKE TO BE OF HELP. I CAN:**

- |   |   |  |
|---|---|--|
| <input type="checkbox"/> Help load in and out for shows | <input type="checkbox"/> Draw and/or paint  | <input type="checkbox"/> Help kids with homework |
| <input type="checkbox"/> Hang lights                    | <input type="checkbox"/> Help with mailings | <input type="checkbox"/> Teach kids a skill      |
| <input type="checkbox"/> Work on a backstage crew       | <input type="checkbox"/> Do office work     | <input type="checkbox"/> Be a chef at an event   |
| <input type="checkbox"/> Do graphic design              | <input type="checkbox"/> Design sound       | <input type="checkbox"/> Design and sew costumes |
| <input type="checkbox"/> Other (please specify) _____   |   |  |

**MY SCHEDULE IS:**

- Very flexible. I'm often available during weekdays.  
 Somewhat flexible. I can help on the occasional morning or afternoon during the week.  
 Not very flexible at all, but I've got some free time on evenings and weekends.

If you would like to mail this (and you're always welcome to enclose a tax-deductible contribution), you can send it to: **The 52nd Street Project**, 500 West 52nd St., New York, NY 10019. Or fax it to (212) 333-5598.



The One-on-Ones Program is made possible with public funds from the National Endowment for the Arts; The New York State Council on the Arts, a state agency; the Department of Youth and Community Development; and the New York City Department of Cultural Affairs. The 52nd Street Project is a member of Art/NY and a participant in the New Generations Program, funded by Doris Duke Charitable Foundation/The Andrew W. Mellon Foundation and administered by Theatre Communications Group, the national organization for the American Theater.



## Don't Miss Our Upcoming Shows!

November 1-3, 2002:  
The Annual Playback Show

# If Only...

## The Second Chance Plays

First a kid writes a short play. Then, an adult writes an "answer" play. Then, the two of them perform both plays. Multiply this equation by seven and you've got an entire show.

December 13-15, 2002:  
The Fall  
Playmaking Series



In September, 10 kids brand-new to the Project will begin a Playmaking class taught by Project Playmaking Director Megan Sandberg-Zakian. Come and see their final plays performed by adult professional actors.

The 52nd Street Project is a non-profit organization that brings children from the Hell's Kitchen neighborhood together with professional theater artists to create original theater. **TEN FOR THE ROAD** is a production of our One-on-One program, which is designed to give children the opportunity to go away for one-week stays in the country and enjoy the undivided attention of a professional theater artist who serves as friend, mentor, and collaborator. The Project is delighted to return to the Ensemble Studio Theatre, where we have been performing since our inception in 1981. We gratefully acknowledge the fact that if E.S.T. wasn't here, we'd be nowhere.

### The 52nd Street Project Board of Directors

Ben Barenholtz

Lisa Benavides

Rachel Chanoff

Cathy Dantchik

Noël Dawkins

Wendy Ettinger,

*chair emeritus*

Louis P. Friedman

Stephen Graham, *chair*

Larry Jones

James McDaniel

Frances McDormand

Patricia M. Murphy, Esq.

Carol Ochs

Willie Reale,

*founder*

Gus Rogerson

Shirley Rumierk,

*alumni member*

José Soto, Jr.,

*alumni member*

Pamala Tyson

Laura Valeroso

Wendy vanden Heuvel

John A. Vassaros

Jenny Wiener

### Special Thanks

Our Host Families – **Gerry & Sam Gray; Anne & Colin McNay; Emily & John Morgan; Susanne & John Potts; Sidney Worthen & David Pearce; Joe & Beth McNay;** and an extra large helping of gratitude for our headquarters hosts **Peter, Helen & Christopher Randolph.**

### In-Kind Contributions

Sincere thanks to our chef **Christopher Randolph** for slaving away over a hot stove; to **David Sneddon, Steve Jenkins & Fairway** for contributing a vanload of great food; **Nesserella's Fruit and Vegetable Stand; Kim D. Sherman** for her musical contributions; **Karin Schall; Stephen Graham;** and the **Marion General Store.**

## TEN (MORE) FOR THE ROAD – ACT I

*“Ten (More) for the Road Theme Song”* lyrics by John Sheehy

### BIG JOHN

Written By Michael Bernard & Directed by Shirley Rumierk  
for **Wonkezeh Newenle**, age 14

Big John .....Wonkezeh Newenle  
Sheriff Luwanda/Grandma .....Shirley Rumierk

*“Drift & Roll”* music by Amy Kohn & lyrics by Michael Bernard

### OZ AGAIN

Written by Suzen Murakoshi & Willie Reale & Directed by Suzen Murakoshi  
for **Evelyn Nicole Rosario**, age 11

Dorothy .....Suzen Murakoshi  
Myrna, The Wicked Witch of the South .....Evelyn Nicole Rosario

*“Newark, Newark”* music by Amy Kohn & lyrics by Willie Reale

### JUST THE CASH

Written by Joe Mihalow & Directed by Tom Schall  
for **Ariana Casablanca**, age 13

Newsman/Headquarters .....John Sheehy  
Customer .....Diana Rojas  
Bank Teller .....Noel Polanco  
Fifi .....Ariana Casablanca  
Francois .....Tom Schall  
Bakery Employee .....Conor Fetting-Smith  
The Boot .....George Babiak

*“Do What You Do”* music by Amy Kohn & lyrics by John Sheehy

### ON THE ROAD, THE PREQUEL

Written & Directed by Bruce MacVittie for **Alex Kehr**, age 11

Dean .....Alex Kehr  
Sal .....Bruce MacVittie  
Hep Cat Chorus .....The “Beat-elles”

*“The Dean Moriarty Riff”* music by Amy Kohn & lyrics by Bruce MacVittie

*“Let’s Step Out”* music by Kim D. Sherman & lyrics by Bruce MacVittie

### THE MAD EXPERIMENT

Written & Directed by Zabryna Guevara for **Anastasia Kehr**, age 12

Mad Scientist .....Anastasia Kehr  
Monster .....Zabryna Guevara

*“Mad Scientist Blues”* music & lyrics by Zabryna Guevara *“Friendship, Life & Truth”* music by Kim D. Sherman & lyrics by Zabryna Guevara

## ACT II

### GROUND CREW GARY TAKES OFF

Written & Directed by Josh Lewis for **Michael Velez**, age 12

Ground Crew Gary .....Michael Velez  
Sparky/Ulcer .....Josh Lewis  
Devon .....Noel Polanco

*“Ground Crew Gary”* music & lyrics by Josh Lewis

### CLOWN TIME IS OVER

Written by Cynthia Kaplan & Directed by Angel Desai  
for **Katie Grullon**, age 12

Petaluna .....Katie Grullon  
Chickie .....Angel Desai  
Circus Announcer .....John Sheehy

*“Out There In The World”* music by Angel Desai & lyrics by Cynthia Kaplan

*“Not An Easy Life”* music by Amy Kohn & lyrics by Cynthia Kaplan

### UP IN ARMS

Written & Directed by Jerry McGill for **Johanna Vidal**, age 11

Lucia Cappuccini .....Johanna Vidal  
Antonio Cappuccini .....Jerry McGill  
Rosaria .....Diana Rojas  
The Couple .....Conor Fetting-Smith, Charlotte Howard  
Sergio .....Noel Polanco

*“I Gotta Have You, You Gotta Have Me”* music by Jerry McGill & Amy Kohn & lyrics by Jerry McGill

### MACK AND MAY

Written & Directed by Keira Naughton for **Zebulun Santiago**, age 11

Mack .....Zebulun Santiago  
May .....Keira Naughton  
Doc .....John Sheehy  
Lady .....Leah Galimidi

*“Mack’s Song”* & *“Mack & May’s Song”* music & lyrics by Keira Naughton

### THE PAINTER

Written & Directed by Robert Sean Leonard for **Mike Grullon**, age 13

Giuseppe .....Mike Grullon  
Paolo .....Robert Sean Leonard  
The Chicken Lady .....Charlotte Howard

*“Giuseppe’s Song”* music & lyrics by Robert Sean Leonard

👉 **Intermission!** 👈

Barker Welfare Foundation, Blythmour Corporation, Capital Research Company, Carnegie Corporation of New York, Comedy Central, Davis Polk & Wardwell, Deutsche Bank of Americas Foundation, The Dramatists Guild Fund, Dramatists Play Service, Eleanor, Adam & Mel Dubin Foundation, Entertainment Weekly, The Fan Fox & Leslie R. Samuels Fdn., The J. Paul Getty Trust, Office of Assembly Member Richard Gottfried, The Horace W. Goldsmith Foundation, Holland Lodge Foundation, Inc., Betty E. & George B. Kaiser Foundation, Lemle Pictures, Inc., Lloyds TSB Bank plc, Lucille Lortel Foundation, Lucent Technologies, James A. Macdonald Foundation, Major League Baseball, Mellon Bank, N.A., The Cynthia & George Mitchell Foundation, The National Board of Review, Newman's Own, The New World Foundation, The New York Times Co. Foundation, Paramount Pictures, Pfizer Foundation, Philip Morris Companies, Roulette Entertainment, Rytech Inc., St. James' Church, Susquehanna Partners, G.P., Theatre Communications Group, Inc., John A. Vassilaros & Son, Inc., The Vervane Foundation, West Bank Café, Felix Zarembo & Co. Inc. (List current as of 10/31/02)

Jace Alexander & Maddie Corman  
 Cecilia Arana-Grant & Kevin Grant  
 Lucie Amaz & Laurence Luckinbill  
 Debbon Ayer  
 June Ballinger & Michael Goldstein  
 Arija Bareikis  
 Ben Barenholtz  
 Benny Bartley  
 Jessica Bauman  
 Laurie Becker & Rick Sweren  
 Gregory Bello  
 Lisa Benavides & Tim Nelson  
 Vicky Bijur & Ed Levine  
 Lewis Black  
 Richard Blackstone & Yldeez Yuksek  
 Tessa Blake  
 Buzz Bovshov  
 Julie Boyd  
 Bob Boyett  
 Becky Browder & Ted Neustadt  
 Susan Bruce & Peter Hedges  
 Michael Buchanan  
 Phoebe Cates & Kevin Kline  
 Alfred C. Cerullo III  
 Rachel Chanoff  
 Sharon Chantile  
 Glenda Chesshir  
 Kirk & Katherine Holt Citron  
 Darah Cloud & Dave Owens  
 Ethan Coen & Trish Cooke  
 Ruth Cohen  
 Lieta Hesen-Cohen & Richard Cohn  
 Elizabeth Cooper Davis  
 & Gordon J. Davis  
 David Copeland  
 Hyla & Richard Crane  
 Margaret Crimmins  
 Peter & Barbara Cross  
 Emily Crow  
 Catherine Curtin  
 Willem Dafoe & Liz Lecompte  
 Nadia Dajani  
 Arthur Dantchik  
 Cathy Dantchik  
 Peter & Judith Dawkins  
 Noël Dawkins & Joe Mihalow  
 Georgia & William Delano  
 Jonathan Demme  
 Stephen DeRosa  
 Cameron Diaz  
 Buddy Dikman & Chuck Davis  
 Alex Draper & Lorraine Tobias  
 Richard & Rebecca Dresser  
 Moira Driscoll & David Pence  
 Christopher & Karen Eddowes  
 Mario Egozi  
 David Eigenberg  
 Ned Eisenberg & Patricia Dunnock  
 Beth Emelson  
 Nora Ephron  
 Barbara Ettinger & Sven Huseby  
 Heidi Ettinger  
 Wendy Ettinger & Derek McLane

Tom Feeney & Paul Parzuchowski  
 Peter Jay Fernandez & Denise Burse  
 Martin Ross Fetner  
 Angelina Fiordellisi & Matt Williams  
 Anita Flanagan & Jeff Potter  
 Alexa Fogel  
 Frank Frattaroli  
 Katherine Freedman  
 Naomi Freundlich & Charles Miles  
 Louis & Patrice Friedman  
 Michael & Sonya Gaffney  
 Janeanne Garofalo  
 Rose Gasner & Larry Chertoff  
 Jonathan Gazdak  
 Cora Cahan & Bernard Gersten  
 Jilian Cahan Gersten  
 Ileen Getz & Mark Grinnell  
 Paul & Elizabeth Giamatti  
 Toni Giamatti  
 Nancy Giles  
 Lloyd & Kity Gilmour  
 Bryan Gmitter  
 Judy Goldman & Michael Pillingier  
 Tony Goldwyn & Jane Musky  
 Fred & Nancy Goodman  
 Lizzie Gottlieb  
 Stephen & Cathy Graham  
 Michael Greif & Jonathan Fried  
 Emily Grishman & Susan Sampliner  
 Lisa Gugenheim  
 Mark & Valerie Hadjipateras  
 Lynn E. Harris  
 Jane & Jonathan Heine  
 Peter Herdrich & Karen Trott  
 Colleen Hindsley  
 William Holtzman & S. Sylvia  
 Shepard  
 Katy Homans & Patterson Sims  
 Matthew Houston  
 Barbara Howard  
 Philip & Alexandra Howard  
 Kate Hudson & Chris Robinson  
 Dana Ivey  
 Mark Evan Jacobs  
 Whitney Scott & Peter Jacobson  
 Amanda Johns  
 Andrea Johnson  
 Traci Paige Johnson  
 & Robert Mowen  
 Larry & Mary Jones  
 Maurice Kanbar  
 Eric Karpeles & Mike Sell  
 Ronald Kastner & Vanessa Boeys  
 Stephen & Sharon Kepniss  
 Judy Kuhn & David Schwab  
 Roger & Belle Kuhn  
 Allan & Nanette Larson  
 Michael P. Lawrence  
 Kate Lear & Jonathan LaPook  
 Mary Ann Lefort  
 Warren Leight  
 Robert Sean Leonard  
 Liza Lerner

Aimee Levine  
 Joshua Lewis  
 Anna Li  
 Linda Li  
 Adrienne Lobel & Mark Linn Baker  
 John Lyons  
 Grace Lyu-Volkhausen  
 Barry Mackall  
 & Bill Schwinghammer  
 Marsue & Peter MacNicol  
 Greg MacPherson  
 & Jane Perlmutter  
 Roma Maffia  
 Rusty Magee & Alison Fraser  
 Wendy Makkena & Bob Krakower  
 Elizabeth Manne  
 Donald Margulies & Lynn Street  
 Richard Marin  
 Sonya Martin  
 John Matoian  
 Kay Matschullat & Allan Arffa  
 Brigid Mccarthy  
 Fran McDormand & Joel Coen  
 Jerry McGill  
 William Michael McMahon  
 & Meg McMahon  
 Rick Meese & Dan Lori  
 Richard & Denise Menelly  
 Josie Merck & Jim Stevenson  
 Audrey & Danny Meyer  
 Nancy Meyer & Marc Weiss  
 Emily & John Morgan  
 Alfred H. Morris  
 Bob Morris  
 Meg Mortimer  
 Suzen Murakoshi  
 Patricia M. Murphy, Esq.  
 & Adam Spilka  
 Geoffrey Nauftis  
 Eric Nedelander  
 Don & Sara Nelson  
 Pamela & Peter Nelson  
 Randy & Rona Nelson  
 Ruth Nelson  
 Mark Nesselson, M.D.  
 & Elliott Rosenblum  
 Lori O'Connor  
 Kevin O'Rourke & Edith Thurber  
 Carol Ochs & Bruce MacVittie  
 Jacki Ochs & Jan Kroezee  
 Lenore Pemberton  
 Elizabeth Peters  
 Peter & Ana Rosa Phillips  
 Oliver Platt & Camilla Campbell Platt  
 Jeremy Posner  
 Dean & Leslie Potashner  
 Michael Potts  
 Christopher Randolph  
 Peter & Helen Randolph  
 Richard Rauchenberger  
 Willie Reale & Jenny Gersten  
 Theresa Rebeck & Jess Lynn  
 Herald & Linda Ritch

David & Anita Rogerson  
 Robin Morse & Gus Rogerson  
 Arthur H. Rosenbloom  
 Daryl Roth  
 Alexander Roy  
 Shirley Rumiak  
 Mark Saad  
 Steve Sabba  
 Arnold & Agnes Sametz  
 Laura Sametz  
 Elizabeth Santeix  
 Zeborah Schachtel  
 Karin & Tom Schall  
 Leslie Schine & Nils Nilsen  
 Maury Schott  
 Ken & Mary Ann Schuster  
 Richard Schwartz  
 Dana Segal  
 Stefan Selig  
 Mitchell Semel & Colleen Carroll  
 Richard Shaffer & Nataalka Bukalo  
 Aaron & Elaine Shapiro  
 Bernice Baruch Shawl  
 Abby Jo Sigal & Matt Turner  
 Meg Simon  
 Landon Slane  
 Talia Balsam & John Slattery  
 Abigail Rose Solomon  
 Jean Stein  
 Ben & Christine Stiller  
 David & Sara Stone  
 Abby Stranahan & Dave Ward  
 Paola Styron  
 Susanna Styron & Darrell Larson  
 Brian Swardstrom  
 & Bonnie Bernstein  
 Daniel Swee  
 Mariko Tada  
 Crystal Thompson  
 Gina Torres  
 Anne Torsiglieri & Michael Bernard  
 Carl & Edna Torsiglieri  
 Liz Tuccillo  
 John & Katherine Turturro  
 Laura Valeroso & David Seidman  
 Josephine Eke & Jason Valk  
 Wendy vanden Heuvel & Brad Coley  
 Ed Vassallo  
 John A. Vassallo  
 John Vassilaros & Alexandra Gersten  
 Susan Vitucci  
 Mary Pat Walsh  
 Borah & Mildred Walton  
 Maja Wampuszyc  
 Wendy Wasserstein  
 Anita Waxman  
 Ann & Paul Weiss  
 Sally & Lenny Weiss  
 Jane Bolster & Steve Wertimer  
 Carol Whitesides  
 Jenny Wiener & Jon Steingart  
 Michael & Zena Wiener  
 Donald Windham



THE 52ND STREET PROJECT  
 PRESENTS  
 THE 2002 PLAYBACK SERIES

# IF ONLY...

## THE SECOND CHANGE PLAYS

FRI., NOV. 1  
 AT 7:30 P.M.

SAT., NOV. 2  
 AT 3:00 P.M.  
 & 7:30 P.M.

SUN., NOV. 3  
 AT 3:00 P.M.

THE CHERNUCHIN  
 THEATER AT  
 A.T.A.  
 314 W. 54TH ST.,  
 NEW YORK CITY



# IF ONLY...

THE SECOND CHANCE PLAYS

THE 2002  
PLAYBACK SERIES  
NOVEMBER 1-3  
AT A.T.A.

**The 52nd Street Project Staff:**

Gus Rogerson, Artistic Director  
 Carol Ochs, Executive Director  
 John Sheehy, Director of Development and Marketing  
 Megan Sandberg-Zakian, Associate Artistic Director  
 George "X-Acto" Babiak, Production Manager  
 Liz Bell, Director of Education  
 Diana Rojas, Executive Assistant  
 Chris Ceraso, Teen Dean  
 Iris A. Brown, Graphic Designer  
 Mayleen Cancel and Jaymaree Rosado, Receptionists  
 Interns: Jolie Tong and Padma Sundaram

**Production Staff:**

**Composer:** Joel Derfner  
**Music Director:** Kari Riely  
**Set Designer:** Kevin Joseph Roach  
**Lighting Designer:**  
 Greg MacPherson  
**Assistant Lighting Designer:**  
 Jason Wells  
**Costume Designer:** Sheila Kehoe  
**Sound Designer:** Betsy Rhodes  
**Stage Manager:** Noël Dawkins  
**Slide Designers:**  
 George Babiak, Christopher  
 Bonanos, Katherine Lumb, Monty  
 Nicol, John Steward, Iwona Waluk  
**"If Only" Illustration:**  
 Esther Geller  
**Prop Design Team:**  
 George Babiak, Roi Babiak,

Danny Goldstein, Amanda Keropian,  
 Cara Marcous, Karen Munkel,  
 Padma Sundaram, Jolie Tong  
**Furniture Crew:**  
 Lee Rosen, Zebulon Santiago,  
 Adrian Zambrano and Alex Tomas  
**Prop Crew:**  
 Jolie Tong, Padma Sundaram,  
 Johanna Vidal  
**Load-in and Light Hang Crew:**  
 Jack Gwaltney, Karen Munkel, Moira  
 MacDonald, Anne O'Sullivan,  
 Christopher Randolph, Chris Ryan,  
 John Salzman, Tom Schall, Maury  
 Schott, Charlie Tolkentines  
**House Managers:** Liz Bell,  
 Karin Schall, and Mary Pat Walsh  
**Chefs:** John Sheehy, Liz Bell



The Playback Program is made possible with public funds from the National Endowment for the Arts; The New York State Council on the Arts, a state agency. The 52nd Street Project is a member of Art/NY and a participant in the New Generations Program, funded by Doris Duke Charitable Foundation/The Andrew W. Mellon Foundation and administered by Theatre Communications Group, the national organization for the American Theater.



# COOL STUFF ON SALE!

FLYER BARS . . . \$2.00, \$1.50 & \$1.00  
 SHEL SILVERSTEIN'S "FIVEY AND TWOEY" LOGO

**GEAR:**

PROJECT T-SHIRTS . . . . . \$12.00  
 PROJECT LONG SLEEVE T-SHIRTS \$15.00  
 PROJECT CAPS . . . . . \$15.00  
 PROJECT MUGS . . . . . \$5.00  
 PROJECT PENCIL 3-PACK . . . . . \$1.00

Thank you for coming to **IF ONLY...** If you are not on our mailing list (or if your address has changed), please fill out this form and give it to us on your way out or mail it to the address below. We would also like to know if you are interested in becoming a volunteer. We need help in **all areas**, so be sure to fill out the entire form.

**PLEASE ADD ME TO YOUR MAILING LIST:**

11/02

NAME: \_\_\_\_\_

ADDRESS: \_\_\_\_\_

\_\_\_\_\_ ZIP \_\_\_\_\_

HOME PHONE: \_\_\_\_\_

DAYTIME PHONE: \_\_\_\_\_

E-MAIL ADDRESS: \_\_\_\_\_

MY OCCUPATION: \_\_\_\_\_

MY HOBBIES: \_\_\_\_\_

**YES, I WOULD LIKE TO BE OF HELP. I CAN:**

- |   |   |  |
|---|---|--|
| <input type="checkbox"/> Help load in and out for shows | <input type="checkbox"/> Draw and/or paint  | <input type="checkbox"/> Help kids with homework |
| <input type="checkbox"/> Hang lights                    | <input type="checkbox"/> Help with mailings | <input type="checkbox"/> Teach kids a skill      |
| <input type="checkbox"/> Work on a backstage crew       | <input type="checkbox"/> Do office work     | <input type="checkbox"/> Be a chef at an event   |
| <input type="checkbox"/> Do graphic design              | <input type="checkbox"/> Design sound       | <input type="checkbox"/> Design and sew costumes |
| <input type="checkbox"/> Other (please specify) _____   |   |  |

**MY SCHEDULE IS:**

- Very flexible. I'm often available during weekdays.  
 Somewhat flexible. I can help on the occasional morning or afternoon during the week.  
 Not very flexible at all, but I've got some free time on evenings and weekends.



If you would like to mail this (and you're always welcome to enclose a tax-deductible contribution), you can send it to: **The 52nd Street Project**, 500 West 52nd St., New York, NY 10019. Or fax it to (212) 333-5598.

**Don't Miss Our Upcoming Shows!**

# STOP THE PRESSES!



**December 13-15**  
**HB Playwright's**  
**Foundation**  
**124 Bank St.**

In September, 10 kids brand-new to the Project began a Playmaking class taught by Playmaking Director Megan Sandberg-Zakian. Come and see their final plays performed by adult professional actors.

## ***THE SENSATIONAL PLAYS***

**"IF AT FIRST  
YOU DON'T  
SUCCEED..."**

**PLAYS THAT TRY AGAIN**

*PLAYBACK, ROUND II*  
*JANUARY, 2003*

We're doing it again, but with new kids, new adults, new plays, and a new theater...not to mention a new theme. Come see it!

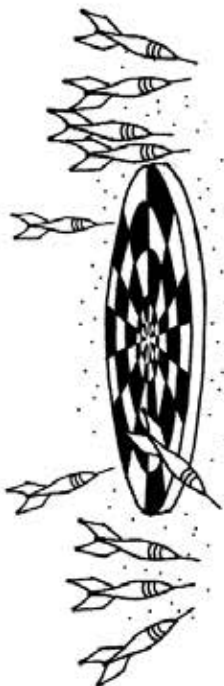

The 52nd Street Project is a non-profit organization that brings children from the Hell's Kitchen neighborhood together with professional theater artists to create original theater. **IF ONLY...** is a production of our Playback program, in which kid actor/playwrights are taken away for a weekend in Pawling, New York, where they write a play. Their adult actor/playwright partners then write "answer plays" in response. In the final production, which you see here tonight, the partners perform both plays back-to-back. All of the kids involved are veterans of the Playmaking classes which were adapted for the Project by Daniel Judah Sklar from his book *Playmaking: Children Writing and Performing Their Own Plays*.

### **The 52nd Street Project Board of Directors**

Ben Barenholtz  
Lisa Benavides  
Rachel Chanoff  
Cathy Dantchik  
Noël Dawkins  
Wendy Ettinger,  
*chair emeritus*  
Louis P. Friedman  
Stephen Graham, *chair*  
Larry Jones  
James McDaniel  
Frances McDormand  
Patricia M. Murphy, Esq.

Carol Ochs  
Willie Reale,  
*founder*  
Gus Rogerson  
Shirley Rumierk,  
*alumni member*  
José Soto, Jr.,  
*alumni member*  
Pamala Tyson  
Laura Valeroso  
Wendy vanden Heuvel  
John A. Vassilaros  
Jenny Wiener

### **Special Thanks**

We're extremely grateful to **Sharon Washington, Charles Ward, Craig the caretaker**, and the **Hudson Valley Artist's Foundation** for housing us over the Playback writing weekend. Thanks also to **Anita Flanagan** for her help with costumes.

### **In-Kind Contributions**

We are also indebted to **Neil A. Mazzella and Hudson Scenic Studios**; the **Murphy Law Office**; **Iris A. Brown**; **Ron Kastner and Capital Printing**; **Big Apple Lights**; **Coleman**; **Noggin**; **The Printing Store**; **Scholastic, Inc.**; **Diageo Chateau & Estate Wines**; **Sesame Workshop**; **Watkins, Inc.**; **Mayor's Office of Film & Television**; **Boylan's Bottling Co.**; **David Sneddon & Fairway Market**; **Andy Millon**; **Steve Olsen & The Westbank Cafe**; **Lorraine Tobias & Imaginary Studios**; **Robert Goldberg and Yorke Construction**; **Jive Records**, part of **Zomba Music Group**; and **Prime Films**.

## IF ONLY... ACT I

All original music composed by Joel Derfner

### Stealing Dreams

By Steven Vasquez age 15. Dramaturg/Director: Ed Vassallo

### The Playuh-Hatuh

 Written and directed by Ed Vassallo

Benchy .....Steven Vasquez  
The Shaker .....Ed Vassallo  
Coach .....John Sheehy  
B.B. Players .....The Crew  
Announcers/Reporters .....Gus Rogerson, John Sheehy, George Babiak  
“*Benchy’s Rap*” lyrics by Ed Vassallo

---

### Beginning is Winning, Losing’s the End

By Lizette Natera, age 14. Dramaturg/Director: Megan Sandberg-Zakian

### I’m Okay, You’re Serving Coffee

Written by Susan Kim, directed by Megan Sandberg-Zakian

D.J. Smith .....Lizette Natera  
Brittany Santiago .....Cecilia Arana  
Teacher .....Padma Sundaram  
Adoring Fan .....Johanna Vidal  
“*All for You*” and “*I Got to Go*” lyrics by Lizette Natera. “*I Got to Go 2*” lyrics by Susan Kim.

---

### The Line Between Friends

By Robert Tomas, age 14. Dramaturg/Director: Michael Potts

### A Few Good Years Left

 Written and directed by Michael Potts

Jose/Coach Hector Lopez .....Robert Tomas  
Bryan/Principal Joe Johnson .....Michael Potts  
Girls at Party .....Liz Bell, Padma Sundaram  
Partygoers .....The Crew  
“*You Can Count on a Friend*” lyrics by Robert Tomas

---

### Through Thick and Thin

By Jaymaree Rosado, age 15. Dramaturg/Director: Liz Flahive

### The Real News

 Written and directed by Liz Flahive

Julia/Janice .....Jaymaree Rosado  
Jobe/Ed Edwards .....Duane Boutté  
Lady/Ed’s Mother .....Kari Riely  
The Judges .....Gus Rogerson, John Sheehy, George Babiak

👉 **Intermission!** 👈

## IF ONLY... ACT II

### Friends are Better than Fame

By Oscar Padilla, age 15. Dramaturg/Director: Danny Goldstein

### Tennis, Gilly-Style

Written and Directed by Danny Goldstein

Gilly Thom-Son/Jack .....Oscar Padilla  
Tina White/Diane .....Roz Coleman  
Director .....John Sheehy  
Cameraman .....Alex Tomas  
Writer .....Zebulon Santiago  
Clapper Girl .....Johanna Vidal  
Guy in street .....Adrian Zambrano  
“*Smelly Slob*” and “*Give Some Gratitude*” lyrics by Oscar Padilla

---

### Liz and Iz

By Nadya Jabour, age 14. Dramaturg/Director: Nancy Giles

### Love and Biz

Written and Directed by Nancy Giles

Elizabeth .....Nadya Jabour  
Isabella/Dr. Van Pelt .....Nancy Giles  
“*Remember the Days*” lyrics by Nancy Giles

---

### Two Different Ways

By Justin Aponte, age 15. Dramaturg/Director: Gus Rogerson

### Rien de Rien

Written and directed by Gus Rogerson

Tom .....Justin Aponte  
Ray .....Gus Rogerson  
French Painter .....George Babiak  
“*Nowhere to Go*” lyrics by Gus Rogerson

## Teen Glossary

**a’ight** or **lght**- A contraction of “all right.”

**buggin’** or **trippin’**- Crazy, irrational

**chill**- Take it easy, stop.

**dum** or **mad**- Extremely, very

**fashizzle**- For sure, definitely.

**frontin’**- Putting on a false image.

“**G**” or “**son**”- Terms of affection

**hater**- A person who is very critical

**heated**- Angry, upset

**I’m out** or “**one**”- Goodbye

**keep it global, keep it gator**- Stay calm, take it easy.

**off the hook**- Superlative, beyond measurable limits

**PJ’s**- The projects (housing developments)

**wack**- Nerdy, uncool

**what’s good? what’s poppin’**- How is everything with you?

**word** or **ya heard?**- Yes, absolutely

Barker Welfare Foundation, Blythmour Corporation, Capital Research Company, Carnegie Corporation of New York, Comedy Central, Davis Polk & Wardwell, Deutsche Bank of Americas Foundation, The Dramatists Guild Fund, Dramatists Play Service, Eleanor, Adam & Mel Dubin Foundation, Entertainment Weekly, The Fan Fox & Leslie R. Samuels Fdn., The J. Paul Getty Trust, Office of Assembly Member Richard Gottfried, The Horace W. Goldsmith Foundation, Holland Lodge Foundation, Inc., Betty E. & George B. Kaiser Foundation, Lemle Pictures, Inc., Lloyds TSB Bank plc, Lucille Lortel Foundation, Lucent Technologies, James A. Macdonald Foundation, Major League Baseball, Mellon Bank, N.A., The Cynthia & George Mitchell Foundation, The National Board of Review, Newman's Own, The New World Foundation, The New York Times Co. Foundation, Paramount Pictures, Pfizer Foundation, Philip Morris Companies, Roulette Entertainment, Rytech Inc., St. James' Church, Susquehanna Partners, G.P., Theatre Communications Group, Inc., John A. Vassilaros & Son, Inc., The Vervane Foundation, West Bank Café, Felix Zarembo & Co. Inc. (List current as of 10/31/02)

Jace Alexander & Maddie Corman  
 Cecilia Arana-Grant & Kevin Grant  
 Lucie Amaz & Laurence Luckinbill  
 Debbon Ayer  
 June Ballinger & Michael Goldstein  
 Arija Bareikis  
 Ben Barenholtz  
 Benny Bartley  
 Jessica Bauman  
 Laurie Becker & Rick Sweren  
 Gregory Bello  
 Lisa Benavides & Tim Nelson  
 Vicky Bijur & Ed Levine  
 Lewis Black  
 Richard Blackstone & Yldeez Yuksek  
 Tessa Blake  
 Buzz Boydshow  
 Julie Boyf  
 Bob Boyett  
 Becky Browder & Ted Neustadt  
 Susan Bruce & Peter Hedges  
 Michael Buchanan  
 Phoebe Cates & Kevin Kline  
 Alfred C. Cerullo III  
 Rachel Chanoff  
 Sharon Chantile  
 Glenda Chesshir  
 Kirk & Katherine Holt Citron  
 Darah Cloud & Dave Owens  
 Ethan Coen & Trish Cooke  
 Ruth Cohen  
 Lieta Hesen-Cohen & Richard Cohn  
 Elizabeth Cooper Davis  
 & Gordon J. Davis  
 David Copeland  
 Hyla & Richard Crane  
 Margaret Crimmins  
 Peter & Barbara Cross  
 Emily Crow  
 Catherine Curtin  
 Willem Dafoe & Liz Lecompte  
 Nadia Dajani  
 Arthur Dantchik  
 Cathy Dantchik  
 Peter & Judith Dawkins  
 Noël Dawkins & Joe Mihalow  
 Georgia & William Delano  
 Jonathan Demme  
 Stephen DeRosa  
 Cameron Diaz  
 Buddy Dikman & Chuck Davis  
 Alex Draper & Lorraine Tobias  
 Richard & Rebecca Dresser  
 Moira Driscoll & David Pence  
 Christopher & Karen Eddowes  
 Mario Egozi  
 David Eigenberg  
 Ned Eisenberg & Patricia Dunnock  
 Beth Emelson  
 Nora Ephron  
 Barbara Ettinger & Sven Huseby  
 Heidi Ettinger  
 Wendy Ettinger & Derek McLane

Tom Feeney & Paul Parzuchowski  
 Peter Jay Fernandez & Denise Burse  
 Martin Ross Felner  
 Angelina Fiordellisi & Matt Williams  
 Anita Flanagan & Jeff Potter  
 Alexa Fogel  
 Frank Frattaroli  
 Katherine Freedman  
 Naomi Freundlich & Charles Miles  
 Louis & Patrice Friedman  
 Michael & Sonya Gaffney  
 Janeanne Garfalo  
 Rose Gasner & Larry Chertoff  
 Jonathan Gazdak  
 Cora Cahan & Bernard Gersten  
 Jilian Cahan Gersten  
 Ileen Getz & Mark Grinnell  
 Paul & Elizabeth Giamatti  
 Toni Giamatti  
 Nancy Giles  
 Lloyd & Kity Gilmour  
 Bryan Gmitter  
 Judy Goldman & Michael Pillingier  
 Tony Goldwyn & Jane Musky  
 Fred & Nancy Goodman  
 Lizzie Gottlieb  
 Stephen & Cathy Graham  
 Michael Greif & Jonathan Fried  
 Emily Grishman & Susan Sampliner  
 Lisa Gugenheim  
 Mark & Valerie Hadjipateras  
 Lynn E. Harris  
 Jane & Jonathan Heine  
 Peter Herdrich & Karen Trott  
 Colleen Hindstley  
 William Holtzman & S. Sylvia  
 Shepard  
 Katy Homans & Patterson Sims  
 Matthew Houston  
 Barbara Howard  
 Philip & Alexandra Howard  
 Kate Hudson & Chris Robinson  
 Dana Ivey  
 Mark Evan Jacobs  
 Whitney Scott & Peter Jacobson  
 Amanda Johns  
 Andrea Johnson  
 Traci Paige Johnson  
 & Robert Mowen  
 Larry & Mary Jones  
 Maurice Kanbar  
 Eric Karpeles & Mike Sell  
 Ronald Kastner & Vanessa Boeyle  
 Stephen & Sharon Kepniss  
 Judy Kuhn & David Schwab  
 Roger & Belle Kuhn  
 Allan & Nanette Larson  
 Michael P. Lawrence  
 Kate Lear & Jonathan LaPook  
 Mary Ann Lefort  
 Warren Leight  
 Robert Sean Leonard  
 Liza Lerner

Aimee Levine  
 Joshua Lewis  
 Anna Li  
 Linda Li  
 Adrienne Lobel & Mark Linn Baker  
 John Lyons  
 Grace Lyu-Volkhausen  
 Barry Mackall  
 & Bill Schwinghammer  
 Marsue & Peter MacNicol  
 Greg MacPherson  
 & Jane Perlmutter  
 Roma Maffia  
 Rusty Magee & Alison Fraser  
 Wendy Makkena & Bob Krakower  
 Elizabeth Manne  
 Donald Margulies & Lynn Street  
 Richard Marin  
 Sonya Martin  
 John Matoian  
 Kay Matschullat & Allan Arffa  
 Brigid Mccarthy  
 Fran McDormand & Joel Coen  
 Jerry McGill  
 William Michael McMahon  
 & Meg McMahon  
 Rick Meese & Dan Lori  
 Richard & Denise Menelly  
 Josie Merck & Jim Stevenson  
 Audrey & Danny Meyer  
 Nancy Meyer & Marc Weiss  
 Emily & John Morgan  
 Alfred H. Morris  
 Bob Morris  
 Meg Mortimer  
 Suzen Murakoshi  
 Patricia M. Murphy, Esq.  
 & Adam Spilka  
 Geoffrey Naultifs  
 Eric Nedelander  
 Don & Sara Nelson  
 Pamela & Peter Nelson  
 Randy & Rona Nelson  
 Ruth Nelson  
 Mark Nesselson, M.D.  
 & Elliott Rosenblum  
 Lori O'Connor  
 Kevin O'Rourke & Edith Thurber  
 Carol Ochs & Bruce MacVittie  
 Jacki Ochs & Jan Kroeze  
 Lenore Pemberton  
 Elizabeth Peters  
 Peter & Ana Rosa Phillips  
 Oliver Platt & Camilla Campbell Platt  
 Jeremy Posner  
 Dean & Leslie Potashner  
 Michael Potts  
 Christopher Randolph  
 Peter & Helen Randolph  
 Richard Rauchenberger  
 Willie Reale & Jenny Gersten  
 Theresa Rebeck & Jess Lynn  
 Herald & Linda Ritch

David & Anita Rogerson  
 Robin Morse & Gus Rogerson  
 Arthur H. Rosenbloom  
 Daryl Roth  
 Alexander Roy  
 Shirley Rumiark  
 Mark Saad  
 Steve Sabba  
 Arnold & Agnes Sametz  
 Laura Sametz  
 Elizabeth Santeix  
 Zeborah Schachtel  
 Karin & Tom Schall  
 Leslie Schine & Nils Nilsen  
 Maury Schott  
 Ken & Mary Ann Schuster  
 Richard Schwartz  
 Dana Segal  
 Stefan Selig  
 Mitchell Semel & Colleen Carroll  
 Richard Shaffer & Nataalka Bukalo  
 Aaron & Elaine Shapiro  
 Bernice Baruch Shawl  
 Abby Jo Sigal & Matt Turner  
 Meg Simon  
 Landon Slane  
 Talia Balsam & John Slattery  
 Abigail Rose Solomon  
 Jean Stein  
 Ben & Christine Stiller  
 David & Sara Stone  
 Abby Stranahan & Dave Ward  
 Paola Styron  
 Susanna Styron & Darrell Larson  
 Brian Swardstrom  
 & Bonnie Bernstein  
 Daniel Swee  
 Mariko Tada  
 Crystal Thompson  
 Gina Torres  
 Anne Torsiglieri & Michael Bernard  
 Carl & Edna Torsiglieri  
 Liz Tuccillo  
 John & Katherine Turturro  
 Laura Valeroso & David Seidman  
 Josephine Eke & Jason Valk  
 Wendy vanden Heuvel & Brad Coley  
 Ed Vassallo  
 John A. Vassallo  
 John Vassilaros & Alexandra Gersten  
 Susan Vitucci  
 Mary Pat Walsh  
 Borah & Mildred Walton  
 Maja Wampuszyc  
 Wendy Wassestein  
 Anita Waxman  
 Ann & Paul Weiss  
 Sally & Lenny Weiss  
 Jane Bolster & Steve Wertimer  
 Carol Whitesides  
 Jenny Wiener & Jon Steingart  
 Michael & Zena Wiener  
 Donald Windham

## THE 52ND STREET PROJECT

presents the Fall 2002 Playmaking Series

# STOP THE PRESSES!



## THE SENSATIONAL PLAYS

Fri., Dec. 13 at 7:30 p.m., Sat., Dec. 14 at 3:00 p.m. and 7:30 p.m.  
 and Sun., Dec. 15 at 3:00 p.m.

**HB Playwright's Foundation**

124 Bank St. in the West Village

# STOP THE PRESSES!

The Fall 2002 Playmaking Plays - Dec. 13-15, HB Playwright's Foundation

## The 52nd Street Project Staff:

Gus Rogerson, Artistic Director  
Carol Ochs, Executive Director  
John Sheehy, Director of Development and Marketing  
Megan Sandberg-Zakian, Associate Artistic Director  
George "X-Acto" Babiak, Production Manager  
Liz Bell, Director of Education  
Diana Rojas, Executive Assistant  
Chris Ceraso, Teen Dean  
Iris A. Brown, Graphic Designer  
Mayleen Cancel and Jaymaree Rosado, Receptionists  
Interns: Jolie Tong and Padma Sundaram

## Production Staff

**Composer:** Joel Derfner  
**Set Designer:** Kevin Joseph Roach  
**Lighting Designer:**  
Greg MacPherson  
**Costume Designer:**  
Crystal Thompson  
**Costume Ass't:** Jennifer Jimenez  
**Sound Designer:** Maury Schott  
**Stage Manager:** Karen Munkel  
**Slide Designers:**  
George Babiak, Mike Sell, et al  
**"STP" Illustration:** Mike Sell  
**Prop Design Team:**  
George Babiak, Roi Babiak,  
Heather Carnduff, Cara Marcous,  
Rick Meese, Leigh Pennebaker,  
Jonathan Philips, Adam Robinson,  
John Sheehy, Jolie Tong

**Furniture Crew:**  
Charlie Tocantins, Anthony Mejia  
**Prop Crew:**  
Adam Robinson, Ariana Casablanca  
**Wall Art Crew:**  
Padma Sundaram,  
Solangee Acosta  
**Load-in and Light Hang Crew:**  
Kelly Blackwell, Perry McBain  
Daniel, Doug Nervik, Rudy Katzke,  
Jonathan Philips, Chris Ryan, Mike  
Stone  
**House Managers:** Susan McGinnis,  
Karin Schall, Mary Pat Walsh,  
Liz Bell  
**Hosts:** Eric Karpeles and Mike Sell  
**Chef:** Eric Karpeles  
**Pals:** Eric Karpeles and Mike Sell



NATIONAL  
ENDOWMENT  
FOR THE ARTS

The Playmaking Program is made possible with public funds from the National Endowment for the Arts; The New York State Council on the Arts, a state agency; the Department of Youth and Community Development; and the New York City Department of Cultural Affairs Cultural Challenge Program. The 52nd Street Project is a member of Art/NY and a participant in the New Generations Program, funded by Doris Duke Charitable Foundation/The Andrew W. Mellon Foundation and administered by Theatre Communications Group, the national organization for the American Theater.

State of the Arts



NYSCA

# COOL STUFF ON SALE!

Flyer Bars .....\$2.00, \$1.50 & \$1.00

*Shel Silverstein's "Fivey and Twoey" logo gear:*

Project sweatshirts .....\$20.00

Project long sleeve t-Shirts .....\$15.00

Project Caps .....\$15.00

Project Mugs .....\$5.00

Project Pencil 3-pack .....\$1.00

"Sweet Appreciation" CD .....\$25.00

Thank you for coming to **STOP THE PRESSES**. If you are not on our mailing list (or if your address has changed), please fill out this form and give it to us on your way out or mail it to the address below. We would also like to know if you are interested in becoming a volunteer. We need help in **all areas**, so be sure to fill out the entire form.

**PLEASE ADD ME TO YOUR MAILING LIST:**

12/02

NAME: \_\_\_\_\_

ADDRESS: \_\_\_\_\_

ZIP \_\_\_\_\_

HOME PHONE: \_\_\_\_\_

DAYTIME PHONE: \_\_\_\_\_

E-MAIL ADDRESS: \_\_\_\_\_

MY OCCUPATION: \_\_\_\_\_

MY HOBBIES: \_\_\_\_\_

**YES, I WOULD LIKE TO BE OF HELP. I CAN:**

- |   |   |  |
|---|---|--|
| <input type="checkbox"/> Help load in and out for shows | <input type="checkbox"/> Draw and/or paint  | <input type="checkbox"/> Help kids with homework |
| <input type="checkbox"/> Hang lights                    | <input type="checkbox"/> Help with mailings | <input type="checkbox"/> Teach kids a skill      |
| <input type="checkbox"/> Work on a backstage crew       | <input type="checkbox"/> Do office work     | <input type="checkbox"/> Be a chef at an event   |
| <input type="checkbox"/> Do graphic design              | <input type="checkbox"/> Design sound       | <input type="checkbox"/> Design and sew costumes |
| <input type="checkbox"/> Other (please specify) _____   |   |  |

**MY SCHEDULE IS:**

- Very flexible. I'm often available during weekdays.  
 Somewhat flexible. I can help on the occasional morning or afternoon during the week.  
 Not very flexible at all, but I've got some free time on evenings and weekends.

If you would like to mail this (and you're always welcome to enclose a tax-deductible contribution), you can send it to: **The 52nd Street Project**, 500 West 52nd St., New York, NY 10019. Or fax it to (212) 333-5598.

**Don't Miss Our Upcoming Shows!**

# *All Aboard!*

## THE DEPARTURE PLAYS

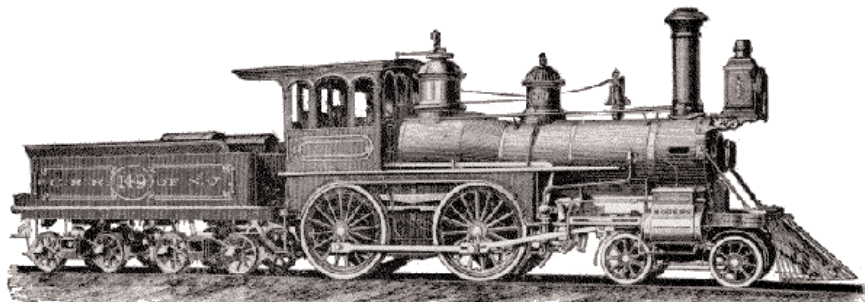

### THE 2003 TWO-ON-TWOS

Feb. 1-3, 2003 at *The Women's Interart Annex*

500 W. 52nd St., #2A (Just across the hall from the Clubhouse)

In the One-on-One's, a single kid is paired with a single adult. Now you can see *two* kids perform a play written by an adult and directed by *another* adult. Call (212) 642-5052 for reservations

# The 2003 Teen Ensemble Sonnet Scenes



Co-written by William Shakespeare  
and the teens of the 52nd Street Project

Saturday, March 1 at 7:30 p.m. and Sunday, March 2 at 3:00 p.m. at

**The Women's Interart Annex**

Call (212) 333-5252 for reservations.

The 52nd Street Project is a non-profit organization that brings children from the Hell's Kitchen neighborhood together with professional theater artists to create original theater. **STOP THE PRESSES** is a production of our Playmaking program. Young people participate in a nine-week playwriting course taught by Megan Sandberg-Zakian and adapted for the Project by Daniel Judah Sklar from his book *Playmaking: Children Writing and Performing Their Own Plays*. At the end of the course, each child is given two actors, a theme, and a dramaturg/director who guides him or her through the writing of a play during a weekend retreat in the country (Tyler Hill, Pennsylvania, for this show). Tonight's performance is the end result.

### The 52nd Street Project Board of Directors

Ben Barenholtz

Lisa Benavides

Rachel Chanoff

Cathy Dantchik

Noël Dawkins

Wendy Ettinger,

*chair emeritus*

Louis P. Friedman

Stephen Graham, *chair*

Larry Jones

James McDaniel

Frances McDormand

Patricia M. Murphy, Esq.

Carol Ochs

Willie Reale,

*founder*

Gus Rogerson

Shirley Rumierk,

*alumni member*

José Soto, Jr.,

*alumni member*

Pamala Tyson

Laura Valeroso

Wendy vanden Heuvel

John A. Vassilaros

Jenny Wiener

### Special Thanks

We're extremely grateful to **Eric Karpeles** and **Mike Sell**, who graciously allowed us to use their beautiful home in Pennsylvania as our base of operations for the writer's retreat. Thanks also to our terrific host families, the **Cobbs**, the **Pursches**, the **Rutledges**, **Sohail Raikhy**, the **Stoekles**, the **Heyns**, **Katy Homans** and **Patterson Sims**, and the **Spoerris**. We must also express our gratitude to **Billy Carden**, **David Apichell**, **Matt**, and the rest of the staff of **HB Playwright's Foundation**.

### In-Kind Contributions

Thanks must be doled out to **Neil A. Mazzella** and **Hudson Scenic Studios**; the **Murphy Law Office**; **Iris A. Brown**; **Ron Kastner** and **Capital Printing**; **Big Apple Lights**; **Coleman**; **Noggin**; **The Printing Store**; **Scholastic, Inc.**; **Diageo Chateau & Estate Wines**; **Sesame Workshop**; **Watkins, Inc.**; **Mayor's Office of Film & Television**; **Boylan's Bottling Co.**; **David Sneddon & Fairway Market**; **Andy Millon**; **Steve Olsen & The Westbank Cafe**; **Lorraine Tobias & Imaginary Studios**; **Jive Records**, part of **Zomba Music Group**; and **Prime Films**.

## STOP THE PRESSES: THE SENSATIONAL PLAYS - ACT I

All original music composed by Joel Derfner

### Spending Christmas Together for the First Time

by Mande Santiago, age 12. Dramaturg/Director: Rick Meese

Ashley .....Toya Lillard  
Skye .....Caroline Clay

"We're Spending Christmas Together for the First Time" lyrics by Mande Santiago

### The Gymnasium Place

By Mordecai Santiago, age 9. Dramaturg/Director: Joe White

Jogo .....Felix Solis  
Ogoj .....Maria Tucci  
Kids .....Anthony Mejia and the crew  
Priest .....George Babiak

### Reggie and Carlos' Adventure

by Christopher Ramirez, age 11 (He will be 12 on Saturday).  
Dramaturg/Director: Jonas Oppenheim

Reggie .....Robert Colston  
Carlos .....Christopher Randolph  
Little Girl and Dad .....Crew

"My Family" and "We're Free" lyrics by Christopher Ramirez.

### At the Park

by Johnathan Rosario, age 9. Dramaturg/Director: Erica Schmidt

Licker .....Eris Migliorini  
Player .....Michael Stuhlbarg

### Two Everlasting

by Crystal Toro, age 10. Dramaturg/Director: Danny Johnson

Falisha .....Lizzy Davis  
Jennifer .....Cara Marcous  
Principal .....Danny Johnson

"We are Teachers Too For Life" lyrics by Crystal Toro

 **Intermission!** 

## STOP THE PRESSES: THE SENSATIONAL PLAYS - ACT II

### Differences

by Bryant Acosta, age 9. Dramaturg/Director: Sascha Paladino

Joey .....Nate Corddy  
Mike .....John Conlee  
Billy Evans .....Adam Robinson  
Jasmine Lopez .....Solangee Acosta

"We Both Wanted to Win" lyrics by Bryant Acosta.

### A Stupid Cheetah

by Merlaine Mendez, age 10.

Dramaturg: Robert Sean Leonard, Director: Lizzie Gottlieb

Spotty .....Armando Riesco  
Antlers .....Saidah Arrika Ekulona

### The Way You Meet a Friend on Manhattan Streets

by Kayelani Silva, age 11. Dramaturg/Director: Kia Corthron

Ashely .....Erin Quinn Purcell  
Lovebird Rodriguez .....Abigail Lopez  
Offstage voices .....Charlie Tocantins

### Betrayed

by Isayah Muller, age 10. Dramaturg/Director: John L. Sheehy

Tazz the Dancing Freak .....Victor Rojas  
Diesel Batista .....Reg Flowers  
The Cop .....Charlie Tocantins

### The Lovers and The Fighters

By Yaiana Vasquez Tineo, age 10. Dramaturg/Director: Mary Pat Walsh

Yesinl .....Lizbeth Mackay  
Mareo .....David Eigenberg  
The Doctor .....Ariana Casablanca

"I Still Love You" lyrics by Yaiana Vasquez Tineo

*Happy*  *Holidays!*

Barker Welfare Foundation, Blythmour Corporation, Capital Research Company, Carnegie Corporation of New York, Comedy Central, Davis Polk & Wardwell, Deutsche Bank of Americas Foundation, The Dramatists Guild Fund, Dramatists Play Service, Eleanor, Adam & Mel Dubin Foundation, Entertainment Weekly, The Fan Fox & Leslie R. Samuels Fdn., The J. Paul Getty Trust, Office of Assembly Member Richard Gottfried, The Horace W. Goldsmith Foundation, Holland Lodge Foundation, Inc., Betty E. & George B. Kaiser Foundation, Lemle Pictures, Inc., Lloyds TSB Bank plc, Lucille Lortel Foundation, Lucent Technologies, James A. Macdonald Foundation, Major League Baseball, Mellon Bank, N.A., The Cynthia & George Mitchell Foundation, The National Board of Review, Newman's Own, The New World Foundation, The New York Times Co. Foundation, Paramount Pictures, Pfizer Foundation, Philip Morris Companies, Roulette Entertainment, Rytech Inc., St. James' Church, Susquehanna Partners, G.P., Theatre Communications Group, Inc., John A. Vassilaros & Son, Inc., The Vervane Foundation, West Bank Café, Felix Zarembo & Co. Inc. (List current as of 10/31/02)

Jace Alexander & Maddie Corman  
 Cecilia Arana-Grant & Kevin Grant  
 Lucie Amaz & Laurence Luckinbill  
 Debbon Ayer  
 June Ballinger & Michael Goldstein  
 Arija Bareikis  
 Ben Barenholtz  
 Benny Bartley  
 Jessica Bauman  
 Laurie Becker & Rick Sweren  
 Gregory Bello  
 Lisa Benavides & Tim Nelson  
 Vicky Bijur & Ed Levine  
 Lewis Black  
 Richard Blackstone & Yldeez Yuksek  
 Tessa Blake  
 Buzz Bovshov  
 Julie Boyd  
 Bob Boyett  
 Becky Browder & Ted Neustadt  
 Susan Bruce & Peter Hedges  
 Michael Buchanan  
 Phoebe Cates & Kevin Kline  
 Alfred C. Cerullo III  
 Rachel Chanoff  
 Sharon Chantile  
 Glenda Chesshir  
 Kirk & Katherine Holt Citron  
 Darah Cloud & Dave Owens  
 Ethan Coen & Trish Cooke  
 Ruth Cohen  
 Lieta Hesen-Cohen & Richard Cohn  
 Elizabeth Cooper Davis  
 & Gordon J. Davis  
 David Copeland  
 Hyla & Richard Crane  
 Margaret Crimmins  
 Peter & Barbara Cross  
 Emily Crow  
 Catherine Curtin  
 Willem Dafoe & Liz Lecompte  
 Nadia Dajani  
 Arthur Dantchik  
 Cathy Dantchik  
 Peter & Judith Dawkins  
 Noël Dawkins & Joe Mihalow  
 Georgia & William Delano  
 Jonathan Demme  
 Stephen DeRosa  
 Cameron Diaz  
 Buddy Dikman & Chuck Davis  
 Alex Draper & Lorraine Tobias  
 Richard & Rebecca Dresser  
 Moira Driscoll & David Pence  
 Christopher & Karen Eddowes  
 Mario Egozi  
 David Eigenberg  
 Ned Eisenberg & Patricia Dunnock  
 Beth Emelson  
 Nora Ephron  
 Barbara Ettinger & Sven Huseby  
 Heidi Ettinger  
 Wendy Ettinger & Derek McLane

Tom Feeney & Paul Parzuchowski  
 Peter Jay Fernandez & Denise Burse  
 Martin Ross Felner  
 Angelina Fiordellisi & Matt Williams  
 Anita Flanagan & Jeff Potter  
 Alexa Fogel  
 Frank Frattaroli  
 Katherine Freedman  
 Naomi Freundlich & Charles Miles  
 Louis & Patrice Friedman  
 Michael & Sonya Gaffney  
 Janeanne Garofalo  
 Rose Gasner & Larry Chertoff  
 Jonathan Gazdak  
 Cora Cahan & Bernard Gersten  
 Jilian Cahan Gersten  
 Ileen Getz & Mark Grinnell  
 Paul & Elizabeth Giamatti  
 Toni Giamatti  
 Nancy Giles  
 Lloyd & Kitty Gilmour  
 Bryan Gmitter  
 Judy Goldman & Michael Pillingier  
 Tony Goldwyn & Jane Musky  
 Fred & Nancy Goodman  
 Lizzie Gottlieb  
 Stephen & Cathy Graham  
 Michael Greif & Jonathan Fried  
 Emily Grishman & Susan Sampliner  
 Lisa Gugenheim  
 Mark & Valerie Hadjipateras  
 Lynn E. Harris  
 Jane & Jonathan Heine  
 Peter Herdrich & Karen Trott  
 Colleen Hindsley  
 William Holtzman & S. Sylvia  
 Shepard  
 Katy Homans & Patterson Sims  
 Matthew Houston  
 Barbara Howard  
 Philip & Alexandra Howard  
 Kate Hudson & Chris Robinson  
 Dana Ivey  
 Mark Evan Jacobs  
 Whitney Scott & Peter Jacobson  
 Amanda Johns  
 Andrea Johnson  
 Traci Paige Johnson  
 & Robert Mowen  
 Larry & Mary Jones  
 Maurice Kanbar  
 Eric Karpeles & Mike Sell  
 Ronald Kastner & Vanessa Boeys  
 Stephen & Sharon Kepniss  
 Judy Kuhn & David Schwab  
 Roger & Belle Kuhn  
 Allan & Nanette Larson  
 Michael P. Lawrence  
 Kate Lear & Jonathan LaPook  
 Mary Ann Lefort  
 Warren Leight  
 Robert Sean Leonard  
 Liza Lerner

Aimee Levine  
 Joshua Lewis  
 Anna Li  
 Linda Li  
 Adrienne Lobel & Mark Linn Baker  
 John Lyons  
 Grace Lyu-Volkhausen  
 Barry Mackall  
 & Bill Schwinghammer  
 Marsue & Peter MacNicol  
 Greg MacPherson  
 & Jane Perlmutter  
 Roma Maffia  
 Rusty Magee & Alison Fraser  
 Cora Cahan & Bernard Gersten  
 Elizabeth Manne  
 Donald Margulies & Lynn Street  
 Richard Marin  
 Sonya Martin  
 John Matoian  
 Kay Matschullat & Allan Arffa  
 Brigid Mccarthy  
 Fran McDormand & Joel Coen  
 Jerry McGill  
 William Michael McMahon  
 & Meg McMahon  
 Rick Meese & Dan Lori  
 Richard & Denise Menelly  
 Josie Merck & Jim Stevenson  
 Audrey & Danny Meyer  
 Nancy Meyer & Marc Weiss  
 Emily & John Morgan  
 Alfred H. Morris  
 Bob Morris  
 Meg Mortimer  
 Suzen Murakoshi  
 Patricia M. Murphy, Esq.  
 & Adam Spilka  
 Geoffrey Nauftis  
 Eric Nedelander  
 Don & Sara Nelson  
 Pamela & Peter Nelson  
 Randy & Rona Nelson  
 Ruth Nelson  
 Mark Nesselson, M.D.  
 & Elliott Rosenblum  
 Lori O'Connor  
 Kevin O'Rourke & Edith Thurber  
 Carol Ochs & Bruce MacVittie  
 Jacki Ochs & Jan Kroezee  
 Lenore Pemberton  
 Elizabeth Peters  
 Peter & Ana Rosa Phillips  
 Oliver Platt & Camilla Campbell Platt  
 Jeremy Posner  
 Dean & Leslie Potashner  
 Michael Potts  
 Christopher Randolph  
 Peter & Helen Randolph  
 Richard Rauchenberger  
 Willie Reale & Jenny Gersten  
 Theresa Rebeck & Jess Lynn  
 Herald & Linda Ritch

David & Anita Rogerson  
 Robin Morse & Gus Rogerson  
 Arthur H. Rosenbloom  
 Daryl Roth  
 Alexander Roy  
 Shirley Rumiak  
 Mark Saad  
 Steve Sabba  
 Arnold & Agnes Sametz  
 Laura Sametz  
 Elizabeth Santeix  
 Zeborah Schachtel  
 Karin & Tom Schall  
 Leslie Schine & Nils Nilsen  
 Maury Schott  
 Ken & Mary Ann Schuster  
 Richard Schwartz  
 Dana Segal  
 Stefan Selig  
 Mitchell Semel & Colleen Carroll  
 Richard Shaffer & Nataalka Bukalo  
 Aaron & Elaine Shapiro  
 Bernice Baruch Shawl  
 Abby Jo Sigal & Matt Turner  
 Meg Simon  
 Landon Slane  
 Talia Balsam & John Slattery  
 Abigail Rose Solomon  
 Jean Stein  
 Ben & Christine Stiller  
 David & Sara Stone  
 Abby Stranahan & Dave Ward  
 Paola Styron  
 Susanna Styron & Darrell Larson  
 Brian Swardstrom  
 & Bonnie Bernstein  
 Daniel Swee  
 Mariko Tada  
 Crystal Thompson  
 Gina Torres  
 Anne Torsiglieri & Michael Bernard  
 Carl & Edna Torsiglieri  
 Liz Tuccillo  
 John & Katherine Turturro  
 Laura Valeroso & David Seidman  
 Josephine Eke & Jason Valk  
 Wendy vanden Heuvel & Brad Coley  
 Ed Vassallo  
 John A. Vassallo  
 John Vassilaros & Alexandra Gersten  
 Susan Vitucci  
 Mary Pat Walsh  
 Borah & Mildred Walton  
 Maja Wampuszyc  
 Wendy Wasserstein  
 Anita Waxman  
 Ann & Paul Weiss  
 Sally & Lenny Weiss  
 Jane Bolster & Steve Wertimer  
 Carol Whitesides  
 Jenny Wiener & Jon Steingart  
 Michael & Zena Wiener  
 Donald Windham

*The 52nd Street Project Presents*



# ALL ABOOOARD!

## THE DEPARTURE PLAYS

### THE 2003 TWO-ON-TWOS

FRIDAY, JANUARY 31 AT 7:30 P.M.

SATURDAY, FEBRUARY 1 AT 3:00 & 7:30 P.M.

SUNDAY, FEBRUARY 2 AT 3:00 P.M.

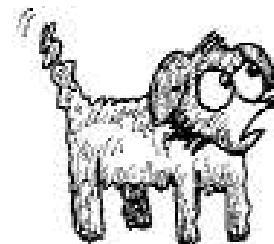

## THE WOMEN'S INTERART ANNEX

500 W. 52ND ST., #2A



THE 2003 TWO-ON-TWOS  
**ALL ABOOOOARD! THE DEPARTURE PLAYS**  
 THE WOMEN'S INTERART ANNEX - JAN. 31-FEB. 2, 2003

**The 52nd Street Project Staff:**

Gus Rogerson, Artistic Director  
 Carol Ochs, Executive Director  
 John Sheehy, Director of Development and Marketing  
 Megan Sandberg-Zakian, Associate Artistic Director  
 George "X-Acto" Babiak, Production Manager  
 Liz Bell, Director of Education  
 Diana Rojas, Executive Assistant  
 Chris Ceraso, Teen Dean  
 Iris A. Brown, Graphic Designer  
 Mayleen Cancel and Jaymaree Rosado, Receptionists  
 Interns: Alex Kranz and Jolie Tong

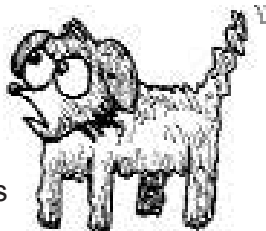

**Composer/Musical Director:**

Patrick Barnes

**Set Designer:**

Kevin Joseph Roach

**Lighting Designer:**

Greg MacPherson

**Costume Designer:**

Moe Schell

**Sound Designer:** Jeremy Posner

**Choreographer:** John Caraffa

**Stage Manager:**

Karen "K1" Parlato

**Slide Designers:**

Katherine Lumb, Richard Hicks,  
 Monty Nicol, Lee Rosen,  
 Kim Snow, Iwona Waluk,  
 and George Babiak

**"All Aboooard" Illustration:**

Leigh Pennebaker

**Prop Design Team:**

George Babiak, Chris Bonanos,  
 Rudi Katzke, Ani Kehr, Katherine  
 Lumb, Cara Marcous, Karen "K2"  
 Munkel, Samantha Padilla, Lee  
 Rosen, Jolie Tong

**Furniture Crew:**

George Babiak

**Prop Crew:** Katherine Acosta,

Alex Kranz, Johanna Vidal

**Load-in and Light Hang Crew:**

Alex Kranz, Karen "K2" Munkel,  
 Karen "K1" Parlato, Doug Nervik,  
 Nicole Watson

**House Manager:** Liz Bell,

Karin Schall, Mary Pat Walsh,

**Host and Guest Chef:** Maria Tucci

**Master Chefs:**

Carol Ochs & John Sheehy



NATIONAL  
 ENDOWMENT  
 FOR THE ARTS

The Two-on-Two Program is made possible with public funds from the National Endowment for the Arts; The New York State Council on the Arts, a state agency; and the New York City Department of Cultural Affairs. The 52nd Street Project is a member of Art/NY.

State of the Arts



NYSCA

**COOL STUFF ON SALE!**

Flyer Bars .....\$2.00, \$1.50 & \$1.00

*Shel Silverstein's "Fivey and Twoey" logo gear:*

Project Sweatshirts .....\$20.00

Project Long Sleeve T-Shirts .....\$15.00

Project Caps .....\$15.00

Project Mugs .....\$5.00

Project Pencil 3-pack .....\$1.00

"Sweet Appreciation" CD .....\$25.00

Thank you for coming to **ALL ABOOOOARD!** If you are not on our mailing list (or if your address has changed), please fill out this form and give it to us on your way out or mail it to the address below. We would also like to know if you are interested in becoming a volunteer. We need help in **all areas**, so be sure to fill out the entire form.

**PLEASE ADD ME TO YOUR MAILING LIST:**

1/03

NAME: \_\_\_\_\_

ADDRESS: \_\_\_\_\_

ZIP \_\_\_\_\_

HOME PHONE: \_\_\_\_\_

DAYTIME PHONE: \_\_\_\_\_

E-MAIL ADDRESS: \_\_\_\_\_

MY OCCUPATION: \_\_\_\_\_

MY HOBBIES: \_\_\_\_\_

**YES, I WOULD LIKE TO BE OF HELP. I CAN:**

- |   |   |  |
|---|---|--|
| <input type="checkbox"/> Help load in and out for shows | <input type="checkbox"/> Draw and/or paint  | <input type="checkbox"/> Help kids with homework |
| <input type="checkbox"/> Hang lights                    | <input type="checkbox"/> Help with mailings | <input type="checkbox"/> Teach kids a skill      |
| <input type="checkbox"/> Work on a backstage crew       | <input type="checkbox"/> Do office work     | <input type="checkbox"/> Be a chef at an event   |
| <input type="checkbox"/> Do graphic design              | <input type="checkbox"/> Design sound       | <input type="checkbox"/> Design and sew costumes |
| <input type="checkbox"/> Other (please specify) _____   |   |  |

**MY SCHEDULE IS:**

- Very flexible. I'm often available during weekdays.  
 Somewhat flexible. I can help on the occasional morning or afternoon during the week.  
 Not very flexible at all, but I've got some free time on evenings and weekends.

If you would like to mail this (and you're always welcome to enclose a tax-deductible contribution), you can send it to: **The 52nd Street Project**, 500 West 52nd St., New York, NY 10019. Or fax it to (212) 333-5598.

## Don't Miss Our Upcoming Shows!

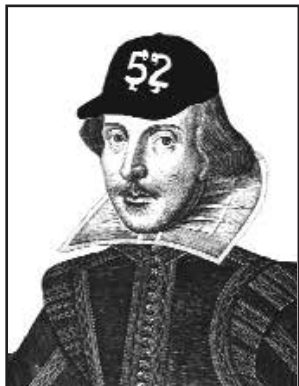

### The 2003 Teen Ensemble Sonnet Scenes

Co-written by William Shakespeare  
and the teens of the 52nd Street Project

Saturday, March 1 at 7:30 p.m. and  
Sunday, March 2 at 3:00 p.m. right here at

The Women's Interart Annex

Call (212) 642-5052 for reservations.

## KNOCK WOOD!

### THE SUPERSTITIOUS PLAYS

MARCH 28-30 AT THE  
BECKETT THEATER IN THE NEW  
THEATRE ROW COMPLEX ON 42ND ST.

THE SPRING  
PLAYMAKING  
SERIES



## HEART SOCIETY

THE 52nd Street Project

BANK JOB BENEFIT

Monday,  
May 12 at

## CAPITALE

For more  
information or  
reservations call

John

"Mr. Big"

Sheehy

at 212/333-5252.

The 52nd Street Project is a non-profit organization that brings children from the Hell's Kitchen neighborhood together with professional theater artists to create original theater. **All Aboooooard** is a production of our Two-on-Two program, in which an adult playwright crafts a piece for a pair of Project kids to perform. Another adult directs the kids for a month that includes an intensive three-day weekend in Dutchess County, New York. Tonight's performance is the final result.

### The 52nd Street Project Board of Directors

Ben Barenholtz

Lisa Benavides

Rachel Chanoff

Cathy Dantchik

Noël Dawkins

Wendy Ettinger,

*chair emeritus*

Louis P. Friedman

Stephen Graham, *chair*

Larry Jones

James McDaniel

Frances McDormand

Patricia M. Murphy, Esq.

Carol Ochs

Willie Reale,

*founder*

Gus Rogerson

Shirley Rumierk,

*alumni member*

José Soto, Jr.,

*alumni member*

Pamala Tyson

Laura Valeroso

Wendy vanden Heuvel

John A. Vassilaros

Jenny Wiener

### Special Thanks

We're grateful to **Margot, Ronnie, Paul**, and the rest of the staff at **Women's Interart Annex** for making their extremely convenient space available to us. We also owe big-time thanks to **Maria Tucci** and **Robert Gottlieb, Lili Taylor and Gerard**, and **Derek McLane** and **Wendy Ettinger**, all of whom graciously allowed us to use their upstate homes for three tumultuous and fun-filled days. Our gratitude also goes to Super Project Pal **Ron Fiorina** of **Boylan Bottling Co.**, **Mary Moore** and **D'Agostino's Supermarkets**, and board member **John A. Vassilaros** (a.k.a. Johnny Coffeeshopolis) for contributing our intermission refreshments. We are also grateful for the extraordinary amount of snow this year.

# ALL ABOOOOARD! – ACT ONE

All original music composed by Patrick Barnes,  
except where noted

## Raining Cats and Dogs

By Jonathan Bernstein. Directed by Lee Rosen

Pigeonhole . . . . . Kimani Lewis-Ashley  
Fillibuster . . . . . Anthony Mejia  
Voice of Smidge . . . . . Lee Rosen

“Scared” and “Just Jump” lyrics by Jonathan Bernstein

## Samson and Calliope

by Zabryna Guevara. Directed by Glynis Rigby.

Samson Daleworth . . . . . Wonkezeh Newenle  
Calliope . . . . . Samantha Padilla



“Amuse a Muse” lyrics by John Sheehy

## Amor Es Un Tren

By R.N Sandberg. Directed by Megan Sandberg-Zakian.

Anita/Andrea . . . . . Ivana Granados  
Rosalia/Rufina . . . . . Ariana Casablanca  
Carlos/Announcer . . . . . Gus Rogerson

“Amor Es Un Tren” lyrics by R.N. Sandberg.

 **Intermission!**   
Root Beer Floats, Coffee,  
and Flyer Bars in the lobby!

# ALL ABOOOOARD! – ACT TWO

## A Little Less Conversation

By Anne Torsiglieri. Directed by Kim Sykes.

Ralph . . . . . Mike Grullon  
Loretta . . . . . Solangee Acosta  
Announcer . . . . . Gus Rogerson  
Foreign competitors . . . . . George Babiak and Alex Kranz

“What Would Elvis Do?” music and lyrics by Josh Lewis.

## Discovering America

by Cynthia Kaplan. Directed by Becky White.

Cassie . . . . . Anastasia Kehr  
Shelly . . . . . Suzette Santana

“Shelly’s Lament” and “It’s Lonely Being a Genius” lyrics by  
Cynthia Kaplan.

## All We Gotta Do

By Michael Bernard. Directed by Joe Mihalow.

Jonathan . . . . . Jonathan Hagemeyer  
Stephen . . . . . Stephen Galimidi

“Less” lyrics by Michael Bernard.

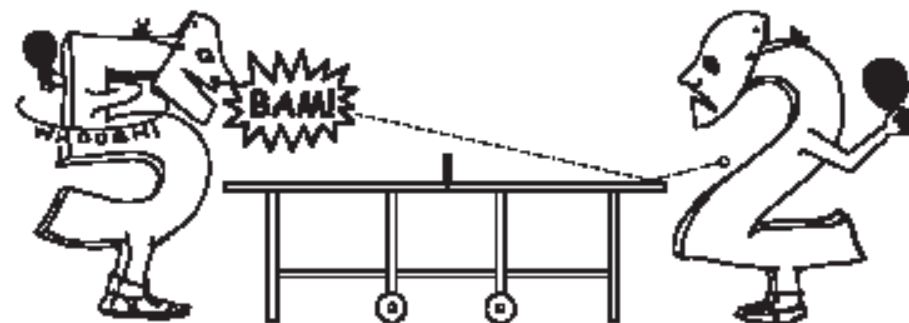

The 52nd Street Project gratefully acknowledges the following foundations and corporations: Barker Welfare Foundation, The Barnsley Foundation, Bloomberg L.P., California Comedy, Capital Research Company, Carnegie Corporation of New York, Comedy Central, Davis Polk & Wardwell, Deutsche Bank of Americas Foundation, The Dramatists Guild Fund, Dramatists Play Service, Eleanor, Adam & Mel Dubin Foundation, Entertainment Weekly, The Fan Fox & Leslie R. Samuels Foundation, The Horace W. Goldsmith Foundation, The William and Mary Greve Foundation, The Hennessy Foundation, Holland Lodge Foundation, Inc., Lloyds TSB Bank plc, Lucille Lortel Foundation, James A. Macdonald Foundation, Major League Baseball, Mellon Bank, N.A., The New World Foundation, The New York Times Company Foundation, Newman's Own, Philip Morris Companies, Rytch Inc., St. James' Church, Stranahan Foundation, Susquehanna Partners, G.P., John A. Vassilaros & Son, Inc, The Vervane Foundation, Felix Zarembo & Co. Inc. In addition the following individuals made gifts of over \$200 this year (list is current as of 3/27/03)

Jace Alexander & Maddie Corman  
Lucie Arnaz and Laurence  
Luckinbill  
Dylan & Becky Baker  
Ben Barenholtz  
Jessica Bauman  
Laurie Becker & Rick Sweren  
Lisa Benavides & Tim Nelson  
Vicky Bijur & Ed Levine  
Lewis Black  
Richard Blackstone & Yldeez  
Yukse  
Tessa Blake  
Buzz Bovshow  
Bob Boyett  
Becky Browder & Ted Neustadt  
Susan Bruce & Peter Hedges  
Alfred C. Cerullo III  
Rachel Chanoff  
Glenda Chesshir  
Kirk & Katherine Holt Citron  
Darah Cloud & Dave Owens  
Ruth Cohen  
Lieta Hesen-Cohen & Richard  
Cohn  
Tricia Cooke & Ethan Coen  
Hyla & Richard Crane  
Margaret Crimmins  
Billy Crudup  
& Mary Louise Parker  
Catherine Curtin  
Willem Dafoe & Liz Lecompte  
Arthur Dantchik  
Cathy Dantchik  
Leslie Dantchik  
Peter and Judith Dawkins  
Georgia and William Delano  
Jonathan Demme  
Richard and Rebecca Dresser  
Christopher and Karen Eddowes  
Mario Egozi  
David Eigenberg  
Ned Eisenberg & Patricia Dunnock  
Nora Ephron

Wendy Ettinger and Derek McLane  
Tom Feeney & Paul Parzuchowski  
Peter Jay Fernandez & Denise  
Burse  
Martin Ross Fetner  
Angelina Fiordellisi  
Alexa Fogel  
Frank Frattaroli  
Katherine Freedman  
Naomi Freundlich & Charles Miles  
Louis and Patrice Friedman  
Janeanne Garofalo  
Rose Gasner & Larry Chertoff  
Ileen Getz & Mark Grinnell  
Paul & Liz Giamatti  
Lloyd and Kilty Gilmour  
Judy Goldman & Michael Pillingier  
Tony Goldwyn & Jane Musky  
Stephen and Cathy Graham  
Michael Greif & Jonathan Fried  
Lisa Gugenheim  
Mark and Valerie Hadjipateras  
Jane and Jonathan Heine  
Peter Herdrich and Karen Trott  
William Holtzman & S. Sylvia  
Shepard  
Katy Homans & Patterson Sims  
Barbara Howard  
Phillip & Alexandra Howard  
Dana Ivey  
Mark Evan Jacobs  
Sy Jacobs  
Whitney Scott & Peter Jacobson  
Andrea Johnson  
Traci Paige Johnson and Robert  
Mowen  
Larry & Mary Jones  
Maurice Kanbar  
Ronald Kastner & Vanessa Boeys  
Seth and Beth Klarman  
Judy Kuhn & David Schwab  
Allan and Nanette Larson  
Michael P. Lawrence  
Mary Ann Lefort

Joshua Lewis  
Anna Li  
Linda Li  
Adrienne Lobel and Mark Linn  
Baker  
John Lyons  
Grace Lyu-Volckhausen  
Greg MacPherson & Jane  
Perlmutter  
Nat Magee & Alison Fraser  
Wendy Makkena  
& Bob Krakoway  
Kay Matschullat & Allan Arffa  
Paul McCrane and Dana Kellin  
Frances McDormand & Joel Coen  
William Michael McMahon & Meg  
Mcmahon  
Rick Meese & Dan Lori  
Richard & Denise Menelly  
Josie Merck & Jim Stevenson  
Brian Mertes  
Audrey and Danny Meyer  
Suzen Murakoshi  
Patricia M. Murphy, Esq. & Adam  
Spilka  
Don & Sara Nelson  
Ruth Nelson  
Mark Nesselson, M.D. & Elliott  
Rosenblum  
Lori O'Connor  
Kevin O'Rourke  
& Edith Thurber  
Carol Ochs & Bruce MacVittie  
Jacki Ochs & Jan Kroeze  
Elizabeth Peters  
Peter and Ana Rosa Phillips  
Oliver Platt and Camilla Campbell  
Platt  
Jeremy Posner  
Dean and Leslie Potashner  
Peter and Helen Randolph  
Richard Rauchenberger  
Willie Reale & Jenny Gersten  
Theresa Rebeck & Jess Lynn

Herald & Linda Ritch  
David & Anita Rogerson  
Robin Morse & Gus Rogerson  
Mark Saad  
Steve Sabba  
Laura Sametz  
Karin and Tom Schall  
Leslie Schine & Nils Nilsen  
Maury Schott  
Ken & Mary Ann Schuster  
Mitchell Semel & Colleen Carroll  
Tom Shadyac  
Richard Shaffer & Nataalka Bukalo  
Aaron & Elaine Shapiro  
Bernice Baruch Shawl  
Abby Jo Sigal & Matt Turner  
Meg Simon  
Talia Balsam & John Slattery  
Abigail Rose Solomon  
Jean Stein  
David and Sara Stone  
Abby Stranahan & Dave Ward  
Susanna Styron & Darrell Larson  
Brian Swardstrom & Bonnie  
Bernstein  
Daniel Swee  
Mariko Tada  
Laura Valeroso & David Seidman  
Wendy vanden Heuvel  
& Brad Coley  
Ed Vassallo  
John A. Vassallo  
Mary Pat Walsh  
Wendy Wasserstein  
Sally & Lenny Weiss  
Jane Bolster and Steve Wertimer  
Carol Whitesides  
Michael and Zena Wiener  
Donald Windham  
Joanne Woodward & Paul  
Newman  
Bill Wrubel & Jennifer Crittenden  
Jeffrey and Janine Yass  
James & Mary Lin Yoshimura

THE 52ND STREET PROJECT PRESENTS



### And from the good folks at Theatre Row...

In the event of Fire, please proceed quietly to the nearest exit. Exits are located where you entered the Theater Complex and at the back of the Stage, which you can reach by walking through any opening in the scenery or drapes on stage.

This Theater is operated by Theatre Row Studios and 42nd Street Development Corporation as a service to individuals and companies who do not have their own performance spaces. This presentation is not a Theatre Row Studios or 42nd Street Development Corporation production, nor does its presentation in this Theater imply approval or sanction by either Theatre Row Studios or 42nd Street Development Corporation.

For information on rental of this Theater, please contact Peter Bloch, General Manager - Theatre Row Studios at (212) 714 - 2442.

The use of cameras and other recording devices in this Theater is prohibited by law.

There is no smoking anywhere in this Theater or in the Theater Complex, including, lobby, stairways and restrooms.

THE WINTER 2003 PLAYMAKING SERIES  
**THE SAMUEL BECKETT THEATER**  
IN THE NEW THEATRE ROW, 410 W. 42ND ST.

FRI., MAR. 28 AT 7:30 P.M.,  
SAT., MAR. 29 AT 3:00 AND 7:30 P.M.,  
AND SUN., MAR. 30 AT 3:00 P.M.

**THE WINTER 2003 PLAYMAKING SERIES  
KNOCK WOOD: THE SUPERSTITIOUS PLAYS  
THE SAMUEL BECKETT THEATER - MAR. 28-30**

**The 52nd Street Project Staff:**

Gus Rogerson, Artistic Director  
 Carol Ochs, Executive Director  
 John Sheehy, Director of Development and Marketing  
 Megan Sandberg-Zakian, Associate Artistic Director  
 George "X-Acto" Babiak, Production Manager  
 Liz Bell, Director of Education  
 Diana Rojas, Executive Assistant  
 Chris Ceraso, Teen Dean  
 Iris A. Brown, Graphic Designer  
 Mayleen Cancel and Jaymaree Rosado, Receptionists  
 Interns: Josh Buchman, Alex Kranz, Aaron Sandfield



**Composer/Musical Director:**

Loren Toolajian

**Set Designer:**

Kevin Joseph Roach

**Lighting Designer:**

Greg MacPherson

**Costume Designer:**

Crystal Thompson

**Costume Assistant:**

Jennifer Jimenez

**Goddess of Sound:**

Vanessa Valdes

**Stage Manager:**

Katherine Lumb

**Slide Designers:**

Katherine Lumb, Richard Hicks,  
 Monty Nicol, Lee Rosen,  
 Kim Snow, Iwona Waluk,  
 and George Babiak

**"Knock Wood" Illustration:**

Heather Carnduff

**Prop Design Team:**

George Babiak, Paul Boyd, Josh  
 Buchman, Heather Carnduff, Hakim  
 Latimore, Jeff LeGreca,  
 Cara Marcous, Karen Munkel,  
 Abigail Ransmeier, Aaron Sandfield,  
 John Sheehy

**Furniture Crew:**

Erik Bowie, Alex Kranz, Alex Tomas

**Prop Crew:** Aaron Sandfield,

Josh Buchman, Ariana Casablanca

**Load-in and Light Hang Crew:**

Kelly Blackwell, Alex Kranz,  
 Karen Munkel, Doug Nervik,  
 Christopher Randolph, Chris Ryan,  
 Aaron Sandfield, Jolie Tong,  
 Jason Wells

**House Managers:** Liz Bell,

Karin Schall, Mary Pat Walsh

**Weekend Hosts:**

Stephen and Cathy Graham



NATIONAL  
 ENDOWMENT  
 FOR THE ARTS

The Playmaking Program is made possible with public funds from the National Endowment for the Arts; The New York State Council on the Arts, a state agency; and the New York City Department of Cultural Affairs. The 52nd Street Project is a member of Art/NY.

State of the Arts



**COOL STUFF ON SALE!**

Flyer Bars .....\$2.00, \$1.50 & \$1.00

*Shel Silverstein's "Fivey and Twoey" logo gear:*

Project T-Shirts .....\$12.00

Project Caps .....\$15.00

Project Mugs .....\$5.00

Project Pencil 3-pack .....\$1.00

"Sweet Appreciation" CD .....\$25.00

Thank you for coming to **KNOCK WOOD!** If you are not on our mailing list (or if your address has changed), please fill out this form and give it to us on your way out or mail it to the address below. We would also like to know if you are interested in becoming a volunteer. We need help in **all areas**, so be sure to fill out the entire form.

**PLEASE ADD ME TO YOUR MAILING LIST:**

3/03

NAME: \_\_\_\_\_

ADDRESS: \_\_\_\_\_

ZIP \_\_\_\_\_

HOME PHONE: \_\_\_\_\_

DAYTIME PHONE: \_\_\_\_\_

E-MAIL ADDRESS: \_\_\_\_\_

MY OCCUPATION: \_\_\_\_\_

MY HOBBIES: \_\_\_\_\_

**YES, I WOULD LIKE TO BE OF HELP. I CAN:**

- |   |   |  |
|---|---|--|
| <input type="checkbox"/> Help load in and out for shows | <input type="checkbox"/> Draw and/or paint  | <input type="checkbox"/> Help kids with homework |
| <input type="checkbox"/> Hang lights                    | <input type="checkbox"/> Help with mailings | <input type="checkbox"/> Teach kids a skill      |
| <input type="checkbox"/> Work on a backstage crew       | <input type="checkbox"/> Do office work     | <input type="checkbox"/> Be a chef at an event   |
| <input type="checkbox"/> Do graphic design              | <input type="checkbox"/> Design sound       | <input type="checkbox"/> Design and sew costumes |
| <input type="checkbox"/> Other (please specify) _____   |   |  |

**MY SCHEDULE IS:**

- Very flexible. I'm often available during weekdays.  
 Somewhat flexible. I can help on the occasional morning or afternoon during the week.  
 Not very flexible at all, but I've got some free time on evenings and weekends.

If you would like to mail this (and you're always welcome to enclose a tax-deductible contribution), you can send it to: **The 52nd Street Project**, 500 West 52nd St., New York, NY 10019. Or fax it to (212) 333-5598.

## Don't Miss Our Upcoming Shows!

# HEART SOCIETY

THE 52nd Street Project

BANK JOB BENEFIT

Monday, May 12 at "Capitale"

For more information or reservations call  
John "Mr. Big" Sheehy at 212/333-5252

WILLIAM SHAKESPEARE'S

# AS YOU LIKE IT



ADAPTED BY CHRIS CERASO AND  
THE TEENS OF THE 52ND STREET PROJECT

DIRECTED BY MICHAEL BERNARD

## WORLD TOUR!

JUNE 27 - NEW YORK CITY - LOCATION T.B.A.  
JUNE 30 - LONDON - HARROW SCHOOL  
JULY 4 - LORGUES, FRANCE - CHATEAU DE BERNE

The 52nd Street Project is a non-profit organization that brings children from the Hell's Kitchen neighborhood together with professional theater artists to create original theater. **KNOCK WOOD** is a production of our Playmaking program. Young people participate in a nine-week playwriting course taught by **Megan Sandberg-Zakian** and adapted for the Project by **Daniel Judah Sklar** from his book *Playmaking: Children Writing and Performing Their Own Plays*. At the end of the course, each child is given two actors, a theme, and a dramaturg/director who guides him or her through the writing of a play during a weekend retreat in the country (Kent, Connecticut, for this show). Tonight's performance is the end result.

### The 52nd Street Project Board of Directors

Ben Barenholtz	Carol Ochs
Lisa Benavides	Willie Reale, <i>founder</i>
Rachel Chanoff	Gus Rogerson
Cathy Dantchik	Shirley Rumierk, <i>alumni member</i>
Noël Dawkins	José Soto, Jr., <i>alumni member</i>
Wendy Ettinger, <i>chair emeritus</i>	Pamala Tyson
Louis P. Friedman	Laura Valeroso
Stephen Graham, <i>chair</i>	Wendy vanden Heuvel
Larry Jones	John A. Vassilaros
James McDaniel	Jenny Wiener
Frances McDormand	
Patricia M. Murphy, Esq.	

### Special Thanks

We're grateful to **Stephen and Cathy Graham** for graciously allowing us to bring the chaos of a Playmaking weekend to their lovely home in Kent, Connecticut. Their staff, including **Jeannie** and **Chef Eric**, get a round of applause, too. Thanks also go to **Sam and Lynn Waterston**, and **Oliver and Camilla Platt** for providing overnight accommodations.

Thanks also to **Charlie Tocantins**, **Blair Slinger** and **Madeleine George** for helping out in Playmaking class.

## KNOCK WOOD: THE SUPERSTITIOUS PLAYS – ACT I

All original music composed by Loren Toolajian

### **The 92 That Changed Everything**

by Nicole Fargardo, age 12. Dramaturg/Director: Maury Schott

Jesse .....Phyllis Somerville  
Joshua .....Alex Draper

*"The Dessert Song"* lyrics by Nicole Fargardo

### **Coney Island Wedding Deal**

By Steven Castellanos, age 9. Dramaturg: Kurt Wootton

Director: John Steber

Alligator .....Kenajuan Bentley  
Turtle of Life .....Sonia Manzano  
Rope handlers .....Alex Tomas, Ariana Casablanca

### **The Audition**

by Aladino Olivares, age 12. Dramaturg/Director: Greg Allen

Anthony .....Joel de la Fuente  
Ms. Jackson/Mom .....Malinda Walford  
Kid #1 .....Alex Tomas  
Kid #2 .....Ariana Casablanca

### **Raven's Bad Luck**

by Christine Tomas, age 10. Dramaturg/Director: Sandra McClain

Raven .....Mandy Gonzalez  
Madam Venus .....Shirley Rumierk  
Raven's Client .....Alex Kranz  
Cauldron bearer .....Alex Tomas  
Cop .....Ariana Casablanca

### **Reunited**

by Amanda Santos, age 12. Dramaturg/Director: Denise Burse

Alfedi .....Jose Soto  
Glaefideat .....Angel Desai

*"Apple Green Lullaby," "What Have I Done,"* and *"I Feel So Bad"* lyrics

by Amanda Santos



## KNOCK WOOD: THE SUPERSTITIOUS PLAYS – ACT II

### **The Man That Rules Us All**

by Isaac Goodman-Boyd, age 10. Dramaturg/Director: George Babiak

George W. Bush .....Kevin O'Rourke  
Taylor .....Josh Lewis  
Secret Service agents .....Josh Buchman, Aaron Sandfield  
*"No Violence," "Alone,"* and *"Bush's Feeling of War"* lyrics by Isaac  
Goodman-Boyd.

### **The Wish**

by Erica Arce, age 9. Dramaturg/Director: Nicole Watson

Eve .....Sarah Kay  
Spot .....Perry McBain-Daniel

### **The Clown Destroyer**

by Harlo Ulloa, age 9. Dramaturg/Director: Louise Andrews

Killer Kid .....Frank Wood  
Police Hero .....David Chandler  
Partygoers .....The Crew

### **Alone**

by Skye Blu Welsh, age 12. Dramaturg/Director: Sheryl Kaller

Nevaeh .....Elise Hernandez  
Heaven .....Julia Gibson

### **Fighting in the Sewers**

By Jose Martinez, age 10. Dramaturg/Director: Larry Nathanson

Spike Shell Iguana .....Ben Shenkman  
Crabhead Chicken .....Catherine Mueller  
*"Getting Red Hot"* and *"Let's Just Be Friends"* lyrics by Jose Martinez

### *IN MEMORIAM*

*These shows are being performed in memory of our beloved friend and volunteer, **Rusty Magee** (1955-2003), who composed over 100 songs for the Project. Some of these songs are being played in the house before the first act and during the intermission.*

*The performers on the recording are **David Costabile, Nancy Giles, Judy Kuhn, Michael Potts, Myra Lucretia Taylor, Mary Testa, Anne Torsiglieri, Karen Trott, and Lee Wilkof.** The production was done by Loren Toolajian at Broadway Sound. Many thanks to Alison Fraser and Sheryl Kaller.*

The **52nd Street Project Teen Ensemble** is a two-year program for graduates of The Project's writing and acting programs. The Teen Ensemble focuses on professional level acting technique by using both original and existing texts. The culmination of the program is the production of a play by William Shakespeare as adapted by the ensemble. The most recent teen production, **The Tempest**, was performed in the United Kingdom in the summer of 2001 at **Teatro Technis** in London and in Debenham, Suffolk. The teens you see tonight will journey to England and France this summer to present their own version of a Shakespeare play. The title remains top-secret.

### The Project Staff

Gus Rogerson . . . . .Artistic Director  
 Carol Ochs . . . . .Executive Director  
 John Sheehy . . . . .Director of Development  
 Megan Sandberg-Zakian . . . . .Associate Artistic Director  
 George Roman Babiak . . . . .Production Manager  
 Liz Bell . . . . .Director of Education  
 Chris Ceraso . . . . .Teen Dean  
 Iris A. Brown . . . . .Graphic Designer  
 Mayleen Cancel, Jaymaree Rosado . . . . .Receptionists  
 Alex Kranz . . . . .Intern

### The 52nd Street Project Board of Directors

Ben Barenholtz	Carol Ochs
Lisa Benavides	Willie Reale, <i>founder</i>
Rachel Chanoff	Gus Rogerson
Cathy Dantchik	Shirley Rumierk, <i>alumni member</i>
Noël Dawkins	José Soto, Jr., <i>alumni member</i>
Wendy Ettinger, <i>chair emeritus</i>	Pamala Tyson
Louis P. Friedman	Laura Valeroso
Stephen Graham, <i>chair</i>	Wendy vanden Heuvel
Larry Jones	John A. Vassilaros
James McDaniel	Jenny Wiener
Frances McDormand	
Patricia M. Murphy, Esq.	

The Project would like to thank **Margot Lewitin, Ronnie Geist, Paul Smithyman**, and **Women's Interart** for generously allowing us to use their space.

## The 52nd Street Project Presents



# 2003 Sonnet Scenes

*Co-written by William Shakespeare  
 and the Teens of the 52nd Street Project*

*Saturday, March 1st at 7:30 p.m.  
 Sunday, March 2nd at 3:00 p.m.*

*The Women's Interart Annex  
 500 W. 52nd St.*



# 2003 Teen Sonnet Scenes

## Go Fish

By Noel Polanco from Sonnet #64

Dramaturg/Director: Kate Marks

José .....Noel Polanco  
Addia .....Jaya Rosado

## Subservientus Ignoramus

By Anju Andre-Bergmann from Sonnet #57

Dramaturg/Director: Catherine Mueller

Minnie Mae Fredda Hedda Dubois .....Anju Andre-Bergmann  
Louisa Dubois .....Aisha Lena Jabour

## Creative Will

By Matthew Jellison from Sonnet #35

Dramaturg/Director: Michael Bernard

William Sopheman .....Matthew Jellison  
Richard Arson III .....Osage Lewis-Ashley

## One-Way Trip

By Jaya Rosado from Sonnet #44

Dramaturg/Director: Diana Rojas

Christy .....Jaya Rosado  
Lesley .....Anju Andre-Bergmann

## High Skoo Chronicle

By Osage Lewis-Ashley from Sonnet #34

Dramaturg/Director: Nancy Giles

Malik .....Osage Lewis-Ashley  
Vanessa .....Mayleen Cancél

## Chris and Lisa: The Loved Ones

By Johnathan Roldan from Sonnet #130

Dramaturg/Director: George Babiak

Chris .....Johnathan Roldan  
Lisa .....Natalie Musteata  
The Waiter .....Matthew Jellison

## One Girl Waiting

By Aisha Lena Jabour from Sonnet #109

Dramaturg: Chris Ceraso, Director: Jeanne Simpson

20 .....Aisha Lena Jabour  
10 .....Jennifer Jimenez

## White and Black

By Natalie Musteata from Sonnet #147

Dramaturg/Director: Josh Lewis

Alba .....Natalie Musteata  
Pierce .....Noel Polanco

## Thy Love

By Mayleen Cancel from Sonnet #91

Dramaturg/Director: Ceci Arana

Krissy .....Mayleen Cancél  
Krishna .....Matthew Jellison

## Jumping Giraffes In Monkey Soup or Peeps

By Jennifer Jimenez from Sonnet #23

Dramaturg/Director: Megan Sandberg-Zakian

Stokely .....Jennifer Jimenez  
William .....Noel Polanco

Stage Manager and Light Operator: Erik Bowie  
Sound Operator: Alex Kranz

# Intermission!

Corporate Hosts

Ars Nova PGM

Louis Friedman, Bear Stearns

Tobak-Dantchik Events

and the Board of Directors of The 52nd Street Project present

# HEIST SOCIETY



**MONDAY, MAY 12, 2003 AT CAPITALE**

**BOARD CHAIR**

Stephen Graham

**ARTISTIC DIRECTOR**

Gus Rogerson

**EXECUTIVE DIRECTOR**

Carol Ochs

## CO-CHAIRS

Lisa Benavides  
Becky Browder  
Cathy Dantchik  
Louis P. Friedman

Patrice Friedman  
Karin Schall  
Laura Valeroso  
Mary Pat Walsh

Jenny Wiener

## THE BOARD OF DIRECTORS

Ben Barenholtz  
Lisa Benavides  
Rachel Chanoff  
Cathy Dantchik  
Noël Dawkins  
Wendy Ettinger, *chair emeritus*  
Louis P. Friedman  
Stephen Graham, *chair*  
Larry Jones  
James McDaniel  
Frances McDormand

Patricia M. Murphy, Esq.  
Carol Ochs  
Willie Reale, *founder*  
Gus Rogerson  
Shirley Rumierk, *alumni member*  
José Soto, Jr., *alumni member*  
Pamala Tyson  
Laura Valeroso  
Wendy vanden Heuvel  
John A. Vassilaros  
Jenny Wiener

## THE 52ND STREET PROJECT GRATEFULLY ACKNOWLEDGES...

Stephanie Berger  
Iris A. Brown  
Bourjois  
Capital Printing/Ronald J. Kastner  
Kenneth Cole Productions  
Diageo Chateau & Estate Wines Co.  
Entertainment Weekly  
Alison Fraser  
Neil Mazzella and Hudson Scenic Studios  
Jive Records/A division of Zomba Music Group  
Newman's Own  
Noggin  
The Printing Store  
Scholastic, Inc.  
Sesame Workshop  
Wendy Stulberg  
Tarte, Inc.  
Terax America  
John A. Vassilaros & Sons  
Watkins Incorporated  
*Healthier Living Since 1868*



## HEIST SOCIETY: THE SHOW

### THE CAST

Lola .....Lili Taylor  
Rocky .....Oliver Platt  
Sweet Talk Santiago .....Mordecai Santiago  
Sister Margarita .....Roma Maffia  
Sister Cosmo .....Solangee Acosta  
Sister Rob Roy .....Mandy Gonzalez  
Officer Clemente .....David Zayas  
Officer Mendoza .....Alex Tomas  
Tommy .....Anthony Mejia  
Ma .....Jazzlyn Rosado

### LYRICS BY

Willie Reale

### MUSIC BY

Henry Krieger

### DIRECTED BY

Jonathan Bernstein

### MUSIC DIRECTOR

Kari Swenson Riely

### WRITTEN BY

Willie Reale and John Sheehy

### SET CHOREOGRAPHER

Kevin Joseph Roach

### LIGHTING DESIGN

Greg MacPherson and Jason Wells

### COSTUME DESIGN

Crystal Thompson

### SOUND DESIGN

Scott Lehrer

### STAGE MANAGER

Hank Meiman

### FOAMCORE DESIGNS

George Babiak

### MUSIC COPYIST

Kim D. Sherman

## CRIMINAL MASTERMINDS

Arthur Dantchik  
Cathy Dantchik  
Patrice & Louis Friedman, Bear Stearns  
Jenny Wiener & Jon Steingart, Ars Nova  
Jeffrey Yass

## GRAND LARCENERS

Wendy Ettinger & Derek McLane  
Angelina Fiordellisi & Matt Williams  
Cathy & Stephen Graham  
Joanne Woodward & Paul Newman

## HIGHWAY ROBBERS

Bloomberg  
Tom Cruise  
The Dawkins Family Foundation  
Heidi Ettinger  
Alexandra Gersten-Vassilaros & Johnny Coffeeshopolis  
Frances & Colin Greer, The New World Foundation  
Maurice Kanbar  
Fred Nelson, Entertainment Weekly  
Ana Rosa & Peter Phillips, Lloyds TSB  
Maury Schott  
Laura Valeroso & David Seidman  
Wendy vanden Heuvel

## HOLD-UP MEN & WOMEN

Alfred C. Cerullo III	Sonia Manzano & Richard Reagan
Comedy Central	Josephine Merck & Jim Stevenson
Leslie Dantchik	Audrey & Danny Meyer
Mario Egozi	Jane Musky & Tony Goldwyn
Chrysti & David Eigenberg	Rona & Randolph Nelson
Sandi & Andrew Farkas	Jane Perlmutter & Greg MacPherson
Alexa L. Fogel	Anita A. & David S. Rogerson
Nancy Giles	Michael Ritchie
Jane & Jonathan Heine	Steve Sabba
Julia Johns	Leslie Schine & Nils Nilsen
Andrea Johnson	Karen Trott & Peter Herdrich
Mary Kong	Mr. & Mrs. William J. vanden Heuvel
John S. Lyons	Wendy Wasserstein
Grace Lyu-Volckhausen, Tiger Baron Foundation	Brenda Wehle & John C. Lynch



## STICKY FINGERS

Cecilia Arana-Grant & Kevin Grant  
Adam Leitman Bailey  
Becky & Dylan Baker  
June Ballinger & Michael Goldstein  
Ben Barenholtz  
Courtney Baron & Blair Singer  
Lisa Benavides & Tim Nelson  
Myra & Barry Bernard  
Jamie Bernstein  
Vicky Bijur & Ed Levine  
Tessa Blake & Ian Williams  
Jane Bolster & Steve Wertimer  
Katherine Borowitz & John Turturro  
Julie Boyd  
Kathryn Briggs, Dramatists Play Service, Inc.  
Becky Browder & Ted Neustadt  
Deborah Brown  
Michael Buchanan & Marcus Astafan  
Denise Burse & Peter Jay Fernandez  
Cori Cahan & Bernard Gersten  
Colleen Carroll & Mitchell Semel  
Rachel Chanoff  
Sharon Chantiles  
Maddie Corman & Jace Alexander  
Catherine Corpeny & Max D. Mayer  
William Coury  
Anna E. Crouse  
Jennifer Crittendon & Bill Wrubel  
Paula Devicq & Joe Taylor  
Rebecca & Richard Dresser  
Julie Dretzin  
Karen & Christopher Eddowes  
Amy & Gary Ehrlich  
Josephine Eke  
Beth Emelson  
Tom Feeney & Paul Parzuchowski  
Liz Flahive  
Andrew Flatt  
Barbara Fleck-Paladino  
Alison Fraser & Nat Magee  
Janeane Garofalo  
Jenny Gersten &  
Willie Reale  
Jilian Cahan Gersten  
Elizabeth & Paul Giamatti  
Kilty & Lloyd Gilmour  
Bryan Gmitter  
Judy Goldman & Michael Pillinger  
Carol & Larry Goldstein

Amy & George Goldstein  
Mark Gorman & Michael Sporn  
Connie Grappo & Lee Wilkof  
Sarah Grate  
Kimberly Grigsby  
Flavia & Ed Grimm  
Emily Grishman & Susan Sampliner  
Evan Handler  
John Benjamin Hickey  
Amy Herzig  
Katy Homans & Patterson Sims  
Sarah Horowitz & David Venarde  
Barbara Howard  
Jean & Ron Jacobs  
Amanda Johns  
Marcy & Max Kahn  
Sheryl Kaller & Scott Zaretsky  
Sarah Kay & Josh Lewis  
Beth & Seth Klarman  
Belle & Roger Kuhn  
David Kuhn  
Judy Kuhn & David Schwab  
Fran Kumin & Richard Tickin  
Warren Leight  
Robert Sean Leonard  
Liza Lerner  
Douglas Lockwood  
Peter Manning  
Lisa Maris  
Sonya Martin  
Kari McCabe & Nate McBride  
Brigid McCarthy  
Frances McDormand & Pedro Coen  
Andrea, Jon & Julia Miller  
Rebecca Miller & Daniel Day-Lewis  
Suzen Murakoshi & Mark Temme  
Patricia Murphy & Adam Spilka  
Margaret Norden & Joseph Gazdak  
Carol Ochs & Bruce MacVittie  
Jacki Ochs & Jan Kroeze  
Elise Pettus & Dan Algrant  
Jeremy M. Posner  
Christopher Randolph  
Joan Reibman  
Nancy & Fred Rosen  
Rosenzweig & Maffia LLP  
Daryl Roth  
Martha Roth & Bill Irwin  
Joyce Rudnick



Shirley Rumierk  
Tatiana Rutkowsky & Andrew Blackman  
Agnes & Arnold Sametz  
Laura Sametz & Anton Fig  
Tim Sanford  
Stephanie Schaich  
Karin & Thomas Schall  
Erica Schmidt  
Sarah Schulman  
Seret Scott  
Whitney Scott & Peter Jacobson  
Stefan M. Selig  
Robert Shaffron & John Steber  
Sloane Shelton  
Sylvia Shepard & Willy Holtzman  
Landon Slane  
Helen Stambler & James Neuberger  
Abbot Stranahan & David Ward  
Alexandra Styron & Ed Beason  
Susanna Styron & Darrell Larson

Edith Thurber & Kevin O'Rourke  
Lorraine Tobias & Alex Draper  
Anne Torsiglieri & Michael Bernard  
Wendy Townsend & Mark Keoppen  
Maria Tucci & Robert Gottlieb  
Cynthia Vance & Robert Abrams  
Susan J. Vitucci  
Mary Pat Walsh  
Maja Wampuszyc  
Anita Waxman  
Amanda Weil  
Dean Wetherell  
Carol J. Whitesides  
Dana Williams & Don Scardino  
Elizabeth Williams & Joseph Forte  
Rita Wilson & Tom Hanks  
Carole Yass, Randy Ginsburg &  
Jerry Yass  
Yildiz Yuksek & Richard Blackstone  
V.A. Zakian & R.N. Sandberg

List current as of 5/7/03

## THE 52ND STREET PROJECT STAFF

Gus Rogerson, Artistic Director  
Carol Ochs, Executive Director  
John Sheehy, Director of Development and Marketing  
George Babiak, Production Manager  
Megan Sandberg-Zakian, Associate Artistic Director  
Liz Bell, Director of Education  
Chris Ceraso, Teen Dean  
Diana Rojas, Executive Assistant  
Iris A. Brown, Graphic Designer  
Alex Kranz, Intern

## BENEFIT VOLUNTEERS

Heather Carmuff-Gobbée, Perry McBain Daniel, Adam Felber,  
Lucas Fleischer, Danny Goldstein, Zabryna Guevara,  
Eris Migliorini, Catherine Mueller, Kim D. Sherman,  
Jeanne Simpson, Walter Trarbach, Vanessa Valdes, Ed Vassallo

## SPECIAL THANKS

Becky Browder, William Curran, Beth Emelson, Liz Flahive,  
Terry Fitzpatrick, Amy Friedman, Jenny Gersten, Nancy Giles,  
Bryan Gmitter, Mark Jacobs, John Laird, Barbara McCrane,  
Suzen Murakoshi, Stephen Pempeluk, Christopher Randolph,  
Karin & Tom Schall, Mary Pat Walsh

**The 52nd Street Project** is a non-profit organization that brings children from the Hell's Kitchen neighborhood together with professional theater artists to create original theater. The Replay program gives children who are graduates of the Project's Playmaking Class a chance to hone their skills in an advanced writing workshop taught by Megan Sandberg-Zakian. Over the nine weeks of Replay class, these nine young playwrights have explored different sources of inspiration, visiting the park, the theater and an art museum. The resulting plays are featured in tonight's reading.

### Special Thanks

We're grateful to **Steve Olson, Hank Meiman, and The West Bank Cafe** for making this evening possible. The plays wouldn't have made it to the page or the stage without the help of the Replay class volunteers: **Alex Kranz, Edward O'Blenis, Lenore Pemberton, Jolie Tong, Joe Zarrow,** and special guest lecturer, Project Founder **Willie Reale**. Thanks also to Willie for hooking us up with tickets to the best show in town, ***A Year With Frog and Toad***. Thanks to **HCC** for the loan of valuable rehearsal space.

### The Project Staff

Gus Rogerson ..... Artistic Director  
Carol Ochs ..... Executive Director  
John Sheehy ..... Director of Development  
Megan Sandberg-Zakian ..... Associate Artistic Director  
George Roman Babiak ..... Production Manager  
Liz Bell ..... Director of Education  
Diana Rojas ..... Executive Assistant  
Chris Ceraso ..... Teen Dean  
Iris A. Brown ..... Graphic Designer  
Mayleen Cancel, Jaymaree Rosado ..... Receptionists  
Alex Kranz ..... Intern

### The 52nd Street Project Board of Directors

Ben Barenholtz	Carol Ochs
Lisa Benavides	Willie Reale, <i>founder</i>
Rachel Chanoff	Gus Rogerson
Cathy Dantchik	Shirley Rumierk, <i>alumni member</i>
Noël Dawkins	José Soto, Jr., <i>alumni member</i>
Wendy Ettinger, <i>chair emeritus</i>	Pamala Tyson
Louis P. Friedman	Laura Valeroso
Stephen Graham, <i>chair</i>	Wendy vanden Heuvel
Larry Jones	John A. Vassilaros
James McDaniel	Jenny Wiener
Frances McDormand	
Patricia M. Murphy, Esq.	

The 52nd Street Project Presents

---

# THE 2003 REPLAY READING

---

Nine plays by  
nine young playwrights

Monday, June 2, 2003

The Laurie Beechman Theater  
at The West Bank Cafe  
407 West 42nd St., NYC

# THE 2003 REPLAY READING

These plays will be performed without an intermission.

## Violet's Revenge

By Chassity Damiani, age 11

Director: John Sheehy

Violet .....Martha Plimpton  
Old Lady/Mom/Child in City .....Nancy Chatty  
Cloudman .....John Sheehy  
Meltman/Doctor .....Alex Draper

## When Bad Things Go Good

By Mordecai Santiago, age 9

Director: George Babiak

Mike .....Ray Thomas  
Billy .....Doc Dougherty  
Mom .....Phyllis Somerville

## Future World

By Megan Cruz, age 12

Director: Megan Sandberg-Zakian

Andrew/Police .....Joe Zarrow  
Mango .....Myra Lucretia Taylor  
Alexis .....Lenore Pemberton  
Miss Charity/Edith .....Diana Rojas

## Woman and Man

By Yaiana Vasquez Tineo, age 10

Director: Mary Pat Walsh

Mama .....Sonia Manzano  
Man .....Peter Maloney

## Free Will

By Eddie Cuevas, age 13

Director: Dion Graham

B-EZ .....Robert Jimenez  
Mr. Rocafella .....Armando Riesco  
FeeZee/Crowd .....Dion Graham

## Just Because We're Related

Doesn't Mean We Have to Get Along

By Jazzlyn Hernandez, age 12

Director: Seret Scott

Lizette .....Marsha Stephanie Blake  
Justin .....Peter Jacobson  
Carleen Ramos .....Florencia Lozano  
Carleen Ramaros .....Jeanne Simpson

## One Chance

By John Cuevas, age 12

Director: Peter Jay Fernandez

Mike .....Kevin Jackson  
Joey .....Paul Butler  
Vince Carter .....Peter Jay Fernandez  
Mom .....Liz Bell

## Death

By Merlaine Mendez, age 11

Director: Tim Blake Nelson

Charlene .....Lisa Benavides  
Death .....Chris Welch  
Amy/Mom .....Catherine Mueller  
Kids/Doctor .....Tim Blake Nelson

## Gossip Womans

By Christopher Ramirez, age 12

Director: Erica Schmidt

Mrs. Poma .....Kathryn Meisle  
Mrs. Luz .....Kate Forbes  
Mrs. Edward .....Shirley Rumierk  
Mr. Edward/Mr. Luz .....Alex Kranz  
Police .....Jonas Oppenheim

Light Operator and Good Pal: Hank Meiman

Gus Rogerson, Artistic Director

Carol Ochs, Executive Director

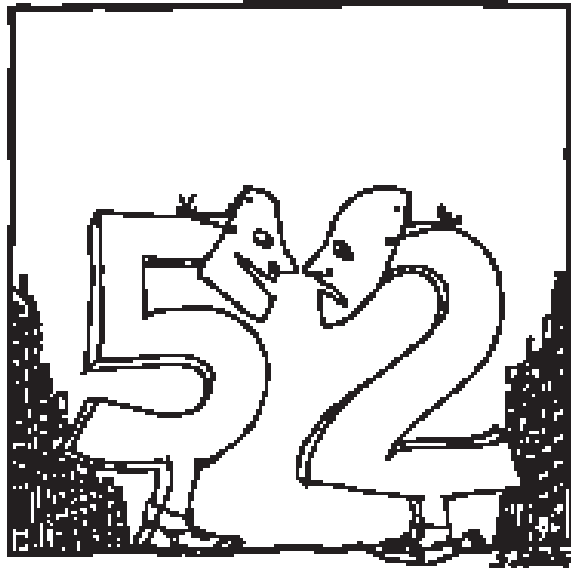

## The 52nd Street Project

*The following foundations and government agencies have generously supported the Teen Program through their contributions:*

City of New York Department of Cultural Affairs  
Horace W. Goldsmith Foundation  
National Endowment for the Arts  
New York State Council on the Arts  
The Surdna Foundation



The 52nd Street Project is a participant in the **New Generations Program**, funded by **Doris Duke Charitable Foundation/The Andrew W. Mellon Foundation** and administered by **Theatre Communications Group**, the national organization for the American theatre.



The 52nd Street Project  
*presents*

# AS YOU LIKE IT

*"Comme Il Vous Plaira"*

The  
2003  
World  
Tour

By William Shakespeare

Directed by  
Michael Bernard

Adapted by  
Chris Ceraso  
and The 52nd Street Project Teens

New York City: June 27 - Theater at St. Clement's  
London, England: June 30 - Harrow School  
Lorgues, France: July 4 - Château de Berne

### The 52nd Street Project

The 52nd Street Project (The Project) is dedicated to the creation and production of new plays for, and often by, kids between the ages of ten and eighteen who reside in the Hell's Kitchen neighborhood in New York City. The Project does this through unique mentoring programs that matches kids with professional (and volunteer!) theater artists.

The Project is about making children proud of themselves. The Project is not about teaching children to act, although they will learn to. It is not about teaching them to write plays, although they will learn that as well. What it is about is giving a kid an experience of success. It is about giving a kid an opportunity to prove that he or she has something of value to offer, something that comes from within that he or she alone possesses, something that cannot be taken away.

The Project's Teen Ensemble is the final step in the kids' training: a two-year acting class that culminates in the production of a full-length play by William Shakespeare, the very one you are seeing tonight. This year's show, the most ambitious one to date, takes us to three cities in three countries. We are very grateful to our gracious European hosts for enabling this tour.

### Le Projet de la 52ème Rue

Le Projet de la 52ème Rue est consacré à la création et production de nouvelles pièces de théâtre écrites pour, et souvent par, des jeunes de neuf à dix-huit ans qui habitent le quartier de Hell's Kitchen (Cuisine de L'enfer) à New York. Le Projet apparie ces jeunes avec des artistes de théâtre professionnels qui leur servent de mentor.

Le Projet a pour but principal l'épanouissement de l'amour-propre des enfants. Ce n'est pas une école de théâtre, bien que les enfants deviennent souvent de très bons comédiens et auteurs dramatiques. Le Projet vise plutôt à créer une ambiance dans laquelle l'enfant peut ressentir ce que c'est de réussir. En donnant aux enfants l'occasion de s'exprimer, le Projet les encourage à reconnaître qu'ils ont une voix unique, qu'elle a de la valeur, et qu'elle mérite d'être entendue.

L'Ensemble Adolescent du Projet représente la dernière étape dans la formation des jeunes: un cours de théâtre de deux ans sur l'art de jouer la comédie, menant à la production de la pièce de William Shakespeare à laquelle vous allez assister ce soir. C'est de loin la production la plus ambitieuse que nous avons montée. Elle sera jouée dans trois villes, et trois pays, différents. Nous remercions nos hôtes Européens pour leur générosité, sans laquelle cette tournée n'aurait pas été possible.

## The Cast -L'Ensemble

Orlando	Osage Lewis-Ashley
Adam/Hymen	Michael Bernard
Oliver/Silvius	Matthew Jellison
El Lobo/William	Johnathan Roldan
Rosalind	Mayleen Cancel
Celia	Anju Andre-Bergmann
Touchstone	Noel Polanco
La Belle/Amelia	Natalie Musteata
Duke Frederick	Chris Ceraso
The Duchess	Nancy Giles
Lady Nancy/Audrey	Aisha Jabour
Corin/Oliver Martext	George Babiak
Jacklyn/Hisperia	Jennifer Jimenez
Denise/Phebe	Jaya Rosado

Stage Manager: Megan Sandberg-Zakian

Costume Design: Wade Penhorwood

Fight Choreography: Tom Schall

Dance Choreography: Jeanne Simpson

Musical Direction: Josh Lewis

French synopsis translation: Alex Draper

Adult volunteers: Ceci Arana, Catherine Mueller,  
Larry Nathanson, Anne Torsiglieri

The 52nd Street Project would also like to thank  
Harrow School

Bill Muddyman and Jane Muddyman-Heine  
The Staff of the Château de Berne

The 52nd Street Project gratefully acknowledges the support of the following foundations and corporations: Altria Employee Fund, Barker Welfare Foundation, The Bamsley Foundation, Bloomberg, The Blythmore Corporation, California Comedy, Capital Research Company, Carnegie Corporation of New York, Citigroup Foundation, Comedy Central, Davis Polk & Wardwell, Deutsche Bank of Americas Foundation, The Dramatists Guild Fund, Dramatists Play Service, Eleanor, Adam & Mel Dubin Foundation, Entertainment Weekly, The Fan Fox & Leslie R. Samuels Foundation, The J. Paul Getty Trust, The Horace W. Goldsmith Foundation, The William and Mary Greve Foundation, The Hennessy Foundation, Holland Lodge Foundation, Inc., Betty E. & George B. Kaiser Foundation, Lemberg Foundation, Inc., Lloyds TSB Bank plc, Lucent Technologies, Lucille Lortel Foundation, James A. Macdonald Foundation, Major League Baseball, Ann M. Martin Foundation, Mellon Bank, N.A., The Cynthia & George Mitchell Foundation, The National Board of Review, The New World Foundation, The New York Times Company Foundation, Newman's Own, Norcross Wildlife Foundation, Inc., Stranahan Foundation, Susquehanna Partners, G.P., Theatre Communications Group, Inc., Paramount Pictures, John A. Vassilaros & Son, Inc., The Vervane Foundation, The Wiener Family Foundation, Zagat Survey, Felix Zaremba & Co. Inc., In addition the following individuals made gifts of over \$200 to The 52nd Street Project this year (list is current as of 6/30/03):

Anonymous	Martin Fetner & William Coury	Kate Lear & Jonathan LaPook	Daryl Roth
Robert Abrams & Cynthia Vance	Angelina Fiordellisi	Mary Ann Lefort	Martha Roth & Bill Irwin
Jace Alexander & Maddie Corman	Liz Flahive	Warren Leight	Mark Saad
Alexis Alexanian	Anita Flanagan & Jeff Potter	Liza Lerner	Steve Sabba
Cecilia Arana-Grant & Kevin Grant	Alexa Fogel	Joshua Lewis & Sarah Kay	Arnold & Agnes Sametz
Lucie Amaz & Laurence Luckinbill	Frank Frattaroli	Anna Li	Laura Sametz & Anton Fig
Debbon Ayer	Helen B. Freedman	Linda Li	Don Scardino & Dana Williams
Adam Leitman Bailey	Katherine Freedman	Adrienne Lobel & Mark Linn Baker	Zeborah Schachtel
Dylan & Becky Baker	Naomi Freundlich & Charles Miles	Doug Lockwood	Karin & Tom Schall
June Ballinger & Michael Goldstein	Louis & Patrice Friedman	John Lyons	Leslie Schine & Nils Nilsen
Ben Barenholtz	Janeane Garofalo	Grace Lyu-Volkhausen	Mauri Schott
Benny Bartley	Rose Gasner & Larry Chertoff	Barry Mackall &	Ken & Mary Ann Schuster
Jessica Bauman	Cora Cahan & Bernard Gersten	Bill Schwinghammer	Seret Scott
Laurie Becker & Rick Sweren	Lillian Cahan Gersten	Marsue & Peter MacNicol	Stefan Selig
Meredith Beeuwkes	Ileen Getz & Mark Grinnell	Greg MacPherson &	Mitchell Sernel & Colleen Carroll
Lisa Benavides & Tim Nelson	Paul & Liz Giamatti	Jane Perlmutter	Tom Shadyac
Vicky Bijur & Ed Levine	Nancy Giles	Joseph Maffia	Aaron & Elaine Shapiro
Lewis Black	Lloyd & Kitty Gilmour	Nat Magee & Alison Fraser	Bernice Baruch Shawl
Richard Blackstone &	Bryan Gmitter	Wendy Makkena & Bob Krakower	Sloane Shelton & Jan Buckaloo
Yldeez Yuksek	Judy Goldman & Michael Pillingier	Paul & Lauren Mandell	Abby Jo Sigal & Matt Turner
Tessa Blake	George & Amy Goldstein	Elizabeth Manne	Meg Simon
Katherine & John Borowitz	Larry & Carol Goldstein	Sonia Manzano &	Landon Slane
Buzz Boyshow	Tony Goldwyn & Jane Musky	Richard Reagan	Talia Balsam & John Slattery
Julie Boyd	Fred & Nancy Goodman	Donald Margulies & Lynn Street	Abigail Rose Solomon
Bob Boyett	Stephen & Cathy Graham	Richard Marin	Phyllis Somerville
Kathy Briggs	Connie Grappo & Lee Wilkof	Sonya Martin	John Steber & Robert Shaffron
Becky Browder & Ted Neustadt	Michael Greif & Jonathan Fried	Kay Matschullat & Allan Arfa	Jean Stein
Susan Bruce & Peter Hedges	Emily Grishman &	George Mayer	Ben & Christine Stiller
Michael Buchanan &	Susan Sampliner	Brigid McCarthy	David & Sara Stone
Marcus Astafan	Lisa Gugenheim	Paul McCrane & Dana Kellin	Abby Stranahan & Dave Ward
Kate Burton & Michael Ritchie	Mark & Valerie Hadjipateras	Fran McDormand & Joel Coen	Alexandra Styron & Ed Beason
Alfred C. Cerullo III	Marianne Hagan	William Michael McMahon &	Susanna Styron & Darrell Larson
Rachel Chanoff	Evan Handler	Meg McMahon	Brian Swardstrom & Bonnie
Sharon Chantile	Lynn E. Harris	Rick Meese & Dan Lori	Bernstein
Glenda Chesshir	Jane & Jonathan Heine	Richard & Denise Menelly	Daniel Sade
Kirk & Katherine Holt Citron	Peter Herdrich & Karen Trott	Josie Merck & Jim Stevenson	Mariko Tada
Darah Cloud & Dave Owens	Amy Herzig	Brian Mertes	Gina Torres
Ruth Cohen	William Holtzman &	Audrey & Danny Meyer	Anne Torsiglieri &
Lieta Heslen-Cohen &	S. Sylvia Shepard	Nancy Meyer & Marc Weiss	Michael Bernard
Richard Cohn	Katy Homans & Patterson Sims	Neal & Amanda Moszkowski	Liz Tucello
Tricia Cooke & Ethan Coen	Sarah Horowitz & David Venarde	Suzen Murakoshi & Mark Temme	John & Katherine Turturro
Hyla & Richard Crane	Barbara Howard	Patricia M. Murphy, Esq. &	Laura Valeroso & David Seidman
Margaret Crimmins	Philip & Alexandra Howard	Adam Spilka	Josephine Eke & Jason Valk
Billy Crudup & Mary Louise Parker	Kate Hudson & Chris Robinson	Don & Sara Nelson	Wendy vanden Heuvel &
Tom Cruise	Dana Ivey	Pamela & Peter Nelson	Brad Coley
Catherine Curtin	Jean & Ron Jacobs	Randy & Rona Nelson	William & Melinda vanden Heuvel
Willem Dafoe & Liz Lecompte	Mark Evan Jacobs	Ruth Nelson	Ed Vassallo
Arthur Dantchik	Sy Jacobs	Mark Nesselson, M.D. &	John A. Vassallo
Cathy Dantchik	Whitney Scott & Peter Jacobson	Elliott Rosenblum	Susan Vitucci
Leslie Dantchik	Linda LeRoy Janklow	James Neuberger &	Mary Pat Walsh
Peter & Judith Dawkins	Amanda Johns	Helen Stambler	Ms. Valerie Walsh
Georgia & William Delano	Julia A. Johns	Lori O'Connor	Maja Wampuszyc
Jonathan Demme	Andrea Johnson	Kevin O'Rourke & Edith Thurber	Wendy Wasserstein
Buddy Dikman & Chuck Davis	Traci Paige Johnson &	Carol Ochs & Bruce MacVittie	Anita Waxman
Edward & Joanne DiRugenis	Robert Mowen	Jacki Ochs & Jan Kroeze	Brenda Wehle & John C. Lynch
Alex Draper & Lorraine Tobias	Larry & Mary Jones	Paul & Maria Onderdonk	Sally & Lenny Weiss
Richard & Rebecca Dresser	Marcy & Max Kahn	Joe Paladino &	Jane Bolster & Steve Wertimer
Christopher & Karen Eddowes	Sheryl Kaller	Barbara Fleck-Paladino	Carol Whitesides
Mario Egozi	Maurice Kanbar	Elizabeth Peters	Jenny Wiener & Jon Steingart
David & Chrysti Eigenberg	Eric Karpeles & Mike Sell	Peter & Ana Rosa Phillips	Michael & Zena Wiener
Ned Eisenberg & Patricia Maguire	Ronald Kastner & Vanessa Boeoye	Oliver Platt &	Elizabeth Williams & Joseph Forte
Beth Emelson	Stephen & Sharon Kepniss	Camilla Campbell Platt	Donald Windham
Nora Ephron	Seth & Beth Klarman	Jeremy Posner	John Woo
Barbara Ettinger & Sven Huseby	Mary Kong	Dean & Leslie Potashner	Joanne Woodward &
Heidi Ettinger	Sarah & Steven Kraemer	Peter & Helen Randolph	Paul Newman
Wendy Ettinger & Derek McLane	Judy Kuhn & David Schwab	Willie Reale & Jenny Gersten	Bill Wrubel & Jennifer Crittenden
Andrew & Sandi Farkas	Roger & Belle Kuhn	Theresa Rebeck & Jess Lynn	Carolee Yass & Randy Ginsburg
Tom Feeney & Paul Parzuchowski	Frances Kumin & Richard Ticktin	Herald & Linda Ritch	Jeffrey & Janine Yass
Peter Jay Fernandez &	Allan & Nanette Larson	David & Anita Rogerson	James & Mary Lin Yoshimura
Denise Burse	Michael P. Lawrence	Robin Morse & Gus Rogerson	Virginia Zakian & Robert Sandberg

The 52nd Street Project presents  
The 2003 Harold and Mimi Steinberg Charitable Trust One-on-Ones

# DATES WITH DESTINY THE HISTORIC PLAYS

**THE BLOCK ISLAND CHRONICLES**



JAMES STEVENSON

July 24-27, 2003  
The Ensemble Studio Theatre  
549 West 52nd St.  
NEW YORK CITY



# DATES WITH DESTINY THE HISTORIC PLAYS

The 2003 Block Island  
One-on-Ones  
July 24-27  
The Ensemble  
Studio Theatre

## The 52nd Street Project Staff:

Gus Rogerson, Artistic Director  
Carol Ochs, Executive Director  
John Sheehy, Director of Development and Marketing  
Megan Sandberg-Zakian, Associate Artistic Director  
George "X-Acto" Babiak, Production Manager  
Liz Bell, Director of Education  
Diana Rojas, Executive Assistant  
Chris Ceraso, Teen Dean  
Iris A. Brown, Graphic Designer  
Mayleen Cancel and Jaymaree Rosado, Receptionists  
Interns: Melissa Jones and Melissa Gawlowski

## Production Staff

**Composer:** Kim D. Sherman  
**Set Designer:** Kevin Joseph Roach  
**Lighting Designer:** Greg MacPherson  
**Costume Designer:** Crystal Thompson  
**Costume Assistant:** Jennifer Jimenez  
**Sound Designer:** Betsy Rhodes  
**Stage Manager:** Kelly Blackwell  
**Slide Design Team:**

Chris Bonanos, Johann Conforme,  
Lee Kimble, Katherine Lumb,  
Kathleen Maloney, Mike Marshall, Robin  
Marshall, Monty Nicol, John Steward,  
Alberta Testanero, Iwona Waluk

## Prop Design Team:

Anju Andre-Bergmann, George Babiak,  
Chris Bonanos, Heather Camduff-Gobbée,  
Leah Cumey, Bree Elrod, Paul Boyd,  
Charlie LaGreca, Jeff LaGreca,  
Katherine Lumb, Monty Nicol,  
Erin Quinn Purcell, Christopher Ramirez,  
John Sheehy

## Flyer/Program Illustrations:

James Stevenson

## Furniture Boss:

Alex Tomas

## Furniture Crew:

Anthony Mejia,  
Timothy Thomas

## Prop Crew:

Melissa Jones, Melissa Gawlowski,  
Anju Andre-Bergmann

## Load-in and Light-hang Crew:

Anju Andre-Bergmann,  
Kelly Blackwell, Bree Elrod,  
Jeff LaGreca, Karen Munkel,  
Doug Nervik, Tom Schall,  
Ed Vassallo

## House Managers:

Liz Bell, Liz Flahive

## Chefs:

Pat McQuade and  
Martha Velie-Gass

## Teen Counselor:

Anju Andre-Bergmann



NATIONAL  
ENDOWMENT  
FOR THE ARTS

The One-on-Ones Program is made possible with public funds from the National Endowment for the Arts; The New York State Council on the Arts, a state agency; the Department of Youth and Community Development; and the New York City Department of Cultural Affairs. The 52nd Street Project is a member of ART/NY and a participant in the New Generations Program, funded by Doris Duke Charitable Foundation/The Andrew W. Mellon Foundation and administered by Theatre Communications Group, the national organization for the American Theater.

State of the Arts



NYS CA

## COOL STUFF ON SALE IN THE LOBBY!

The Fabulous Flyer Bar .....\$2.00 & \$1.50  
and featuring Shel Silverstein's "Fivey and Twoey" logo:  
Project T-shirts .....\$12.00  
Project Tank Tops .....\$12.00  
Project Caps (NEW design) .....\$15.00  
Project Mugs (now in BLUE!) .....\$5.00  
Project Pencil 3-pack (now in RED!) .....\$1.00

Thank you for coming to **DATES WITH DESTINY!** If you are not on our mailing list (or if your address has changed), please fill out this form and give it to us on your way out or mail it to the address below. We would also like to know if you are interested in becoming a volunteer. We need help in **all areas**, so be sure to fill out the entire form.

### PLEASE ADD ME TO YOUR MAILING LIST:

7/03

NAME: \_\_\_\_\_

ADDRESS: \_\_\_\_\_

ZIP \_\_\_\_\_

HOME PHONE: \_\_\_\_\_

DAYTIME PHONE: \_\_\_\_\_

E-MAIL ADDRESS: \_\_\_\_\_

MY OCCUPATION: \_\_\_\_\_

MY HOBBIES: \_\_\_\_\_

### YES, I WOULD LIKE TO BE OF HELP. I CAN:

- |   |   |  |
|---|---|--|
| <input type="checkbox"/> Help load in and out for shows | <input type="checkbox"/> Draw and/or paint  | <input type="checkbox"/> Help kids with homework |
| <input type="checkbox"/> Hang lights                    | <input type="checkbox"/> Help with mailings | <input type="checkbox"/> Teach kids a skill      |
| <input type="checkbox"/> Work on a backstage crew       | <input type="checkbox"/> Do office work     | <input type="checkbox"/> Be a chef at an event   |
| <input type="checkbox"/> Do graphic design              | <input type="checkbox"/> Design sound       | <input type="checkbox"/> Design and sew costumes |
| <input type="checkbox"/> Other (please specify) _____   |   |  |

### MY SCHEDULE IS:

- Very flexible. I'm often available during weekdays.  
 Somewhat flexible. I can help on the occasional morning or afternoon during the week.  
 Not very flexible at all, but I've got some free time on evenings and weekends.

If you would like to mail this (and you're always welcome to enclose a tax-deductible contribution), you can send it to: **The 52nd Street Project**, 500 West 52nd St., New York, NY 10019. Or fax it to (212) 333-5598.

**Don't Miss Our Upcoming Shows!**

## ***SECOND DATES WITH DESTINY***

**THE WAREHAM CHRONICLES**



The second outing of the 2003 One-on-Ones  
August 21-24 right here at E.S.T.  
Same great theme, but with new kids,  
new adults, and all-new plays. Come again!

## **PLAYBACK**

**November, 2003**

First a kid writes a short play. Then, an adult writes an “answer” play. Then, the two of them perform both plays. Multiply this equation by seven and you’ve got an entire show.



**December, 2003**

In September, 10 kids brand-new to the Project will begin a Playmaking class taught by Project Playmaking Director Megan Sandberg-Zakian. Come and see their final plays performed by adult professional actors.

The 52nd Street Project is a non-profit organization that brings children from the Hell's Kitchen neighborhood together with professional theater artists to create original theater. **DATES WITH DESTINY** is a production of our One-on-One program, which is designed to give children the opportunity to go away for one-week stays in the country and enjoy the undivided attention of a professional theater artist who serves as friend, mentor, and collaborator. The Project is delighted to return to the Ensemble Studio Theatre, where we have been performing since our inception in 1981. We gratefully acknowledge the fact that if E.S.T. wasn't here, we'd be nowhere.

### **The 52nd Street Project Board of Directors**

Ben Barenholtz  
Lisa Benavides  
Rachel Chanoff  
Cathy Dantchik  
Noël Dawkins

Wendy Ettinger, *chair emeritus*  
Louis P. Friedman  
Stephen Graham, *chair*  
Larry Jones  
James McDaniel  
Frances McDormand

Patricia M. Murphy, Esq.  
Carol Ochs  
Willie Reale, *founder*  
Gus Rogerson  
Shirley Rumierk, *alumni member*  
José Soto, Jr., *alumni member*  
Pamala Tyson  
Laura Valeroso  
Wendy vanden Heuvel  
John A. Vassilaros  
Jenny Wiener

### **Special Thanks**

Our Host Families – Pat McQuade & Martha Velie-Gass; Josie Merck & Jim Stevenson; Eliot & Amy Nerenberg; Jennifer & Elliot Taubman; Diane Trippler & Don Frageau; Ron, Judy & Kevin Tierney; Joya Verde & Virginia Dare; Thomas Frye and our headquarters host Dr. Christina Biaggi. Sincere thanks also go to Lynn Reale, Kate & Harold at Block Island Realty; Prudy & The Ice Cream Place; Rita & Steve Draper; Jane Muskey & Tony Goldwyn ; Glenn & Annie Hall; McQuade's Market; Interstate Navigation; Sophia Ochs MacVittie; Jenny Ritter; Amanda Gass; Kirk Littlefield; Joe and Pat at Smuggler's Cove Sailing School; Finns, Block Island Grocery and The Depot.

### **In-Kind Contributions**

Curt, Jamie, Suzanne, Carl, Tim, and everyone at the Ensemble Studio Theatre; Neil A. Mazzella and Hudson Scenic Studios; the Murphy Law Office; Stephanie Berger; Iris A. Brown; Ron Kastner and Capital Printing; Kenneth Cole Productions; Noggin; The Printing Store; Scholastic, Inc.; Diageo Chateau & Estate Wines; Entertainment Weekly; Alison Fraser; Newman's Own; Sesame Workshop; Wendy Stuhlberg; Tarte, Inc.; Terax America; John A. Vassilaros; Watkins, Inc.; Mayor's Office of Film & Television; Boylan's Bottling Co.; David Sneddon & Fairway Market; Andy Millon; Steve Olsen & The Westbank Cafe; Lorraine Tobias & Imaginary Studios; Jive Records, part of Zomba Music Group; and Prime Films.

## DATES WITH DESTINY - ACT 1

All original music composed by Kim D. Sherman  
"Dates With Destiny Theme Song" lyrics by John Sheehy

### WHERE'S THE SOOTH IN THAT?

Written by Liz Flahive & Directed by Diana Rojas for Chassity Damiani, age 11

Millie .....Chassity Damiani  
Madge .....Diana Rojas  
Jim .....George Babiak  
Ancient Voices .....Erin Quinn Purcell, Melissa Jones,  
Bree Elrod, Eris Migliorini

"I Like What I See" lyrics by Liz Flahive

### A SHORT HISTORY OF AN ODD DAY

Written by Neena Beber & Directed by Florencia Lozano for  
Crystal Toro, age 11 (on July 25)

Lulubelle .....Crystal Toro  
Fifi .....Florencia Lozano  
Cheerleaders .....Anju Andre-Bergmann, Melissa Jones, Liz Bell

"When You Get Stuck" lyrics by Neena Beber

### BATTLEFIELD BLUES

Written & Directed by Jonas Oppenheim for Zebulun Santiago, age 12

Joey .....Zebulun Santiago  
Jimmy .....Jonas Oppenheim

"The 'I'm Scared' Song" lyrics by Jonas Oppenheim

### THE QUEEN OF BASEBALL

Written & Directed by Gus Rogerson for Merlaine Mendez, age 11

Lizzie "Spike" Murphy .....Merlaine Mendez  
Batboy .....Gus Rogerson  
Kid with letter .....Alex Tomas  
Play-by-Play .....George Babiak

"The Best in Baseball" lyrics by Gus Rogerson

### CREW OF TWO

Written & Directed by Eris Migliorini for Michael Velez, age 13

First Mate Buster McMean .....Michael Velez  
Captain Bonecruncher .....Eris Migliorini  
Miss Wogg .....Melissa Jones  
Captain Crazyhair .....Anju Andre-Bergmann  
The Crew .....The Crew

"Pirates" lyrics by Eris Migliorini

👉 **Intermission!** 👈

## DATES WITH DESTINY - ACT 2

### TWO GENTS OF WHENCE

Written by Willie Reale & Directed by Victor Rojas for  
Christopher Ramirez, age 13

Spence .....Christopher Ramirez  
Impetigo .....Victor Rojas

"Heather" and "Me" lyrics by Willie Reale

### JANET'S DATE WITH DESTINY

Written by James Stevenson & Directed by Dion Graham for  
Christine Tomas, age 10

Janet .....Christine Tomas  
Gary and Voice of God .....Dion Graham

"Invention" and "Tell Me A Joke" lyrics by James Stevenson

### WHO DIED AND MADE YOU PRESIDENT?

Written by Madeleine George & Directed by Bree Elrod for  
Nicole Fargardo, age 12

Candace Kominsky .....Nicole Fargardo  
April Rose Smith .....Bree Elrod  
Miss DiRafael .....Melissa Gawlowski

"My Fellow Americans" lyrics by Madeleine George

### THE YUMMY MUMMY

Written & Directed by Erin Quinn Purcell for Skye Blu Welsh, age 12

Miss Aurora Mariette Birch .....Skye Blu Welsh  
Professor Emily Hemmingspot .....Erin Quinn Purcell  
King Tootsanapplepeel .....George Babiak

"Date with a Mummy" lyrics by Erin Quinn Purcell

### PANEL DISCUSSION

Written & Directed by John Sheehy for Harlo Ulloa, age 10

The Raven Lunatic .....Harlo Ulloa  
Captain Heroic Goodman .....John Sheehy



The 52nd Street Project gratefully acknowledges the support of the following foundations and corporations: Altria Employee Fund, Barker Welfare Foundation, The Bamsley Foundation, Bloomberg, The Blythmore Corporation, California Comedy, Capital Research Company, Carnegie Corporation of New York, Citigroup Foundation, Comedy Central, Davis Polk & Wardwell, Deutsche Bank of Americas Foundation, The Dramatists Guild Fund, Dramatists Play Service, Eleanor, Adam & Mel Dubin Foundation, Entertainment Weekly, The Fan Fox & Leslie R. Samuels Foundation, The J. Paul Getty Trust, The Horace W. Goldsmith Foundation, The William and Mary Greve Foundation, The Hennessy Foundation, Holland Lodge Foundation, Inc., Betty E. & George B. Kaiser Foundation, Lemberg Foundation, Inc., Lloyds TSB Bank plc, Lucent Technologies, Lucille Lortel Foundation, James A. Macdonald Foundation, Major League Baseball, Ann M. Martin Foundation, Mellon Bank, N.A., The Cynthia & George Mitchell Foundation, The National Board of Review, The New World Foundation, The New York Times Company Foundation, Newmar's Own, Norcross Wildlife Foundation, Inc., Stranahan Foundation, Susquehanna Partners, G.P., Theatre Communications Group, Inc., Paramount Pictures, John A. Vassilaros & Son, Inc., The Vervane Foundation, The Wiener Family Foundation, Zagat Survey, Felix Zaremba & Co. Inc., In addition the following individuals made gifts of over \$200 to The 52nd Street Project this year (list is current as of 6/30/03):

Anonymous	Martin Fetner & William Coury	Kate Lear & Jonathan LaPook	Daryl Roth
Robert Abrams & Cynthia Vance	Angelina Fiordellisi	Mary Ann Lefort	Martha Roth & Bill Irwin
Jace Alexander & Maddie Corman	Liz Flahive	Warren Leight	Mark Saad
Alexis Alexanian	Anita Flanagan & Jeff Potter	Liza Lerner	Steve Sabba
Cecilia Arana-Grant & Kevin Grant	Alexa Fogel	Joshua Lewis & Sarah Kay	Arnold & Agnes Sametz
Lucie Amaz & Laurence Luckinbill	Frank Frattaroli	Anna Li	Laura Sametz & Anton Fig
Debbon Ayer	Helen B. Freedman	Linda Li	Don Scardino & Dana Williams
Adam Leitman Bailey	Katherine Freedman	Adrienne Lobel & Mark Linn Baker	Zeborah Schachtel
Dylan & Becky Baker	Naomi Freundlich & Charles Miles	Doug Lockwood	Karin & Tom Schall
June Ballinger & Michael Goldstein	Louis & Patrice Friedman	John Lyons	Leslie Schine & Nils Nilsen
Ben Barenholtz	Janeane Garofalo	Grace Lyu-Volkhausen	Mauri Schott
Benny Bartley	Rose Gasner & Larry Chertoff	Barry Mackall &	Ken & Mary Ann Schuster
Jessica Bauman	Cora Cahan & Bernard Gersten	Bill Schwinghammer	Seret Scott
Laurie Becker & Rick Sweren	Jilian Cahan Gersten	Marsue & Peter MacNicol	Stefan Selig
Meredith Beeuwkes	Ileen Getz & Mark Grinnell	Greg MacPherson &	Mitchell Sernel & Colleen Carroll
Lisa Benavides & Tim Nelson	Paul & Liz Giamatti	Jane Perlmutter	Tom Shadyac
Vicky Bijur & Ed Levine	Nancy Giles	Joseph Maffia	Aaron & Elaine Shapiro
Lewis Black	Lloyd & Kilty Gilmour	Nat Magee & Alison Fraser	Bernice Baruch Shawl
Richard Blackstone &	Bryan Gmitter	Wendy Makkena & Bob Krakower	Sloane Shelton & Jan Buckaloo
Yldeez Yuksek	Judy Goldman & Michael Pillingier	Paul & Lauren Mandell	Abby Jo Sigal & Matt Turner
Tessa Blake	George & Amy Goldstein	Elizabeth Manne	Meg Simon
Katherine & John Borowitz	Larry & Carol Goldstein	Sonia Manzano &	Landon Slane
Buzz Bovshow	Tony Goldwyn & Jane Musky	Richard Reagan	Talia Balsam & John Slattery
Julie Boyd	Fred & Nancy Goodman	Donald Margulies & Lynn Street	Abigail Rose Solomon
Bob Boyett	Stephen & Cathy Graham	Richard Marin	Phyllis Somerville
Kathy Briggs	Connie Grappo & Lee Wilkof	Richard Marin	John Steber & Robert Shaffron
Becky Browder & Ted Neustadt	Michael Greif & Jonathan Fried	Kay Matschullat & Allan Arfa	Jean Stein
Susan Bruce & Peter Hedges	Emily Grishman &	George Mayer	Ben & Christine Stiller
Michael Buchanan &	Susan Sampliner	Brigid Mccarthy	David & Sara Stone
Marcus Astafan	Lisa Gugenheim	Paul McCrane & Dana Kellin	Abby Stranahan & Dave Ward
Kate Burton & Michael Ritchie	Mark & Valerie Hadjipateras	Fran McDormand & Joel Coen	Alexandra Styron & Ed Beason
Alfred C. Cerullo III	Marianne Hagan	William Michael McMahon &	Susanna Styron & Darrell Larson
Rachel Chanoff	Evan Handler	Meg McMahon	Brian Swardstrom & Bonnie
Sharon Chantile	Lynn E. Harris	Rick Meese & Dan Lori	Bernstein
Glenda Chesshir	Jane & Jonathan Heine	Richard & Denise Menelly	Daniel Wade
Kirk & Katherine Holt Citron	Peter Herdrich & Karen Trott	Josie Merck & Jim Stevenson	Mariko Tada
Darah Cloud & Dave Owens	Amy Herzig	Brian Mertes	Gina Torres
Ruth Cohen	William Holtzman &	Audrey & Danny Meyer	Anne Torsiglieri &
Lieta Heslen-Cohen &	S. Sylvia Shepard	Nancy Meyer & Marc Weiss	Michael Bernard
Richard Cohn	Katy Homans & Patterson Sims	Neal & Amanda Moszkowski	Liz Tuccillo
Tricia Cooke & Ethan Coen	Sarah Horowitz & David Venarde	Suzen Murakoshi & Mark Temme	John & Katherine Turturro
Hyla & Richard Crane	Barbara Howard	Patricia M. Murphy, Esq. &	Laura Valeroso & David Seidman
Margaret Crimmins	Philip & Alexandra Howard	Adam Spilka	Josephine Eke & Jason Valk
Billy Crudup & Mary Louise Parker	Kate Hudson & Chris Robinson	Don & Sara Nelson	Wendy vanden Heuvel &
Tom Cruise	Dana Ivey	Pamela & Peter Nelson	Brad Coley
Catherine Curtin	Jean & Ron Jacobs	Randy & Rona Nelson	William & Melinda vanden Heuvel
Willem Dafoe & Liz Lecompte	Mark Evan Jacobs	Ruth Nelson	Ed Vassallo
Arthur Dantchik	Sy Jacobs	Mark Nesselson, M.D. &	John A. Vassallo
Cathy Dantchik	Whitney Scott & Peter Jacobson	Elliott Rosenblum	Susan Vitucci
Leslie Dantchik	Linda LeRoy Janklow	James Neuberger &	Mary Pat Walsh
Peter & Judith Dawkins	Amanda Johns	Helen Stambler	Ms. Valerie Walsh
Georgia & William Delano	Julia A. Johns	Lori O'Connor	Maja Wampuszyc
Jonathan Demme	Andrea Johnson	Kevin O'Rourke & Edith Thurber	Wendy Wasserstein
Buddy Dikman & Chuck Davis	Traci Paige Johnson &	Carol Ochs & Bruce MacVittie	Anita Waxman
Edward & Joanne DiRugenis	Robert Mowen	Jacki Ochs & Jan Kroeze	Brenda Wehle & John C. Lynch
Alex Draper & Lorraine Tobias	Larry & Mary Jones	Paul & Maria Onderdonk	Sally & Lenny Weiss
Richard & Rebecca Dresser	Marcy & Max Kahn	Joe Paladino &	Jane Bolster & Steve Wertimer
Christopher & Karen Eddowes	Sheryl Kaller	Barbara Fleck-Paladino	Carol Whitesides
Mario Egozi	Maurice Kanbar	Elizabeth Peters	Jenny Wiener & Jon Steingart
David & Chrysti Eigenberg	Eric Karpeles & Mike Sell	Peter & Ana Rosa Phillips	Michael & Zena Wiener
Ned Eisenberg & Patricia Maguire	Ronald Kastner & Vanessa Boeoye	Oliver Platt &	Elizabeth Williams & Joseph Forte
Beth Emelson	Stephen & Sharon Kepniss	Camilla Campbell Platt	Donald Windham
Nora Ephron	Seth & Beth Klarman	Jeremy Posner	John Woo
Barbara Ettinger & Sven Huseby	Mary Kong	Dean & Leslie Potashner	Joanne Woodward &
Heidi Ettinger	Sarah & Steven Kraemer	Peter & Helen Randolph	Paul Newman
Wendy Ettinger & Derek McLane	Judy Kuhn & David Schwab	Willie Reale & Jenny Gersten	Bill Wrubel & Jennifer Crittenden
Andrew & Sandi Farkas	Roger & Belle Kuhn	Theresa Rebeck & Jess Lynn	Carolee Yass & Randy Ginsburg
Tom Feeney & Paul Parzuchowski	Frances Kumin & Richard Ticktin	Herald & Linda Ritch	Jeffrey & Janine Yass
Peter Jay Fernandez &	Allan & Nanette Larson	David & Anita Rogerson	James & Mary Lin Yoshimura
Denise Burse	Michael P. Lawrence	Robin Morse & Gus Rogerson	Virginia Zakian & Robert Sandberg

The 52nd Street Project presents  
The 2003 Wiener Family Foundation One-on-Ones

# SECOND DATES WITH DESTINY THE HISTORIC PLAYS

THE WAREHAM CHRONICLES



JAMES STEVENSON

August 21-24, 2003  
The Ensemble Studio Theatre  
549 West 52nd St.  
NEW YORK CITY

# DATES WITH DESTINY THE HISTORIC PLAYS

The 2003 Wareham, MA  
One-on-Ones  
August 21-24  
The Ensemble  
Studio Theatre

## The 52nd Street Project Staff:

Gus Rogerson, Artistic Director  
Carol Ochs, Executive Director  
John Sheehy, Director of Development and Marketing  
Megan Sandberg-Zakian, Associate Artistic Director  
George "X-Acto" Babiak, Production Manager  
Liz Bell, Director of Education  
Diana Rojas, Executive Assistant  
Chris Ceraso, Teen Dean  
Iris A. Brown, Graphic Designer  
Mayleen Cancel and Jaymaree Rosado, Receptionists  
Interns: Melissa Jones and Melissa Gawlowski

## Production Staff

**Composer:** Patrick Barnes  
**Set Designer:** Kevin Joseph Roach  
**Lighting Designer:**  
Greg MacPherson  
**Costume Designer:**  
Crystal Thompson  
**Camel Head Design & Construction:**  
Erminio Pinque & Big Nazo Designs  
**Sound Designer:** Vanessa Valdes  
**Stage Manager:** Karen Munkel  
**Slide Design Team:**  
George Babiak, Midge Lucas and guest  
artists of the past  
**Prop Design Team:**  
George Babiak, Heather Camduff-  
Gobbée, Britney Castro, Melissa  
Gawlowski, Esther Geller, Midge Lucas,  
Isayah Muller, Karen Munkel, Octavia  
Rodriguez, Mordecai Santiago, Amanda  
Santos, John Sheehy, Alex Tomas

## Flyer/Program Illustrations:

James Stevenson

## Furniture Crew:

Nash Landesman,  
Anthony Mejia

## Prop Crew:

Melissa Jones,  
Melissa Gawlowski,  
Suzette Santana

## Load-in and Light-hang Crew:

Karen Munkel,  
Ed Vassallo

## House Managers:

Liz Bell,  
Liz Flahive

## Chefs:

Carol Ochs,  
Christopher Randolph,  
John Sheehy

## COOL STUFF ON SALE IN THE LOBBY!

The Fabulous Flyer Bar .....\$2.00 & \$1.50  
and featuring Shel Silverstein's "Fivey and Twoey" logo:  
Project T-shirts .....\$12.00  
Project Tank Tops .....\$12.00  
Project Caps (NEW design) .....\$15.00  
Project Mugs (now in BLUE!) .....\$5.00  
Project Pencil 3-pack (now in RED!) .....\$1.00

Thank you for coming to **SECOND DATES WITH DESTINY!** If you are not on our mailing list (or if your address has changed), please fill out this form and give it to us on your way out or mail it to the address below. We would also like to know if you are interested in becoming a volunteer. We need help in **all areas**, so be sure to fill out the entire form.

### PLEASE ADD ME TO YOUR MAILING LIST:

8/03

NAME: \_\_\_\_\_

ADDRESS: \_\_\_\_\_

ZIP \_\_\_\_\_

HOME PHONE: \_\_\_\_\_

DAYTIME PHONE: \_\_\_\_\_

E-MAIL ADDRESS: \_\_\_\_\_

MY OCCUPATION: \_\_\_\_\_

MY HOBBIES: \_\_\_\_\_

### YES, I WOULD LIKE TO BE OF HELP. I CAN:

- |   |   |  |
|---|---|--|
| <input type="checkbox"/> Help load in and out for shows | <input type="checkbox"/> Draw and/or paint  | <input type="checkbox"/> Help kids with homework |
| <input type="checkbox"/> Hang lights                    | <input type="checkbox"/> Help with mailings | <input type="checkbox"/> Teach kids a skill      |
| <input type="checkbox"/> Work on a backstage crew       | <input type="checkbox"/> Do office work     | <input type="checkbox"/> Be a chef at an event   |
| <input type="checkbox"/> Do graphic design              | <input type="checkbox"/> Design sound       | <input type="checkbox"/> Design and sew costumes |
| <input type="checkbox"/> Other (please specify) _____   |   |  |

### MY SCHEDULE IS:

- Very flexible. I'm often available during weekdays.  
 Somewhat flexible. I can help on the occasional morning or afternoon during the week.  
 Not very flexible at all, but I've got some free time on evenings and weekends.

If you would like to mail this (and you're always welcome to enclose a tax-deductible contribution), you can send it to: **The 52nd Street Project**, 500 West 52nd St., New York, NY 10019. Or fax it to (212) 333-5598.



The One-on-Ones Program is made possible with public funds from The New York State Council on the Arts, a state agency; and the New York City Department of Cultural Affairs. The 52nd Street Project is a member of ART/NY and a participant in the New Generations Program, funded by Doris Duke Charitable Foundation/The Andrew W. Mellon Foundation and administered by Theatre Communications Group, the national organization for the American Theater.



**Don't Miss Our Upcoming Shows!**

# On the Other Hand: The Alternative Plays

Playback, October, 2003

First a kid writes a short play. Then, an adult writes an "answer" play using the same situations and characters as in the kid's play. Finally, the adult and the kid rehearse and perform both plays (as pals). Multiply this equation by seven and you've got an entire show. That's Playback, the most collaborative of all our shows. Don't miss it!

## A PIECE OF OUR MIND: Plays with Opinions



December, 2003

In September, 10 kids who are newcomers to the Project will begin a Playmaking class taught by Project Playmaking Director **Megan Sandberg-Zakian**. Come and see their final plays performed and directed by members of the New York Theater Community.

The 52nd Street Project is a non-profit organization that brings children from the Hell's Kitchen neighborhood together with professional theater artists to create original theater. **SECOND DATES WITH DESTINY** is a production of our One-on-One program, which is designed to give children the opportunity to go away for one-week stays in the country and enjoy the undivided attention of a professional theater artist who serves as friend, mentor, and collaborator. The Project is delighted to return to the Ensemble Studio Theatre, where we have been performing since our inception in 1981. We gratefully acknowledge the fact that if E.S.T. wasn't here, we'd be nowhere.

### The 52nd Street Project Board of Directors

Ben Barenholtz	Patricia M. Murphy, Esq.
Lisa Benavides	Carol Ochs
Rachel Chanoff	Willie Reale, <i>founder</i>
Cathy Dantchik	Gus Rogerson
Noël Dawkins	Shirley Rumierk, <i>alumni member</i>
Wendy Ettinger, <i>chair emeritus</i>	José Soto, Jr., <i>alumni member</i>
Louis P. Friedman	Pamala Tyson
Stephen Graham, <i>chair</i>	Laura Valeroso
Larry Jones	Wendy vanden Heuvel
James McDaniel	John A. Vassilaros
Frances McDormand	Jenny Wiener

### Special Thanks

Our Host Families –Gerry & Sam Gray; Anne & Colin McNay; Emily & John Morgan; Patty & David Strauss; Sidney Worthen & David Pearce; Beth McNay; Joe McNay; Joanna & Jack Nelson; Bob Krystofolski; and our headquarters host Peter, Helen & Christopher Randolph.

Sincere thanks to our super chef Christopher Randolph; Vanessa Valdes; Kurt Wootton; Robin Morse & Lucy Rogerson; Sophia Ochs MacVittie.

### In-Kind Contributions

Curt, Jamie, Suzanne, Carl, Tim, and everyone at the Ensemble Studio Theatre; Neil A. Mazzella and Hudson Scenic Studios; the Murphy Law Office; Stephanie Berger; Iris A. Brown; Ron Kastner and Capital Printing; Kenneth Cole Productions; Noggin; The Printing Store; Scholastic, Inc.; Diageo Chateau & Estate Wines; Entertainment Weekly; Alison Fraser; Newman's Own; Sesame Workshop; Wendy Stuhlberg; Tarte, Inc.; Terax America; John A. Vassilaros; Watkins, Inc.; Mayor's Office of Film & Television; Boylan's Bottling Co.; David Sneddon & Fairway Market; Andy Millon; Steve Olsen & The Westbank Cafe; Lorraine Tobias & Imaginary Studios; Jive Records, part of Zomba Music Group; and Prime Films.

## SECOND DATES WITH DESTINY - ACT 1

All original music composed by Patrick Barnes  
"Second Dates With Destiny Theme Song" lyrics by John Sheehy

### THE RIVALS

Written & Directed by Keira Naughton for Britney Castro, age 13

Descriptivus .....Britney Castro  
Metaphoricus .....Keira Naughton  
Commentator .....John Sheehy

"Nemesis" lyrics by Keira Naughton

### BREAD PUDDING

Written & Directed by Erica Schmidt for Mordecai Santiago, age 10

Albert .....Mordecai Santiago  
Elsa .....Erica Schmidt

"The Genius Song" lyrics by Erica Schmidt

### THE WRIGHT STUFF

Written & Directed by George Babiak for Paul Dixon, age 13

Orv .....Paul Dixon  
Will .....George Babiak  
Miss Amanda Honeywell .....Melissa Jones

"The Bike Shop Rag" lyrics by George Babiak

### MIMI MEETS HER MATCH

Written by Melissa Gawlowski & Directed by Saidah Arrika Ekulona  
for Octavia Rodriguez, age 12

Mimi Moore .....Octavia Rodriguez  
Dora Dogood .....Saidah Arrika Ekulona  
Edgar Edinhorpe .....Gus Rogerson  
Patrick .....Patrick Barnes

"You Can Do Anything" lyrics by Melissa Gawlowski

### VIKINGS RULE!

Written & Directed by Adam Felber for Jonathan Rosario, age 10

Torvald .....Jonathan Rosario  
Erich the Beige .....Adam Felber  
Warrior Horde .....The Crew

"We Viking!" lyrics by Adam Felber & Music by Holly Nadal

## SECOND DATES WITH DESTINY - ACT 2

### A VERY PRIVATE PRACTICE

Written & Directed by Clem Martini for Alex Tomas, age 12

Elwood .....Alex Tomas  
Juri .....Clem Martini

"Live Out My Dreams" lyrics by Clem Martini

### GET OVER THE HUMP

Written & Directed by Elizabeth Keiser for Steven Castellanos, age 11

Guru .....Steven Castellanos  
Sheri .....Elizabeth Keiser  
Commentator .....Patrick Barnes

"Mind Over Matter" and "It Isn't a Sin to Win" lyrics by Elizabeth Keiser

### GALILEO MEETS THE POPE

Written by Theresa Rebeck & Directed by Shirley A. Rumierk  
for Megan Cruz, age 12

Galileo .....Megan Cruz  
Pope .....Shirley A. Rumierk  
Underling .....John Sheehy

"The Earth May Rotate" lyrics by Theresa Rebeck

### TWO MEN IN A BOAT

Written & Directed by Matt Saldívar for Isayah Muller, age 11

Paolo de Gallo .....Isayah Muller  
Captain .....Matt Saldívar  
Tropical beauties .....Diana Rojas, Melissa Gawlowski

"Adventure!" lyrics by Matt Saldívar, Music by Patrick Barnes, Matt Saldívar,  
and Isayah Muller

### SPIKE AND THE STORYTELLER

Written by Michael Bernard & Directed by Michael Potts  
for Amanda Santos, age 12

Spike .....Amanda Santos  
The Storyteller .....Michael Potts  
Celestina .....Suzette Santana

"Tell Me A Story" lyrics by Michael Bernard

👉 **Intermission!** 👈

The 52nd Street Project gratefully acknowledges the support of the following foundations and corporations: Altria Employee Fund, Barker Welfare Foundation, The Barmley Foundation, Bloomberg, Blythmour Corporation, California Comedy, Capital Research Company, Carnegie Corporation of New York, Comedy Central, Davis Polk & Wardwell, Deutsche Bank of Americas Foundation, The Dramatists Guild Fund, Dramatists Play Service, Eleanor, Adam & Mel Dubin Foundation, Entertainment Weekly, The Horace W. Goldsmith Foundation, The William and Mary Greve Foundation, The Hennessy Foundation, Holland Lodge Foundation, Inc., Lloyds TSB Bank plc, Lucille Lortel Foundation, James A. Macdonald Foundation, Major League Baseball, Ann M. Martin Foundation, Mellon Bank, N.A., The New World Foundation, The New York Times Company Foundation, Newman's Own, Norcross Wildlife Foundation, Inc., Pfizer Foundation, Rytech Inc., St. James' Church, The Fan Fox & Leslie R. Samuels Foundation, Stranahan Foundation, Susquehanna Partners, G.P., Tiger Baron Foundation, John A. Vassilaros & Son, Inc., The Vervane Foundation, The Wiener Family Foundation, Zagat Survey, Felix Zarembo & Co. Inc. In addition the following individuals made gifts of over \$200 to The 52nd Street Project this year (list is current as of 10/10/03):

Jace Alexander & Maddie Corman  
Lucie Amaz & Laurence Luckinbill  
Dylan & Becky Baker  
Ben Barenholtz  
Jessica Bauman  
Laurie Becker & Rick Sweren  
Lisa Benavides & Tim Nelson  
Vicky Bijur & Ed Levine  
Lewis Black  
Richard Blackstone & Yldeez Yulksek  
Tessa Blake  
Buzz Bovsho  
Bob Boyett  
Becky Browder & Ted Neustadt  
Susan Bruce & Peter Hedges  
Alfred C. Cerullo III  
Rachel Chanoff  
Glenda Chesshir  
Kirk & Katherine Holt Citron  
Darah Cloud & Dave Owens  
Ruth Cohen  
Lieta Heslen-Cohen & Richard Cohn  
Tricia Cooke & Ethan Coen  
Hyla & Richard Crane  
Margaret Crimmins  
Billy Crudup & Mary Louise Parker  
Tom Cruise  
Catherine Curtin  
Willem Dafoe & Liz Lecompte  
John J. Dagenhard  
Arthur Dantchik  
Cathy Dantchik  
Leslie Dantchik  
Peter & Judith Dawkins  
Georgia & William Delano  
Jonathan Demme  
Richard & Rebecca Dresser  
Christopher & Karen Eddowes  
Mario Egozi  
David & Chrysti Eigenberg  
Ned Eisenberg & Patricia Maguire

Nora Ephron  
Wendy Ettinger & Derek McLane  
Tom Feeney & Paul Parzuchowski  
Peter Jay Fernandez & Denise Burse  
Martin Fetner & William Coury  
Angelina Fiordellisi  
Alexa Fogel  
Frank Frattaroli  
Katherine Freedman  
Naomi Freundlich & Charles Miles  
Louis & Patrice Friedman  
Janeane Garofalo  
Rose Gasner & Larry Chertoff  
Ileen Getz & Mark Grinnell  
Paul & Liz Giamatti  
Lloyd & Kilty Gilmour  
Judy Goldman & Michael Pillinger  
Tony Goldwyn & Jane Musky  
Assembly Member Richard Gottfried  
Stephen & Cathy Graham  
Michael Greif & Jonathan Fried  
Lisa Gugenheim  
Mark & Valerie Hadjipateras  
Jane & Jonathan Heine  
Peter Herdrich & Karen Trott  
William Holtzman & S. Sylvia Shepard  
Katy Homans & Patterson Sims  
Barbara Howard  
Philip & Alexandra Howard  
Dana Ivey  
Mark Evan Jacobs  
Sy Jacobs  
Whitney Scott & Peter Jacobson  
Andrea Johnson  
Traci Paige Johnson & Robert Mowen  
Larry & Mary Jones  
Maurice Kanbar  
Ronald Kastner & Vanessa Boeys  
Seth & Beth Klarman  
Judy Kuhn & David Schwab  
Allan & Nanette Larson

Michael P. Lawrence  
Mary Ann Lefort  
Joshua Lewis & Sarah Kay  
Anna Li  
Linda Li  
Adrienne Lobel & Mark Linn Baker  
John Lyons  
Grace Lyu-Volckhausen  
Greg MacPherson & Jane Perlmutter  
Nat Magee & Alison Fraser  
Wendy Makkena & Bob Krakower  
Doda Manalansan  
Kay Matuschillat & Allan Arffa  
Paul McCrane & Dana Kellin  
Fran McDormand & Joel Coen  
William Michael McMahon & Meg McMahon  
Rick Meese & Dan Lori  
Richard & Denise Menelly  
Josie Merck & Jim Stevenson  
Brian Mertes  
Audrey & Danny Meyer  
Suzen Murakoshi & Mark Temme  
Patricia M. Murphy, Esq. & Adam Spilka  
Don & Sara Nelson  
Ruth Nelson  
Mark Nesselson, M.D. & Elliott Rosenblum  
Lori O'Connor  
Kevin O'Rourke & Edith Thurber  
Carol Ochs & Bruce MacVittie  
Jacki Ochs & Jan Kroeze  
Elizabeth Peters  
Peter & Ana Rosa Phillips  
Oliver Platt & Camilla Campbell Platt  
Jeremy Posner  
Dean & Leslie Potashner  
Peter & Helen Randolph  
Richard Rauchenberger  
Willie Reale & Jenny Gersten  
Theresa Rebeck & Jess Lynn  
Herald & Linda Ritch

David & Anita Rogerson  
Robin Morse & Gus Rogerson  
Mark Saad  
Steve Sabba  
Laura Sametz & Anton Fig  
Karin & Tom Schall  
Leslie Schine & Nils Nielsen  
Maury Schott  
Ken & Mary Ann Schuster  
Mitchell Semel & Colleen Carroll  
Tom Shadyac  
Richard Shaffer & Nataalka Bukalo  
Aaron & Elaine Shapiro  
Bernice Baruch Shawl  
Abby Jo Sigal & Matt Turner  
Meg Simon  
Talia Balsam & John Slattery  
Abigail Rose Solomon  
Jean Stein  
David & Sara Stone  
Abby Stranahan & Dave Ward  
Susanna Styron & Darrell Larson  
Brian Swardstrom & Bonnie Bernstein  
Daniel Swee  
Mariko Tada  
John Turturro & Katherine Borowitz  
Laura Valeroso & David Seidman  
Wendy vanden Heuvel & Brad Coley  
Ed Vassallo  
John A. Vassallo  
Mary Pat Walsh  
Wendy Wasserstein  
Sally & Lenny Weiss  
Jane Bolster & Steve Wertimer  
Carol Whitesides  
Michael & Zena Wiener  
Donald Windham  
Joanne Woodward & Paul Newman  
Bill Wrubel & Jennifer Crittenden  
Jeffrey & Janine Yass  
James & Mary Lin Yoshimura  
William & Katherine Zarembo

The 52nd Street Project presents the 2003 Playback Show

# ON THE OTHER HAND

## THE ALTERNATIVE PLAYS

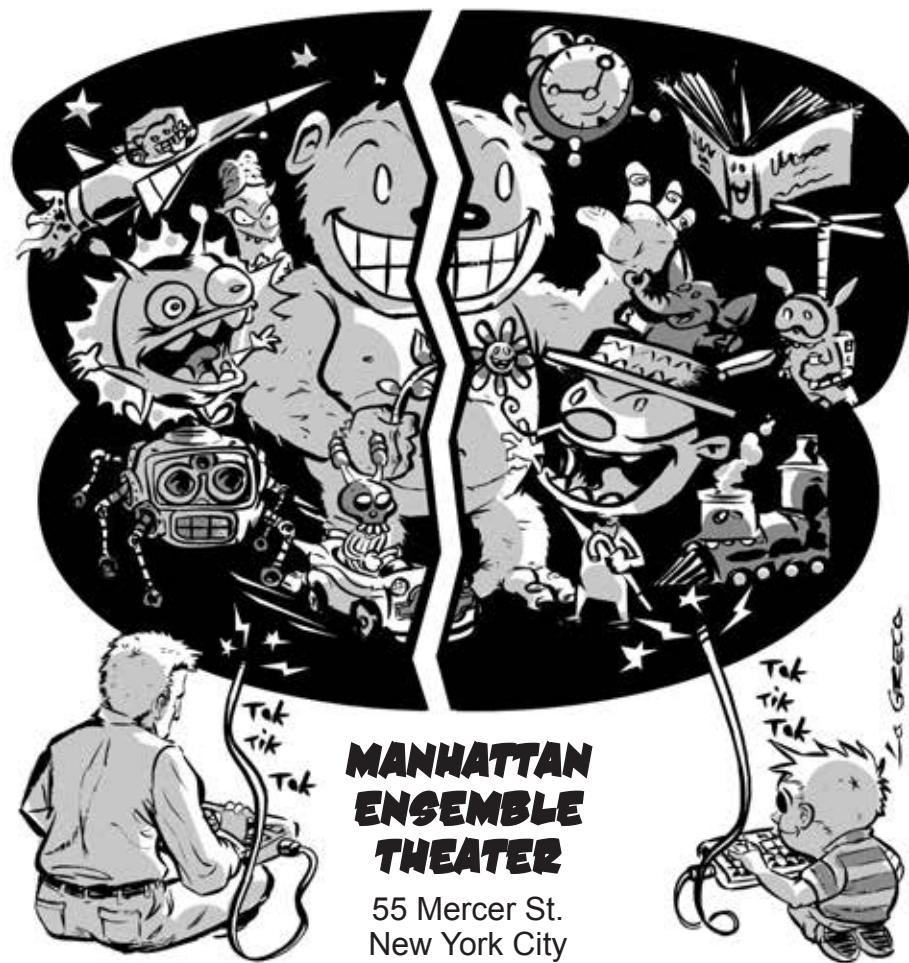

**MANHATTAN  
ENSEMBLE  
THEATER**

55 Mercer St.  
New York City

Fri., Oct. 24 @ 7:30 p.m.,  
Sat., Oct. 25 @ 7:30 p.m., Sun., Oct. 26 @ 3:00 p.m.



# ON THE OTHER HAND

THE ALTERNATIVE PLAYS

THE 2003  
PLAYBACK SHOW  
OCTOBER 24-26  
AT THE MET THEATER

### The 52nd Street Project Staff:

Gus Rogerson, Artistic Director  
 Carol Ochs, Executive Director  
 John Sheehy, Director of Development and Marketing  
 Megan Sandberg-Zakian, Associate Artistic Director  
 George "X-Acto" Babiak, Production Manager  
 Liz Bell, Director of Education  
 Diana Rojas, Executive Assistant  
 Chris Ceraso, Teen Dean  
 Iris A. Brown, Graphic Designer  
 Mayleen Cancel and Anju Andre-Bergmann, Receptionists  
 Intern: Danielle Hill



### Production Staff:

**Composer:** Loren Toolajian  
**Singing Coach:** Kari Riely  
**Set Designer:** Kevin Joseph Roach  
**Lighting Designer:** Greg MacPherson  
**Assistant Lighting Designer:**  
 Kelly Blackwell  
**Costume Designer:** Munee Hayes  
**Goddess of Sound:** Vanessa Valdes  
**Stage Manager:** Erica Schmidt  
**Slide Designers:**  
 George "Pollock" Babiak, Halina  
 "Picasso" Newberry, Henri "Matisse"  
 Bodo, Roy "Warhol" Mills, Gina "van  
 Gogh" Cline.  
**"Other Hand" Illustration:**  
 Charlie LaGreca  
**Prop Design Team:**  
 Justin Aponte, George Babiak,

Heather Carnduff, Nikki Fargardo,  
 Esther Geller, Danielle Hill, Karen  
 Munkel, Adam Robinson, Lee Rosen,  
 John Sheehy, Michael Velez  
**Furniture Crew:**  
 Erik Bowie, Ariana Casablanca  
**Prop Crew:**  
 Solangee Acosta, Danielle Hill  
**Load-in and Light Hang Crew:**  
 Mona Arriola, Kelly Blackwell,  
 Lee Briggs, Nedra Gallegos, Anne  
 O'Sullivan, Christopher Randolph,  
 Tom Schall, Jolie Tong  
**House Managers:**  
 Karin Schall, Beth Emelson,  
 Liz Flahive  
**Chefs:**  
 John Sheehy, Liz Bell



The Playback Program is made possible with public funds from The New York State Council on the Arts, a state agency. The 52nd Street Project is a member of Art/NY and a participant in the New Generations Program, funded by Doris Duke Charitable Foundation/The Andrew W. Mellon Foundation and administered by Theatre Communications Group, the national organization for the American Theater.



# COOL STUFF ON SALE!

Flyer Bars .....\$2.00, \$1.50 & \$1.00

*Shel Silverstein's "Fivey and Twoey" logo gear:*

Project T-shirts .....\$12.00  
 Project long sleeve t-Shirts .....\$15.00  
 Project Caps .....\$15.00  
 Project Mugs .....\$5.00  
 Project Pencil 3-pack .....\$1.00

Thank you for coming to **ON THE OTHER HAND...** If you are not on our mailing list (or if your address has changed), please fill out this form and give it to us on your way out or mail it to the address below. We would also like to know if you are interested in becoming a volunteer. We need help in **all areas**, so be sure to fill out the entire form.

### PLEASE ADD ME TO YOUR MAILING LIST:

10/03

NAME: \_\_\_\_\_

ADDRESS: \_\_\_\_\_

\_\_\_\_\_ ZIP \_\_\_\_\_

HOME PHONE: \_\_\_\_\_

DAYTIME PHONE: \_\_\_\_\_

E-MAIL ADDRESS: \_\_\_\_\_

MY OCCUPATION: \_\_\_\_\_

MY HOBBIES: \_\_\_\_\_

### YES, I WOULD LIKE TO BE OF HELP. I CAN:

- |   |   |  |
|---|---|--|
| <input type="checkbox"/> Help load in and out for shows | <input type="checkbox"/> Draw and/or paint  | <input type="checkbox"/> Help kids with homework |
| <input type="checkbox"/> Hang lights                    | <input type="checkbox"/> Help with mailings | <input type="checkbox"/> Teach kids a skill      |
| <input type="checkbox"/> Work on a backstage crew       | <input type="checkbox"/> Do office work     | <input type="checkbox"/> Be a chef at an event   |
| <input type="checkbox"/> Do graphic design              | <input type="checkbox"/> Design sound       | <input type="checkbox"/> Design and sew costumes |
| <input type="checkbox"/> Other (please specify) _____   |   |  |

### MY SCHEDULE IS:

- Very flexible. I'm often available during weekdays.  
 Somewhat flexible. I can help on the occasional morning or afternoon during the week.  
 Not very flexible at all, but I've got some free time on evenings and weekends.

If you would like to mail this (and you're always welcome to enclose a tax-deductible contribution), you can send it to: **The 52nd Street Project**, 500 West 52nd St., New York, NY 10019. Or fax it to (212) 333-5598.



## Don't Miss Our Upcoming Shows!

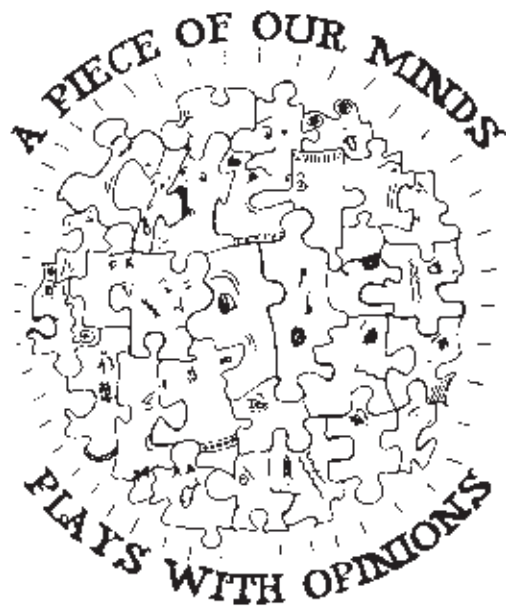

### December 12-14 Playwright's Horizons Upstairs Theater

In September, 10 kids brand-new to the Project began a Playmaking class taught by Playmaking Director Megan Sandberg-Zakian.

Come and see their final plays performed by adult professional actors.

**"IF AT FIRST  
YOU DON'T  
SUCCEED..."**

**PLAYS THAT TRY AGAIN  
Playback, Round II  
February, 2004**

We're doing it again, but with new kids, new adults, new plays, and a new theater...not to mention a new theme. Come see it!



The 52nd Street Project is a non-profit organization that brings children from the Hell's Kitchen neighborhood together with professional theater artists to create original theater. **ON THE OTHER HAND** is a production of our **Playback** program, in which kid actor/playwrights write plays which are then "answered" by adult actor/playwright partners who write their own plays. We then took the whole menagerie up to the idyllic hamlet of Franklin, NY over the Columbus Day weekend to rehearse the shows. In the final production, which you see here tonight, the partners perform both plays back-to-back. All of the kids involved are veterans of the Playmaking classes which were adapted for the Project by Daniel Judah Sklar from his book *Playmaking: Children Writing and Performing Their Own Plays*.

### The 52nd Street Project Board of Directors

Ben Barenholtz  
Lisa Benavides  
Rachel Chanoff  
Cathy Dantchik  
Noël Dawkins  
Wendy Ettinger,  
*chair emeritus*  
Louis P. Friedman  
Stephen Graham, *chair*  
Larry Jones  
James McDaniel  
Frances McDormand  
Patricia M. Murphy, Esq.

Carol Ochs  
Willie Reale,  
*founder*  
Gus Rogerson  
Shirley Rumierk,  
*alumni member*  
José Soto, Jr.,  
*alumni member*  
Pamala Tyson  
Laura Valeroso  
Wendy vanden Heuvel  
John A. Vassilaros  
Jenny Wiener

### Special Thanks

We're extremely grateful to **Gene, Carol, and Carmela Marner; David Bridel, Wendy, Tom and Erna Morgan**, and all the folks in Franklin, NY for being such gracious hosts on the weekend away. **Ed Vassallo** gets a special foam-core Medal of Honor for arranging the entire expedition. Thanks, Ed.

### In-Kind Contributions

We are also indebted to Neil A. Mazzella and Hudson Scenic Studios; the Murphy Law Office; Iris A. Brown; Ron Kastner and Capital Printing; Kenneth Cole Productions; Noggin; Scholastic, Inc.; Diageo Chateau & Estate Wines; Entertainment Weekly; Alison Fraser; Newman's Own; Sesame Workshop; Wendy Stuhlberg; Tarte, Inc.; Terax America; John A. Vassilaros; Watkins, Inc.; Mayor's Office of Film & Television; Boylan's Bottling Co.; David Sneddon & Fairway Market; Steve Olsen & The Westbank Cafe; Lorraine Tobias & Imaginary Studios; Jive Records, part of Zomba Music Group; and Prime Films.

## ON THE OTHER HAND - ACT I

All original music composed by Loren Toolajian

### Like Mother, Like Daughter

By Jazzy Hernandez, age 12. Dramaturg/Director: Kate Marks

### Like Daughter, Like Mother

 Written and directed by Kate Marks

Monica/Missy .....Jazzy Hernandez  
Ashley .....Kate Marks  
Teen-age friends .....Erik Bowie, George Babiak  
“Missy and Ashley’s Song” lyrics by Kate Marks

### The Mistorie

By John Cuevas, age 13. Dramaturg/Director: Megan Sandberg-Zakian

### Behind The Mistorie

Written and Directed by Megan Sandberg-Zakian

Mystoman .....John Cuevas  
Mermaid Mary .....Megan Sandberg-Zakian  
Teller .....Ariana Casablanca  
Bank Customer .....Solangee Acosta  
People in line .....Crew  
Policeman .....George Babiak

“Now I am Happy” lyrics by John Cuevas, “Didn’t You Know?” lyrics by Megan Sandberg-Zakian

### Just Put It Like This

By Johanna Vidal, age 13. Dramaturg/Director: Jolie Tong

### Lost and Found

 Written and directed by Jolie Tong

Denise/Ruth .....Johanna Vidal  
Livia .....Diana Rojas  
The kid .....Erik Bowie

“Denise’s Song” lyrics by Johanna Vidal, “Why Can’t This Be Easy?” lyrics by Jolie Tong

### The House

By Aladino Olivares, age 12. Dramaturg/Director: Reg Flowers

### The Money Trap

 Written and Directed by Reg Flowers

Jason .....Aladino Olivares  
Sergio .....Reg Flowers  
The Narrator/Bright Light .....George Babiak

“Change Can Take Some Time” lyrics by Reg Flowers

☞ **Intermission!** ☞

## ON THE OTHER HAND - ACT II

### The Swordsmen

By Alex Kehr, age 12. Dramaturg/Director: Tom Schall

### The Unkindest Cut

 Written and directed by Tom Schall

Josh Perez .....Alex Kehr  
Max Perez .....Tom Schall

### Family Issues

By Katherine Acosta, age 13. Dramaturg/Director: Gus Rogerson

### Sweet Sixteen

Written and directed by Gus Rogerson

Maria Smith .....Katherine Acosta  
Junior Smith .....Gus Rogerson  
Mother’s voice .....Diana Rojas  
Officer One .....Erik Bowie  
Officer Two .....George Babiak

“Family Issues and Sweet Sixteen: The Songs”: lyrics by Gus Rogerson.

### The Relationship Between Two Friends

By Kayelani Silva, age 12. Dramaturg/Director: Becky White

### Home is Where You Make It

Written and directed by Becky White

Angel Smith/Sploradora .....Kayelani Silva  
Esperanza/Skwawk .....Becky White  
Angel’s Mom .....Diana Rojas  
Angel’s Dad/Sergeant Supitchoo .....George Babiak

“Yippee” lyrics by Kayelani Silva, “Home is Where You Make It” lyrics by Becky White



The 52nd Street Project gratefully acknowledges the support of the following foundations and corporations: Altria Employee Fund, Barker Welfare Foundation, The Barnsley Foundation, Bloomberg, Blythmour Corporation, California Comedy, Capital Research Company, Carnegie Corporation of New York, Comedy Central, Davis Polk & Wardwell, Deutsche Bank of Americas Foundation, The Dramatists Guild Fund, Dramatists Play Service, Eleanor, Adam & Mel Dubin Foundation, Entertainment Weekly, The Horace W. Goldsmith Foundation, The William and Mary Greve Foundation, The Hennessy Foundation, Holland Lodge Foundation, Inc., Lloyds TSB Bank plc, Lucille Lortel Foundation, James A. Macdonald Foundation, Major League Baseball, Ann M. Martin Foundation, Mellon Bank, N.A., The New World Foundation, The New York Times Company Foundation, Newman's Own, Norcross Wildlife Foundation, Inc., Pfizer Foundation, Rytech Inc., St. James' Church, The Fan Fox & Leslie R. Samuels Foundation, Stranahan Foundation, Susquehanna Partners, G.P., Tiger Baron Foundation, John A. Vassilaros & Son, Inc., The Vervane Foundation, The Wiener Family Foundation, Zagat Survey, Felix Zaremba & Co. Inc. In addition the following individuals made gifts of over \$200 to The 52nd Street Project this year (list is current as of 10/10/03):

Jace Alexander & Maddie Corman  
 Lucie Amaz & Laurence Luckinbill  
 Dylan & Becky Baker  
 Ben Barenholtz  
 Jessica Bauman  
 Laurie Becker & Rick Sweren  
 Lisa Benavides & Tim Nelson  
 Vicky Bijur & Ed Levine  
 Lewis Black  
 Richard Blackstone & Yldeez Yulksek  
 Tessa Blake  
 Buzz Bovshew  
 Bob Boyett  
 Becky Browder & Ted Neustadt  
 Susan Bruce & Peter Hedges  
 Alfred C. Cerullo III  
 Rachel Chanoff  
 Glenda Chesshir  
 Kirk & Katherine Holt Citron  
 Darah Cloud & Dave Owens  
 Ruth Cohen  
 Lieta Heslen-Cohen & Richard Cohn  
 Tricia Cooke & Ethan Coen  
 Hyla & Richard Crane  
 Margaret Crimmins  
 Billy Crudup & Mary Louise Parker  
 Tom Cruise  
 Catherine Curtin  
 Willem Dafoe & Liz Lecompte  
 John J. Dagenhard  
 Arthur Dantchik  
 Cathy Dantchik  
 Leslie Dantchik  
 Peter & Judith Dawkins  
 Georgia & William Delano  
 Jonathan Demme  
 Richard & Rebecca Dresser  
 Christopher & Karen Eddowes  
 Mario Egozi  
 David & Chrysti Eigenberg  
 Ned Eisenberg & Patricia Maguire

Nora Ephron  
 Wendy Ettinger & Derek McLane  
 Tom Feeney & Paul Parzuchowski  
 Peter Jay Fernandez & Denise Burse  
 Martin Fetner & William Coury  
 Angelina Fiordellisi  
 Alexa Fogel  
 Frank Frattaroli  
 Katherine Freedman  
 Naomi Freundlich & Charles Miles  
 Louis & Patrice Friedman  
 Janeane Garofalo  
 Rose Gasner & Larry Chertoff  
 Ileen Getz & Mark Grinnell  
 Paul & Liz Giamatti  
 Lloyd & Kilty Gilmour  
 Judy Goldman & Michael Pillinger  
 Tony Goldwyn & Jane Musky  
 Assembly Member Richard Gottfried  
 Stephen & Cathy Graham  
 Michael Greif & Jonathan Fried  
 Lisa Gugenheim  
 Mark & Valerie Hadjipateras  
 Jane & Jonathan Heine  
 Peter Herdrich & Karen Trott  
 William Holtzman & S. Sylvia Shepard  
 Katy Homans & Patterson Sims  
 Barbara Howard  
 Philip & Alexandra Howard  
 Dana Ivey  
 Mark Evan Jacobs  
 Sy Jacobs  
 Whitney Scott & Peter Jacobson  
 Andrea Johnson  
 Traci Paige Johnson & Robert Mowen  
 Larry & Mary Jones  
 Maurice Kanbar  
 Ronald Kastner & Vanessa Boeye  
 Seth & Beth Klarman  
 Judy Kuhn & David Schwab  
 Allan & Nanette Larson

Michael P. Lawrence  
 Mary Ann Lefort  
 Joshua Lewis & Sarah Kay  
 Anna Li  
 Linda Li  
 Adrienne Lobel & Mark Linn Baker  
 John Lyons  
 Grace Lyu-Volckhausen  
 Greg MacPherson & Jane Perlmutter  
 Nat Magee & Alison Fraser  
 Wendy Makkena & Bob Krakower  
 Doda Manalansan  
 Kay Matuschullat & Allan Arffa  
 Paul McCrane & Dana Kellin  
 Fran McDormand & Joel Coen  
 William Michael McMahon & Meg McMahon  
 Rick Meese & Dan Lori  
 Richard & Denise Menelly  
 Josie Merck & Jim Stevenson  
 Brian Mertes  
 Audrey & Danny Meyer  
 Suzen Murakoshi & Mark Temme  
 Patricia M. Murphy, Esq. & Adam Spilka  
 Don & Sara Nelson  
 Ruth Nelson  
 Mark Nesselson, M.D. & Elliott Rosenblum  
 Lori O'Connor  
 Kevin O'Rourke & Edith Thurber  
 Carol Ochs & Bruce MacVittie  
 Jacki Ochs & Jan Kroeze  
 Elizabeth Peters  
 Peter & Ana Rosa Phillips  
 Oliver Platt & Camilla Campbell Platt  
 Jeremy Posner  
 Dean & Leslie Potashner  
 Peter & Helen Randolph  
 Richard Rauchenberger  
 Willie Reale & Jenny Gersten  
 Theresa Rebeck & Jess Lynn  
 Herald & Linda Ritch

David & Anita Rogerson  
 Robin Morse & Gus Rogerson  
 Mark Saad  
 Steve Sabba  
 Laura Sametz & Anton Fig  
 Karin & Tom Schall  
 Leslie Schine & Nils Nielsen  
 Maury Schott  
 Ken & Mary Ann Schuster  
 Mitchell Semel & Colleen Carroll  
 Tom Shadyac  
 Richard Shaffer & Nataalka Bukalo  
 Aaron & Elaine Shapiro  
 Bernice Baruch Shawl  
 Abby Jo Sigal & Matt Turner  
 Meg Simon  
 Talia Balsam & John Slattery  
 Abigail Rose Solomon  
 Jean Stein  
 David & Sara Stone  
 Abby Stranahan & Dave Ward  
 Susanna Styron & Darrell Larson  
 Brian Swardstrom & Bonnie Bernstein  
 Daniel Swee  
 Mariko Tada  
 John Turturro & Katherine Borowitz  
 Laura Valeroso & David Seidman  
 Wendy vanden Heuvel & Brad Coley  
 Ed Vassallo  
 John A. Vassallo  
 Mary Pat Walsh  
 Wendy Wasserstein  
 Sally & Lenny Weiss  
 Jane Bolster & Steve Wertimer  
 Carol Whitesides  
 Michael & Zena Wiener  
 Donald Windham  
 Joanne Woodward & Paul Newman  
 Bill Wrubel & Jennifer Crittenden  
 Jeffrey & Janine Yass  
 James & Mary Lin Yoshimura  
 William & Katherine Zaremba

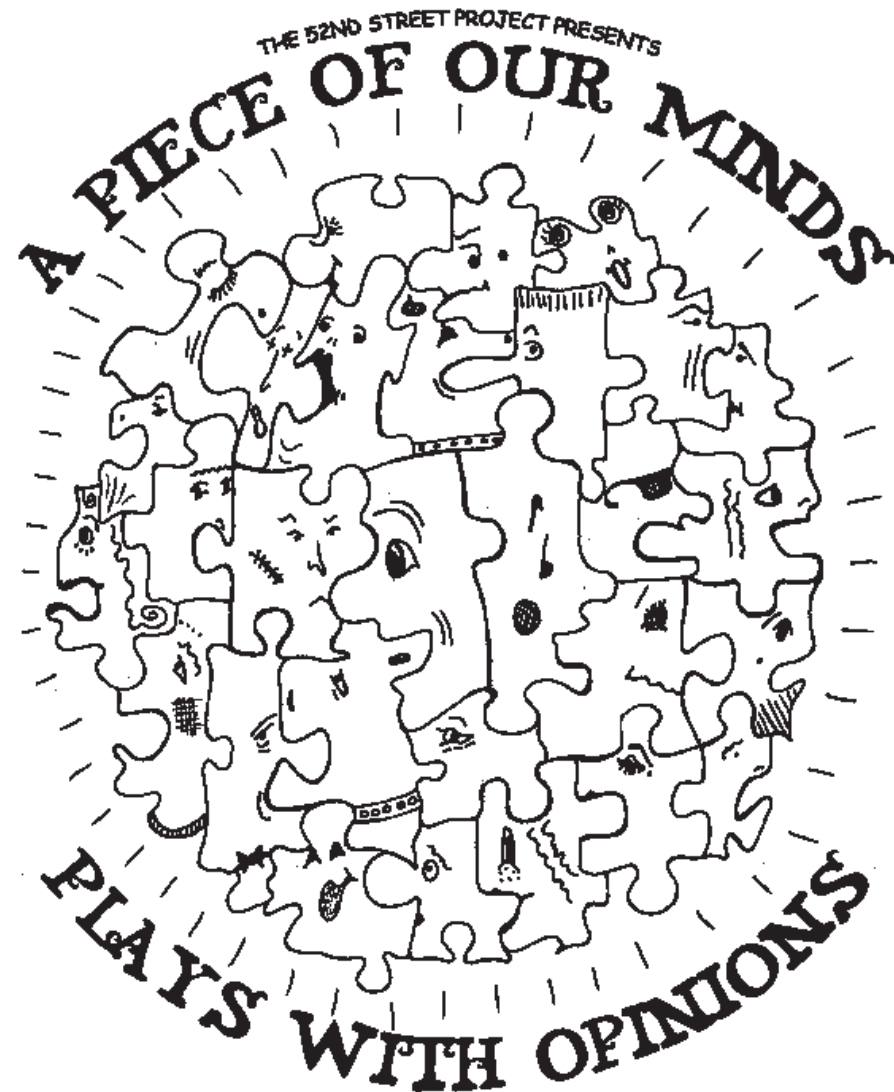

*The Fall 2003 Playmaking Series*

Fri., Dec. 12 at 7:30 p.m.,  
 Sat., Dec. 13 at 3:00 p.m. and 7:30 p.m.  
 and Sun., Dec. 14 at 3:00 p.m.

*The Peter Jay Sharp Theater at Playwrights Horizons*  
 416 W. 42nd St.

# A PIECE OF OUR MINDS

The Fall 2003 Playmaking Plays - Dec. 12-14,  
The Peter Jay Sharp Theater at Playwrights Horizons

## The 52nd Street Project Staff:

Gus Rogerson, Artistic Director  
Carol Ochs, Executive Director  
John Sheehy, Director of Development and Marketing  
Megan Sandberg-Zakian, Associate Artistic Director  
George "X-Acto" Babiak, Production Manager  
Liz Bell, Director of Education  
Diana Rojas, Executive Assistant  
Chris Ceraso, Teen Dean  
Iris A. Brown, Graphic Designer  
Anju Andre-Bergmann and Mayleen Cancel, Receptionists

## Production Staff

**Composer:** Patrick Barnes  
**Set Designer:** Kevin Joseph Roach  
**Lighting Designers:**  
Greg MacPherson & Kelly Blackwell

## Costume Designer:

Elizabeth Bourgeois

## Sound Designer:

Maury Schott

## Stage Manager:

Katie Ahern

## Slide Designers:

George Babiak, Chris Bonanos,  
Renato Castilho, Vanessa Enriquez,  
Katherine Lumb, Mike Sell,  
John Steward, Alberta Testanero,  
Iwona Waluk

## "POOM" Illustration:

Esther Geller

## Prop Design Team:

George Babiak, Nicole Fargardo,  
Gardi and Fiona from South Africa,  
Karen Munkel, Lee Rosen, Kevin  
Ryder, Amy Yen

## Furniture Crew:

Ephraim Lopez  
and Christopher Ramirez

## Prop Crew:

Michael Coglán and Nicole Fargardo

## Load-in and Light Hang Crew:

Kelly Blackwell, Giselda Beaudin,  
Lee Briggs, Melissa Jones,  
Karen Munkel, Christopher  
Randolph, Betsy Rhodes,  
Tom Schall

## Playmaking Class Volunteers:

Jed Clarke, Danielle Hill, Nathan  
Lang, Moira MacDonald, Deirdre  
O'Connor, Nicole Phillips

## House Managers:

Karin Schall, Mary Pat Walsh,  
Liz Bell

## Hosts:

Eric Karpeles and Mike Sell

## Master Chef:

Eric Karpeles

# COOL STUFF ON SALE!



Flyer Bars .....\$2.00, \$1.50 & \$1.00

*Shel Silverstein's "Fivey and Twoey" logo gear:*

Project sweatshirts .....\$20.00

Project long sleeve t-Shirts .....\$15.00

Project Caps .....\$15.00

Project Mugs .....\$5.00

Project Pencil 3-pack .....\$1.00

"Sweet Appreciation" CD .....\$25.00

Thank you for coming to **A PIECE OF OUR MINDS**. If you are not on our mailing list (or if your address has changed), please fill out this form and give it to us on your way out or mail it to the address below. We would also like to know if you are interested in becoming a volunteer. We need help in **all areas**, so be sure to fill out the entire form.



## PLEASE ADD ME TO YOUR MAILING LIST:

12/03

NAME: \_\_\_\_\_

ADDRESS: \_\_\_\_\_

ZIP \_\_\_\_\_

HOME PHONE: \_\_\_\_\_

DAYTIME PHONE: \_\_\_\_\_

E-MAIL ADDRESS: \_\_\_\_\_

MY OCCUPATION: \_\_\_\_\_

MY HOBBIES: \_\_\_\_\_

## YES, I WOULD LIKE TO BE OF HELP. I CAN:

- |   |   |  |
|---|---|--|
| <input type="checkbox"/> Help load in and out for shows | <input type="checkbox"/> Draw and/or paint  | <input type="checkbox"/> Help kids with homework |
| <input type="checkbox"/> Hang lights                    | <input type="checkbox"/> Help with mailings | <input type="checkbox"/> Teach kids a skill      |
| <input type="checkbox"/> Work on a backstage crew       | <input type="checkbox"/> Do office work     | <input type="checkbox"/> Be a chef at an event   |
| <input type="checkbox"/> Do graphic design              | <input type="checkbox"/> Design sound       | <input type="checkbox"/> Design and sew costumes |
| <input type="checkbox"/> Other (please specify) _____   |   |  |

## MY SCHEDULE IS:

- Very flexible. I'm often available during weekdays.  
 Somewhat flexible. I can help on the occasional morning or afternoon during the week.  
 Not very flexible at all, but I've got some free time on evenings and weekends.

If you would like to mail this (and you're always welcome to enclose a tax-deductible contribution), you can send it to: **The 52nd Street Project**, 500 West 52nd St., New York, NY 10019. Or fax it to (212) 333-5598.



The Playmaking Program is made possible with public funds from The New York State Council on the Arts, a state agency. The 52nd Street Project is a member of Art/NY and a participant in the New Generations Program, funded by Doris Duke Charitable Foundation/The Andrew W. Mellon Foundation and administered by Theatre Communications Group, the national organization for the American Theater.



## Don't Miss Our Upcoming Shows!

**"IF AT FIRST  
YOU DON'T  
SUCCEED..."**



**PLAYS THAT TRY AGAIN**

**Playback, Round II  
February, 2004**

We're doing it again, but with new kids, new adults, new plays, and a new theater...not to mention a new theme. Come see it!

# THE WINTER EDITION...



**APRIL, 2004  
AT A THEATER  
TO BE ANNOUNCED.**

If you're enjoying the show tonight, you'll want to take in another set of shows by our *next* batch of Project newcomers! Call 642-5052 for reservations.

The 52nd Street Project is a non-profit organization that brings children from the Hell's Kitchen neighborhood together with professional theater artists to create original theater. **A PIECE OF OUR MINDS** is a production of our Playmaking program. Young people participate in a nine-week playwriting course taught by Megan Sandberg-Zakian and adapted for the Project by Daniel Judah Sklar from his book *Playmaking: Children Writing and Performing Their Own Plays*. At the end of the course, each child is given two actors, a theme, and a dramaturg/director who guides him or her through the writing of a play during a weekend retreat in the country (Tyler Hill, Pennsylvania, for this show). Tonight's performance is the end result.

### The 52nd Street Project Board of Directors

Ben Barenholtz

Lisa Benavides

Rachel Chanoff

Cathy Dantchik

Noël Dawkins

Wendy Ettinger,

*chair emeritus*

Louis P. Friedman

Stephen Graham, *chair*

Larry Jones

James McDaniel

Frances McDormand

Patricia M. Murphy, Esq.

Carol Ochs

Willie Reale,

*founder*

Gus Rogerson

Shirley Rumierk,

*alumni member*

José Soto, Jr.,

*alumni member*

Pamala Tyson

Laura Valeroso

Wendy vanden Heuvel

John A. Vassilaros

Jenny Wiener

### Special Thanks

We're extremely grateful to **Eric Karpeles** and **Mike Sell**, who graciously allowed us to use their beautiful home in Pennsylvania as our base of operations for the writer's retreat. Thanks also to our terrific host families, the **Cobbs**, the **Pursches**, the **Rutledges**, **Sohail Raikhy**, **Joan Henry**, the **Heyns**, **Katy Homans** and **Patterson Sims**, and **Dylan** and **Becky Baker**. We must also express our gratitude to **Tim Sanford**, **Leslie Marcus**, **William Russo**, **Christopher Boll**, **Doug Filomena**, and **Mike Rafael** and all the other folks at Playwrights Horizons for the use of their beautiful theater.

### In-Kind Contributions

We are also indebted to **Neil A. Mazzella** and **Hudson Scenic Studios**; the **Murphy Law Office**; **Iris A. Brown**; **Ron Kastner** and **Capital Printing**; **Kenneth Cole Productions**; **Noggin**; **Scholastic, Inc.**; **Diageo Chateau & Estate Wines**; **Entertainment Weekly**; **Alison Fraser**; **Newman's Own**; **Sesame Workshop**; **Wendy Stuhlberg**; **Tarte, Inc.**; **Terax America**; **John A. Vassilaros**; **Watkins, Inc.**; **Mayor's Office of Film & Television**; **Boylan's Bottling Co.**; **David Sneddon & Fairway Market**; **Steve Olsen & The Westbank Cafe**; **Lorraine Tobias & Imaginary Studios**; **Jive Records**, part of **Zomba Music Group**; and **Prime Films**.

All original music composed by Patrick Barnes

**War Between Love**

By Matthew Ortiz, age 10. Dramaturg/Director: Lee Wilkof

Arthur .....Walker Jones  
 Erika .....Liza Colon-Zayas  
*“He Fights On”* and *“Fight Together”* lyrics by Matthew Ortiz

**Pro Skateboarders**

By Jason Peterson Ridge, age 10.  
 Dramaturg/Director: Jonathan Bernstein

Lob .....Nathan Lang  
 Nob .....Erik Bowie  
 The Fans .....The Crew  
 Voice of the Skateboard .....Jonathan Bernstein

**The Mafia Tragedy**

by A.J. Welsh, age 10. Dramaturg/Director: John Sheehy

Sunny Ferguson .....Jed Clarke  
 Zoe Ramirez .....Martha Plimpton  
 The Boss .....George Babiak

**How Did a Princess Turn Into a Cat?**

by Luz Maldonado, age 10. Dramaturg/Director: Liliana Amador

Princess Fiona .....Lenore Pemberton  
 Little Princess .....Caroline Clay  
*“Fiona’s Song”* lyrics by Luz Maldonado

**The Big Argument**

by Carla Olivia, age 9. Dramaturg/Director: Liza Steinberg

Shanelle .....Ellen Foley  
 Mabel .....Kathy Hiler  
*“I’m Sorry”* lyrics by Carla Olivia



**The Dancing Fool**

by Stephanie Vamvoukakis, age 9.  
 Dramaturg/Director: Madeleine George

Jeanette .....Joselin Reyes  
 Jennifer .....Wendy vanden Heuvel  
 Clubbers .....The Crew  
*“Why Can’t I”* and *“Now I Can”* lyrics by Stephanie Vamvoukakis

**The Horror**

by Junior Chatman, age 11. Dramaturg/Director: Danyon Davis

Timmy .....Paco Tolson  
 Jimmy .....Peter Appel  
 Computer Associate .....Christopher Ramirez

**Love Birds**

by Katherine Alvarez, age 11. Dramaturg/Director: Rick Meese

Epiphany Jones .....Mercedes Herrero  
 Sam Smith .....Christopher Randolph

**The Legend of Dragons and Dinosaurs**

by George Zapata, age 9. Dramaturg/Director: Jeanne Simpson

Thunder .....Thom Sesma  
 Lightning .....Shona Tucker

**The Deadline**

by Jennifer Ramirez, age 10. Dramaturg/Director: Jennifer Ostrega

Kevin .....Felix Solis  
 Carlos .....Stephen Barker Turner  
*“Friends Forever”* lyrics by Jennifer Ramirez.



*Happy  
 Holidays  
 to all  
 Projectiles!*

The 52nd Street Project gratefully acknowledges the support of the following foundations and corporations: Altria Employee Fund, Barker Welfare Foundation, The Barmley Foundation, Bloomberg, Blythmour Corporation, California Comedy, Capital Research Company, Carnegie Corporation of New York, Comedy Central, Davis Polk & Wardwell, Deutsche Bank of Americas Foundation, The Dramatists Guild Fund, Dramatists Play Service, Eleanor, Adam & Mel Dubin Foundation, Entertainment Weekly, The Horace W. Goldsmith Foundation, The William and Mary Greve Foundation, The Hennessy Foundation, Holland Lodge Foundation, Inc., Lloyds TSB Bank plc, Lucille Lortel Foundation, James A. Macdonald Foundation, Major League Baseball, Ann M. Martin Foundation, Mellon Bank, N.A., The New World Foundation, The New York Times Company Foundation, Newman's Own, Norcross Wildlife Foundation, Inc., Pfizer Foundation, Rytech Inc., St. James' Church, The Fan Fox & Leslie R. Samuels Foundation, Stranahan Foundation, Susquehanna Partners, G.P., Tiger Baron Foundation, John A. Vassilaros & Son, Inc., The Vervane Foundation, The Wiener Family Foundation, Zagat Survey, Felix Zaremby & Co. Inc. In addition the following individuals made gifts of over \$200 to The 52nd Street Project this year (list is current as of 10/10/03):

Jace Alexander & Maddie Corman  
 Lucie Amaz & Laurence Luckinbill  
 Dylan & Becky Baker  
 Ben Barenholtz  
 Jessica Bauman  
 Laurie Becker & Rick Sweren  
 Lisa Benavides & Tim Nelson  
 Vicky Bijur & Ed Levine  
 Lewis Black  
 Richard Blackstone & Yldeez Yuksek  
 Tessa Blake  
 Buzz Boyshow  
 Bob Boyett  
 Becky Browder & Ted Neustadt  
 Susan Bruce & Peter Hedges  
 Alfred C. Cerullo III  
 Rachel Chanoff  
 Glenda Chesshir  
 Kirk & Katherine Holt Citron  
 Darah Cloud & Dave Owens  
 Ruth Cohen  
 Lieta Heslen-Cohen & Richard Cohn  
 Tricia Cooke & Ethan Coen  
 Hyla & Richard Crane  
 Margaret Crimmins  
 Billy Crudup & Mary Louise Parker  
 Tom Cruise  
 Catherine Curtin  
 Willem Dafoe & Liz Lecompte  
 John J. Dagenhard  
 Arthur Dantchik  
 Cathy Dantchik  
 Leslie Dantchik  
 Peter & Judith Dawkins  
 Georgia & William Delano  
 Jonathan Demme  
 Richard & Rebecca Dresser  
 Christopher & Karen Eddowes  
 Mario Egozi  
 David & Chrysti Eigenberg  
 Ned Eisenberg & Patricia Maguire

Nora Ephron  
 Wendy Ettinger & Derek McLane  
 Tom Feeney & Paul Parzuchowski  
 Peter Jay Fernandez & Denise Burse  
 Martin Fetner & William Coury  
 Angelina Fiordellisi  
 Alexa Fogel  
 Frank Frattaroli  
 Katherine Freedman  
 Naomi Freundlich & Charles Miles  
 Louis & Patrice Friedman  
 Janeane Garofalo  
 Rose Gasner & Larry Chertoff  
 Ileen Getz & Mark Grinnell  
 Paul & Liz Giamatti  
 Lloyd & Kilty Gilmour  
 Judy Goldman & Michael Pillinger  
 Tony Goldwyn & Jane Musky  
 Assembly Member Richard Gottfried  
 Stephen & Cathy Graham  
 Michael Greif & Jonathan Fried  
 Lisa Gugenheim  
 Mark & Valerie Hadjipateras  
 Jane & Jonathan Heine  
 Peter Herdrich & Karen Trott  
 William Holtzman & S. Sylvia Shepard  
 Katy Homans & Patterson Sims  
 Barbara Howard  
 Philip & Alexandra Howard  
 Dana Ivey  
 Mark Evan Jacobs  
 Sy Jacobs  
 Whitney Scott & Peter Jacobson  
 Andrea Johnson  
 Traci Paige Johnson & Robert Mowen  
 Larry & Mary Jones  
 Maurice Kanbar  
 Ronald Kastner & Vanessa Boeye  
 Seth & Beth Klarman  
 Judy Kuhn & David Schwab  
 Allan & Nanette Larson

Michael P. Lawrence  
 Mary Ann Lefort  
 Joshua Lewis & Sarah Kay  
 Anna Li  
 Linda Li  
 Adrienne Lobel & Mark Linn Baker  
 John Lyons  
 Grace Lyu-Volckhausen  
 Greg MacPherson & Jane Perlmutter  
 Nat Magee & Alison Fraser  
 Wendy Makkena & Bob Krakower  
 Doda Manalansan  
 Kay Matuschullat & Allan Arffa  
 Paul McCrane & Dana Kellin  
 Fran McDormand & Joel Coen  
 William Michael McMahon & Meg McMahon  
 Rick Meese & Dan Lori  
 Richard & Denise Menelly  
 Josie Merck & Jim Stevenson  
 Brian Mertes  
 Audrey & Danny Meyer  
 Suzen Murakoshi & Mark Temme  
 Patricia M. Murphy, Esq. & Adam Spilka  
 Don & Sara Nelson  
 Ruth Nelson  
 Mark Nesselson, M.D. & Elliott Rosenblum  
 Lori O'Connor  
 Kevin O'Rourke & Edith Thurber  
 Carol Ochs & Bruce MacVittie  
 Jacki Ochs & Jan Kroeze  
 Elizabeth Peters  
 Peter & Ana Rosa Phillips  
 Oliver Platt & Camilla Campbell Platt  
 Jeremy Posner  
 Dean & Leslie Potashner  
 Peter & Helen Randolph  
 Richard Rauchenberger  
 Willie Reale & Jenny Gersten  
 Theresa Rebeck & Jess Lynn  
 Herald & Linda Ritch

David & Anita Rogerson  
 Robin Morse & Gus Rogerson  
 Mark Saad  
 Steve Sabba  
 Laura Sametz & Anton Fig  
 Karin & Tom Schall  
 Leslie Schine & Nils Nielsen  
 Maury Schott  
 Ken & Mary Ann Schuster  
 Mitchell Semel & Colleen Carroll  
 Tom Shadyac  
 Richard Shaffer & Nataalka Bukalo  
 Aaron & Elaine Shapiro  
 Bernice Baruch Shawl  
 Abby Jo Sigal & Matt Turner  
 Meg Simon  
 Talia Balsam & John Slattery  
 Abigail Rose Solomon  
 Jean Stein  
 David & Sara Stone  
 Abby Stranahan & Dave Ward  
 Susanna Styron & Darrell Larson  
 Brian Swardstrom & Bonnie Bernstein  
 Daniel Swee  
 Mariko Tada  
 John Turturro & Katherine Borowitz  
 Laura Valeroso & David Seidman  
 Wendy vanden Heuvel & Brad Coley  
 Ed Vassallo  
 John A. Vassallo  
 Mary Pat Walsh  
 Wendy Wasserstein  
 Sally & Lenny Weiss  
 Jane Bolster & Steve Wertimer  
 Carol Whitesides  
 Michael & Zena Wiener  
 Donald Windham  
 Joanne Woodward & Paul Newman  
 Bill Wrubel & Jennifer Crittenden  
 Jeffrey & Janine Yass  
 James & Mary Lin Yoshimura  
 William & Katherine Zaremby

## The 52nd Street Project presents the 2004 Playback Show

# "IF AT FIRST YOU DON'T SUCCEED..."

PLAYS THAT TRY AGAIN

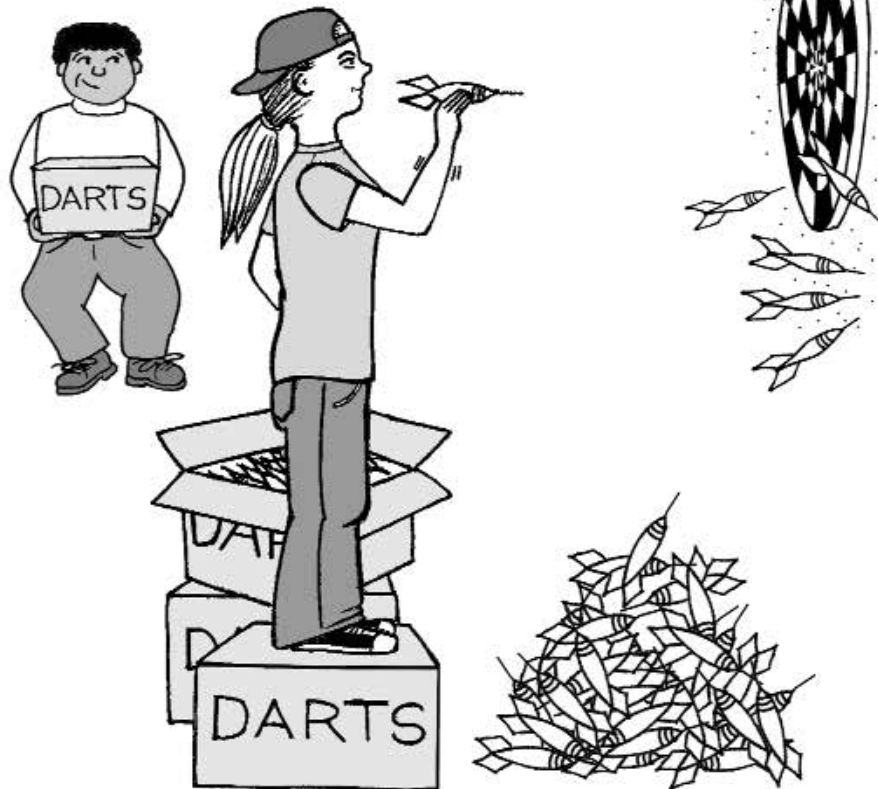

## THEATRE THREE

311 West 43rd St., 3rd Floor.  
 New York City

Fri., February 27 @ 7:30 p.m.,  
 Sat., Feb. 28 @ 3:00 and 7:30 p.m.,  
 Sun., Feb. 29 @ 3:00 p.m.



**IF AT FIRST YOU  
DON'T SUCCEED...  
PLAYS THAT TRY AGAIN**

THE 2004  
PLAYBACK SHOW  
FEBRUARY 27-29  
AT THEATRE THREE

**The 52nd Street Project Staff:**

Gus Rogerson, Artistic Director  
 Carol Ochs, Executive Director  
 John Sheehy, Director of Development and Marketing  
 Megan Sandberg-Zakian, Associate Artistic Director  
 George "X-Acto" Babiak, Production Manager  
 Liz Bell, Director of Education  
 Diana Rojas, Executive Assistant  
 Chris Ceraso, Teen Dean  
 Iris A. Brown, Graphic Designer  
 Mayleen Cancel and Anju Andre-Bergmann, Receptionists  
 Intern: Melanie Levy

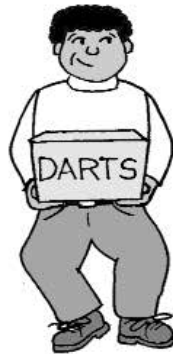

**Production Staff:**

**Composer:** Greg Pliska  
**Music Director:** Kari Riely  
**Choreographer:** Jeanne Simpson  
**Set Designer:** Kevin Joseph Roach  
**Lighting Designers:**  
 Greg MacPherson & Kelly Blackwell  
**Costume Designer:** Lora LaVon  
**Costume Assistant:** Jen Caprio  
**Sound Designer:** Betsy Rhodes  
**Stage Manager:** Linda Marvel  
**Slide Designers:**  
 Kent Albin, George Babiak,  
 Chris Bonanos, Nancy Edge,  
 Katherine Lumb, John Steward,  
 Alberta Testanero.

**"If At First" Illustration:** GRB

**Prop Design Team:**

George Babiak, Stephanie Bast,  
 Heather Carnduff, Nikki Fargardo,

Karen Munkel, Lee Rosen,  
 John Sheehy, Jolie Tong,  
 Ed Vassallo

**Furniture Crew:**

Alex Tomas (Boss)  
 & Timothy Thomas

**Prop Crew:**

Rachel Spiers, Melanie Levy,  
 Johanna Vidal, Octavia Rodriguez

**Load-in and Light Hang Crew:**

Kelly Blackwell, Melanie Levy,  
 Linda Marvel, Karen Munkel,  
 Doug Nervik, Christopher Randolph,  
 Lee Rosen, and the great Tom Schall

**House Managers:**

Karin Schall, Liz Bell

**Chefs:**

John Sheehy, Liz Bell,  
 & Bossy Flossy



The Playback Program is made possible with public funds from The New York State Council on the Arts, a state agency. The 52nd Street Project is a member of ART/NY and a participant in the New Generations Program, funded by Doris Duke Charitable Foundation/The Andrew W. Mellon Foundation and administered by Theatre Communications Group, the national organization for the American Theater.



**COOL STUFF ON SALE!**

Flyer Bars .....\$2.00, \$1.50 & \$1.00

*Shel Silverstein's "Fivey and Twoey" logo gear:*

Project Sweatshirts .....\$20.00  
 Project long sleeve t-Shirts .....\$15.00  
 Project Caps .....\$15.00  
 Project Mugs .....\$5.00  
 Project Spiral Notebooks (NEW!) .....\$5.00  
 Project Pencil 3-pack .....\$1.00  
 Rusty Magee CD's .....\$10.00

Thank you for coming to **IF AT FIRST YOU DON'T SUCCEED...** If you are not on our mailing list (or if your address has changed), please fill out this form and give it to us on your way out or mail it to the address below. We would also like to know if you are interested in becoming a volunteer. We need help in **all areas**, so be sure to fill out the entire form.

**PLEASE ADD ME TO YOUR MAILING LIST:**

FEB 2004

NAME: \_\_\_\_\_

ADDRESS: \_\_\_\_\_

\_\_\_\_\_ ZIP \_\_\_\_\_

HOME PHONE: \_\_\_\_\_

DAYTIME PHONE: \_\_\_\_\_

E-MAIL ADDRESS: \_\_\_\_\_

MY OCCUPATION: \_\_\_\_\_

MY HOBBIES: \_\_\_\_\_

**YES, I WOULD LIKE TO BE OF HELP. I CAN:**

- |   |   |  |
|---|---|--|
| <input type="checkbox"/> Help load in and out for shows | <input type="checkbox"/> Draw and/or paint  | <input type="checkbox"/> Help kids with homework |
| <input type="checkbox"/> Hang lights                    | <input type="checkbox"/> Help with mailings | <input type="checkbox"/> Teach kids a skill      |
| <input type="checkbox"/> Work on a backstage crew       | <input type="checkbox"/> Do office work     | <input type="checkbox"/> Be a chef at an event   |
| <input type="checkbox"/> Do graphic design              | <input type="checkbox"/> Design sound       | <input type="checkbox"/> Design and sew costumes |
| <input type="checkbox"/> Other (please specify) _____   |   |  |

**MY SCHEDULE IS:**

- Very flexible. I'm often available during weekdays.  
 Somewhat flexible. I can help on the occasional morning or afternoon during the week.  
 Not very flexible at all, but I've got some free time on evenings and weekends.

If you would like to mail this (and you're always welcome to enclose a tax-deductible contribution), you can send it to: **The 52nd Street Project**, 500 West 52nd St., New York, NY 10019. Or fax it to (212) 333-5598.



## Don't Miss Our Upcoming Shows!

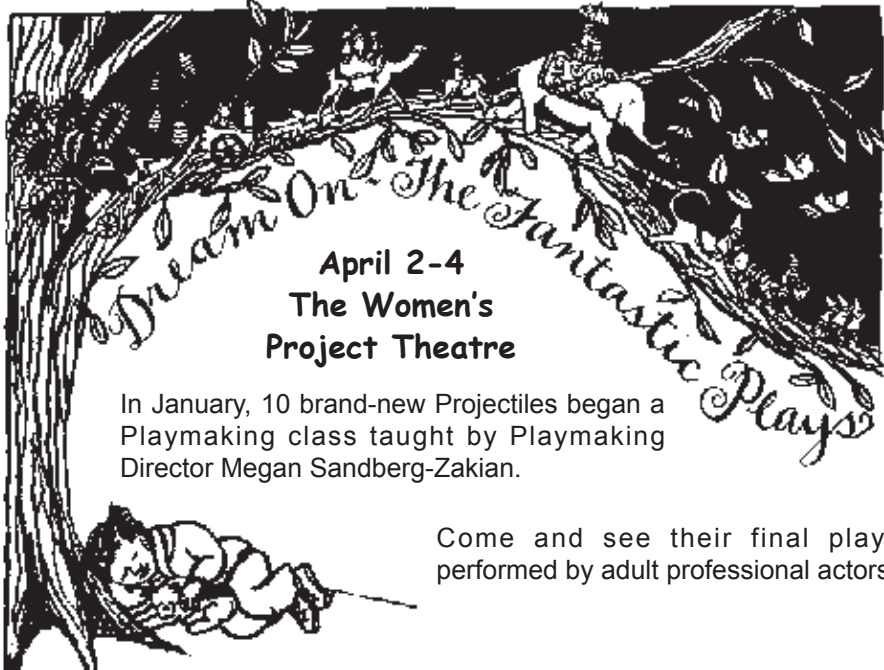

April 2-4  
The Women's  
Project Theatre

In January, 10 brand-new Projectiles began a Playmaking class taught by Playmaking Director Megan Sandberg-Zakian.

Come and see their final plays performed by adult professional actors.

Lewis Black and Jon Stewart, Co-Chairs,  
invite you to save the date for...

# THE PROJECTSHOW WITH JON STEWART

THE MOST IMPORTANT ANNUAL BENEFIT FOR THE 52ND STREET PROJECT, EVER

## MONDAY, MAY 10, 2004

**DON'T MISS IT! THERE WILL BE NO RE-RUN.**

For more information or reservations call John "TIVO" Sheehy @  
**212/333-5252**

The 52nd Street Project is a non-profit organization that brings children from the Hell's Kitchen neighborhood together with professional theater artists to create original theater. **IF AT FIRST** is a production of our **Playback** program, in which kid actor/playwrights wrote plays that were then "answered" by adult actor/playwright partners who write their own plays. We took the whole menagerie up to the idyllic hamlet of Clinton Corners, NY over the Valentine's Day weekend to rehearse the shows. In the final production, which you see here tonight, the partners perform both plays back-to-back. All of the kids involved are veterans of the Playmaking classes which were adapted for the Project by Daniel Judah Sklar from his book *Playmaking: Children Writing and Performing Their Own Plays*.

### The 52nd Street Project Board of Directors

Ben Barenholtz  
Lisa Benavides  
Rachel Chanoff  
Cathy Dantchik  
Noël Dawkins  
Wendy Ettinger,  
*chair emeritus*  
Louis P. Friedman  
Stephen Graham, *chair*  
Larry Jones  
James McDaniel  
Frances McDormand  
Patricia M. Murphy, Esq.

Carol Ochs  
Willie Reale,  
*founder*  
Gus Rogerson  
Shirley Rumierk,  
*alumni member*  
José Soto, Jr.,  
*alumni member*  
Pamala Tyson  
Laura Valeroso  
Wendy vanden Heuvel  
John A. Vassilaros  
Jenny Wiener

### Special Thanks

We're extremely grateful to **Maria Tucci and Robert Gottlieb, Griffin Dunne, and Terry Fitzpatrick and Stephen Perepeluk** for providing us with luxurious housing during our trip upstate. Thanks also to the **TheaterWorks Costume Shop** for loaning us some cool duds.

### In-Kind Contributions

We are also indebted to Neil A. Mazzella and Hudson Scenic Studios; the Murphy Law Office; Iris A. Brown; Ron Kastner and Capital Printing; Kenneth Cole Productions; Noggin; Scholastic, Inc.; Diageo Chateau & Estate Wines; Entertainment Weekly; Alison Fraser; Newman's Own; Sesame Workshop; Wendy Stuhlberg; Tarte, Inc.; Terax America; John A. Vassilaros; Watkins, Inc.; Mayor's Office of Film & Television; Boylan's Bottling Co.; David Sneddon & Fairway Market; Steve Olsen & The Westbank Cafe; Lorraine Tobias & Imaginary Studios; Jive Records, part of Zomba Music Group, Playwrights Horizons, Ensemble Studio Theatre; and Prime Films.

## IF AT FIRST YOU DON'T SUCCEED - ACT I

All original music composed by Greg Pliska

### The Jock and the Geek

By Jeremy Butler, age 13. Dramaturg/Director: Carlo Alban

**Dr. Spencer and Mr. Cool** Written and directed by Carlo Alban

Spencer .....Jeremy Butler  
Chris .....Carlo Alban  
Other Jock .....Alex Tomas  
Voice of Mr. Wolf .....Timothy Thomas  
Other students .....The Crew

*"A Little Cool-Aid"* lyrics by Carlo Alban

### The Decision

By Anthony Mejia, age 14. Dramaturg: Jerome Hairston  
Director: Stephanie Bast

### The Heart of a Madman

Written by Jerome Hairston and directed by Stephanie Bast

Wild Joe .....Anthony Mejia  
Bonny .....Stephanie Bast  
Cop .....Timothy Thomas  
Teller .....Melanie Levy

### Out of the Box

By Anastasia Kehr, age 13. Dramaturg/Director: Danny Goldstein

**Under Your Nose** Written and directed by Danny Goldstein

Liberty .....Ani Kehr  
Liberty's kid brother/Red .....Danny Goldstein  
Television reporter/Small child .....John Sheehy  
*"Closet Monster"* lyrics by Danny Goldstein

### I'm Sorry

By Wonkezeh Newenle, age 15. Dramaturg: Megan Sandberg-Zakian  
Directed by George Babiak

**I'm Sorry II** Written by Michael Bernard. Directed by George Babiak

Andrew .....Wonkezeh Newenle  
Kate .....Phyllis Somerville  
Supermarket Workers .....Johanna Vidal, Timothy Thomas  
Waiters .....Alex Tomas, Octavia Rodriguez  
Violinists .....Kari Riely, George Babiak

*"Sorry to See You Hurt"* lyrics by Wonkezeh Newenle

☞ **Intermission!** ☜

## IF AT FIRST YOU DON'T SUCCEED - ACT II

### The Help of a Friend

By Adalberto Rodriguez, age 14. Dramaturg/Director: Ed Vassallo

**Which Friend Should You Help?** Written and directed by Ed Vassallo

Jet .....Berto Rodriguez  
Peanut .....Ed Vassallo  
Malf .....Alex Tomas  
The Girl .....Melanie Levy

### The Best of Both Worlds

By Solangee Acosta, age 14. Dramaturg/Director: Lee Rosen

### When Both Worlds Collide

Written and directed by Lee Rosen

Chris .....Solangee Acosta  
Janay .....Lee Rosen  
Other kids .....The Crew

*"Project Z"* lyrics by Lee Rosen

### Dreams

By Ariana Casablanca, age 14. Dramaturg/Director: Erin Quinn Purcell

### Dreams II

Written and directed by Erin Quinn Purcell

Brenda .....Ariana Casablanca  
Jessica .....Erin Quinn Purcell  
Josh .....Alex Tomas  
Voice of the Stage Manager .....Johanna Vidal

*"The Truth About Friendship"* lyrics by Ariana Casablanca

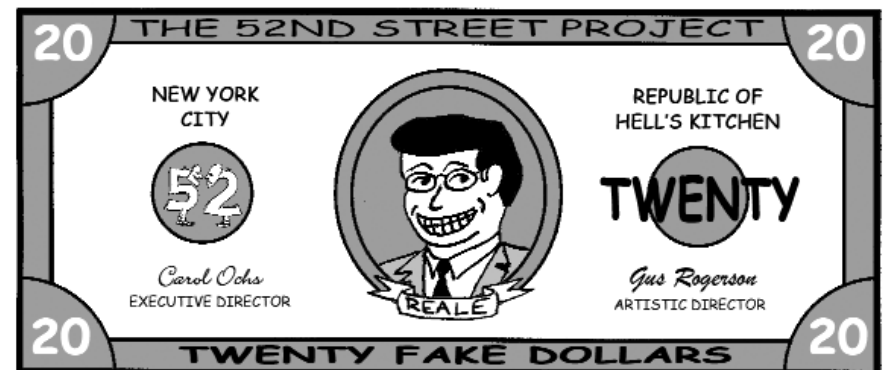

The 52nd Street Project gratefully acknowledges the support of the following foundations and corporations: Altria Employee Fund, Barker Welfare Foundation, The Barnsley Foundation, Bloomberg, Blythmour Corporation, California Comedy, Capital Research Company, Carnegie Corporation of New York, Comedy Central, Davis Polk & Wardwell, Deutsche Bank of Americas Foundation, The Dramatists Guild Fund, Dramatists Play Service, Eleanor, Adam & Mel Dubin Foundation, Entertainment Weekly, The Horace W. Goldsmith Foundation, The William and Mary Greve Foundation, The Hennessy Foundation, Holland Lodge Foundation, Inc., Lloyds TSB Bank plc, Lucille Lortel Foundation, James A. Macdonald Foundation, Major League Baseball, Ann M. Martin Foundation, Mellon Bank, N.A., The New World Foundation, The New York Times Company Foundation, Newman's Own, Norcross Wildlife Foundation, Inc., Pfizer Foundation, Rytech Inc., St. James' Church, The Fan Fox & Leslie R. Samuels Foundation, Stranahan Foundation, Susquehanna Partners, G.P., Tiger Baron Foundation, John A. Vassilaros & Son, Inc., The Vervane Foundation, The Wiener Family Foundation, Zagat Survey, Felix Zaremba & Co. Inc. In addition the following individuals made gifts of over \$200 to The 52nd Street Project this year (list is current as of 4/1/04):

Jace Alexander & Maddie Corman	Angelina Fiordellisi	Linda Li	Laura Sametz & Anton Fig
Lucie Amaz & Laurence Luckinbill	Alexa Fogel	Adrienne Lobel & Mark Linn Baker	Karin & Tom Schall
Dylan & Becky Baker	David Frankel	John Lyons	Leslie Schine & Nils Nielsen
Ben Barenholtz	Frank Frattaroli	Grace Lyu-Volckhausen	Maury Schott
Jessica Bauman	Katherine Freedman	Greg MacPherson & Jane Perlmutter	Ken & Mary Ann Schuster
Laurie Becker & Rick Sweren	Naomi Freundlich & Charles Miles	Nat Magee & Alison Fraser	Lauren Seikaly & Michael Huber
Meredith Beeuwkes	Louis & Patrice Friedman	Wendy Makkena & Bob Krakower	Mitchell Semel & Colleen Carroll
Lisa Benavides & Tim Nelson	Janeane Garofalo	Doda Manalansan	Tom Shadyac
Vicky Bijur & Ed Levine	Rose Gasner & Larry Chertoff	Donald Margulies & Lynn Street	Richard Shaffer & Natalka Bukalo
Lewis Black	Ileen Getz & Mark Grinnell	Kay Matschullat & Allan Arffa	Aaron & Elaine Shapiro
Richard Blackstone & Yildez Yuksek	Paul & Liz Giamatti	Paul McCrane & Dana Kellin	Bernice Baruch Shawl
Tessa Blake	Nancy Giles	Fran McDormand & Joel Coen	Peter Shinoda
Buzz Bovshow	Lloyd & Kilty Gilmour	William Michael McMahon & Meg McMahon	Abby Jo Sigal & Matt Turner
Bob Boyett	Judy Goldman & Michael Pillinger	Rick Meese & Dan Lori	Meg Simon
Becky Browder & Ted Neustadt	Tony Goldwyn & Jane Musky	Richard & Denise Menelly	Talia Balsam & John Slattery
Susan Bruce & Peter Hedges	Assembley Member	Josie Merck & Jim Stevenson	Abigail Rose Solomon
Alfred C. Cerullo III	Richard Gottfried	Brian Mertes	Jean Stein
Rachel Chanoff	Stephen & Cathy Graham	Audrey & Danny Meyer	David & Sara Stone
Glenda Chesshir	Michael Greif & Jonathan Fried	Judy Minor	Abby Stranahan & Dave Ward
Kirk & Katherine Holt Citron	Connie Grappo & Lee Wilkof	Robin Morse & Gus Rogerson	Susanna Styrone & Darrell Larson
Darah Cloud & Dave Owens	Lisa Gugenheim	Suzen Murakoshi & Mark Temme	Brian Swardstrom & Bonnie Bernstein
Ruth Cohen	Mark & Valerie Hadjipateras	Patricia M. Murphy, Esq. & Adam Spilka	Daniel Swee
Lieta Heslen-Cohen & Richard Cohn	Jane & Jonathan Heine	Don & Sara Nelson	Mariko Tada
Tricia Cooke & Ethan Coen	Peter Herdrich & Karen Trott	Ruth Nelson	Timothy Thomas
Hyla & Richard Crane	William Holtzman & S. Sylvia Shepard	Mark Nesselson, M.D. & Elliott Rosenblum	John Turturro & Katherine Borowitz
Margaret Crimmins	Katy Homans & Patterson Sims	Lori O'Connor	Laura Valeroso & David Seidman
Billy Crudup	Barbara Howard	Kevin O'Rourke & Edith Thurber	Wendy vanden Heuvel & Brad Coley
Tom Cruise	Philip & Alexandra Howard	Carol Ochs & Bruce MacVittie	Ed Vassallo
Catherine Curtin	Dana Ivey	Jacki Ochs & Jan Kroeze	John A. Vassallo
Willem Dafeo	Mark Evan Jacobs	Elizabeth Peters	Mary Pat Walsh
John J. Dagenhard	Sy Jacobs	Peter & Ana Rosa Phillips	Wendy Wasserstein
Arthur Dantchik	Whitney Scott & Peter Jacobson	Oliver Platt & Camilla Campbell Platt	Sally & Lenny Weiss
Cathy Dantchik	Andrea Johnson	Jeremy Posner	Jane Bolster & Steve Wertimer
Leslie Dantchik	Traci Paige Johnson & Robert Mowen	Dean & Leslie Potashner	Carol Whitesides
Peter & Judith Dawkins	Kristen Johnston	Peter & Helen Randolph	Michael & Zena Wiener
Georgia & William Delano	Larry & Mary Jones	Richard Rauchenberger	Donald Windham
Jonathan Demme	Aram Kailian	Willie Reale & Jenny Gersten	Frank Wood & Jo Porter
Richard & Rebecca Dresser	Maurice Kanbar	Theresa Rebeck & Jess Lynn	Peter & Helen Woodward & Paul Newman
Christopher & Karen Eddowes	Ronald Kastner & Vanessa Boeye	Herald & Linda Ritch	Bill Wrubel & Jennifer Crittenden
Mario Egozi	Seth & Beth Klarman	David & Anita Rogerson	Jeffrey & Janine Yass
David & Chrysti Eigenberg	Judy Kuhn & David Schwab	Martha Roth & Bill Irwin	James & Mary Lin Yoshimura
Ned Eisenberg & Patricia Maguire	Allan & Nanette Larson	Mark Saad	William & Katherine Zaremba
Nora Ephron	Michael P. Lawrence	Steve Sabba	
Wendy Ettinger & Derek McLane	Mary Ann Lefort		
Tom Feeney & Paul Parzuchowski	Ilana Levine & Dominic Fumusa		
Peter Jay Fernandez & Denise Burse	Joshua Lewis & Sarah Kay		
Martin Fetner & William Coury	Anna Li		

## The 52nd Street Project presents



## THE SPRING 2004 PLAYMAKING PLAYS

Fri., April 2 at 7:30 p.m.  
Sat., April 3 at 7:30 p.m.  
Sun., April 4 at 3:00 p.m.

The Women's Project Theater, 424 West 55th Street

**DREAM ON...**  
*The Fantastic Plays*

THE SPRING, 2004  
 PLAYMAKING SHOW  
 APRIL 2-4  
 AT THE WOMEN'S PROJECT

**The 52nd Street Project Staff:**

Gus Rogerson, Artistic Director  
 Carol Ochs, Executive Director  
 John Sheehy, Director of Development and Marketing  
 Megan Sandberg-Zakian, Associate Artistic Director  
 George "X-Acto" Babiak, Production Manager  
 Liz Bell, Director of Education  
 Diana Rojas, Executive Assistant  
 Chris Ceraso, Teen Dean  
 Iris A. Brown, Graphic Designer  
 Mayleen Cancel and Anju Andre-Bergmann, Receptionists



**Production Staff:**

**Composer:** Joel Derfner  
**Music Director:** Patrick Barnes  
**Fight Choreographer:** Tom Schall  
**Set Designer:** Kevin Joseph Roach  
**Lighting Designer:**  
 Greg MacPherson  
**Costume Designer:** Crystal Thompson  
**Costume Assistants:**  
 Bobby Andres and Deb Lucas  
**Sound Designer:** Maury Schott  
**Stage Manager:** Karen Munkel  
**Slide Designers:**  
 George Babiak, Chris Bonanos,  
 Jeremy Harger, Tyra Hillsten,  
 Katherine Lumb, Alexandre Mentha,  
 John Steward, Alberta Testanero,  
 Iwona Waluk  
**"Dream On" Illustration:**  
 Laura Kvasnosky

**Prop Design Team:**

George Babiak, Anju Andre-Bergmann, Stephanie Bast, Nicole Fargardo, Danny Goldstein, Karen Munkel, Lee Rosen

**Furniture Crew:**

Zebulun Santiago, Anthony Mejia, & Eric Fisher

**Prop Crew:**

Nicole Fargardo, Kayelani Silva, & Rachel Spiers

**Load-in and Light Hang Crew:**

Geiselda Beaudin, Kelly Blackwell, Tim Gallagher, Nedra Gallegos, Karen Munkel, Eric Pomert, Kevin Ryder, & the great Tom Schall

**House Managers:**

Karin Schall, Mary Pat Walsh, Liz Bell



The Playmaking Program is made possible with public funds from The New York State Council on the Arts, a state agency. The 52nd Street Project is a member of Art/NY and a participant in the New Generations Program, funded by Doris Duke Charitable Foundation/The Andrew W. Mellon Foundation and administered by Theatre Communications Group, the national organization for the American Theater.



**COOL STUFF ON SALE!**

- Flyer Bars .....\$2.00, \$1.50 & \$1.00  
*Shel Silverstein's "Fivey and Twoey" logo gear:*  
 Project Sweatshirts .....\$20.00  
 Project long sleeve t-Shirts .....\$15.00  
 Project Caps .....\$15.00  
 Project Mugs .....\$5.00  
 Project Spiral Notebooks (NEW!) .....\$5.00  
 Project Pencil 3-pack .....\$1.00  
 Rusty Magee CD's .....\$10.00

Thank you for coming to **DREAM ON**. If you are not on our mailing list (or if your address has changed), please fill out this form and give it to us on your way out or mail it to the address below. We would also like to know if you are interested in becoming a volunteer. We need help in **all areas**, so be sure to fill out the entire form.

**PLEASE ADD ME TO YOUR MAILING LIST:**

APR 2004

NAME: \_\_\_\_\_

ADDRESS: \_\_\_\_\_

\_\_\_\_\_ ZIP \_\_\_\_\_

HOME PHONE: \_\_\_\_\_

DAYTIME PHONE: \_\_\_\_\_

E-MAIL ADDRESS: \_\_\_\_\_

MY OCCUPATION: \_\_\_\_\_

MY HOBBIES: \_\_\_\_\_

**YES, I WOULD LIKE TO BE OF HELP. I CAN:**

- |   |   |  |
|---|---|--|
| <input type="checkbox"/> Help load in and out for shows | <input type="checkbox"/> Draw and/or paint  | <input type="checkbox"/> Help kids with homework |
| <input type="checkbox"/> Hang lights                    | <input type="checkbox"/> Help with mailings | <input type="checkbox"/> Teach kids a skill      |
| <input type="checkbox"/> Work on a backstage crew       | <input type="checkbox"/> Do office work     | <input type="checkbox"/> Be a chef at an event   |
| <input type="checkbox"/> Do graphic design              | <input type="checkbox"/> Design sound       | <input type="checkbox"/> Design and sew costumes |
| <input type="checkbox"/> Other (please specify) _____   |   |  |

**MY SCHEDULE IS:**

- Very flexible. I'm often available during weekdays.  
 Somewhat flexible. I can help on the occasional morning or afternoon during the week.  
 Not very flexible at all, but I've got some free time on evenings and weekends.

If you would like to mail this (and you're always welcome to enclose a tax-deductible contribution), you can send it to: **The 52nd Street Project**, 500 West 52nd St., New York, NY 10019. Or fax it to (212) 333-5598.



**MONDAY, MAY 10, 2004**

**Hosted by  
Jon Stewart and Lewis Black  
with  
Edie Falco and  
Tim Blake Nelson**

**For information  
or reservations  
call  
John Sheehy at  
(212) 333-5252**



**THE** A GALA TO BENEFIT THE 52ND STREET PROJECT, NYC  
**PROJECTSHOW**  
WITH **JON STEWART**

The 52nd Street Project is a non-profit organization that brings children from the Hell's Kitchen neighborhood together with professional theater artists to create original theater. **DREAM ON** is a production of our Playmaking program. Young people participate in a nine-week playwriting course taught by Megan Sandberg-Zakian and adapted for the Project by Daniel Judah Sklar from his book *Playmaking: Children Writing and Performing Their Own Plays*. At the end of the course, each child is given two actors, a theme, and a dramaturg/director who guides him or her through the writing of a play during a weekend retreat in the country (Kent, Connecticut, for this show). Tonight's performance is the end result.

---

**The 52nd Street Project Board of Directors**

- |  |  |
|--|--|
| Ben Barenholtz                           | Carol Ochs                               |
| Lisa Benavides                           | Willie Reale,<br><i>founder</i>          |
| Rachel Chanoff                           | Gus Rogerson                             |
| Cathy Dantchik                           | Shirley Rumierk,<br><i>alumni member</i> |
| Noël Dawkins                             | José Soto, Jr.,<br><i>alumni member</i>  |
| Wendy Ettinger,<br><i>chair emeritus</i> | Pamala Tyson                             |
| Louis P. Friedman                        | Laura Valeroso                           |
| Stephen Graham, <i>chair</i>             | Wendy vanden Heuvel                      |
| Larry Jones                              | John A. Vassilaros                       |
| James McDaniel                           | Jenny Wiener                             |
| Frances McDormand                        |  |
| Patricia M. Murphy, Esq.                 |  |

---

**In-Kind Contributions**

We are also indebted to Neil A. Mazzella and Hudson Scenic Studios; the Murphy Law Office; Iris A. Brown; Ron Kastner and Capital Printing; Kenneth Cole Productions; Noggin; Scholastic, Inc.; Diageo Chateau & Estate Wines; Entertainment Weekly; Alison Fraser; Newman's Own; Sesame Workshop; Wendy Stuhlberg; Tarte, Inc.; Terax America; John A. Vassilaros; Watkins, Inc.; Mayor's Office of Film & Television; Boylan's Bottling Co.; David Sneddon & Fairway Market; Steve Olsen & The Westbank Cafe; Lorraine Tobias & Imaginary Studios; Jive Records, part of Zomba Music Group, Playwrights Horizons, Ensemble Studio Theatre; and Prime Films.

---

**Special Thanks**

We're grateful to **Stephen, Cathy, Juliet, and Tommy Graham** for graciously allowing us to bring the chaos of a Playmaking weekend to their lovely home in Kent, Connecticut. Their staff, including **Miriam** and **Chef Erik**, get a round of applause, too. Thanks also go to **Sam and Lynn Waterston**, and **Oliver and Camilla Platt** for providing accommodations. Thanks also to **Julie Kline, Melanie Levy, and Kate Weisburd** for helping out in Playmaking class.

## DREAM ON - ACT I

All original music composed by Joel Derfner

### The Clumsy One

by Carlos Muentes, age 9. Dramaturg/Director: Glynis Rigsby

Key ..... Joel de la Fuente  
Pen ..... Marsha Stephanie Blake  
“It’s Mean to Be Mean” lyrics by Carlos Muentes

### The Guy Who Lived in the Street

by Angel Silva, age 10. Dramaturg/Director: Joe White

Brad ..... Stephan Kolbert  
Glenn ..... Ephraim Lopez

### The Dead Mother and the Lonely Girl

by Arielle Velasquez, age 12. Dramaturg/Director: Sonia Manzano

Lisa ..... Jessica Walling  
Kathy ..... Lizzy Cooper Davis  
Mother’s Voice ..... Nancy Giles

“Going to Sleep” lyrics by Arielle Velasquez

### Zoe and Phoebe - Friends Forever

by Janiece Krystle Aponte, age 10.

Dramaturg: Liz Bell, Director: Jessica Bauman

Phoebe ..... Deirdre O’Connell  
Zoe ..... Jenny Bacon

“Sad Song” lyrics by Janiece Aponte.

### Friends and Siblings

by Lily Houghton, age 9.

Dramaturg/Director: Mary Pat Walsh

Charlie Supertop ..... Edward O’Blenis  
Rosie Supertop ..... Anita Flanagan  
Cool Kid ..... Kayelani Silva  
Cool Kid Posse ..... Crew

 **Intermission!** 

## DREAM ON - ACT II

### The Boxer and The Dancer

by Dale Fetterman, age 10. Dramaturg/Director: Drew Cortese

Mat Reva ..... Kevin Geer  
Patrosa ..... Nancy Giles  
Boxing Announcer ..... John Sheehy  
Heavyweight Champion Michael Lane ..... George Babiak  
Corner People ..... Crew

### Best Brothers and Good Friends

by Muhammad Cunningham, age 10.

Dramaturg/Director: Michael Potts

Alex ..... Emilio Delgado  
Josh ..... Chris McCann  
Mom ..... Nancy Giles  
Operator ..... John Sheehy

### Dream of the Yankees

by Hera Andre-Bergmann, age 9.

Dramaturg/Director: Erica Schmidt

Nicki Modern ..... Brienan Bryant  
Dazed Dream ..... Katherine Wallach  
Joe Torre ..... George Babiak

### Comet and Bud’s Adventure

by Pablo Maldonado, age 10. Dramaturg/Director: Alex Draper

Comet ..... Edie Falco  
Bud ..... Nate Corddry

“Night Shift” lyrics by Pablo Maldonado.



*Honorary Chairs*  
Lewis Black and Jon Stewart  
*and Corporate Hosts*  
Ars Nova PGM,  
Louis Friedman, Bear Stearns  
Tobak-Dantchik Events  
*and the Board of Directors of*  
*The 52nd Street Project present*

# THE PROJECT SHOW

WITH **JON STEWART**

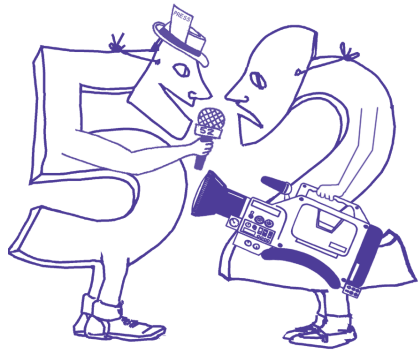

**MONDAY MAY 10, 2004**  
**AT CAPITALE**

**BOARD CHAIR**

Stephen Graham

**EXECUTIVE DIRECTOR**

Carol Ochs

**ARTISTIC DIRECTOR**

Gus Rogerson

## CO-CHAIRS

Lisa Benavides	Patrice Friedman
Becky Browder	Karin Schall
Cathy Dantchik	Laura Valeroso
Louis P. Friedman	Mary Pat Walsh
Jenny Wiener	

## THE BOARD OF DIRECTORS

Ben Barenholtz	Patricia M. Murphy, Esq.
Lisa Benavides	Carol Ochs
Rachel Chanoff	Willie Reale, <i>founder</i>
Cathy Dantchik	Gus Rogerson
Noël Dawkins	Shirley Rumiark, <i>alumni member</i>
Wendy Ettinger, <i>chair emeritus</i>	José Soto, Jr., <i>alumni member</i>
Louis P. Friedman	Pamala Tyson
Stephen Graham, <i>chair</i>	Laura Valeroso
Larry Jones	Wendy vanden Heuvel
James McDaniel	John A. Vassilaros
Frances McDormand	
Jenny Wiener	

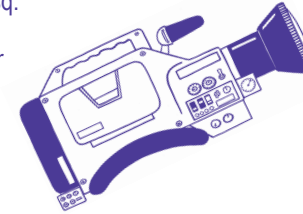

## THE 52ND STREET PROJECT GRATEFULLY ACKNOWLEDGES...

Benefit Cosmetics  
Iris A. Brown  
Bourjois Paris  
Bumble and bumble  
Capital Printing/Ronald J. Kastner  
Kenneth Cole Productions  
Diageo Chateau & Estate Wines Co.  
Entertainment Weekly  
Jive Records  
*A division of Zomba Music Group*  
Lucky Magazine  
Micro Touch/Finishing Touch Trimmers  
Molton Brown  
MOP Cosmetics  
Newman's Own  
Noggin/The N  
Pharma/Omni Printing  
Sesame Workshop  
Wendy Stulberg  
Terax America  
John A. Vassilaros & Sons  
Watkins Incorporated  
*Healthier Living Since 1868*

## THE PROJECT SHOW CAST

### THE ADULTS

Lewis Black  
Rob Corddry  
Edie Falco  
Tim Blake Nelson  
and  
Jon Stewart

### THE KIDS

John Cuevas  
Christopher Ramirez  
Jennifer Ramirez  
Johanna Vidal

### DIRECTED BY

Jonathan Bernstein

### WRITTEN BY

Willie Reale &  
John Sheehy

### SET DESIGN

George Babiak &  
Kevin Joseph Roach

### LIGHTING DESIGN

Greg MacPherson &  
Jason Wells

### COSTUME DESIGN

Crystal Thompson

### SOUND DESIGN

Tom Morse

### STAGE MANAGER

Hank Meiman

### FOAMCORE CARPENTRY

George Babiak



## **BANNER HEADLINERS**

Arthur Dantchik  
Cathy Dantchik  
Patrice & Louis Friedman, Bear Sterns  
Cathy & Stephen Graham  
Jenny Wiener & Jon Steingart, Ars Nova  
Jeff Yass

## **LATE-BREAKING STORY TELLERS**

Comedy Central  
Wendy Ettinger & Derek McLane  
Sy Jacobs  
Paulette & Jeremy Posner  
Joanne Woodward & Paul Newman

## **LOCAL COLOR COMMENTATORS**

Tom Cruise  
The Dawkins Family Foundation  
Amy Friedman, Noggin/The N  
Alexandra Gersten-Vassilaros & Johnny  
Coffeeshopolis  
HBO  
Michelle Katz  
Fred Nelson, Entertainment Weekly  
Clea Newman  
David Pecker, American Media  
Ana Rosa & Peter Phillips, Lloyds TSB  
Maury Schott  
Sesame Workshop  
Laura Valeroso & David Seidman  
Wendy vanden Heuvel  
Randall Weisenburger

## **SENIOR ANALYSTS**

Gavin Berger & Craig Berggren	Nancy Giles
Elizabeth & Alexander Bernstein	Susan Jacobs
Linda & Arthur Carter	Kristen Johnston
Alfred C. Cerullo, III	Deborah & James Kern
Kathleen Clark & Richard Frankel	Steve Klinsky
Jennifer Crittendon & Bill Wrubel	John S. Lyons
Leslie Dantchik	Betsy MacIsaac & Robert Goldberg, Yorke Construction Corp.
Nora Ephron	Sonia Manzano & Richard Reagan
Frank Frattaroli	Josephine Merck & Jim Stevenson
Janeane Garofalo	Audrey & Danny Meyer



Walter Mosley  
Michelle Mulitz & Morty Gudelsky  
Rona & Randy Nelson  
Sara & Don Nelson  
Jane Perlmutter & Greg MacPherson  
Elizabeth Peters  
Lise Rehmaldt  
Theresa Rebeck & Jess Lynn  
Michael Ritchie

Anonymous  
Cecilia Arana-Grant & Dr. Kevin Grant  
Emily Armstrong  
Adam Leitman Bailey  
Becky & Dylan Baker  
June Ballinger & Michael Goldstein  
Vera Ann Baquet & Vicki Rundberg-Rivera  
Ben Barenholtz  
Lisa Benavides & Tim Blake Nelson  
Stephen Bernstein  
Jane Bolster & Steve Wertimer  
Buzz Bovshow  
Rick Boynton  
Jon Brielle  
Kathryn Briggs, Dramatists Play Service  
Becky Browder & Ted Neustadt  
Susan Bruce & Peter Hedges  
Denise Burse & Peter Jay Fernandez  
Cora Cahan & Bernard Gersten  
Camilla Campbell  
Kassie Canter  
Colleen Carroll & Mitchell Semel  
Heather Carter  
Constance Casey & Harold Varmus  
Rachel Chanoff  
Sharon Chantiles  
David Copeland  
David Costabile  
William Coury & Martin Fettner  
Rebecca & Daniel Day-Lewis  
Yvonne DeSanti  
Paula Devicq & Joe Taylor  
Rebecca & Richard Dresser  
Bonnie Dry  
Patricia Dunnock & Ned Eisenberg  
Tana & Bill Dye  
Karen & Chris Eddowes

Mark Roberts  
Anita A. & David S. Rogerson  
Daryl Roth  
Steve Sabba  
Sarah & Jeff Stafford  
Jane & R.L. Stine  
Adriana Trigiani & Tim Stephenson  
Mary Pat Walsh  
Frank Wood  
Mary Lin & Jim Yoshimura

## **BUREAU CHIEFS**

Renee Edelman  
Paul Ferrara  
Liz Fillo & Chris Coucill  
Anita Flanagan  
Alison Fraser & Nat Magee  
Rose Gasner & Larry Chertoff  
Jenny Gersten & Willie Reale  
Ileen Getz & Mark Grinnell  
Amy & George Goldstein  
Carol & Larry Goldstein  
Connie Grappo & Lee Wilkof  
Lisa J. Gugenheim & Lawrence Nathanson  
Wendy & Alan Halpern  
Laura Hamilton  
Jane & Jonathan Heine  
Amy Herzig  
Katy Homans & Patterson Sims  
Sarah Horowitz & David Venarde  
Charlie Huntley  
Donna & Thomas Jaycox  
Amanda Johns  
Julie Johns  
Aram Kailian & Teni Apelian  
Sheryl Kaller & Scott Zaretsky  
Cindy Kaplan & David Froelich  
Sarah Kay & Josh Lewis  
Pat Kirby  
Belle & Roger Kuhn  
Liza Lerner  
Aimee Levine  
Ilana Levine, Dominic Fumusa & Georgia Levi Fumusa  
Anna Antonia Li  
Katherine Lumb  
Bruce MacVittie  
Sonya Martin  
Brigid McCarthy  
Barbara McCrane & Paul Reale  
Frances McDormand & Joel Coen  
Marianne & Andrew McKeon  
Rick Meese & Dan Lori  
Emily & John Morgan  
Mala & Sham Mosher

Suzen Murakoshi & Mark Temme  
Laura & Richard Murawczyk  
Patricia Murphy & Adam Spilka  
Frank Napolitano  
Jacki Ochs & Jan Kroeze  
Sascha Paladino  
Susan Ochs Phillips  
Judy & Michael Pillinger  
Katharyn Pinder  
Eric Pomert  
Kelly Powell  
Christopher Randolph  
Robert Reale  
Martha Roth & Bill Irwin  
Julie Rottenberg & Ben Rubin  
Laura Rovinsky & Bruce Grossberg  
Laura Sametz & Anton Fig  
Karin & Thomas Schall  
David Schwab  
Whitney Scott & Peter Jacobson  
Jeffrey Seller  
Sylvia Shepard & Will Holtzman  
Seth Shepsle & Michael Sheehan  
Meg Simon

Landon Slane  
Lois Smith  
John Steber & Robert Shaffron  
Joel Stigliano, Dramatists Play Service  
Lynn Street & Donald Margulies  
Wendy Stulberg & David Nanasi  
Susanna Styron & Darrell Larson  
Daniel Swee  
Lili Taylor  
Edith Thurber & Kevin O'Rourke  
Lorraine Tobias & Alex Draper  
Anne Torsiglieri & Michael Bernard  
Karen Trott & Peter Herdrich  
Cynthia Vance & Robert Abrams  
Susan J. Vitucci  
Brenda Wehle & John C. Lynch  
Ali Marsh Weller & Fred Weller  
Carol Whitesides  
Max Wilk  
George Xenos  
Yildiz Yuksek & Richard Blackstone  
Paul Zakian  
Elisa Zuritsky & Jordan Barowitz

List current as of 5/5/04

## **THE 52ND STREET PROJECT STAFF**

Gus Rogerson, Artistic Director  
Carol Ochs, Executive Director  
John Sheehy, Dir. of Development and Marketing  
George Babiak, Production Manager  
Megan Sandberg-Zakian, Associate Artistic Director  
Liz Bell, Director of Education  
Diana Rojas, Executive Assistant  
Chris Ceraso, Teen Dean  
Iris A. Brown, Graphic Designer

## **BENEFIT VOLUNTEERS**

Susan Ash, Jack Babin, Perry McBain Daniel, Adam Felber, Danny Goldstein, Bryan Gmitter, Ray Harold, Tucker Howard, Sheryl Kaller, Eric Migliorini, Catherine Mueller, Karen Munkel, Kari Riely, Lee Rosen, Kim D. Sherman, Jeanne Simpson, Vanessa Valdes, Ed Vassallo, Dan Wojnar

## **SPECIAL THANKS**

Becky Browder, William Curran, Beth Emelson, Liz Flahive, Terry Fitzpatrick, Amy Friedman, Jenny Gersten, Mark Jacobs, John Laird, Barbara McCrane, Christopher Randolph, Karin & Tom Schall, Mary Pat Walsh



**The 52nd Street Project** is a non-profit organization that brings children from the Hell's Kitchen neighborhood together with professional theater artists to create original theater. The Replay program gives children who are graduates of the Project's Playmaking class a chance to hone their skills in an advanced writing workshop taught by Megan Sandberg-Zakian. Over the nine weeks of Replay class, these young playwrights explored varied sources of inspiration, including a visit to the Whitney Museum and two trips to the theater, studied dramatic structure, and learned to embrace the dreaded rewrite. The resulting plays are featured in tonight's reading.

### Special Thanks

We're grateful to **Jenny Wiener, Jon Steingart, and Ars Nova Theater** for making this evening possible. The plays wouldn't have made it to the page without the help of the Replay class volunteers: **Megan Cramer, Jeff LaGreca, Carolyn Nastro, Adam Robinson, Charlie Tocantins, and Malinda Walford**. Big ups to **Rosa Hires and Sally Morse at Dodger Theatricals** for hooking the class up with tickets to the toe tappin' "*42nd Street*", and to **Marianna Houston and Lisa Poyer** for providing us with an excellent model of good playwriting by sending us to "*Raisin in the Sun*."

### The Project Staff

Gus Rogerson ..... Artistic Director  
Carol Ochs ..... Executive Director  
John Sheehy ..... Director of Development  
Megan Sandberg-Zakian ..... Associate Artistic Director  
George Roman Babiak ..... Production Manager  
Liz Bell ..... Director of Education  
Diana Rojas ..... Executive Assistant  
Chris Ceraso ..... Teen Dean  
Iris A. Brown ..... Graphic Designer  
Anju Andre-Bergmann, Mayleen Cancel ..... Receptionists  
Andrew Kelsey, Emily Meisler, Reese Smith ..... Interns

### The 52nd Street Project Board of Directors

Ben Barenholtz  
Lisa Benavides  
Rachel Chanoff  
Cathy Dantchik  
Noël Dawkins  
Wendy Ettinger,  
*chair emeritus*  
Louis P. Friedman  
Stephen Graham, *chair*  
Larry Jones  
James McDaniel  
Frances McDormand  
Patricia M. Murphy, Esq.

Carol Ochs  
Willie Reale,  
*founder*  
Gus Rogerson  
Shirley Rumierk,  
*alumni member*  
José Soto, Jr.,  
*alumni member*  
Pamala Tyson  
Laura Valeroso  
Wendy vanden Heuvel  
John A. Vassilaros  
Jenny Wiener

The 52nd Street Project Presents

---

# THE 2004 REPLAY READINGS

---

**13 PLAYS BY  
13 YOUNG PLAYWRIGHTS**

Monday, June 21, 2004

The Ars Nova Theater  
511 West 54th St.

## Colormania

by Stephanie Vamvoukakis, age 10. Directed by Julia Gibson

Blue Man 1 ..... John Conlee  
Pink Girl 1 ..... Frances McDormand

## Walk and Don't Walk's Big Break

by Jason Peterson Ridge, age 10. Directed by Megan Sandberg-Zakian

Walk ..... Chris Ceraso  
Don't Walk ..... Michael Stuhlbarg  
The Boss ..... Adam Robinson

## Two Personalities, One Person

by Nicole Fargardo, age 13. Directed by Maria Goyanes

Rosie ..... Malinda Walford  
Jake ..... Jeff LaGreca  
Outer Ellen ..... Kate Forbes  
Voice of God ..... Maria Goyanes  
Inner Ellen ..... Maile Holck

## The Stealing Changes

by Jennifer Ramirez, age 10. Directed by Julia Gibson

Jason ..... Kenajuan Bentley  
Michael ..... John Conlee  
Wife ..... Frances McDormand

## A Friendship of a Teacher and a Stupidhead

by Isaac Goodman Boyd, age 11. Directed by Megan Sandberg-Zakian

Hilly Billy Bob ..... Michael Stuhlbarg  
Mr. Ogglethorpe ..... Chris Ceraso

## The Interruption

by Aladino Olivares, age 13. Directed by Elizabeth Giamatti

Johnny ..... Robert Jimenez  
Rico ..... George Babiak  
Mikie ..... John Sheehy  
Mom ..... Diana Rojas

## Circus is Pure Evil

by Matthew Ortiz, age 11. Directed by Seret Scott

Clab ..... Abigail Lopez  
Cho ..... Bruce MacVittie  
Rhino ..... Mario Quesada  
Guard 1 ..... Andrew Kessler  
Guard 2 ..... Charise Smith  
Juggler ..... Seret Scott

## AIDS in Texas

by Erica Arce, age 10. Directed by Maria Goyanes

Samantha ..... Kate Forbes  
Mom: ..... Malinda Walford  
Lisa ..... Maile Holck

## Two Mermaids in Love

by Luz Maldonado, age 11. Directed by Seret Scott

Mariel ..... Abigail Lopez  
Fish ..... Mario Quesada  
Bill ..... Bruce MacVittie

## The Woman That Suicided Herself

by Steven Castellanos, age 12. Directed by Julia Gibson

Alan ..... John Conlee  
Rosie ..... Frances McDormand  
News Reporter ..... Andrew Kessler  
Maria ..... Julia Gibson

## Ryan Normal

by Skye Blu Welsh, age 12. Directed by Seret Scott

Ryan ..... Bruce MacVittie  
Mikey ..... Mario Quesada  
Sarah ..... Abigail Lopez

## Growing Up The Wrong Way

by Andrew John Welsh, age 11. Directed by Elizabeth Giamatti

Cesario ..... Robert Jimenez  
Boss ..... George Babiak  
Tony ..... John Sheehy  
Guy/Christopher ..... Charlie Tocantins

## Time is Money

by Harlo Ulloa, age 11. Directed by Megan Sandberg-Zakian

Mat ..... Michael Stuhlbarg  
Dad/Teacher ..... Adam Robinson  
Jim ..... Chris Ceraso

# B R I E F I N T E R M I S S I O N



The 52nd Street Project gratefully acknowledges the support of the following foundations and corporations: American Media; Barker Welfare Foundation; Bloomberg; Capital Research Company; Carnegie Corporation of New York; Citigroup; Consolidated Edison; Comedy Central; The Dramatists Guild Fund; Dramatists Play Service; The Max & Victoria Dreyfus Foundation Inc.; Eleanor, Adam & Mel Dubin Foundation; Entertainment Weekly; The Hennessy Foundation; HBO; Holland Lodge Foundation, Inc.; The Horace W. Goldsmith Foundation; Hurlbut Family Charitable Lead Trust; JKW Foundation; Betty E. & George B. Kaiser Foundation; Lloyds TSB Bank plc; Lucille Lortel Foundation; James A. Macdonald Foundation; Mad.House, Inc.; Ann M. Martin Foundation; Mellon Equity Associated, LLP; The New World Foundation; The New York Times Company Foundation; Newman's Own; Armstrong Nickoll Family Foundation; Noggin; Norcross Wildlife Foundation, Inc.; The Fan Fox & Leslie R. Samuels Foundation; Sesame Workshop; Stranahan Foundation; The Surdna Foundation; Theatre Communications Group, Inc.; The Vervane Foundation; John A. Vassilaros & Son, Inc; Yorke Construction Corporation; Felix Zarembo & Co. Inc. In addition the following individuals made gifts of over \$200 to The 52nd Street Project this year (list is current as of 6/30/04):

Robert Abrams & Cynthia Vance	Janeane Garofalo	Doda Manalansan	Daryl Roth
Cecilia Arana-Grant & Kevin Grant	Rose Gasner & Larry Chertoff	Paul & Lauren Mandell	Martha Roth & Bill Irwin
Adam Leitman Bailey	Alexandra Gersten &	Sonia Manzano &	Steve Sabba
Ben Barenholtz	John Vassilaros	Richard Reagan	Arnold & Agnes Sametz
Jessica Bauman	Cora Cahan & Bernard Gersten	Donald Margulies & Lynn Street	Laura Sametz & Anton Fig
Laurie Becker & Rick Sweren	Nancy Giles	Gene & Mary Ann McCoy	Karin & Tom Schall
Meredith Beeuwkes	Lloyd & Kilty Gilmour	Paul McCrane & Dana Kellin	Maury Schott
Lisa Benavides & Tim Nelson	Judy Goldman & Michael Pillingier	Fran McDormand & Joel Coen	Lauren Seikaly & Michael Huber
Gavin Berger & Craig Berggren	George & Amy Goldstein	Andrew McKeon	Jeffrey Seller & Joshua Lehrer
Alexander & Elizabeth Bernstein	Larry & Carol Goldstein	Rick Meese & Dan Lori	Mitchell Semel & Colleen Carroll
Jeanette & Samuel Black	Stephen & Cathy Graham	Danny Meisner	Aaron & Elaine Shapiro
Tessa Blake	Connie Grappo & Lee Wilkof	Josie Merck & Jim Stevenson	Pam Shaw & Victor Szymis
Buzz Bovshew	Emily Grishman & Susan Sampliner	Brian Mertes	Seth Shepsle
Jon Brielle	Bruce Grossberg & Laura Rovinsky	Audrey & Danny Meyer	Peter Shinoda
Kathy Briggs	Lisa Gugenheim	Judy Minor	Meg Simon
Becky Browder & Ted Neustadt	Alan Halperin & Wendy Halperin	Emily & John Morgan	Landon Slane
Deborah Brown	Jane & Jonathan Heine	Mala & Sham Mosher	Jeff Stafford
Susan Bruce & Peter Hedges	Peter Herdrich & Karen Trott	Walter Mosley	John Steber & Robert Shaffron
Kate Burton & Michael Ritchie	Amy Herzig	Michelle Mulitz & Morty Gudelsky	Jean Stein
Linda & Arthur Carter	William Holtzman &	Suzen Murakoshi & Mark Temme	R.L. Stine & Jane Stine
Constance Casey	S. Sylvia Shepard	Richard Murawczyk	Susanna Styron & Darrell Larson
Alfred C. Cerullo III	Katy Homans & Patterson Sims	& Laura Murawczyk	Daniel Swee
Rachel Chanoff	Sarah Horowitz & David Venarde	Patricia M. Murphy, Esq.	Timothy Thomas
Lieta Hesen-Cohen & Richard Cohn	Sy Jacobs	& Adam Spilka	Adriana & Tim Stephenson
Billy Crudup	Donna & Thomas Jaycox	Frank Napolitano	Laura Valeroso & David Seidman
Tom Cruise	Amanda Johns	Steven Neiditz & Leslie Neiditz	Wendy vanden Heuvel &
Arthur Dantchik	Andrea Johnson	Don & Sara Nelson	Brad Coley
Cathy Dantchik	Kristen Johnston	Randy & Rona Nelson	Susan Vitucci
Leslie Dantchik	Larry & Mary Jones	Clea Newman	Mary Pat Walsh
Peter & Judith Dawkins	Aram Kailian & Eli Pariser	Edward Norton	Brenda Wehle & John C. Lynch
Alex Draper & Lorraine Tobias	Sheryl Kaller	Kevin O'Rourke & Edith Thurber	Randall Weisenburger
Richard & Rebecca Dresser	Cindy Kaplan	Carol Ochs & Bruce MacVittie	Sally & Lenny Weiss
Christopher & Karen Eddowes	Michelle Katz	Jacki Ochs & Jan Kroeze	Ali Marsh
Renee Edelman	James Kern & Deborah Kern	Paul & Maria Onderdonk	Jane Bolster &
David & Chrysti Eigenberg	Steven Klinsky	Sascha Paladino	Steve Wertimer
Ned Eisenberg & Patricia Maguire	Mary Kong	Elizabeth Peters	Jenny Wiener & Jon Steingart
Nora Ephron	Judy Kuhn & David Schwab	Peter & Ana Rosa Phillips	Michael & Zena Wiener
Wendy Ettinger & Derek McLane	Liza Lerner	Susan Ochs Phillips	Donald Windham
Peter Jay Fernandez & Denise Burse	Ilana Levine & Dominic Fumusa	Katharyn Pinder	Frank Wood
Martin Fetner & William Coury	Joshua Lewis & Sarah Kay	Jeremy & Paulette Posner	Joanne Woodward &
Liz Fillo	Anna Li	Peter & Helen Randolph	Paul Newman
David Frankel	Katherine Lumb	Paul Reale & Barbara McCrane	Bill Wrubel & Jennifer Crittenden
Richard Frankel & Kathleen Clark	John Lyons	Willie Reale & Jenny Gersten	Patricia Xenos
Alison Fraser & Nat Magee	Grace Lyu-Volckhausen	Theresa Rebeck & Jess Lynn	Jeffrey & Janine Yass
Frank Frattaroli	Greg MacPherson &	Lise Rehwaldt & Mark Roberts	James & Mary Lin Yoshimura
Louis & Patrice Friedman	Jane Perlmutter	David & Anita Rogerson	Elisa Zuritsky & Jordan Barowitz

The 52nd Street Project presents  
The 2004 Harold and Mimi Steinberg Charitable Trust One-on-Ones

# LOCATION, LOCATION: THE LOCATION PLAYS



JAMES STEVENSON

## DESTINATION: BLOCK ISLAND

July 22-25, 2004

The Ensemble Studio Theatre  
549 West 52nd St.  
NEW YORK CITY

# LOCATION, LOCATION THE LOCATION PLAYS

The 2004 Block Island  
One-on-Ones  
July 22-25  
The Ensemble  
Studio Theatre

## The 52nd Street Project Staff:

Gus Rogerson, Artistic Director  
Carol Ochs, Executive Director  
John Sheehy, Director of Development and Marketing  
Megan Sandberg-Zakian, Associate Artistic Director  
George "X-Acto" Babiak, Production Manager  
Liz Bell, Director of Education  
Diana Rojas, Executive Assistant  
Chris Ceraso, Teen Dean  
Iris A. Brown, Graphic Designer  
Mayleen Cancel, Receptionist  
Interns: Andrew Kelsey, Emily Meisler and Reese Smith

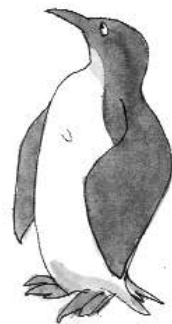

## Production Staff

### Composer:

Kim D. Sherman

### Set Designer:

Kevin Joseph Roach

### Lighting Designer:

Greg MacPherson

### Costume Designer:

Bryan Gmitter

### Goddess of Sound:

Vanessa Valdes

### Stage Manager:

Perry McBain Daniel

### Slide Design Team:

Chris Bonanos, Johann Conforme,  
Lee Kimble, Katherine Lumb,  
Kathleen Maloney, Mike Marshall, Robin  
Marshall, Monty Nicol, John Steward,  
James Stevenson, Alberta Testanero,  
Iwona Waluk

### Prop Design Team:

George Babiak, Stephanie Bast,

Nicole Fargardo, Andrew Kelsey,

Ephraim Lopez and Thom, Sophia Ochs  
MacVittie, John Sheehy, Joaquín Torres,  
Michael Velez

### Flyer/Program Illustrations:

James Stevenson

### Furniture Crew:

Andrew Kelsey and Michael Velez

### Prop Crew:

Nicole Fargardo, Leah Galimidi,  
Emily Meisler, Reese Smith

### Load-in and Light-hang Crew:

Kelly Blackwell, Leah Galimidi,  
Ray Harold, Doug Nervik, Christopher  
Randolph, Joaquín Torres

### House Managers:

Liz Bell, Liz Flahive, Karin Schall

### Chefs:

Pat Ritter and Martha Velie-Gass

### Teen Counselor:

Leah Galimidi

## COOL STUFF ON SALE IN THE LOBBY!

The Fabulous Flyer Bar . . . . . \$2, \$1.50 & \$1  
and featuring Shel Silverstein's "Five and Twoey" logo:

Project T-shirts (NEW Design) . . . . . \$12.00  
Project Tank Tops (NEW Girls' Design) . \$12.00  
Project Caps (NEW design) . . . . . \$15.00  
Project Mugs (now in BLUE!) . . . . . \$5.00  
Project Pencil 3-pack (now in RED!) . . . . \$1.00  
Project Notebook (New Item) . . . . . \$5.00

Thank you for coming to **LOCATION, LOCATION!** If you are not on our mailing list (or if your address has changed), please fill out this form and give it to us on your way out or mail it to the address below. We would also like to know if you are interested in becoming a volunteer. We need help in **all areas**, so be sure to fill out the entire form.

### PLEASE ADD ME TO YOUR MAILING LIST:

7/04

NAME: \_\_\_\_\_

ADDRESS: \_\_\_\_\_

ZIP \_\_\_\_\_

HOME PHONE: \_\_\_\_\_

DAYTIME PHONE: \_\_\_\_\_

E-MAIL ADDRESS: \_\_\_\_\_

MY OCCUPATION: \_\_\_\_\_

MY HOBBIES: \_\_\_\_\_

### YES, I WOULD LIKE TO BE OF HELP. I CAN:

- |   |   |  |
|---|---|--|
| <input type="checkbox"/> Help load in and out for shows | <input type="checkbox"/> Draw and/or paint  | <input type="checkbox"/> Help kids with homework |
| <input type="checkbox"/> Hang lights                    | <input type="checkbox"/> Help with mailings | <input type="checkbox"/> Teach kids a skill      |
| <input type="checkbox"/> Work on a backstage crew       | <input type="checkbox"/> Do office work     | <input type="checkbox"/> Be a chef at an event   |
| <input type="checkbox"/> Do graphic design              | <input type="checkbox"/> Design sound       | <input type="checkbox"/> Design and sew costumes |
| <input type="checkbox"/> Other (please specify) _____   |   |  |

### MY SCHEDULE IS:

- Very flexible. I'm often available during weekdays.  
 Somewhat flexible. I can help on the occasional morning or afternoon during the week.  
 Not very flexible at all, but I've got some free time on evenings and weekends.

If you would like to mail this (and you're always welcome to enclose a tax-deductible contribution), you can send it to: **The 52nd Street Project**, 500 West 52nd St., New York, NY 10019. Or fax it to (212) 333-5598.



The One-on-Ones Program is made possible with public funds from The New York State Council on the Arts, a state agency; and the New York City Department of Cultural Affairs. The 52nd Street Project is supported by funds from the National Endowment for the Arts, the Department of Youth and Community Development. The Project is member of ART/NY and a participant in the New Generations Program, funded by Doris Duke Charitable Foundation/The Andrew W. Mellon Foundation and administered by Theatre Communications Group, the national organization for the American Theater.



## Don't Miss Our Upcoming Shows!

# LOCATION, LOCATION: THE LOCATION PLAYS

VOLUME  
2



DESTINATION:  
WAREHAM

The second outing of the 2004 One-on-Ones August 21-24 right here at E.S.T. Same great theme, but with new kids, new adults, and all-new plays. Come again!

## PLAYBACK

November, 2004

First a kid writes a short play. Then, an adult writes an "answer" play. Then, the two of them perform both plays. Multiply this equation by seven and you've got an entire show.



December, 2004

In September, 10 kids brand-new to the Project will begin a Playmaking class taught by Project Playmaking Director Megan Sandberg-Zakian. Come and see their final plays performed by adult professional actors.

The 52nd Street Project is a non-profit organization that brings children from the Hell's Kitchen neighborhood together with professional theater artists to create original theater. **LOCATION, LOCATION** is a production of our One-on-One program, which is designed to give children the opportunity to go away for one-week stays in the country and enjoy the undivided attention of a professional theater artist who serves as friend, mentor, and collaborator. The Project is delighted to return to the Ensemble Studio Theatre, where we have been performing since our inception in 1981. We gratefully acknowledge the fact that if E.S.T. wasn't here, we'd be nowhere.

### The 52nd Street Project Board of Directors

Ben Barenholtz

Lisa Benavides

Rachel Chanoff

Cathy Dantchik

Noël Dawkins

Wendy Ettinger, *chair emeritus*

Louis P. Friedman

Stephen Graham, *chair*

Larry Jones

James McDaniel

Frances McDormand

Patricia M. Murphy, Esq.

Carol Ochs

Willie Reale, *founder*

Gus Rogerson

Shirley Rumierk, *alumni member*

José Soto, Jr., *alumni member*

Pamala Tyson

Laura Valeroso

Wendy vanden Heuvel

John A. Vassilaros

Jenny Wiener

### Special Thanks

Our Host Families – Josie Merck & Jim Stevenson; Alan & Roberta Alpert; Jennifer & Elliot Taubman; Sue Black; Jane Muskey & Tony Goldwyn; Ron, Judy & Kevin Tierney; Joya Verde & Virginia Dare; Thomas Frye and our headquarters host Dr. Christina Biaggi. Sincere thanks also go to Lynn Reale, Kate & Harold at Block Island Realty; Rita & Steve Draper; Glenn & Annie Hall; McQuade's Market; Interstate Navigation; Bruce & Sophia Ochs MacVittie; Jenny Ritter; Amanda Gass; Kirk Littlefield; Joe & Pat at Smuggler's Cove Sailing School; Finns Fish Market; Ed McGovern; Ed Berube; the Block Island Grocery; Cindy & Stan Greer at The Depot; Bill Bendokis at New England Airlines; Gary Pollard at The Empire Theater; Robin Morse, Lucy & Francis Rogerson; Wendy vanden Heuvel and Lila Blue Coley; and our amazing chefs Pat Ritter & Martha Velie-Gass

### In-Kind Contributions

Curt, John, Mary, Carl, Tim, and everyone at the Ensemble Studio Theatre; the Murphy Law Office; Benefit Cosmetics; Iris A. Brown; Bourjois Paris; Bumble and bumble; Ron Kastner and Capital Printing; Kenneth Cole Productions; Noggin; The Printing Store; Scholastic, Inc.; Diageo Chateau & Estate Wines; Entertainment Weekly; Lucky Magazine; Microtouch/Finishing Touch; Molten Brown; MOP Cosmetics; Newman's Own; Pharma Print/Omni Graphics; Sesame Workshop; Wendy Stuhlberg; Terax America; John A. Vassilaros; Watkins, Inc.; Mayor's Office of Film & Television; Boylan's Bottling Co.; David Sneddon & Fairway Market; Lorraine Tobias & Imaginary Studios; Jive Records, part of Zomba Music Group; and Prime Films.

## LOCATION, LOCATION - ACT 1

All original music composed by Kim D. Sherman  
"Location, Location Theme Song" lyrics by John Sheehy

### THE GOOD SOLDIER

Written & Directed by Stephen Barker Turner for Angel Silva, age 10

Jace .....Angel Silva  
Sergeant Strongheart .....Stephen Barker Turner  
Girl .....Leah Galimidi

"The Ready Song," "The Rightness Song," "The Love Song," "The Why Song,"  
"The Surprise Song" lyrics by Stephen Barker Turner

### UNDERGROUND

Written & Directed by Nina Daniels for Muhammad Cunningham, age 10

Lady .....Nina Daniels  
Rat .....Muhammad Cunningham  
Bystanders .....Andrew Kelsey & Leah Galimidi

"Smooth Rat" lyrics by Nina Daniels & John Sheehy

### CITY STORY

Written & Directed by Erica Schmidt for Jennifer Ramirez, age 10

Shelby Lauren .....Erica Schmidt  
Crystal James .....Jennifer Ramirez

"What's Your Name" lyrics by Erica Schmidt

### ON LOCATION

Written by James Stevenson & Directed by Joaquín Torres  
for Pablo Maldonado, age 10

Larry Morris .....Joaquín Torres  
Boris Grossoff .....Pablo Maldonado

"Boris Is Back" lyrics by James Stevenson

### FOWL PLAY

Written & Directed by Eris Migliorini for Stephanie Vamvoukakis, age 10

Birdra Bokoran .....Eris Migliorini  
Myrtle McCluck .....Stephanie Vamvoukakis  
Capon Wattle .....Gus Rogerson  
Marty .....George Babiak

"Look in the Mirror" lyrics by Eris Migliorini

## LOCATION, LOCATION - ACT 2

### ARMANDO

Written by Willie Reale & Directed by Diana Rojas for Kayelani Silva, age 13

Rosalinda .....Diana Rojas  
Pina .....Kayelani Silva  
Armando .....Andrew Kelsey

"Armando" and "Nobody Here But Us" lyrics by Willie Reale

### HOW MASTER LY GOT HIS GROOVE BACK

Written & Directed by Kate Marks for George Zapata, age 10

Master Ly .....George Zapata  
Little Z .....Kate Marks

"The Monk's Lament" lyrics by Kate Marks

### THE ADVENTURES OF CAPTAIN FUNK AND DR. KNOCKOUT

Written & Directed by Ross M. Berger for Jonathan Rosario, age 11

Captain Funk .....Ross M. Berger  
Dr. Knockout .....Jonathan Rosario  
Negativity Man .....George Babiak  
Narrator .....Gus Rogerson

"Generic Theme Song aka Schmaggegy" lyrics by Ross M. Berger & John Sheehy

### THE AMAZING DR. JUNGLE

Written by Daniel Goldfarb & Directed by Becky White  
for Arielle Velasquez, age 12

Dr. Jungle .....Arielle Velasquez  
Serena .....Becky White

"Itchy's Song" lyrics by Daniel Goldfarb

### FOOLS RUSSIAN

Written & Directed by John Sheehy for Jason Peterson Ridge, age 11

Sergei .....John Sheehy  
Alexei .....Jason Ridge  
Ringmaster .....Andrew Kelsey

"I Can't Hold On" lyrics by John Sheehy

☞ **Intermission!** ☞



The 52nd Street Project gratefully acknowledges the support of the following foundations and corporations: American Media; Barker Welfare Foundation; Bloomberg; Capital Research Company; Carnegie Corporation of New York; CBS, Citigroup; Consolidated Edison; Comedy Central; The Dramatists Guild Fund; Dramatists Play Service; The Max & Victoria Dreyfus Foundation Inc.; Eleanor, Adam & Mel Dubin Foundation; Entertainment Weekly; The Henlopen Foundation, The Hennessy Foundation; HBO; Holland Lodge Foundation, Inc.; The Horace W. Goldsmith Foundation; Hurlbut Family Charitable Lead Trust; JKW Foundation; Betty E. & George B. Kaiser Foundation; Lloyds TSB Bank plc; Lucille Lortel Foundation; James A. Macdonald Foundation; Mad House, Inc.; Ann M. Martin Foundation; Mellon Equity Associated, LLP; The New World Foundation; The New York Times Company Foundation; Newman's Own; Armstrong Nickoll Family Foundation; Noggin; Norcross Wildlife Foundation, Inc.; The Fan Fox & Leslie R. Samuels Foundation; Sesame Workshop; Stranahan Foundation; The Surdna Foundation; Theatre Communications Group, Inc.; The Vervane Foundation; John A. Vassilaros & Son, Inc; Yorke Construction Corporation; Felix Zaremba & Co. Inc. In addition the following individuals made gifts of over \$200 to The 52nd Street Project this year (list is current as of 6/30/04):

Robert Abrams & Cynthia Vance	Janeane Garofalo	Doda Manalansan	Daryl Roth
Cecilia Arana-Grant & Kevin Grant	Rose Gasner & Larry Chertoff	Paul & Lauren Mandell	Martha Roth & Bill Irwin
Adam Leitman Bailey	Alexandra Gersten &	Sonia Manzano &	Steve Sabba
Ben Barenholtz	John Vassilaros	Richard Reagan	Arnold & Agnes Sametz
Jessica Bauman	Cora Cahan & Bernard Gersten	Donald Margulies & Lynn Street	Laura Sametz & Anton Fig
Laurie Becker & Rick Sweren	Nancy Giles	Gene & Mary Ann McCoy	Karin & Tom Schall
Meredith Beeuwkes	Lloyd & Kilty Gilmour	Paul McCrane & Dana Kellin	Maury Schott
Lisa Benavides & Tim Nelson	Judy Goldman & Michael Pillinger	Fran McDormand & Joel Coen	Lauren Seikaly & Michael Huber
Gavin Berger & Craig Berggren	George & Amy Goldstein	Andrew McKeon	Jeffrey Seller & Joshua Lehrer
Alexander & Elizabeth Bernstein	Larry & Carol Goldstein	Rick Meese & Dan Lori	Mitchell Semel & Colleen Carroll
Jeanette & Samuel Black	Stephen & Cathy Graham	Danny Meisner	Aaron & Elaine Shapiro
Tessa Blake	Connie Grappo & Lee Wilkof	Josie Merck & Jim Stevenson	Pam Shaw & Victor Szymis
Buzz Bovshov	Emily Grishman & Susan Sampliner	Brian Mertes	Seth Shepsola
Jon Brielle	Bruce Grossberg & Laura Rovinsky	Audrey & Danny Meyer	Peter Shinoda
Kathy Briggs	Lisa Gugenheim	Judy Minor	Meg Simon
Becky Browder & Ted Neustadt	Alan Halperin & Wendy Halperin	Emily & John Morgan	Landon Slane
Deborah Brown	Jane & Jonathan Heine	Mala & Sham Mosher	Jeff Stafford
Susan Bruce & Peter Hedges	Peter Herdrich & Karen Trott	Walter Mosley	John Steber & Robert Shaffron
Kate Burton & Michael Ritchie	Amy Herzig	Michelle Multiz & Morty Gudelsky	Jean Stein
Linda & Arthur Carter	William Holtzman &	Suzen Murakoshi & Mark Temme	R.L. Stine & Jane Stine
Constance Casey	S. Sylvia Shepard	Richard Murawczyk	Susanna Styron & Darrell Larson
Alfred C. Cerullo III	Katy Homans & Patterson Sims	& Laura Murawczyk	Daniel Swee
Rachel Chanoff	Sarah Horowitz & David Venarde	Patricia M. Murphy, Esq.	Timothy Thomas
Lieta Hesen-Cohen & Richard Cohn	Sy Jacobs	& Adam Spilka	Adriana & Tim Stephenson
Billy Crudup	Donna & Thomas Jaycox	Frank Napolitano	Laura Valeroso & David Seidman
Tom Cruise	Amanda Johns	Steven Neiditz & Leslie Neiditz	Wendy vanden Heuvel &
Arthur Dantchik	Andrea Johnson	Don & Sara Nelson	Brad Coley
Cathy Dantchik	Kristen Johnston	Randy & Rona Nelson	Susan Vitucci
Leslie Dantchik	Larry & Mary Jones	Clea Newman	Mary Pat Walsh
Peter & Judith Dawkins	Aram Kailian & Eli Pariser	Edward Norton	Brenda Wehle & John C. Lynch
Alex Draper & Lorraine Tobias	Sheryl Kaller	Kevin O'Rourke & Edith Thurber	Randall Weisenburger
Richard & Rebecca Dresser	Cindy Kaplan	Carol Ochs & Bruce MacVittie	Sally & Lenny Weiss
Christopher & Karen Eddowes	Michelle Katz	Jacki Ochs & Jan Kroeze	Ali Marsh
Renee Edelman	James Kern & Deborah Kern	Paul & Maria Onderdonk	Jane Bolster &
David & Chrysti Eigenberg	Steven Klinsky	Sascha Paladino	Steve Wertimer
Ned Eisenberg & Patricia Maguire	Mary Kong	Elizabeth Peters	Jenny Wiener & Jon Steingart
Nora Ephron	Judy Kuhn & David Schwab	Peter & Ana Rosa Phillips	Michael & Zena Wiener
Wendy Ettinger & Derek McLane	Liza Lerner	Susan Ochs Phillips	Donald Windham
Peter Jay Fernandez & Denise Burse	Ilana Levine & Dominic Fumusa	Katharyn Pinder	Frank Wood
Martin Fetner & William Coury	Joshua Lewis & Sarah Kay	Jeremy & Paulette Posner	Joanne Woodward &
Liz Fillo	Anna Li	Peter & Helen Randolph	Paul Newman
David Frankel	Katherine Lumb	Paul Reale & Barbara McCrane	Bill Wrubel & Jennifer Crittenden
Richard Frankel & Kathleen Clark	John Lyons	Willie Reale & Jenny Gersten	Patricia Xenos
Alison Fraser & Nat Magee	Grace Lyu-Volckhausen	Theresa Rebeck & Jess Lynn	Jeffrey & Janine Yass
Frank Frattaroli	Greg MacPherson &	Lise Rehwaldt & Mark Roberts	James & Mary Lin Yoshimura
Louis & Patrice Friedman	Jane Perlmutter	David & Anita Rogerson	Elisa Zuritsky & Jordan Barowitz

The 52nd Street Project presents  
The 2004 Wiener Family Foundation One-on-Ones

# LOCATION, LOCATION: THE LOCATION PLAYS

Vol.  
2



JAMES STEVENSON

## DESTINATION: WAREHAM, MASS.

August 20-22, 2004

The Ensemble Studio Theatre  
549 West 52nd St.  
NEW YORK CITY



# LOCATION, LOCATION THE LOCATION PLAYS

The 2004 Wareham, MA  
One-on-Ones  
August 20-22  
The Ensemble  
Studio Theatre

## The 52nd Street Project Staff:

Gus Rogerson, Artistic Director  
Carol Ochs, Executive Director  
John Sheehy, Director of Development and Marketing  
Megan Sandberg-Zakian, Associate Artistic Director  
George "X-Acto" Babiak, Production Manager  
Liz Bell, Director of Education  
Diana Rojas, Executive Assistant  
Chris Ceraso, Teen Dean  
Iris A. Brown, Graphic Designer  
Mayleen Cancel, Receptionist  
Interns: Andrew Kelsey, Emily Meisler and Reese Smith

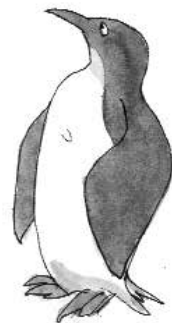

## Production Staff

**Composer:** Patrick Barnes  
**Set Designer:** Kevin Joseph Roach  
**Lighting Designer:** Greg MacPherson  
**Costume Designer:** K. O'Reilly  
**Sound Designer:** Andrew Kelsey  
**Stage Manager:** Karen Munkel  
**Slide Design Team:**

Chris Bonanos, Johann Conforme,  
Lee Kimble, Katherine Lumb,  
Kathleen Maloney, Mike Marshall, Robin  
Marshall, Monty Nicol, Mike Sell, John  
Steward, Alberta Testanero, Iwona Waluk

## Prop Design Team:

Hera Andre-Bergmann, George Babiak,  
Liz Bell, Kelly Blackwell, Noel Kvasnosky,  
Luz Maldonado, Emily Meisler, Karen  
Munkel, Megan Sandberg-Zakian, John  
Sheehy, Reese Smith

**Location Illustration:** Jim Stevenson  
**Furniture Crew:**

Luis Anthony Maldonado and  
Christopher Ramirez

## Prop Crew:

Emily Meisler, Reese Smith, and  
Anthony Mejia

## Load-in and Light-hang Crew:

Andrew Kelsey, Emily Meisler,  
Reese Smith, Luis Anthony  
Maldonado and the staff

## House Managers:

Liz Bell, Liz Flahive, Mary Pat Walsh

## Chefs:

Christopher Randolph, Liz Bell,  
John Sheehy, Carol Ochs

## Teen Counselor:

Luis Anthony Maldonado

The One-on-Ones Program is made possible with public funds from The New York State Council on the Arts, a state agency; and the New York City Department of Cultural Affairs. The 52nd Street Project is supported by funds from the National Endowment for the Arts, the Department of Youth and Community Development. The Project is member of ART/NY and a participant in the New Generations Program, funded by Doris Duke Charitable Foundation/The Andrew W. Mellon Foundation and administered by Theatre Communications Group, the national organization for the American Theater.



## COOL STUFF ON SALE IN THE LOBBY!

The Fabulous Flyer Bar . . . . . \$2, \$1.50 & \$1  
and featuring Shel Silverstein's "Five and Twoey" logo:  
Project T-shirts (NEW Design) . . . . . \$12.00  
Project Tank Tops (NEW Girls' Design) . \$12.00  
Project Caps (NEW design) . . . . . \$15.00  
Project Mugs (now in BLUE!) . . . . . \$5.00  
Project Pencil 3-pack (now in RED!) . . . . \$1.00  
Project Notebook (New Item) . . . . . \$5.00

Thank you for coming to **LOCATION, LOCATION!** If you are not on our mailing list (or if your address has changed), please fill out this form and give it to us on your way out or mail it to the address below. We would also like to know if you are interested in becoming a volunteer. We need help in **all areas**, so be sure to fill out the entire form.

### PLEASE ADD ME TO YOUR MAILING LIST:

8/04

NAME: \_\_\_\_\_

ADDRESS: \_\_\_\_\_

ZIP \_\_\_\_\_

HOME PHONE: \_\_\_\_\_

DAYTIME PHONE: \_\_\_\_\_

E-MAIL ADDRESS: \_\_\_\_\_

MY OCCUPATION: \_\_\_\_\_

MY HOBBIES: \_\_\_\_\_

### YES, I WOULD LIKE TO BE OF HELP. I CAN:

- |   |   |  |
|---|---|--|
| <input type="checkbox"/> Help load in and out for shows | <input type="checkbox"/> Draw and/or paint  | <input type="checkbox"/> Help kids with homework |
| <input type="checkbox"/> Hang lights                    | <input type="checkbox"/> Help with mailings | <input type="checkbox"/> Teach kids a skill      |
| <input type="checkbox"/> Work on a backstage crew       | <input type="checkbox"/> Do office work     | <input type="checkbox"/> Be a chef at an event   |
| <input type="checkbox"/> Do graphic design              | <input type="checkbox"/> Design sound       | <input type="checkbox"/> Design and sew costumes |
| <input type="checkbox"/> Other (please specify) _____   |   |  |

### MY SCHEDULE IS:

- Very flexible. I'm often available during weekdays.  
 Somewhat flexible. I can help on the occasional morning or afternoon during the week.  
 Not very flexible at all, but I've got some free time on evenings and weekends.

If you would like to mail this (and you're always welcome to enclose a tax-deductible contribution), you can send it to: **The 52nd Street Project**, 500 West 52nd St., New York, NY 10019. Or fax it to (212) 333-5598.

## Don't Miss Our Upcoming Shows!

# PLAYBACK

## nothing up my sleeve: *The Deceptive Plays*

October, 2004

First a kid writes a short play. Then, an adult writes an "answer" play. Then, the two of them perform both plays. Multiply this equation by seven and you've got an entire show.



## MORPH FOR THE MONEY: *Plays with Change*

December, 2004

In September, 10 kids brand-new to the Project will begin a Playmaking class taught by Project Playmaking Director Megan Sandberg-Zakian. Come and see their final plays performed by adult professional actors.

The 52nd Street Project is a non-profit organization that brings children from the Hell's Kitchen neighborhood together with professional theater artists to create original theater. **LOCATION, LOCATION** is a production of our One-on-One program, which is designed to give children the opportunity to go away for one-week stays in the country and enjoy the undivided attention of a professional theater artist who serves as friend, mentor, and collaborator. The Project is delighted to return to the Ensemble Studio Theatre, where we have been performing since our inception in 1981. We gratefully acknowledge the fact that if E.S.T. wasn't here, we'd be nowhere.

### The 52nd Street Project Board of Directors

Ben Barenholtz

Lisa Benavides

Rachel Chanoff

Cathy Dantchik

Noël Dawkins

Wendy Ettinger, *chair emeritus*

Louis P. Friedman

Stephen Graham, *chair*

Larry Jones

James McDaniel

Frances McDormand

Patricia M. Murphy, Esq.

Carol Ochs

Willie Reale, *founder*

Gus Rogerson

Shirley Rumierk, *alumni member*

José Soto, Jr., *alumni member*

Pamala Tyson

Laura Valeroso

Wendy vanden Heuvel

John A. Vassilaros

Jenny Wiener

### Special Thanks

Our Host Families – Emily & John Morgan; Larry Stifler & Mary McFadden; Patty & David Strauss; Sidney Worthen & David Pearce; Beth McNay; Joe McNay; Marina & Bob Whitman; our swimming hosts – Anne & Colin McNay; Alice & Ron Curtin; and our headquarters host – Peter, Helen & Christopher Randolph.

Sincere thanks to our super chef Christopher Randolph; Vanessa Valdes; Kurt Wootton; Robin Morse & Lucy & Francis Rogerson; Sophia Ochs MacVittie; Bob Krystofolski

### In-Kind Contributions

Curt, John, Mary, Carl, Tim, and everyone at the Ensemble Studio Theatre; the Murphy Law Office; Benefit Cosmetics; Iris A. Brown; Bourjois Paris; Bumble and bumble; Ron Kastner and Capital Printing; Kenneth Cole Productions; Noggin; The Printing Store; Scholastic, Inc.; Diageo Chateau & Estate Wines; Entertainment Weekly; Lucky Magazine; Microtouch/Finishing Touch; Molten Brown; MOP Cosmetics; Newman's Own; Pharma Print/Omni Graphics; Sesame Workshop; Wendy Stuhlberg; Terax America; John A. Vassilaros; Watkins, Inc.; Mayor's Office of Film & Television; Boylan's Bottling Co.; David Sneddon & Fairway Market; Lorraine Tobias & Imaginary Studios; Jive Records, part of Zomba Music Group; and Prime Films.

## LOCATION, LOCATION - ACT 1

All original music composed by Patrick Barnes  
"Location, Location (Vol. 2) Theme Song" lyrics by John Sheehy

### MALL GIRL RETURNS

Written by Jackie Reingold & Directed by Shirley A. Rumierk  
for Katherine Alvarez, age 13.

Mall Girl .....Katherine Alvarez  
Tacky Girl .....Shirley A. Rumierk

"She's Mall Girl" & "A Tragic Tale" lyrics by Jackie Reingold

### BEAN THE BOZO

Written & Directed by George Babiak for Hera Andre-Bergmann, age 10

Corky O'Rourke .....Hera Andre-Bergmann  
Griff Thomas .....George Babiak  
Vinnie .....Luis Anthony Maldonado  
Peachface .....Reese Smith

"Platitude Adjustment" lyrics by George Babiak

### THE TEXAS CHAINSAW MATCH OCCURRED

Written & Directed by Bruce MacVittie for Aladino Olivares, age 13

Lewis .....Aladino Olivares  
Clovis .....Bruce MacVittie  
Chainsaw and various victims .....Anthony Mejia, Reese Smith,  
Christopher Ramirez, Luis Anthony Maldonado

"Someone Like You" lyrics by Bruce MacVittie

### METER? I HARDLY KNOW HER

Written by Megan Sandberg-Zakian & Directed by Jennifer Ostrega  
for Luz Maldonado, age 11

Madge Wright .....Luz Maldonado  
Raquel Pasquetti .....Jennifer Ostrega  
Parking Commissioner Pasquetti .....John Sheehy  
Vinnie .....Luis Anthony Maldonado

"You Gotta Keep Time" lyrics by Megan Sandberg-Zakian

### A TAD EXCELLENT ADVENTURE

Written & Directed by Reg Flowers for Bryant Acosta, age 11

Tad Excellent .....Bryant Acosta  
Mr. V .....Reg Flowers  
Slug .....Luis Anthony Maldonado

"I'm Gonna Bring You Down" lyrics by Reg Flowers

## LOCATION, LOCATION - ACT 2

### FAKE IT LIKE YOU MEAN IT

Written by Liza Steinberg & Directed by Megan Cramer  
for Merlaine Mendez, age 12

Jessica Z .....Merlaine Mendez  
Daphne Star .....Megan Cramer  
Announcer .....Reese Smith

"In My Own Words" lyrics by Liza Steinberg

### CHUNK-A-CHANGE GUARANTEED

Written & Directed by Ed Vassallo for Chassity Damiani, age 12

Miss Metamorph .....Chassity Damiani  
Larry .....Ed Vassallo  
Man .....Anthony Mejia  
Peachface .....Reese Smith

"Don't Wanna Be A Dog" lyrics by Ed Vassallo

### THE WILL

Written by Michael Bernard & Directed by Drew Cortese  
for Junior Chatman, age 12

Trevor .....Junior Chatman  
Ernest Terwilliger/Uncle Theopolis .....Drew Cortese  
Wolfgang O'Smellowitz .....Christopher Ramirez

"Not Scared" lyrics by Michael Bernard

### FOR WHOM THE BELLHOP TOILS

Written by Liz Tuccillo & Directed by Zabryna Guevara for Carla Olivia, age 11

Betty the Bellhop .....Carla Olivia  
Veronica Johnstone a.k.a. Sally Smith .....Zabryna Guevara  
Cow .....Luis Anthony Maldonado  
Hog .....Christopher Ramirez  
Duck .....Emily Meisler  
Chicken .....Reese Smith  
Sheep .....Anthony Mejia

"The Bellhop Hop" & "The Special Treatment" lyrics by Liz Tuccillo

### TROUBADOUR TO DOOR

Written by Liz Flahive & Directed by Susan McGinnis  
for Andrew John Welsh, age 11

Max .....Andrew John Welsh  
Laurabelle .....Susan McGinnis  
Bobby the Cruise Director .....John Sheehy

"We'll Get There," "Max's Ultimatum," and "While I Was Out" & lyrics by Liz  
Flahive

 **Intermission!** 

The 52nd Street Project gratefully acknowledges the support of the following foundations and corporations: American Media; Barker Welfare Foundation; Bloomberg; Capital Research Company; Carnegie Corporation of New York; CBS; Citigroup; Consolidated Edison; Comedy Central; The Dramatists Guild Fund; Dramatists Play Service; The Max & Victoria Dreyfus Foundation Inc.; Eleanor, Adam & Mel Dubin Foundation; Entertainment Weekly; The Henlopen Foundation; The Hennessy Foundation; HBO; Holland Lodge Foundation, Inc.; The Horace W. Goldsmith Foundation; Hurlbut Family Charitable Lead Trust; JKW Foundation; Betty E. & George B. Kaiser Foundation; Lloyds TSB Bank plc; Lucille Lortel Foundation; James A. Macdonald Foundation; Mad.House, Inc.; Ann M. Martin Foundation; Mellon Equity Associated, LLP; The New World Foundation; The New York Times Company Foundation; Newman's Own; Armstrong Nickoll Family Foundation; Noggin; Norcross Wildlife Foundation, Inc.; The Fox & Leslie R. Samuels Foundation; Sesame Workshop; Stranahan Foundation; The Surdna Foundation; Theatre Communications Group, Inc.; The Vervane Foundation; John A. Vassilaros & Son, Inc; Yorke Construction Corporation; Felix Zarembo & Co. Inc. In addition the following individuals made gifts of over \$200 to The 52nd Street Project this year (list is current as of 6/30/04):

Robert Abrams & Cynthia Vance	Louis & Patrice Friedman	Jane Perlmutter	David & Anita Rogerson
Cecilia Arana-Grant & Kevin Grant	Janeane Garofalo	Doda Manalansan	Daryl Roth
Adam Leitman Bailey	Rose Gasner & Larry Chertoff	Paul & Lauren Mandell	Martha Roth & Bill Irwin
Ben Barenholtz	Alexandra Gersten &	Sonia Manzano &	Steve Sabba
Jessica Bauman	John Vassilaros	Richard Reagan	Arnold & Agnes Sametz
Laurie Becker & Rick Sweren	Cora Cahan & Bernard Gersten	Donald Margulies & Lynn Street	Laura Sametz & Anton Fig
Meredith Beeuwkes	Nancy Giles	Gene & Mary Ann McCoy	Karin & Tom Schall
Lisa Benavides & Tim Nelson	Lloyd & Kitty Gilmour	Paul McCrane & Dana Kellin	Maury Schott
Gavin Berger & Craig Berggren	Judy Goldman & Michael Pillingier	Fran McDormand & Joel Coen	Lauren Seikaly & Michael Huber
Alexander & Elizabeth Bernstein	George & Amy Goldstein	Andrew McKeon	Jeffrey Seller & Joshua Lehrer
Jeanette & Samuel Black	Larry & Carol Goldstein	Rick Meese & Dan Lori	Mitchell Semel & Colleen Carroll
Lewis Black	Stephen & Cathy Graham	Danny Meisner	Aaron & Elaine Shapiro
Tessa Blake	Connie Grappo & Lee Wilkof	Josie Merck & Jim Stevenson	Pam Shaw & Victor Syrmis
Buzz Bovshow	Emily Grishman & Susan Sampliner	Brian Mertes	Seth Shepsle
Jon Brielle	Bruce Grossberg & Laura Rovinsky	Audrey & Danny Meyer	Peter Shinoda
Kathy Briggs	Lisa Gugenheim	Judy Minor	Meg Simon
Becky Browder & Ted Neustadt	Alan Halperin & Wendy Halperin	Emily & John Morgan	Landon Slane
Deborah Brown	Jane & Jonathan Heine	Mala & Sham Mosher	Jeff Stafford
Susan Bruce & Peter Hedges	Peter Herdrich & Karen Trott	Walter Mosley	John Steber & Robert Shaffron
Kate Burton & Michael Ritchie	Amy Hertzig	Michelle Mulitz & Morty Gudelsky	Jean Stein
Linda & Arthur Carter	William Holtzman &	Suzen Murakoshi & Mark Temme	R.L. Stine & Jane Stine
Constance Casey	S. Sylvia Shepard	Richard Murawczyk	Susanna Styron & Darrell Larson
Alfred C. Cerullo III	Katy Homans & Patterson Sims	& Laura Murawczyk	Daniel Sweet
Rachel Chanoff	Sarah Horowitz & David Venarde	Patricia M. Murphy, Esq.	Timothy Thomas
Lieta Hesen-Cohen & Richard Cohn	Sy Jacobs	& Adam Spilka	Adriana & Tim Stephenson
Billy Crudup	Donna & Thomas Jaycox	Frank Napolitano	Laura Valeroso & David Seidman
Tom Cruise	Amanda Johns	Steven Neiditz & Leslie Neiditz	Wendy vanden Heuvel &
Arthur Dantchik	Andrea Johnson	Don & Sara Nelson	Brad Coley
Cathy Dantchik	Kristen Johnston	Randy & Rona Nelson	Susan Vitucci
Leslie Dantchik	Larry & Mary Jones	Clea Newman	Mary Pat Walsh
Peter & Judith Dawkins	Aram Kailian & Eli Pariser	Edward Norton	Brenda Wehle & John C. Lynch
Alex Draper & Lorraine Tobias	Sheryl Kaller	Kevin O'Rourke & Edith Thurber	Randall Weisenburger
Richard & Rebecca Dresser	Cindy Kaplan	Carol Ochs & Bruce MacVittie	Sally & Lenny Weiss
Christopher & Karen Eddowes	Michelle Katz	Jacki Ochs & Jan Kroeze	Ali Marsh
Renee Edelman	James Kern & Deborah Kern	Paul & Maria Onderdonk	Jane Bolster & Steve Wertimer
David & Chrysti Eigenberg	Steven Klinsky	Sascha Paladino	Jenny Wiener & Jon Steingart
Ned Eisenberg & Patricia Maguire	Mary Kong	Elizabeth Peters	Michael & Zena Wiener
Nora Ephron	Judy Kuhn & David Schwab	Peter & Ana Rosa Phillips	Donald Windham
Wendy Ettinger & Derek McLane	Liza Lerner	Susan Ochs Phillips	Frank Wood
Peter Jay Fernandez & Denise Burse	Ilana Levine & Dominic Fumusa	Katharyn Pinder	Joanne Woodward &
Martin Fetner & William Coury	Joshua Lewis & Sarah Kay	Jeremy & Paulette Posner	Paul Newman
Liz Fillo	Anna Li	Peter & Helen Randolph	Bill Wrubel & Jennifer Crittenden
David Frankel	Katherine Lumb	Paul Reale & Barbara McCrane	Patricia Xenos
Richard Frankel & Kathleen Clark	John Lyons	Willie Reale & Jenny Gersten	Jeffrey & Janine Yass
Alison Fraser & Nat Magee	Grace Lyu-Volckhausen	Theresa Rebeck & Jess Lynn	James & Mary Lin Yoshimura
Frank Fratrotoli	Greg MacPherson &	Lise Rehwaldt & Mark Roberts	Elisa Zuritsky & Jordan Barowitz

The 52nd Street Project presents the  
Fall 2004 Playback Show

# Nothing Up My Sleeve: *The Deceptive Plays*

**THE  
AXIS THEATRE  
AT AXIS COMPANY**

*1 Sheridan Square,  
New York, NY*



*Fri., Oct. 22  
at 7:30 p.m.  
Sat., Oct. 23  
at 3:00 p.m.  
and 7:30 p.m.  
Sun., Oct. 24  
at 3:00 p.m.*

# Nothing Up My Sleeve:

*The Deceptive Plays*

THE FALL 2004  
PLAYBACK SHOW  
OCT. 22-24  
AT THE AXIS THEATRE

### The 52nd Street Project Staff:

Gus Rogerson, Artistic Director  
Carol Ochs, Executive Director  
John Sheehy, Director of Development and Marketing  
Megan Sandberg-Zakian, Associate Artistic Director  
George "X-Acto" Babiak, Production Manager  
Liz Bell, Director of Education  
Diana Rojas, Executive Assistant  
Mayleen Cancel, Education Assistant  
Chris Ceraso, Teen Dean  
Iris A. Brown, Graphic Designer  
Solangee Acosta and Amelia Whitney, Receptionists  
Intern: Mara Grunbaum



### Production Staff:

**Composer:** Loren Toolajian  
**Vocal Coach:** Kari Riely  
**Set Designer:** Kevin Joseph Roach  
**Lighting Designer:** Greg MacPherson  
**Costume Designer:** Naomi Wolff  
**Sound Designer:** Maury Schott  
**Stage Manager:** Katie Ahern  
**"Sleeve" Illustration:** Stephanie Bast  
**Prop Design Team:** George Babiak, Heather Carnduff, Galya Diment, Mara Grunbaum, Karen Munkel, Lee Rosen, Amy Schiff, John Sheehy, Rachel Stephens

### Furniture Crew:

Kayelani Silva and Sarah Petersiel

### Prop Crew:

Jennifer Ramirez and Mara Grunbaum

### Load-in and Light Hang Crew:

Lee Briggs, Melissa Jones, Christopher Randolph, Maury Schott, Rachel Stephens, Tim Thomas, Charlie Tocantins

### House Managers:

Karin Schall, Liz Bell, Mary Pat Walsh

### Chef:

The Incredible Liz Bell

The Playback Program is made possible with public funds from The New York State Council on the Arts, a state agency; and the New York City Department of Cultural Affairs. The 52nd Street Project is supported by funds from the National Endowment for the Arts and the Department of Youth and Community Development. The Project is member of ART/NY and a participant in the New Generations Program, funded by Doris Duke Charitable Foundation/The Andrew W. Mellon Foundation and administered by Theatre Communications Group, the national organization for the American Theater.



## COOL STUFF ON SALE!

Flyer Bars .....\$2.00, \$1.50 & \$1.00

*Shel Silverstein's "Fivey and Twoey" logo gear:*

Project Sweatshirts .....\$20.00  
Project Long Sleeve T-Shirts .....\$15.00  
Project Short Sleeve T-Shirts .....\$12.00  
Project Caps .....\$15.00  
Project Mugs .....\$5.00  
Project Spiral Notebooks (NEW!) .....\$5.00  
Project Pencil 3-pack .....\$1.00

Thank you for coming to **NOTHING UP MY SLEEVE**. If you are not on our mailing list (or if your address has changed), please fill out this form and give it to us on your way out or mail it to the address below. We would also like to know if you are interested in becoming a volunteer. We need help in **all areas**, so be sure to fill out the entire form.

### PLEASE ADD ME TO YOUR MAILING LIST:

OCT 2004

NAME: \_\_\_\_\_

ADDRESS: \_\_\_\_\_

\_\_\_\_\_ ZIP \_\_\_\_\_

HOME PHONE: \_\_\_\_\_

DAYTIME PHONE: \_\_\_\_\_

E-MAIL ADDRESS: \_\_\_\_\_

MY OCCUPATION: \_\_\_\_\_

MY HOBBIES: \_\_\_\_\_

### YES, I WOULD LIKE TO BE OF HELP. I CAN:

- |   |   |  |
|---|---|--|
| <input type="checkbox"/> Help load in and out for shows | <input type="checkbox"/> Draw and/or paint  | <input type="checkbox"/> Help kids with homework |
| <input type="checkbox"/> Hang lights                    | <input type="checkbox"/> Help with mailings | <input type="checkbox"/> Teach kids a skill      |
| <input type="checkbox"/> Work on a backstage crew       | <input type="checkbox"/> Do office work     | <input type="checkbox"/> Be a chef at an event   |
| <input type="checkbox"/> Do graphic design              | <input type="checkbox"/> Design sound       | <input type="checkbox"/> Design and sew costumes |
| <input type="checkbox"/> Other (please specify) _____   |   |  |

### MY SCHEDULE IS:

- Very flexible. I'm often available during weekdays.  
 Somewhat flexible. I can help on the occasional morning or afternoon during the week.  
 Not very flexible at all, but I've got some free time on evenings and weekends.

If you would like to mail this (and you're always welcome to enclose a tax-deductible contribution), you can send it to: **The 52nd Street Project**, 500 West 52nd St., New York, NY 10019. Or fax it to (212) 333-5598.

## Don't Miss Our Upcoming Shows!



December 10-12  
Stage 36  
312 W. 36th St.  
3rd Floor

In September, 10 kids brand-new to the Project began a Playmaking class taught by Playmaking Director Megan Sandberg-Zakian. Come and see their final plays performed by adult professional actors.

# AND WE'RE BACK!

THE RETURN OF THE  
TWO-ON-TWOS  
JANUARY 28-30  
AT THE WOMEN'S INTERART ANNEX

The 52nd Street Project is a non-profit organization that brings children from the Hell's Kitchen neighborhood together with professional theater artists to create original theater. **NOTHING UP MY SLEEVE** is a production of our **Playback** program, in which kid actor/playwrights wrote plays that were then "answered" by adult actor/playwright partners who write their own plays. We took the whole menagerie up to the idyllic hamlet of Franklin, NY over the Columbus Day weekend to rehearse the shows. In the final production, which you see here tonight, the partners perform both plays back-to-back. All of the kids involved are veterans of the Playmaking classes which were adapted for the Project by Daniel Judah Sklar from his book *Playmaking: Children Writing and Performing Their Own Plays*.

### The 52nd Street Project Board of Directors

Ben Barenholtz  
Lisa Benavides  
Rachel Chanoff  
Cathy Dantchik  
Wendy Ettinger,  
*chair emeritus*  
Louis P. Friedman  
Stephen Graham, *chair*  
Larry Jones  
James McDaniel  
Frances McDormand  
Noël Mihalow  
Patricia M. Murphy, Esq.

Carol Ochs  
Willie Reale,  
*founder*  
Gus Rogerson  
Shirley Rumierk,  
*alumni member*  
José Soto, Jr.,  
*alumni member*  
Pamala Tyson  
Laura Valeroso  
Wendy vanden Heuvel  
John A. Vassilaros  
Jenny Wiener

### Special Thanks

We're extremely grateful to **Gene, Carol, and Carmela Marner; Tom Duerdon** and **Xena Sheehan**, the **Rich** family and all the folks in Franklin, NY for being such gracious hosts on the weekend away. **Ed Vassallo** gets a special foam-core Croix de Guerre for arranging the entire expedition.

### In-Kind Contributions

Randy, Jeff, Brian, Jared and the AXIS Theatre Company; The Murphy Law Office; Benefit Cosmetics; Iris A. Brown; Bourjois Paris; Bumble and bumble; Ron Kastner and Capital Printing; Kenneth Cole Productions; Noggin; The Printing Store; Scholastic, Inc.; Diageo Chateau & Estate Wines; Entertainment Weekly; Lucky Magazine; Microtouch/Finishing Touch; Molten Brown; MOP Cosmetics; Newman's Own; Pharma Print/Omni Graphics; Sesame Workshop; Wendy Stuhlberg; Terax America; John A. Vassilaros; Watkins, Inc.; Mayor's Office of Film & Television; Boylan's Bottling Co.; David Sneddon & Fairway Market; Lorraine Tobias & Imaginary Studios; Jive Records, part of Zomba Music Group; and Prime Films.

## Nothing Up My Sleeve: The Deceptive Plays - Act I

All original music composed by Loren Toolajian

### Uncertainty

By Skye Blu Welsh, age 13. Dramaturg/Director: Danny Goldstein.

### B.P.H.S. Revisited

Written and directed by Danny Goldstein.

Drew .....Skye Blu Welsh  
James .....Danny Goldstein  
Drew's Friend .....Kaylelani Silva

*"Like You-Like You"* lyrics by Skye Blu Welsh.

### I.I.: Incredible Intelligence

By Octavia Rodriguez, age 12. Dramaturg/Director: Megan Sandberg-Zakian.

### O.I.: Opinionated Intelligence

Written and directed by Megan Sandberg-Zakian.

Robot .....Octavia Rodriguez  
Evil Rose/Dr. Smile .....Megan Sandberg-Zakian  
Voice of operator .....Sarah Petersiel  
Mailman .....George Babiak  
Storekeeper .....Jennifer Ramirez

*"Hate to Sing"* lyrics by Megan Sandberg-Zakian.

### Da Secret

By Amanda Santos, age 13. Dramaturg: Jolie Tong. Director: Malinda Walford.

### Da Lesson

Written by Jolie Tong, directed by Malinda Walford.

Irise/Bernice the Bright .....Amanda Santos  
Bonquisha/Queen Ernestine .....Malinda Walford  
Servant .....Sarah Petersiel

*"Perky and Pink"* lyrics by Amanda Santos. *"Lesson Learned"* lyrics by Jolie Tong.

### Sandy Dream

By Kimani Lewis-Ashley, age 14. Dramaturg/Director: Jed Clarke.

**Life Without Failure** Written and Directed by Jed Clarke.

Peter .....Kimani Lewis-Ashley  
Hudson IV .....Jed Clarke  
Jack .....George Babiak  
Newscaster .....Sarah Petersiel

*"Feeling Swell"* lyrics by Kimani Lewis-Ashley, *"Failure"* lyrics by Jed Clarke.

👉 **Intermission!** 👈

## Nothing Up My Sleeve: The Deceptive Plays - Act II

### When Wendy Meets Will

By Isayah Muller, age 12. Dramaturg/Director: John Sheehy.

**Who's Your Daddy** Written and directed by John Sheehy.

Sheriff Wendy MacDonalds .....Isayah Muller  
Pirate Will Abominable .....John Sheehy

*"Your Father Is Insane"* lyrics by Isayah Muller

### Love and Hate

By Britney Castro, age 14. Directed by Abigail Lopez. Dramaturg: Liz Bell.

### Sister, Schizophrenia

Written by Liz Bell. Directed by Abigail Lopez.

Aqua Paradise .....Britney Castro  
Liberty Paradise .....Abigail Lopez  
Friends and runway models .....The Crew  
Jennifer .....Sarah Petersiel  
Rude Backstage Dude .....George Babiak

*"I Need My Liberty"* lyrics by Liz Bell

### My Friend is Not in the Yearbook

By Christopher Ramirez, age 13. Dramaturg/Director: Erin Quinn Purcell.

### Lovelorn Jack and the Enchanting Violin:

#### An Operetta in Three Acts

Written and directed by Erin Quinn Purcell.

Jack .....Christopher Ramirez  
Carla/The Evil Witch .....Erin Quinn Purcell  
Cool Kids .....Gus Rogerson and George Babiak  
Cigarette Girl .....Kayelani Silva

*"Carla's Song"* lyrics by Christopher Ramirez, *"I Love This Violin I & II"* lyrics by Erin Quinn Purcell.



The 52nd Street Project gratefully acknowledges the support of the following foundations and corporations: American Media; Barker Welfare Foundation; Bloomberg; Capital Research Company; Carnegie Corporation of New York; CBS; Citigroup; Consolidated Edison; Comedy Central; The Dramatists Guild Fund; Dramatists Play Service; The Max & Victoria Dreyfus Foundation Inc.; Eleanor, Adam & Mel Dubin Foundation; Entertainment Weekly; The Henlopen Foundation; The Hennessy Foundation; HBO; Holland Lodge Foundation, Inc.; The Horace W. Goldsmith Foundation; Hurlbut Family Charitable Lead Trust; JKW Foundation; Betty E. & George B. Kaiser Foundation; Lloyds TSB Bank plc; Lucille Lortel Foundation; James A. Macdonald Foundation; MadHouse, Inc.; Ann M. Martin Foundation; Mellon Equity Associated, LLP; The New World Foundation; The New York Times Company Foundation; Newman's Own; Armstrong Nickoll Family Foundation; Noggin; Norcross Wildlife Foundation, Inc.; The Fox & Leslie R. Samuels Foundation; Sesame Workshop; Stranahan Foundation; The Surdna Foundation; Theatre Communications Group, Inc.; The Vervane Foundation; John A. Vassilaros & Son, Inc; Yorke Construction Corporation; Felix Zarembo & Co. Inc. In addition the following individuals made gifts of over \$200 to The 52nd Street Project this year (list is current as of 6/30/04):

Robert Abrams & Cynthia Vance	Louis & Patrice Friedman	Jane Perlmutter	David & Anita Rogerson
Cecilia Arana-Grant & Kevin Grant	Janeane Garofalo	Doda Manalansan	Daryl Roth
Adam Leitman Bailey	Rose Gasner & Larry Chertoff	Paul & Lauren Mandell	Martha Roth & Bill Irwin
Ben Barenholtz	Alexandra Gersten &	Sonia Manzano &	Steve Sabba
Jessica Bauman	John Vassilaros	Richard Reagan	Arnold & Agnes Sametz
Laurie Becker & Rick Sweren	Cora Cahan & Bernard Gersten	Donald Margulies & Lynn Street	Laura Sametz & Anton Fig
Meredith Beeuwkes	Nancy Giles	Gene & Mary Ann McCoy	Karin & Tom Schall
Lisa Benavides & Tim Nelson	Lloyd & Kitty Gilmour	Paul McCrane & Dana Kellin	Maury Schott
Gavin Berger & Craig Berggren	Judy Goldman & Michael Pillingier	Fran McDormand & Joel Coen	Lauren Seikaly & Michael Huber
Alexander & Elizabeth Bernstein	George & Amy Goldstein	Andrew McKeon	Jeffrey Seller & Joshua Lehrer
Jeanette & Samuel Black	Larry & Carol Goldstein	Rick Meese & Dan Lori	Mitchell Semel & Colleen Carroll
Lewis Black	Stephen & Cathy Graham	Danny Meisner	Aaron & Elaine Shapiro
Tessa Blake	Connie Grappo & Lee Wilkof	Josie Merck & Jim Stevenson	Pam Shaw & Victor Syrmis
Buzz Bovshow	Emily Grishman & Susan Sampliner	Brian Mertes	Seth Shepsle
Jon Brielle	Bruce Grossberg & Laura Rovinsky	Audrey & Danny Meyer	Peter Shinoda
Kathy Briggs	Lisa Gugenheim	Judy Minor	Meg Simon
Becky Browder & Ted Neustadt	Alan Halperin & Wendy Halperin	Emily & John Morgan	Landon Slane
Deborah Brown	Jane & Jonathan Heine	Mala & Sham Mosher	Jeff Stafford
Susan Bruce & Peter Hedges	Peter Herdrich & Karen Trott	Walter Mosley	John Steber & Robert Shaffron
Kate Burton & Michael Ritchie	Amy Hertzig	Michelle Mulitz & Morty Gudelsky	Jean Stein
Linda & Arthur Carter	William Holtzman &	Suzen Murakoshi & Mark Temme	R.L. Stine & Jane Stine
Constance Casey	S. Sylvia Shepard	Richard Murawczyk	Susanna Styron & Darrell Larson
Alfred C. Cerullo III	Katy Homans & Patterson Sims	& Laura Murawczyk	Daniel Swee
Rachel Chanoff	Sarah Horowitz & David Venarde	Patricia M. Murphy, Esq.	Timothy Thomas
Lieta Heslen-Cohen & Richard Cohn	Sy Jacobs	& Adam Spilka	Adriana & Tim Stephenson
Billy Crudup	Donna & Thomas Jaycox	Frank Napolitano	Laura Valeroso & David Seidman
Tom Cruise	Amanda Johns	Steven Neiditz & Leslie Neiditz	Wendy vanden Heuvel &
Arthur Dantchik	Andrea Johnson	Don & Sara Nelson	Brad Coley
Cathy Dantchik	Kristen Johnston	Randy & Rona Nelson	Susan Vitucci
Leslie Dantchik	Larry & Mary Jones	Clea Newman	Mary Pat Walsh
Peter & Judith Dawkins	Aram Kailian & Eli Pariser	Edward Norton	Brenda Wehle & John C. Lynch
Alex Draper & Lorraine Tobias	Sheryl Kaller	Kevin O'Rourke & Edith Thurber	Randall Weisenburger
Richard & Rebecca Dresser	Cindy Kaplan	Carol Ochs & Bruce MacVittie	Sally & Lenny Weiss
Christopher & Karen Eddowes	Michelle Katz	Jacki Ochs & Jan Kroeze	Ali Marsh
Renee Edelman	James Kern & Deborah Kern	Paul & Maria Onderdonk	Jane Bolster & Steve Wertimer
David & Chrysti Eigenberg	Steven Klinsky	Sascha Paladino	Jenny Wiener & Jon Steingart
Ned Eisenberg & Patricia Maguire	Mary Kong	Elizabeth Peters	Michael & Zena Wiener
Nora Ephron	Judy Kuhn & David Schwab	Peter & Ana Rosa Phillips	Donald Windham
Wendy Ettinger & Derek McLane	Liza Lerner	Susan Ochs Phillips	Frank Wood
Peter Jay Fernandez & Denise Burse	Ilana Levine & Dominic Fumusa	Katharyn Pinder	Joanne Woodward &
Martin Fetner & William Coury	Joshua Lewis & Sarah Kay	Jeremy & Paulette Posner	Paul Newman
Liz Fillo	Anna Li	Peter & Helen Randolph	Bill Wrubel & Jennifer Crittenden
David Frankel	Katherine Lumb	Paul Reale & Barbara McCrane	Patricia Xenos
Richard Frankel & Kathleen Clark	John Lyons	Willie Reale & Jenny Gersten	Jeffrey & Janine Yass
Alison Fraser & Nat Magee	Grace Lyu-Volckhausen	Theresa Rebeck & Jess Lynn	James & Mary Lin Yoshimura
Frank Frattaroli	Greg MacPherson &	Lise Rehwaldt & Mark Roberts	Elisa Zuritsky & Jordan Barowitz

The 52nd Street Project Presents

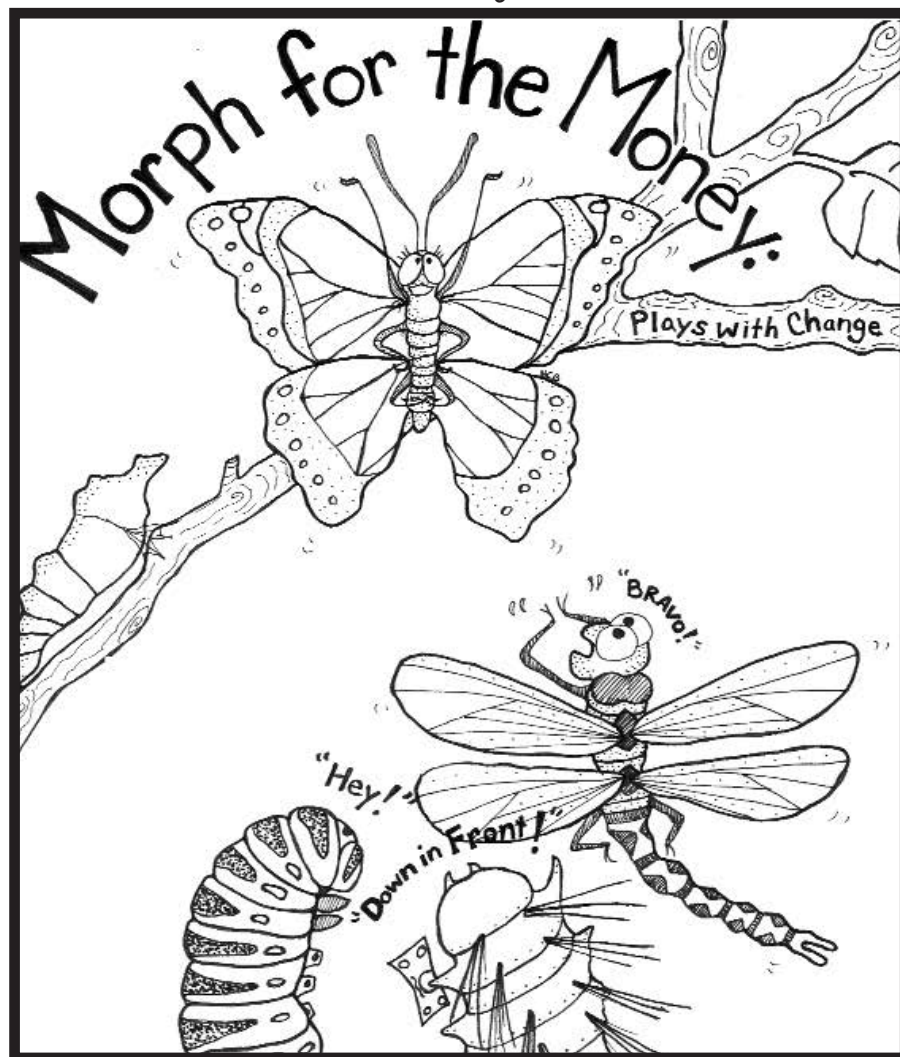

## The Kripplebush Playmaking Series - Fall 2004

Fri., Dec. 10 at 7:30 p.m.,

Sat., Dec. 11 at 3:00 p.m. and 7:30 p.m.

and Sun., Dec. 12 at 3:00 p.m.

Stage 36, 312 West 36th St.



# Morph for the Money

The Kripplebush Playmaking Plays - Fall 2004 - Dec. 12-14  
Stage 36, 312 W. 36th St.

## The 52nd Street Project Staff:

Gus Rogerson, Artistic Director  
Carol Ochs, Executive Director  
John Sheehy, Director of Development and Marketing  
Megan Sandberg-Zakian, Associate Artistic Director  
George "X-Acto" Babiak, Production Manager  
Liz Bell, Director of Education  
Diana Rojas, Executive Assistant  
Chris Ceraso, Teen Dean  
Mayleen Cancel, Education Assistant  
Iris A. Brown, Graphic Designer  
Solangee Acosta and Amelia Whitney, Receptionists  
Mara Grunbaum, Intern

## Production Staff

**Composer:** Patrick Barnes  
**Set Designer:** Kevin Joseph Roach  
**Lighting Designer:**  
Greg MacPherson  
**Countess of Costumes:**  
Crystal Thompson  
**Sound Designer:** Maury Schott  
**Stage Manager:** Sarah Wynne  
**Slide Designers:**  
George Babiak, Sandra Barron,  
Chris Bonanos, Todd Levin,  
Katherine Lumb, Mike Sell,  
John Steward, Alberta Testanero  
**"Morph" Illustration:**  
Heather Carnduff-Gobbée  
**Prop Design Team:**  
George Babiak, Heather Carnduff-  
Gobbée, Emmy Grinwis,

Mara Grunbaum, Lee Rosen,  
John Sheehy  
**Furniture Crew:**  
Ephraim Lopez  
and Mordecai Santiago  
**Prop Crew:**  
Mara Grunbaum and Skyebly Welsh  
**Load-in and Light Hang Crew:**  
Moirra MacDonald, Doug Nervik,  
Jamie Smith  
**Playmaking Class Volunteers:**  
Nancy Giles, Maile Holck, Melissa  
Jones, Mario Quesada  
**House Managers:**  
Karin Schall, Mary Pat Walsh,  
Liz Bell  
**Host/Chefs:**  
Joe White and Iris A. Brown

## COOL STUFF ON SALE!

Flyer Bars .....\$2.00, \$1.50 & \$1.00

*Shel Silverstein's "Fivey and Twoey" logo gear:*

Project sweatshirts .....\$20.00  
Project long sleeve t-Shirts .....\$15.00  
Project Caps .....\$15.00  
Project Mugs .....\$5.00  
Project Pencil 3-pack .....\$1.00  
"Sweet Appreciation" CD .....\$25.00

Thank you for coming to **MORPH FOR THE MONEY**. If you are not on our mailing list (or if your address has changed), please fill out this form and give it to us on your way out or mail it to the address below. We would also like to know if you are interested in becoming a volunteer. We need help in **all areas**, so be sure to fill out the entire form.

### PLEASE ADD ME TO YOUR MAILING LIST:

12/04

NAME: \_\_\_\_\_

ADDRESS: \_\_\_\_\_

ZIP \_\_\_\_\_

HOME PHONE: \_\_\_\_\_

DAYTIME PHONE: \_\_\_\_\_

E-MAIL ADDRESS: \_\_\_\_\_

MY OCCUPATION: \_\_\_\_\_

MY HOBBIES: \_\_\_\_\_

### YES, I WOULD LIKE TO BE OF HELP. I CAN:

- |   |   |  |
|---|---|--|
| <input type="checkbox"/> Help load in and out for shows | <input type="checkbox"/> Draw and/or paint  | <input type="checkbox"/> Help kids with homework |
| <input type="checkbox"/> Hang lights                    | <input type="checkbox"/> Help with mailings | <input type="checkbox"/> Teach kids a skill      |
| <input type="checkbox"/> Work on a backstage crew       | <input type="checkbox"/> Do office work     | <input type="checkbox"/> Be a chef at an event   |
| <input type="checkbox"/> Do graphic design              | <input type="checkbox"/> Design sound       | <input type="checkbox"/> Design and sew costumes |
| <input type="checkbox"/> Other (please specify) _____   |   |  |

### MY SCHEDULE IS:

- Very flexible. I'm often available during weekdays.  
 Somewhat flexible. I can help on the occasional morning or afternoon during the week.  
 Not very flexible at all, but I've got some free time on evenings and weekends.

If you would like to mail this (and you're always welcome to enclose a tax-deductible contribution), you can send it to: **The 52nd Street Project**, 500 West 52nd St., New York, NY 10019. Or fax it to (212) 333-5598.



The Playmaking Program is made possible with public funds from The New York State Council on the Arts, a state agency. The 52nd Street Project is a member of Art/NY and a participant in the New Generations Program, funded by Doris Duke Charitable Foundation/The Andrew W. Mellon Foundation and administered by Theatre Communications Group, the national organization for the American Theater.



**Don't Miss Our Upcoming Shows!**

# And We're Back!

## THE RETURN OF THE...

January  
28th,  
29th,  
and 30th  
2005

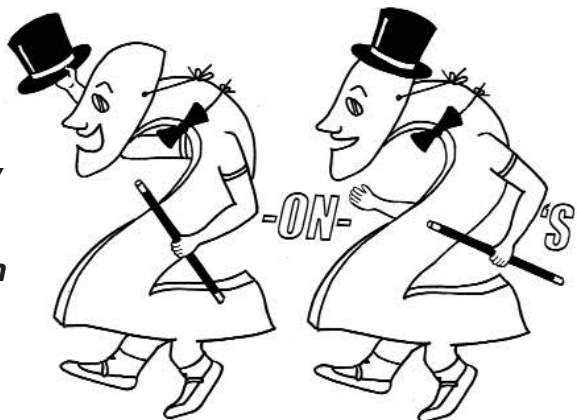

The  
Women's  
Interart  
Annex,  
500 W. 52nd

6 new plays, each with two kids as performers and two adults as writers and directors. We haven't done this in two years!



# What's the Big Idea?

Plays to Think About

The Spring Edition of the  
Project's Playmaking Program  
April 1, 2, and 3 at  
The Calhoun School Theater

If you're enjoying the show tonight, you'll want to take in another set of shows by our next batch of Project newcomers! Call 642-5052 for reservations.

The 52nd Street Project is a non-profit organization that brings children from the Hell's Kitchen neighborhood together with professional theater artists to create original theater. **MORPH FOR THE MONEY** is a production of our Playmaking program. Young people participate in a nine-week playwriting course taught by Megan Sandberg-Zakian and adapted for the Project by Daniel Judah Sklar from his book *Playmaking: Children Writing and Performing Their Own Plays*. At the end of the course, each child is given two actors, a theme, and a dramaturg/director who guides him or her through the writing of a play during a weekend retreat in the country (Kripplebush, New York, for this show). Tonight's performance is the end result.

### The 52nd Street Project Board of Directors

Ben Barenholtz  
Lisa Benavides  
Rachel Chanoff  
Cathy Dantchik  
Noël Dawkins  
Wendy Ettinger,  
*chair emeritus*  
Louis P. Friedman  
Stephen Graham, *chair*  
Larry Jones  
James McDaniel  
Frances McDormand  
Patricia M. Murphy, Esq.

Carol Ochs  
Willie Reale,  
*founder*  
Gus Rogerson  
Shirley Rumierk,  
*alumni member*  
José Soto, Jr.,  
*alumni member*  
Pamala Tyson  
Laura Valeroso  
Wendy vanden Heuvel  
John A. Vassilaros  
Jenny Wiener

### Special Thanks

We're extremely grateful to **Steve Buscemi** and **Jo Andres**, who graciously allowed us to use their beautiful home in Kripplebush, NY as our base of operations for the writer's retreat. We also owe a mini-van load of gratitude to **Joe White** and **Iris Brown** for cooking some mighty big (and good) meals and lining up all the other host families (who earn thanks as well): **Tim Guinee** and **Daisy Foote**, **Laura Shane Cunningham**, **Mary Louise Wilson**, **Nicole** and **Paul Quinn**, **Deborah Freedman**, **Bill Woods**, and **Charles** and **Naomi Miles**.

### In-Kind Contributions

The Murphy Law Office; Benefit Cosmetics; Iris A. Brown; Bourjois Paris; Bumble and bumble; Ron Kastner and Capital Printing; Kenneth Cole Productions; Noggin; The Printing Store; Scholastic, Inc.; Diageo Chateau & Estate Wines; Entertainment Weekly; Lucky Magazine; Microtouch/Finishing Touch; Molten Brown; MOP Cosmetics; Newman's Own; Pharma Print/Omni Graphics; Sesame Workshop; Wendy Stuhlberg; Terax America; John A. Vassilaros; Watkins, Inc.; Mayor's Office of Film & Television; Boylan's Bottling Co.; David Sneddon & Fairway Market; Lorraine Tobias & Imaginary Studios; Jive Records, part of Zomba Music Group; and Prime Films.

## Morph for the Money - ACT I

All original music composed by Patrick Barnes

### The Life of Malibu and Fabulous Joe

by Amonson Pargas, age 10. Dramaturg/Director: Sascha Paladino  
Costume Designer: Munee Hayes

Malibu .....Kenajuan Bentley  
Fabulous Joe .....Bruce MacVittie  
Security Guy .....Mordecai Santiago

“The Hip-Hop Classic Rock Music Song” lyrics by Amonson Pargas

### A Cubic Corzonicon Life

by Azalea Rosario, age 10. Dramaturg/Director: Denise Burse  
Costume Designers: Debbie Lucas and Stephanie Bear

Dace .....Danyon Davis  
Hoggy, a groundhog .....Bryan Gmitter

“Now We Are Friends” lyrics by Azalea Rosario

### The Miracle of Music

By Carlos Dume, age 10. Dramaturg/Director: David Eigenberg  
Costume Designers: Scott Coppock and Marit Aagaard

Kate, a microphone .....Ellen Foley  
Phil, an electric guitar .....David Eigenberg  
Mom .....Skyeblu Welsh

“My Brother and I” lyrics by Carlos Dume

### The Big, The Small, and the Goofy

by Jason Gil, age 9. Dramaturg/Director: Peter Jay Fernandez  
Costume Designers: Marit Aagaard and Scott Coppock

Great Giant Shark .....Peter Appel  
Short Fuse .....Mario Quesada  
Russian Citizen .....George Babiak

“What I Could Do” lyrics by Jason Gil

### Why?

By Catherine Fernandez, age 10. Dramaturg/Director: Jessica Bauman  
Costume Designer: Cathrine Piper

Daisy .....Saidah Arrika Ekulona  
Kelly .....Michelle Pawk  
Mr. Barken .....John Sheehy

“Change” lyrics by Catherine Fernandez

☞ **Intermission!** ☞

## Morph for the Money - ACT II

### Trust

by Lilian Moore, age 12. Dramaturg/Director: Maria Goyanes  
Costume Designer: Vicki Jo De Rocker

Sandra Star .....Lucia Brawley  
Mr. Roy Whiskers .....Dion Graham

“Letting Go” lyrics by Lilian Moore

### I Wish I Had Something To Do

by Emmett Goodman-Boyd, age 10. Dramaturg/Director: Emmy Grinwis  
Costume Designer: Munee Hayes

Zack .....Christopher Randolph  
Amy .....Florencia Lozano

“I Have an Idea” lyrics by Emmett Goodman-Boyd

### The Big Chase

by Lordan Ulloa, age 10. Dramaturg/Director: Charlie Tocantins  
Costume Designer: Vicki Jo De Rocker

Alexis .....Cecilia Arana  
Slimy .....Eddie Cooper

### For All Those Years

by Krystal Vega, age 11. Dramaturg/Director: Liliana Amador  
Costume Designer: Cathrine Piper

Kat Ellen .....Catherine Mueller  
Elisa Ellen .....Maile Holck  
Michael .....Mordecai Santiago

“Why I Should Be Picked” and “Everything I Did for You” lyrics by Krystal Vega

### Trees and Snow

by Samantha Toro, age 10. Dramaturg/Director: Gus Rogerson  
Costume Designers: Debbie Lucas and Stephanie Bear

Snowy Man .....John Conlee  
Big Tree .....Melissa Jones  
The Tree .....Ephraim Lopez  
Different Tree .....Mara Grunbaum



*A Very  
Happy  
Holiday to all  
Projectiles!*

## The 52nd Street Project Cabaret

### Trees and Snow

by Samantha Toro, age 10. Dramaturg/Director: Gus Rogerson  
Costume Designers: Debbie Lucas and Stephanie Biear

Snowy Man .....John Conlee  
Big Tree .....Melissa Jones

### For All Those Years

by Krystal Vega, age 11.  
Dramaturg/Director: Liliana Amador  
Costume Designer: Cathrine Piper

Kat Ellen .....Catherine Mueller  
Elisa Ellen .....Maile Holck

*"Why I Should Be Picked"* and *"Everything I Did for You"* lyrics  
by Krystal Vega, music by Patrick Barnes

### Two Gents of Whence

Written by Willie Reale & Directed by Victor Rojas  
for Christopher Ramirez, age 14  
Costume Designers: Crystal Thompson and Vicki Jo De Rocker

Spence .....Christopher Ramirez  
Impetigo .....Victor Rojas

*"Heather"* and *"Me"* lyrics by Willie Reale, music by Kim D.  
Sherman

### The Miracle of Music

By Carlos Dume, age 10. Dramaturg/Director: David Eigenberg  
Costume Designers: Scott Coppock and Marit Aagaard

Kate, a microphone .....Ellen Foley  
Phil, an electric guitar .....Maggie Lacey  
Mom .....George Babiak

*"My Brother and I"* lyrics by Carlos Dume

## "Just Kidding" at Symphony Space

### I Wish I had Something to Do

by Emmett Goodman-Boyd, age 10.  
Dramaturg/Director: Emmy Grinwis  
Costume Designer: Muneé Hayes

Zack .....Christopher Randolph  
Amy .....Florencia Lozano

*"I Have an Idea"* lyrics by Emmett Goodman-Boyd, music by  
Patrick Barnes

### Fools Russian

Written & Directed by John Sheehy  
for Jason Peterson Ridge, age 11  
Costume Designer: Bryan Gmitter

Sergei .....John Sheehy  
Alexei .....Jason Peterson Ridge  
Ringmaster .....George Babiak

*"I Can't Hold On"* lyrics by John Sheehy, music by Kim D.  
Sherman

**Stage Manager:** Karen Munkel

**Lighting Designer:** Greg MacPherson

**Music Director:** Patrick Barnes

**Sound operator:** Mara Grunbaum

**Backstage support:** Ephraim Lopez

### The 52nd Street Project Staff

Gus Rogerson, Artistic Director

Carol Ochs, Executive Director

John Sheehy, Director of Development and Marketing

Megan Sandberg-Zakian, Associate Artistic Director

George Babiak, Production Manager

Liz Bell, Director of Education

Diana Rojas, Executive Assistant

Mayleen Cancel, Education Assistant

## **About The 52nd Street Project**

The 52nd Street Project is dedicated to the creation and production of new plays for and by kids between the ages of ten and eighteen who reside in the Hell's Kitchen neighborhood of New York City. The Project does this through unique mentoring programs that match kids with professional (and volunteer!) theater artists.

The Project is about making children proud of themselves. The Project is not about teaching children to act or write plays, although they will learn how to do both. What it is about is giving a kid an experience of success. It is an opportunity to prove that he or she has something of value to offer, something that comes from within that he or she alone possesses, something that cannot be taken away.

The program we present today is a specially selected smorgasbord of plays from the **One-on-Ones**, our summertime series in which kids perform with adults, and our **Playmaking** program, in which kids write original scripts for professional adult actors.

### ***The 52nd Street Project***

500 West 52nd St., #2B, New York, NY 10019

Phone: (212) 333-5252 Fax: (212) 333-5598

For more information about volunteering or our programs,  
call us, visit [www.52project.org](http://www.52project.org), or write to us at [info@52project.org](mailto:info@52project.org)

The 52nd Street Project gratefully acknowledges the support of the following foundations and corporations: American Media; Barker Welfare Foundation; Bloomberg; Blythmour Corporation; Capital Research Company; Carnegie Corporation of New York; CBS, Citigroup; Cityrest LLC; Consolidated Edison; Comedy Central; St. Vincent de Paul Foundation; The Dramatists Guild Fund; Dramatists Play Service; The Max & Victoria Dreyfus Foundation Inc.; Eleanor, Adam & Mel Dubin Foundation; Entertainment Weekly; The Horace W. Goldsmith Foundation; The Henlopen Foundation; The Hennessy Foundation; HBO; Holland Lodge Foundation, Inc.; Hurlbut Family Charitable Lead Trust; JKW Foundation; Betty E. & George B. Kaiser Foundation; Lloyds TSB Bank plc; Lucille Lortel Foundation; James A. Macdonald Foundation; Mad.House, Inc.; Ann M. Martin Foundation; Mellon Equity Associated, LLP; The New World Foundation; The New York Times Company Foundation; Newman's Own; Armstrong Nickoll Family Foundation; Noggin; Norcross Wildlife Foundation, Inc.; The Fan Fox & Leslie R. Samuels Foundation; Sesame Workshop; Stranahan Foundation; The Surdna Foundation; Theatre Communications Group, Inc.; The Vervane Foundation; John A. Vassilaros & Son, Inc; The Wiener Family Foundation; Yorke Construction Corporation; Felix Zarembo & Co. Inc. In addition the following individuals made gifts of over \$200 to The 52nd Street Project this year (list is current as of 1/26/05):

Robert Abrams & Cynthia Vance	Rose Gasner & Larry Chertoff	Sonia Manzano &	Laura Sametz & Anton Fig
Cecilia Arana-Grant & Kevin Grant	Alexandra Gersten &	Richard Reagan	Karin & Tom Schall
Adam Leitman Bailey	John Vassilaros	Donald Margulies & Lynn Street	Maury Schott
Ben Barenholtz	Cora Cahan & Bernard Gersten	Gene & Mary Ann McCoy	Lauren Seikaly & Michael Huber
Jessica Bauman & Ben Posel	Nancy Giles	Paul McCrane & Dana Kellin	Jeffrey Seller & Joshua Lehrler
Meredith Beeuwkes	Lloyd & Kitty Gilmour	Fran McDormand & Joel Coen	Mitchell Semel & Colleen Carroll
Lisa Benavides & Tim Nelson	Judy Goldman & Michael Pillingier	Andrew McKeon	Aaron & Elaine Shapiro
Gavin Berger & Craig Berggren	George & Amy Goldstein	Rick Meese & Dan Lori	Pam Shaw & Victor Szymis
Alexander & Elizabeth Bernstein	Larry & Carol Goldstein	Danny Meisner	Seth Shepsle
Jeanette & Samuel Black	James & Virginia Graham	Josie Merck & Jim Stevenson	Peter Shinoda
Lewis Black	Stephen & Cathy Graham	Brian Mertes	Mitchell Silverman
Tessa Blake	Connie Grappo & Lee Wilkof	Audrey & Danny Meyer	Meg Simon
Buzz Bovshow	Emily Grishman & Susan Sampliner	Judy Minor	Landon Slane
Jon Brielle	Bruce Grossberg & Laura Rovinsky	Emily & John Morgan	Jeff Stafford
Kathy Briggs	Lisa Gugenheim	Mala & Sham Mosher	John Steber & Robert Shaffron
Becky Browder & Ted Neustadt	Alan Halperin & Wendy Halperin	Walter Mosley	Jean Stein
Deborah Brown	Jane & Jonathan Heine	Keith & Judy Muhleman	R.L. Stine & Jane Stine
Susan Bruce & Peter Hedges	Peter Herdlich & Karen Trott	Michelle Multz & Morty Gudelsky	Susanna Styron & Darrell Larson
Kate Burton & Michael Ritchie	Amy Herzig	Suzen Murakoshi & Mark Temme	Daniel Swee
Linda & Arthur Carter	William Holtzman &	Richard Murawczyk	Timothy Thomas
Constance Casey	S. Sylvia Shepard	& Laura Murawczyk	Adriana & Tim Stephenson
Alfred C. Cerullo III	Katy Homans & Patterson Sims	Patricia M. Murphy, Esq.	Richard Sweren
Rachel Chanoff	Sarah Horowitz & David Venarde	& Adam Spilka	Liz Tuccillo
Lietla Hesen-Cohen & Richard Cohn	Sy Jacobs	Frank Napolitano	Laura Valeroso & David Seidman
Billy Crudup	Donna & Thomas Jaycox	Steven Neiditz & Leslie Neiditz	Wendy vanden Heuvel &
Tom Cruise	Amanda Johns	Don & Sara Nelson	Brad Coley
John Dagenhard	Andrea Johnson	Randy & Rona Nelson	Ed Vassallo
Arthur Dantchik	Kristen Johnston	Clea Newman	Susan Vitucci
Cathy Dantchik	Larry & Mary Jones	Edward Norton	Mary Pat Walsh
Leslie Dantchik	Aram Kailian & Eli Pariser	Kevin O'Rourke & Edith Thurber	Sam & Lynn Waterston
Peter & Judith Dawkins	Sheryl Kaller	Carol Ochs & Bruce MacVittie	Brenda Wehle & John C. Lynch
Alex Draper & Lorraine Tobias	Cindy Kaplan	Jacki Ochs & Jan Kroeze	Randall Weisenburger
Richard & Rebecca Dresser	Michelle Katz	Paul & Maria Onderdonk	Sally & Lenny Weiss
Christopher & Karen Eddowes	James Kern & Deborah Kern	Sascha Paladino	Ali Marsh
Renee Edelman	Steven Klinsky	Elizabeth Peters	Jane Bolster & Steve Wertimer
David & Chrysti Eigenberg	Mary Kong	Peter & Ana Rosa Phillips	Jenny Wiener & Jon Steingart
Ned Eisenberg & Patricia Maguire	Judy Kuhn & David Schwab	Susan Ochs Phillips	Michael & Zena Wiener
Nora Ephron	Kate Lear & Jonathan LaPook	Katharyn Pinder	Donald Windham
Heidi Ettinger	Liza Lerner	Jeremy & Paulette Posner	Frank Wood
Wendy Ettinger & Derek McLane	Ilana Levine & Dominic Fumusa	Peter & Helen Randolph	Joanne Woodward &
Peter Jay Fernandez & Denise Borse	Joshua Lewis & Sarah Kay	Paul Reale & Barbara McCrane	Paul Newman
Martin Fetner & William Coury	Anna Li	Willie Reale & Jenny Gersten	Bill Wrubel & Jennifer Crittenden
Liz Fillo	Katherine Lumb	Theresa Rebeck & Jess Lynn	Patricia Xenos
David Frankel	John Lyons	Lise Rehwaldt & Mark Roberts	Jeffrey & Janine Yass
Richard Frankel & Kathleen Clark	Grace Lyu-Volkhausen	David & Anita Rogerson	Mei Yueh Yen
Alison Fraser & Nat Magee	Greg MacPherson &	Daryl Roth	James & Mary Lin Yoshimura
Frank Frattaroli	Jane Perlmutter	Martha Roth & Bill Irwin	Bill Zarembo
Louis & Patrice Friedman	Doda Manalansan	Steve Sabba	Elisa Zuritsky & Jordan Barowitz
Janeane Garofalo	Paul & Lauren Mandell	Arnold & Agnes Sametz	

The 52nd Street Project Presents

# ...And We're Back!

## THE RETURN OF THE

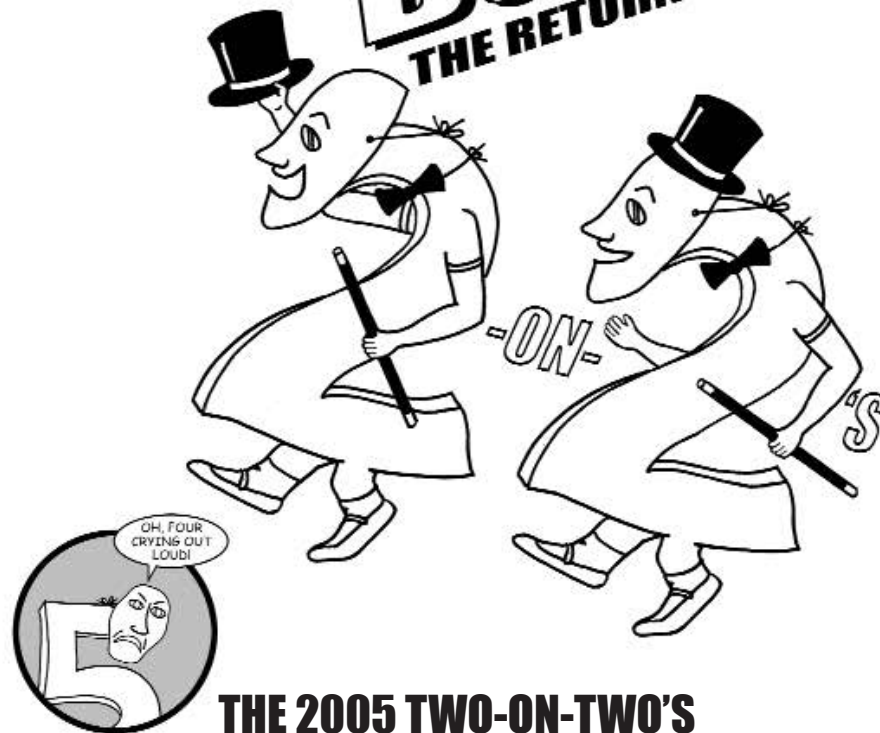

### THE 2005 TWO-ON-TWO'S

Friday, January 28 at 7:30 p.m.

Saturday, January 29 at 3:00 & 7:30 p.m.

Sunday, January 30 at 3:00 p.m.

### THE WOMEN'S INTERART ANNEX

500 W. 52nd St., #2A

# AND WE'RE BACK...

The Return of the Two-on-Two's - January 28-30, 2005  
The Women's Interart Annex

## The 52nd Street Project Staff:

Gus Rogerson, Artistic Director  
Carol Ochs, Executive Director  
John Sheehy, Director of Development and Marketing  
Megan Sandberg-Zakian, Associate Artistic Director  
George "X-Acto" Babiak, Production Manager  
Liz Bell, Director of Education  
Diana Rojas, Executive Assistant  
Mayleen Cancel, Education Assistant  
Chris Ceraso, Teen Dean  
Iris A. Brown, Graphic Designer  
Solangee Acosta and Amelia Whitney, Receptionists  
Rebecca Greig, Intern

## Production Staff

**Composer:** Joel Derfner

**Musical Director:** Doug Nervik

**Set Designer:** Kevin Joseph Roach

**Lighting Designer:**

Greg MacPherson

**Costume Designer:** Lora LaVon

**Sound Designer:** Vanessa Valdes

**Stage Manager:** Erica Schmidt

**Slide Designers:**

George Babiak, Sandra Barron,  
Chris Bonanos, Todd Levin,  
Katherine Lumb, Mike Sell,  
John Steward, Alberta Testanero

**Prop Design Team:**

George Babiak, Heather Carnduff-  
Gobbée, Rebecca Greig

**Furniture Crew:**

Charlie Tocantins and  
Stephanie Vamvoukakis

**Prop Crew:**

Rebecca Greig and Octavia Rodriguez

**Load-in and Light Hang Crew:**

Michael Coghlan, Nedra Gallegos,  
Yana Landowne, Doug Nervik,  
Anne O'Sullivan

**House Managers:**

Karin Schall, Mary Pat Walsh,  
Liz Bell

**Hosts:**

Fisher Stevens, Lili Taylor,  
Maria Tucci and Robert Gottlieb

# COOL STUFF ON SALE!

Flyer Bars .....\$2.00, \$1.50 & \$1.00

*Shel Silverstein's "Fivey and Twoey" logo gear:*

Project sweatshirts .....\$20.00

Project long sleeve t-Shirts .....\$15.00

Project Caps .....\$15.00

Project Mugs .....\$5.00

Project Pencil 3-pack .....\$1.00

Project Notebooks .....\$5.00

Thank you for coming to **AND WE'RE BACK**. If you are not on our mailing list (or if your address has changed), please fill out this form and give it to us on your way out or mail it to the address below. We would also like to know if you are interested in becoming a volunteer. We need help in **all areas**, so be sure to fill out the entire form.

**PLEASE ADD ME TO YOUR MAILING LIST:**

01/05

NAME: \_\_\_\_\_

ADDRESS: \_\_\_\_\_

ZIP \_\_\_\_\_

HOME PHONE: \_\_\_\_\_

DAYTIME PHONE: \_\_\_\_\_

E-MAIL ADDRESS: \_\_\_\_\_

MY OCCUPATION: \_\_\_\_\_

MY HOBBIES: \_\_\_\_\_

**YES, I WOULD LIKE TO BE OF HELP. I CAN:**

- |   |   |  |
|---|---|--|
| <input type="checkbox"/> Help load in and out for shows | <input type="checkbox"/> Draw and/or paint  | <input type="checkbox"/> Help kids with homework |
| <input type="checkbox"/> Hang lights                    | <input type="checkbox"/> Help with mailings | <input type="checkbox"/> Teach kids a skill      |
| <input type="checkbox"/> Work on a backstage crew       | <input type="checkbox"/> Do office work     | <input type="checkbox"/> Be a chef at an event   |
| <input type="checkbox"/> Do graphic design              | <input type="checkbox"/> Design sound       | <input type="checkbox"/> Design and sew costumes |
| <input type="checkbox"/> Other (please specify) _____   |   |  |

**MY SCHEDULE IS:**

- Very flexible. I'm often available during weekdays.  
 Somewhat flexible. I can help on the occasional morning or afternoon during the week.  
 Not very flexible at all, but I've got some free time on evenings and weekends.

If you would like to mail this (and you're always welcome to enclose a tax-deductible contribution), you can send it to: **The 52nd Street Project**, 500 West 52nd St., New York, NY 10019. Or fax it to (212) 333-5598.

State of the Arts



NYSOA

The Two-on-Two's Program is made possible with public funds from The New York State Council on the Arts, a state agency. The 52nd Street Project is a member of Art/NY and a participant in the New Generations Program, funded by Doris Duke Charitable Foundation/The Andrew W. Mellon Foundation and administered by Theatre Communications Group, the national organization for the American Theater.



## Don't Miss Our Upcoming Shows!

# M+M: THE REMIX

THE 52ND STREET PROJECT  
TEEN ENSEMBLE  
PRESENTS SCENES INSPIRED BY  
WILLIAM SHAKESPEARE'S  
**MEASURE FOR MEASURE**  
FOR MATURE AUDIENCES ONLY!  
MARCH 3 & 4  
IN THIS VERY SPACE

## What's the Big Idea?

Plays to Think About

The Spring Playmaking Series

April 1-3 at The Calhoun School Theater

A brand-new set of shows by the next batch of brand-new  
Projectiles! Call 212/642-5052 for reservations.



Hank Azaria and Oliver Platt invite you to  
Save the Date, and possibly the World at...



# A SUPER-HEROIC ACT

TO BENEFIT TRUTH, JUSTICE AND  
THE 52ND STREET PROJECT

**MONDAY, MAY 9, 2005**

For reservations or info call John "The Thing" Sheehy @ 212/333-5252

The 52nd Street Project is a non-profit organization that brings children from the Hell's Kitchen neighborhood together with professional theater artists to create original theater. **And We're Back...** is a production of our Two-on-Two's program, in which an adult playwright crafts a piece for a pair of Project kids to perform. Another adult directs the kids for a month that includes an intensive three-day weekend in Dutchess County, New York. Tonight's performance is the final result.

## The 52nd Street Project Board of Directors

Ben Barenholtz  
Lisa Benavides  
Rachel Chanoff  
Cathy Dantchik  
Noël Dawkins  
Wendy Ettinger,  
*chair emeritus*  
Louis P. Friedman  
Stephen Graham, *chair*  
Larry Jones  
James McDaniel  
Frances McDormand  
Patricia M. Murphy, Esq.

Carol Ochs  
Willie Reale,  
*founder*  
Gus Rogerson  
Shirley Rumierk,  
*alumni member*  
José Soto, Jr.,  
*alumni member*  
Pamala Tyson  
Laura Valeroso  
Wendy vanden Heuvel  
John A. Vassilaros  
Jenny Wiener

## Special Thanks

We're grateful to **Margot, Ronnie, Josh**, and the rest of the staff at **Women's Interart Annex** for making their extremely convenient space available to us. We also owe big-time thanks to **Maria Tucci** and **Robert Gottlieb, Lili Taylor**, and **Fisher Stevens**, all of whom graciously allowed us to use their upstate homes for three tumultuous and fun-filled days. Our gratitude also goes to Super Project Pal **Ron Fiorina** of **Boylan Bottling Co.**, **Mary Moore & D'Agostino's Supermarkets**, and board member **John A. Vassilaros** (a.k.a. Johnny Coffeeshopolis) for contributing our intermission refreshments. We are also grateful for the extraordinary amount of snow this year.

## In-Kind Contributions

The Murphy Law Office; Benefit Cosmetics; Iris A. Brown; Bourjois Paris; Bumble and bumble; Ron Kastner and Capital Printing; Kenneth Cole Productions; Noggin; The Printing Store; Scholastic, Inc.; Diageo Chateau & Estate Wines; Entertainment Weekly; Lucky Magazine; Microtouch/Finishing Touch; Molten Brown; MOP Cosmetics; Newman's Own; Pharma Print/Omni Graphics; Sesame Workshop; Wendy Stuhlberg; Terax America; John A. Vassilaros; Watkins, Inc.; Mayor's Office of Film & Television; Boylan's Bottling Co.; David Sneddon & Fairway Market; Lorraine Tobias & Imaginary Studios; Jive Records, part of Zomba Music Group; and Prime Films.



## And We're Back - ACT I

All original music composed by Joel Derfner  
and played by Doug Nervik

### David and Manny

By Michael Bernard. Directed by Michael Baron.

Manny . . . . .Alex Tomas  
David . . . . .Eddie Cuevas  
Announcer . . . . .Charlie Tocantins

“Ladies” lyrics by Michael Bernard.

### More Potatoes, More

By Madeleine George. Directed by Kim Sykes.

Rosalie . . . . .Katie Grullon  
Renee . . . . .Kamila Jacobs

“More Potatoes, More” lyrics by Madeleine George.

### The Giant and the Fairy

By Keira Naughton. Directed by Ed Vassallo.

Peaseblossom . . . . .Nicole Fargardo  
Goliath . . . . .Zebulun Santiago  
Forest Policeman . . . . .Charlie Tocantins

“Schadenfreude” and “We Killed a Freakin’ Dragon” lyrics by  
Keira Naughton.

☞ **Intermission!** ☜

Root Beer Floats, Coffee,  
and Flyer Bars in the lobby!

## And We're Back - ACT II

### Don and Dean

By Josh Lewis. Directed by Drew Cortese.

Dean . . . . .Mark Gamero  
Don . . . . .Michael Velez  
Dean’s Brother . . . . .Charlie Tocantins  
Linda . . . . .Rebecca Greig  
Party guests . . . . .Octavia Rodriguez & Stephanie Vamvoukakis

“Sun Salutation” lyrics by Josh Lewis.

### Don’t Call it a Comeback

By Liz Flahive. Directed by Megan Cramer.

Cecilia del Fuego . . . . .Megan Cruz  
Bobby Damon . . . . .Joshua Joya  
Hatchling Loggerhead . . . . .Megan Cruz

“Song of the Sea Turtle” lyrics by Liz Flahive.

### LMNOP Negative

By Willie Reale. Directed by Megan Sandberg-Zakian.

Jane Anzart . . . . .Evelyn Nicole Rosario  
Prunella . . . . .Katherine Acosta

“Annoying” lyrics by Willie Reale.

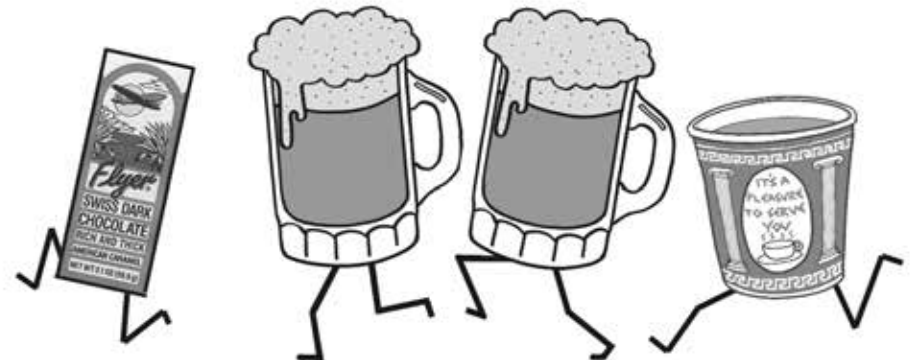

The **52nd Street Project Teen Ensemble** is a two-year program for graduates of The Project's writing and acting programs. The Teen Ensemble focuses on professional level acting technique by using both original and existing texts. The culmination of the program is the production of a play by William Shakespeare as adapted by the ensemble. The most recent teen production, **As You Like It**, was performed in the United Kingdom in the summer of 2003 at **Harrow School** in London and at the **Chateau de Berne** in Lorgues, France. The teens you see tonight will journey to Europe this summer to present a full-length version of **Measure for Measure**.

### The Project Staff

Gus Rogerson . . . . .Artistic Director  
 Carol Ochs . . . . .Executive Director  
 John Sheehy . . . . .Director of Development  
 Megan Sandberg-Zakian . . . . .Associate Artistic Director  
 George Roman Babiak . . . . .Production Manager  
 Liz Bell . . . . .Director of Education  
 Diana Rojas . . . . .Executive Assistant  
 Mayleen Cancel . . . . .Education Assistant  
 Chris Ceraso . . . . .Teen Dean  
 Solangee Acosta, Amelia Whitney . . . . .Receptionists  
 Rebecca Grieg, Rebecca Masback . . . . .Interns

### The 52nd Street Project Board of Directors

Ben Barenholtz	Carol Ochs
Lisa Benavides	Willie Reale, <i>founder</i>
Rachel Chanoff	Gus Rogerson
Cathy Dantchik	Shirley Rumierk, <i>alumni member</i>
Noël Dawkins	José Soto, Jr., <i>alumni member</i>
Wendy Ettinger, <i>chair emeritus</i>	Pamala Tyson
Louis P. Friedman	Laura Valeroso
Stephen Graham, <i>chair</i>	Wendy vanden Heuvel
Larry Jones	John A. Vassilaros
James McDaniel	Jenny Wiener
Frances McDormand	
Patricia M. Murphy, Esq.	

## The 52nd Street Project Teen Ensemble Presents

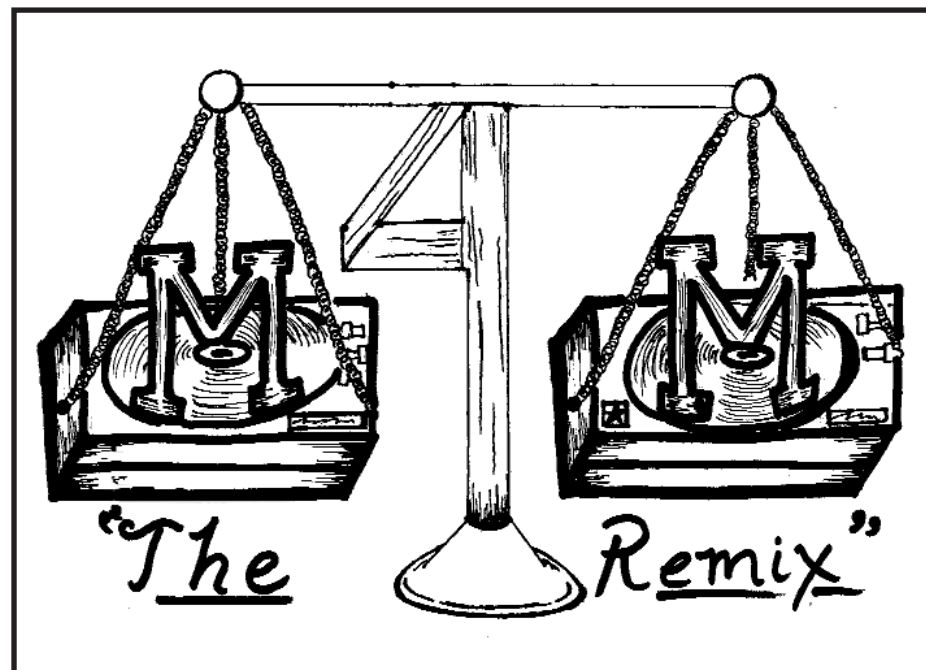

ARTWORK BY CHRISTINA RAMIREZ

# M4M: The Remix

*Scenes based on Shakespeare's  
"Measure for Measure"*

Thursday, March 3rd at 7:30 p.m.  
 Friday, March 4th at 7:30 p.m.

The Women's Interart Annex  
 500 W. 52nd St.

# M4M: The Remix

## **A Fearful Thing**

By Leah Galimidi

Directed by Diana Rojas

Claudio/Juan .....Christina Ramirez  
Leah .....Leah Galimidi  
Angelo .....Reg Flowers  
Mike .....Chris Ceraso

## **Birds of Prey**

By Nadya Jabour

Directed by Megan Sandberg-Zakian

Ms. Jones .....Nadya Jabour  
Ms. Geller .....Amelia Whitney  
Mr. Dale .....Chris Ceraso

## **Doubts**

By Christina Ramirez

Directed by Chris Ceraso

Lucio .....Christina Ramirez  
Mirror .....Leah Galimidi  
Lauren .....Nadya Jabour

## **Bound To You**

By Amelia Whitney

Directed by Reg Flowers

Mariana Overdone .....Amelia Whitney  
Claudio Provost .....Reg Flowers

**“The very mercy of the law cries out...  
an Angelo for Claudio, death for death...  
and measure still for measure.” –  
Measure for Measure, Act 5, Scene 1**

### **Extra Special Thanks To**

Margot Lewitin, Ronnie Geist,

Josh Liveright and

The Women’s Interart Annex;

Becky White;

Our old friends

Justin Aponte,

Joel Lind,

Robert Tomas,

and

Isaac Trujillo.

Sound:

Diana Rojas and Shevonne Hernandez

The 52nd Street Project gratefully acknowledges the support of the following foundations and corporations: American Media; Barker Welfare Foundation; Bloomberg; Blythmour Corporation; Capital Research Company; Carnegie Corporation of New York; CBS, Citigroup; Cityrest LLC; Consolidated Edison; Comedy Central; St. Vincent de Paul Foundation; The Dramatists Guild Fund; Dramatists Play Service; The Max & Victoria Dreyfus Foundation Inc.; Eleanor, Adam & Mel Dubin Foundation; Entertainment Weekly; The Horace W. Goldsmith Foundation; The Henlopen Foundation; The Hennessy Foundation; HBO; Holland Lodge Foundation, Inc.; Hurlbut Family Charitable Lead Trust; JKW Foundation; Betty E. & George B. Kaiser Foundation; Lloyds TSB Bank plc; Lucille Lortel Foundation; James A. Macdonald Foundation; MadHouse, Inc.; Ann M. Martin Foundation; Mellon Equity Associated, LLP; The New World Foundation; The New York Times Company Foundation; Newman's Own; Armstrong Nickoll Family Foundation; Noggin; Norcross Wildlife Foundation, Inc.; The Fan Fox & Leslie R. Samuels Foundation; Sesame Workshop; Stranahan Foundation; The Surdna Foundation; Theatre Communications Group, Inc.; The Vervane Foundation; John A. Vassilaros & Son, Inc; The Wiener Family Foundation; Yorke Construction Corporation; Felix Zarembo & Co. Inc. In addition the following individuals made gifts of over \$200 to The 52nd Street Project this year (list is current as of 1/26/05):

Robert Abrams & Cynthia Vance	Rose Gasner & Larry Chertoff	Sonia Manzano & Richard Reagan	Laura Sametz & Anton Fig
Cecilia Arana-Grant & Kevin Grant	Alexandra Gersten & John Vassilaros	Donald Margulies & Lynn Street	Karin & Tom Schall
Adam Leitman Bailey	Cora Cahan & Bernard Gersten	Gene & Mary Ann McCoy	Maury Schott
Ben Barenholtz	Nancy Giles	Paul McCrane & Dana Kellin	Lauren Seikaly & Michael Huber
Jessica Bauman & Ben Posel	Lloyd & Kitty Gilmour	Fran McDormand & Joel Coen	Jeffrey Seller & Joshua Lehrer
Meredith Beeuwkes	Judy Goldman & Michael Pillingier	Andrew McKeon	Mitchell Semel & Colleen Carroll
Lisa Benavides & Tim Nelson	George & Amy Goldstein	Rick Meese & Dan Lori	Aaron & Elaine Shapiro
Gavin Berger & Craig Berggren	Larry & Carol Goldstein	Danny Meisner	Pam Shaw & Victor Symris
Alexander & Elizabeth Bernstein	James & Virginia Graham	Josie Merck & Jim Stevenson	Seth Shepsle
Jeanette & Samuel Black	Stephen & Cathy Graham	Brian Mertes	Peter Shinoda
Lewis Black	Connie Grappo & Lee Wilkof	Audrey & Danny Meyer	Mitchell Silverman
Tessa Blake	Emily Grishman & Susan Sampliner	Judy Minor	Meg Simon
Buzz Bovshow	Bruce Grossberg & Laura Rovinsky	Emily & John Morgan	Landon Slane
Jon Brielle	Lisa Gugenheim	Mala & Sham Mosher	Jeff Stafford
Kathy Briggs	Alan Halperin & Wendy Halperin	Walter Mosley	John Steber & Robert Shaffron
Becky Browder & Ted Neustadt	Jane & Jonathan Heine	Keith & Judy Muhleman	Jean Stein
Deborah Brown	Peter Herdrich & Karen Trott	Michelle Multz & Morty Gudelsky	R.L. Stine & Jane Stine
Susan Bruce & Peter Hedges	Amy Herzig	Suzen Murakoshi & Mark Temme	Susanna Styron & Darrell Larson
Kate Burton & Michael Ritchie	William Holtzman & S. Sylvia Shepard	Richard Murawczyk & Laura Murawczyk	Daniel Sweet
Linda & Arthur Carter	Katy Homans & Patterson Sims	Patricia M. Murphy, Esq. & Adam Spilka	Timothy Thomas
Constance Casey	Sy Jacobs	Frank Napolitano	Adriana & Tim Stephenson
Alfred C. Cerullo III	Donna & Thomas Jaycox	Steven Neiditz & Leslie Neiditz	Richard Sweren
Rachel Chanoff	Amanda Johns	Don & Sara Nelson	Liz Tuccillo
Lielta Hesen-Cohen & Richard Cohn	Andrea Johnson	Randy & Rona Nelson	Laura Valeroso & David Seidman
Billy Crudup	Kristen Johnston	Clea Newman	Wendy vanden Heuvel & Brad Coley
Tom Cruise	Larry & Mary Jones	Edward Norton	Ed Vassallo
John Dagenhard	Aram Kailian & Eli Pariser	Kevin O'Rourke & Edith Thurber	Susan Vitucci
Arthur Dantchik	Sheryl Kaller	Carol Ochs & Bruce MacVittie	Mary Pat Walsh
Cathy Dantchik	Cindy Kaplan	Jacki Ochs & Jan Kroeze	Sam & Lynn Waterston
Leslie Dantchik	Michelle Katz	Paul & Maria Onderdonk	Brenda Wehle & John C. Lynch
Peter & Judith Dawkins	James Kern & Deborah Kern	Sascha Paladino	Randall Weisenburger
Alex Draper & Lorraine Tobias	Steven Klinsky	Elizabeth Peters	Sally & Lenny Weiss
Richard & Rebecca Dresser	David & Chrysti Eigenberg	Peter & Ana Rosa Phillips	Ali Marsh
Christopher & Karen Eddowes	Ned Eisenberg & Patricia Maguire	Susan Ochs Phillips	Jane Bolster & Steve Wertimer
Renee Edelman	Nora Ephron	Katharyn Pinder	Jenny Wiener & Jon Steingart
David & Chrysti Eigenberg	Heidi Ettinger	Jeremy & Paulette Posner	Michael & Zena Wiener
David & Chrysti Eigenberg	Wendy Ettinger & Derek McLane	Peter & Helen Randolph	Donald Windham
Ned Eisenberg & Patricia Maguire	Peter Jay Fernandez & Denise Borse	Paul Reale & Barbara McCrane	Frank Wood
Nora Ephron	Martin Fetner & William Coury	Willie Reale & Jenny Gersten	Joanne Woodward & Paul Newman
Heidi Ettinger	Liz Fillo	Theresa Rebeck & Jess Lynn	Bill Wrubel & Jennifer Crittenden
Wendy Ettinger & Derek McLane	David Frankel	Lise Rehwaldt & Mark Roberts	Patricia Xenos
Peter Jay Fernandez & Denise Borse	Richard Frankel & Kathleen Clark	David & Anita Rogerson	Jeffrey & Janine Yass
Martin Fetner & William Coury	Alison Fraser & Nat Magee	Daryl Roth	Mei Yueh Yen
Liz Fillo	Frank Frattaroli	Martha Roth & Bill Irwin	James & Mary Lin Yoshimura
David Frankel	Louis & Patrice Friedman	Steve Sabba	Bill Zarembo
Richard Frankel & Kathleen Clark	Janeane Garofalo	Arnold & Agnes Sametz	Elisa Zuritsky & Jordan Barowitz
Alison Fraser & Nat Magee			
Frank Frattaroli			
Louis & Patrice Friedman			
Janeane Garofalo			

GUS ROGERSON  
ARTISTIC DIRECTOR

CAROL OCHS  
EXECUTIVE DIRECTOR

MEGAN SANDBERG-ZAKIAN  
PLAYMAKING DIRECTOR

THE 52ND  
STREET  
PROJECT  
PRESENTS

WHAT'S  
THE BIG  
IDEA?

PLAYS TO THINK ABOUT  
THE SPRING 2005 PLAYMAKING SHOW



FRI., APRIL 1 AT 7:30 P.M. ● SAT., APRIL 2 AT 3:00 P.M. & 7:30 P.M. ● SUN., APRIL 3 AT 3:00 P.M.

THE MARY LEA JOHNSON PERFORMING ARTS CENTER AT  
THE CALHOUN SCHOOL

433 WEST END AVENUE (CORNER OF 81ST ST.)

# WHAT'S THE BIG IDEA?

Plays to Think About - April 1-3, 2005

The Mary Lea Johnson Performing Arts Center at the Calhoun School

## The 52nd Street Project Staff:

Gus Rogerson, Artistic Director  
Carol Ochs, Executive Director  
John Sheehy, Director of Development and Marketing  
Megan Sandberg-Zakian, Associate Artistic Director  
George "X-Acto" Babiak, Production Manager  
Liz Bell, Director of Education  
Diana Rojas, Executive Assistant  
Mayleen Cancel, Education Assistant  
Chris Ceraso, Teen Dean  
Iris A. Brown, Graphic Designer  
Solangee Acosta and Amelia Whitney, Receptionists  
Becca Masback and Rebecca Greig, Interns

## Production Staff

**Composer:** Greg Pliska  
**Musical Director:** Kim Sherman  
**Set Designer:** Kevin Joseph Roach  
**Lighting Designer:**  
Greg MacPherson  
**Costume Designer:**  
Crystal Thompson  
**Costume Building Crew:**  
Claudia Diaz, Emily Gainfield,  
Christine Szczepanski, and Scott  
Copeck  
**Sound Designer:** Maury Schott  
**Stage Manager:**  
Jean Marie Donnelly  
**Slide Designers:**  
George Babiak, Sandra Barron,  
Chris Bonanos, Todd Levin,  
Katherine Lumb, Mike Sell,  
John Steward, Alberta Testanero

**Prop Design Team:**  
George Babiak, Krysti Eigenberg,  
Rebecca Greig, Becca Masback,  
Lee Rosen.  
**Furniture Crew:**  
Rebecca Greig, Luis Maldonado,  
Christopher Ramirez  
**Prop Crew:**  
Becca Masback, John Cuevas  
**Load-in and Light Hang Crew:**  
Ray Harold, Jeff LaGreca, Moira  
MacDonald, Gayle MacDonald,  
Anne O'Sullivan, Betsy Rhodes.  
**House Managers:**  
Karin Schall, Liz Flahive,  
Liz Bell

The Playmaking Program is made possible with public funds from The New York State Council on the Arts, a state agency, and the NEA. The 52nd Street Project is a member of Art/NY and a participant in the New Generations Program, funded by Doris Duke Charitable Foundation/The Andrew W. Mellon Foundation and administered by Theatre Communications Group, the national organization for the American Theater.



## COOL STUFF ON SALE!

Flyer Bars .....\$2.00, \$1.50 & \$1.00

*Shel Silverstein's "Fivey and Twoey" logo gear:*

Project Caps .....\$15.00

Project Mugs .....\$5.00

Project Pencil 3-pack .....\$1.00

Project Notebooks .....\$5.00

Thank you for coming to **WHAT'S THE BIG IDEA?**. If you are not on our mailing list (or if your address has changed), please fill out this form and give it to us on your way out or mail it to the address below. We would also like to know if you are interested in becoming a volunteer. We need help in **all areas**, so be sure to fill out the entire form.

### PLEASE ADD ME TO YOUR MAILING LIST:

04/05

NAME: \_\_\_\_\_

ADDRESS: \_\_\_\_\_

ZIP \_\_\_\_\_

HOME PHONE: \_\_\_\_\_

DAYTIME PHONE: \_\_\_\_\_

E-MAIL ADDRESS: \_\_\_\_\_

MY OCCUPATION: \_\_\_\_\_

MY HOBBIES: \_\_\_\_\_

### YES, I WOULD LIKE TO BE OF HELP. I CAN:

- |   |   |  |
|---|---|--|
| <input type="checkbox"/> Help load in and out for shows | <input type="checkbox"/> Draw and/or paint  | <input type="checkbox"/> Help kids with homework |
| <input type="checkbox"/> Hang lights                    | <input type="checkbox"/> Help with mailings | <input type="checkbox"/> Teach kids a skill      |
| <input type="checkbox"/> Work on a backstage crew       | <input type="checkbox"/> Do office work     | <input type="checkbox"/> Be a chef at an event   |
| <input type="checkbox"/> Do graphic design              | <input type="checkbox"/> Design sound       | <input type="checkbox"/> Design and sew costumes |
| <input type="checkbox"/> Other (please specify) _____   |   |  |

### MY SCHEDULE IS:

- Very flexible. I'm often available during weekdays.  
 Somewhat flexible. I can help on the occasional morning or afternoon during the week.  
 Not very flexible at all, but I've got some free time on evenings and weekends.

If you would like to mail this (and you're always welcome to enclose a tax-deductible contribution), you can send it to: **The 52nd Street Project**, 500 West 52nd St., New York, NY 10019. Or fax it to (212) 333-5598.

## Don't Miss Our Upcoming Shows!

Hank Azaria and Oliver Platt invite you to Save the Date, and possibly the World at...

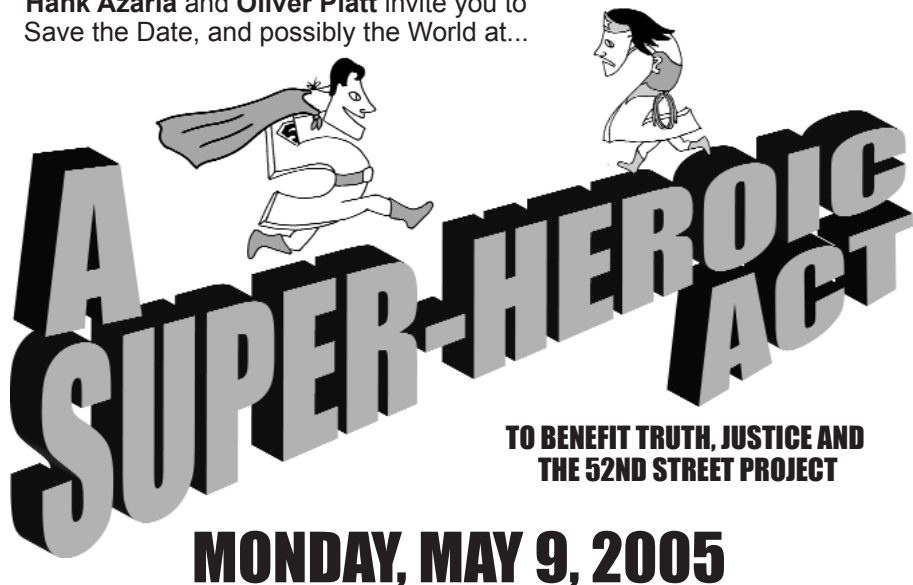

TO BENEFIT TRUTH, JUSTICE AND  
THE 52ND STREET PROJECT

**MONDAY, MAY 9, 2005**

For reservations or info call John "The Thing" Sheehy @ 212/333-5252

### William Shakespeare's **Measure for Measure**

Adapted by the teens of The 52nd Street Project  
Directed by Megan Sandberg-Zakian

#### ***Bi-Continental Tour!***

June 25 - NEW YORK CITY - The Axis Theater  
July 1 - LORGUES, FRANCE - Chateau de Berne



## **HOLIDAYS IN THE SUN** **THE BLOCK ISLAND PLAYS**

*THE 2005 ONE-ON-ONES*

*KIDS AND ADULTS ON STAGE TOGETHER!*

**JULY 21-24, THE ENSEMBLE STUDIO THEATER**

The 52nd Street Project is a non-profit organization that brings children from the Hell's Kitchen neighborhood together with professional theater artists to create original theater. **What's The Big Idea?** is a production of our Playmaking program. Young people participate in a nine-week playwriting course taught by Megan Sandberg-Zakian and adapted for the Project by Daniel Judah Sklar from his book *Playmaking: Children Writing and Performing Their Own Plays*. At the end of the course, each child is given two actors, a theme, and a dramaturg/director who guides him or her through the writing of a play during a weekend retreat in the country (Kent, Connecticut, for this show). Tonight's performance is the end result.

### **The 52nd Street Project Board of Directors**

Ben Barenholtz  
Lisa Benavides  
Rachel Chanoff  
Cathy Dantchik  
Noël Dawkins  
Wendy Ettinger,  
*chair emeritus*  
Louis P. Friedman  
Stephen Graham, *chair*  
Larry Jones  
James McDaniel  
Frances McDormand  
Patricia M. Murphy, Esq.

Carol Ochs  
Willie Reale,  
*founder*  
Gus Rogerson  
Shirley Rumierk,  
*alumni member*  
José Soto, Jr.,  
*alumni member*  
Pamala Tyson  
Laura Valeroso  
Wendy vanden Heuvel  
John A. Vassilaros  
Jenny Wiener

### **Special Thanks**

We're grateful to **Stephen, Cathy, Juliet, and Tommy Graham** for graciously allowing us to bring the chaos of a Playmaking weekend to their lovely home in Kent, Connecticut. Their staff gets a round of applause, too. Thanks also go to **Sam and Lynn Waterston, and Emily Armstrong and Kevin Patrick Gannon** for providing accommodations. Thanks also to **Chris Varmouse** for helping out in Playmaking class.

### **In-Kind Contributions**

The Murphy Law Office; Benefit Cosmetics; Iris A. Brown; Bourjois Paris; Bumble and bumble; Ron Kastner and Capital Printing; Kenneth Cole Productions; Noggin; The Printing Store; Scholastic, Inc.; Diageo Chateau & Estate Wines; Entertainment Weekly; Lucky Magazine; Microtouch/Finishing Touch; Molten Brown; MOP Cosmetics; Newman's Own; Pharma Print/Omni Graphics; Sesame Workshop; Wendy Stuhlberg; Terax America; John A. Vassilaros; Watkins, Inc.; Mayor's Office of Film & Television; Boylan's Bottling Co.; Steve Jenkins, David Sneddon & Fairway Market; Lorraine Tobias & Imaginary Studios; Jive Records, part of Zomba Music Group; and Prime Films.

## WHAT'S THE BIG IDEA? - ACT I

All original music composed by Greg Pliska (except where noted)

### **Nerdy Nerd and the Princess of Life**

by Stephanie Marion, age 9. Dramaturg/Director: Evan Cabnet

Princess .....Lois Smith  
Nerdy Nerd .....Joel de la Fuente  
Students .....The Crew

*"We Should be Friends"* lyrics by Stephanie Marion

### **Godzilla Meets Anaconda**

by Laron Holt, age 9. Dramaturg/Director: Reg Flowers

Anaconda .....Martin Moran  
Lize .....Marva Hicks  
Godzilla .....George Babiak

*"Burn You"* lyrics by Laron Holt

### **Broadway Miracle**

by Jenisse Bouret, age 10. Dramaturg/Director: Liza Steinberg

Ellyse .....Sarah Petersiel  
Hopefull .....Nikki Philips  
Casting Director .....John Sheehy

*"This is My Dream," "Miracle," and "What's in the Heart"* lyrics by Jenisse Bouret

### **Good Vs. Evil**

by Malik Velasquez, age 10. Dramaturg/Director: Beatrice Terry

S.A.A.J. (aka Secret Agent A.J.) .....Lee Rosen  
E.S.A.C. (aka Evil Secret Agent Christina) .....Sharon Washington  
Unconscious Cops .....Luis Maldonado & John Cuevas  
Alien Pet .....Rebecca Greig

*"Jet Pack Song"* lyrics by Malik Velasquez.

### **Fighters**

by George Keller, age 9. Dramaturg/Director: George Babiak

Tom .....Matt Saldivar  
Ishmael .....Stevie Ray Dallimore  
Brother .....John Sheehy  
Sister .....Becca Masback

*"The Stupid Mistakes"* lyrics by George Keller, music by Matt Saldivar and Stevie Ray Dallimore.

## WHAT'S THE BIG IDEA? - ACT II

### **One Sister Jealousy**

by Luisa Santiago, age 9. Dramaturg/Director: Zakiyyah Alexander

April .....Marsha Stephanie Blake  
Jenny .....Pascale Armand

*"Sisters"* lyrics by Luisa Santiago

### **Rony Makes Friends with His Own Predator**

by Analis "Fifi" Fernandez, age 9.

Dramaturg: Mayleen Cancel Director: Gus Rogerson

Rony .....Ephraim Lopez  
Dougless .....Lee Briggs  
Father .....Christopher Ramirez

*"River Song"* and *"Dougless Confesses"* lyrics by Analis Fernandez

### **Day After Day**

by Joyce Cheung, age 9. Dramaturg/Director: Julia Gibson

Amy .....Kathy Hiler  
Snow Ball .....Johanna Day  
Mom .....Becca Masback

*"Snow Ball's Life"* and *"The Happiest Day for Amy"* lyrics by Joyce Cheung

### **The Giraffe King**

by Marcus Quinones, age 9. Dramaturg/Director: Joe White

Bernie the Elephant .....Ray Harold  
Frank the Giraffe .....Arthur French

### **Brother vs. Sister**

by Amoro Pargas, age 10

Jason .....Paco Tolson  
Maria .....Kari Swenson Riely

*"I Hate My Sister"* and *"You Would Always Be My Brother and Sister"* lyrics by Amoro Pargas.

# INTERMISSION



*Honorary Chairs*  
Hank Azaria and Oliver Platt  
*and Corporate Hosts*  
Ars Nova  
Louis Friedman/Bear Stearns  
Tobak-Dantchik Events  
*and the Board of Directors of*  
*The 52nd Street Project present*

# A SUPER-HEROIC ACT

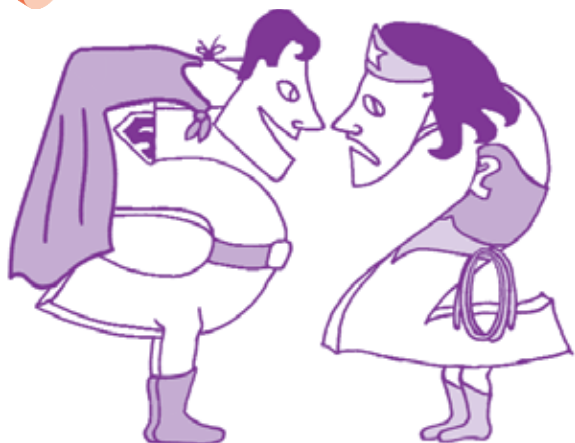

**MONDAY MAY 9, 2005**  
**AT CAPITALE**

**BOARD CHAIR**

Stephen Graham

**EXECUTIVE DIRECTOR**

Carol Ochs

**ARTISTIC DIRECTOR**

Gus Rogerson

## CO-CHAIRS

Lisa Benavides  
Becky Browder  
Cathy Dantchik  
Louis P. Friedman  
Patrice Friedman

Jenny Gersten  
Karin Schall  
Laura Valeroso  
Mary Pat Walsh  
Jenny Wiener

## THE BOARD OF DIRECTORS

Ben Barenholtz  
Lisa Benavides  
Rachel Chanoff  
Cathy Dantchik  
Wendy Ettinger,  
*chair emeritus*  
Louis P. Friedman  
Stephen Graham, *chair*  
Larry Jones  
James McDaniel  
Frances McDormand  
Noël Mihalow

Patricia M. Murphy, Esq.  
Carol Ochs  
Willie Reale, *founder*  
Gus Rogerson  
Shirley Rumierk,  
*alumni member*  
José Soto, Jr.,  
*alumni member*  
Pamala Tyson  
Laura Valeroso  
Wendy vanden Heuvel  
John A. Vassilaros

Jenny Wiener

## THE 52ND STREET PROJECT GRATEFULLY ACKNOWLEDGES...

Iris A. Brown  
Bumble and bumble  
Capital Printing/Ronald J. Kastner  
Kenneth Cole Productions  
Diageo Chateau & Estate Wines Co.  
Entertainment Weekly  
Jive Records  
*A division of Zomba Music Group*  
Lucky Magazine  
MAC  
Newman's Own  
Noggin/The N  
Pharma/Omni Printing  
Sesame Workshop  
Wendy Stulberg  
John A. Vassilaros & Sons  
Watkins Incorporated  
*Healthier Living Since 1868*

## THE PROJECT SHOW CAST

### CAST OF CHARACTERS

Aphorisma . . . . .Martha Plimpton  
Redunda . . . . .Kayelani Silva  
Captain Gesundheit . . . . .Oliver Platt  
Hanky . . . . .Zebulun Santiago  
Harpy . . . . .Sara Ramirez  
Foresight . . . . .Hera Andre-Bergmann  
The Stickler . . . . .Michael Stuhlbarg  
Nit Pick . . . . .Jason Peterson Ridge

### DIRECTED BY

Jonathan Bernstein

### WRITTEN BY

Willie Reale &  
John Sheehy

### MUSIC BY

Kim D. Sherman

### PERCUSSION

Anton Fig

### LYRICS BY

Willie Reale

### SET DESIGN AND CONSTRUCTION

George Babiak

### LIGHTING DESIGN

Greg MacPherson

### COSTUME DESIGN

Crystal Thompson

### SOUND DESIGN

Kristyn Smith

### STAGE MANAGER

Karen Munkel



## **CAPED CRUSADERS**

Arthur Dantchik  
Cathy Dantchik  
Wendy Ettinger & Derek McLane  
Patrice & Louis Friedman, Bear Sterns  
Cathy & Stephen Graham  
Jenny Wiener & Jon Steingart, Ars Nova  
Joanne Woodward & Paul Newman  
Jeff Yass

## **MASKED AVENGERS**

Brunswick Group LLC  
Frances McDormand & Joel Coen  
Clea Newman

## **LOYAL SIDEKICKS**

Amy Friedman, Noggin/The N  
Alexandra Gersten-Vassilaros &  
Johnny Coffeeshopolis  
The Saul Horowitz Jr. Fund  
Lloyds TSB Bank  
Noël & Joe Mihalow, The Dawkins  
Family Foundation  
Fred Nelson  
Lauren Seikaly & Michael Huber  
Sesame Workshop  
Showtime Networks Inc.  
Laura Valeroso & David Seidman  
Wendy vanden Heuvel  
Dr. Mildred Collier Walton  
Weil, Gotshal & Manges LLP

## **LONE CHAMPIONS**

Anonymous  
Howard Chatzinoff  
Tricia Cooke & Ethan Coen  
Leslie Dantchik  
Frank Frattaroli  
Robert C. Feldman  
Sarah Horowitz & David Venarde  
Anne Jackson & Eli Wallach  
LaTonya & Samuel L. Jackson  
Sy Jacobs  
Andrea Johnson  
Kristen Johnston  
Jane Kaczmarek  
Robert Sean Leonard

Marjorie & Michael Loeb  
Peter Manning & Andre Bishop  
Audrey & Danny Meyer  
Josephine Merck & Jim Stevenson  
Jane Musky & Tony Goldwyn  
Jane Perlmutter & Greg MacPherson  
Lise Rehwaldt & Mark Roberts  
Anita A. & David S. Rogerson  
Steve Sabba  
Simone Silverman & George Xenos  
Jane & R.L. Stine  
Laura Valeroso & David Seidman  
Yildiz Yuksek & Richard Blackstone

## **GOODIE TWO-SHOES**

Anonymous	Patricia Dunnock & Ned Eisenberg
Alexis Alexanian	Barbara Fleck-Paladino & Joseph Paladino
Dean Adrian	Katherine Freedman & Brian Bierne
Cecilia Arana-Grant & Dr. Kevin Grant	Rose Gasner & Larry Chertoff
Emily Armstrong & Thomas Patrick Gannon	Jenny Gersten & Willie Reale
Brooks Ashmanskas	Jilian Cahan Gersten
Becky Ann & Dylan Baker	Ileen Getz & Mark Grinnell
Ben Barenholtz	Nancy Giles
Lisa Benavides & Tim Blake Nelson	Connie Grappo & Lee Wilkof
Stephanie Berger & Paul King	Michael Greif & Jonathan Fried
Stephen Bernstein	Lisa J. Gugenheim & Lawrence Nathanson
Lewis Black	John Hazard
Jane Bolster & Steve Wertimer	Nina Hellman & Jeremy Shamos
Lynne & Roger Bolton	Amy Herzig
Buzz Bovshow	Marin Hinkle & Randall Sommer
Kathy Briggs & Matthew Hobbs, Dramatists Play Service	Katy Homans & Paterson Sims
Becky Browder & Ted Neustadt	Pat Ivers
Susan Bruce & Peter Hedges	Dana Ivey
Michelle Buffington	Bonnie Kantor
Denise Burse & Peter Jay Fernandez	Cynthia Kaplan & David Froelich
Colleen Carroll & Mitchell Semel	Mary Kong
Alfred C. Cerullo III	John Conlee
Rachel Chanoff	Judy Kuhn & David Schwab
Sharon Chantiles	Mickey Lemle
David Copeland	Liza Lerner
Maddie Corman & Jace Alexander	Howard Levi
Dr. Bill Coury & Martin Fetner	Aimee Levine
Paula Devicq	Ilana Levine, Dominic Fumusa & Georgia Fumusa
Rebecca & Richard Dresser	Anna Li
Moira Driscoll & David Pence	

Lorraine Lopezzo	Marcia Santoni & John Morris
D.J. Martin	Sandra Santoni
Sonya Martin & Michael Bornheimer	Karin & Thomas Schall
Nina & Robert Matza	Robin Schanzenbach
Brigid McCarthy	Maury Schott
Barbara McCrane & Paul Reale	Dana Segal
Rick Meese & Dan Lori	Stephanie Sharis
Robin Morse & Gus Rogerson	Sylvia Shepard & Will Holtzman
Suzen Murakoshi & Mark Temme	Lois Smith
Patricia Murphy & Adam Spilka	Abbot Stranahan & David Ward
Jacki Ochs & Jan Kroeze	Tracy Straus
Elise Pettus	Susanna Styron & Darrell Larson
Susan Ochs Phillips	Edith Thurber & Kevin O'Rourke
Judy & Michael Pillinger	Karen Trott & Peter Herdrich
Christopher Randolph	Liz Tuccillo
Frank Ridge	Cynthia Vance & Bob Abrams
Tatiana Rutkowsky & Andrew Blackman	Susan J. Vitucci
Agnes & Arnold Sametz	Mary Pat Walsh
Laura Sametz & Anton Fig	Carol Whitesides
	Gary Winick
	Marc D. Zand

List current as of 5/3/05

## **THE 52ND STREET PROJECT STAFF**

Gus Rogerson, Artistic Director  
Carol Ochs, Executive Director  
John Sheehy, Dir. of Development and Marketing  
George Babiak, Production Manager  
Megan Sandberg-Zakian,  
Associate Artistic Director  
Liz Bell, Director of Education  
Mayleen Cancel, Education Assistant  
Diana Rojas, Executive Assistant  
Chris Ceraso, Teen Dean  
Iris A. Brown, Graphic Designer

## **BENEFIT VOLUNTEERS**

Perry McBain Daniel, Reg Flowers, Bryan Gmitter,  
Heather Gobbee, Andrew Kelsey, Becca Masback,  
Catherine Mueller, Doug Nervik, Kari Riely,  
Lee Rosen, Victoria Row, Kim D. Sherman,  
Charlie Tocantins, Vanessa Valdes,  
Ed Vassallo, Becky White, Kurt Wootton

## **SPECIAL THANKS**

Becky Browder, William Curran, Liz Flahive,  
Terry Fitzpatrick, Amy Friedman,  
Jenny Gersten, Mark Jacobs, John Laird,  
Barbara McCrane, Christopher Randolph,  
Karin & Tom Schall, Mary Pat Walsh

GUS ROGERSON, ARTISTIC DIRECTOR

CAROL OCHS, EXECUTIVE DIRECTOR

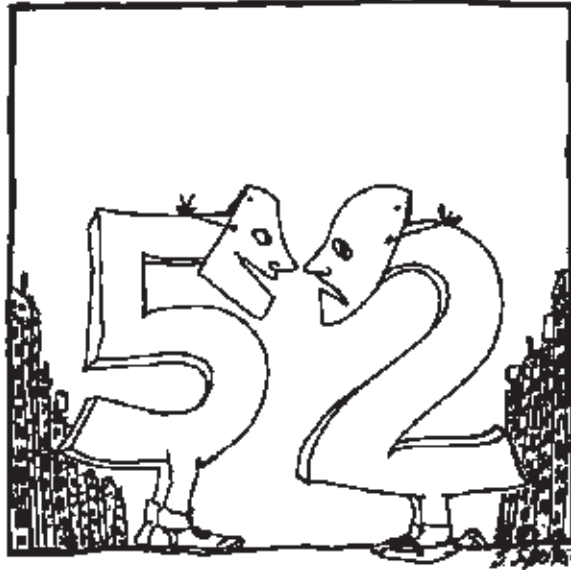

## The 52nd Street Project

*The following foundations and government agencies have generously supported the Teen Program through their contributions:*

City of New York Department of Cultural Affairs  
Max and Victoria Dreyfus Foundation  
Horace W. Goldsmith Foundation  
National Endowment for the Arts  
New York State Council on the Arts  
The Surdna Foundation



The 52nd Street Project is a participant in the **New Generations Program**, funded by **Doris Duke Charitable Foundation/The Andrew W. Mellon Foundation** and administered by **Theatre Communications Group**, the national organization for the American theatre.



THE 52ND  
STREET  
PROJECT  
PRESENTS

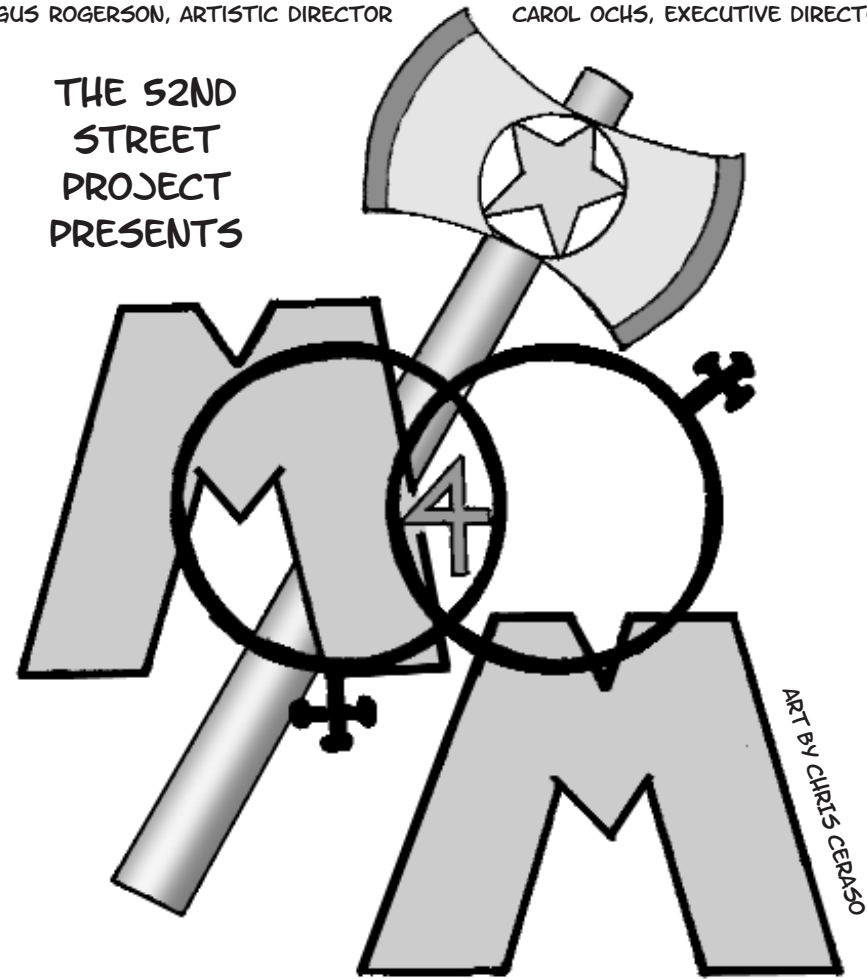

ART BY CHRIS CERASO

# MEASURE FOR MEASURE (MESURE POUR MESURE)

BY WILLIAM SHAKESPEARE

DIRECTED BY  
MEGAN SANDBERG ZAKIAN

ADAPTED BY CHRIS CERASO

AND THE 52ND STREET PROJECT TEEN ENSEMBLE  
NEW YORK CITY: JUNE 24 & 25 - THE AXIS THEATER  
LORGUES, FRANCE: JULY 1 - CHATEAU DE BERNE



### The 52nd Street Project

The 52nd Street Project (The Project) is dedicated to the creation and production of new plays for, and often by, kids between the ages of ten and eighteen who reside in the Hell's Kitchen neighborhood in New York City. The Project does this through unique mentoring programs that matches kids with professional (and volunteer!) theater artists.

The Project is about making children proud of themselves. The Project is not about teaching children to act, although they will learn to. It is not about teaching them to write plays, although they will learn that as well. What it is about is giving a kid an experience of success. It is about giving a kid an opportunity to prove that he or she has something of value to offer, something that comes from within that he or she alone possesses, something that cannot be taken away.

The Project's Teen Ensemble is the final step in the kids' training: a two-year acting class that culminates in the production of a full-length play by William Shakespeare, the very one you are seeing tonight. This year's show is being done in two countries. We are very grateful to our gracious European hosts for enabling this tour.

### Le Projet de la 52ème Rue

Le Projet de la 52ème Rue est consacré à la création et production de nouvelles pièces de théâtre écrites pour, et souvent par, des jeunes de neuf à dix-huit ans qui habitent le quartier de Hell's Kitchen (Cuisine de L'enfer) à New York. Le Projet apparie ces jeunes avec des artistes de théâtre professionnels qui leur servent de mentor.

Le Projet a pour but principal l'épanouissement de l'amour-propre des enfants. Ce n'est pas une école de théâtre, bien que les enfants deviennent souvent de très bons comédiens et auteurs dramatiques. Le Projet vise plutôt à créer une ambiance dans laquelle l'enfant peut ressentir ce que c'est de réussir. En donnant aux enfants l'occasion de s'exprimer, le Projet les encourage à reconnaître qu'ils ont une voix unique, qu'elle a de la valeur, et qu'elle mérite d'être entendue.

L'Ensemble Adolescent du Projet représente la dernière étape dans la formation des jeunes: un cours de théâtre de deux ans sur l'art de jouer la comédie, menant à la production de la pièce de William Shakespeare à laquelle vous allez assister ce soir. C'est de loin la production la plus ambitieuse que nous avons montée. Elle sera jouée dans deux pays. Nous remercions nos hôtes Européens pour leur générosité, sans laquelle cette tournée n'aurait pas été possible.

## THE CAST - L'ENSEMBLE

Duke Vincentio	.....	Reg Flowers
Escalus	.....	Nadya Jabour
Angelo	.....	Rebecca White
Lucio	.....	Christina Ramirez
Dopey	.....	Rebecca White
Huey	.....	Diana Rojas
Mistress Overdone	.....	Amelia Whitney
Claudio	.....	Amelia Whitney
Provost	.....	Diana Rojas
Friar Peter	.....	Diana Rojas
Isabella	.....	Leah Galimidi
Sister Francisca	.....	Nadya Jabour
Elbow	.....	Christina Ramirez
Pompey	.....	Leah Galimidi
Froth	.....	Amelia Whitney
Juliet	.....	Christina Ramirez
Mariana	.....	Amelia Whitney
Abhorson	.....	Leah Galimidi
Barnardine	.....	Nadya Jabour

Directed by Megan Sandberg-Zakian

Costume design by Naomi Wolff

Musical direction by Rebecca White

Choreography by Megan Cramer

Program and summary translations by Alex Draper

The 52nd Street Project thanks Randy, Jeff, Brian, Jared,  
and all the other kind folks at the Axis Theatre.

We are also indebted to Bill Muddyman,  
Jane Muddyman-Heine, Jean-Yves,  
Annie, and the Staff of the Château de Berne.

The 52nd Street Project is a non-profit organization that brings children from the Hell's Kitchen neighborhood together with professional theater artists to create original theater. The Replay program gives children who are graduates of the Project's Playmaking class a chance to hone their skills in an advanced writing workshop taught by **Megan Sandberg-Zakian** and **Reg Flowers**. Over the nine weeks of Replay class, these young playwrights explored varied sources of inspiration, including a visit to the Whitney Museum and a trip to the theater, studied dramatic structure, and learned to embrace the dreaded rewrite. The resulting plays are featured in tonight's reading.

### The Project Staff

Gus Rogerson . . . . . Artistic Director  
 Carol Ochs . . . . . Executive Director  
 John Sheehy . . . . . Director of Development  
 Megan Sandberg-Zakian . . . . . Associate Artistic Director  
 George Roman Babiak . . . . . Production Manager  
 Liz Bell . . . . . Director of Education  
 Diana Rojas . . . . . Executive Assistant  
 Chris Ceraso . . . . . Teen Dean  
 Iris A. Brown . . . . . Graphic Designer  
 Solangee Acosta, Amelia Whitney . . . . . Receptionists  
 Li Cornfeld, Anikke Fox, Becca Masback . . . . . Interns

### The 52nd Street Project Board of Directors

Ben Barenholtz  
 Lisa Benavides  
 Rachel Chanoff  
 Cathy Dantchik  
 Noël Dawkins  
 Wendy Ettinger,  
*chair emeritus*  
 Louis P. Friedman  
 Stephen Graham, *chair*  
 Larry Jones  
 James McDaniel  
 Frances McDormand  
 Patricia M. Murphy, Esq.

Carol Ochs  
 Willie Reale,  
*founder*  
 Gus Rogerson  
 Shirley Rumierk,  
*alumni member*  
 José Soto, Jr.,  
*alumni member*  
 Pamala Tyson  
 Laura Valeroso  
 Wendy vanden Heuvel  
 John A. Vassilaros  
 Jenny Wiener

The 52nd Street Project Presents  
 The Third Annual

# Replay Reading

10 new plays by  
 10 young playwrights

Monday, June 6, 2005  
 7:30 p.m.

Playwrights Horizons  
 Mainstage Theater  
 416 West 42nd St.



The Playmaking Program is made possible with public funds from The New York State Council on the Arts, a state agency; and the New York City Department of Cultural Affairs. The 52nd Street Project is supported by funds from the National Endowment for the Arts, the Department of Youth and Community Development. The Project is member of ART/NY and a participant in the New Generations Program, funded by Doris Duke Charitable Foundation/The Andrew W. Mellon Foundation and administered by Theatre Communications Group, the national organization for the American Theater.



## What Can Happen When a Kid Watches T.V.

by Emmett Goodman Boyd, age 10.

Directed by John Steber

Mad Scientist .....George Babiak  
Fred's Mom .....Victoria Row  
Channel .....Nancy Giles  
Fred .....Peter Jacobson  
Fred's Friend .....Becca Masback

## My Money

by Lordan Ulloa, age 10.

Directed by Danny Goldstein

Pico .....David Costabile  
Jaylin .....Emilio Delgado  
Jake .....Chris Varmus

## Hate and Love

by Catherine Fernandez, age 11.

Directed by Lizzie Gottlieb

Ellen .....Caroline Clay  
Taurence .....Lizzy Cooper Davis

## Why Why Why

by Muhammad Cunningham, age 11.

Directed by Megan Sandberg-Zakian

Juggles .....Kevin Geer  
Josephine .....Deirdre O'Connell

## A Family Legend

By Dale Fetterman, age 12.

Directed by Reg Flowers

Jason .....Michael Alexis Palmer  
Prodigy .....Nate Corddry  
Stone .....John Sheehy  
Announcer .....Reg Flowers  
Chad .....John Sheehy

## Bob's Transformation

by Pablo Maldonado, age 11.

Directed by Lizzie Gottlieb

Bob .....Caroline Clay  
Jow .....Lizzy Cooper Davis  
Jow's Dad .....Chris Varmus  
Bob's Dad .....Chris Varmus

## The Brotherhood of the Travelling Togas

By Hera Andre-Bergmann, age 10.

Directed by John Steber

Announcer .....Victoria Row  
Dianus .....Nancy Giles  
Marcellus .....Peter Jacobson  
Herculus .....George Babiak  
Athenus .....Becca Masback  
Mom .....Victoria Row

## The Fight

By Carlos Dume, age 11.

Directed by Danny Goldstein

ZaZoul .....David Costabile  
Roger .....Emilio Delgado

## The Big Argument

By Janiece Aponte, age 11.

Directed by Megan Sandberg-Zakian

Brittney .....Deirdre O'Connell  
Daniel .....Kevin Geer

## Let's Be Friends

By Jason Gil, age 10.

Directed by Reg Flowers

Atlas .....Michael Alexis Palmer  
Fix It .....Nate Corddry  
Wrench Man .....John Sheehy

**B  
R  
I  
E  
F  
  
I  
N  
T  
E  
R  
M  
I  
S  
S  
I  
O  
N**

The 52nd Street Project gratefully acknowledges the support of the following foundations and corporations: Stephen & Mary Birch Foundation, Brunswick Group L, Capital Research Company, Carnegie Corporation of New York, CBS, Citigroup Foundation, Cityrest, LLC, Comedy Central, Consolidated Edison, The Dramatists Guild Fund, Dramatists Play Service, The Fan Fox & Leslie R. Samuels Fdn., Fox Hollow Technologies, Inc., The Horace W. Goldsmith Foundation, The Henlopen Foundation, Lloyds TSB Bank plc, Lucille Lortel Foundation, James A. Macdonald Foundation, Ann M. Martin Foundation, Mellon Equity Associated, Llp, Newnan's Own, The New York Times Company Foundation, Noggin, People Places, Inc., Sesame Workshop, Showtime Networks Inc, St. Vincent De Paul Foundation, Stranahan Foundation, The Surdna Foundation, Theatre Communications Group, Inc., John A. Vassilaros & Son, Inc., The Vervane Foundation, Weil, Gotshal & Manges Llp, Felix Zaremka & Co. Inc., Zombahn addition the following individuals made gifts of over \$250 to The 52nd Street Project this past year (list is current as of 7/01/05):

Robert Abrams & Cynthia Vance	Katherine Freedman	Doda Manalansan	Lauren Seikaly & Michael Huber
Jace Alexander & Maddie Corman	Louis & Patrice Friedman	Peter Manning & André Bishop	Mitchell Semel & Colleen Carroll
Alexis Alexanian	Rose Gasner & Larry Chertoff	Sonya Martin	Mitchell Silverman
Lawrence Alletto	John A. Vassilaros	Robert Matza & Nina Matza	Simone Silverman
Cecilia Arana-Grant & Kevin Grant	& Alexandra Gersten-Vassilaros	Fran McDormand & Joel Coen	Landon Slane
Emily Armstrong	Kilty Gilmour	Rick Meese & Dan Lori	Jean Stein
Ben Barenholtz	Tony Goldwyn & Jane Musky	Josie Merck & Jim Stevenson	Barclay Stiff
Jessica Bauman	Stephen & Cathy Graham	Audrey & Danny Meyer	Ben & Christine Stiller
Lisa Benavides & Tim Nelson	Connie Grappo & Lee Wilkof	Noël & Joe Mihalow	R.L. Stine & Jane Stine
Stephanie Berger & Paul King	Myrna & Stephen Greenberg	Suzen Murakoshi & Mark Temme	Susanna Styron & Darrell Larson
Alexander & Elizabeth Bernstein	Michael Greif & Jonathan Fried	Patricia M. Murphy, Esq.	Brian Swardstrom
Lewis Black	Emily Grishman & Susan Sampliner	& Adam Spilka	& Bonnie Bemstein
Andrew Blackman	Lisa Gugenheim & Larry Nathanson	Fred Nelson	Richard Sweren
& Tatiana Rutkowski	Nina Hellman & Jeremy Shamos	Randy & Rona Nelson	Leonard Tow
Richard Blau	Peter Herdrich & Karen Trott	James Neuberger	Liz Tuccillo
Roger Bolton & Lynne Bolton	William Holtzman	& Helen Stambler	John Turturro & Katherine Borowitz
Becky Browder & Ted Neustadt	& S. Sylvia Shepard	Clea Newman	Laura Valeroso & David Seidman
Susan Bruce & Peter Hedges	Katy Homans & Patterson Sims	Kevin O'Rourke & Edith Thurber	Wendy vanden Heuvel
Cora Cahan & Bernard Gersten	Sarah Horowitz & David Venarde	Carol Ochs & Bruce MacVittie	& Brad Coley
Rachel Chanoff	Saul Horowitz	Jacki Ochs & Jan Kroeze	Ed Vassallo
Howard Chatzinoff	Anne & Eli Jackson	Elizabeth Peters	John A. Vassilaros & Alexandra
John Ellison Conlee	LaTanya & Samuel Jackson	Bat-Sheva & Thomas Peters	Gersten- Vassilaros
Tricia Cooke & Ethan Coen	Sy Jacobs	Judy Goldman & Michael Pillinger	Claudia Wagner
Arthur Dantchik	Andrea Johnson	Peter & Helen Randolph	Mary Pat Walsh
Cathy Dantchik	Kristen Johnston	Paul Reale & Barbara McCrane	Borah & Mildred Walton
Leslie Dantchik	Larry & Mary Jones	Willie Reale & Jenny Gersten	Lynn & Sam Waterston
Sherry Davis & Mark Alhadeff	Jane Kaczmarek	Lise Rehwaldt & Mark Roberts	Sally & Lenny Weiss
Peter & Judith Dawkins	Cindy Kaplan	Julie Ridge	Jane Bolster & Steve Wertimer
Richard & Rebecca Dresser	Michelle Katz	David & Anita Rogerson	Jenny Wiener & Jon Steingart
Nora Ephron	Judy Kuhn & David Schwab	Shirley Rumierk	Michael & Zena Wiener
Heidi Ettinger	Stephen Lebovitz	Steve Sabba	Joanne Woodward & Paul Newman
Wendy Ettinger & Derek McLane	Robert Sean Leonard	Laura Sametz & Anton Fig	Jeffrey & Janine Yass
Robert Feldman	Liza Lerner	Marcia Santoni & John Morris	Mei Yueh Yen
Peter Jay Fernandez	Michael Loeb & Marjorie Loeb	Meredith Beeuwkes	
& Denise Burse	Greg MacPherson	Karin & Tom Schall	
Frank Frattaroli	& Jane Perlmutter	Maury Schott	

THE 52ND STREET PROJECT  
PRESENTS THE 2005  
HAROLD AND MIMI STEINBERG  
CHARITABLE TRUST ONE-ON-ONES



# HOLIDAYS IN THE SUN

## THE BLOCK ISLAND EDITION



JAMES STEVENSON

JULY 22-24, 2005  
**THE ENSEMBLE STUDIO THEATRE**  
549 WEST 52ND ST.  
NEW YORK CITY

# HOLIDAYS IN THE SUN

THE 2005 BLOCK ISLAND  
ONE-ON-ONES  
JULY 22-24  
THE ENSEMBLE  
STUDIO THEATRE



## The 52nd Street Project Staff:

Gus Rogerson, Artistic Director  
Carol Ochs, Executive Director  
John Sheehy, Director of Development and Marketing  
Reg Flowers, Associate Artistic Director  
George "X-Acto" Babiak, Production Manager  
Liz Bell, Director of Education  
Diana Rojas, Executive Assistant  
Mayleen "Star" Cancel, Education Assistant  
Chris Ceraso, Teen Dean  
Iris A. Brown, Graphic Designer  
Solangee Acosta & Amelia Whitney, Receptionist  
Interns: Li Cornfeld, Anikke Fox

## Production Staff

### Composer:

Kim D. Sherman

### Set Designer:

Kevin Joseph Roach

### Lighting Designer:

Greg MacPherson

### Costume Designer:

Lora Lavon

### Goddess of Sound:

Vanessa Valdes

### Stage Manager:

Allison Kyle

### Slide Design Team:

George Babiak, Liz Bell, Angel Desai, Reg  
Flowers, Lee Rosen, John Sheehy

### Prop Design Team:

George Babiak, Li Cornfeld, Angel Desai,  
Reg Flowers, Nedra Gallegos, Allison Kyle,  
Sascha Paladino and Erin Tomeo, Lee  
Rosen, John Sheehy

### Holidays in the Sun Illustration:

James Stevenson

### Furniture Crew:

Anikke Fox, Leah Galimidi

### Prop Crew:

Li Cornfeld, Amelia Whitney

### Load-in and Light-hang Crew:

Li Cornfeld, Angel Desai, Anikke Fox,  
Allison Kyle, Lee Rosen, Tom Schall

### House Manager:

Karin Schall

### Chefs:

Pat Ritter and Martha Velie-Gass

### Teen Counselors:

Leah Galimidi and Amelia Whitney

## COOL STUFF ON SALE IN THE LOBBY!

The Fabulous Flyer Bar . . . . . \$2, \$1.50 & \$1  
and featuring Shel Silverstein's "Fivey and Twoey" logo:  
Project T-shirts (NEW Design) . . . . . \$12.00  
Project Tank Tops (NEW Girls' Design) . \$12.00  
Project Caps (NEW design) . . . . . \$15.00  
Project Mugs (now in BLUE!) . . . . . \$5.00  
Project Pencil 3-pack (now in RED!) . . . . \$1.00  
Project Notebook (New Item) . . . . . \$5.00

Thank you for coming to **HOLIDAYS IN THE SUN!** If you are not on our mailing list (or if your address has changed), please fill out this form and give it to us on your way out or mail it to the address below. We would also like to know if you are interested in becoming a volunteer. We need help in **all areas**, so be sure to fill out the entire form.

### PLEASE ADD ME TO YOUR MAILING LIST:

7/05

NAME: \_\_\_\_\_

ADDRESS: \_\_\_\_\_

ZIP \_\_\_\_\_

HOME PHONE: \_\_\_\_\_

DAYTIME PHONE: \_\_\_\_\_

E-MAIL ADDRESS: \_\_\_\_\_

MY OCCUPATION: \_\_\_\_\_

MY HOBBIES: \_\_\_\_\_

### YES, I WOULD LIKE TO BE OF HELP. I CAN:

- |   |   |  |
|---|---|--|
| <input type="checkbox"/> Help load in and out for shows | <input type="checkbox"/> Draw and/or paint  | <input type="checkbox"/> Help kids with homework |
| <input type="checkbox"/> Hang lights                    | <input type="checkbox"/> Help with mailings | <input type="checkbox"/> Teach kids a skill      |
| <input type="checkbox"/> Work on a backstage crew       | <input type="checkbox"/> Do office work     | <input type="checkbox"/> Be a chef at an event   |
| <input type="checkbox"/> Do graphic design              | <input type="checkbox"/> Design sound       | <input type="checkbox"/> Design and sew costumes |
| <input type="checkbox"/> Other (please specify) _____   |   |  |

### MY SCHEDULE IS:

- Very flexible. I'm often available during weekdays.  
 Somewhat flexible. I can help on the occasional morning or afternoon during the week.  
 Not very flexible at all, but I've got some free time on evenings and weekends.

If you would like to mail this (and you're always welcome to enclose a tax-deductible contribution), you can send it to: **The 52nd Street Project**, 500 West 52nd St., New York, NY 10019. Or fax it to (212) 333-5598.



The One-on-Ones Program is made possible with public funds from The New York State Council on the Arts, a state agency; and the New York City Department of Cultural Affairs. The 52nd Street Project is supported by funds from the National Endowment for the Arts, the Department of Youth and Community Development. The Project is member of ART/NY and a participant in the New Generations Program, funded by Doris Duke Charitable Foundation/The Andrew W. Mellon Foundation and administered by Theatre Communications Group, the national organization for the American Theater.



## Don't Miss Our Upcoming Shows!



THE WAREHAM, MASS.  
ONE-ON-ONES

10 NEW KIDS!  
10 NEW ADULTS!  
10 NEW PLAYS!  
SAME OLD  
THEME!

AUG. 18-21

RIGHT HERE AT THE  
ENSEMBLE STUDIO  
THEATRE

The 52nd Street Project is a non-profit organization that brings children from the Hell's Kitchen neighborhood together with professional theater artists to create original theater. **HOLIDAYS IN THE SUN** is a production of our One-on-One program, which is designed to give children the opportunity to go away for one-week stays in the country and enjoy the undivided attention of a professional theater artist who serves as friend, mentor, and collaborator. The Project is delighted to return to the Ensemble Studio Theatre, where we have been performing since our inception in 1981. We gratefully acknowledge the fact that if E.S.T. wasn't here, we'd be nowhere.

### The 52nd Street Project Board of Directors

Ben Barenholtz

Lisa Benavides

Rachel Chanoff

Cathy Dantchik

Noël Dawkins

Wendy Ettinger, *chair emeritus*

Louis P. Friedman

Stephen Graham, *chair*

Larry Jones

James McDaniel

Frances McDormand

Patricia M. Murphy, Esq.

Carol Ochs

Willie Reale, *founder*

Gus Rogerson

Shirley Rumierk, *alumni member*

José Soto, Jr., *alumni member*

Pamala Tyson

Laura Valeroso

Wendy vanden Heuvel

John A. Vassilaros

Jenny Wiener

## CHILL AND SERVE THE REVENGE PLAYS

The 2005 Playback Production, October, 2005

First a kid writes a short play. Then, an adult writes an "answer" play. Then, the two of them perform both plays. Multiply this equation by seven and you've got an entire show.

## OH NO YOU DIDN'T!

PLAYS THAT DO!

December, 2005

In September, 10 brand-new kids will begin a Playmaking class taught by **Reg Flowers**, our brand-new Project Playmaking Director. Come and see their final plays performed by adult professional actors.

### Special Thanks

Our Host Families – Sue Black; Nancy & John Doolittle; Josie Merck & Jim Stevenson; Theresa & Jack Sisto; Jennifer & Elliot Taubman; Ron & Judy Tierney; Joya Verde & Virginia Dare; and our headquarters host Dr. Christina Biaggi.

Sincere thanks to our chefs Pat Ritter & Martha Velie-Gass; Lynn Reale, Kate & everyone at Block Island Realty; Prudy, Jean and The Ice Cream Place; Rita & Steve Draper; Glenn & Annie Hall; McQuade's Market; Interstate Navigation; Sophia Ochs MacVittie; Jenny Ritter; Amanda Gass; Mary & John at Smuggler's Cove Sailing School; Amy Jaffe; Ed Berube; Amelia Gallant at the Block Island Grocery; Cindy & Stan Geer at the Depot; The Homans Family; Chuck the electrician; and Charlie Gale.

### In-Kind Contributions

Curt, John, Theresa, and everyone at the Ensemble Studio Theatre; the Murphy Law Office; Benefit Cosmetics; Iris A. Brown; Bourjois Paris; Bumble and bumble; Ron Kastner and Capital Printing; Kenneth Cole Productions; Noggin; The Printing Store; Scholastic, Inc.; Diageo Chateau & Estate Wines; Entertainment Weekly; Lucky Magazine; Microtouch/Finishing Touch; Molten Brown; MOP Cosmetics; Newman's Own; Pharma Print/Omni Graphics; Sesame Workshop; Wendy Stuhlberg; Terax America; John A. Vassilaros; Watkins, Inc.; Mayor's Office of Film & Television; Boylan's Bottling Co.; David Sneddon & Fairway Market; Lorraine Tobias & Imaginary Studios; Jive Records, part of Zomba Music Group; and Prime Films.



## HOLIDAYS IN THE SUN - ACT 1

All original music composed by Kim D. Sherman  
"Holidays In The Sun Theme Song" lyrics by John Sheehy

### JUST DESERT

Written & Directed by Perry Daniel for Hera Andre-Bergmann, age 11

Zora .....Hera Andre-Bergmann  
Daria .....Perry Daniel  
Vendher .....Amelia Whitney

"Sand Sonata" lyrics by Perry Daniel

### SNAKE-EYES AND MEATHEAD

Written & Directed by Lee Rosen for Jennifer Ramirez, age 11

Meathead Rabinowitz .....Lee Rosen  
Snake-Eyes Canseco .....Jennifer Ramirez  
Alfredo Fettuccine .....George Babiak  
Two prison guards .....Leah Galimidi and Amelia Whitney

"Breakout" lyrics by Lee Rosen

### HOLIDAYS AT SEA

Written by Neena Beber and Directed by Angel Desai for Malik Velazquez,  
age almost 10

Skipper .....Angel Desai  
Captain .....Malik Velazquez

"Rolling On" lyrics by Neena Beber

### THE FIERCE AND THE FABULOUS

Written by Reg Flowers and Directed by Diana Rojas for Carla Olivia, age 11

Sylvia Sleuth .....Diana Rojas  
Alexis Cunning .....Carla Olivia  
Dr. Revloni .....Reg Flowers

"Young and Pretty" lyrics by Reg Flowers

### THE HUSTLE

Written & Directed by Josh Lewis for Bryant Acosta, age almost 12

Rico .....Bryant Acosta  
Sonny .....Josh Lewis  
A Cop .....Leah Galimidi

"The Hustle 2005" lyrics & music by Josh Lewis

## HOLIDAYS IN THE SUN - ACT 2

### THE UNKINDEST CUT

Written and Directed by John Sheehy for Stephanie Vamvoukakis, age 11

Jerrold .....John Sheehy  
Stacy .....Stephanie Vamvoukakis

"The Hardest Thing" lyrics by John Sheehy

### SUAVE, SMOOTH, SUPERSPY

Written & Directed by Sascha Paladino for Jason Gill, age 10

Jimmy Blank .....Sascha Paladino  
Johnny Smiles .....Jason Gil  
Chief .....Li Cornfeld

"If You Wanna Be a Spy" lyrics by Sascha Paladino

### A SNOWFLAKE'S CHANCE IN H-E DOUBLE HOCKEY STICKS

Written by Erin Quinn Purcell & Directed by Melissa Jones  
for Samantha Toro, age 11

Flake .....Melissa Jones  
Snow .....Samantha Toro  
Starfish .....Leah Galimidi  
Santa .....George Babiak

"Christmas Tonight!" lyrics by Erin Quinn Purcell

### CLEOPATRA JAMES AND THE CURSE OF M'HEK'NA'HAY

Written by Adam Felber and Directed by Sarah Petersiel  
for Stephanie Marion, age 10

Dr. Cleopatra James .....Stephanie Marion  
Dr. Shirley Malmstein .....Sarah Petersiel  
Dr. Minky .....Reg Flowers  
Juan .....Andrew Kelsey  
The Excavettes .....Angel Desai, Josh Lewis, Lee Rosen

"We Dig It" lyrics by Adam Felber

### YOU COULD HAVE BEEN BETTER

Written by Willie Reale and Directed by Andrew Kelsey  
for Lordan Ulloa, age 10

Mike .....Lordan Ulloa  
Alec .....Andrew Kelsey  
Woman with document .....Li Cornfeld

"You Should Have Called Candy" lyrics by Willie Reale

Intermission!

The 52nd Street Project gratefully acknowledges the support of the following foundations and corporations: Stephen & Mary Birch Foundation; Brunswick Group LLP; Capital Research Company; Carnegie Corporation of New York; CBS; Citigroup Foundation; Cityrest, LLC; Clinton Seed Fund; Comedy Central; Consolidated Edison; The Dramatists Guild Fund; Dramatists Play Service; The Fan Fox & Leslie R. Samuels Foundation.; Fox Hollow Technologies, Inc.; The Horace W. Goldsmith Foundation; The Henlopen Foundation; Holland Lodge Foundation; Lloyds TSB Bank plc; Lucille Lortel Foundation; James A. Macdonald Foundation; Ann M. Martin Foundation; Mellon Equity Associated, LLP; Newman's Own; The New York Times Company Foundation; Noggin; People Places, Inc.; Sesame Workshop; Showtime Networks Inc; St. Vincent De Paul Foundation; Stranahan Foundation; The Surdna Foundation; Theatre Communications Group, Inc.; Tiger Baron Foundation; John A. Vassilaros & Son, Inc.; The Vervane Foundation; Weil, Gotshal & Manges LLP; Felix Zaremba & Co. Inc.; Zombaln addition the following individuals made gifts of over \$250 to The 52nd Street Project this past year (list is current as of 7/01/05):

Robert Abrams & Cynthia Vance	Louis & Patrice Friedman	Peter Manning & André Bishop	Mitchell Semel & Colleen Carroll
Jace Alexander & Maddie Coman	Rose Gasner & Larry Chertoff	Sonya Martin	Mitchell Silverman
Alexis Alexanian	John A. Vassilaros &	Robert Matza & Nina Matza	Simone Silverman
Lawrence Alieto	Alexandra Gersten-Vassilaros	Fran McDormand & Joel Coen	Landon Slane
Cecilia Arana-Grant & Kevin Grant	Scott & Laura Gewirtz	Rick Meese & Dan Lori	Jean Stein
Emily Armstrong	Kilty Gilmour	Josie Merck & Jim Stevenson	Barclay Stiff
Ben Barenholtz	Tony Goldwyn & Jane Musky	Audrey & Danny Meyer	Ben & Christine Stiller
Jessica Bauman	Stephen & Cathy Graham	Noël & Joe Mihalow	R.L. Stine & Jane Stine
Lisa Benavides & Tim Nelson	Connie Grappo & Lee Wilkof	Suzen Murakoshi & Mark Temme	Susanna Styron & Darrell Larson
Stephanie Berger & Paul King	Myrna & Stephen Greenberg	Patricia M. Murphy, Esq. & Adam Spilka	Brian Swardstrom & Bonnie Bernstein
Alexander & Elizabeth Bernstein	Michael Greif & Jonathan Fried	Don & Sara Nelson	Richard Sweren
Lewis Black	Emily Grishman & Susan Sampliner	Fred Nelson	Leonard Tow
Andrew Blackman & Tatiana Rutkowski	Lisa Gugenheim & Larry Nathanson	Randy & Rona Nelson	Liz Tuccillo
Richard Blau	Nina Hellman & Jeremy Shamos	James Neuberger & Helen Stambler	John Turturro & Katherine Borowitz
Roger Bolton & Lynne Bolton	Peter Herdrich & Karen Trott	& Helen Stambler	Laura Valeroso & David Seidman
Becky Browder & Ted Neustadt	William Holtzman	Clea Newman	Wendy vanden Heuvel & Brad Coley
Susan Bruce & Peter Hedges	& S. Sylvia Shepard	Kevin O'Rourke & Edith Thurber	Ed Vassallo
Cora Cahan & Bernard Gersten	Katy Homans & Patterson Sims	Carol Ochs & Bruce MacVittie	John A. Vassilaros & Alexandra Gersten- Vassilaros
Rachel Chanoff	Sarah Horowitz & David Venarde	Jacki Ochs & Jan Kroeze	Claudia Wagner
Howard Chatzinoff	Saul Horowitz	Elizabeth Peters	Mary Pat Walsh
Ronald Cohen	Anne & Eli Jackson	Bat-Sheva & Thomas Peters	Borah & Mildred Walton
John Ellison Conlee	LaTanya & Samuel Jackson	Judy Goldman & Michael Pillingner	Lynn & Sam Waterston
Tricia Cooke & Ethan Coen	Sy Jacobs	Peter & Helen Randolph	Sally & Lenny Weiss
Arthur Dantchik	Andrea Johnson	Paul Reale & Barbara McCrane	Jane Bolster & Steve Wertimer
Cathy Dantchik	Kristen Johnston	Willie Reale & Jenny Gersten	Jenny Wiener & Jon Steingart
Leslie Dantchik	Larry & Mary Jones	Lise Rehwaldt & Mark Roberts	Michael & Zena Wiener
Shery Davis & Mark Alhadeff	Jane Kaczmarek	Julie Ridge	Joanne Woodward & Paul Newman
Peter & Judith Dawkins	Cindy Kaplan	David & Anita Rogerson	Jeffrey & Janine Yass
Richard & Rebecca Dresser	Michelle Katz	Shirley Rumierk	Mei Yueh Yen
Nora Ephron	Judy Kuhn & David Schwab	Steve Sabba	
Heidi Ettinger	Stephen Lebovitz	Laura Sametz & Anton Fig	
Wendy Ettinger & Derek McLane	Robert Sean Leonard	Marcia Santoni & John Morris	
Robert Feldman	Liza Lerner	Meredith Beeuwkes	
Peter Jay Fernandez & Denise Burse	Michael Loeb & Marjorie Loeb	Karin & Tom Schall	
Frank Frattaroli	Grace Lyu-Volkhausen	Robert Schnur	
Katherine Freedman	Greg MacPherson & Jane Perlmutter	Maury Schott	
	Doda Manalansan	Lauren Seikaly & Michael Huber	

THE 52ND STREET PROJECT  
PRESENTS THE 2005  
WIENER FAMILY FOUNDATION  
ONE ON ONES



# HOLIDAYS IN THE SUN

THE WAREHAM, MASS. EDITION



JAMES STEVENSON

AUGUST 18-21, 2005  
THE ENSEMBLE STUDIO THEATRE  
549 WEST 52ND ST.  
NEW YORK CITY

# HOLIDAYS IN THE SUN

THE 2005  
WIENER FAMILY FOUNDATION  
WAREHAM, MASS. ONE-ON-ONES  
AUGUST 18-21  
THE ENSEMBLE STUDIO THEATRE

## The 52nd Street Project Staff:

Gus Rogerson, Artistic Director  
Carol Ochs, Executive Director  
John Sheehy, Director of Development and Marketing  
Reg Flowers, Associate Artistic "Cruise" Director  
George "X-Acto" Babiak, Production Manager  
Liz Bell, Director of Education  
Diana Rojas, Executive Assistant  
Mayleen "Star" Cancel, Education Assistant  
Chris Ceraso, Teen Dean  
Iris A. Brown, Graphic Designer  
Solangee Acosta & Amelia Whitney, Receptionist  
Interns: Li Cornfeld, Anikke Fox



## Production Staff

### Composer:

Patrick Barnes

### Set Designer:

Kevin Joseph Roach

### Lighting Designer:

Greg MacPherson

### Costume Designer:

Abby Taylor Redmond

### Sound Designer: Andrew Kelsey

### Sound Operator: Mayleen Cancel

### Stage Manager:

Karen Munkel

### Background Slide Designer:

Mike Sell

### Prop Design Team:

George Babiak, Liz Bell, Heather  
Camduff, Angel Desai, Anikke Fox, Karen  
Munkel, Matthew Ortiz, Lee Rosen, John  
Sheehy

### Holidays in the Sun Illustration:

James Stevenson

### Furniture Crew:

Li Cornfeld, Paul Dixon, Mark  
Gamero, Joshua Joya

### Prop Crew:

Nicole Fargardo, Anikke Fox

### Load-in and Light-hang Crew:

Li Cornfeld, Anikke Fox, the wonderful  
Doug Nervik, the great Charlie  
Tocantins

### House Manager:

Liz Bell, Karin Schall

### Chefs:

Liz Bell, Carol Ochs, Christopher  
Randolph, John Sheehy

### Teen Counselors:

Mark Gamero and Joshua Joya

## COOL STUFF ON SALE IN THE LOBBY!

The Fabulous Flyer Bar . . . . . \$2, \$1.50 & \$1  
and featuring Shel Silverstein's "Fivey and Twoey" logo:  
Project T-shirts (NEW Design) . . . . . \$12.00  
Project Tank Tops (NEW Girls' Design) . \$12.00  
Project Caps (NEW design) . . . . . \$15.00  
Project Mugs (now in BLUE!) . . . . . \$5.00  
Project Notebook (New Item) . . . . . \$5.00

Thank you for coming to **HOLIDAYS IN THE SUN!** If you are not on our mailing list (or if your address has changed), please fill out this form and give it to us on your way out or mail it to the address below. We would also like to know if you are interested in becoming a volunteer. We need help in **all areas**, so be sure to fill out the entire form.

### PLEASE ADD ME TO YOUR MAILING LIST:

8/05

NAME: \_\_\_\_\_

ADDRESS: \_\_\_\_\_

ZIP \_\_\_\_\_

HOME PHONE: \_\_\_\_\_

DAYTIME PHONE: \_\_\_\_\_

E-MAIL ADDRESS: \_\_\_\_\_

MY OCCUPATION: \_\_\_\_\_

MY HOBBIES: \_\_\_\_\_

### YES, I WOULD LIKE TO BE OF HELP. I CAN:

- |   |   |  |
|---|---|--|
| <input type="checkbox"/> Help load in and out for shows | <input type="checkbox"/> Draw and/or paint  | <input type="checkbox"/> Help kids with homework |
| <input type="checkbox"/> Hang lights                    | <input type="checkbox"/> Help with mailings | <input type="checkbox"/> Teach kids a skill      |
| <input type="checkbox"/> Work on a backstage crew       | <input type="checkbox"/> Do office work     | <input type="checkbox"/> Be a chef at an event   |
| <input type="checkbox"/> Do graphic design              | <input type="checkbox"/> Design sound       | <input type="checkbox"/> Design and sew costumes |
| <input type="checkbox"/> Other (please specify) _____   |   |  |

### MY SCHEDULE IS:

- Very flexible. I'm often available during weekdays.  
 Somewhat flexible. I can help on the occasional morning or afternoon during the week.  
 Not very flexible at all, but I've got some free time on evenings and weekends.

If you would like to mail this (and you're always welcome to enclose a tax-deductible contribution), you can send it to: **The 52nd Street Project**, 500 West 52nd St., New York, NY 10019. Or fax it to (212) 333-5598.



The One-on-Ones Program is made possible with public funds from The New York State Council on the Arts, a state agency; and the New York City Department of Cultural Affairs. The 52nd Street Project is supported by funds from the National Endowment for the Arts, the Department of Youth and Community Development. The Project is member of ART/NY and a participant in the New Generations Program, funded by Doris Duke Charitable Foundation/The Andrew W. Mellon Foundation and administered by Theatre Communications Group, the national organization for the American Theater.



**Don't Miss Our Upcoming Shows!**

# CHILL AND SERVE

## THE REVENGE PLAYS

**The 2005 Playback Production, October, 2005**

First a kid writes a short play. Then, an adult writes an "answer" play. Then, the two of them perform both plays. Multiply this equation by seven and you've got an entire show.

# OH NO YOU DIDN'T!

## PLAYS THAT DO!

**December, 2005**

In September, 10 brand-new kids will begin a Playmaking class taught by **Reg Flowers**, our brand-new Project Playmaking Director. Come and see their final plays performed by adult professional actors.

The 52nd Street Project is a non-profit organization that brings children from the Hell's Kitchen neighborhood together with professional theater artists to create original theater. **HOLIDAYS IN THE SUN** is a production of our One-on-One program, which is designed to give children the opportunity to go away for one-week stays in the country and enjoy the undivided attention of a professional theater artist who serves as friend, mentor, and collaborator. The Project is delighted to return to the Ensemble Studio Theatre, where we have been performing since our inception in 1981. We gratefully acknowledge the fact that if E.S.T. wasn't here, we'd be nowhere.

### The 52nd Street Project Board of Directors

Ben Barenholtz	Patricia M. Murphy, Esq.
Lisa Benavides	Carol Ochs
Rachel Chanoff	Willie Reale, <i>founder</i>
Cathy Dantchik	Gus Rogerson
Wendy Ettinger, <i>chair emeritus</i>	Shirley Rumierk, <i>alumni member</i>
Louis P. Friedman	José Soto, Jr., <i>alumni member</i>
Stephen Graham, <i>chair</i>	Pamala Tyson
Larry Jones	Laura Valeroso
James McDaniel	Wendy vanden Heuvel
Frances McDormand	John A. Vassilaros
Noël Mihalow	Jenny Wiener

### Special Thanks

Our Host Families – Anne & Colin McNay; Emily & John Morgan; Suzanne & John Potts; Patty & David Straus; Bob & Marina Whitman; Joe McNay & the entire McNay family; Peter, Helen & Christopher Randolph  
Sincere Thanks to Eric Griggs; Chris Hammett; Bruce MacVittie; Robin Morse, Lucy & Francis Rogerson; Vanessa Valdes; The Wareham Gatemen; The McNay Family pools; Alice Curtin; The Watson Family; The Wareham Land Trust.

### In-Kind Contributions

Curt, John, Theresa, and everyone at the Ensemble Studio Theatre; the Murphy Law Office; Benefit Cosmetics; Iris A. Brown; Bourjois Paris; Bumble and bumble; Ron Kastner and Capital Printing; Kenneth Cole Productions; Noggin; The Printing Store; Scholastic, Inc.; Diageo Chateau & Estate Wines; Entertainment Weekly; Lucky Magazine; Microtouch/Finishing Touch; Molten Brown; MOP Cosmetics; Newman's Own; Pharma Print/Omni Graphics; Sesame Workshop; Wendy Stuhlberg; Terax America; John A. Vassilaros; Watkins, Inc.; Mayor's Office of Film & Television; Boylan's Bottling Co.; David Sneddon & Fairway Market; Lorraine Tobias & Imaginary Studios; Jive Records, part of Zomba Music Group; and Prime Films.

## HOLIDAYS IN THE SUN II - ACT 1

All original music composed by Patrick Barnes  
"Holidays In The Sun Theme Song" lyrics by John Sheehy

### OUTFIELDERS

Written by Jay Reiss & Directed by Paco Tolson  
for Junior Chatman, age 12

Ted .....Junior Chatman  
Fred .....Paco Tolson  
Announcer .....John Sheehy

"It's The Equinox" lyrics by Jay Reiss

### IT'S ALIVE

Written & Directed by Drew Cortese for Mathew Ortiz, age 12

The Doctor .....Mathew Ortiz  
The Creature .....Drew Cortese  
First Scientist .....Mark Gamero  
Second Scientist .....Joshua Joya

"Doctor & Creature Song" lyrics by Drew Cortese

### DEAD-A-PORTER

Written by Martha Plimpton & Directed by Nikki Phillips  
for Luisa Santiago, age 9

Dr. Jennifer Lopez .....Luisa Santiago  
Det. Sanchez, Veronique, Lunatic Fan & Det. Hannigan .....Nikki Phillips

"The New Jennifer Lopez (No Relation) Song" lyrics by Martha Plimpton

### VIVA LA REVOLUTION

Written & Directed by Kate Marks for Pablo Maldonado, age 11

Lion .....Pablo Maldonado  
Tulip .....Anikke Fox  
Radio .....Patrick Barnes  
Violet .....Susan McGinnis

"Viva La Revolution: A Marching Song" lyrics by Kate Marks

### TIME OUT

Written by Michael Bernard & Directed by Elizabeth Canavan  
for Fifi Fernandez, age 9

Plimpsie .....Fifi Fernandez  
Soul .....Elizabeth Canavan

"The Bestest Time" lyrics by Michael Bernard

👉 **Intermission!** 👈

## HOLIDAYS IN THE SUN II - ACT 2

### THE SHOWDOWN

Written & Directed by George Babiak for George Keller, age 10

Tank Brannigan .....George Keller  
Crank Flannigan .....George Babiak  
Maggie .....Anikke Fox

"The Soft Drinking Song" lyrics by George Babiak

### TOO COOL PILOTS

Written & Directed by Catherine Mueller for Harlo Ulloa, age 12

Frank Sarciapone .....Harlo Ulloa  
Frances Sterngarden .....Catherine Mueller

"Two Pilots are Better Than One" lyrics by Catherine Mueller

### THE PRINCESS PLAYS BALL

Written by Jacquelyn Reingold & Directed by Susan McGinnis  
for Catherine Fernandez, age 11

Princess of the Queendom .....Catherine Fernandez  
Baseball Coach .....Susan McGinnis  
Queen of the Queendom .....Diana Rojas  
Announcer .....John Sheehy

"I'll Have to Give Up Who I Am" lyrics by Jacquelyn Reingold

### TOMMY THE TRAINER & HIS "KID" CRUZ

Written & Directed by Joaquin Torres for Muhammad Cunningham, age 11

Tommy the Trainer .....Muhammad Cunningham  
Carlos "The Kid" Cruz .....Joaquin Torres  
Winston "The Weatherman" Jones .....Joshua Joya  
Charlie .....Mark Gamero

"Be A Champion Tonight" lyrics by Joaquin Torres

### PERMANENT VACATION

Written & Directed by Carlo Alban for Joyce Cheung, age 9

Lucy .....Joyce Cheung  
Lucky .....Carlo Alban

"A Lighthouse in the Sea" lyrics by Carlo Alban



The 52nd Street Project gratefully acknowledges the support of the following foundations and corporations: Stephen & Mary Birch Foundation; Brunswick Group LLP; Capital Research Company; Carnegie Corporation of New York; CBS; Citigroup Foundation; Cityrest, LLC; Clinton Seed Fund; Comedy Central; Consolidated Edison; The Dramatists Guild Fund; Dramatists Play Service; The Fan Fox & Leslie R. Samuels Foundation.; Fox Hollow Technologies, Inc.; The Horace W. Goldsmith Foundation; The Henlopen Foundation; Holland Lodge Foundation; Lloyds TSB Bank plc; Lucille Lortel Foundation; James A. Macdonald Foundation; Ann M. Martin Foundation; Mellon Equity Associated, LLP; Newman's Own; The New York Times Company Foundation; Noggini; People Places, Inc.; Sesame Workshop; Showtime Networks Inc; St. Vincent De Paul Foundation; Stranahan Foundation; The Surdna Foundation; Theatre Communications Group, Inc.; Tiger Baron Foundation; John A. Vassilaros & Son, Inc.; The Vervane Foundation; Weil, Gotshal & Manges LLP; Felix Zarembo & Co. Inc.; Zombaln addition the following individuals made gifts of over \$250 to The 52nd Street Project this past year (list is current as of 7/01/05):

Robert Abrams & Cynthia Vance	Louis & Patrice Friedman	Peter Manning & André Bishop	Mitchell Semel & Colleen Carroll
Jace Alexander & Maddie Corman	Rose Gasner & Larry Chertoff	Sonya Martin	Mitchell Silverman
Alexis Alexanian	John A. Vassilaros &	Robert Matza & Nina Matza	Simone Silverman
Lawrence Alieto	Alexandra Gersten-Vassilaros	Fran McDormand & Joel Coen	Landon Slane
Cecilia Arana-Grant & Kevin Grant	Scott & Laura Gewirtz	Rick Meese & Dan Lori	Jean Stein
Emily Armstrong	Kilty Gilmour	Josie Merck & Jim Stevenson	Barclay Stiff
Ben Barenholtz	Tony Goldwyn & Jane Musky	Audrey & Danny Meyer	Ben & Christine Stiller
Jessica Bauman	Stephen & Cathy Graham	Noël & Joe Mihalow	R.L. Stine & Jane Stine
Lisa Benavides & Tim Nelson	Connie Grappo & Lee Wilkof	Suzen Murakoshi & Mark Temme	Susanna Styron & Darrell Larson
Stephanie Berger & Paul King	Myrna & Stephen Greenberg	Patricia M. Murphy, Esq. & Adam Spilka	Brian Swardstrom & Bonnie Bernstein
Alexander & Elizabeth Bernstein	Michael Greif & Jonathan Fried	Don & Sara Nelson	Richard Sweren
Lewis Black	Emily Grishman & Susan Sampliner	Fred Nelson	Leonard Tow
Andrew Blackman & Tatiana Rutkowski	Lisa Gugenheim & Larry Nathanson	Randy & Rona Nelson	Liz Tuccillo
Richard Blau	Nina Hellman & Jeremy Shamos	James Neuberger & Helen Stambler	John Turturro & Katherine Borowitz
Roger Bolton & Lynne Bolton	Peter Herdrich & Karen Trott	& Helen Stambler	Laura Valeroso & David Seidman
Becky Browder & Ted Neustadt	William Holtzman	Clea Newman	Wendy vanden Heuvel & Brad Coley
Susan Bruce & Peter Hedges	& S. Sylvia Shepard	Kevin O'Rourke & Edith Thurber	Ed Vassallo
Cora Cahan & Bernard Gersten	Katy Homans & Patterson Sims	Carol Ochs & Bruce MacVittie	John A. Vassilaros & Alexandra Gersten- Vassilaros
Rachel Chanoff	Sarah Horowitz & David Venarde	Jacki Ochs & Jan Kroeze	Claudia Wagner
Howard Chatzinoff	Saul Horowitz	Elizabeth Peters	Mary Pat Walsh
Ronald Cohen	Anne & Eli Jackson	Bat-Sheva & Thomas Peters	Borah & Mildred Walton
John Ellison Conlee	LaTanya & Samuel Jackson	Judy Goldman & Michael Pillingger	Lynn & Sam Waterston
Tricia Cooke & Ethan Coen	Sy Jacobs	Peter & Helen Randolph	Sally & Lenny Weiss
Arthur Dantchik	Andrea Johnson	Paul Reale & Barbara McCrane	Jane Bolster & Steve Wertimer
Cathy Dantchik	Kristen Johnston	Willie Reale & Jenny Gersten	Jenny Wiener & Jon Steingart
Leslie Dantchik	Larry & Mary Jones	Lise Rehwaldt & Mark Roberts	Michael & Zena Wiener
Shery Davis & Mark Alhadeff	Jane Kaczmarek	Julie Ridge	Joanne Woodward & Paul Newman
Peter & Judith Dawkins	Cindy Kaplan	David & Anita Rogerson	Jeffrey & Janine Yass
Richard & Rebecca Dresser	Michelle Katz	Shirley Rumierk	Mei Yueh Yen
Nora Ephron	Judy Kuhn & David Schwab	Steve Sabba	
Heidi Ettinger	Stephen Lebovitz	Laura Sametz & Anton Fig	
Wendy Ettinger & Derek McLane	Robert Sean Leonard	Marcia Santoni & John Morris	
Robert Feldman	Liza Lerner	Meredith Beeuwkes	
Peter Jay Fernandez	Michael Loeb & Marjorie Loeb	Karin & Tom Schall	
& Denise Burse	Grace Lyu-Volkhausen	Robert Schnur	
Frank Frattaroli	Greg MacPherson	Maury Schott	
Katherine Freedman	& Jane Perlmutter	Lauren Seikaly & Michael Huber	
	Doda Manalansan		

## THE 52ND STREET PROJECT PRESENTS THE FALL 2005 PLAYBACK SHOW

# Chill AND Serve

## THE REVENGE PLAYS

### AT THE WINGS THEATRE

154 CHRISTOPHER ST.

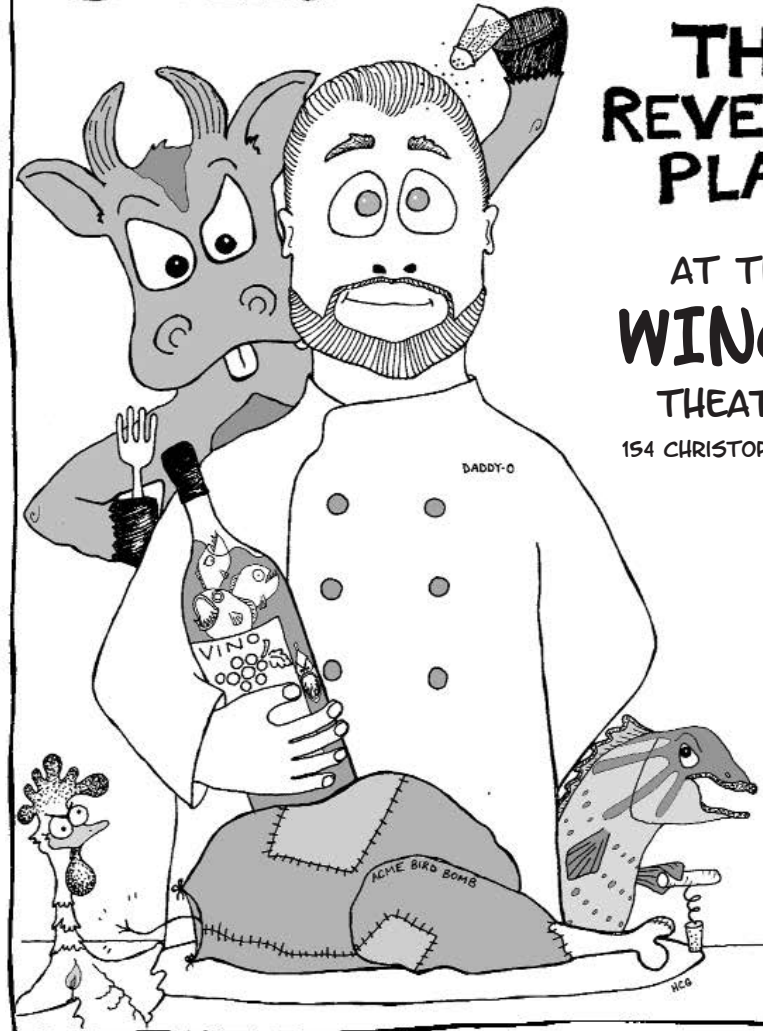

HEATHER CARNIDUFF-GOBBIE

FRI., OCT. 21 AT 7:30 P.M.  
SAT., OCT. 22 AT 3:00 P.M. AND 7:30 P.M.  
SUN., OCT. 23 AT 3:00 P.M.

# CHILL AND SERVE THE REVENGE PLAYS

THE FALL 2005 PLAYBACK SHOW OCT. 21-23 AT THE WINGS THEATRE

## The 52nd Street Project Staff:

Gus Rogerson, Artistic Director  
 Carol Ochs, Executive Director  
 John Sheehy, Director of Development and Marketing  
 George "X-Acto" Babiak, Production Manager  
 Reg Flowers, Associate Artistic Director  
 Liz Bell, Director of Education  
 Diana Rojas, Executive Assistant  
 Mayleen Cancel, Education Assistant  
 Megan Cramer, Education Liaison  
 Chris Ceraso, Teen Dean  
 Solangee Acosta, Joshua Joya, Johanna Vidal, Receptionists  
 Intern: Megan Corcoran



HEATHER CARNDUFF-GOBBER

## Production Staff:

**Composer:** Loren Toolajian  
**Set Designer:** Kevin Joseph Roach  
**Lighting Designer:** Greg MacPherson  
**Lighting Assistant:** Alex Gordon  
**Costume Designer:** Bryan Gmitter  
**Sound Designer:** Maury Schott  
**Stage Manager:** Jenni Swan  
**"Chill" Illustration:**

Heather Carnduff-Gobbee

## Prop Design Team:

George Babiak, Megan Corcoran,  
 John Sheehy, Rachel Stephens,  
 Jenni Swan

## Backstage Boss:

Mean Mayleen Cancel

## Furniture Crew:

Anthony Mejia and  
 Kimani Lewis-Ashley

## Prop Crew:

Kayelani Silva and Megan Corcoran

## Load-in and Light Hang Crew:

Megan Corcoran,  
 Moira MacDonald,  
 Doug Nervik, Kevin Ryder,  
 Tom Schall, Maury Schott,  
 Jenni Swan

## House Managers:

Liz Bell and Mary Pat Walsh

## Chef:

The Incredibell Liz Bell

The Playback Program is made possible with public funds from The New York State Council on the Arts, a state agency; and the New York City Department of Cultural Affairs. The 52nd Street Project is supported by funds from the National Endowment for the Arts and the Department of Youth and Community Development. The Project is member of ART/NY and a participant in the New Generations Program, funded by Doris Duke Charitable Foundation/The Andrew W. Mellon Foundation and administered by Theatre Communications Group, the national organization for the American Theater.



## COOL STUFF ON SALE!

Flyer Bars .....\$2.00, \$1.50 & \$1.00

*Shel Silverstein's "Fivey and Twoey" logo gear:*

Project Sweatshirts .....\$20.00  
 Project Long Sleeve T-Shirts .....\$15.00  
 Project Short Sleeve T-Shirts (New colors!) ..\$12.00  
 Project Caps .....\$15.00  
 Project Mugs .....\$5.00  
 Project Spiral Notebooks .....\$5.00  
 Project Pencil 3-pack (New color!) .....\$1.00

Thank you for coming to **CHILL AND SERVE**. If you are not on our mailing list (or if your address has changed), please fill out this form and give it to us on your way out or mail it to the address below. We would also like to know if you are interested in becoming a volunteer. We need help in **all areas**, so be sure to fill out the entire form.

### PLEASE ADD ME TO YOUR MAILING LIST:

OCT 2005

NAME: \_\_\_\_\_

ADDRESS: \_\_\_\_\_

\_\_\_\_\_ ZIP \_\_\_\_\_

HOME PHONE: \_\_\_\_\_

DAYTIME PHONE: \_\_\_\_\_

E-MAIL ADDRESS: \_\_\_\_\_

MY OCCUPATION: \_\_\_\_\_

MY HOBBIES: \_\_\_\_\_

### YES, I WOULD LIKE TO BE OF HELP. I CAN:

- |   |   |  |
|---|---|--|
| <input type="checkbox"/> Help load in and out for shows | <input type="checkbox"/> Draw and/or paint  | <input type="checkbox"/> Help kids with homework |
| <input type="checkbox"/> Hang lights                    | <input type="checkbox"/> Help with mailings | <input type="checkbox"/> Teach kids a skill      |
| <input type="checkbox"/> Work on a backstage crew       | <input type="checkbox"/> Do office work     | <input type="checkbox"/> Be a chef at an event   |
| <input type="checkbox"/> Do graphic design              | <input type="checkbox"/> Design sound       | <input type="checkbox"/> Design and sew costumes |
| <input type="checkbox"/> Other (please specify) _____   |   |  |

### MY SCHEDULE IS:

- Very flexible. I'm often available during weekdays.  
 Somewhat flexible. I can help on the occasional morning or afternoon during the week.  
 Not very flexible at all, but I've got some free time on evenings and weekends.

If you would like to mail this (and you're always welcome to enclose a tax-deductible contribution), you can send it to: **The 52nd Street Project**, 500 West 52nd St., New York, NY 10019. Or fax it to (212) 333-5598.

## Don't Miss Our Upcoming Shows!

# Oh No, You *DIDN'T!*

Plays that do!

DECEMBER 9-11 AT THE PUBLIC THEATER

In September, 9 brand-new Project kids began a Playmaking class taught by brand-new Playmaking Director Reg Flowers. Come and see their final plays performed by adult professional actors.

# THE TWO-ON -TWO'S

JANUARY, 2006  
AT THE  
WOMEN'S INTERART THEATRE

Dare we let kids act with each other, with no adult in sight? You bet we do! Come see these six new plays in the space across the hall from the Clubhouse.



The 52nd Street Project is a non-profit organization that brings children from the Hell's Kitchen neighborhood together with professional theater artists to create original theater. **CHILL AND SERVE** is a production of our **Playback** program, in which kid actor/playwrights wrote plays that were then "answered" by adult actor/playwright partners who write their own plays. We took the whole menagerie up to the idyllic hamlet of Franklin, NY over the Columbus Day weekend to rehearse the shows. In the final production, which you see here tonight, the partners perform both plays back-to-back. All of the kids involved are veterans of the Playmaking classes which were adapted for the Project by Daniel Judah Sklar from his book *Playmaking: Children Writing and Performing Their Own Plays*.

### The 52nd Street Project Board of Directors

Ben Barenholtz  
Lisa Benavides  
Rachel Chanoff  
Cathy Dantchik  
Wendy Ettinger,  
*chair emeritus*  
Louis P. Friedman  
Stephen Graham, *chair*  
Larry Jones  
James McDaniel  
Frances McDormand  
Noël Mihalow  
Patricia M. Murphy, Esq.

Carol Ochs  
Willie Reale,  
*founder*  
Gus Rogerson  
Shirley Rumierk,  
*alumni member*  
José Soto, Jr.,  
*alumni member*  
Pamala Tyson  
Laura Valeroso  
Wendy vanden Heuvel  
John A. Vassilaros  
Jenny Wiener

### Special Thanks

We're extremely grateful to **Gene, Carol, and Carmela Marner; Tom Duerdon and Xena Sheehan**, the **Monosson** family and all the folks in Franklin, NY for being such gracious hosts on the weekend away. **Ed Vassallo** gets a foam-core Oscar for arranging the entire expedition.

### In-Kind Contributions

The Murphy Law Office; Benefit Cosmetics; Iris A. Brown; Bourjois Paris; Bumble and bumble; Ron Kastner and Capital Printing; Kenneth Cole Productions; Noggin; Scholastic, Inc.; Diageo Chateau & Estate Wines; Entertainment Weekly; Lucky Magazine; Microtouch/Finishing Touch; Molten Brown; MOP Cosmetics; Newman's Own; Pharma Print/Omni Graphics; Sesame Workshop; Wendy Stuhlberg; Terax America; John A. Vassilaros; Watkins, Inc.; Mayor's Office of Film & Television; Boylan's Bottling Co.; David Sneddon & Fairway Market; Lorraine Tobias & Imaginary Studios; ICI; Jive Records, part of Zomba Music Group; and Prime Films.



## CHILL AND SERVE: THE REVENGE PLAYS ACT I

All original music composed by Loren Toolajian

### GLAMOUROUS AND FANTSY

By Crystal Toro, age 13. Dramaturg/Director: Megan Cramer.

### ALL THE PRETTY LITTLE FLOWERS

Written and directed by Megan Cramer.

Glamour Girl/Rose .....Crystal Toro  
 Fantsy Smantsy Pantsy/Daisy .....Megan Cramer  
 Best Friends .....Megan Corcoran & Kayelani Silva  
 School Kids .....The Crew  
 Mr. Fantastic .....John Sheehy  
 “I’m a Star,” “Just Listen,” “What a Day,” “Just Stay Away,” and “Drama’s Over”  
 lyrics by Crystal Toro.

### I HAD TO DO WHAT I HAD TO DO

By A.J.Welsh, age 12. Dramaturg/Director: Ed Vassallo.

### ACORN’S DILEMMA

Written and directed by Ed Vassallo.

Champ Shanahan .....A.J. Welsh  
 Shockey Buress/Devin Shanahan .....Ed Vassallo  
 Silhouettes .....Anthony Mejia, Kayelani Silva  
 & Kimani Lewis-Ashley

“Cause and Effect” lyrics by Ed Vassallo.

### THE RICH AND THE BUM

By Jonathan Rosario, age 12. Dramaturg/Director: Zakiyyah Alexander.

### FAME AND FORTUNE

Written and directed by Zakiyyah Alexander.

Yo I Don’t Know .....Jonathan Rosario  
 Yo I Do Know .....Zakiyyah Alexander

“The Rap” lyrics by Jonathan Rosario.

### THE BIG MYSTERY

By Janiece Aponte, age 12. Dramaturg/Director: George Babiak.

**SWEET REVENGE** Written and Directed by George Babiak.

Katelyn/Lefty .....Janiece Aponte  
 Anthony/Flash .....George Babiak  
 High School Kids .....The Crew  
 Survivor .....Megan Corcoran  
 Silhouettes .....Megan Cramer & Reg Flowers

“Best Friends Forever” lyrics by Janiece Aponte, “Revenge” lyrics by George Babiak.



## CHILL AND SERVE: THE REVENGE PLAYS ACT II

### THE LESSON OF GIVING

By Dale Fetterman, age 12. Dramaturg/Director: Lizzy Cooper Davis.

### THE GIFT THAT KEEPS ON

By Reg Flowers. Directed by Lizzy Cooper Davis.

Davis .....Dale Fetterman  
 Spirit/Terry Mason .....Lizzy Cooper Davis  
 Policeman .....Reg Flowers  
 Other Cops .....The Crew

“The Break Song” lyrics by Reg Flowers.

### THE YEAH YEAH BRAVE GIRLS

By Merlaine Mendez, age 13. Directed by Patricia Buckley.

### YEAH, YEAH WHATEVER

Written by Reg Flowers and Patricia Buckley. Directed by Patricia Buckley.

Mimi Mister .....Merlaine Mendez  
 Cici Mister .....Patricia Buckley

“The Yeah Yeah Song” and “What Do You Do” lyrics by Merlaine Mendez.

### LAWYERS ALWAYS HAVE A THING FOR FOOTBALL PLAYERS

By Steven Castellanos, age 13. Dramaturg/Director: Jed Clarke.

### MAKE IT RIGHT

Written and directed by Jed Clarke.

Michle .....Steven Castellanos  
 John Ricks .....Jed Clarke

“I’m Sorry” lyrics by Jed Clarke.

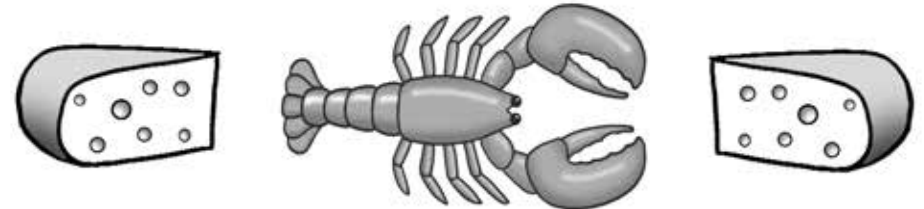

The 52nd Street Project gratefully acknowledges the support of the following foundations and corporations: Stephen & Mary Birch Foundation; Brunswick Group LLP; Capital Research Company; Carnegie Corporation of New York; CBS; Citigroup Foundation; Cityrest, LLC; Clinton Seed Fund; Comedy Central; Consolidated Edison; The Dramatists Guild Fund; Dramatists Play Service; The Fan Fox & Leslie R. Samuels Foundation.; Fox Hollow Technologies, Inc.; The Horace W. Goldsmith Foundation; The Henlopen Foundation; Holland Lodge Foundation; Lloyds TSB Bank plc; Lucille Lortel Foundation; James A. Macdonald Foundation; Ann M. Martin Foundation; Mellon Equity Associated, LLP; Newman's Own; The New York Times Company Foundation; Noggin; People Places, Inc.; Sesame Workshop; Showtime Networks Inc; St. Vincent De Paul Foundation; Stranahan Foundation; The Surdna Foundation; Theatre Communications Group, Inc.; Tiger Baron Foundation; John A. Vassilaros & Son, Inc.; The Vervane Foundation; Weil, Gotshal & Manges LLP; Felix Zaremba & Co. Inc.; Zombaln addition the following individuals made gifts of over \$250 to The 52nd Street Project this past year (list is current as of 7/01/05):

Robert Abrams & Cynthia Vance	Louis & Patrice Friedman	Peter Manning & André Bishop	Mitchell Semel & Colleen Carroll
Jace Alexander & Maddie Coman	Rose Gasner & Larry Chertoff	Sonya Martin	Mitchell Silverman
Alexis Alexanian	John A. Vassilaros &	Robert Matza & Nina Matza	Simone Silverman
Lawrence Alieto	Alexandra Gersten-Vassilaros	Fran McDormand & Joel Coen	Landon Slane
Cecilia Arana-Grant & Kevin Grant	Scott & Laura Gewirtz	Rick Meese & Dan Lori	Jean Stein
Emily Armstrong	Kilty Gilmour	Josie Merck & Jim Stevenson	Barclay Stiff
Ben Barenholtz	Tony Goldwyn & Jane Musky	Audrey & Danny Meyer	Ben & Christine Stiller
Jessica Bauman	Stephen & Cathy Graham	Noël & Joe Mihalow	R.L. Stine & Jane Stine
Lisa Benavides & Tim Nelson	Connie Grappo & Lee Wilkof	Suzen Murakoshi & Mark Temme	Susanna Styron & Darrell Larson
Stephanie Berger & Paul King	Myrna & Stephen Greenberg	Patricia M. Murphy, Esq. & Adam Spilka	Brian Swardstrom & Bonnie Bernstein
Alexander & Elizabeth Bernstein	Michael Greif & Jonathan Fried	Don & Sara Nelson	Richard Sweren
Lewis Black	Emily Grishman & Susan Sampliner	Fred Nelson	Leonard Tow
Andrew Blackman & Tatiana Rutkowski	Lisa Gugenheim & Larry Nathanson	Randy & Rona Nelson	Liz Tuccillo
Richard Blau	Nina Hellman & Jeremy Shamos	James Neuberger & Helen Stambler	John Turturro & Katherine Borowitz
Roger Bolton & Lynne Bolton	Peter Herdrich & Karen Trott	& Helen Stambler	Laura Valeroso & David Seidman
Becky Browder & Ted Neustadt	William Holtzman	Clea Newman	Wendy vanden Heuvel & Brad Coley
Susan Bruce & Peter Hedges	& S. Sylvia Shepard	Kevin O'Rourke & Edith Thurber	Ed Vassallo
Cora Cahan & Bernard Gersten	Katy Homans & Patterson Sims	Carol Ochs & Bruce MacVittie	John A. Vassilaros & Alexandra Gersten- Vassilaros
Rachel Chanoff	Sarah Horowitz & David Venarde	Jacki Ochs & Jan Kroeze	Claudia Wagner
Howard Chatzinoff	Saul Horowitz	Elizabeth Peters	Mary Pat Walsh
Ronald Cohen	Anne & Eli Jackson	Bat-Sheva & Thomas Peters	Borah & Mildred Walton
John Ellison Conlee	LaTanya & Samuel Jackson	Judy Goldman & Michael Pillingier	Lynn & Sam Waterston
Tricia Cooke & Ethan Coen	Sy Jacobs	Peter & Helen Randolph	Sally & Lenny Weiss
Arthur Dantchik	Andrea Johnson	Paul Reale & Barbara McCrane	Jane Bolster & Steve Wertimer
Cathy Dantchik	Kristen Johnston	Willie Reale & Jenny Gersten	Jenny Wiener & Jon Steingart
Leslie Dantchik	Larry & Mary Jones	Lise Rehwaldt & Mark Roberts	Michael & Zena Wiener
Shery Davis & Mark Alhadeff	Jane Kaczmarek	Julie Ridge	Joanne Woodward & Paul Newman
Peter & Judith Dawkins	Cindy Kaplan	David & Anita Rogerson	Jeffrey & Janine Yass
Richard & Rebecca Dresser	Michelle Katz	Shirley Rumierk	Mei Yueh Yen
Nora Ephron	Judy Kuhn & David Schwab	Steve Sabba	
Heidi Ettinger	Stephen Lebovitz	Laura Sametz & Anton Fig	
Wendy Ettinger & Derek McLane	Robert Sean Leonard	Marcia Santoni & John Morris	
Robert Feldman	Liza Lerner	Meredith Beeuwkes	
Peter Jay Fernandez	Michael Loeb & Marjorie Loeb	Karin & Tom Schall	
& Denise Burse	Grace Lyu-Volkhausen	Robert Schnur	
Frank Frattaroli	Greg MacPherson	Maury Schott	
Katherine Freedman	& Jane Perlmutter	Lauren Seikaly & Michael Huber	
	Doda Manalansan		

## THE 52ND STREET PROJECT PRESENTS



## THE 2005 STONE RIDGE PLAYMAKING SERIES

AT THE PUBLIC THEATER  
425 LAFAYETTE ST.

FRI., DEC. 9 AND SAT., DEC. 10 AT 7:30 P.M.,  
SUN., DEC. 11 AT 3:00 P.M.

# OH NO YOU DIDN'T

The Stone Ridge Playmaking Plays - Fall 2005 - Dec. 9-11  
at The Public Theater, 425 Lafayette St.

## The 52nd Street Project Staff:

Gus Rogerson, Artistic Director  
Carol Ochs, Executive Director  
John Sheehy, Director of Development and Marketing  
George "X-Acto" Babiak, Production Manager  
Reg Flowers, Associate Artistic Director  
Liz Bell, Director of Education  
Diana Rojas, Executive Assistant  
Mayleen Cancel, Education Assistant  
Megan Cramer, Education Liaison  
Chris Ceraso, Teen Dean  
Solangee Acosta, Joshua Joya, Johanna Vidal, Receptionists  
Intern: Megan Corcoran

## Production Staff

**Composer:** Patrick Barnes

**Set Designer:** Kevin Joseph Roach

**Lighting Designers:**

Greg MacPherson and  
Doug Filomena

**Costume Designers:**

Chloe Chapin and Abby Redmond

**Sound Designer:** Maury Schott

**Stage Manager:** Patricia MacGregor

**Slide Designers:**

George Babiak, Billie Cohen,  
Mike Sell, and many others

**"Oh No You Didn't" Illustration:**

Reg Flowers

**Prop Design Team:**

George Babiak, Inge Baugh,  
Meredith Blake and her friend  
Taylor, Megan Corcoran,  
Ben Patton, Rob Steir, Oui Wong

**Furniture Crew:**

Noel Polanco, Christopher Ramirez,  
and Aladino Olivares

**Prop Crew:**

Megan Corcoran and Riji Suh

**Load-in and Light Hang Crew:**

Brian Emens, Ray Harold, Holly  
Kirk, Nick Mele, Ben Patton, Jay  
Scott, Charlie Tocantins

**Playmaking Class Volunteers:**

David Anzuelo, Rebecca  
Bellingham, Megan Corcoran,  
Ephraim Lopez  
and Akyiaa Wilson,

**House Managers:**

Mary Pat Walsh and Liz Bell

**Host/Chefs:**

Joe White, Iris A. Brown, and their  
son Walker

The Playmaking Program is made possible with public funds from The New York State Council on the Arts, a state agency. The 52nd Street Project is a member of Art/NY and a participant in the New Generations Program, funded by Doris Duke Charitable Foundation/The Andrew W. Mellon Foundation and administered by Theatre Communications Group, the national organization for the American Theater.



# COOL STUFF ON SALE!

Flyer Bars .....\$2.00, \$1.50 & \$1.00  
"Playmaking" by Daniel Judah Sklar .....\$15.00

*Shel Silverstein's "Fivey and Twoey" logo gear:*

Project "Hoodies" (NEW!) .....\$30.00  
Project Caps .....\$15.00  
Project Mugs .....\$5.00  
Project Notebooks .....\$5.00  
Project Pencil 3-pack (NEW COLOR!) ...\$1.00

Thank you for coming to **OH NO YOU DIDN'T**. If you are not on our mailing list (or if your address has changed), please fill out this form and give it to us on your way out or mail it to the address below. We would also like to know if you are interested in becoming a volunteer. We need help in **all areas**, so be sure to fill out the entire form.

**PLEASE ADD ME TO YOUR MAILING LIST:**

12/05

NAME: \_\_\_\_\_

ADDRESS: \_\_\_\_\_

ZIP \_\_\_\_\_

HOME PHONE: \_\_\_\_\_

DAYTIME PHONE: \_\_\_\_\_

E-MAIL ADDRESS: \_\_\_\_\_

MY OCCUPATION: \_\_\_\_\_

MY HOBBIES: \_\_\_\_\_

**YES, I WOULD LIKE TO BE OF HELP. I CAN:**

- |   |   |  |
|---|---|--|
| <input type="checkbox"/> Help load in and out for shows | <input type="checkbox"/> Draw and/or paint  | <input type="checkbox"/> Help kids with homework |
| <input type="checkbox"/> Hang lights                    | <input type="checkbox"/> Help with mailings | <input type="checkbox"/> Teach kids a skill      |
| <input type="checkbox"/> Work on a backstage crew       | <input type="checkbox"/> Do office work     | <input type="checkbox"/> Be a chef at an event   |
| <input type="checkbox"/> Do graphic design              | <input type="checkbox"/> Design sound       | <input type="checkbox"/> Design and sew costumes |
| <input type="checkbox"/> Other (please specify) _____   |   |  |

**MY SCHEDULE IS:**

- Very flexible. I'm often available during weekdays.  
 Somewhat flexible. I can help on the occasional morning or afternoon during the week.  
 Not very flexible at all, but I've got some free time on evenings and weekends.

If you would like to mail this (and you're always welcome to enclose a tax-deductible contribution), you can send it to: **The 52nd Street Project**, 500 West 52nd St., New York, NY 10019. Or fax it to (212) 333-5598.

## Don't Miss Our Upcoming Shows!

# WHICH WAY DID THEY GO?

## THEATRICAL PURSUITS

The 2006 2-on-2's - January 27, 28, and 29

at

The Women's  
Interart Annex,  
500 W. 52nd St.

Just across the  
hall from the  
Clubhouse!



6 new plays, each with two kids as performers and two adults as writers and directors. Come watch the kids go it alone on stage!

# Any Day Now!

## PLAYS WORTH WAITING FOR



The Spring Edition of the  
Project's Playmaking Program

At a theater to be announced  
(If you have one we can use, tell us!)

If you're enjoying the show tonight, you'll want to take in another set of shows by our *next* batch of Project newcomers! Call 642-5052 for reservations.

The 52nd Street Project is a non-profit organization that brings children from the Hell's Kitchen neighborhood together with professional theater artists to create original theater. **OH NO YOU DIDN'T** is a production of our Playmaking program. Young people participate in a nine-week playwriting course taught by Megan Sandberg-Zakian and adapted for the Project by Daniel Judah Sklar from his book *Playmaking: Children Writing and Performing Their Own Plays*. At the end of the course, each child is given two actors, a theme, and a dramaturg/director who guides him or her through the writing of a play during a weekend retreat in the country (Kripplebush, New York, for this show). Tonight's performance is the end result.

### The 52nd Street Project Board of Directors

Ben Barenholtz  
Lisa Benavides  
Rachel Chanoff  
Cathy Dantchik  
Noël Dawkins  
Wendy Ettinger,  
*chair emeritus*  
Louis P. Friedman  
Stephen Graham, *chair*  
Larry Jones  
James McDaniel  
Frances McDormand  
Patricia M. Murphy, Esq.

Carol Ochs  
Willie Reale,  
*founder*  
Gus Rogerson  
Shirley Rumierk,  
*alumni member*  
José Soto, Jr.,  
*alumni member*  
Pamala Tyson  
Laura Valeroso  
Wendy vanden Heuvel  
John A. Vassilaros  
Jenny Wiener

### Special Thanks

We're extremely grateful to **Steve Gorn**, **Barbara Bash** and their son **Wiley**, who graciously allowed us to use their beautiful home in Stone Ridge, NY as our base of operations for the writer's retreat. We also owe a mini-van load of gratitude to **Joe White** and **Iris Brown** for cooking some mighty big (and good) meals and lining up all the other host families (who earn thanks as well). They were **Laura Shaine Cunningham**, **Mary Louise Wilson**, **Nicole** and **Paul Quinn**, **Deborah Freedman**, **Bill Woods**, and **Charles Miles** and **Naomi Freundlich**, and **Jason Downs** and **Sophia Rabb**. Finally, a big box of thanks go to **Oskar Eustis**, **Maria Goyanes**, **Christina Hale**, Al Clancy, and everyone else at the terrific **Public Theater**. We're very honored to be here!

### In-Kind Contributions

The Murphy Law Office; Benefit Cosmetics; Iris A. Brown; Bourjois Paris; Bumble and bumble; Ron Kastner and Capital Printing; Kenneth Cole Productions; Noggin; Scholastic, Inc.; Diageo Chateau & Estate Wines; Entertainment Weekly; Lucky Magazine; Microtouch/Finishing Touch; Molten Brown; MOP Cosmetics; Newman's Own; Pharma Print/Omni Graphics; Sesame Workshop; Wendy Stuhlberg; Terax America; John A. Vassilaros; Watkins, Inc.; Mayor's Office of Film & Television; Boylan's Bottling Co.; David Sneddon & Fairway Market; Lorraine Tobias & Imaginary Studios; ICI; Jive Records, part of Zomba Music Group; and Prime Films.

# OH NO YOU DIDN'T! - ACT 1

All original music composed by Patrick Barnes

## The Best Friends

by Breanna Straker, age 9. Dramaturg/Director: Maria Goyanes  
Costume Designer: Abby Redmond

Pencil Project .....Jeanine Serralles  
Big Black Eraser .....Mia Barron

“Mean” lyrics by Breanna Straker

## The Lock-Up

by Terrence Mack, age 11. Dramaturg/Director: John Sheehy  
Costume Designer: Abby Redmond

Young Ron .....Kenajuan Bentley  
Officer Bang .....Nancy Giles  
Joe .....Michael Potts

“Dead Man” lyrics by Terrence Mack

## Feeling Good

by Zakiya Jacob, age 9. Dramaturg/Director: Jessica Bauman  
Costume Designer: Chloe Chapin

Smiley .....Josh Hamilton  
Feala .....Megan Cramer  
Voice of the Painter .....Christopher Ramirez

“You Can’t Erase Me” and “Friends” lyrics by Zakiya Jacob

## Foolish Mortals, Magical Powers

by Marlowe Mendez, age 9. Dramaturg/Director: Claudia Zelevansky  
Costume Designer: Abby Redmond

Bad Guy/Dad .....Reg Flowers  
Prey .....Akyiaa Wilson

“You and Me” lyrics by Marlowe Mendez

## The Man, The Monkey, So Funny

by Chris Tineo, age 9. Dramaturg/Director: Jonathan Bernstein  
Costume Designer: Chloe Chapin

Smart Monkey .....Christopher Randolph  
The Man .....Danyon Davis  
The Nurse .....Riji Suh

“The Rhyming Song” and “The Rhyming Song Reprise” lyrics by Chris Tineo

👉 **Intermission!** 👈

# PLAYS THAT DO! - ACT II

## The War with the Barbies and Legoes

by Kyone Murphy, age 9. Dramaturg/Director: Kate Marks  
Costume Designer: Chloe Chapin

Max .....Bill Camp  
Rudy .....Ray Anthony Thomas  
Newscaster .....Noel Polanco  
Super .....Riji Suh

“This Is My War” lyrics by Kyone Murphy

## Sam and Samantha’s Friendship

by Chloe Moore, age 10. Dramaturg/Director: Glynis Rigsby  
Costume Designer: Abby Redmond

Samantha .....Cecilia Arana  
Sam .....Ephraim Lopez

“We’re Friends” lyrics by Chloe Moore

## The Halloween Night

by Nequai Figueroa, age 10. Dramaturg/Director: Michael Potts  
Costume Designer: Abby Redmond

Ciara .....Mary Louise Wilson  
Megan .....Florencia Lozano  
Landlord .....George Babiak

## Lost In The Woods

by Andy Reyes, age 9. Dramaturg/Director: Danny Goldstein  
Costume Designer: Chloe Chapin

Mucha Lucha .....Kevin Geer  
Deery .....Edie Falco  
Voice of Mucha Lucha’s Mother .....Reg Flowers  
Voice of Mucha Lucha Never Wanna Be .....Reg Flowers

“Mucha Lucha Never Wanna Be’s Song” and “Have Fun” lyrics by Andy Reyes



*We wish a very  
happy holiday  
season to all  
Projectiles,  
great and small!*



# SHOW PROGRAMS 2006-2010

The 52nd Street Project gratefully acknowledges the support of the following foundations and corporations: Artists Independent Network, LLC; Brunswick Group; Carnegie Corporation of New York; Citigroup Foundation; Clinton Seed Fund; Consolidated Edison; The Dramatists Guild Fund; Dramatists Play Service; The Horace W. Goldsmith Foundation; The William and Mary Greve Foundation; Fox Hollow Technologies, Inc.; The Hennessy Foundation; Holland Lodge Foundation, Inc.; Hurlbut Family Charitable Lead Trust; JKW Foundation; Betty E. & George B Kaiser Foundation; Lloyds TSB Bank plc; Lucille Lortel Foundation; James A. Macdonald Foundation; Ann M. Martin Foundation; Mellon Bank, N.A.; Newman's Own; New York Times Company Foundation; Noggin; People Places, Inc.; St. Vincent De Paul Foundation; Sesame Workshop; Showtime Networks Inc; Stranahan Foundation; The Surdna Foundation; Theatre Communications Group, Inc.; John A. Vassilaros & Son, Inc; Weil, Gotshal & Manges LLP; The Wiener Family Foundation; Yorke Construction Corporation; Felix Zaremba & Company, Inc; Zomba. In addition the following individuals made gifts of over \$200 to The 52nd Street Project this year (list is current as of 1/26/06):

Robert Abrams & Cynthia Vance	Denise Burse	Grace Lyu-Volkhausen	Marcia Santoni & John Morris
Jace Alexander & Maddie Corman	Angelina Fiordellisi	Greg MacPherson & Jane Perlmutter	Meredith Beeuwkes Scarlet Zeb Schachtel
Alexis Alexanian	Katherine Freedman	Bonnie Macsaveny & Tom Fetterman	Karin & Tom Schall
Lawrence Alleto	Louis & Patrice Friedman	Beverly Gasner	James Schamus
Cecilia Arana-Grant & Kevin Grant	Rose Gasner & Larry Chertoff	Peter Manning & André Bishop	Daniel Schnur
Emily Armstrong	Cora Cahan & Bernard Gersten	Sonya Martin	Robert Schnur
Dylan & Becky Baker	Scott Aaron Gewirtz & Laura Gewirtz	Mark Marvel	Maury Schott
Ben Barenholtz	Paul & Liz Giamatti	Robert Matza & Nina Matza	Lauren Seikaly & Michael Huber
Jessica Bauman & Ben Posel	Nancy Giles	Paul McCrane	Mitchell Semel & Colleen Carroll
Lisa Benavides & Tim Nelson	Kilty Gilmour	Fran McDormand & Joel Coen	Peter Shinoda
Stephanie Berger & Paul King	Tony Goldwyn & Jane Musky	Rick Meese & Dan Lori	Simone Silverman
Alexander & Elizabeth Bernstein	Stephen & Cathy Graham	Josie Merck & Jim Stevenson	Robert Evans & Gail Evans
Lewis Black	Connie Grappo & Lee Wilkof	Audrey & Danny Meyer	Landon Slane
Andrew Blackman & Tatiana Rutkowski	Myrna & Stephen Greenberg	Noël Dawkins & Joe Mihalow	Jean Stein
Richard Blau	Michael Greif & Jonathan Fried	Suzen Murakoshi & Mark Temme	Ben & Christine Stiller
Roger Bolton & Lynne Bolton	Emily Grishman & Susan Sampliner	Patricia M. Murphy, Esq. & Adam Spilka	R.L. Stine & Jane Stine
Buzz Bovshow	Jane Hayden Helmsley	Larry Nathanson	Susanna Styron & Darrell Larson
Becky Browder & Ted Neustadt	Nina Hellman & Jeremy Shamos	Don & Sara Nelson	Brian Swardstrom & Bonnie Bernstein
Susan Bruce & Peter Hedges	Peter Herdrich & Karen Trott	Fred Nelson	Daniel Swee
John Carr & Patricia Carr	Amy Herzig	Randy & Rona Nelson	Richard Sweren
Constance Casey	William Holtzman & S. Sylvia Shepard	James Neuberger & Helen Stambler	Leonard Tow
Rachel Chanoff	Katy Homans & Patterson Sims	Clea Newman	Liz Tuccillo
Howard Chatzinoff	Sarah Horowitz & David Venarde	Kevin O'Rourke & Edith Thurber	John Turturro & Katherine Borowitz
Julian Cohan & Greta Cohan	Saul Horowitz	Carol Ochs & Bruce MacVittie	Laura Valeroso & David Seidman
Ronald Cohen	Anne & Eli Jackson	Jacki Ochs & Jan Kroeze	Josephine Eke & Jason Valk
John Ellison Conlee	LaTanya & Samuel Jackson	Elizabeth Peters	Wendy vanden Heuvel & Brad Coley
Tricia Cooke & Ethan Coen	Sy Jacobs	Bat-Sheva & Thomas Peters	Claudia Wagner
Peter & Barbara Cross	Andrea Johnson	Susan Ochs Phillips	Mary Pat Walsh
Stephen & Sandra Crudgington	Kristen Johnston	Judy Goldman & Michael Pillinger	Borah & Mildred Walton
Billy Crudup	Larry & Mary Jones	Peter & Helen Randolph	Lynn & Sam Waterston
Suzanne Dallimore	Jane Kaczmarek	Paul Reale & Barbara McCrane	Sally & Lenny Weiss
Arthur Dantchik	Cindy Kaplan	Willie Reale & Jenny Gersten	Brenda Wehle & John Lynch
Cathy Dantchik	Seth & Beth Klarman	Lise Rehwaldt & Mark Roberts	Jane Bolster & Steve Wertimer
Leslie Dantchik	Mary Kong	Jay Reiss	Joe White & Iris Brown
Sherry Davis & Mark Alhadeff	Sarah & Steven Kraemer	Julie Ridge	Jenny Wiener & Jon Steingart
Peter & Judith Dawkins	Judy Kuhn & David Schwab	David & Anita Rogerson	Gary Winick
Richard & Rebecca Dresser	Stephen Lebovitz	Steve Sabba	Joanne Woodward & Paul Newman
Nora Ephron	Robert Sean Leonard	Arnold & Agnes Sametz	Jeffrey & Janine Yass
Heidi Ettinger	Liza Lerner	Laura Sametz & Anton Fig	
Wendy Ettinger & Derek McLane	Michael Loeb & Marjorie Loeb		
Robert Feldman			
Peter Jay Fernandez &			

## THE 52ND STREET PROJECT PRESENTS



FRIDAY, JANUARY 27 AT 7:30 P.M.  
 SATURDAY, JANUARY 28 AT 3:00 & 7:30 P.M.  
 SUNDAY, JANUARY 29 AT 3:00 P.M.

THE WOMEN'S INTERART ANNEX  
 500 W. 52ND ST., #2A

# WHICH WAY DID THEY GO? THEATRICAL PURSUITS

THE 2006 TWO-ON-TWO'S - JANUARY 27-29  
THE WOMEN'S INTERART ANNEX

## The 52nd Street Project Staff:

Gus Rogerson, Artistic Director  
 Carol Ochs, Executive Director  
 John Sheehy, Director of Development and Marketing  
 George "X-Acto" Babiak, Production Manager  
 Reg Flowers, Associate Artistic Director  
 Liz Bell, Director of Education  
 Diana Rojas, Executive Assistant  
 Mayleen Cancel, Education Assistant  
 Megan Cramer, Education Liaison  
 Chris Ceraso, Teen Dean  
 Solangee Acosta, Joshua Joya, Johanna Vidal, Receptionists  
 Interns: Courtney Cooke, Lindsey Newman

## Production Staff

**Composer:** Andrew Sherman

**Set Designer:** Kevin Joseph Roach

**Lighting Designer:** Greg MacPherson

**Costume Designer:** Mark Caswell

**Sound Designer:** Mayleen Cancel

**Stage Manager:**

Jean-Marie Donnelly

**Slide Designers:**

George Babiak, Reg Flowers

**Prop Design Team:**

George Babiak, Inge Baugh,

Courtney Cooke, Lindsey Newman,

Ben Patton, Nikki Philips,

John Sheehy, Rob Stier

**Furniture Crew:**

Luis Maldonado, Mark Gamero

**Prop Crew:**

Courtney Cooke, Nicole Fargardo,  
 Lindsey Newman, Jennifer Ramirez

**Load-in and Light Hang Crew:**

Varin Ayala, Courtney Cooke, Colin  
 Graham, Chris Henry, Lindsey  
 Newman, Doug Nervik, Tom Schall

**House Managers:**

Karin Schall, Mary Pat Walsh,  
 Liz Bell

**Chefs:**

George Babiak, Liz Bell, Carol  
 Ochs, John Sheehy

**Hosts:**

Steven Pempeluk, Terry Fitzpatrick,  
 Lili Taylor, Maria Tucci and Robert  
 Gottlieb



The Two-on-Two's Program is made possible with public funds from The New York State Council on the Arts, a state agency. The 52nd Street Project is a member of Art/NY and a participant in the New Generations Program, funded by Doris Duke Charitable Foundation/The Andrew W. Mellon Foundation and administered by Theatre Communications Group, the national organization for the American Theater.



## MAD COOL STUFF ON SALE!

Flyer Bars .....\$2.00, \$1.50 & \$1.00

*Shel Silverstein's "Fivey and Twoey" logo gear:*

Project Hoodies .....\$30.00

Project Caps .....\$15.00

Project Mugs .....\$5.00

Project Pencil 3-pack .....\$1.00

Project Notebooks .....\$5.00

Thank you for coming to **WHICH WAY DID THEY GO?** If you are not on our mailing list (or if your address has changed), please fill out this form and give it to us on your way out or mail it to the address below. We would also like to know if you are interested in becoming a volunteer. We need help in **all areas**, so be sure to fill out the entire form.

**PLEASE ADD ME TO YOUR MAILING LIST:**

01/06

NAME: \_\_\_\_\_

ADDRESS: \_\_\_\_\_

ZIP \_\_\_\_\_

HOME PHONE: \_\_\_\_\_

DAYTIME PHONE: \_\_\_\_\_

E-MAIL ADDRESS: \_\_\_\_\_

MY OCCUPATION: \_\_\_\_\_

MY HOBBIES: \_\_\_\_\_

**YES, I WOULD LIKE TO BE OF HELP. I CAN:**

- |   |   |  |
|---|---|--|
| <input type="checkbox"/> Help load in and out for shows | <input type="checkbox"/> Draw and/or paint  | <input type="checkbox"/> Help kids with homework |
| <input type="checkbox"/> Hang lights                    | <input type="checkbox"/> Help with mailings | <input type="checkbox"/> Teach kids a skill      |
| <input type="checkbox"/> Work on a backstage crew       | <input type="checkbox"/> Do office work     | <input type="checkbox"/> Be a chef at an event   |
| <input type="checkbox"/> Do graphic design              | <input type="checkbox"/> Design sound       | <input type="checkbox"/> Design and sew costumes |
| <input type="checkbox"/> Other (please specify) _____   |   |  |

**MY SCHEDULE IS:**

- Very flexible. I'm often available during weekdays.  
 Somewhat flexible. I can help on the occasional morning or afternoon during the week.  
 Not very flexible at all, but I've got some free time on evenings and weekends.

If you would like to mail this (and you're always welcome to enclose a tax-deductible contribution), you can send it to: **The 52nd Street Project**, 500 West 52nd St., New York, NY 10019. Or fax it to (212) 333-5598.



## Don't Miss Our Upcoming Shows!



# Any Day Now!

## PLAYS WORTH WAITING FOR

The Spring Edition of the Project's Playmaking Program

at the Calhoun School Theater  
on W. 81st St. and West End Ave.

At the moment, 10 kids are learning the fine art of Playwriting from our teacher, Reg Flowers. On March 31, April 1 and April 2, their plays will be performed by adult professional actors. Come watch the fun! Call (212) 642-5052 for reservations.

## THE 52<sup>ND</sup> STREET PROJECT TURNS



# GREATEST HITS

## THE PROJECT'S ANNIVERSARY BENEFIT

# MONDAY, MAY 1, 2006

The 52nd Street Project is a non-profit organization that brings children from the Hell's Kitchen neighborhood together with professional theater artists to create original theater. **Which Way Did They Go?** is a production of our Two-on-Two's program, in which an adult playwright crafts a piece for a pair of Project kids to perform. Another adult directs the kids for a month that includes an intensive three-day weekend in Dutchess County, New York. Tonight's performance is the final result.

### The 52nd Street Project Board of Directors

Ben Barenholtz  
Lisa Benavides  
Rachel Chanoff  
Cathy Dantchik  
Noël Dawkins  
Wendy Ettinger,  
*chair emeritus*  
Louis P. Friedman  
Stephen Graham, *chair*  
Larry Jones  
James McDaniel  
Frances McDormand  
Patricia M. Murphy, Esq.

Carol Ochs  
Willie Reale,  
*founder*  
Gus Rogerson  
Shirley Rumierk,  
*alumni member*  
José Soto, Jr.,  
*alumni member*  
Pamala Tyson  
Laura Valeroso  
Wendy vanden Heuvel  
John A. Vassilaros  
Jenny Wiener

### Special Thanks

We're grateful to **Margot, Ronnie, Josh**, and the rest of the staff at **Women's Interart Annex** for making their extremely convenient space available to us. We also owe big-time thanks to **Maria Tucci** and **Robert Gottlieb, Lili Taylor**, and **Steven Perepeluk** and **Terry Fitzpatrick**, all of whom graciously allowed us to use their upstate homes for three tumultuous and fun-filled days. Our gratitude also goes to Super Project Pal **Ron Fiorina** of **Boylan Bottling Co.**, **Mary Moore & D'Agostino's Supermarkets**, and board member **John A. Vassilaros** (a.k.a. Johnny Coffeeshopolis) for contributing our intermission refreshments.

### In-Kind Contributions

The Murphy Law Office; Benefit Cosmetics; Iris A. Brown; Bourjois Paris; Bumble and bumble; Ron Kastner and Capital Printing; Kenneth Cole Productions; Noggin; The Printing Store; Scholastic, Inc.; Diageo Chateau & Estate Wines; Entertainment Weekly; Lucky Magazine; Microtouch/Finishing Touch; Molten Brown; MOP Cosmetics; Newman's Own; Pharma Print/Omni Graphics; Sesame Workshop; Wendy Stuhlberg; Terax America; John A. Vassilaros; Watkins, Inc.; Mayor's Office of Film & Television; Boylan's Bottling Co.; David Sneddon & Fairway Market; Lorraine Tobias & Imaginary Studios; Jive Records, part of Zomba Music Group; and Prime Films.

# WHICH WAY DID THEY GO? - ACT I

All original music composed and played by Andrew Sherman

## Blues on the Red Planet

By Jerome Hairston. Directed by Evan Cabnet.

Bart .....Paul Dixon  
Z .....Alex Kehr

“Daddy Don’t Dig the Lum Lum Blues” lyrics by Jerome Hairston.

## The Future’s So Bright

By Madeleine George. Directed by Liza Steinberg.

Andromeda .....Johanna Vidal  
Luna .....Merlaine Mendez  
Voice of Cassandra .....Lindsey Newman

“I See Big Things For You” lyrics by Madeleine George.

## Diamond in the Rough

By Michael Bernard. Directed by Tom Schall.

Professor Havacandytreat .....Christopher Ramirez  
Chad .....Isayah Muller

“The Song of the Fight” lyrics by Michael Bernard.

☞ **Intermission!** ☜

Root Beer Floats, Coffee,  
and Flyer Bars in the lobby!

# WHICH WAY DID THEY GO? - ACT II

## Hand O’ Yo Bidness

By Reg Flowers. Directed by Megan Cramer.

June Macadamia .....Octavia Rodriguez  
Barley Flavour .....Aladino Olivares

“The Albatross Song” lyrics by Reg Flowers.

## Scoop

By Susan Kim. Directed by Becky White.

Angeline Powers .....Amanda Santos  
Tiffany Blakewell .....Kayelani Silva  
The Jaguar .....Luis Maldonado

“Respect” lyrics by Susan Kim.

## Not Funny!

By Erin Quinn Purcell. Directed by Michael Baron.

John Baker .....John Cuevas  
Cassiopeia Parker-Green .....Skyeblu Welsh

“Birthday Wish” and “Solo Flight” lyrics by Erin Quinn Purcell.



The 52nd Street Project gratefully acknowledges the support of the following foundations and corporations: Artists Independent Network, LLC; Brunswick Group; Carnegie Corporation of New York; Citigroup Foundation; Clinton Seed Fund; Consolidated Edison; The Dramatists Guild Fund; Dramatists Play Service; The Horace W. Goldsmith Foundation; The William and Mary Greve Foundation; Fox Hollow Technologies, Inc.; The Hennessy Foundation; Holland Lodge Foundation, Inc.; Hurlbut Family Charitable Lead Trust; JKW Foundation; Betty E. & George B Kaiser Foundation; Lloyds TSB Bank plc; Lucille Lortel Foundation; James A. Macdonald Foundation; Ann M. Martin Foundation; Mellon Bank, N.A.; Newman's Own; New York Times Company Foundation; Noggin; People Places, Inc.; St. Vincent De Paul Foundation; Sesame Workshop; Showtime Networks Inc; Stranahan Foundation; The Surdna Foundation; Theatre Communications Group, Inc.; John A. Vassilaros & Son, Inc; Weil, Gotshal & Manges LLP; The Wiener Family Foundation; Yorke Construction Corporation; Felix Zarembo & Company, Inc; Zomba. In addition the following individuals made gifts of over \$200 to The 52nd Street Project this year (list is current as of 1/26/06):

**GUS ROGERSON**  
ARTISTIC DIRECTOR

**CAROL OCHS**  
EXECUTIVE DIRECTOR

**REG FLOWERS**  
PLAYMAKING DIRECTOR

**THE 52ND  
STREET PROJECT  
PRESENTS**

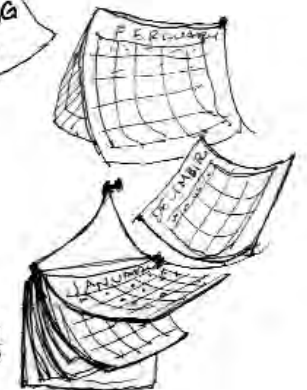

BILLIE COHEN

- |                                     |                                      |  |   |
|-------------------------------------|--------------------------------------|--|---|
| Robert Abrams & Cynthia Vance       | Denise Burse                         | Grace Lyu-Volkhausen                   | Marcia Santoni & John Morris            |
| Jace Alexander & Maddie Corman      | Angelina Fiordellisi                 | Greg MacPherson & Jane Perlmutter      | Meredith Beeuwkes Scarlet Zeb Schachtel |
| Alexis Alexanian                    | Katherine Freedman                   | Bonnie Macsaveny & Tom Fetterman       | Karin & Tom Schall                      |
| Lawrence Alleto                     | Beverly Gasner                       | Peter Manning & André Bishop           | James Schamus                           |
| Cecilia Arana-Grant & Kevin Grant   | Rose Gasner & Larry Chertoff         | Sonya Martin                           | Daniel Schnur                           |
| Emily Armstrong                     | Cora Cahan & Bernard Gersten         | Mark Marvel                            | Robert Schnur                           |
| Dylan & Becky Baker                 | Scott Aaron Gewirtz & Laura Gewirtz  | Robert Matza & Nina Matza              | Mauzy Schott                            |
| Ben Barenholtz                      | Paul & Liz Giamatti                  | Paul McCrane                           | Lauren Seikaly & Michael Huber          |
| Jessica Bauman & Ben Posel          | Nancy Giles                          | Fran McDormand & Joel Coen             | Mitchell Semel & Colleen Carroll        |
| Lisa Benavides & Tim Nelson         | Kilty Gilmour                        | Rick Meese & Dan Lori                  | Peter Shinoda                           |
| Stephanie Berger & Paul King        | Tony Goldwyn & Jane Musky            | Josie Merck & Jim Stevenson            | Simone Silverman                        |
| Alexander & Elizabeth Bernstein     | Stephen & Cathy Graham               | Audrey & Danny Meyer                   | Robert Evans & Gail Evans               |
| Lewis Black                         | Connie Grappo & Lee Wilkof           | Noël Dawkins & Joe Mihalov             | Landon Slane                            |
| Andrew Blackman & Tatiana Rutkowski | Myrna & Stephen Greenberg            | Suzen Murakoshi & Mark Temme           | Jean Stein                              |
| Richard Blau                        | Michael Greif & Jonathan Fried       | Patricia M. Murphy, Esq. & Adam Spilka | Ben & Christine Stiller                 |
| Roger Bolton & Lynne Bolton         | Emily Grishman & Susan Sampliner     | Larry Nathanson                        | R.L. Stine & Jane Stine                 |
| Buzz Bovshow                        | Jane Hayden Helmsley                 | Don & Sara Nelson                      | Susanna Styron & Darrell Larson         |
| Becky Browder & Ted Neustadt        | Nina Hellman & Jeremy Shamos         | Fred Nelson                            | Brian Swardstrom & Bonnie Bernstein     |
| Susan Bruce & Peter Hedges          | Peter Herdrich & Karen Trott         | Randy & Rona Nelson                    | Daniel Swee                             |
| John Carr & Patricia Carr           | Amy Herzig                           | James Neuberger & Helen Stambler       | Richard Sweren                          |
| Constance Casey                     | William Holtzman & S. Sylvia Shepard | Clea Newman                            | Leonard Tow                             |
| Rachel Chanoff                      | Katy Homans & Patterson Sims         | Kevin O'Rourke & Edith Thurber         | Liz Tuccillo                            |
| Howard Chatzino                     | Sarah Horowitz & David Venarde       | Carol Ochs & Bruce MacVittie           | John Turturro & Katherine Borowitz      |
| Julian Cohan & Greta Cohan          | Saul Horowitz                        | Jacki Ochs & Jan Kroeze                | Kevin O'Rourke & Edith Thurber          |
| Ronald Cohen                        | Anne & Eli Jackson                   | Elizabeth Peters                       | Laura Valeroso & David Seidman          |
| John Ellison Conlee                 | LaTanya & Samuel Jackson             | Bat-Sheva & Thomas Peters              | Josephine Eke & Jason Valk              |
| Tricia Cooke & Ethan Coen           | Sy Jacobs                            | Susan Ochs Phillips                    | Wendy vanden Heuvel & Brad Coley        |
| Peter & Barbara Cross               | Andrea Johnson                       | Judy Goldman & Michael Pillinger       | Claudia Wagner                          |
| Stephen & Sandra Crudgington        | Kristen Johnston                     | Peter & Helen Randolph                 | Mary Pat Walsh                          |
| Billy Crudup                        | Larry & Mary Jones                   | Paul Reale & Barbara McCrane           | Borah & Mildred Walton                  |
| Suzanne Dallimore                   | Jane Kaczmarek                       | Willie Reale & Jenny Gersten           | Lynn & Sam Waterston                    |
| Arthur Dantchik                     | Cindy Kaplan                         | Lise Rehwaldt & Mark Roberts           | Sally & Lenny Weiss                     |
| Cathy Dantchik                      | Seth & Beth Klarman                  | Jay Reiss                              | Brenda Wehle & John Lynch               |
| Leslie Dantchik                     | Mary Kong                            | Julie Ridge                            | Jane Bolster & Steve Wertimer           |
| Sherry Davis & Mark Alhadeff        | Sarah & Steven Kraemer               | David & Anita Rogerson                 | Joe White & Iris Brown                  |
| Peter & Judith Dawkins              | Judy Kuhn & David Schwab             | Steve Sabba                            | Jenny Wiener & Jon Steingart            |
| Richard & Rebecca Dresser           | Stephen Lebovitz                     | Arnold & Agnes Sametz                  | Jenny Wiener & Jon Steingart            |
| Nora Ephron                         | Robert Sean Leonard                  | Laura Sametz & Anton Fig               | Gary Winick                             |
| Heidi Ettinger                      | Liza Lerner                          |  | Joanne Woodward & Paul Newman           |
| Wendy Ettinger & Derek McLane       | Michael Loeb & Marjorie Loeb         |  | Jeffrey & Janine Yass                   |
| Robert Feldman                      |                                      |  |   |
| Peter Jay Fernandez &               |                                      |  |   |

**FRIDAY, MARCH 31 AT 7:30 P.M.**  
**SATURDAY, APRIL 1 AT 3:00 P.M. & 7:30 P.M.**  
**SUNDAY, APRIL 2 AT 3:00 P.M.**  
**THE PERFORMING ARTS CENTER AT**  
**THE CALHOUN SCHOOL**  
**433 WEST END AVENUE (CORNER OF 81ST ST.)**

# ANY DAY NOW

Plays Worth Waiting For - March 31 - April 2, 2006  
The Performing Arts Center at the Calhoun School

## The 52nd Street Project Staff:

Gus Rogerson, Artistic Director  
Carol Ochs, Executive Director  
John Sheehy, Director of Development and Marketing  
George "X-Acto" Babiak, Production Manager  
Reg Flowers, Associate Artistic Director  
Liz Bell, Director of Education  
Diana Rojas, Executive Assistant  
Mayleen Cancel, Education Assistant  
Jackie Frankel, Development Assistant  
Chris Ceraso, Teen Dean  
Iris A. Brown, Graphic Designer  
Joshua Joya, Solangee Acosta, Johanna Vidal, Receptionists  
Courtney Cooke and Lindsey Newman, Interns

## Production Staff

**Composer:** Greg Pliska  
**Musical Director:** Kim D. Sherman  
**Set Designer:** Kevin Joseph Roach  
**Lighting Designer:**  
Greg MacPherson  
**Costume Designers:**  
Crystal Thompson, Erin Chainani, &  
Vonia Arslanian.  
**Goddess of Sound:**  
Vanessa Valdes  
**Stage Manager:**  
Sadie Bancroft  
**Slide Designers:**  
George Babiak, Mike Sell,  
and the Project's Slide Art Archive.  
**"Any Day" Art:** Billie Cohen

## Prop Design Team:

George Babiak, Courtney Cooke,  
Jackie Frankel, Jake Friedman,  
Lindsey Newman, Nikki Phillips, &  
John Sheehy.

## Backstage Crew:

Courtney Cooke, Luis Maldonado,  
Lindsey Newman, & Johanna Vidal.

## Load-in and Light Hang Crew:

Andy Boccanfuso, Ray Harold,  
Kevin Roach, Jay Scott, Timothy  
Thomas, Virginia, & Charlie  
Tocantins.

## House Managers:

Karin Schall, Jackie Frankel,  
& Liz Bell

The Playmaking Program is made possible with public funds from The New York State Council on the Arts, a state agency, and the NEA. The 52nd Street Project is a member of Art/NY and a participant in the New Generations Program, funded by Doris Duke Charitable Foundation/The Andrew W. Mellon Foundation and administered by Theatre Communications Group, the national organization for the American Theater.



# COOL STUFF ON SALE!

Flyer Bars .....\$2.00, \$1.50 & \$1.00

*Shel Silverstein's "Fivey and Twoey" logo gear:*

Project "Hoodies" .....\$25.00

Project Ball Caps .....\$20.00

Project T-Shirts .....\$12.00

Project Mugs .....\$5.00

Project Notebooks .....\$5.00

Project Pencil 3-pack .....\$1.00

Thank you for coming to **ANY DAY NOW**. If you are not on our mailing list (or if your address has changed), please fill out this form and give it to us on your way out or mail it to the address below. We would also like to know if you are interested in becoming a volunteer. We need help in **all areas**, so be sure to fill out the entire form.

## PLEASE ADD ME TO YOUR MAILING LIST:

04/06

NAME: \_\_\_\_\_

ADDRESS: \_\_\_\_\_

ZIP \_\_\_\_\_

HOME PHONE: \_\_\_\_\_

DAYTIME PHONE: \_\_\_\_\_

E-MAIL ADDRESS: \_\_\_\_\_

MY OCCUPATION: \_\_\_\_\_

MY HOBBIES: \_\_\_\_\_

## YES, I WOULD LIKE TO BE OF HELP. I CAN:

- |   |   |  |
|---|---|--|
| <input type="checkbox"/> Help load in and out for shows | <input type="checkbox"/> Draw and/or paint  | <input type="checkbox"/> Help kids with homework |
| <input type="checkbox"/> Hang lights                    | <input type="checkbox"/> Help with mailings | <input type="checkbox"/> Teach kids a skill      |
| <input type="checkbox"/> Work on a backstage crew       | <input type="checkbox"/> Do office work     | <input type="checkbox"/> Be a chef at an event   |
| <input type="checkbox"/> Do graphic design              | <input type="checkbox"/> Design sound       | <input type="checkbox"/> Design and sew costumes |
| <input type="checkbox"/> Other (please specify) _____   |   |  |

## MY SCHEDULE IS:

- Very flexible. I'm often available during weekdays.
- Somewhat flexible. I can help on the occasional morning or afternoon during the week.
- Not very flexible at all, but I've got some free time on evenings and weekends.

If you would like to mail this (and you're always welcome to enclose a tax-deductible contribution), you can send it to: **The 52nd Street Project**, 500 West 52nd St., New York, NY 10019. Or fax it to (212) 333-5598.

**Don't Miss Our Upcoming Shows!**

**THE 52<sup>ND</sup> STREET PROJECT  
TURNS**



**GREATEST HITS**  
**THE PROJECT'S ANNIVERSARY BENEFIT**  
**MONDAY, MAY 1, 2006**

**ANOTHER COUNTRY  
HEARD FROM:**

**THE INTERNATIONAL PLAYS**

*THE 2006 ONE-ON-ONES - TWO SEPARATE PRODUCTIONS!  
KIDS AND ADULTS ON STAGE TOGETHER!*

**JULY 20-23 and AUGUST 17-20**

The 52nd Street Project is a non-profit organization that brings children from the Hell's Kitchen neighborhood together with professional theater artists to create original theater. **ANY DAY NOW** is a production of our Playmaking program. Young people participate in a nine-week playwriting course taught by Reg Flowers and adapted for the Project by Daniel Judah Sklar from his book *Playmaking: Children Writing and Performing Their Own Plays*. At the end of the course, each child is given two actors, a theme, and a dramaturg/director who guides him or her through the writing of a play during a weekend retreat in the country (Kent, Connecticut, for this show). Tonight's performance is the end result.

---

**The 52nd Street Project Board of Directors**

Ben Barenholtz  
Lisa Benavides  
Rachel Chanoff  
Cathy Dantchik  
Noël Dawkins  
Wendy Ettinger,  
*chair emeritus*  
Louis P. Friedman  
Stephen Graham, *chair*  
Larry Jones  
James McDaniel  
Frances McDormand  
Patricia M. Murphy, Esq.

Carol Ochs  
Willie Reale,  
*founder*  
Gus Rogerson  
Shirley Rumierk,  
*alumni member*  
José Soto, Jr.,  
*alumni member*  
Pamala Tyson  
Laura Valeroso  
Wendy vanden Heuvel  
John A. Vassilaros  
Jenny Wiener

---

**Special Thanks**

We're grateful to **Stephen, Cathy, Juliet, and Tommy Graham** for graciously allowing us to bring the chaos of a Playmaking weekend to their lovely home in Kent, Connecticut. Their staff gets a round of applause, too. Thanks also go to **Sam and Lynn Waterston, and Emily Armstrong and Kevin and Patrick Gannon** for providing accommodations. Thanks also to **Aurin Squire** for helping out in Playmaking class.

---

**In-Kind Contributions**

The Murphy Law Office; Benefit Cosmetics; Iris A. Brown; Comptoir Sud Pacifique, Ron Kastner and Capital Printing; Kenneth Cole Productions; Noggin; Entertainment Weekly; Newman's Own; Pharma Print/Omni Graphics; Sesame Workshop; Wendy Stuhlberg; John A. Vassilaros; Watkins, Inc.; Mayor's Office of Film & Television; Boylan's Bottling Co.; Lorraine Tobias & Imaginary Studios; Warner Chappell Music Group, Simon Spotlight Entertainment, an imprint of Simon and Schuster; Hudson Scenic, Noggin/The N; and Prime Films.

## ANY DAY NOW - ACT I

All original music composed by Greg Pliska  
and performed by Kim D. Sherman

### Best Friends Never Known

by Kyle Fargardo, age 10. Dramaturg: Gus Rogerson.  
Director: Reg Flowers Costume Designer: Erin Chainani

Brock Plack .....John Conlee  
Carlos Finger .....Fred Armisen  
Psychologist .....John Sheehy

“Friends Forever” lyrics by Kyle Fargardo

### Flowers and Magic

by Lily Capstick, age 9. Dramaturg/Director: Alex Barretto  
Costume Designer: Vonja Arslanian

Ariana .....Enid Graham  
Flower Girl .....Annie Torsiglieri  
Flower People .....Courtney Cooke & Johanna Vidal  
Flower Girl’s Mom’s Voice .....Lindsey Newman

### The Wondering Dog

by Jamie Yip, age 10. Dramaturg/Director:Liliana Amador  
Costume Designer: Erin Chainani

Jake .....Emilio Delgado  
Jessica .....Riji Suh

“The Things I Hate” lyrics by Jamie Yip

### Bullies

by John Cacomanolis, age 10. Dramaturg/Director: Josh Lewis  
Costume Designer: Vonja Arslanian

Billy Bob .....Carlo Alban  
Alex .....Brienan Bryant  
Billy G. Joe’s Voice .....Luis Maldonado

### Mr. TV and Mr. Camera

by Devin Gonzalez, age 9. Dramaturg/Director: George Babiak  
Costume Designers: George Babiak and Crystal Thompson

Mr. TV .....David Zayas  
Mr. Camera .....Felix Solis

“Why Am I So Lonely” lyrics by Devin Gonzalez.

## ANY DAY NOW - ACT II

### Die

by Maximo Jimenez, age 11. Dramaturg/Director: Rick Meese  
Costume Designer: Erin Chainani

Mr. Tree .....Peter Maloney  
Bob .....David Lansbury  
Beaver .....Luis Maldonado

### In Her Shoes

by Kiana Hernandez, age 9. Dramaturg/Director: Patricia MacGregor  
Costume Designer: Erin Chainani

Lula .....Liza Colon-Zayas  
Sweetie Pie .....Deirdre O’Connell

“Pushed Away,” “World Dancing” and “Best Friends” lyrics by Kiana Hernandez

### Evelese’s Chance

by Ashley Torres, age 11. Dramaturg/Director: Sonia Manzano  
Costume Designer: Crystal Thompson

Evelese Santiago .....Myra Lucretia Taylor  
Milagros De Jesus .....Phyllis Somerville  
Brian and Michelle .....Luis Maldonado & Johanna Vidal

“Surprise” lyrics by Ashley Torres

### Family In Garden

by Simone Lindo, age 11. Dramaturg: Rebecca Masback  
Director: Sandi Carroll Costume Designer: Crystal Thompson

Josy .....Winslow Corbett  
Jo .....Rebecca Masback  
Owner .....Lindsey Newman

### It Stinks of FHN News

by Arpad West, age 10. Dramaturg/Director: Carlos Armesto  
Costume Designer: Vonja Arslanian

Dacy Flow .....Kathy Hiler  
James Kiky .....Howard Overshown  
Robinson .....Reg Flowers

“There’s Four Names” and “He Broked Us” lyrics by Arpad West

# I N T E R M I S S I O N

Honorary Chair  
Sam Waterston  
and Corporate Host

Ars Nova

and the Board of Directors of  
The 52nd Street Project present

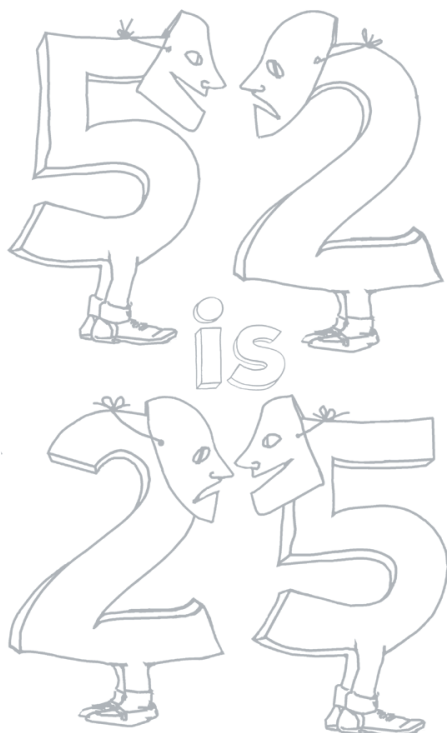

**THE 52ND STREET PROJECT'S  
GREATEST HITS  
MAY 1, 2006  
AT GOTHAM HALL**

**BOARD CHAIR**

Stephen Graham

**EXECUTIVE DIRECTOR**

Carol Ochs

**ARTISTIC DIRECTOR**

Gus Rogerson

**CO-CHAIRS**

Lisa Benavides  
Becky Browder  
Cathy Dantchik  
Louis P. Friedman  
Patrice Friedman

Jenny Gersten  
Karin Schall  
Laura Valeroso  
Mary Pat Walsh  
Jenny Wiener

**THE BOARD OF DIRECTORS**

Ben Barenholtz  
Lisa Benavides  
Rachel Chanoff  
Cathy Dantchik  
Wendy Ettinger,  
*chair emeritus*  
Louis P. Friedman  
Stephen Graham, *chair*  
Larry Jones  
James McDaniel  
Frances McDormand  
Noël Mihalow

Patricia M. Murphy, Esq.  
Carol Ochs  
Willie Reale, *founder*  
Gus Rogerson  
Shirley Rumierk,  
*alumni member*  
José Soto, Jr.,  
*alumni member*  
Pamala Tyson  
Laura Valeroso  
Wendy vanden Heuvel  
John A. Vassilaros

Jenny Wiener

**THE 52ND STREET PROJECT  
GRATEFULLY ACKNOWLEDGES...**

Mario Badescu  
Benefit Cosmetics  
Iris A. Brown  
Capital Printing/Ronald J. Kastner  
Kenneth Cole Productions  
Comptoir Sud Pacifique  
William Curran, Curran Affair  
Diageo Chateau & Estate Wines Co.  
Entertainment Weekly  
Frédéric Fekkai & Company, LLC  
Newman's Own  
Noggin/The N  
Pharma/Omni Printing  
Sesame Workshop  
Showman Fabricators  
Simon Spotlight  
*an imprint of Simon & Schuster*  
Wendy Stulberg  
John A. Vassilaros & Sons  
Warner/Chappell Music, Inc.  
Watkins Incorporated  
*Healthier Living Since 1868*

**THE SHOW**

Your Host: Sam Waterston

**Blast from the Past**

By Willie Reale and Henry Krieger  
Sung by Cathy and Fifi Fernandez,  
Megan Cramer, and Reg Flowers

**In the World Out There**

By Dan Berrett and Kim D. Sherman  
Sung by Michael Potts and Stephen Galimidi

**Money**

By Solangee Acosta, age 12, and Rusty Magee  
Sung by Judy Kuhn

**Like You - Like You**

By Skyeblu Welsh, age 12, and Loren Toolajian  
Sung by Malcolm Gets and Judy Kuhn

**Amanda's Song**

by Ariana Casablanca, age 11, and Rusty Magee  
Sung by Marva Hicks

**Underwear Man and Kathy**

By Frankie Ventura, age 9, and Rusty Magee  
Sung by Lee Wilkof and Anne Torsiglieri

**Old Friend, Old Friend**

By Willie Reale and Kim D. Sherman  
Sung by Malcolm Gets and Michael Potts

**Mean**

By Breanna Straker, age 9, and Patrick Barnes  
Sung by Marva Hicks and Anne Torsiglieri

**Friends Forever**

By Kyle Fargardo, age 10, and Greg Pliska  
Sung by John Conlee and David Costabile

**Supreme Happiness**

By Shirley Rumierk and Henry Krieger  
Sung by Marva Hicks and the Company

Director . . . . .Jonathan Bernstein  
Music Direction . . . . .Larry Yurman  
Music Supervision . . . . .Kim D.Sherman  
Drums . . . . .Anton Fig  
Guitar . . . . .Peter Bernstein  
Lighting Design . . . . .Greg MacPherson  
Sound Design . . . . .Scott Lehrer  
Stage Manager . . . . .Patricia McGregor

## PLATINUM RECORDS

The Dantchik Family  
Patrice & Louis Friedman  
Cathy & Stephen Graham  
Jenny Wiener & Jon Steingart, Ars Nova

## CHART TOPPERS

Wendy Ettinger & Derek McLane  
Janine & Jeffrey Yass

## DANCE REMIXERS

Ira Pittelman  
Joanne Woodward & Paul Newman

## COMPILATION ALBUMS

CBS Corporation  
Angelina Fiordellisi & Matt Williams  
Amy Friedman, Noggin/The N  
Lloyds TSB Bank plc  
Grace Lyu-Volckhausen  
HBO  
Betsy MacIsaac & Robert Goldberg, Yorke  
Construction Corporation  
Noël & Joe Mihalow, The Dawkins Family  
Foundation  
Fred Nelson  
Jonathan Rose Companies, Inc.  
Sesame Workshop  
Shearman & Sterling LLP  
Jeff Tauffield, Kekst & Co.  
Laura Valeroso & David Seidman  
Wendy vanden Heuvel

## POWER BALLADEERS

Laurie Becker  
Carol & Michael Bell  
Lisa Benavides & Tim Blake Nelson  
Gavin Berger & Craig Berggren  
Elizabeth & Alexander Bernstein  
André Bishop & Peter Manning  
Tessa Blake & Ian Williams  
Brunswick Group LLC  
Constance Casey  
Elizabeth Cooper Davis & Gordon J. Davis  
Robert de Rothschild  
Josephine Eke & Jason Valk  
Ellen Freudenheim & Daniel Wiener  
Jenny Gersten & Willie Reale  
Nancy Giles

Sarah Horowitz & David Venarde  
Felicia & Sy Jacobs  
Mary Kong  
Steven Lebovitz  
Ilana Levine & Dominic Fumusa  
John S. Lyons  
Audrey & Danny Meyer  
Jane Musky & Tony Goldwyn  
Rona & Randy Nelson  
Carol Ochs & Bruce MacVittie  
Jane Perlmutter & Greg MacPherson  
Anita A. & David S. Rogerson  
Erica Schmidt & Peter Dinklage  
Steve Sabba, Tax Pro Financial Network, Inc.  
Gaby Salick & Robert Sean Leonard  
Heidi & Stefan Selig  
Maury Schott  
Jane & R.L. Stine  
Liz Tuccillo  
Law Offices of Claudia Wagner  
Dr. Mildred Collier Walton  
Mary Pat Walsh  
Yildiz Yuksek & Richard Blackstone

## BREAKOUT SINGLES

Cecilia Arana-Grant & Kevin Grant	Rebecca & Richard Dresser
Emily Armstrong & Thomas Patrick Gannon	Anita Flanagan
Jonathan E. Aviv	Alison Fraser & Nat Magee
Ben Barenholtz	Bev Gasner
Jessica Bauman & Ben Posel	Rose Gasner
Jane Bolster & Steve Wertimer	Jilian Cahan Gersten
Buzz Bovshow	Elizabeth & Paul Giamatti
Becky Browder & Ted Neustadt	Kilty Gilmour
Michelle Buffington	Michael Greif & Jonathan Fried
Denise Burse & Peter Jay Fernandez	Janet Grillo
Kate Burton & Michael Ritchie	Emily Grishman & Susan Sampliner
Sharon Chantiles	Lisa J. Gugenheim & Lawrence Nathanson
Rachel Chanoff	Annie Hausman
Darrah Cloud & Dave Owens	Nancy Hechinger
Ruth Cohen & Robert Usdin	Amy Herzig
Penelope Collins	Kathryn & Matthew Hobbs
Ray Connors	Mark Horowitz
Tricia Cooke & Ethan Coen	Linda LeRoy Janklow
Maddie Corman & Jace Alexander	Thomas Jaycox
David Costabile	Amanda Johns
Bill Coury & Martin Fettner	Bonnie Kantor
Craig Cox	Cynthia Kaplan & David Froelich
Jeff Cox	Beth S. & Seth A. Klarman
Thomasine Dolan & Whitney Dow	Warren Leight
	Anna Li
	Adrienne Lobel & Mark Linn-Baker
	Katherine K. Lumb & Christopher Bonanos

Jodie Markell	Whitney Scott & Peter Jacobson
Barbara McCrane & Paul Reale	Mitchell R. Semel
Fran McDormand & Joel Coen	Stephanie Sharis
Patricia McGuire & Ned Eisenberg	Sylvia Shepard & Willy Holtzman
Rick Meese & Dan Lori	John Steber & Robert Shaffron
Emily & John Morgan	Susanna Styron & Darrell Larson
Suzen Murakoshi & Mark Temme	Richard Sweren
Patricia Murphy & Adam Spilka	Alice & Daniel Swistel
Jacki Ochs & Jan Kroeze	Brenda Thomas
Maria & Paul Onderdonk	Tracy Thorne & Edmund Lewis
Bat-Sheva & Thomas Peters	Edith Thurber & Kevin O'Rourke
Judy & Michael Pillingier	Karen Trott & Peter Herdrich
Christopher Randolph	Cynthia Vance & Robert Abrams
Daryl Roth	Wendy Ward
Ida Roth	Sharon Washington
Martha Roth & Bill Irwin	Carol Whitesides
Agnes Sametz	Dana L. Williams & Donald Scardino
Laura Sametz & Anton Fig	Carole Yass
Karin & Thomas Schall	Jack Schlegel
Robin Schanzbach	
Jack Schlegel	

List current as of 4/26/06

## THE 52ND STREET PROJECT STAFF

Gus Rogerson, Artistic Director  
Carol Ochs, Executive Director  
John Sheehy, Dir. of Development and Marketing  
George Babiak, Production Manager  
Reg Flowers, Associate Artistic Director  
Liz Bell, Director of Education  
Mayleen Cancel, Education Assistant  
Diana Rojas, Executive Assistant  
Jackie Frankel, Development Assistant  
Chris Ceraso, Teen Dean  
Iris A. Brown, Graphic Designer  
and  
Ruth Cohen, Capital Campaign Consultant

## BENEFIT VOLUNTEERS

Winslow Corbett, Perry McBain Daniel,  
Bryan Gmitter, Chris Hammett, Susan McGinnis,  
Catherine Mueller, Doug Nervik, Nikki Phillips,  
Kari Riely, Kim D. Sherman, Vanessa Valdes

## SPECIAL THANKS

Becky Browder, William Curran, Liz Flahive,  
Terry Fitzpatrick, Amy Friedman,  
Jenny Gersten, Mark Jacobs, John Laird,  
Barbara McCrane, Christopher Randolph,  
Karin & Tom Schall, Mary Pat Walsh



The **52nd Street Project** is a non-profit organization that brings children from the Hell's Kitchen neighborhood together with professional theater artists to create original theater. The Replay program gives children who are graduates of the Project's Playmaking class a chance to hone their skills in an advanced writing workshop taught by **Reg Flowers**. Over the nine weeks of Replay class, these young playwrights explored varied sources of inspiration, including a visit to the Whitney Museum and a trip to the theater, studied dramatic structure, and learned to embrace the dreaded rewrite. The resulting plays are featured in tonight's reading.

### Special Thanks

We're grateful to **James, Adam** and everyone else at **The Signature Theatre** for making this evening possible. The plays wouldn't have made it to the page without the help of the Replay class volunteers **Varin Ayala, Barnett Cohen, Angel Desai, Joe Haupt, Amina Henry, Stephanie Keating, Rita Marchelya, Nana Mensa, and Virginia Vitzthum**. Big ups to **Erin Funck and Edie Demas** at the **New Victory Theatre** for hooking the class up with tickets to "*Brundibar*." We'd like to thank the Cohen family and friends for their support of this project.

### The Project Staff

Gus Rogerson . . . . .	Artistic Director
Carol Ochs . . . . .	Executive Director
John Sheehy . . . . .	Director of Development and Marketing
George Babiak . . . . .	Production Manager
Reg Flowers . . . . .	Associate Artistic Director
Liz Bell . . . . .	Director of Education
Diana Rojas . . . . .	Executive Assistant
Mayleen Cancel . . . . .	Education Assistant
Jackie Frankel . . . . .	Development Assistant
Chris Ceraso . . . . .	Teen Dean
Iris A. Brown . . . . .	Graphic Designer
Receptionists . . . . .	Solangee Acosta, Johanna Vidal
Capital Campaign Consultant . . . . .	Ruth Cohen
Interns . . . . .	Lauren Blumenfeld, Sean Kenealy, Drew Vanderburg

### The 52nd Street Project Board of Directors

Ben Barenholtz	Carol Ochs
Lisa Benavides	Willie Reale,
Rachel Chanoff	<i>founder</i>
Cathy Dantchik	Gus Rogerson
Noël Dawkins	Shirley Rumierk,
Wendy Ettinger,	<i>alumni member</i>
<i>chair emeritus</i>	José Soto, Jr.,
Louis P. Friedman	<i>alumni member</i>
Stephen Graham, <i>chair</i>	Pamala Tyson
Larry Jones	Laura Valeroso
James McDaniel	Wendy vanden Heuvel
Frances McDormand	John A. Vassilaros
Patricia M. Murphy, Esq.	Jenny Wiener

The 52nd Street Project Presents  
The Lorraine Cohen

# Replay Readings

10 new plays by  
10 young playwrights

Monday, June 5, 2006  
7:30 p.m.

The Signature Theatre at  
The Peter Norton Space  
555 West 42nd Street

## Alex Hits the Ball

By Andy Reyes, age 10  
Directed by Evan Cabnet

Ms. Anderson/Mom .....Frances McDormand  
Alex .....Alex Draper  
Derek .....Tom Schall  
Coach .....John Sheehy

## Chicken World

by Zakiya Jacob, age 10  
Directed by Julie Boyd

Tom 550 .....Cynthia Nixon  
Tom 5,065 .....Edward O'Blenis  
Other Tom .....Joe Haupt

## The Struggling Twins

By Luisa Santiago, age 10  
Directed by Erica Schmidt

Rochelle .....Pascale Armand  
Susane .....Marsha Stephanie Blake  
Librarian .....Erica Schmidt

## The Argument

by Analis "Fifi" Fernandez, age 10  
Directed by Jonathan Bernstein

Willie .....Frank Wood  
Officer/Judge Rainbow .....Stevie Ray Dallimore  
Beonica .....Frances McDormand  
Boyfriend of Beonica .....Joe Haupt  
Beautifulll .....Virginia Vitzthum  
Josh .....Barnett Cohen  
Other prisoners .....The Company

## Duck and Rabbit

By Laron Holt, age 10  
Directed by Elizabeth Giamatti

Rabbit .....Saidah Arrika Ekulona  
Duck .....Felix Solis

## The Friendship of Life

By Stephanie Marion, age 12  
Directed by Julie Boyd

Sweetie Cool .....Edward O'Blenis  
Valentine Heart .....Cynthia Nixon

## Killing Spree

by Terrence Mack, age 12  
Directed by Evan Cabnet

Farrel .....Alex Draper  
Poorman/Dr. Phil .....Tom Schall  
Bodyguard .....John Sheehy

## Star and Twinkle Meet the Sun

by Joyce Cheung, age 10  
Directed by Erica Schmidt

Star .....Marsha Stephanie Blake  
Twinkle .....Pascale Armand  
Sun .....Frances McDormand

## He Bird Learns English

by Malik Velazquez, age 10  
Directed by Elizabeth Giamatti

Master/She Bird .....Saidah Arrika Ekulona  
He Bird .....Felix Solis

## The Boxer

By George Keller, age 11  
Directed by Jonathan Bernstein

Tommy Sanchez .....Stevie Ray Dallimore  
Jackie .....Frank Wood  
Robinson/Johnny's Coach/Chris's Coach .....George Babiak  
Mikey/Johnny/Chris .....Barnett Cohen  
Referee/Announcer .....Jonathan Bernstein  
Girl With A Sign .....Virginia Vitzthum  
Doctor .....Frances McDormand

**B  
R  
I  
E  
F  
  
I  
N  
T  
E  
R  
M  
I  
S  
S  
I  
O  
N**

**The 52nd Street Project** is a non-profit organization that brings children from the Hell's Kitchen neighborhood together with professional theater artists to create original theater.

The Teen Ensemble is the final step in our kids' training: a two-year acting class that culminates in the production of a full-length play by William Shakespeare. Past Teen Ensembles have taken their shows to London and the South of France. The teens you're seeing tonight are completing their first year of Ensemble work.

### Special Thanks

We're grateful to **Eric Karpeles** and **Mike Sell** for hosting the Ensemble for a glorious day this past Saturday at their home in Pennsylvania. A big fat helping of thanks to **Josh Liveright**, **Chris Henry**, and the **Women's Interart Annex** for being so generous with their space and tolerating our erratic rehearsal schedule.

### The Project Staff

Gus Rogerson . . . . . Artistic Director  
 Carol Ochs . . . . . Executive Director  
 John Sheehy . . . . . Director of Development and Marketing  
 George Babiak . . . . . Production Manager  
 Reg Flowers . . . . . Associate Artistic Director  
 Liz Bell . . . . . Director of Education  
 Diana Rojas . . . . . Executive Assistant  
 Megan Cramer . . . . . Education Liaison  
 Mayleen Cancel . . . . . Education Assistant  
 Jackie Frankel . . . . . Development Assistant  
 Chris Ceraso . . . . . Teen Dean  
 Iris A. Brown . . . . . Graphic Designer  
 Receptionists . . . . . Solangee Acosta, Johanna Vidal  
 Capital Campaign Consultant . . . . . Ruth Cohen  
 Interns . . . . . Lauren Blumenfeld, Sean Kenealy,  
 Drew Vanderburg

### The 52nd Street Project Board of Directors

Ben Barenholtz	Carol Ochs
Lisa Benavides	Willie Reale, <i>founder</i>
Rachel Chanoff	Gus Rogerson
Cathy Dantchik	Shirley Rumierk, <i>alumni member</i>
Noël Dawkins	José Soto, Jr., <i>alumni member</i>
Wendy Ettinger, <i>chair emeritus</i>	Pamala Tyson
Louis P. Friedman	Laura Valeroso
Stephen Graham, <i>chair</i>	Wendy vanden Heuvel
Larry Jones	John A. Vassilaros
James McDaniel	Jenny Wiener
Frances McDormand	
Patricia M. Murphy, Esq.	

THE 52ND STREET PROJECT PRESENTS

# NEW PLAYS of NEW PLAYERS



## FIVE NEW PLAYS PERFORMED BY THE 52ND STREET PROJECT TEEN ENSEMBLE

Thursday, June 22, 2006

THE WOMEN'S  
 INTERART ANNEX

## **CORNOGRAPHY**

*by Reg Flowers*

*Directed by  
Gus Rogerson*



Mike .....Adrian Zambrano  
Ben .....Joshua Joya  
Tabby .....Nicole Fargardo



## **ABOVE IT ALL**

*by Leslie Ayvazian*

*Directed by  
George Babiak*

Master Zane .....Zebulun Santiago  
Shelley Dell .....Nikki Rosario

## **THE LAST GOODBYE**

*by Megan Mostyn-Brown*

*Directed by  
Megan Cramer*



Damon .....Alex Tomas  
Mags .....Suzette Santana  
Lily .....Anastasia Kehr

## **DINNER, LUNCH AND BREAKFAST**

*by David Auburn*

*Directed by  
Julia Gibson*



The Waiter .....Christian Alvarez  
The Woman .....Kamila Jacob



## **DOMINICA...**

*by Stephen Adly Guirgis*

*Directed by  
Chris Ceraso*

Carlos .....Anthony Mejia  
Rolando .....Mark Gamero  
Mylene .....Megan Cruz

Costume Consultant: Viviane Galloway

Sound Designer: Drew Vanderburg

Stage Manager: Sean Kenealy

Backstage Crew: Lauren Blumenfeld

*New Plays for New Players is performed  
without an intermission.*

The 52nd Street Project gratefully acknowledges the support of the following foundations and corporations: AOL Time Warner, Inc.; BKS Architects LLP; Bloomberg; The Brenner Family Foundation; Brunswick Group; Carnegie Corporation of New York; CBS; Consolidated Edison; The Dermot Company; The Dramatists Guild Fund; Dramatists Play Service; Joele Frank & Wilkinson Brimmer Katcher; The Horace W. Goldsmith Foundation; The William & Mary Greve Foundation; The Hennessy Foundation; Holland Lodge Foundation, Inc.; Hurlbut Family Charitable Lead Trust; Kekst & Company; Latham & Watkins, LLP; Lloyds TSB Bank plc; James A. Macdonald Foundation; Ann M. Martin Foundation; Mellon Bank, N.A.; Noggins; Jonathan Rose Companies; Shapiro & Lobel; Showtime Networks Inc; St. Vincent De Paul Foundation; Shearman & Sterling, LLP; Stranahan Foundation; The Sordna Foundation; Theatre Communications Group, Inc.; The Tow Foundation; John A. Vassilaros & Son, Inc; The Law Offices of Claudia Wagner, Weil, Gotshal & Manges LLP; Yorke Construction Corp. In addition, the following individuals made gifts of over \$200 to The 52nd Street Project this past year (list is current as of 7/19/06):

Raymond & Elizabeth Abbott  
 Robert Abrams & Cynthia Vance  
 Jace Alexander & Maddie Corman  
 Cecilia Arana-Grant & Kevin Grant  
 Jonathan Aviv  
 Dylan & Becky Baker  
 Ben Barenholtz  
 Jessica Bauman  
 Christopher Beale &  
 Francesca Beale  
 Laurie Becker & Rick Sweren  
 Michael Bell & Carol Bell  
 Lisa Benavides & Tim Nelson  
 Stephanie Berger & Paul King  
 Craig Berggren  
 Elizabeth & Alexander Bernstein  
 Richard Blackstone &  
 Yldeez Yuksek  
 Tessa Blake  
 Buzz Bovshov  
 Becky Browder & Ted Neustadt  
 Michelle Buffington  
 Nataalka Bukalo  
 Kate Burton & Michael Ritchie  
 John Carr & Patricia Carr  
 Constance Casey  
 Rachel Chanoff  
 Sharon Chantlie  
 Darah Cloud & Dave Owens  
 Julian Cohan & Greta Cohan  
 David Cohen & Sandra Novak  
 Cohen  
 Ronald Cohen  
 Ruth Cohen  
 Penny Collins  
 Tricia Cooke & Ethan Coen  
 Elizabeth Cooper Davis &  
 Gordon J. Davis  
 David Costabile  
 Craig Cox  
 Jeff Cox  
 Peter & Barbara Cross  
 Stephen & Sandra Crudgington  
 Billy Crudup  
 Mary D'Elia  
 Suzanne Dallimore  
 Arthur Dantchik  
 Cathy Dantchik  
 Leslie Dantchik  
 Peter & Judith Dawkins  
 Robert de Rothschild  
 Anthony & Christie deNicola

William Dockery  
 Whitney Dow &  
 Thomasine Dolan Dow  
 Richard & Rebecca Dresser  
 Ned Eisenberg & Patricia Maguire  
 Wendy Ettinger & Derek McLane  
 Robert & Gail Evans  
 Peter Jay Fernandez &  
 Denise Burse  
 Martin Fetner & William Coury  
 Angelina Fiordellisi &  
 Matt Williams  
 Terry Fitzpatrick &  
 Stephen Perpeluk  
 Anita Flanagan & Jeff Potter  
 Nat Magee & Alison Fraser  
 Louis & Patrice Friedman  
 Thomas Gannon  
 Beverly Gasner  
 Jilian Cahan Gersten  
 Scott Aaron Gewirtz & Laura  
 Gewirtz  
 Paul & Liz Giamatti  
 Nancy Giles  
 Kilty Gilmour  
 Tony Goldwyn & Jane Musky  
 Stephen & Cathy Graham  
 Michael Greif & Jonathan Fried  
 Janet Grillo & David Russell  
 Emily Grishman &  
 Susan Sampliner  
 Lisa Gugenheim &  
 Larry Nathanson  
 Marianne Hagan  
 David & Ann Hausmann  
 Erica Heilman  
 Jane Hayden Helmsley  
 Nancy Hechinger  
 Peter Herdrich & Karen Trott  
 Amy Herzig  
 Kathy & Matthew Hobbs  
 William Holtzman &  
 S. Sylvia Shepard  
 Mark Horowitz  
 Sarah Horowitz & David Venarde  
 Seymour Jacobs & Felicia Jacobs  
 Linda LeRoy Janklow  
 Donna & Thomas Jaycox  
 Amanda Johns  
 Andrea Johnson  
 Douglas Jordan & Katie Jordan  
 Bonnie Kantor

Cindy Kaplan  
 Seth & Beth Klarman  
 Mary Kong  
 Henry Krieger  
 Stephen Lebovitz  
 Warren Leight  
 Robert Sean Leonard  
 Ilana Levine & Dominic Fumusa  
 Anna Li & Frank Sposato  
 Mark Linn-Baker &  
 Adrienne Lobel  
 Michael Loeb & Marjorie Loeb  
 Katherine Lumb  
 John Lyons  
 Grace Lyu-Volckhausen  
 Greg MacPherson &  
 Jane Perlmutter  
 Bonnie MacSaveny &  
 Tom Fetterman  
 Peter Manning & André Bishop  
 Jodie & Brad Markell  
 Mark Marvel  
 Paul McCrane & Dana Kellin  
 Fran McDormand & Joel Coen  
 Rick Meese & Dan Lori  
 Audrey & Danny Meyer  
 Noël & Joe Mihalow  
 Michael Moffat  
 Emily & John Morgan  
 Suzen Murakoshi &  
 Mark Temme  
 Patricia M. Murphy, Esq. &  
 Adam Spilka  
 Don & Sara Nelson  
 Fred Nelson  
 Randy & Rona Nelson  
 Cynthia Nixon  
 Lori O'Connor  
 Kevin O'Rourke & Edith Thurber  
 Amy Herzig  
 Jacki Ochs & Jan Kroeze  
 Paul & Maria Onderdonk  
 Elizabeth Peters  
 Judy Goldman & Michael Pillinger  
 Christopher Randolph  
 Peter & Helen Randolph  
 Willie Reale & Jenny Gersten  
 Jay Reiss  
 David & Anita Rogerson  
 Daryl Roth  
 Ida Roth  
 Martha Roth & Bill Irwin

Shirley Rumierk  
 Steve Sabba  
 Arnold & Agnes Sametz  
 Laura Sametz & Anton Fig  
 Don Scardino & Dana Williams  
 Zeborah Schachtel  
 Karin & Tom Schall  
 John Schlegel  
 Erica Schmidt & Peter Dinklage  
 Daniel Schnur  
 Robert Schnur  
 Maury Schott  
 Whitney Scott &  
 Peter Jacobson  
 Stefan Selig  
 Mitchell Semel & Colleen Carroll  
 Robert Shaffron & John Davis  
 Stephanie Sharis  
 Peter Shinoda  
 Abby Jo Sigal & Matt Turner  
 Jean Stein  
 R.L. & Jane Stine  
 Susanna Styron & Darrell Larson  
 Daniel Swee  
 Richard Sweren  
 Daniel Swistel  
 Brenda Thomas  
 Tracy Thorne & Edmund Lewis  
 Liz Tuccillo  
 Laura Valeroso & David Seidman  
 Josephine Eke & Jason Valk  
 Wendy vanden Heuvel &  
 Brad Coley  
 Mary Pat Walsh  
 Borah & Mildred Walton  
 David & Wendy Ward  
 Sharon Washington  
 Lynn & Sam Waterston  
 Brenda Wehle & John C. Lynch  
 Sally & Lenny Weiss  
 Jane Bolster & Steve Wertimer  
 Joe White & Iris Brown  
 Carol Whitesides  
 Daniel Wiener &  
 Ellen Freudenheim  
 Jenny Wiener & Jon Steingart  
 Michael & Zena Wiener  
 Joanne Woodward &  
 Paul Newman  
 Carole Yass & Randy Ginsburg  
 Jeffrey & Janine Yass  
 John Young

THE 52ND STREET PROJECT PRESENTS  
 THE 2006 HAROLD AND MIMI STEINBERG  
 CHARITABLE TRUST ONE-ON-ONES

# ANOTHER COUNTRY HEARD FROM

THE  
 INTERNATIONAL PLAYS

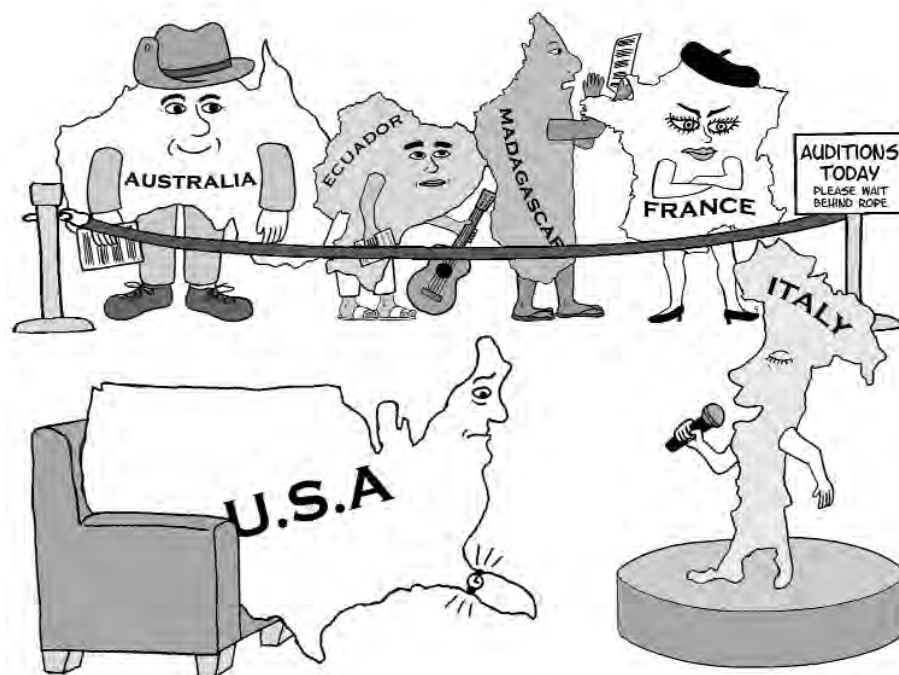

JULY 21-23, 2006

THE ENSEMBLE STUDIO THEATRE  
 549 WEST 52ND ST.  
 NEW YORK CITY

**ANOTHER COUNTRY HEARD FROM:  
THE INTERNATIONAL PLAYS  
THE BLOCK ISLAND ONE-ON-ONES  
JULY 21-23 - THE ENSEMBLE STUDIO THEATRE**

**The 52nd Street Project Staff:**

Gus Rogerson, Artistic Director  
 Carol Ochs, Executive Director  
 John Sheehy, Director of Development and Marketing  
 George "X-Acto" Babiak, Production Manager  
 Reg Flowers, Associate Artistic Director  
 Liz Bell, Director of Education  
 Megan Cramer, Program Director  
 Diana Rojas, Executive Assistant  
 Jackie Frankel, Development Assistant  
 Chris Ceraso, Teen Dean  
 Iris A. Brown, Graphic Designer  
 Solangee Acosta, Johanna Vidal, Receptionists  
 Lauren Blumenfeld, Sean Kenealy, Drew Vanderburg, Interns

**Production Staff**

**Composer:** Aaron Platt, John Sheehy, Ronee Siegel,  
 Andrew Sherman  
**Set Designer:** Ashley Springer, Drew Vanderburg  
 Kevin Joseph Roach  
**Lighting Designer:** **Furniture Crew:**  
 Greg MacPherson Sean Kenealy, Alex Tomas, and Drew  
**Costume Designers:** Vanderburg  
 Lauren Blumenfeld and Nicole  
 Chloe Chapin and Katherine Brown Fargardo  
**Goddess of Sound:** **Prop Crew:**  
 Vanessa Valdes Tim Cain, Craig Cox, Doug Nervik,  
**Stage Manager:** Nikki Phillips, Tom Schall  
 Patricia McGregor  
**House Manager:**  
**Slide Designs:** Liz Bell, Jackie Frankel, Karin Schall  
 Tracy Rosiene, George Babiak, **Chefs:**  
 and the Project Slide Archive Katie Homans, Pat Ritter and Martha  
**Prop Design Team:** Velie-Gass  
 George Babiak, Lauren Blumenfeld, **Teen Counselor:**  
 Katherine Brown, Reg Flowers, Jackie Nicole Fargardo  
 Frankel, Sean Kenealy, Nikki Phillips,

The One-on-One Program is made possible with public funds from the New York State Council on the Arts, a state agency; and the New York City Department of Cultural Affairs. The 52nd Street Project is supported by funds from the National Endowment for the Arts. The Project is a member of ART/NY and a participant in the New Generations Program, funded by Doris Duke Charitable Foundation/The Andrew W. Mellon Foundation and administered by Theatre Communications Group, the national organization for the American Theater.



**COOL STUFF ON SALE IN THE LOBBY!**

The Fabulous Flyer Bar .....\$2, \$1.50 & \$1  
*and featuring Shel Silverstein's "Fivey and Twoey" logo:*  
 Project T-shirts .....\$12.00  
 Project Tank Tops .....\$12.00  
 Project Caps .....\$15.00  
 Project Mugs .....\$5.00  
 Project Pencil 3-pack .....\$1.00  
 Project Notebook .....\$5.00

Thank you for coming to **ANOTHER COUNTRY HEARD FROM!** If you are not on our mailing list (or if your address has changed), please fill out this form and give it to us on your way out or mail it to the address below. We would also like to know if you are interested in becoming a volunteer. We need help in **all areas**, so be sure to fill out the entire form.

**PLEASE ADD ME TO YOUR MAILING LIST:**

7/06

NAME: \_\_\_\_\_  
 ADDRESS: \_\_\_\_\_  
 \_\_\_\_\_ ZIP \_\_\_\_\_  
 HOME PHONE: \_\_\_\_\_  
 DAYTIME PHONE: \_\_\_\_\_  
 E-MAIL ADDRESS: \_\_\_\_\_  
 MY OCCUPATION: \_\_\_\_\_  
 MY HOBBIES: \_\_\_\_\_

**YES, I WOULD LIKE TO BE OF HELP. I CAN:**

- |   |   |  |
|---|---|--|
| <input type="checkbox"/> Help load in and out for shows | <input type="checkbox"/> Draw and/or paint  | <input type="checkbox"/> Help kids with homework |
| <input type="checkbox"/> Hang lights                    | <input type="checkbox"/> Help with mailings | <input type="checkbox"/> Teach kids a skill      |
| <input type="checkbox"/> Work on a backstage crew       | <input type="checkbox"/> Do office work     | <input type="checkbox"/> Be a chef at an event   |
| <input type="checkbox"/> Do graphic design              | <input type="checkbox"/> Design sound       | <input type="checkbox"/> Design and sew costumes |
| <input type="checkbox"/> Other (please specify) _____   |   |  |

**MY SCHEDULE IS:**

- Very flexible. I'm often available during weekdays.  
 Somewhat flexible. I can help on the occasional morning or afternoon during the week.  
 Not very flexible at all, but I've got some free time on evenings and weekends.

If you would like to mail this (and you're always welcome to enclose a tax-deductible contribution), you can send it to: **The 52nd Street Project**, 500 West 52nd St., New York, NY 10019. Or fax it to (212) 333-5598.

## Don't Miss Our Upcoming Shows!

### YET ANOTHER COUNTRY HEARD FROM THE INTERNATIONAL PLAYS

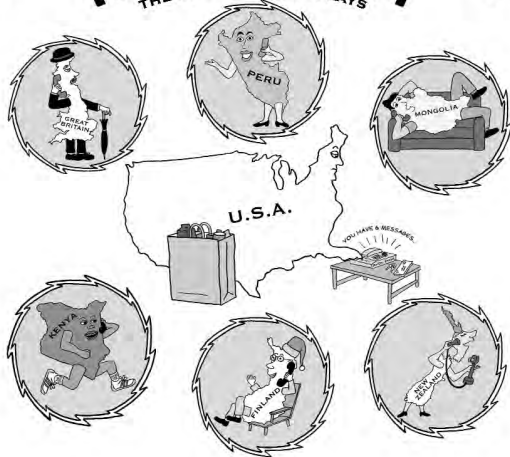

**10  
NEW KIDS!  
10  
NEW ADULTS!  
10  
NEW PLAYS!  
SAME  
OLD THEME!  
AUG. 18-20  
RIGHT HERE AT THE  
ENSEMBLE STUDIO  
THEATRE**

## **PLAYBACK**

**October, 2006**

First a kid writes a short play. Then, an adult writes an “answer” play. Then, the two of them perform both plays. Multiply this equation by seven and you’ve got a terrific evening of theater.



**December, 2006**

In September, 10 kids brand-new to the Project will begin a Playmaking class taught by Project Playmaking Director Reg Flowers. Come and see their final plays performed by adult professional actors.

The 52nd Street Project is a non-profit organization that brings children from the Hell’s Kitchen neighborhood together with professional theater artists to create original theater. **ANOTHER COUNTRY HEARD FROM** is a production of our One-on-One program, which is designed to give children the opportunity to go away for one-week stays in the country and enjoy the undivided attention of a professional theater artist who serves as friend, mentor, and collaborator. The Project is delighted to return to the Ensemble Studio Theatre, where we have been performing since our inception in 1981. We gratefully acknowledge the fact that if E.S.T. wasn’t here, we’d be nowhere.

### The 52nd Street Project Board of Directors

Ben Barenholtz	Frances McDormand
Lisa Benavides	Carol Ochs
Rachel Chanoff	Willie Reale, <i>founder</i>
Cathy Dantchik	Gus Rogerson
Noël Dawkins	Shirley Rumierk, <i>alumni member</i>
Wendy Ettinger, <i>chair emeritus</i>	José Soto, Jr., <i>alumni member</i>
Louis P. Friedman	Pamala Tyson
Stephen Graham, <i>chair</i>	Wendy vanden Heuvel
Larry Jones	John A. Vassilaros
James McDaniel	Jenny Wiener

### Special Thanks

Our Host Families – Roberta & Alan Alpert; Sue Black; Josie Merck & Jim Stevenson; Caroline & K.C. Perry; Jennifer & Elliot Taubman; Ron & Judy Tierney; Joya Verde & Virginia Dare; and our headquarters host Dr. Christina Biaggi.

Sincere thanks to our chefs Pat Ritter & Martha Velie-Gass; Lynn Reale, Kate & everyone at Block Island Realty; Rita & Steve Draper; Glenn & Annie Hall; McQuade’s Market; Interstate Navigation; Sophia Ochs MacVittie; Jenny Ritter; Amanda Gass; Amy Jaffe; Ed Berube; Amelia Gallant at the Block Island Grocery; Cindy & Stan Geer at the Depot; The Homans Family; Maclac Enterprise, and Peter McNerney.

### In-Kind Contributions

The Murphy Law Office; Benefit Cosmetics; Iris A. Brown; Comptoir Sud Pacifique, Ron Kastner and Capital Printing; Kenneth Cole Productions; Noggin; Entertainment Weekly; Newman’s Own; Pharma Print/Omni Graphics; Sesame Workshop; Wendy Stuhlberg; John A. Vassilaros; Watkins, Inc.; Mayor’s Office of Film & Television; Boylan’s Bottling Co.; Lorraine Tobias & Imaginary Studios; Warner Chappell Music Group, Simon Spotlight Entertainment, an imprint of Simon and Schuster; Hudson Scenic, Noggin/The N; Prime Films, Mario Badescu; Diageo Chateau & Estate Wines Co.; Showman Fabricators; Frédéric Fekkai & Co., LLC.

## ANOTHER COUNTRY HEARD FROM - ACT I

All original music composed by Andrew Sherman (except where noted)  
“Another Country Heard From Theme Song” lyrics by John Sheehy

### PAIN IN MY ART

Written & Directed by Reg Flowers for Lily Houghton, age 11.  
Costumes by Katherine Brown.

Ivory Hightower .....Lily Houghton  
Frank Eversow .....Reg Flowers  
Curator .....Nicole Fargardo

“Art Haters’ Lament” and “Pain in My Art” lyrics by Reg Flowers

### THE LUCK O’ THE IRISH

Written & Directed by Angel Desai for Emmett Goodman-Boyd, age 10.  
Costumes by Chloe Chapin.

Finnegan Beginagain .....Emmett Goodman-Boyd  
Murdoch MacMurdegan .....Angel Desai  
Miss O’Brien .....Nicole Fargardo

“A Second Chance” music and lyrics by Angel Desai

### PENGUIN DREAMS

Written by Cynthia Kaplan; Directed by Catherine Mueller for Joyce Cheung,  
age 10. Costumes by Katherine Brown.

Janice .....Joyce Cheung  
Michelle A. Michelle .....Catherine Mueller

“When All is Done and Said” lyrics by Cynthia Kaplan

### ONE

Written & Directed by Bruce MacVittie for Terrence Mack, age 12.  
Costumes by Chloe Chapin.

One .....Bruce MacVittie  
Two .....Terrence Mack  
Tourists .....Sean Kenealy, Lauren Blumenfeld  
Gus Rogerson.....Himself

“The Singular Lament” and “The Two Together Duet” lyrics by Bruce MacVittie

### MELINDA Y MAYA

Written by Michael Bernard; Directed by Riji Suh for Erica Arce, age 12.  
Costumes by Katherine Brown.

Melinda. ....Erica Arce  
Maya .....Riji Suh  
Main Guard .....Diana Rojas  
Other Guards .....Nicole Fargardo, Alex Tomas, Sean Kenealy  
Fidel Castro .....Drew Vanderburg

“Ants in My Pants: The Revolution Song” lyrics by Michael Bernard

## ANOTHER COUNTRY HEARD FROM - ACT II

### BLOOD SPORT

Written & Directed by John Sheehy for Lily Capstick, age 9.  
Costumes by Katherine Brown.

Maleficent .....Lily Capstick  
Barnabus .....John Sheehy

“Get Yourself a Minion” lyrics by John Sheehy

### TRAPPED IN THE LOUVRE MUSEUM

Written by Deirdre O’Connor; Directed by Nikki Phillips for Chloe Moore, age  
11. Costumes by Katherine Brown.

Francoise Foie Gras .....Nikki Phillips  
Aphrodite .....Chloe Moore  
Truffaut Escargot .....George Babiak

“Louvre’s Lament” lyrics by Deirdre O’Connor

### THE STABLE BOY WHO WOULD BE KING

Written & Directed by Lee Rosen for Lordan Ulloa, age 11.  
Costumes by Chloe Chapin.

Gavin .....Lee Rosen  
Angus .....Lordan Ulloa  
Town Crier .....Drew Vanderburg  
Townspiece .....Sean Kenealy, Lauren Blumenfeld

“I’m the King” lyrics by Lee Rosen

### SAY CHEESE!

Written & Directed by Megan Cramer for Luz Maldonado, age 13.  
Costumes by Chloe Chapin.

Henrietta Gorgonzoliano .....Megan Cramer  
Pepper Jack .....Luz Maldonado  
Customers .....Nicole Fargardo, Lauren Blumenfeld, Drew Vanderburg

“Say Cheese Polka” and “Be a Brie” lyrics by Megan Cramer

### THE MOROVIAN BUNNY

Written by Willie Reale; Directed by Tim Cain for Malik Velasquez, age 10.  
Costumes by Chloe Chapin.

Tim .....Tim Cain  
King Petrovia .....Malik Velasquez  
Guard .....Alex Tomas  
Princess Fantoopia .....Diana Rojas  
Morovian Pips .....Tim Cain, Reg Flowers, Lee Rosen\*

“Trouble in Morovia” and “Surrender” lyrics by Willie Reale

\*Better known as “Menergy ‘06”

I  
N  
T  
E  
R  
M  
I  
S  
I  
O  
N



The 52nd Street Project gratefully acknowledges the support of the following foundations and corporations: AOL Time Warner, Inc.; BKSK Architects LLP; Bloomberg; The Brenner Family Foundation; Brunswick Group; Carnegie Corporation of New York; CBS; Consolidated Edison; The Dermot Company; The Dramatists Guild Fund; Dramatists Play Service; Joele Frank & Wilkinson Brimmer Katcher; The Horace W. Goldsmith Foundation; The William & Mary Greve Foundation; The Hennessy Foundation; Holland Lodge Foundation, Inc.; Hurlbut Family Charitable Lead Trust; Kekst & Company; Latham & Watkins, LLP; Lloyds TSB Bank plc; James A. Macdonald Foundation; Ann M. Martin Foundation; Mellon Bank, N.A.; Noggin; Jonathan Rose Companies; Shapiro & Lobel; Showtime Networks Inc; St. Vincent De Paul Foundation; Shearman & Sterling, LLP; Stranahan Foundation; The Sordna Foundation; Theatre Communications Group, Inc.; The Tow Foundation; John A. Vassilaros & Son, Inc; The Law Offices of Claudia Wagner; Weil, Gotshal & Manges LLP; Yorke Construction Corp. In addition, the following individuals made gifts of over \$200 to The 52nd Street Project this past year (list is current as of 7/19/06):

Raymond & Elizabeth Abbott  
 Robert Abrams & Cynthia Vance  
 Jace Alexander & Maddie Corman  
 Cecilia Arana-Grant & Kevin Grant  
 Jonathan Aviv  
 Dylan & Becky Baker  
 Ben Barenholtz  
 Jessica Bauman  
 Christopher Beale &  
 Francesca Beale  
 Laurie Becker & Rick Sweren  
 Michael Bell & Carol Bell  
 Lisa Benavides & Tim Nelson  
 Stephanie Berger & Paul King  
 Craig Berggren  
 Elizabeth & Alexander Bernstein  
 Richard Blackstone &  
 Yldeez Yuksek  
 Tessa Blake  
 Buzz Bovshow  
 Becky Browder & Ted Neustadt  
 Michelle Buffington  
 Nataalka Bukalo  
 Kate Burton & Michael Ritchie  
 John Carr & Patricia Carr  
 Constance Casey  
 Rachel Chanoff  
 Sharon Chantile  
 Darah Cloud & Dave Owens  
 Julian Cohan & Greta Cohan  
 David Cohen & Sandra Novak  
 Cohen  
 Ronald Cohen  
 Ruth Cohen  
 Penny Collins  
 Tricia Cooke & Ethan Coen  
 Elizabeth Cooper Davis &  
 Gordon J. Davis  
 David Costabile  
 Craig Cox  
 Jeff Cox  
 Peter & Barbara Cross  
 Stephen & Sandra Crudgington  
 Billy Crudup  
 Mary D'Elia  
 Suzanne Dallimore  
 Arthur Dantchik  
 Cathy Dantchik  
 Leslie Dantchik  
 Peter & Judith Dawkins  
 Robert de Rothschild  
 Anthony & Christie deNicola

William Dockery  
 Whitney Dow &  
 Thomasine Dolan Dow  
 Richard & Rebecca Dresser  
 Ned Eisenberg & Patricia Maguire  
 Wendy Ettinger & Derek McLane  
 Robert & Gail Evans  
 Peter Jay Fernandez &  
 Denise Burse  
 Martin Fetner & William Coury  
 Angelina Fiordellisi &  
 Matt Williams  
 Terry Fitzpatrick &  
 Stephen Perpeluk  
 Anita Flanagan & Jeff Potter  
 Nat Magee & Alison Fraser  
 Louis & Patrice Friedman  
 Thomas Gannon  
 Beverly Gasner  
 Jilian Cahan Gersten  
 Scott Aaron Gewirtz & Laura  
 Gewirtz  
 Paul & Liz Giamatti  
 Nancy Giles  
 Kilty Gilmour  
 Tony Goldwyn & Jane Musky  
 Stephen & Cathy Graham  
 Michael Greif & Jonathan Fried  
 Janet Grillo & David Russell  
 Emily Grishman &  
 Susan Sampliner  
 Lisa Gugenheim &  
 Larry Nathanson  
 Marianne Hagan  
 David & Ann Hausmann  
 Erica Heilman  
 Jane Hayden Helmsley  
 Nancy Hechinger  
 Peter Herdrich & Karen Trott  
 Amy Herzig  
 Kathy & Matthew Hobbs  
 William Holtzman &  
 S. Sylvia Shepard  
 Mark Horowitz  
 Sarah Horowitz & David Venarde  
 Seymour Jacobs & Felicia Jacobs  
 Linda LeRoy Janklow  
 Donna & Thomas Jaycox  
 Amanda Johns  
 Andrea Johnson  
 Douglas Jordan & Katie Jordan  
 Bonnie Kantor

Cindy Kaplan  
 Seth & Beth Klarman  
 Mary Kong  
 Henry Krieger  
 Stephen Lebovitz  
 Warren Leight  
 Robert Sean Leonard  
 Ilana Levine & Dominic Fumusa  
 Anna Li & Frank Sposato  
 Mark Linn-Baker &  
 Adrienne Lobel  
 Michael Loeb & Marjorie Loeb  
 Katherine Lumb  
 John Lyons  
 Grace Lyu-Volckhausen  
 Greg MacPherson &  
 Jane Perlmutter  
 Bonnie MacSaveny &  
 Tom Fetterman  
 Peter Manning & André Bishop  
 Jodie & Brad Markell  
 Mark Marvel  
 Paul McCrane & Dana Kellin  
 Fran McDormand & Joel Coen  
 Rick Meese & Dan Lori  
 Audrey & Danny Meyer  
 Noël & Joe Mihalow  
 Michael Greif & Jonathan Fried  
 Emily & John Morgan  
 Suzen Murakoshi &  
 Mark Temme  
 Patricia M. Murphy, Esq. &  
 Adam Spilka  
 Don & Sara Nelson  
 Fred Nelson  
 Randy & Rona Nelson  
 Cynthia Nixon  
 Lori O'Connor  
 Kevin O'Rourke & Edith Thurber  
 Jacki Ochs & Jan Kroeze  
 Paul & Maria Onderdonk  
 Elizabeth Peters  
 Judy Goldman & Michael Pillinger  
 Christopher Randolph  
 Peter & Helen Randolph  
 Willie Reale & Jenny Gersten  
 Jay Reiss  
 David & Anita Rogerson  
 Daryl Roth  
 Ida Roth  
 Martha Roth & Bill Irwin

Shirley Rumierk  
 Steve Sabba  
 Arnold & Agnes Sametz  
 Laura Sametz & Anton Fig  
 Don Scardino & Dana Williams  
 Zeborah Schachtel  
 Karin & Tom Schall  
 John Schlegel  
 Erica Schmidt & Peter Dinklage  
 Daniel Schnur  
 Robert Schnur  
 Maury Schott  
 Whitney Scott &  
 Peter Jacobson  
 Stefan Selig  
 Mitchell Semel & Colleen Carroll  
 Robert Shaffron & John Davis  
 Stephanie Sharis  
 Peter Shinoda  
 Abby Jo Sigal & Matt Turner  
 Jean Stein  
 R.L. & Jane Stine  
 Susanna Styron & Darrell Larson  
 Daniel Swee  
 Richard Sweren  
 Daniel Swistel  
 Brenda Thomas  
 Tracy Thome & Edmund Lewis  
 Liz Tuccillo  
 Laura Valeroso & David Seidman  
 Josephine Eke & Jason Valk  
 Wendy vanden Heuvel &  
 Brad Coley  
 Mary Pat Walsh  
 Borah & Mildred Walton  
 David & Wendy Ward  
 Sharon Washington  
 Lynn & Sam Waterston  
 Brenda Wehle & John C. Lynch  
 Carol Ochs & Bruce MacVittie  
 Jane Bolster & Steve Wertimer  
 Joe White & Iris Brown  
 Carol Whitesides  
 Daniel Wiener &  
 Ellen Freudenheim  
 Jenny Wiener & Jon Steingart  
 Michael & Zena Wiener  
 Joanne Woodward &  
 Paul Newman  
 Carole Yass & Randy Ginsburg  
 Jeffrey & Janine Yass  
 John Young

THE 52ND STREET PROJECT PRESENTS  
 THE 2006 WIENER FAMILY FOUNDATION  
 ONE-ON-ONES

LET  
**ANOTHER COUNTRY**  
 HEARD FROM  
 THE INTERNATIONAL PLAYS

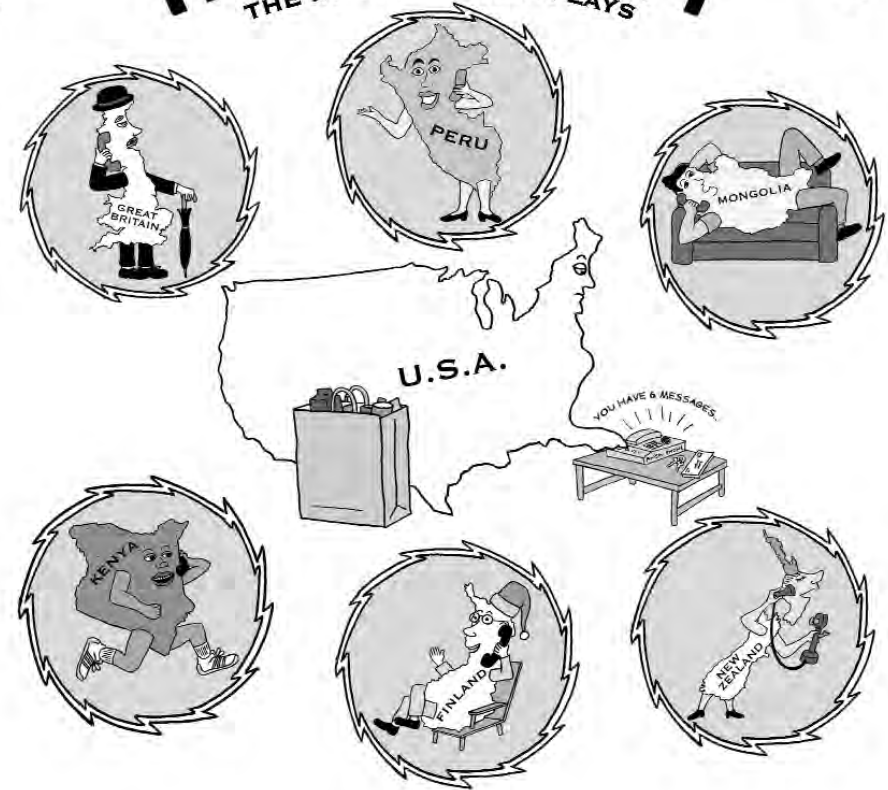

AUGUST 18-20, 2006  
**THE ENSEMBLE STUDIO THEATRE**  
 549 WEST 52ND STREET  
 NEW YORK CITY

**YET ANOTHER COUNTRY HEARD FROM:  
THE INTERNATIONAL PLAYS  
THE WAREHAM, MASS. ONE-ON-ONES  
AUGUST 18-20 - THE ENSEMBLE STUDIO THEATRE**

**The 52nd Street Project Staff:**

Gus Rogerson, Artistic Director  
 Carol Ochs, Executive Director  
 John Sheehy, Director of Development and Marketing  
 George "Smartacus" Babiak, Production Manager  
 Reg Flowers, Associate Artistic Director  
 Liz Bell, Director of Education  
 Megan Cramer, Program Director  
 Diana Rojas, Executive Assistant  
 Jackie Frankel, Development Assistant  
 Chris Ceraso, Teen Dean  
 Iris A. Brown, Graphic Designer  
 Solangee Acosta, Johanna Vidal, Receptionists  
 Lauren Blumenfeld, Sean Kenealy, Drew Vanderburg, Interns

**Production Staff**

**Composer:**

Patrick Barnes

**Set Designer:**

Kevin Joseph Roach

**Lighting Designer:**

Greg MacPherson

**Costume Designers:**

Crystal Thompson and Ciera Wells

**Sound Designer:**

Drew Vanderburg

**Stage Manager:**

Karen Munkel

**Slide Designs:**

Tracy Rosiene, George Babiak,  
and the Project Slide Archive

**Prop Design Team:**

George Babiak, Lauren Blumenfeld, Reg  
Flowers, Sean Kenealy, Ben Patton, Nikki  
Phillips, Aaron Platt, Erin Quinn Purcell

**Furniture Crew:**

Sean Kenealy, Alex Tomas, and  
Anthony Mejia

**Prop Crew:**

Lauren Blumenfeld and  
Merlaine Mendez

**Load-in and Light-hang Crew:**

Tim Cain, Craig Cox,  
Doug Nervik, Nikki Phillips,  
Tom Schall

**House Manager:**

Liz Bell, Jackie Frankel,  
Karin Schall, Mary Pat Walsh

**Chefs:**

John Sheehy, Liz Bell,  
Carol Ochs, Christopher Randolph

**Teen Counselor:**

Anthony Mejia

**COOL STUFF ON SALE IN THE LOBBY!**

The Fabulous Flyer Bar .....\$2, \$1.50 & \$1  
*and featuring Shel Silverstein's "Fivey and Twoey" logo:*  
 Project T-shirts .....\$12.00  
 Project Tank Tops .....\$12.00  
 Project Caps .....\$15.00  
 Project Mugs .....\$5.00  
 Project Pencil 3-pack .....\$1.00  
 Project Notebook .....\$5.00

Thank you for coming to **YET ANOTHER COUNTRY HEARD FROM!** If you are not on our mailing list (or if your address has changed), please fill out this form and give it to us on your way out or mail it to the address below. We would also like to know if you are interested in becoming a volunteer. We need help in **all areas**, so be sure to fill out the entire form.

**PLEASE ADD ME TO YOUR MAILING LIST:**

8/06

NAME: \_\_\_\_\_

ADDRESS: \_\_\_\_\_

ZIP \_\_\_\_\_

HOME PHONE: \_\_\_\_\_

DAYTIME PHONE: \_\_\_\_\_

E-MAIL ADDRESS: \_\_\_\_\_

MY OCCUPATION: \_\_\_\_\_

MY HOBBIES: \_\_\_\_\_

**YES, I WOULD LIKE TO BE OF HELP. I CAN:**

- |   |   |  |
|---|---|--|
| <input type="checkbox"/> Help load in and out for shows | <input type="checkbox"/> Draw and/or paint  | <input type="checkbox"/> Help kids with homework |
| <input type="checkbox"/> Hang lights                    | <input type="checkbox"/> Help with mailings | <input type="checkbox"/> Teach kids a skill      |
| <input type="checkbox"/> Work on a backstage crew       | <input type="checkbox"/> Do office work     | <input type="checkbox"/> Be a chef at an event   |
| <input type="checkbox"/> Do graphic design              | <input type="checkbox"/> Design sound       | <input type="checkbox"/> Design and sew costumes |
| <input type="checkbox"/> Other (please specify) _____   |   |  |

**MY SCHEDULE IS:**

- Very flexible. I'm often available during weekdays.  
 Somewhat flexible. I can help on the occasional morning or afternoon during the week.  
 Not very flexible at all, but I've got some free time on evenings and weekends.

If you would like to mail this (and you're always welcome to enclose a tax-deductible contribution), you can send it to: **The 52nd Street Project**, 500 West 52nd St., New York, NY 10019. Or fax it to (212) 333-5598.



The One-on-One Program is made possible with public funds from The New York State Council on the Arts, a state agency. This program is supported, in part, by public funds from the New York City Department of Cultural Affairs. The 52nd Street Project is supported by funds from the National Endowment for the Arts. The Project is a member of ART/NY.



**Don't Miss Our Upcoming Shows!**

# NO WAY TO BEHAVE!

THE SEVEN DEADLY SIN PLAYS  
THE 2006 PLAYBACK SHOW

*October 20-22, in a theater to be announced*

First a kid writes a short play. Then, an adult writes an "answer" play. Then, the two of them perform both plays. Multiply this equation by seven and you've got a terrific evening of theater.

To spice things up this year, we're assigning each kid/adult team a specific sin... not to commit, of course, but to inspire their show.

# THE POWER OF 10

**PLAYS THAT COUNT**

*December 8-10, in a theater to be announced*

In September, 10 kids brand-new to the Project will begin a Playmaking class taught by Project Playmaking Director Reg Flowers. Come and see their final plays performed by adult professional actors.

The 52nd Street Project is a non-profit organization that brings children from the Hell's Kitchen neighborhood together with professional theater artists to create original theater. **YET ANOTHER COUNTRY HEARD FROM** is a production of our One-on-One program, which is designed to give children the opportunity to go away for one-week stays in the country and enjoy the undivided attention of a professional theater artist who serves as friend, mentor, and collaborator. The Project is delighted to return to the Ensemble Studio Theatre, where we have been performing since our inception in 1981. We gratefully acknowledge the fact that if E.S.T. wasn't here, we'd be nowhere.

## The 52nd Street Project Board of Directors

Ben Barenholtz	Frances McDormand
Lisa Benavides	Carol Ochs
Rachel Chanoff	Willie Reale, <i>founder</i>
Cathy Dantchik	Gus Rogerson
Noël Dawkins	Shirley Rumierk, <i>alumni member</i>
Wendy Ettinger, <i>chair emeritus</i>	José Soto, Jr., <i>alumni member</i>
Louis P. Friedman	Pamala Tyson
Stephen Graham, <i>chair</i>	Wendy vanden Heuvel
Larry Jones	John A. Vassilaros
James McDaniel	Jenny Wiener

## Special Thanks

Our Host Families – Emily & John Morgan; Suzanne & John Potts; Bob & Marina Whitman; Sidney Worthen & David Pearce; Joe McNay & the entire McNay family; and, of course, Peter, Helen & Christopher Randolph for letting us use their beautiful home in Wareham as our headquarters for a whole week.

Sincere Thanks to Kent McIngvale; Robin Morse, Lucy & Francis Rogerson; Vanessa Valdes; Bob Krystolfolski; and Beamer Weems and The Wareham Gatemen baseball team.

## In-Kind Contributions

The Murphy Law Office; Benefit Cosmetics; Iris A. Brown; Comptoir Sud Pacifique, Ron Kastner and Capital Printing; Kenneth Cole Productions; Noggin; Entertainment Weekly; Newman's Own; Pharma Print/Omni Graphics; Sesame Workshop; Wendy Stuhlberg; John A. Vassilaros; Watkins, Inc.; Mayor's Office of Film & Television; Boylan's Bottling Co.; Lorraine Tobias & Imaginary Studios; Warner Chappell Music Group, Simon Spotlight Entertainment, an imprint of Simon and Schuster; Hudson Scenic, Noggin/The N; Prime Films, Mario Badescu; Diageo Chateau & Estate Wines Co.; Showman Fabricators; Frédéric Fekkai & Co., LLC.

## YET ANOTHER COUNTRY HEARD FROM - ACT I

All original music composed by Patrick Barnes  
“Another Country Heard From Theme Song” lyrics by John Sheehy

### AN EU-TIFUL FRIENDSHIP

Written by Adam Felber & Directed by Reg Flowers for Kyle Fargardo, age 10  
Antonio von Baguette, E.U. Detective . . . . . Kyle Fargardo  
Ziggy . . . . . Reg Flowers  
Claudette . . . . . Lauren Blumenfeld  
Pierre de la Schneider . . . . . John Sheehy  
Thug . . . . . Sean Kenealy

“E.U. And Me” lyrics by Adam Felber

### BEAUTIFUL GAME

Written & Directed by Erin Quinn Purcell for Breanna Straker, age 10  
Marielle . . . . . Breanna Straker  
Felicia . . . . . Erin Quinn Purcell

“Talk To The Hand,” “Red Anthem,” & “Blue Anthem” lyrics by Erin Quinn Purcell

### THE LAST RESORT

Written by Liz Tuccillo & Directed by Saidah Arrika Ekulona for Jason Gil, age 11  
Al Sullivan . . . . . Jason Gil  
Snow White . . . . . Saidah Arrika Ekulona  
Fern’s Mom . . . . . Lauren Blumenfeld

“We Love Disneyland” lyrics by Liz Tuccillo

### THE EX-PATS

Written & Directed by Keira Naughton for Stephanie Marion, age 11  
Lady . . . . . Stephanie Marion  
Chick . . . . . Keira Naughton  
Lady’s Brain on the Microphone . . . . . Lauren Blumenfeld

“We’re Ex-Pats” & “The Feasting Song” lyrics by Keira Naughton

### ROME, SWEET ROME

Written & Directed by George Babiak for Mordecai Santiago, age 13  
Magnus Optimus . . . . . Mordecai Santiago  
Smartacus Minimus . . . . . George Babiak  
Announcer . . . . . Patrick Barnes  
Tigers . . . . . Anthony Mejia, Sean Kenealy

“The Gladiator’s Song” lyrics by George Babiak

## YET ANOTHER COUNTRY HEARD FROM - ACT II

### NO CURE LIKE TRAVEL

Written & Directed by Christopher Randolph for Jamie Yip, age 10  
Jewel Rose . . . . . Jamie Yip  
Stanley . . . . . Christopher Randolph  
Wild Man of Borneo/Todd . . . . . John Sheehy  
Wild Man . . . . . Sean Kenealy  
Wild Woman . . . . . Lauren Blumenfeld

“Adventure” lyrics by Christopher Randolph

### LUNCHROOM OF THE LIVING DEAD

Written & Directed by Michael Puzzo for Chris Tineo, age 10  
Bats . . . . . Chris Tineo  
Frank . . . . . Michael Puzzo  
Mr. Klopinski . . . . . Patrick Barnes

“Creature Double Feature” lyrics by Michael Puzzo

### INNERWEAR

Written by Leslie Kramer & Directed by Caroline Clay for Marlowe Mendez, age 10  
Radianz Delamer . . . . . Marlowe Mendez  
Clarisse Fauxpas . . . . . Caroline Clay  
Dogs . . . . . The Crew

“A Natural Beauty” lyrics by Leslie Kramer

### THE LAUGHING MISTRESS

Written by Reg Flowers & Directed by Megan Cramer for Samantha Toro, age 12  
Niu Li . . . . . Samantha Toro  
Mama Chou/Laughing Mistress/Aunt Yu Wen . . . . . Megan Cramer  
Wei Kun Wu/Mu Jin/Assassin . . . . . Sean Kenealy  
Lady Fire Bird/Assassin . . . . . Lauren Blumenfeld  
Crouching Lion/Ju Lin/Assassin . . . . . Anthony Mejia

“Niu Li, Once Again You Bring This Family Shame” & “A Home In Me” lyrics by Reg Flowers & Megan Cramer

# I N T E R M I S S I O N



The 52nd Street Project gratefully acknowledges the support of the following foundations and corporations: AOL Time Warner, Inc.; BKSK Architects LLP; Bloomberg; The Brenner Family Foundation; Brunswick Group; Carnegie Corporation of New York; CBS; Consolidated Edison; The Dermot Company; The Dramatists Guild Fund; Dramatists Play Service; Joele Frank & Wilkinson Brimmer Katcher; The Horace W. Goldsmith Foundation; The William & Mary Greve Foundation; The Hennessy Foundation; Holland Lodge Foundation, Inc.; Hurlbut Family Charitable Lead Trust; Kekst & Company; Latham & Watkins, LLP; Lloyds TSB Bank plc; James A. Macdonald Foundation; Ann M. Martin Foundation; Mellon Bank, N.A.; Noggins; Jonathan Rose Companies; Shapiro & Lobel; Showtime Networks Inc; St. Vincent De Paul Foundation; Shearman & Sterling, LLP; Stranahan Foundation; The Surdna Foundation; Theatre Communications Group, Inc.; The Tow Foundation; John A. Vassilaros & Son, Inc; The Law Offices of Claudia Wagner; Weil, Gotshal & Manges LLP; Yorke Construction Corp. In addition, the following individuals made gifts of over \$200 to The 52nd Street Project this past year (list is current as of 7/19/06):

Raymond & Elizabeth Abbott  
 Robert Abrams & Cynthia Vance  
 Jace Alexander & Maddie Corman  
 Cecilia Arana-Grant & Kevin Grant  
 Jonathan Aviv  
 Dylan & Becky Baker  
 Ben Barenholtz  
 Jessica Bauman  
 Christopher Beale &  
 Francesca Beale  
 Laurie Becker & Rick Sweren  
 Michael Bell & Carol Bell  
 Lisa Benavides & Tim Nelson  
 Stephanie Berger & Paul King  
 Craig Berggren  
 Elizabeth & Alexander Bernstein  
 Richard Blackstone &  
 Yldeez Yuksek  
 Tessa Blake  
 Buzz Bovshow  
 Becky Browder & Ted Neustadt  
 Michelle Buffington  
 Nataalka Bukalo  
 Kate Burton & Michael Ritchie  
 John Carr & Patricia Carr  
 Constance Casey  
 Rachel Chanoff  
 Sharon Chantlie  
 Darah Cloud & Dave Owens  
 Julian Cohan & Greta Cohan  
 David Cohen & Sandra Novak  
 Cohen  
 Ronald Cohen  
 Ruth Cohen  
 Penny Collins  
 Tricia Cooke & Ethan Coen  
 Elizabeth Cooper Davis &  
 Gordon J. Davis  
 David Costabile  
 Craig Cox  
 Jeff Cox  
 Peter & Barbara Cross  
 Stephen & Sandra Crudgington  
 Billy Crudup  
 Mary D'Elia  
 Suzanne Dallimore  
 Arthur Dantchik  
 Cathy Dantchik  
 Leslie Dantchik  
 Peter & Judith Dawkins  
 Robert de Rothschild  
 Anthony & Christie deNicola

William Dockery  
 Whitney Dow &  
 Thomasine Dolan Dow  
 Richard & Rebecca Dresser  
 Ned Eisenberg & Patricia Maguire  
 Wendy Ettinger & Derek McLane  
 Robert & Gail Evans  
 Peter Jay Fernandez &  
 Denise Burse  
 Martin Fetner & William Coury  
 Angelina Fiordellisi &  
 Matt Williams  
 Terry Fitzpatrick &  
 Stephen Perpeluk  
 Anita Flanagan & Jeff Potter  
 Nat Magee & Alison Fraser  
 Louis & Patrice Friedman  
 Thomas Gannon  
 Beverly Gasner  
 Jilian Cahan Gersten  
 Scott Aaron Gewirtz & Laura  
 Gewirtz  
 Paul & Liz Giamatti  
 Nancy Giles  
 Kilty Gilmour  
 Tony Goldwyn & Jane Musky  
 Stephen & Cathy Graham  
 Michael Greif & Jonathan Fried  
 Janet Grillo & David Russell  
 Emily Grishman &  
 Susan Sampliner  
 Lisa Gugenheim &  
 Larry Nathanson  
 Marianne Hagan  
 David & Ann Hausmann  
 Erica Heilman  
 Jane Hayden Helmsley  
 Nancy Hechinger  
 Peter Herdrich & Karen Trott  
 Amy Herzig  
 Kathy & Matthew Hobbs  
 William Holtzman &  
 S. Sylvia Shepard  
 Mark Horowitz  
 Sarah Horowitz & David Venarde  
 Seymour Jacobs & Felicia Jacobs  
 Linda LeRoy Janklow  
 Donna & Thomas Jaycox  
 Amanda Johns  
 Andrea Johnson  
 Douglas Jordan & Katie Jordan  
 Bonnie Kantor

Cindy Kaplan  
 Seth & Beth Klarman  
 Mary Kong  
 Henry Krieger  
 Stephen Lebovitz  
 Warren Leight  
 Robert Sean Leonard  
 Ilana Levine & Dominic Fumusa  
 Anna Li & Frank Sposato  
 Mark Linn-Baker &  
 Adrienne Lobel  
 Michael Loeb & Marjorie Loeb  
 Katherine Lumb  
 John Lyons  
 Grace Lyu-Volckhausen  
 Greg MacPherson &  
 Jane Perlmutter  
 Bonnie MacSaveny &  
 Tom Fetterman  
 Peter Manning & André Bishop  
 Jodie & Brad Markell  
 Mark Marvel  
 Paul McCrane & Dana Kellin  
 Fran McDormand & Joel Coen  
 Rick Meese & Dan Lori  
 Audrey & Danny Meyer  
 Noël & Joe Mihalow  
 James & Amanda Moffat  
 Emily & John Morgan  
 Suzen Murakoshi &  
 Mark Temme  
 Patricia M. Murphy, Esq. &  
 Adam Spilka  
 Don & Sara Nelson  
 Fred Nelson  
 Randy & Rona Nelson  
 Cynthia Nixon  
 Lori O'Connor  
 Kevin O'Rourke & Edith Thurber  
 Carol Ochs & Bruce MacVittie  
 Jacki Ochs & Jan Kroeze  
 Paul & Maria Onderdonk  
 Elizabeth Peters  
 Judy Goldman & Michael Pillinger  
 Christopher Randolph  
 Peter & Helen Randolph  
 Willie Reale & Jenny Gersten  
 Jay Reiss  
 David & Anita Rogerson  
 Daryl Roth  
 Ida Roth  
 Martha Roth & Bill Irwin

Shirley Rumiark  
 Steve Sabba  
 Arnold & Agnes Sametz  
 Laura Sametz & Anton Fig  
 Don Scardino & Dana Williams  
 Zeborah Schachtel  
 Karin & Tom Schall  
 John Schlegel  
 Erica Schmidt & Peter Dinklage  
 Daniel Schnur  
 Robert Schnur  
 Maury Schott  
 Whitney Scott &  
 Peter Jacobson  
 Stefan Selig  
 Mitchell Semel & Colleen Carroll  
 Robert Shaffron & John Davis  
 Stephanie Sharis  
 Peter Shinoda  
 Abby Jo Sigal & Matt Turner  
 Jean Stein  
 R.L. & Jane Stine  
 Susanna Styron & Darrell Larson  
 Daniel Swee  
 Richard Sweren  
 Daniel Swistel  
 Brenda Thomas  
 Tracy Thome & Edmund Lewis  
 Liz Tuccillo  
 Laura Valeroso & David Seidman  
 Josephine Eke & Jason Valk  
 Wendy vanden Heuvel &  
 Brad Coley  
 Mary Pat Walsh  
 Borah & Mildred Walton  
 David & Wendy Ward  
 Sharon Washington  
 Lynn & Sam Waterston  
 Brenda Wehle & John C. Lynch  
 Sally & Lenny Weiss  
 Jane Bolster & Steve Wertimer  
 Joe White & Iris Brown  
 Carol Whitesides  
 Daniel Wiener &  
 Ellen Freudenheim  
 Jenny Wiener & Jon Steingart  
 Michael & Zena Wiener  
 Joanne Woodward &  
 Paul Newman  
 Carole Yass & Randy Ginsburg  
 Jeffrey & Janine Yass  
 John Young

THE 52ND STREET PROJECT PRESENTS  
 THE FALL 2006 PLAYBACK SHOWS



THE TADA! THEATRE  
 15 WEST 28TH ST., 2ND FLOOR  
 FRI., OCT. 20 AT 7:30 P.M.  
 SAT., OCT. 21 AT 3:00 P.M. AND 7:30 P.M.  
 SUN., OCT. 22 AT 3:00 P.M.

**The 52nd Street Project Staff:**

Gus Rogerson, Artistic Director  
Carol Ochs, Executive Director  
John Sheehy, Director of Development and Marketing  
George "Smartacus" Babiak, Production Manager  
Reg Flowers, Associate Artistic Director  
Liz Bell, Director of Education  
Megan Cramer, Program Director  
Diana Rojas, Executive Assistant  
Jackie Frankel, Development Assistant  
Chris Ceraso, Teen Dean  
Iris A. Brown, Graphic Designer  
Solangee Acosta, Johanna Vidal, Receptionists  
Archie Ekong, Intern



**Production Staff:**

**Composers:** Greg Pliska and Andrew Sherman  
**Set Designer:** Kevin Joseph Roach  
**Lighting Designers:** Greg MacPherson and Alex Gordon  
**Lighting Assistant:** Alex Gordon  
**Costume Designer:** Ali Turns  
**Sound Designer:** Betsy Rhodes  
**Stage Manager:** Lanita Ward  
**"Devil" Illustration:** Ryan Sanchez  
**Prop Design Team:** George Babiak, Paul Boyd, Reg Flowers, Cara Marcous, John Sheehy  
**Furniture Crew:** Archie Ekong, Michael Feliciano, and Zebulun Santiago  
**Prop Crew:** Maura Fisher and Kayelani Silva  
**Load-in and Light Hang Crew:** Archie Ekong, Nedra Gallegos, "Manta" Ray Harold, Rick Meese, Doug Nervik, Tom Schall, Becky Sealander  
**House Managers:** Liz Bell and Mary Pat Walsh  
**Chef:** The Incredibell Liz Bell

The Playback Program is made possible with public funds from The New York State Council on the Arts, a state agency; and the New York City Department of Cultural Affairs. The 52nd Street Project is supported by funds from the National Endowment for the Arts and the Department of Youth and Community Development. The Project is member of ART/NY and a participant in the New Generations Program, funded by Doris Duke Charitable Foundation/The Andrew W. Mellon Foundation and administered by Theatre Communications Group, the national organization for the American Theater.



**COOL STUFF ON SALE!**

Flyer Bars .....\$2.00, \$1.50 & \$1.00  
*Shel Silverstein's "Fivey and Twoey" logo gear:*  
Project Hoodies .....\$30.00  
Project Short Sleeve T-Shirts (New colors!) ..\$12.00  
Project Caps .....\$15.00  
Project Mugs (New RED type) .....\$5.00  
Project Spiral Notebooks .....\$5.00  
Project Pencil 3-pack .....\$1.00

Thank you for coming to **NO WAY TO BEHAVE**. If you are not on our mailing list (or if your address has changed), please fill out this form and give it to us on your way out or mail it to the address below. We would also like to know if you are interested in becoming a volunteer. We need help in **all areas**, so be sure to fill out the entire form.

**PLEASE ADD ME TO YOUR MAILING LIST:**

OCT 2006

NAME: \_\_\_\_\_

ADDRESS: \_\_\_\_\_

ZIP \_\_\_\_\_

HOME PHONE: \_\_\_\_\_

DAYTIME PHONE: \_\_\_\_\_

E-MAIL ADDRESS: \_\_\_\_\_

MY OCCUPATION: \_\_\_\_\_

MY HOBBIES: \_\_\_\_\_

**YES, I WOULD LIKE TO BE OF HELP. I CAN:**

- Help load in and out for shows
- Draw and/or paint
- Help kids with homework
- Hang lights
- Help with mailings
- Teach kids a skill
- Work on a backstage crew
- Do office work
- Be a chef at an event
- Do graphic design
- Design sound
- Design and sew costumes
- Other (please specify) \_\_\_\_\_

**MY SCHEDULE IS:**

- Very flexible. I'm often available during weekdays.
- Somewhat flexible. I can help on the occasional morning or afternoon during the week.
- Not very flexible at all, but I've got some free time on evenings and weekends.

If you would like to mail this (and you're always welcome to enclose a tax-deductible contribution), you can send it to: **The 52nd Street Project**, 500 West 52nd St., New York, NY 10019. Or fax it to (212) 333-5598.

**Don't Miss Our Upcoming Shows!**

# THE POWER OF 10

**PLAYS THAT COUNT**

**December 8-10 at the Public Theater**

In September, 10 kids brand-new to the Project will begin a Playmaking class taught by Project Playmaking Director Reg Flowers. Come and see their final plays performed by adult professional actors.

# THE TWO-ON -TWO'S

**JANUARY, 2007  
AT THE  
WOMEN'S INTERART THEATRE**

Dare we let kids act with each other, with no adult in sight? You bet we do! Come see these six new plays in the space across the hall from the Clubhouse.



The 52nd Street Project is a non-profit organization that brings children from the Hell's Kitchen neighborhood together with professional theater artists to create original theater. **NO WAY TO BEHAVE** is a production of our **Playback** program, in which kid actor/playwrights wrote plays that were then "answered" by adult actor/playwright partners who write their own plays. We took the whole menagerie up to the idyllic hamlet of Franklin, NY over the Columbus Day weekend to rehearse the shows. In the final production, which you see here tonight, the partners perform both plays back-to-back. All of the kids involved are veterans of the Playmaking classes which were adapted for the Project by Daniel Judah Sklar from his book *Playmaking: Children Writing and Performing Their Own Plays*.

## The 52nd Street Project Board of Directors

Ben Barenholtz

Lisa Benavides

Rachel Chanoff

Cathy Dantchik

Noël Dawkins

Wendy Ettinger, *chair emeritus*

Louis P. Friedman

Stephen Graham, *chair*

Larry Jones

James McDaniel

Frances McDormand

Carol Ochs

Willie Reale, *founder*

Gus Rogerson

Shirley Rumierk, *alumni member*

José Soto, Jr., *alumni member*

Pamala Tyson

Wendy vanden Heuvel

John A. Vassilaros

Jenny Wiener

## Special Thanks

We're extremely grateful to **John Vassilaros**, **Alex Gersten-Vassilaros**, and their boys **Tonio** and **Stefano** for allowing us to use their home as our headquarters on our rehearsal trip to the Hamptons. Thanks also to **Louis** and **Patrice Friedman**.

## In-Kind Contributions

The Murphy Law Office; Benefit Cosmetics; Iris A. Brown; Comptoir Sud Pacifique, Ron Kastner and Capital Printing; Kenneth Cole Productions; Noggin; Entertainment Weekly; Newman's Own; Pharma Print/Omni Graphics; Sesame Workshop; Wendy Stuhlberg; John A. Vassilaros; Watkins, Inc.; Mayor's Office of Film & Television; Boylan's Bottling Co.; Lorraine Tobias & Imaginary Studios; Warner Chappell Music Group, Simon Spotlight Entertainment, an imprint of Simon and Schuster; Hudson Scenic, Noggin/The N; Prime Films, Mario Badescu; Diageo Chateau & Estate Wines Co.; Showman Fabricators; Frédéric Fekkai & Co., LLC.

## NO WAY TO BEHAVE: THE 7 DEADLY SINS PLAYS - ACT I

### HONESTY AND VANITY

By Jenisse Bouret, age 12. Dramaturge/Director: Pascale Armand

#### AND WHAT?

Written and directed by Pascale Armand

Joelle .....Jenisse Bouret  
Bellinda .....Pascale Armand  
Adam .....George Babiak  
Dancers .....The crew

“Just Everything” lyrics by Jenisse Bouret, music by Greg Pliska

### THE LUCKY BROTHERS

By Pablo Maldonado, age 13. Dramaturge/Director: Jed Clarke

#### CONTROL

Written and directed by Jed Clarke

Golden .....Pablo Maldonado  
David .....Jed Clarke  
Boss .....George Babiak

“What I Think About Power” lyrics by Jed Clarke, music by Andrew Sherman

### THE OTHER SIDE

By Jennifer Ramirez, age 12. Dramaturge/Director: Perry Daniel

#### TAGALONG

Written and directed by Perry Daniel

Pumpkin/SD6 .....Jennifer Ramirez  
Fruitcake/KKP .....Perry Daniel  
Wicked Joe .....Reg Flowers

“Writing On the Wall” lyrics by Perry Daniel, music by Andrew Sherman

### THE BIBLE IN THE FUTURE

By Harlo Ulloa, age 13. Dramaturge/Director: Craig Cox.

#### SCI-FIE

Written and directed by Craig Cox

Jesus .....Harlo Ulloa  
Moses/ Jesus’ Dad .....Craig Cox

“Science!” lyrics by Craig Cox, music by Andrew Sherman



## NO WAY TO BEHAVE: THE 7 DEADLY SINS PLAYS - ACT II

### FROM RAGS TO RICHES

By Stephanie Vamvoukakis, age 12. Dramaturge/Director: Sarah Petersiel

### GLORIA AND HER MOM FIND THEMSELVES IN THE SAME ROOM (IN ICELAND)

Written and directed by Sarah Petersiel

Gloria .....Stephanie Vamvoukakis  
April/Gloria’s Mom .....Sarah Petersiel  
Visitor .....Reg Flowers

“Cold Like Iceland” lyrics by Sarah Petersiel, music by Andrew Sherman

### LUCKY NUMBER ONE

By Azalea Rosario, age 12. Dramaturge/Director: Alex Barreto

### STRANGER IN AMERICA

Written and directed by Alex Barreto

Elle/Maria .....Azalea Rosario  
Ben/Daniel .....Alex Barreto  
Female Assistant .....Kayelani Silva

“About Me” lyrics by Azalea Rosario, music by Greg Pliska

### SLOTH

By Bryant Acosta, age 13. Dramaturge/Director: Drew Cortese

### HARDBOILED

Written and directed by Drew Cortese

Reginald Fairfield/Jack Powers .....Bryant Acosta  
Chauncey Peoples/Marcelo “The Mooch” Muccino .....Drew Cortese  
Leslie .....John Sheehy  
Jo/ Mamma .....Megan Cramer  
Goons .....Archie Ekong, Zebulun Santiago

“Mamma Mia” lyrics by Drew Cortese, music by Andrew Sherman

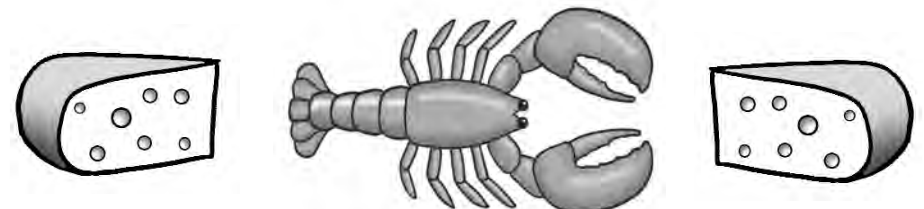



The 52nd Street Project gratefully acknowledges the support of the following foundations and corporations: AOL Time Warner, Inc.; BKS Architects LLP; Bloomberg; The Brenner Family Foundation; Brunswick Group; Carnegie Corporation of New York; CBS; Consolidated Edison; The Dermot Company; The Dramatists Guild Fund; Dramatists Play Service; Joelle Frank & Wilkinson Brimmer Katcher; The Horace W. Goldsmith Foundation; The William & Mary Greve Foundation; The Hennessy Foundation; Holland Lodge Foundation, Inc.; Hurlbut Family Charitable Lead Trust; Kekst & Company; Latham & Watkins, LLP; Lloyds TSB Bank plc; James A. Macdonald Foundation; Ann M. Martin Foundation; Mellon Bank, N.A.; Nogg; Jonathan Rose Companies; Shapiro & Lobel; Showtime Networks Inc; St. Vincent De Paul Foundation; Shearman & Sterling, LLP; Stranahan Foundation; The Surdna Foundation; Theatre Communications Group, Inc.; The Tow Foundation; John A. Vassilaros & Son, Inc.; The Law Offices of Claudia Wagner; Weil, Gotshal & Manges LLP; Yorke Construction Corp. In addition, the following individuals made gifts of over \$200 to The 52nd Street Project this past year (list is current as of 7/19/06):

Raymond & Elizabeth Abbott	Whitney Dow &	Mary Kong	Arnold & Agnes Sametz
Robert Abrams & Cynthia Vance	Thomasine Dolan Dow	Henry Krieger	Laura Sametz & Anton Fig
Jace Alexander & Maddie Corman	Richard & Rebecca Dresser	Stephen Lebovitz	Don Scardino & Dana Williams
Cecilia Arana-Grant & Kevin Grant	Ned Eisenberg & Patricia Maguire	Warren Leight	Zeborah Schachtel
Jonathan Aviv	Wendy Ettinger & Derek McLane	Robert Sean Leonard	Karin & Tom Schall
Dylan & Becky Baker	Robert & Gail Evans	Ilana Levine & Dominic Fumusa	John Schlegel
Ben Barenholtz	Peter Jay Fernandez &	Anna Li & Frank Sposato	Erica Schmidt & Peter Dinklage
Jessica Bauman	Denise Burse	Mark Linn-Baker &	Daniel Schnur
Christopher Beale &	Martin Fetner & William Coury	Adrienne Lobel	Robert Schnur
Francesca Beale	Angelina Fiordellisi &	Michael Loeb & Marjorie Loeb	Maury Schott
Laurie Becker & Rick Sweren	Matt Williams	Katherine Lumb	Whitney Scott &
Michael Bell & Carol Bell	Terry Fitzpatrick &	John Lyons	Peter Jacobson
Lisa Benavides & Tim Nelson	Stephen Perepeluk	Grace Lyu-Volkhausen	Stefan Selig
Stephanie Berger & Paul King	Anita Flanagan & Jeff Potter	Greg MacPherson &	Mitchell Semel & Colleen Carroll
Craig Berggren	Nat Magee & Alison Fraser	Jane Perlmutter	Robert Shaffron & John Davis
Elizabeth & Alexander Bernstein	Louis & Patrice Friedman	Bonnie MacSaveny &	Stephanie Sharis
Richard Blackstone &	Thomas Gannon	Tom Fetterman	Peter Shinoda
Yldeez Yuksek	Beverly Gasner	Peter Manning & André Bishop	Abby Jo Sigal & Matt Turner
Tessa Blake	Jillian Cahan Gersten	Jodie & Brad Markell	Jean Stein
Buzz Bovshow	Scott Aaron Gewirtz & Laura Gewirtz	Mark Marvel	R.L. & Jane Stine
Becky Browder & Ted Neustadt	Paul & Liz Giamatti	Paul McCrane & Dana Kellin	Susanna Styron & Darrell Larson
Michelle Buffington	Nancy Giles	Fran McDormand & Joel Coen	Daniel Swee
Natalia Bukalo	Kilty Gilmour	Rick Meese & Dan Lori	Richard Sweren
Kate Burton & Michael Ritchie	Tony Goldwyn & Jane Musky	Audrey & Danny Meyer	Daniel Swistel
John Carr & Patricia Carr	Stephen & Cathy Graham	Noël & Joe Mihalow	Brenda Thomas
Constance Casey	Michael Greif & Jonathan Fried	James & Amanda Moffat	Tracy Thorne & Edmund Lewis
Rachel Chanoff	Janet Grillo & David Russell	Emily & John Morgan	Liz Tucillo
Sharon Chantile	Emily Grishman &	Suzen Murakoshi &	Laura Valeroso & David Seidman
Darah Cloud & Dave Owens	Susan Sampliner	Mark Temme	Josephine Eke & Jason Valk
Julian Cohan & Greta Cohan	Lisa Gugenheim &	Patricia M. Murphy, Esq. &	Wendy vanden Heuvel &
David Cohen & Sandra Novak Cohen	Larry Nathanson	Adam Spilka	Brad Coley
Ronald Cohen	Marianne Hagan	Don & Sara Nelson	Mary Pat Walsh
Ruth Cohen	David & Ann Hausmann	Fred Nelson	Borah & Mildred Walton
Penny Collins	Erica Heilman	Randy & Rona Nelson	David & Wendy Ward
Tricia Cooke & Ethan Coen	Jane Hayden Helmsley	Cynthia Nixon	Sharon Washington
Elizabeth Cooper Davis &	Nancy Hechinger	Lori O'Connor	Lynn & Sam Waterston
Gordon J. Davis	Peter Herdrich & Karen Trott	Kevin O'Rourke & Edith Thurber	Brenda Wehle & John C. Lynch
David Costabile	Amy Herzig	Carol Ochs & Bruce MacVittie	Sally & Lenny Weiss
Craig Cox	Kathy & Matthew Hobbs	Jacki Ochs & Jan Kroeze	Jane Bolster & Steve Wertimer
Jeff Cox	William Holtzman &	Paul & Maria Onderdonk	Joe White & Iris Brown
Peter & Barbara Cross	S. Sylvia Shepard	Elizabeth Peters	Carol Whitesides
Stephen & Sandra Crudginton	Mark Horowitz	Judy Goldman & Michael Pflinger	Daniel Wiener &
Billy Crudup	Sarah Horowitz & David Venarde	Christopher Randolph	Ellen Freudenheim
Mary D'Elia	Seymour Jacobs & Felicia Jacobs	Peter & Helen Randolph	Jenny Wiener & Jon Steingart
Suzanne Dallimore	Linda LeRoy Janklow	Willie Reale & Jenny Gersten	Michael & Zena Wiener
Arthur Dantchik	Donna & Thomas Jaycox	Jay Reiss	Joanne Woodward &
Cathy Dantchik	Amanda Johns	David & Anita Rogerson	Paul Newman
Leslie Dantchik	Andrea Johnson	Daryl Roth	Carole Yass & Randy Ginsburg
Peter & Judith Dawkins	Douglas Jordan & Katie Jordan	Jeffrey & Janine Yass	John Young
Robert de Rothschild	Bonnie Kantor		
Anthony & Christie deNicola	Cindy Kaplan		
William Dockery	Seth & Beth Klarman		

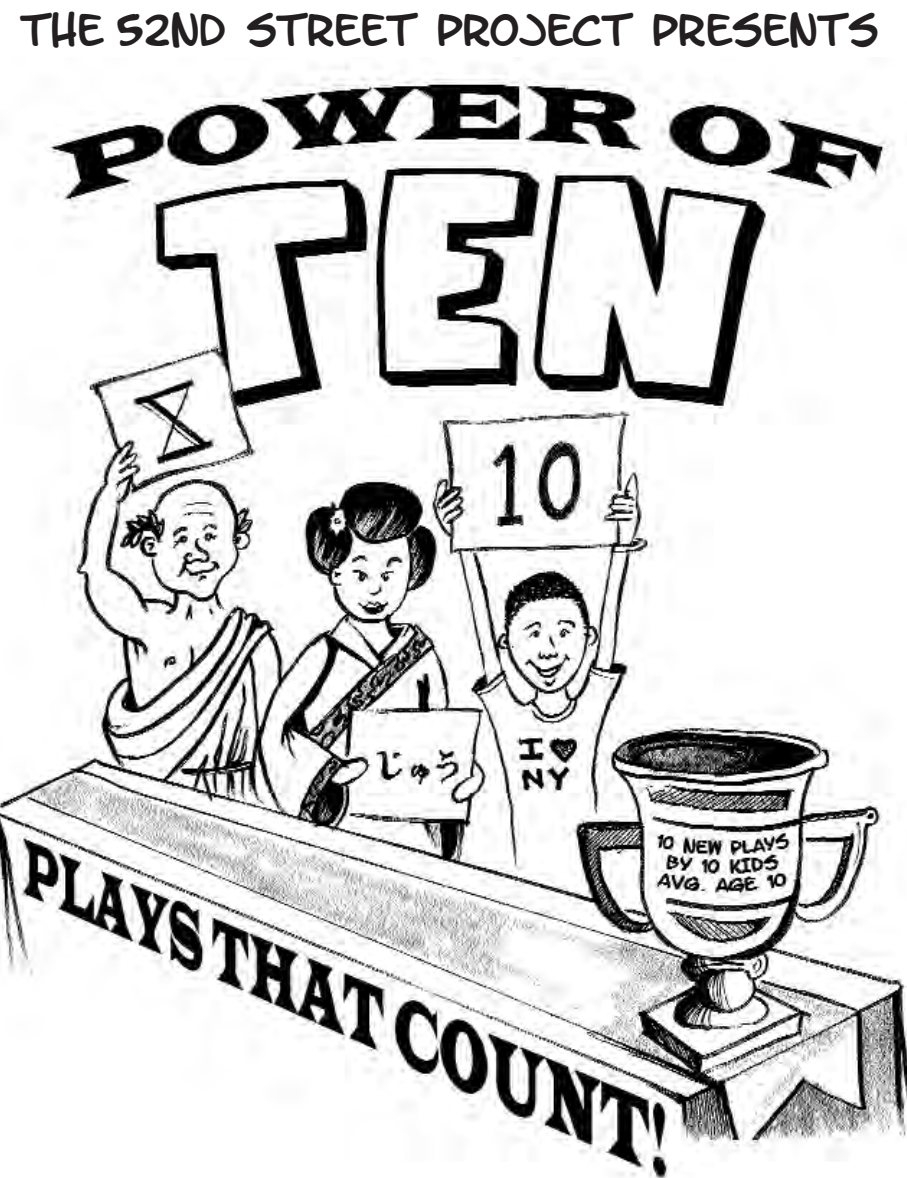

THE 2006 STONE RIDGE PLAYMAKING SERIES

AT THE PUBLIC THEATER  
425 LAFAYETTE ST.

FRI., DEC. 8 AT 7:30 P.M.,  
SAT., DEC. 9 AT 3:00 & 7:30 P.M.,  
SUN., DEC. 11 AT 3:00 P.M.

# POWER OF 10

The Stone Ridge Playmaking Plays - Fall 2006 - Dec. 8-10  
at The Public Theater, 425 Lafayette St.

## The 52nd Street Project Staff

Gus Rogerson, Artistic Director  
Carol Ochs, Executive Director  
John Sheehy, Director of Development and Marketing  
George "Smartacus" Babiak, Production Manager  
Reg Flowers, Associate Artistic Director  
Liz Bell, Director of Education  
Megan Cramer, Program Director  
Diana Rojas, Executive Assistant  
Josh Moody, Development Assistant  
Chris Ceraso, Teen Dean  
Iris A. Brown, Graphic Designer  
Solangee Acosta, Johanna Vidal, Jazzy Hernandez, Kayelani Silva, Receptionists  
Archie Ekong, Intern

## Production Staff

**Composer:** Patrick Barnes  
**Set Designer:** Kevin Joseph Roach  
**Lighting Designer:**  
Greg MacPherson  
**Costume Designer:**  
Viviane Galloway  
**Sound Designer:** Maury Schott  
**Stage Manager:** Carol Sullivan  
**Slide Designers:**  
George Babiak, Tracy Rosiene,  
Mike Sell, and many others  
**"Power of 10" Illustration:**  
Jimmy Hilburn  
**Prop Design Team:**  
George Babiak, Megan Cramer, Reg  
Flowers, Patrick Jones, Nikki Phillips,  
John Sheehy

**Furniture Crew:**  
Chris Varmus, Kimani Lewis-Ashley  
**Prop Crew:**  
Chloe Demrovsky, Octavia Rodriguez  
**Backstage Boss:**  
Nikki Phillips  
**Load-in and Light Hang Crew:**  
Doug Nervik, Nikki Phillips, Christopher  
Randolph, Tom Schall  
**Playmaking Class Volunteers:**  
Tim Cain, Genevieve DeGaillande, Ben  
Masur, Virginia Vitzthum  
**House Managers:**  
Mary Pat Walsh and Liz Bell  
**Host/Chefs:**  
Joe White, Iris A. Brown, and their son  
Walker

The Playmaking Program is made possible with public funds from The New York State Council on the Arts, a state agency; and the New York City Department of Cultural Affairs. The 52nd Street Project is supported by funds from the National Endowment for the Arts and the Department of Youth and Community Development. The Project is member of ART/NY.



# COOL STUFF ON SALE!

Flyer Bars .....\$2.00, \$1.50 & \$1.00  
"Playmaking" by Daniel Judah Sklar .....\$15.00  
*Shel Silverstein's "Fivey and Twoey" logo gear:*  
Project "Hoodies" (now come in BLUE!) ..\$30.00  
Project Caps .....\$15.00  
Project Mugs (New RED type!) .....\$5.00  
Project Notebooks .....\$5.00  
Project Pencil 3-pack .....\$1.00

Thank you for coming to **POWER OF 10**. If you are not on our mailing list (or if your address has changed), please fill out this form and give it to us on your way out or mail it to the address below. We would also like to know if you are interested in becoming a volunteer. We need help in **all areas**, so be sure to fill out the entire form.

### PLEASE ADD ME TO YOUR MAILING LIST:

12/06

NAME: \_\_\_\_\_

ADDRESS: \_\_\_\_\_

ZIP \_\_\_\_\_

HOME PHONE: \_\_\_\_\_

DAYTIME PHONE: \_\_\_\_\_

E-MAIL ADDRESS: \_\_\_\_\_

MY OCCUPATION: \_\_\_\_\_

MY HOBBIES: \_\_\_\_\_

### YES, I WOULD LIKE TO BE OF HELP. I CAN:

- |   |   |  |
|---|---|--|
| <input type="checkbox"/> Help load in and out for shows | <input type="checkbox"/> Draw and/or paint  | <input type="checkbox"/> Help kids with homework |
| <input type="checkbox"/> Hang lights                    | <input type="checkbox"/> Help with mailings | <input type="checkbox"/> Teach kids a skill      |
| <input type="checkbox"/> Work on a backstage crew       | <input type="checkbox"/> Do office work     | <input type="checkbox"/> Be a chef at an event   |
| <input type="checkbox"/> Do graphic design              | <input type="checkbox"/> Design sound       | <input type="checkbox"/> Design and sew costumes |
| <input type="checkbox"/> Other (please specify) _____   |   |  |

### MY SCHEDULE IS:

- Very flexible. I'm often available during weekdays.  
 Somewhat flexible. I can help on the occasional morning or afternoon during the week.  
 Not very flexible at all, but I've got some free time on evenings and weekends.

If you would like to mail this (and you're always welcome to enclose a tax-deductible contribution), you can send it to: **The 52nd Street Project**, 500 West 52nd St., New York, NY 10019. Or fax it to (212) 333-5598.

## Don't Miss Our Upcoming Shows!



# DESPERATE MEASURES: PLAYS ON THE VERGE

The 2007 2-on-2's - January 26, 27, and 28

at The Women's Interart Annex,  
500 W. 52nd St.

*Just across the hall from the Clubhouse!*

6 new plays, each with two kids as performers and two adults as writers and directors. Come watch the kids go it alone on stage!

## 52 + 365 = ?

Friday, February 23 at the Project Clubhouse  
Sunday, March 4 at the Public

On November 13, 2002, Pulitzer-prize winner **Suzan-Lori Parks** got an idea to write a play a day for a year. This play cycle is called **365 Plays/365**

**Days**. In New York City, over the course of this year, over 60 selected theater companies—curated by **The Public** and the **365 National Festival**—will perform these brief, brilliant plays.

The 52nd Street Project's production of 365 will bring together Project veterans, ages 13-15, performing under our own roof at 52nd and 10th. Come get stuck in a room, climb a stairwell, or travel through a hallway with kids from the Kitchen and 7 days of Ms. Parks. On our turf, surprises lurk around every corner.



**PLAYS THAT TALK BACK**

The Spring Edition  
of the Project's  
Playmaking Program

*Theater to be  
announced.*

**March 30 and 31, and April 1**

If you're enjoying the show tonight, you'll want to take in another set of shows by our *next* batch of Project newcomers!

Call 642-5052 for reservations.

The 52nd Street Project is a non-profit organization that brings children from the Hell's Kitchen neighborhood together with professional theater artists to create original theater. **POWER OF 10** is a production of our Playmaking program. Young people participate in a nine-week playwriting course taught by Reg Flowers and adapted for the Project by Daniel Judah Sklar from his book *Playmaking: Children Writing and Performing Their Own Plays*. At the end of the course, each child is given two actors, a theme, and a dramaturg/director who guides him or her through the writing of a play during a weekend retreat in the country (Stone Ridge, New York, for this show). Tonight's performance is the end result.

### The 52nd Street Project Board of Directors

Ben Barenholtz

Lisa Benavides

Rachel Chanoff

Cathy Dantchik

Noël Dawkins

Wendy Ettinger, *chair emeritus*

Louis P. Friedman

Stephen Graham, *chair*

Larry Jones

James McDaniel

Frances McDormand

Carol Ochs

Willie Reale, *founder*

Gus Rogerson

Shirley Rumierk, *alumni member*

José Soto, Jr., *alumni member*

Pamala Tyson

Wendy vanden Heuvel

John A. Vassilaros

Jenny Wiener

### Special Thanks

We're extremely grateful to **Steve Gorn**, **Barbara Bash** and their son **Wiley**, who graciously allowed us to use their beautiful home in Stone Ridge, NY as our base of operations for the writer's retreat. We also owe a wheelbarrow of gratitude to **Joe White** and **Iris Brown** for cooking some mighty big (and good) meals and lining up all the other host families (who earn thanks as well). They were **Laura Shaine Cunningham**, **Mary Louise Wilson**, **Nicole** and **Paul Quinn**, **Deborah Freedman**, **Bill Woods**, and **Charles Miles** and **Naomi Freundlich**, **Denny Dillon**, and **David Curtis** and **Anne Morse**. Finally, a 55-gallon drum of thanks goes to **Oskar Eustis**, **Maria Goyanes**, **Christina Hale**, **Ruth Sternberg**, **Andrew Kircher**, and everyone else at the terrific **Public Theater**. We're very honored to be here!

### In-Kind Contributions

The Murphy Law Office; Benefit Cosmetics; Iris A. Brown; Comptoir Sud Pacifique, Ron Kastner and Capital Printing; Kenneth Cole Productions; Noggin; Entertainment Weekly; Newman's Own; Pharma Print/Omni Graphics; Sesame Workshop; Wendy Stuhlberg; John A. Vassilaros; Watkins, Inc.; Mayor's Office of Film & Television; Boylan's Bottling Co.; Lorraine Tobias & Imaginary Studios; Warner Chappell Music Group, Simon Spotlight Entertainment, an imprint of Simon and Schuster; Hudson Scenic; Noggin/The N; Prime Films, Mario Badescu; Diageo Chateau & Estate Wines Co.; Showman Fabricators; Frédéric Fekkai & Co., LLC and Paul, Weiss, Rifkind, Wharton & Garrison LLP

# POWER OF 10 - ACT 1

All original music composed by Patrick Barnes

## The Twins

by Ashley Smith, age 11. Dramaturg/Director: Michael Early

Jack .....Paco Tolson  
Jackie .....Lizzy Cooper Davis  
Maid .....Nikki Phillips  
Randy Gotson .....Reg Flowers

“Far Away” lyrics by Ashley Smith

## Best Friends for Life

by Wendell Joseph, age 9.

Dramaturg: Megan Cramer; Director: Maria Goyanes

John .....Andrew Kelsey  
Rose .....Autumn Dornfeld  
Bully .....Gus Rogerson

“Hate” and “Remember/Bullies” lyrics by Wendell Joseph

## Like Father, Like Son

by Ethan Maldonado, age 12. Dramaturg/Director: Henry Wishcamper

Sam .....Peter Dinklage  
George (Dad) .....Lucas Caleb Rooney

## The Weird Thing

by Aleyni Aguilar, age 10. Dramaturg/Director: David Dalton

Mom .....Jeanine Serralles  
Daughter .....Adriana Gaviria

“The Moment” and “The Yoga Song” lyrics by Aleyni Aguilar

## Steven and Tommy

by Hashem Hamed, age 9. Dramaturg/Director: John Sheehy

Steven .....Tim Cain  
Tommy .....Ed Vassallo  
Andrew .....Reg Flowers

“Believe Each Other” lyrics by Hashem Hamed



# PLAYS THAT COUNT! - ACT II

## The Purple Scary House

by Armando Cosme, Jr., age 11.

Dramaturg: Gus Rogerson; Director: Reg Flowers

Eirica .....Mercedes Herrero  
Sqwishy Gummy .....Joaquin Torres

## Camping At Florida

by Mari Ulloa, age 9. Dramaturg/Director: Cynthia Kaplan

Felicia .....Lizbeth Mackay  
Brenda .....Nancy Gilles  
Bear .....George Babiak

“To Be Brave” lyrics by Mari Ulloa

## How Mr. MicGrumpy Became Mr. MicNiceNice

by Samantha Caldon, age 10. Dramaturg/Director: Kate Marks

Mr. MicGrumpy .....Daniel Oreskes  
Betty .....Wendy vanden Heuvel  
Kids .....The Crew  
Snake .....Chloe Demrovsky  
Newscaster .....Nikki Phillips  
People .....Chris Varmus, Kimani Lewis-Ashley

## I Messed Up

by Kevin Kulego, age 10. Dramaturg/Director: Evan Cabnet

Volso .....Robert Sella  
Velora .....Johanna Day  
Ninjas .....The Crew

“Dangerous Ninja” and “I Don’t Believe” lyrics by Kevin Kulego

## Autumn’s Nest

by Doris Alcantara, age 9.

Dramaturg: Virginia Vitzthum; Director: Jessica Bauman

Stephen .....Ned Eisenberg  
Sophia .....Frances McDormand  
Baby Birds .....Nikki Phillips

“Looking for My Woman” and “The Time Has Come” lyrics by Doris Alcantara



We wish a very happy holiday season to all Projectiles, great and small!

# 365 DAYS PLAYS

BY SUZAN-LORI PARKS

## WHAT IS 365 DAYS/365 PLAYS?

On November 13, 2002 Suzan-Lori Parks got an idea to write a play a day for a year. She began that very day, finishing one year later. The resulting play cycle, called 365 Days/365 Plays, is a daily meditation on an artistic life. Some plays are very short, less than a page. Others last forever.

## WHAT IS THE 365 NATIONAL FESTIVAL?

Make Theater. Make History. The 365 National Festival invites every theater in the world to join a grassroots premiere of Suzan-Lori Parks' 365 Days/365 Plays. Over 600 theaters are producing the plays in Atlanta, Austin, Canada, Chicago, Colorado, Greater Texas, Los Angeles, Minnesota, New York, Northeast, San Francisco Bay Area, Seattle, Southeast, Washington DC Area, Western US and in universities (365U). And the festival is growing every day. To find out more visit [www.365days365plays.com](http://www.365days365plays.com). Produced by Bonnie Metzgar and Suzan-Lori Parks. National Coordinator, David Myers. National Press Rep, Carol Fineman. 365U Producer, Rebecca Rugg.

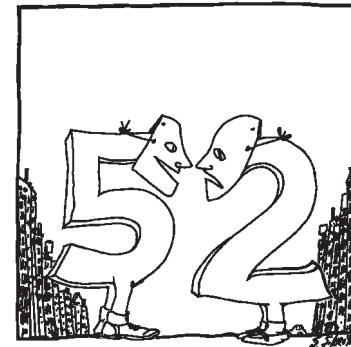

The 52nd Street Project

Presents

# 365 DAYS PLAYS

By Suzan-Lori Parks

Week 15:  
February 19-25

Presented at  
The 52nd Street Project Clubhouse  
500 West 52nd Street  
on Friday, February 23rd, 2007  
at 5:00 p.m. and 6:30 p.m.

**PRODUCED AND DIRECTED BY:**

Megan Cramer,  
with Reg Flowers, Gus Rogerson,  
and Nicole Watson

**COMPOSER AND MUSIC DIRECTOR:**

Patrick Barnes

**GUITARIST:**

Sean Kenealy

**PROPS BY:**

George Babiak and Josh Moody

**SPECIAL THANKS**

The Public Theater:

Oskar Eustis  
Mandy Hackett  
Maria Goyanes  
Christine Hale  
Andrew Kircher

**THE 52ND STREET PROJECT STAFF**

Gus Rogerson, Artistic Director  
Carol Ochs, Executive Director  
John Sheehy, Director of Development and Marketing  
George "Smartacus" Babiak, Production Manager  
Reg Flowers, Associate Artistic Director  
Liz Bell, Director of Education  
Megan Cramer, Program Director  
Diana Rojas, Executive Assistant  
Josh Moody, Development Assistant  
Chris Ceraso, Teen Dean  
Iris A. Brown, Graphic Designer  
Solangee Acosta, Johanna Vidal, Jazzy Hernandez, Kayelani Silva,  
Receptionists  
Jeremy Basescu, Intern

**WEEK 15: FEBRUARY 19-25**

**IT WAS THE ONLY WAY, REALLY**

(FEBRUARY 19)

**ASK THE EXPERTS**

(FEBRUARY 24)

**A MINIATURE PAINTING ON THE WALL OF  
THE KING PRESIDENT'S BEDROOM  
IN THE PLAY DAEDALUS 800**

(FEBRUARY 25)

**PROJECT MACBETH**

(FEBRUARY 23)

**CONEY ISLAND JOE'S**

(FEBRUARY 22)

**BABE CATCHER**

(FEBRUARY 20)

**A PLAY WRITTEN ON A  
PIECE OF PACKING PAPER**

(FEBRUARY 21)

**THE 3RD CONSTANT: INACTION IN ACTION**

PERSON, OR PERSONS (DOING 365 TASKS)

**THE COMPANY:**

Junior Chatman  
John Cuevas  
Kimani Lewis-Ashley  
Merlaine Mendez  
Aladino Olivares  
Kayelani Silva  
Johanna Vidal

The 52nd Street Project gratefully acknowledges the support of the following foundations and corporations: AOL Time Warner, Inc.; BKSK Architects LLP; Bloomberg; The Brenner Family Foundation; Brunswick Group; Carnegie Corporation of New York; CBS; Citigroup Foundation; Consolidated Edison; Dawkins Family Foundation; St. Vincent de Paul Foundation; The Dermot Company; The Dramatists Guild Fund; Dramatists Play Service; Joelle Frank & Wilkinson Brimmer Katcher; The Horace W. Goldsmith Foundation; The William & Mary Greve Foundation; HBO; The Heisman Foundation; The Hennessy Foundation; Holland Lodge Foundation, Inc.; The Saul Horowitz, Jr. Fund; Hurlbut Family Charitable Lead Trust; The JKW Foundation; Kekst & Company; Latham & Watkins, LLP; Loyds TSB Bank plc; James A. Macdonald Foundation; Ann M. Martin Foundation; Mellon Bank, N.A.; Noggin; Jonathan Rose Companies; Shapiro & Lobel; Showtime Networks Inc; St. Vincent De Paul Foundation; Shearman & Sterling, LLP; Stranahan Foundation; The Surdna Foundation; Theatre Communications Group, Inc.; The Tow Foundation; John A. Vassilaros & Son, Inc; The Vervane Foundation; The Law Offices of Claudia Wagner, Weil, Gotshal & Manges LLP; Wiener Family Foundation; Yorke Construction Corp. In addition, the following individuals made gifts of over \$200 to The 52nd Street Project this past year (list is current as of 1/25/07):

Raymond & Elizabeth Abbott	Wendy Ettinger & Derek McLane	Robert Sean Leonard	Erica Schmidt & Peter Dinklage
Robert Abrams & Cynthia Vance	Andrew & Sandi Farkas	& Gaby Salick	Daniel Schnur
Jace Alexander & Maddie Corman	Peter Jay Fernandez	Liza Lerner	Robert Schnur
Cecilia Arana-Grant & Kevin Grant	& Denise Burse	Ilana Levine & Dominic Fumusa	Maury Schott
Jonathan Aviv	Martin Fetner & William Coury	Anna Li & Frank Sposato	Whitney Scott & Peter Jacobson
Ben Baerenholtz	Angelina Fiordellisi & Matt Williams	Mark Linn-Baker & Adrienne Lobel	Lauren Seikaly & Michael Huber
Jessica Bauman	Terry Fitzpatrick	Paul Logan	Mitchell Semel & Colleen Carroll
Christopher & Francesca Beale	& Stephen Perpeluk	Katherine Lumb	Robert Shaffron & John Davis
Lisa Benavides & Tim Nelson	Anita Flanagan & Jeff Potter	John Lyons	Stephanie Sharis
Stephanie Berger & Paul King	Alison Fraser & Nat Magee	Greg MacPherson	Abby Jo Sigal & Matt Turner
Craig Berggren	Louis & Patrice Friedman	& Jane Perlmutter	R.L. & Jane Stine
Elizabeth Velazquez Bernstein	Thomas Gannon	Roma Maffia	Michael Stone
& Alexander Bernstein	& Emily Armstrong	Peter Manning & André Bishop	Susanna Styron & Darrell Larson
Richard Blackstone	Beverly Gasner	Jodie & Brad Markell	Daniel Sweet
& Yildez Yuksek	Jilian Cahan Gersten	Paul McCrane & Dana Kellin	Richard Sweren
Tessa Blake & Ian Williams	Paul & Liz Giamatti	Frances McDormand & Joel Coen	Daniel Swistel
Buzz Bovshow	Nancy Giles	Audrey & Danny Meyer	Jay & Rachel Tarses
Becky Browder & Ted Neustadt	Kilty Gilmour	Noël & Joe Mihalow	Brenda Thomas
Michelle Buffington	Tony Goldwyn & Jane Musky	James & Amanda Moffat	Tracy Thorne & Edmund Lewis
Natalia Bukalo	Stephen & Cathy Graham	Emily & John Morgan	Lisa Tilney
Kate Burton & Michael Ritchie	Connie Grappo & Lee Wilkof	Meg Mortimer & David Lloyd	Liz Tuccillo
Bill Camp	Michael Greif & Jonathan Fried	Neal & Amanda Moszkowski	John Turturro & Katherine Borowitz
Constance Casey	Janet Grillo & David Russell	Suzen Murakoshi & Mark Temme	Laura Valeroso & David Seidman
Rachel Chanoff	Lisa Gugenheim	Patricia M. Murphy, Esq.	Josephine Eke & Jason Valk
Sharon Chantile	& Larry Nathanson	& Adam Spilka	Wendy vanden Heuvel
Kirk & Katherine Holt Citron	Marianne Hagan	Fred Nelson	& Brad Coley
Darah Cloud & Dave Owens	David & Ann Hausmann	Randy & Rona Nelslaros	John A. Vassilaros
David Cohen	Nancy Hechinger	Cynthia Nixon	& Alex Gersten Vassilaros
& Sandra Novak Cohen	Joy & Harry Henshel	Lori O'Connor	Gonzalo Vicente
Ronald Cohen	Peter Herdrich & Karen Trott	Kevin O'Rourke & Edith Thurber	Mary Pat Walsh
Ruth Cohen & Bob Usdin	Kathy & Matthew Hobbs	Carol Ochs & Bruce MacVittie	Borah & Mildred Walton
Penny Collins	William Holtzman	Jacki Ochs & Jan Kroeze	David & Wendy Ward
Tricia Cooke	& S. Sylvia Shepard	Paul & Maria Onderdonk	Sharon Washington
Elizabeth Cooper Davis	Katy Homans & Patterson Sims	Sascha Paladino & Erin Torneo	Lynn & Sam Waterston
& Gordon J. Davis	Mark Horowitz	F. Richard Pappas	Brenda Wehle & John C. Lynch
David Costabile	Sarah Horowitz & David Venarde	Benjamin Patton	Sally & Lenny Weiss
Craig Cox	Seymour & Felicia Jacobs	Bat-Sheva & Thomas Peters	Jane Bolster & Steve Wertimer
Jeff Cox	Steven & Miriam Jacobson	Judy Goldman & Michael Pillingner	Joe White & Iris Brown
Peter & Barbara Cross	Linda LeRoy Janklow	Jeremy Posner	Carol Whitesides
Suzanne Dallimore	Donna & Thomas Jaycox	Christopher Randolph	Daniel Wiener
Arthur Dantchik	Amanda Johns	Peter & Helen Randolph	& Ellen Freudenheim
Cathy Dantchik	Andrea Johnson	Willie Reale & Jenny Gersten	Jenny Wiener & Jon Steingart
Leslie Dantchik	Douglas & Katie Jordan	David & Anita Rogerson	Michael & Zena Wiener
Peter & Judith Dawkins	Bonnie Kantor	Daryl Roth	Elizabeth Williams & Joseph Forte
Robert de Rothschild	Mark Keoppen	Ida Roth	Joanne Woodward
Whitney Dow	& Wendy Townsend	Martha Roth & Bill Irwin	& Paul Newman
& Thomasine Dolan Dow	Seth & Beth Klarman	Shirley Rumierk	Jeffrey & Janine Yass
Richard & Rebecca Dresser	Mary Kong	Arnold & Agnes Sametz	
Greg Durkin & Vanessa Beecroft	Henry Krieger	Laura Sametz & Anton Fig	
Ned Eisenberg & Patricia Maguire	Judy Kuhn & David Schwab	Don Scardino & Dana Williams	
Beth Emelson	Roger & Belle Kuhn	Zeborah Schachtel	
Arthur & Louise Ermelino	Warren Leight	Karin & Tom Schall	

## THE 52ND STREET PROJECT PRESENTS

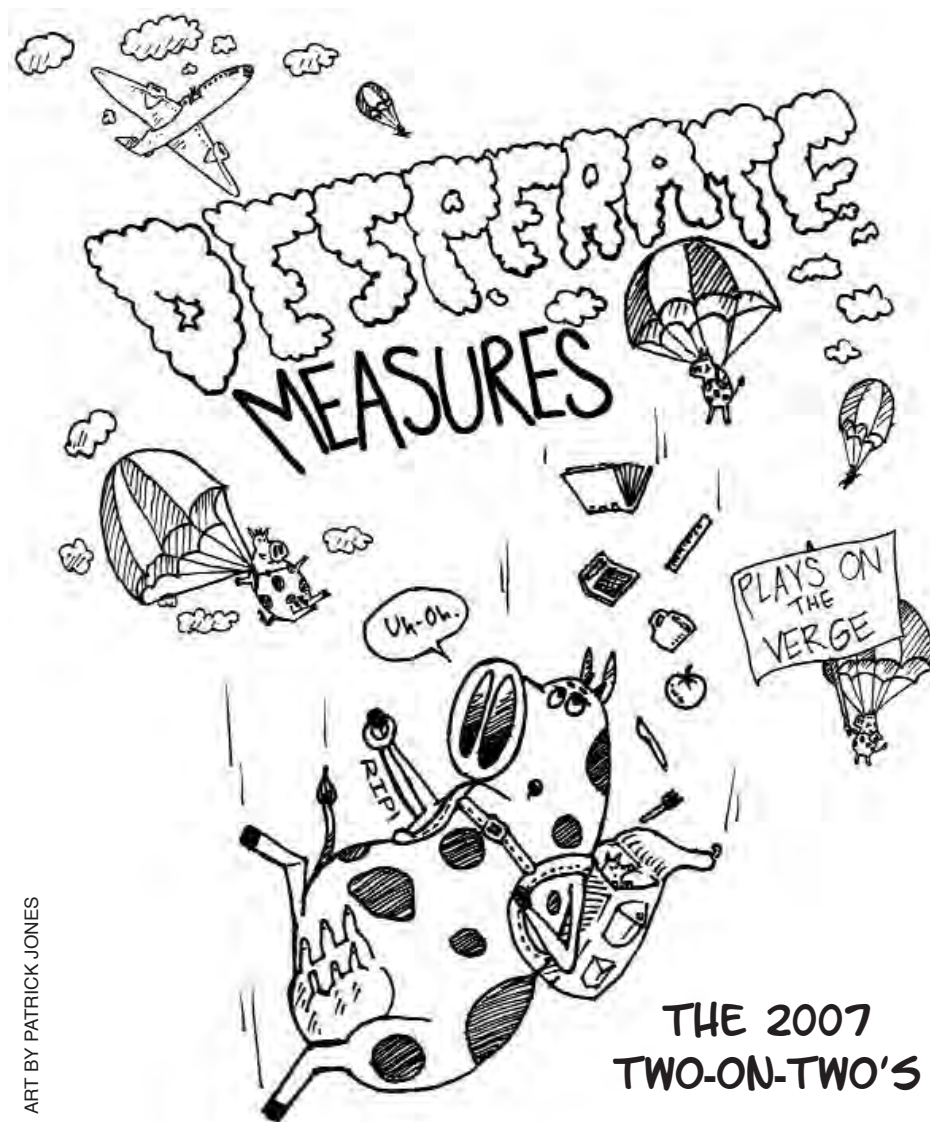

ART BY PATRICK JONES

## THE 2007 TWO-ON-TWO'S

FRIDAY, JANUARY 26 AT 7:30 P.M.  
SATURDAY, JANUARY 27 AT 3:00 & 7:30 P.M.  
SUNDAY, JANUARY 28 AT 3:00 P.M.

THE WOMEN'S INTERART ANNEX  
500 W. 52ND STREET

# DESPERATE MEASURES PLAYS ON THE VERGE

The 2007 Two-on-Two's - January 26-28  
The Women's Interart Annex

## The 52nd Street Project Staff

Gus Rogerson, Artistic Director  
 Carol Ochs, Executive Director  
 John Sheehy, Director of Development and Marketing  
 George "Smartacus" Babiak, Production Manager  
 Reg Flowers, Associate Artistic Director  
 Liz Bell, Director of Education  
 Megan Cramer, Program Director  
 Diana Rojas, Executive Assistant  
 Josh Moody, Development Assistant  
 Chris Ceraso, Teen Dean  
 Iris A. Brown, Graphic Designer  
 Solangee Acosta, Johanna Vidal, Jazzy Hernandez, Kayelani Silva, Receptionists  
 Jeremy Basescu, Matthew Rickart, Interns

## Production Staff

### Composer:

Andrew Sherman

### Set Designer:

Kevin Joseph Roach

### Lighting Designer:

Greg MacPherson

### Costume Designer:

Summer Lee Jack

### Sound Designer:

Mayleen Cancel

### Stage Manager:

Sadie Bancroft

### Slide Designers:

George Babiak, Matthew Rickart

### Prop Design Team:

George Babiak, Josh Moody,

Matthew Rickart

### Furniture Crew:

Matthew Rickart, Mark Gamero

### Prop Crew:

Jeremy Basescu, Nicole Fargardo, Mordecai  
Santiago

### Load-in and Light Hang Crew:

Jeremy Basescu, Lee and Melissa  
Briggs, Ephraim Lopez, Anne  
O'Sullivan, Matthew Rickart,  
Tom Schall,

### House Managers:

Karin Schall, Mary Pat Walsh,  
Liz Bell

### Chefs:

George Babiak, Liz Bell, Carol Ochs,  
John Sheehy

### Hosts:

Maria Tucci and Robert Gottlieb,  
Frances McDormand, Fisher Stevens

### Flyer/Program artwork:

Patrick Jones

The Two-on-Two Program is made possible with public funds from The New York State Council on the Arts, a state agency; and the New York City Department of Cultural Affairs. The 52nd Street Project is supported by funds from the National Endowment for the Arts. The Project is member of ART/NY.



## MAD COOL STUFF ON SALE!

Flyer Bars .....\$2.00, \$1.50 & \$1.00

*Shel Silverstein's "Fivey and Twoey" logo gear:*

Project Hoodies .....\$30.00

Project Caps .....\$20.00

Project Mugs .....\$5.00

Project Pencil 3-pack .....\$1.00

Project Notebooks .....\$5.00

Thank you for coming to **DESPERATE MEASURES**. If you are not on our mailing list (or if your address has changed), please fill out this form and give it to us on your way out or mail it to the address below. We would also like to know if you are interested in becoming a volunteer. We need help in **all areas**, so be sure to fill out the entire form.

### PLEASE ADD ME TO YOUR MAILING LIST:

01/07

NAME: \_\_\_\_\_

ADDRESS: \_\_\_\_\_

ZIP \_\_\_\_\_

HOME PHONE: \_\_\_\_\_

DAYTIME PHONE: \_\_\_\_\_

E-MAIL ADDRESS: \_\_\_\_\_

MY OCCUPATION: \_\_\_\_\_

MY HOBBIES: \_\_\_\_\_

### YES, I WOULD LIKE TO BE OF HELP. I CAN:

- |   |   |  |
|---|---|--|
| <input type="checkbox"/> Help load in and out for shows | <input type="checkbox"/> Draw and/or paint  | <input type="checkbox"/> Help kids with homework |
| <input type="checkbox"/> Hang lights                    | <input type="checkbox"/> Help with mailings | <input type="checkbox"/> Teach kids a skill      |
| <input type="checkbox"/> Work on a backstage crew       | <input type="checkbox"/> Do office work     | <input type="checkbox"/> Be a chef at an event   |
| <input type="checkbox"/> Do graphic design              | <input type="checkbox"/> Design sound       | <input type="checkbox"/> Design and sew costumes |
| <input type="checkbox"/> Other (please specify) _____   |   |  |

### MY SCHEDULE IS:

- Very flexible. I'm often available during weekdays.  
 Somewhat flexible. I can help on the occasional morning or afternoon during the week.  
 Not very flexible at all, but I've got some free time on evenings and weekends.

If you would like to mail this (and you're always welcome to enclose a tax-deductible contribution), you can send it to: **The 52nd Street Project**, 500 West 52nd St., New York, NY 10019. Or fax it to (212) 333-5598.



## Don't Miss Our Upcoming Shows!

# 52 + 365 = ?

Friday, February 23 at the Project Clubhouse  
Sunday, March 4 at The Public Theater



On November 13, 2002, Pulitzer-prize winner **Suzan-Lori Parks** got an idea to write a play a day for a year. This play cycle is called **365 Plays/365**

**Days**. In New York City, over the course of this year, over 60 selected theater companies—curated by **The Public Theater** and the **365 National Festival**—will perform these brief, brilliant plays.

The 52nd Street Project's production of 365 will bring together Project veterans, ages 13-15, performing under our own roof at 52nd and 10th. Travel through the hallways, rehearsal rooms, and offices of the Clubhouse on a site-specific odyssey with kids from the Kitchen and 7 days of Ms. Parks. On our turf, surprises lurk around every corner.



**PLAYS THAT TALK BACK**

### The Spring Edition of the Project's Playmaking Program

*Theater to be announced.*

*March 30 and 31, and April 1*

At this moment, 10 brand-new Project kids are taking Reg Flowers' Playmaking class. Come see the plays they write as performed by adult professional actors!

*Call 642-5052 for reservations.*

Honorary "co-chairs" Wilmer Valderrama and Robin Williams, along with the Board of Directors, invite you to the Project's annual benefit on

## Monday, May 7, 2007

# CHARRED BLACK

## The 52nd Street Project Roasts Lewis Black

An evening of scorching comedy and rotisserie chicken

### GOTHAM HALL, 7:00 p.m.

The 52nd Street Project is a non-profit organization that brings children from the Hell's Kitchen neighborhood together with professional theater artists to create original theater. **Desperate Measures** is a production of our Two-on-Two's program, in which an adult playwright crafts a piece for a pair of Project kids to perform. Another adult directs the kids for a month that includes an intensive three-day weekend in upstate New York. Tonight's performance is the final result.

### The 52nd Street Project Board of Directors

Ben Barenholtz  
Lisa Benavides  
Rachel Chanoff  
Cathy Dantchik  
Noël Dawkins  
Wendy Ettinger,  
*chair emeritus*  
Louis P. Friedman  
Stephen Graham, *chair*  
Larry Jones  
James McDaniel  
Frances McDormand  
Patricia M. Murphy, Esq.

Carol Ochs  
Willie Reale,  
*founder*  
Gus Rogerson  
Shirley Rumierk,  
*alumni member*  
José Soto, Jr.,  
*alumni member*  
Pamala Tyson  
Laura Valeroso  
Wendy vanden Heuvel  
John A. Vassilaros  
Jenny Wiener

### Special Thanks

We're grateful to **Margot, Ronnie, Josh**, and the rest of the staff at **Women's Interart Annex** for making their extremely convenient space available to us. We also owe big-time thanks to **Maria Tucci** and **Robert Gottlieb, Frances McDormand**, and **Fisher Stevens**, all of whom graciously allowed us to use their upstate homes for three tumultuous and fun-filled days. Our gratitude also goes to Super Project Pal **Ron Fiorina** of **Boylan Bottling Co.**, and **D'Agostino's Supermarkets**, and board member **John A. Vassilaros** (a.k.a. Johnny Coffeeshopolis) for contributing our intermission refreshments.

### In-Kind Contributions

The Murphy Law Office; Benefit Cosmetics; Iris A. Brown; Comptoir Sud Pacifique, Ron Kastner and Capital Printing; Kenneth Cole Productions; D'Agostino's; ICI; Noggin; Entertainment Weekly; Newman's Own; Pharma Print/Omni Graphics; Sesame Workshop; Wendy Stuhlberg; John A. Vassilaros; Watkins, Inc.; Mayor's Office of Film & Television; Boylan's Bottling Co.; Lorraine Tobias & Imaginary Studios; Warner Chappell Music Group, Shapiro & Lobel; Simon Spotlight Entertainment, an imprint of Simon and Schuster; Hudson Scenic; Noggin/The N; Prime Films, Mario Badescu; Dlageo Chateau & Estate Wines Co.; Showman Fabricators; Frédéric Fekkai & Co., LLC and Paul, Weiss, Rifkind, Wharton & Garrison LLP

## DESPERATE MEASURES - ACT I

All original music composed and played by Andrew Sherman

### Destiny's Calling

By Erin Quinn Purcell. Directed by Claudia Zelevansky.

Lana Peters .....Kayelani Silva  
Stevie LeFevre .....Hera Andre-Bergmann

*"Leap of Faith"* lyrics by Erin Quinn Purcell.

### Movie Stars

By Daniel Goldfarb. Directed by Josh Lewis.

Zendel Seattle .....Muhammad Cunningham  
Huge Actman .....Dale Fetterman  
Director's Voice .....Josh Lewis

*"Save Ryan from Dyin'"* and *"A Boy Down Under"* lyrics by Daniel Goldfarb.

### Knife to Meet You

By George Babiak. Directed by Megan Cramer.

The Great Stabini .....Steven Castellanos  
Beatrice .....Jennifer Ramirez

*"The Tango of the Knives"* lyrics by George Babiak.

☞ **Intermission!** ☜

Root Beer Floats, Coffee,  
and Flyer Bars in the lobby!

## DESPERATE MEASURES - ACT II

### Will the Terrific Two Strike Again?

By Megan Mostyn-Brown. Directed by Nicole Watson.

Molecule Girl .....Merlaine Mendez  
Freeze Boy .....Mathew Ortiz  
The Voice .....Reg Flowers

*"Better Together"* lyrics by Megan Mostyn-Brown.

### World Premiere

By Zakiyyah Alexander. Directed by Reg Flowers.

Clarabel .....Jenisse Bouret  
Amanda Type .....Carla Olivia  
Stage Manager's Voice .....Megan Cramer

*"Fabulously Scandalous"* lyrics by Zakiyyah Alexander.

### The Adventures of Glack and Zorn of the Intergalactic Space Patrol

By Michael Bernard. Directed by Erica Schmidt.

Zorn .....Jonathan Rosario  
Glack .....A.J. Welsh  
Voice of Cindy .....Megan Cramer  
The Mepnords .....The Crew

*"My Sister"* and *"Zorn's Lament"* lyrics by Michael Bernard.



The 52nd Street Project gratefully acknowledges the support of the following foundations and corporations: AOL Time Warner, Inc.; BKSK Architects LLP; Bloomberg; The Brenner Family Foundation; Brunswick Group; Carnegie Corporation of New York; CBS; Citigroup Foundation; Consolidated Edison; Dawkins Family Foundation; St. Vincent de Paul Foundation; The Dermot Company; The Dramatists Guild Fund; Dramatists Play Service; Joelle Frank & Wilkinson Brimmer Katcher; The Horace W. Goldsmith Foundation; The William & Mary Greve Foundation; HBO; The Heisman Foundation; The Hennessy Foundation; Holland Lodge Foundation, Inc.; The Saul Horowitz, Jr. Fund; Hurlbut Family Charitable Lead Trust; The JKW Foundation; Kekst & Company; Latham & Watkins, LLP; Lloyds TSB Bank plc; James A. Macdonald Foundation; Ann M. Martin Foundation; Mellon Bank, N.A.; Noggin; Jonathan Rose Companies; Shapiro & Lobel; Showtime Networks Inc; St. Vincent De Paul Foundation; Shearman & Sterling, LLP; Stranahan Foundation; The Surdna Foundation; Theatre Communications Group, Inc.; The Tow Foundation; John A. Vassilaros & Son, Inc; The Vervane Foundation; The Law Offices of Claudia Wagner; Weil, Gotshal & Manges LLP; Wiener Family Foundation; Yorke Construction Corp. In addition, the following individuals made gifts of over \$200 to The 52nd Street Project this past year (list is current as of 1/25/07):

Raymond & Elizabeth Abbott	Wendy Ettinger & Derek McLane	Robert Sean Leonard	Erica Schmidt & Peter Dinklage
Robert Abrams & Cynthia Vance	Andrew & Sandi Farkas	& Gaby Salick	Daniel Schnur
Jace Alexander & Maddie Corman	Peter Jay Fernandez	Liza Lerner	Robert Schnur
Cecilia Arana-Grant & Kevin Grant	& Denise Burse	Ilana Levine & Dominic Fumusa	Maury Schott
Jonathan Aviv	Martin Fetner & William Coury	Anna Li & Frank Sposato	Whitney Scott & Peter Jacobson
Ben Baerenholtz	Angelina Fiordellisi & Matt Williams	Mark Linn-Baker & Adrienne Lobel	Lauren Seikaly & Michael Huber
Jessica Bauman	Terry Fitzpatrick	Paul Logan	Mitchell Semel & Colleen Carroll
Christopher & Franosca Beale	& Stephen Persepeluk	Katherine Lumb	Robert Shaffron & John Davis
Lisa Benavides & Tim Nelson	Anita Flanagan & Jeff Potter	John Lyons	Stephanie Sharis
Stephanie Berger & Paul King	Alison Fraser & Nat Magee	Greg MacPherson	Abby Jo Sigal & Matt Turner
Craig Berggren	Louis & Patrice Friedman	& Jane Perlmutter	R.L. & Jane Stine
Elizabeth Velazquez Bernstein	Thomas Gannon	Roma Maffia	Michael Stone
& Alexander Bernstein	& Emily Armstrong	Peter Manning & André Bishop	Susanna Styron & Darrell Larson
Richard Blackstone	Beverly Gasner	Jodie & Brad Markell	Daniel Sweet
& Yildez Yuksek	Jilian Cahan Gersten	Paul McCrane & Dana Kellin	Richard Sweren
Tessa Blake & Ian Williams	Paul & Liz Giamatti	Frances McDormand & Joel Coen	Daniel Swistel
Buzz Bovshow	Nancy Giles	Audrey & Danny Meyer	Jay & Rachel Tarses
Becky Browder & Ted Neustadt	Kilty Gilmour	Noël & Joe Mihalow	Brenda Thomas
Michelle Buffington	Tony Goldwyn & Jane Musky	James & Amanda Moffat	Tracy Thorne & Edmund Lewis
Natalia Bukalo	Stephen & Cathy Graham	Emily & John Morgan	Lisa Tilney
Kate Burton & Michael Ritchie	Connie Grappo & Lee Wilkof	Meg Mortimer & David Lloyd	Liz Tuccillo
Bill Camp	Michael Greif & Jonathan Fried	Neal & Amanda Moszkowski	John Turturro & Katherine Borowitz
Constance Casey	Janet Grillo & David Russell	Suzen Murakoshi & Mark Temme	Laura Valeroso & David Seidman
Rachel Chanoff	Lisa Gugenheim	Patricia M. Murphy, Esq.	Josephine Eke & Jason Valk
Sharon Chantile	& Larry Nathanson	& Adam Spilka	Wendy vanden Heuvel
Kirk & Katherine Holt Citron	Marianne Hagan	Fred Nelson	& Brad Coley
Darah Cloud & Dave Owens	David & Ann Hausmann	Randy & Rona Nelson	John A. Vassilaros
David Cohen	Nancy Hechinger	Cynthia Nixon	& Alex Gersten Vassilaros
& Sandra Novak Cohen	Joy & Harry Henshel	Lori O'Connor	Gonzalo Vicente
Ronald Cohen	Peter Herdrich & Karen Trott	Kevin O'Rourke & Edith Thurber	Mary Pat Walsh
Ruth Cohen & Bob Usdin	Kathy & Matthew Hobbs	Carol Ochs & Bruce MacVittie	Borah & Mildred Walton
Penny Collins	William Holtzman	Jacki Ochs & Jan Kroeze	David & Wendy Ward
Tricia Cooke	& S. Sylvia Shepard	Paul & Maria Onderdonk	Sharon Washington
Elizabeth Cooper Davis	Katy Homans & Patterson Sims	Sascha Paladino & Erin Torneo	Lynn & Sam Waterston
& Gordon J. Davis	Mark Horowitz	F. Richard Pappas	Brenda Wehle & John C. Lynch
David Costabile	Sarah Horowitz & David Venarde	Benjamin Patton	Sally & Lenny Weiss
Craig Cox	Seymour & Felicia Jacobs	Bat-Sheva & Thomas Peters	Jane Bolster & Steve Wertimer
Jeff Cox	Steven & Miriam Jacobson	Judy Goldman & Michael Pillingier	Joe White & Iris Brown
Peter & Barbara Cross	Linda LeRoy Janklow	Jeremy Posner	Carol Whitesides
Suzanne Dallimore	Donna & Thomas Jaycox	Christopher Randolph	Daniel Wiener
Arthur Dantchik	Amanda Johns	Peter & Helen Randolph	& Ellen Freudenheim
Cathy Dantchik	Andrea Johnson	Willie Reale & Jenny Gersten	Jenny Wiener & Jon Steingart
Leslie Dantchik	Douglas & Katie Jordan	David & Anita Rogerson	Michael & Zena Wiener
Peter & Judith Dawkins	Bonnie Kantor	Daryl Roth	Elizabeth Williams & Joseph Forte
Robert de Rothschild	Mark Keoppen	Ida Roth	Joanne Woodward
Whitney Dow	& Wendy Townsend	Martha Roth & Bill Irwin	& Paul Newman
& Thomasine Dolan Dow	Seth & Beth Klarman	Shirley Rumierk	Jeffrey & Janine Yass
Richard & Rebecca Dresser	Mary Kong	Arnold & Agnes Sametz	
Greg Durkin & Vanessa Beecroft	Henry Krieger	Laura Sametz & Anton Fig	
Ned Eisenberg & Patricia Maguire	Judy Kuhn & David Schwab	Don Scardino & Dana Williams	
Beth Emelson	Roger & Belle Kuhn	Zeborah Schachtel	
Arthur & Louise Ermelino	Warren Leight	Karin & Tom Schall	

GUS ROGERSON  
ARTISTIC DIRECTOR

CAROL OCHS  
EXECUTIVE DIRECTOR

REG FLOWERS  
PLAYMAKING DIRECTOR

## THE 52ND STREET PROJECT PRESENTS



SATURDAY, MARCH 31 AT 3:00 & 7:30 P.M.  
SUNDAY, APRIL 1 AT 3:00 P.M.

# PLAYWRIGHTS HORIZONS

416 WEST 42ND ST.

# SEZ WHO?!

Plays That Talk Back - March 31 -April 1, 2007  
Playwrights Horizons Mainstage Theater

## The 52nd Street Project Staff

Gus Rogerson, Artistic Director  
Carol Ochs, Executive Director  
John Sheehy, Director of Development and Marketing  
George Babiak, Production Manager  
Reg Flowers, Associate Artistic Director  
Liz Bell, Director of Education  
Megan Cramer, Program Director  
Diana Rojas, Executive Assistant  
Josh Moody, Development Assistant  
Chris Ceraso, Teen Dean  
Iris A. Brown, Graphic Designer  
Solangee Acosta, Johanna Vidal, Jazzy Hernandez,  
Kayelani Silva, Receptionists  
Jeremy Basescu, Intern

## Production Staff

**Composer:** Loren Toolajian  
**Set Designer:** Kevin Joseph Roach  
**Lighting Designer:**  
Greg MacPherson  
**Costume Designers:**  
Kate Cusack and  
Arnulfo Maldonado  
**Goddess of Sound:**  
Vanessa Valdes  
**Stage Manager:**  
Sadie Bancroft  
**Slide Designers:**  
Tracy Rosiene  
and the Project's Slide Art Archive  
"Sez Who?!" **Art:** Sara Varon

## Prop Design Team:

George Babiak, Megan Cramer,  
Rohit Kapoor, Debbie Lee Jones,  
Karen Munkel, Isabel Tewes

## Backstage Crew:

Jeremy Basescu, Anikke Fox,  
Jason Gil, Patrick Jones,  
Terrence Mack, & Noah Trepanier.

## Load-in and Light Hang Crew:

Desi Fischer, Tim Knapp,  
Karen Munkel, Doug Nervik,  
Jay Scott, Becky White.

## House Managers:

Karin Schall  
and Liz Bell

The Playmaking Program is made possible with public funds from The New York State Council on the Arts, a state agency, and the National Endowment for the Arts. The 52nd Street Project is a member of Art/NY.



# COOL STUFF ON SALE!

Flyer Bars .....\$2.00, \$1.50 & \$1.00

*Shel Silverstein's "Fivey and Twoey" logo gear:*

Project "Hoodies" .....\$25.00

Project Ball Caps .....\$20.00

Project T-Shirts .....\$12.00

Project Mugs .....\$5.00

Project Notebooks .....\$5.00

Project Pencil 3-pack .....\$1.00

Thank you for coming to **SEZ WHO?!** If you are not on our mailing list (or if your address has changed), please fill out this form and give it to us on your way out or mail it to the address below. We would also like to know if you are interested in becoming a volunteer. We need help in **all areas**, so be sure to fill out the entire form.

## PLEASE ADD ME TO YOUR MAILING LIST:

03/07

NAME: \_\_\_\_\_

ADDRESS: \_\_\_\_\_

ZIP \_\_\_\_\_

HOME PHONE: \_\_\_\_\_

DAYTIME PHONE: \_\_\_\_\_

E-MAIL ADDRESS: \_\_\_\_\_

MY OCCUPATION: \_\_\_\_\_

MY HOBBIES: \_\_\_\_\_

## YES, I WOULD LIKE TO BE OF HELP. I CAN:

- |   |   |  |
|---|---|--|
| <input type="checkbox"/> Help load in and out for shows | <input type="checkbox"/> Draw and/or paint  | <input type="checkbox"/> Help kids with homework |
| <input type="checkbox"/> Hang lights                    | <input type="checkbox"/> Help with mailings | <input type="checkbox"/> Teach kids a skill      |
| <input type="checkbox"/> Work on a backstage crew       | <input type="checkbox"/> Do office work     | <input type="checkbox"/> Be a chef at an event   |
| <input type="checkbox"/> Do graphic design              | <input type="checkbox"/> Design sound       | <input type="checkbox"/> Design and sew costumes |
| <input type="checkbox"/> Other (please specify) _____   |   |  |

## MY SCHEDULE IS:

- Very flexible. I'm often available during weekdays.  
 Somewhat flexible. I can help on the occasional morning or afternoon during the week.  
 Not very flexible at all, but I've got some free time on evenings and weekends.

If you would like to mail this (and you're always welcome to enclose a tax-deductible contribution), you can send it to: **The 52nd Street Project**, 500 West 52nd St., New York, NY 10019. Or fax it to (212) 333-5598.

Honorary “co-chars” Stephen Colbert, Wilmer Valderrama and Robin Williams, along with the Board of Directors, invite you to Sauté the Date

# Monday, May 7, 2007



AN EVENING OF SCORCHING COMEDY AND ROTISSERIE CHICKEN

## GOTHAM HALL, 7:00 P.M.

For more inflammation or reservations, call  
John “Shish kebob” Sheehy at (212) 333-5252  
or write him at [sheehy@52project.org](mailto:sheehy@52project.org)

The 52nd Street Project is a non-profit organization that brings children from the Hell’s Kitchen neighborhood together with professional theater artists to create original theater. **SEZ WHO?!** is a production of our Playmaking program. Young people participate in a nine-week playwriting course taught by Reg Flowers and adapted for the Project by Daniel Judah Sklar from his book *Playmaking: Children Writing and Performing Their Own Plays*. At the end of the course, each child is given two actors, a theme, and a dramaturg/director who guides him or her through the writing of a play during a weekend retreat in the country (Kent, Connecticut, for this show). Tonight’s performance is the end result.

### The 52nd Street Project Board of Directors

Ben Barenholtz  
Lisa Benavides  
Rachel Chanoff  
Cathy Dantchik  
Wendy Ettinger,  
*chair emeritus*  
Louis P. Friedman  
Stephen Graham, *chair*  
Larry Jones  
James McDaniel  
Frances McDormand  
Noël Mihalow

Carol Ochs  
Willie Reale,  
*founder*  
Gus Rogerson  
Shirley Rumierk,  
*alumni member*  
José Soto, Jr.,  
*alumni member*  
Pamala Tyson  
Wendy vanden Heuvel  
John A. Vassilaros  
Jenny Wiener

### Special Thanks

We’re grateful to **Stephen, Cathy, Juliet, and Tommy Graham** for graciously allowing us to bring the chaos of a Playmaking weekend to their lovely home in Kent, Connecticut. Their staff gets a round of applause, too. Thanks also go to **Sam and Lynn Waterston, and Emily Armstrong and Kevin and Patrick Gannon** for providing accommodations. Thanks also to **Tonya Canada, Craig Cox, Chloe Demrovsky, Liz Flahive, and Margaret Lewis** for helping out in Playmaking class. We must finally thank Tim Sanford, Leslie Marcus, Sandra Garner, Chris Boll, Tim Knapp, and everyone at Playwrights Horizons for the use of their beautiful theater and for all their help.

### In-Kind Contributions

The Murphy Law Office; Benefit Cosmetics; Iris A. Brown; Comptoir Sud Pacifique, Ron Kastner and Capital Printing; Kenneth Cole Productions; D’Agostino’s; ICI; Noggin; Entertainment Weekly; Newmann’s Own; Pharma Print/Omni Graphics; Sesame Workshop; Wendy Stuhlberg; John A. Vassilaros; Watkins, Inc.; Mayor’s Office of Film & Television; Boylan’s Bottling Co.; Lorraine Tobias & Imaginary Studios; Warner Chappell Music Group, Shapiro & Lobel; Simon Spotlight Entertainment, an imprint of Simon and Schuster; Hudson Scenic; Noggin/The N; Prime Films, Mario Badescu; Dlageo Chateau & Estate Wines Co.; Showman Fabricators; Frédéric Fekkai & Co., LLC and Paul, Weiss, Rifkind, Wharton & Garrison LLP, and Shapiro & Lobel.

## SEZ WHO?! - ACT I

All original music composed and performed by Loren Toolajian

### The Flashback

by Kimberly Senteno, age 10. Dramaturg/Director: Maury Schott  
Costume Designer: Arnulfo Maldonado

Greg .....Kevin Geer  
Saphire .....Elizabeth Canavan  
Greg's Dad/Stacy .....Patrick Jones  
Saphire's Mom/Jenny .....Anikke Fox  
*"Let's Stay Together" (and Reprise)* lyrics by Kimberly Senteno

### Mees's Opportunity

by Zoltan Lucas, age 10. Dramaturg/Director: George Babiak  
Costume Designer: Arnulfo Maldonado

Mees .....Matt Citron  
Rocky .....Barnett Cohen  
Waiter .....Jeremy Basescu  
Mice Populace .....The Crew

### The Competition

by Gabriella DeJesus, age 10. Dramaturg: Diana Rojas  
Director:Gus Rogerson Costume Designer: Kate Cusack

Dishanair .....Florencia Lozano  
Ben .....James McDaniel (Sat.), Ed Vassallo (Sun.)  
The Announcer .....Noah Trepanier  
Tavon .....Jason Gil

### The Break-Up

by Raphael Irizarry III, age 10. Dramaturg/Director: Julia Gibson  
Costume Designer: Kate Cusack

Monica .....Liza Colon-Zayas  
Ben .....David Costabile

### Vanilla and Hoppy are Friends

by Brandon Leon, age 9. Dramaturg/Director: Liza Steinberg  
Costume Designer: Arnulfo Maldonado

Vanilla .....Vanessa Aspillaga  
Hoppy .....Dominic Colon  
Mom .....Anikke Fox  
Dad/Party guests .....Noah Trepanier and the Crew  
*"Vanilla and Hoppy are Twins"* lyrics by Brandon Leon

## SEZ WHO?! - ACT II

### Problems in Life

by Lauren Robinson, age 9. Dramaturg/Director: Liliana Amador-Marty  
Costume Designer: Kate Cusack

Tia .....Elizabeth Marvel  
Fish .....Howard Overshown  
*"Please Marry Me" and "I Don't Want to Marry You"* lyrics by Lauren Robinson

### The Smarchian

by Melissa Rebolledo, age 10. Dramaturg/Director: Mariana Carreño  
Costume Designer: Arnulfo Maldonado

Smarchian .....Keira Naughton  
Jenifer .....Sharon Washington

### Michelle and Rosey (The Musical)

by Jazmine Mikell, age 10. Dramaturg: Liz Flahive  
Director: Megan Cramer Costume Designer: Kate Cusack

Michelle .....Nana Mensah  
Rosey .....Tonya Canada  
*"The Together Song," "Best Friends," "Counting," "Let It Be Over," "I Don't Want To," "Violet City National Anthem," and "Family"* lyrics by Jazmine Mikell

### The Price

by Chanel Rodney, age 10. Dramaturg/Director: Thom Sesma  
Costume Designer: Kate Cusack

Ice Man .....Danyon Davis  
Ice Cat .....Robert Montano

### The Love of a Thief and a Lady

by Tino Paduani, age 11. Dramaturg: Jeremy Basescu  
Director: Tom Schall Costume Designer: Arnulfo Maldonado

Hanna Jane .....Edie Falco  
Erek .....Jeremy Beck  
*"When I Catch the Thief," "I Just Saw a Lady," "Doing As You're Told" and "Wherever I Go"* lyrics by Tino Paduani

I  
N  
T  
E  
R  
M  
I  
S  
S  
I  
O  
N

Honorary Co-chairs  
**Stephen Colbert, Wilmer Valderrama  
and Robin Williams**

Corporate Host

**Ars Nova**

and the Board of Directors of  
The 52nd Street Project present



**CHARRED  
BLACK**

**THE 52ND STREET PROJECT  
ROASTS LEWIS BLACK**

**BOARD CHAIR**

Stephen Graham

**EXECUTIVE DIRECTOR ARTISTIC DIRECTOR**

Carol Ochs

Gus Rogerson

## CO-CHAIRS

Lisa Benavides  
Becky Browder  
Cathy Dantchik  
Louis P. Friedman  
Patrice Friedman

Jenny Gersten  
Karin Schall  
Laura Valeroso  
Mary Pat Walsh  
Jenny Wiener

## THE BOARD OF DIRECTORS

Ben Barenholtz  
Lisa Benavides  
Rachel Chanoff  
Cathy Dantchik  
Wendy Ettinger,  
*chair emeritus*  
Louis P. Friedman  
Stephen Graham, *chair*  
Larry Jones  
James McDaniel  
Frances McDormand  
Noël Mihalow

Carol Ochs  
Willie Reale,  
*founder*  
Gus Rogerson  
Shirley Rumierk,  
*alumni member*  
José Soto, Jr.,  
*alumni member*  
Pamala Tyson  
Wendy vanden Heuvel  
John A. Vassilaros  
Jenny Wiener

## THE 52ND STREET PROJECT GRATEFULLY ACKNOWLEDGES...

Iris A. Brown  
Bumble and bumble  
Capital Printing/Ronald J. Kastner  
Kenneth Cole Productions  
Comedy Central  
William Curran, Curran Affair  
Diageo Chateau & Estate Wines Co.  
HBO Video  
La Mer  
Jo Malone  
Newman's Own  
Noggin/The N  
Pharma/Omni Printing  
Sentry Industries  
Sesame Workshop  
Shapiro Lobel, LLP  
Wendy Stulberg  
John A. Vassilaros & Sons  
Warner/Chappell Music, Inc.  
Watkins Incorporated  
*Healthier Living Since 1868*  
I. Weiss and Sons, Inc.

## THE ROAST

### YOUR HOST

Mark Linn-Baker

### THE ROASTERS

John Bowman  
Nancy Giles  
Judith Ivey  
Kathleen Madigan  
Neil Mazzella  
Richard Myrie  
Steve Olsen

### THE MATCHLESS DANCERS

Merlaine Mendez, Mathew Ortiz  
and Kayelani Silva

### THE HOT LICKS BAND

Ben Butler, Guitar  
Anton Fig, Drums  
Tim Luntzel, Bass  
Andrew Sherman, Keyboards  
and Music Direction

*"Black Magic" lyrics by Steve Sajich  
(with apologies to Johnny Mercer)*

*"Black" lyrics by Rusty Magee  
(with apologies to Isaac Hayes)*

### DIRECTED BY

Jonathan Bernstein

### CHOREOGRAPHY

Megan Cramer

### LIGHTING DESIGN

Greg MacPherson and  
Alistair Wandesforde-Smith

### COSTUME DESIGN

Crystal Thompson

### SET DESIGN

George Babiak

### SOUND DESIGN

Scott Lehrer

### STAGE MANAGER

Karen Munkel

## BLAZE OF GLORY TABLES

The Dantchik Family  
Patrice & Louis Friedman  
Cathy & Stephen Graham  
Jenny Wiener & Jon Steingart, Ars Nova

## RING OF FIRE TABLES

Wendy Ettinger & Derek McLane  
Janine & Jeffrey Yass

## FLAMETHROWER TABLES

Comedy Central  
Carolyn & Neil DeSena  
Alexandra Gersten-Vassilaros &  
Johnny Coffeeshopolis  
Neil Mazzella, Hudson Scenic Studio, Inc.  
Paulette & Jeremy Posner  
Joanne Woodward & Paul Newman

## TOASTED TABLES

BKSK Architects  
CBS Corporation  
The Dawkins Family Foundation  
Rose Gasner & Larry Chertoff  
James Gosnel, APA Talent & Literary Agency  
HBO  
Katheryn Holt & Kirk Citron  
Lloyds TSB Bank plc  
Fred Nelson  
Jonathan Rose Companies, Owner's  
Representative Studio  
Sesame Workshop  
Shearman & Sterling LLP  
Erica Steinberger, Latham & Watkins, LLP  
Wendy vanden Heuvel & Brad Coley

## HOT SEATS

Amy Aquino & Drew McCoy  
Becky Ann & Dylan Baker  
Lisa Benavides Nelson & Tim Blake Nelson  
Elizabeth & Alexander Bernstein  
Alfred C. Cerullo, III  
Penelope Collins  
Jennifer Crittendon & Bill Wrubel  
Michael Engler & Steve Sumser  
Jessalyn Gilsig & Bobby Salomon  
Betsy & Fred Graver  
Karen Hauser & Warren Leight  
Sarah Horowitz & David Venarde

Charlie Huntley  
Marcella Kahn  
Cynthia Kaplan & David Froelich  
Marjorie & Michael Loeb  
Luchia  
Edie Lutnick  
John S. Lyons  
Grace Lyu-Volckhausen  
Josephine Merck & Jim Stevenson  
Rona & Randy Nelson  
Jane Perlmutter & Greg MacPherson  
Ana Rosa & Peter Phillips  
Anita A. & David S. Rogerson  
David Rosenberg, I. Weiss and Sons, Inc.  
Steve Sabba, Tax Pro Financial Network, Inc.  
Jane & R.L. Stine  
Anne Torsiglieri & Michael Bernard  
Adriana Trigiani & Tim Stephenson  
Liz Tuccillo  
Laura Valeroso & David Seidman  
Cynthia Vance & Robert Abrams  
Claudia Wagner & Don Lebowitz  
Sally Weiss  
Elizabeth Williams & Joseph Forte

## SMOLDERING SEATS

Cecilia Arana-Grant  
Emily Armstrong &  
Thomas Patrick Gannon  
Jo Anne Astrow &  
Mark Lonow  
Ben Barenholtz  
Paige & Andrew Bart  
Gavin Berger &  
Craig Berggren  
Stephanie Berger &  
Paul King  
Stephen Bernstein  
Matt Boggie  
Jane Bolster &  
Steve Wertimer  
June Brody  
Becky Browder &  
Ted Neustadt  
Michelle Buffington  
John Burke  
Denise Burse &  
Peter Jay Fernandez  
Jean Candiotte  
Cora Cahan &  
Bernard Gersten  
Sharon Chantiles  
Maddie Corman &  
Jace Alexander  
Catherine Corpeny &  
Max D. Mayer  
Colleen Croft  
Betsy & John Cunningham

Christina & Oliver Dobbs  
Thomasine & Whitney Dow  
Rebecca & Richard Dresser  
Martin Ross Fettner  
Alison Fraser & Nat Magee  
Katherine Freedman &  
Brian Beirne  
Hank Gallo  
Kay Gayner & Frank Wood  
Jenny Gersten &  
Willie Reale  
Elizabeth & Paul Giamatti  
Nancy Giles  
Connie Grappo & Lee Wilkof  
Joy Greenhouse  
Joe Grifasi  
Bruce Grossberg  
Lisa J. Gugenheim &  
Lawrence Nathanson  
Larry Hirsh, Sentry Industries  
Linda LeRoy Janklow  
Amanda Johns  
Bonnie Kantor  
Rohit Kapoor  
Peggy Klaus  
Judy Kuhn & David Schwab  
Mickey Lemle  
Anna Li & Frank Sposato  
Adrienne Lobel &  
Mark Linn-Baker  
Laurie Manifold  
Erin Moriarty

Suzen Murakoshi &  
Mark Temme  
Noggin/The N  
Carol Ochs &  
Bruce MacVittie  
Jacki Ochs & Jan Kroeze  
Leigh Pennebaker &  
Taro Alexander  
Michael Potts  
Christopher Randolph  
Jackie Reingold  
Harriet Rosiene  
Tracy Rosiene  
Ida Roth  
Martha Roth & Bill Irwin  
Marcia Santoni &  
John Morris  
Karin & Thomas Schall  
Maury Schott  
Mitchell R. Semel  
Pamela Shaw &  
Victor Syrmis  
Bruce Sherman  
Sylvia Shepard &  
Willy Holtzman  
Meg Simon

John Steber &  
Robert Shaffron  
Liza Steinberg & Eric Demby  
Alexandra Styron &  
Ed Beason  
Susanna Styron &  
Darrell Larson  
Richard Sweren  
Mary Testa  
Edith Thurber &  
Kevin O'Rourke  
Erin Torneo &  
Sascha Paladino  
Karen Trott &  
Peter Herdrich  
Anne Twomey &  
John Bedford Lloyd  
Mary Pat Walsh  
Sharon Washington  
Rita & Steve Weisskoff  
Carol Whitesides  
George Xenos  
Yildiz Yuksek &  
Richard Blackstone  
Connie & Marc Zand,  
Shapiro Lobel, LLP

List current as of 5/2/07

## THE 52ND STREET PROJECT STAFF

Carol Ochs, Executive Director  
Gus Rogerson, Artistic Director  
John Sheehy, Dir. of Development and Marketing  
George Babiak, Production Manager  
Reg Flowers, Associate Artistic Director  
Liz Bell, Director of Education  
Megan Cramer, Program Director  
Diana Rojas, Executive Assistant  
Josh Moody, Development Assistant  
Chris Ceraso, Teen Dean  
Iris A. Brown, Graphic Designer  
Jeremy Basescu, Intern

## BENEFIT VOLUNTEERS

Perry Daniel, Bryan Gmitter, Chris Hammett,  
Doug Nervik, Christopher Randolph,  
Kim D. Sherman, Vanessa Valdes

## SPECIAL THANKS

Becky Browder, William Curran, Liz Flahive,  
Terry Fitzpatrick, Alison Fraser, Amy Friedman,  
Jenny Gersten, Mark Jacobs, Shae Kennedy,  
John Laird, Barbara McCrane,  
Karin & Tom Schall, Mary Pat Walsh



**The 52nd Street Project** is a non-profit organization that brings children from the Hell's Kitchen neighborhood together with professional theater artists to create original theater. The Replay program gives children who are graduates of the Project's Playmaking class a chance to hone their skills in an advanced writing workshop taught by **Reg Flowers**. Over the nine weeks of Replay class, these young playwrights explored varied sources of inspiration, including a visit to the Whitney Museum, studied dramatic structure, and learned to embrace the dreaded rewrite. The resulting plays are featured in tonight's reading.

### Special Thanks

We're grateful to **James Houghton, Tara Geesaman**, and the rest of the staff at **The Signature Theatre** for making this evening possible. The plays wouldn't have made it to the page without the help of the Replay class volunteers: **Danyon Davis, Katie Flahive, Fanneke Verhallen, Patrick Jones, Jonathan Kravetz, Garrett Long, Anne O'Sullivan, David Paarlberg, Joanna Parsons, and Virginia Vitzthum**. We'd especially like to thank the **Cohen** family and friends for their support of this project.

### The Project Staff

Gus Rogerson . . . . .	Artistic Director
Carol Ochs . . . . .	Executive Director
John Sheehy . . . . .	Director of Development and Marketing
George Babiak . . . . .	Production Manager
Reg Flowers . . . . .	Associate Artistic Director
Liz Bell . . . . .	Director of Education
Megan Cramer . . . . .	Program Director
Diana Rojas . . . . .	Executive Assistant
Joshua A. Moody . . . . .	Development Assistant
Chris Ceraso . . . . .	Teen Dean
Iris A. Brown . . . . .	Graphic Designer
Receptionists . . . . .	Solangee Acosta, Johanna Vidal
Interns . . . . .	Brigid Gannon, Jonathan Dent

### The 52nd Street Project Board of Directors

Ben Barenholtz	Carol Ochs
Lisa Benavides	Willie Reale, <i>founder</i>
Rachel Chanoff	Gus Rogerson
Cathy Dantchik	Shirley Rumierk, <i>alumni member</i>
Noël Dawkins	José Soto, Jr., <i>alumni member</i>
Wendy Ettinger, <i>chair emeritus</i>	Pamala Tyson
Louis P. Friedman	Wendy vanden Heuvel
Stephen Graham, <i>chair</i>	John A. Vassilaros
Larry Jones	Jenny Wiener
James McDaniel	
Frances McDormand	

The 52nd Street Project Presents  
The Lorraine Cohen

# Replay Readings

10 new plays by  
10 young playwrights

Monday, June 11, 2007  
7:30 p.m.

The Signature Theatre at  
The Peter Norton Space  
555 West 42nd Street

## **Pain in the Neck**

by Wendell Joseph, age 10.  
Directed by Jonathan Bernstein.

Johnny Blaze .....Bill Camp  
Steven Stronghold .....Felix Solis  
Miss Werewood .....Jonathan Bernstein

## **The Competition**

by Doris Alcantara, age 10.  
Directed by John Steber.

Saphire .....Megan Cramer  
Katrina .....Diana Rojas  
Miss Sally .....Joanna Parson  
Lina .....Virginia Vitzthum

## **The Two Brothers**

by Maximo Jimenez, age 12.  
Directed by Danny Goldstein.

Johnny .....Joel de la Fuente  
Philip .....Edward O'Brien  
James .....Patrick Jones

## **Be a Leader Not a Admirer**

by Ashley Smith, age 12.  
Directed by Michael Potts.

Angela Patterson .....Caroline Clay  
John Smith .....John Ellison Conlee  
Jake Simmons .....Chris Mazza

## **School Trouble**

by Lily Capstick, age 10.  
Directed by Lisa Benavides.

Anabell .....J. Smith-Cameron  
Abigail .....Jeanine Serralles  
Mom/Principal/Mrs. Bimply .....Katie Flahive

## **Stupidtown's Worst University**

by Devin Gonzalez, age 10. Directed by Danny Goldstein.

John .....Joel de la Fuente  
Bum .....Patrick Jones  
Security Guard .....Edward O'Brien

## **Best Buddies**

by Samantha Caldon, age 11. Directed by John Steber.

Midna .....Diana Rojas  
Roxy .....Megan Cramer  
Teacher .....Joanna Parson  
Principal .....Virginia Vitzthum

## **Life**

by John Cacomanolis, age 12. Directed by Jonathan Bernstein.

James .....Felix Solis  
Christian .....Bill Camp  
Christian's friend .....Danyon Davis  
Another kid/Roosevelt Goalie .....David Paarlberg  
Coach/Ref .....Chris Mazza

## **Laura and Mary**

by Mari Ulloa, age 10. Directed by Lisa Benavides.

Laura .....Jeanine Serralles  
Mary .....J. Smith-Cameron  
People .....Katie Flahive and Lisa Benavides  
Shoeella/Singing Card .....Katie Flahive

## **Happiness or Terror**

by Armando Cosme, Jr., age 11.  
Directed by Michael Potts.

Kane .....John Ellison Conlee  
Ashley .....Caroline Clay  
Duck/Intercom/Doctor .....Michael Potts  
Big Head Doctor/  
Lady Who Does the Marriage .....Joanna Parson

**B  
R  
I  
E  
F  
  
I  
N  
T  
E  
R  
M  
I  
S  
S  
I  
O  
N**

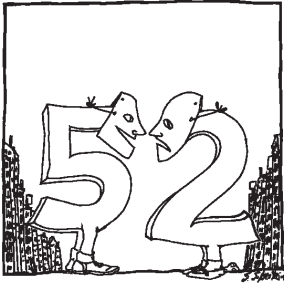

## The 52nd Street Project

The 52nd Street Project (The Project) is dedicated to the creation and production of new plays for and by kids between the ages of ten and eighteen who reside in the Hell's Kitchen neighborhood in New York City. The Project does this through unique mentoring programs that match kids with professional (and volunteer!) theater artists.

### The 52nd Street Project

The Project is about making children proud of themselves. The Project is not about teaching children to act, although they will learn to. It is not about teaching them to write plays, although they will learn that as well. What it is about is giving a kid an experience of success. It is about giving a kid an opportunity to prove that he or she has something of value to offer, something that comes from within that he or she alone possesses, something that cannot be taken away.

The Project's Teen Ensemble is the final step in the kids' training: a two-year acting class that culminates in the production of a full-length play by William Shakespeare, the very one you are seeing tonight. This year's show is being done in New York and Marfa, Texas. We are very grateful to our Lone Star hosts for enabling this tour.

*The following foundations and government agencies have generously supported the Teen Program through their contributions:*

City of New York Department of Cultural Affairs  
 Horace W. Goldsmith Foundation  
 National Endowment for the Arts  
 New York State Council on the Arts  
 The Surdna Foundation



DIRECTED BY  
**REG FLOWERS**

ADAPTED BY  
**CHRIS CERASO**  
 AND THE 52ND STREET PROJECT TEEN ENSEMBLE

PRODUCED BY  
**MEGAN CRAMER**

**NEW YORK CITY: JUNE 29 AND 30 - TBG THEATER**  
**MARFA, TEXAS: JULY 6 - THE GOODE-CROWLEY THEATER**

**The 52nd Street Project Staff**

Gus Rogerson, Artistic Director  
Carol Ochs, Executive Director

John Sheehy, Director of Development and Marketing

George Babiak, Production Manager

Reg Flowers, Associate Artistic Director

Liz Bell, Director of Education

Megan Cramer, Program Director

Diana Rojas, Executive Assistant

Josh Moody, Development Assistant

Chris Ceraso, Teen Dean

Iris A. Brown, Graphic Designer

Solangee Acosta, Johanna Vidal, Kayelani Silva, Receptionists

Jonathan Dent, Brigid Gannon, Lily Howard, Interns

***Production Staff for Romeo and Juliet:***

**Lighting Designers**

Greg MacPherson and Becky Sealander

**Costume Consultant**

Kate Cusack

**Costume Designers**

Jennifer Jimenez and Reg Flowers

**Stage Manager**

Patricia MacGregor

**Fight Choreographer**

Tom Schall

**Sound Design**

Reg Flowers

The 52nd Street Project thanks **Cicely Berry, Catherine Mueller, Justine Williams, Andy Groteleuschen, Josh Liveright** and the **Women’s Interart Annex, INTAR Theater, Porter Pickard** and the staff of **TBG Theater**. We are also indebted to **Lynn and Tim Crowley, Ree Willaford, Evelyn Luciani, Kate Hunt**, the **Thunderbird Hotel, Ballroom Marfa**, the **Chinati Foundation**, the **Pizza Foundation** and the people of **Marfa** for welcoming us to their fair city.

# THE CAST

***The House of the Prince of Verona***

**Prince**, political head of Verona / **Paris**, his cousin . . . . . Alex Tomas

**Mercutio**, kinsman of the Prince and friend to Romeo . . . . . Zebulun Santiago

***The House of Montague***

**Lord Montague**, Romeo’s father . . . . . Zebulun Santiago

**Lady Montague**, Romeo’s mother . . . . . Nicole Fargardo

**Romeo**, son of the house of Montague . . . . . Mark Gamero

**Abram**, kinsman to Romeo and the Capulets . . . . . Adrian Zambrano

**Benvolia**, kinswoman and friend to Romeo . . . . . Kamila Jacob

***The House of Capulet***

**Capulet**, head of the family and father to Juliet . . . . . Anthony Mejia

**Lady Capulet**, Juliet’s stepmother . . . . . Nikki Rosario

**Juliet**, daughter of the house of Capulet . . . . . Megan Cruz

**Naaz** (a.k.a. Nurse), cousin to Juliet . . . . . Nicole Fargardo

**Tybalt**, cousin to Lady Capulet . . . . . Christian Alvarez

**Petula**, a servant to Capulet . . . . . Ani Kehr

**Sampson**, a servant to Capulet . . . . . Joshua Joya

***Townspeople of Verona***

**Holy Lawrence**, a mystic . . . . . Joshua Joya

**Valet**, a servant to Paris . . . . . Christian Alvarez

**Captain of the Watch** . . . . . Adrian Zambrano

**The Watch** . . . . . Nicole Fargardo, Kamila Jacob

***The Town of Mantua***

**Apothecary** . . . . . Nikki Rosario

**Place:**

The Towns of Verona and Mantua.

**Time:**

An annual celebration and the days following it.

The 52nd Street Project gratefully acknowledges the support of the following foundations and corporations: Alexandra Productions, Inc.; APA; BKSK Architects LLP; Bloomberg; The Brenner Family Foundation; Carnegie Corporation of New York; CBL Center; CBS Corporation; Citigroup Foundation; Comedy Central; Consolidated Edison; Downtown Arts Development, Inc.; The Dramatists Guild Fund; Dramatists Play Service; The Horace W. Goldsmith Foundation; The William & Mary Greve Foundation; Holland Lodge Foundation, Inc.; The Saul Horowitz Jr. Fund; HBO; Hudson Scenic Studio; Hurlbut Family Charitable Lead Trust; Kekst & Company; Latham & Watkins LLP; Lloyd's TSB Bank plc; James A. Macdonald Foundation; Ann M. Martin Foundation; Mellon Bank, N.A.; The Philip D. & Tammy S. Murphy Foundation; The New York Times Company Foundation; Newman's Own; Noggin; Tony Randall Theatrical Fund; Jonathan Rose Companies, Inc.; St. Vincent De Paul Foundation; Sesame Workshop; Shapiro & Lobel; Shearman & Sterling, LLP; Jane & Tad Shepard Family Foundation; The Shubert Organization; Stranahan Foundation; John A. Vassilaros & Son, Inc; Law Offices of Claudia Wagner; The Wiener Family Foundation; Yorke Construction Corporation. In addition, the following individuals made gifts of over \$200 to The 52nd Street Project this past year (list is current as of 7/19/07):

Anonymous	Peter Jay Fernandez & Denise Burse	John Lyons
Raymond & Elizabeth Abbott	Tom Fetterman & Bonnie Mac Savery	Grace Lyu-Volckhausen
Robert Abrams & Cynthia Vance	Alison Fraser & Nat Magee	Marsue & Peter MacNicol
Jace Alexander & Maddie Coman	Katherine Freedman	Greg MacPherson & Jane Perlmutter
James Auron	Louis & Patrice Friedman	Jane Perlmutter
Dylan & Becky Baker	Hank Gallo	Roma Maffia
Ben Barenholtz	Emily Armstrong & Thomas Gannon	Laurie Manifold
Patrick Barnes	Beverly Gasner	Drew McCoy & Amy Aquino
Andy Bart & Paige Bart	Rose Gasner & Larry Chertoff	Paul McCrane & Dana Kellin
Jessica Bauman	Cora Cahan & Bernard Gersten	Frances McDormand & Joel Coen
Laurie Becker	Paul & Liz Giamatti	Josie Merck & Jim Stevenson
Liz Bell	Nancy Giles	Noël & Joe Mihalow
Michael Bell & Carol Bell	Jessalyn Glisig	Bob & Adriana Mnuchin
Lisa Benavides & Tim Nelson	Stephen & Cathy Graham	Erin Moriarty
Gavin Berger & Craig Berggren	Connie Grappo & Lee Wilkof	Meg Mortimer & David Lloyd
Stephanie Berger & Paul King	Fred Graver & Betsy Graver	David & Sheri Mount
Elizabeth & Alexander Velazquez Bernstein	Joy Greenhouse	Suzen Murakoshi & Mark Temme
Richard Blackstone & Yldeez Yuksek	Lisa Gugenheim & Larry Nathanson	Patricia M. Murphy, Esq. & Adam Spilka
Tessa Blake & Ian Williams	William Henning	Stanley & Carol Nelson
Buzz Bovshow	Joy & Harry Henshel	Fred Nelson
Douglas & Samara Braunstein	Peter Hardrich & Karen Trott	Randy & Rona Nelson
Becky Browder & Ted Neustadt	Hippeau & Barbara Hippeau	James Neuburger & Helen Stambler
Bill Camp	Lawrence Hirsh	Lori O'Conner & Suzanne Poulin
Constance Casey	William Holtzman & S. Sylvia Shepard	Kevin O'Rourke & Edith Thurber
Alfred C. Cerullo III	Katy Homans & Patterson Sims	Carol Ochs & Bruce MacVittie
Kirk & Katherine Holt Citron	Sarah Horowitz & David Venarde	Jacki Ochs & Jan Kroeze
David Cohen & Sandra Novak Cohen	Charles Huntley	Sascha Paladino & Erin Torneo
Ruth Cohen & Bob Usdin	Whitney Scott & Peter Jacobson	F. Richard Pappas
Geoffrey & Ann Coley	Steven & Miriam Jacobson	Bat-Sheva & Thomas Peters
Penny Collins	Marc & Tracy Jaffe	Ana Rosa & Peter Phillips
Jeffrey & Anna Cramer	Andrea Johnson	Jeremy & Paulette Posner
John Cunningham	Larry & Mary Jones	Peter & Helen Randolph
Mary D'Elia	Douglas & Katie Jordan	Willie Reale & Jenny Gersten
Cathy Dantchik	Marcy & Max Kahn	Jacquelyn Reingold
Leslie Dantchik	Cindy Kaplan & David Froelich	Jeffrey Rogers
Jill Davis & Edward Conard	Mark Keoppen & Wendy Townsend	David & Anita Rogerson
Peter & Judith Dawkins	Judy Kuhn & David Schwab	David Rosenberg
Kendra Decious & Curt Child	Roger & Belle Kuhn	Russel & Debra Rosenthal
Neil DeSena & Carolyn DeSena	Whitney Dow & Liza Lerner	Ida Roth
Oliver & Christina Dobb	Mark Linn-Baker & Adrienne Lobel	Martha Roth & Bill Irwin
Whitney Dow & Thomasine Dolan Dow	John Bedford Lloyd & Anne Twomey	Erica Heilman
Richard & Rebecca Dresser	Michael & Marjorie Loeb	Alan & Joan Safir
Greg Durkin & Vanessa Beecroft	Mark Lanow & Joanne Astrow	Laura Sametz & Anton Fig
Beth Emelson	Edith Lutnick	Robert Sandberg
Michael Engerl & Steve Sumser		Marcia Santoni & John Morris
Wendy Ettinger & Derek McLane		Karin & Tom Schall
Andrew & Sandi Farkas		Robert Schnur
		Lauren Seikaly & Michael Huber

Tom Shadyac
Robert Shaffron & John Davis
Aaron & Elaine Shapiro
Pam Shaw & Victor Szymis
Meg Simon
Paul Logan
Dimriti & Helen Sogoloff
Jean Stein
Michael & Marjorie Stern
R.L. & Jane Stine
Michael Stone
Alexandra Styron & Ed Beason
Richard Sweren
Jay & Rachel Tarses
Anne Torsiglieri & Michael Bernard
Adriana & Tim Stephenson
Liz Tuccillo
John Turturro & Katherine Borowitz
Amanda Uprichard
Laura Valeroso & David Seidman
Josephine Eke & Jason Valk
Katrina vanden Heuvel
Wendy vanden Heuvel & Brad Coley
John A. Vassilaros & Alexandra Gersten-Vassilaros
Gonzalo Vicente
Mary Pat Walsh
Lynn & Sam Waterston
Sally & Lenny Weiss
Steve & Rita Weisskoff
Jane Bolster & Steve Wertimer
Joe White & Iris Brown
Margaret Whitton & Warren Spector
Jenny Wiener & Jon Steingart
Michael & Zena Wiener
Elizabeth Williams & Joseph Forte
Frank Wood
Joanne Woodward & Paul Newman
Bill Wrubel & Jennifer Crittenden
George Xenos
Jeffrey & Janine Yass
Luchia Yocabucci

# RAIN OR SHINE

## The All-Weather Plays



THE  
2007  
HAROLD  
AND  
MIMI  
STEINBERG  
CHARITABLE  
TRUST  
ONE-  
ON-  
ONES



JULY 20-22, 2007

**THE ENSEMBLE STUDIO THEATRE**  
549 WEST 52ND ST.  
NEW YORK CITY

**RAIN OR SHINE:**  
**THE ALL- WEATHER PLAYS**  
**THE BLOCK ISLAND ONE-ON-ONES**  
**JULY 20-22 - THE ENSEMBLE STUDIO THEATRE**

**The 52nd Street Project Staff:**

Gus Rogerson, Artistic Director  
 Carol Ochs, Executive Director  
 John Sheehy, Director of Development and Marketing  
 George "G-Force" Babiak, Production Manager  
 Reg Flowers, Associate Artistic Director  
 Liz Bell, Director of Education  
 Megan Cramer, Program Director  
 Diana Rojas, Executive Assistant  
 Josh Moody, Development Assistant  
 Chris Ceraso, Teen Dean  
 Iris A. Brown, Graphic Designer  
 Solangee Acosta, Johanna Vidal, Kayelani Silva, Receptionists  
 Jonathan Dent, Brigid Gannon, Lily Howard, Interns

**Production Staff:**

**Composer:** Lily Howard, Ethan Maldonado, Kim Sherman, Josh Moody, Luisa Santiago, Kim Sherman, John Sheehy

**Set Designer:** Kevin Joseph Roach

**Lighting Designer:** Jonathan Dent, Stephen Galimidi, Greg MacPherson, Alex Tomas

**Costume Designers:** Nicole Fargardo, Brigid Gannon, Lily Wells, Howard

**Goddess of Sound:** Vanessa Valdes

**Stage Manager:** Doug Nervik, Matt Sincell  
Charles M. Turner III

**Slide Designs:** Liz Bell, Karin Schall  
Tracy Rosiene, George Babiak, and the Project Slide Archive

**Prop Design Team:** Pat Ritter and Martha Velie-Gass  
Doris Alcantara, George Babiak, Stephen Galimidi, Jonathan Dent, Brigid Gannon,

**COOL STUFF ON SALE IN THE LOBBY!**

The Fabulous Flyer Bar ..\$2.50, \$2, \$1.50 & \$1  
*and featuring Shel Silverstein's "Fivey and Twoey" logo:*  
 Project T-shirts (New Design) .....\$12.00  
 Project Tank Tops (New Design) .....\$12.00  
 Project Caps .....\$20.00  
 Project Mugs .....\$5.00  
 Project Pencil 3-pack .....\$1.00  
 Project Notebook .....\$5.00

Thank you for coming to **RAIN OR SHINE**. If you are not on our mailing list (or if your address has changed), please fill out this form and give it to us on your way out or mail it to the address below. We would also like to know if you are interested in becoming a volunteer. We need help in **all areas**, so be sure to fill out the entire form.

**PLEASE ADD ME TO YOUR MAILING LIST:**

7/07

NAME: \_\_\_\_\_

ADDRESS: \_\_\_\_\_

ZIP \_\_\_\_\_

HOME PHONE: \_\_\_\_\_

DAYTIME PHONE: \_\_\_\_\_

E-MAIL ADDRESS: \_\_\_\_\_

MY OCCUPATION: \_\_\_\_\_

MY HOBBIES: \_\_\_\_\_

**YES, I WOULD LIKE TO BE OF HELP. I CAN:**

- |   |   |  |
|---|---|--|
| <input type="checkbox"/> Help load in and out for shows | <input type="checkbox"/> Draw and/or paint  | <input type="checkbox"/> Help kids with homework |
| <input type="checkbox"/> Hang lights                    | <input type="checkbox"/> Help with mailings | <input type="checkbox"/> Teach kids a skill      |
| <input type="checkbox"/> Work on a backstage crew       | <input type="checkbox"/> Do office work     | <input type="checkbox"/> Be a chef at an event   |
| <input type="checkbox"/> Do graphic design              | <input type="checkbox"/> Design sound       | <input type="checkbox"/> Design and sew costumes |
| <input type="checkbox"/> Other (please specify) _____   |   |  |

**MY SCHEDULE IS:**

- Very flexible. I'm often available during weekdays.  
 Somewhat flexible. I can help on the occasional morning or afternoon during the week.  
 Not very flexible at all, but I've got some free time on evenings and weekends.

If you would like to mail this (and you're always welcome to enclose a tax-deductible contribution), you can send it to: **The 52nd Street Project**, 500 West 52nd St., New York, NY 10019. Or fax it to (212) 333-5598.

The One-on-One Program is made possible with public funds from The New York State Council on the Arts, a state agency; and the New York City Department of Cultural Affairs. The 52nd Street Project is supported by funds from the National Endowment for the Arts. The Project is a member of ART/NY.



## Don't Miss Our Upcoming Shows!

### RAIN OR SHINE The All-Weather Plays



**10  
NEW KIDS!  
10  
NEW ADULTS!  
10  
NEW PLAYS!  
SAME  
GREAT THEME!**

**AUG. 17-19**

RIGHT HERE AT THE  
ENSEMBLE STUDIO  
THEATRE

## NEW PLAYBACK

**October, 2007**

Come experience the NEW version of Playback: The children are still partnered with adults, but this time the children write the plays for the two of them to perform. It's like the One-on-Ones, but all kid-written.



**December, 2007**

In September, 10 kids brand-new to the Project will begin a Playmaking class taught by Project Playmaking Director Reg Flowers. Come and see their final plays performed by adult professional actors.

The 52nd Street Project is a non-profit organization that brings children from the Hell's Kitchen neighborhood together with professional theater artists to create original theater. **RAIN OR SHINE** is a production of our One-on-One program, which is designed to give children the opportunity to go away for one-week stays in the country and enjoy the undivided attention of a professional theater artist who serves as friend, mentor, and collaborator. The Project is delighted to return to the Ensemble Studio Theatre, where we have been performing since our inception in 1981. We gratefully acknowledge the fact that if E.S.T. wasn't here, we'd be nowhere.

### The 52nd Street Project Board of Directors

Ben Barenholtz

Lisa Benavides

Rachel Chanoff

Cathy Dantchik

Wendy Ettinger, *chair emeritus*

Louis P. Friedman

Stephen Graham, *chair*

Larry Jones

James McDaniel

Frances McDormand

Noël Mihalow

Carol Ochs

Willie Reale, *founder*

Gus Rogerson

Shirley Rumierk, *alumni member*

José Soto, Jr., *alumni member*

Pamala Tyson

Wendy vanden Heuvel

John A. Vassilaros

Jenny Wiener

### Special Thanks

Our Host Families – Roberta & Alan Alpert; Sue Black; The Homans Family; Josie Merck & Jim Stevenson; Jane Scranton; Jennifer & Elliot Taubman; Ron & Judy Tierney; Martha Velie-Gass & Pat Ritter; Joya Verde & Virginia Dare; and our headquarters host Dr. Christina Biaggi. Sincere thanks to our chefs Pat Ritter & Martha Velie-Gass; Lynn Reale, Kate Butcher & everyone at Block Island Realty; Block Island Maritime Institute; Robbie Brown; Rita & Steve Draper; Amelia Gallant at the Block Island Grocery; Cindy & Stan Geer at the Depot; Glenn & Annie Hall; Interstate Navigation; MacLac Enterprise; Ed McGovern at Winfields; Bill Padien at The Bagel Shop and Bruce MacVittie.

### In-Kind Contributions

The Murphy Law Office; Benefit Cosmetics; Iris A. Brown; Comptoir Sud Pacifique; Ron Kastner and Capital Printing; Kenneth Cole Productions; D'Agostino's; ICI; Noggin; Entertainment Weekly; Newman's Own; Pharma Print/Omni Graphics; Sesame Workshop; Wendy Stuhlberg; John A. Vassilaros; Watkins, Inc.; Mayor's Office of Film & Television; Boylan's Bottling Co.; Lorraine Tobias & Imaginary Studios; Warner Chappell Music Group, Shapiro & Lobel; Simon Spotlight Entertainment, an imprint of Simon and Schuster; Hudson Scenic; Noggin/The N; Prime Films, Mario Badescu; Dlageo Chateau & Estate Wines Co.; Showman Fabricators; Frédéric Fekkai & Co., LLC and Paul, Weiss, Rifkind, Wharton & Garrison LLP, and Shapiro & Lobel.

## RAIN OR SHINE - ACT I

All original music composed by Kim Sherman  
*Rain or Shine Theme Song* lyrics by John Sheehy

### MYTH DIRECTION

Written and directed by John Sheehy for Laron Holt, age 11

Prometheus .....John Sheehy  
Hercules .....Laron Holt

*Such a Thing as Mercy* lyrics by John Sheehy

### SO-O IRRITATING

Written and directed by Diana Rojas for Jamie Yip, age 11

Elaine .....Jamie Yip  
Jesse .....Diana Rojas

*The Itching Song* lyrics by Gus Rogerson

### WHETHER THE WEATHER

Written by Carlo Alban and directed by Matt Sincell  
for Carlos (C.J.) Muentes, age 12

Newscaster .....Tim Cain  
Dom .....Matt Sincell  
Julian .....Carlos (C.J.) Muentes

*Weather The Weather Together* lyrics by Carlo Alban

### PLAINS JANES

Written by Reg Flowers and directed by Nana Mensah  
for Breanna Straker, age 11

Savana .....Breanna Straker  
Baretta .....Nana Mensah

*Janes Of The Plain* lyrics by Reg Flowers

### GIMME SOME SPACE

Written by Michael Bernard and directed by Tim Cain  
for Andy Reyes, age 11

Buzz .....Tim Cain  
Manly .....Andy Reyes  
Computer Voice .....Vanessa Valdes

*The Launch Song* and *I Hate You Less* lyrics by Michael Bernard

## RAIN OR SHINE - ACT II

### TRUTH OVER LUNCH

Written by Willie Reale and directed by Ed Vassallo  
for Hashem Hamed, age 10

Don .....Hashem Hamed  
Artie .....Ed Vassallo  
Waiter .....Stephen Galimidi  
Chef .....Alex Tomas

*Stick With The Truth* lyrics by Willie Reale

### OH, I DON'T THINK SO

Written by Liz Tuccillo and directed by Lauren Blumenfeld  
for Luisa Santiago, age 11

Marci Mild .....Luisa Santiago  
Naomi Handfull .....Lauren Blumenfeld

*People Who Yell* and *Being Kind of Happy* lyrics by Liz Tuccillo

### CITIZEN DOG

Written and directed by Liz Flahive for John Cacomanolis, age 12

Angela Newman .....Liz Flahive  
Spot .....John Cacomanolis  
Female Newscaster .....Brigid Gannon  
Older Guy .....George Babiak  
Announcer .....Tim Cain

*Anything To Win* lyrics by Liz Flahive

### A HARD SNOW'S A-GONNA FALL

Written and directed by Josh Moody for Ethan Maldonado, age 12

James .....Josh Moody  
Ben .....Ethan Maldonado

*Brothers Are Totally, Like, Totally Lame* lyrics by Josh Moody

### THE RAINMAKER

Written by Adam Felber and directed by Claudia Zelevansky  
for Doris Alcantara, age 10

Stella .....Claudia Zelevansky  
Angelique .....Doris Alcantara  
Pops .....Reg Flowers  
Sammy .....George Babiak  
Angry Mob .....The Crew

*It's Raining Rain* lyrics by Adam Felber

I  
N  
T  
E  
R  
M  
I  
S  
I  
O  
N



The 52nd Street Project gratefully acknowledges the support of the following foundations and corporations: Alexandra Productions, Inc.; APA; BKSK Architects LLP; Bloomberg; The Brenner Family Foundation; Carnegie Corporation of New York; CBL Center; CBS Corporation; Citigroup Foundation; Comedy Central; Consolidated Edison; Downtown Arts Development, Inc.; The Dramatists Guild Fund; Dramatists Play Service; The Horace W. Goldsmith Foundation; The William & Mary Greve Foundation; Holland Lodge Foundation, Inc.; The Saul Horowitz Jr. Fund; HBO; Hudson Scenic Studio; Hurlbut Family Charitable Lead Trust; Kekst & Company; Latham & Watkins LLP; Lloyd's TSB Bank plc; James A. Macdonald Foundation; Ann M. Martin Foundation; Mellon Bank, N.A.; The Philip D. & Tammy S. Murphy Foundation; New York City Department of Cultural Affairs; The New York Times Company Foundation; Newman's Own; Noggin; Tony Randall Theatrical Fund; Jonathan Rose Companies, Inc.; St. Vincent De Paul Foundation; Sesame Workshop; Shapiro & Lobel; Shearman & Sterling, LLP; Jane & Tad Shepard Family Foundation; The Shubert Organization; Stranahan Foundation; John A. Vassilaros & Son, Inc; Law Offices of Claudia Wagner; The Wiener Family Foundation; Yorke Construction Corporation. In addition, the following individuals made gifts of over \$200 to The 52nd Street Project this past year (list is current as of 7/19/07):

Anonymous  
Raymond & Elizabeth Abbott  
Robert Abrams & Cynthia Vance  
Jace Alexander & Maddie Coman  
James Auron  
Dylan & Becky Baker  
Ben Barenholtz  
Patrick Barnes  
Andy Bart & Paige Bart  
Jessica Bauman  
Laurie Becker  
Liz Bell  
Michael Bell & Carol Bell  
Lisa Benavides & Tim Nelson  
Gavin Berger & Craig Berggren  
Stephanie Berger & Paul King  
Elizabeth &  
Alexander Velazquez Bernstein  
Richard Blackstone & Yldeez Yuksek  
Tessa Blake & Ian Williams  
Buzz Bovshow  
Douglas & Samara Braunstein  
Becky Browder & Ted Neustadt  
Bill Camp  
Constance Casey  
Alfred C. Cerullo III  
Kirk & Katherine Holt Citron  
David Cohen &  
Sandra Novak Cohen  
Ruth Cohen & Bob Usdin  
Geoffrey & Ann Coley  
Penny Collins  
Jeffrey & Anna Cramer  
John Cunningham  
Mary D'Elia  
Cathy Dantchik  
Leslie Dantchik  
Jill Davis & Edward Conard  
Peter & Judith Dawkins  
Kendra Decious & Curt Child  
Neil DeSena & Carolyn DeSena  
Oliver & Christina Dobbis  
Whitney Dow &  
Thomasine Dolan Dow  
Richard & Rebecca Dresser  
Greg Durkin & Vanessa Beecroft  
Beth Emelson  
Michael Engerl & Steve Sumser  
Wendy Ettinger & Derek McLane  
Andrew & Sandi Farkas

Peter Jay Fernandez &  
Denise Burse  
Tom Fetterman &  
Bonnie Mac Savery  
Alison Fraser & Nat Magee  
Katherine Freedman  
Louis & Patrice Friedman  
Hank Gallo  
Emily Armstrong &  
Thomas Gannon  
Beverly Gasner  
Rose Gasner & Larry Chertoff  
Cora Cahlan & Bernard Gersten  
Paul & Liz Giamatti  
Nancy Giles  
Jessalyn Glisig  
Stephen & Cathy Graham  
Connie Grappo & Lee Wilkof  
Fred Graver & Betsy Graver  
Joy Greenhouse  
Lisa Gugenheim & Larry Nathanson  
William Henning  
Joy & Harry Henshel  
Peter Hardrich & Karen Trott  
Hippeau & Barbara Hippeau  
Lawrence Hirsh  
William Holtzman &  
S. Sylvia Shepard  
Katy Homans & Patterson Sims  
Sarah Horowitz & David Venarde  
Charles Huntley  
Whitney Scott & Peter Jacobson  
Steven & Miriam Jacobson  
Marc & Tracy Jaffe  
Andrea Johnson  
Larry & Mary Jones  
Douglas & Katie Jordan  
Marcy & Max Kahn  
Cindy Kaplan & David Froelich  
Mark Keoppen & Wendy Townsend  
Judy Kuhn & David Schwab  
Roger & Belle Kuhn  
Warren Leight  
Liza Lerner  
Mark Linn-Baker & Adrienne Lobel  
John Bedford Lloyd &  
Anne Twomey  
Michael & Marjorie Loeb  
Mark Lanow & Joanne Astrow  
Edith Lutnick

John Lyons  
Grace Lyu-Volckhausen  
Marsue & Peter MacNicol  
Greg MacPherson &  
Jane Perlmutter  
Roma Maffia  
Laurie Manifold  
Drew McCoy & Amy Aquino  
Paul McCrane & Dana Kellin  
Frances McDormand & Joel Coen  
Josie Merck & Jim Stevenson  
Noël & Joe Mihalow  
Bob & Adriana Mnuchin  
Erin Moriarty  
Meg Mortimer & David Lloyd  
David & Sheri Mount  
Suzen Murakoshi & Mark Temme  
Patricia M. Murphy, Esq. &  
Adam Spilka  
Stanley & Carol Nelson  
Fred Nelson  
Randy & Rona Nelson  
James Neuburger &  
Helen Stambler  
Lori O'Conner & Suzanne Poulin  
Kevin O'Rourke & Edith Thurber  
Carol Ochs & Bruce MacVittie  
Jacki Ochs & Jan Kroeze  
Sascha Paladino & Erin Torneo  
F. Richard Pappas  
Bat-Sheva & Thomas Peters  
Ana Rosa & Peter Phillips  
Jeremy & Paulette Posner  
Peter & Helen Randolph  
Willie Reale & Jenny Gersten  
Jacquelyn Reingold  
Jeffrey Rogers  
David & Anita Rogerson  
David Rosenberg  
Russel & Debra Rosenthal  
Ida Roth  
Martha Roth & Bill Irwin  
Erica Heilman  
Alan & Joan Safir  
Laura Sametz & Anton Fig  
Robert Sandberg  
Marcia Santoni & John Morris  
Karin & Tom Schall  
Robert Schnur  
Lauren Seikaly & Michael Huber

Tom Shadyac  
Robert Shaffron & John Davis  
Aaron & Elaine Shapiro  
Pam Shaw & Victor Symis  
Meg Simon  
Paul Logan  
Dimitri & Helen Sogoloff  
Jean Stein  
Michael & Marjorie Stern  
R.L. & Jane Stine  
Michael Stone  
Alexandra Styron & Ed Beason  
Richard Sweren  
Jay & Rachel Tarses  
Anne Torsiglieri & Michael Bernard  
Adriana & Tim Stephenson  
Liz Tuccillo  
John Turturro & Katherine Borowitz  
Amanda Uprichard  
Laura Valeroso & David Seidman  
Josephine Eke & Jason Valk  
Katrina vanden Heuvel  
Wendy vanden Heuvel &  
Brad Coley  
John A. Vassilaros &  
Alexandra Gersten-Vassilaros  
Gonzalo Vicente  
Mary Pat Walsh  
Lynn & Sam Waterston  
Sally & Lenny Weiss  
Steve & Rita Weisskoff  
Jane Bolster & Steve Wertimer  
Joe White & Iris Brown  
Margaret Whitton & Warren Spector  
Jenny Wiener & Jon Steingart  
Michael & Zena Wiener  
Elizabeth Williams &  
Joseph Forte  
Frank Wood  
Joanne Woodward & Paul Newman  
Bill Wrubel & Jennifer Crittenden  
George Xenos  
Jeffrey & Janine Yass  
Luchia Yocabucci

# The 52nd Street Project Presents

## RAIN OR SHINE The All-Weather Plays

2ND SERIES  
OF THE SUMMER!

The  
WAREHAM  
MASS.  
Batch

1  
ON  
1

THE  
2007  
WIENER  
FAMILY  
FOUNDATION  
ONE-  
ON-  
ONES

10  
ADULTS  
10  
KIDS  
10  
PLAYS

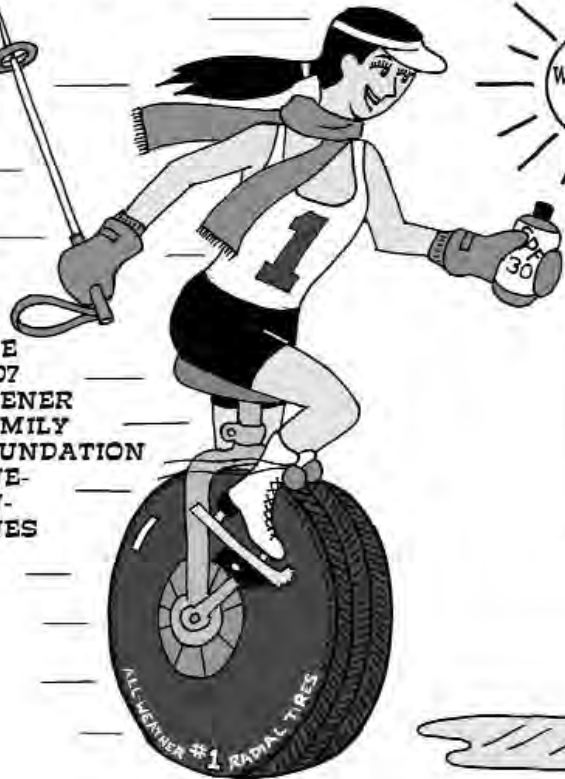

August 17-19, 2007

The Ensemble Studio Theatre

549 West 52nd St.

New York City

**RAIN OR SHINE: THE ALL-WEATHER PLAYS**  
**The Wareham, Mass. One-on-Ones**  
**August 17-19 - The Ensemble Studio Theatre**

**The 52nd Street Project Staff:**

Gus Rogerson, Artistic Director  
 Carol Ochs, Executive Director  
 John Sheehy, Director of Development and Marketing  
 George "G-Shock" Babiak, Production Manager  
 Reg Flowers, Associate Artistic Director  
 Liz Bell, Director of Education  
 Megan Cramer, Program Director  
 Diana Rojas, Executive Assistant  
 Josh Moody, Development Assistant  
 Chris Ceraso, Teen Dean  
 Iris A. Brown, Graphic Designer  
 Solangee Acosta, Johanna Vidal, Kayelani Silva, Receptionists  
 Jonathan Dent, Brigid Gannon, Lily Howard, Interns

**Production Staff:**

**Composer:**

Patrick Barnes

**Set Designer:**

Kevin Joseph Roach

**Lighting Designer:**

Greg MacPherson

**Costume Designer:**

Katherine Brown

**Sound Designer:**

Drew Vandenburg

**Stage Manager:**

Karen Munkel

**Prop Design Team:**

George Babiak, Megan Cramer, Brigid Gannon, Lily Howard, Patrick Jones, Josh Moody, Karen Munkel, and John Sheehy

**Slide Designs:**

George Babiak, Liz Bell, Megan Cramer, and the Project Slide Archive

**Stage Crew:**

Jonathan Dent, Brigid Gannon, Lily Howard, Terrence Mack, Johanna Vidal, Alicia Violan

**House Managers:**

Liz Bell, Karin Schall, and Mary Pat Walsh

**Chefs:**

Liz Bell, Carol Ochs, and John Sheehy

**Teen Counselors:**

Kayelani Silva and Johanna Vidal

The One-on-One Program is made possible with public funds from The New York State Council on the Arts, a state agency; and the New York City Department of Cultural Affairs. The 52nd Street Project is supported by funds from the National Endowment for the Arts. The Project is a member of ART/NY.



**COOL STUFF ON SALE IN THE LOBBY!**

The Fabulous Flyer Bar . . .\$2.50, \$2, \$1.50 & \$1  
*and featuring Shel Silverstein's "Fivey and Twoey" logo:*  
 Project T-shirts (New Design) . . . . . \$12.00  
 Project Tank Tops (New Design) . . . . . \$12.00  
 Project Caps . . . . . \$20.00  
 Project Mugs . . . . . \$5.00  
 Project Pencil 3-pack . . . . . \$1.00  
 Project Notebook . . . . . \$5.00

Thank you for coming to **RAIN OR SHINE**. If you are not on our mailing list (or if your address has changed), please fill out this form and give it to us on your way out or mail it to the address below. We would also like to know if you are interested in becoming a volunteer. We need help in **all areas**, so be sure to fill out the entire form.

**PLEASE ADD ME TO YOUR MAILING LIST:**

8/07

NAME: \_\_\_\_\_

ADDRESS: \_\_\_\_\_

\_\_\_\_\_ ZIP \_\_\_\_\_

HOME PHONE: \_\_\_\_\_

DAYTIME PHONE: \_\_\_\_\_

E-MAIL ADDRESS: \_\_\_\_\_

MY OCCUPATION: \_\_\_\_\_

MY HOBBIES: \_\_\_\_\_

**YES, I WOULD LIKE TO BE OF HELP. I CAN:**

- |   |   |  |
|---|---|--|
| <input type="checkbox"/> Help load in and out for shows | <input type="checkbox"/> Draw and/or paint  | <input type="checkbox"/> Help kids with homework |
| <input type="checkbox"/> Hang lights                    | <input type="checkbox"/> Help with mailings | <input type="checkbox"/> Teach kids a skill      |
| <input type="checkbox"/> Work on a backstage crew       | <input type="checkbox"/> Do office work     | <input type="checkbox"/> Be a chef at an event   |
| <input type="checkbox"/> Do graphic design              | <input type="checkbox"/> Design sound       | <input type="checkbox"/> Design and sew costumes |
| <input type="checkbox"/> Other (please specify) _____   |   |  |

**MY SCHEDULE IS:**

- Very flexible. I'm often available during weekdays.  
 Somewhat flexible. I can help on the occasional morning or afternoon during the week.  
 Not very flexible at all, but I've got some free time on evenings and weekends.

If you would like to mail this (and you're always welcome to enclose a tax-deductible contribution), you can send it to: **The 52nd Street Project**, 500 West 52nd St., New York, NY 10019. Or fax it to (212) 333-5598.

## Don't Miss Our Upcoming Shows!



### PLAYBACK 2007

October 19-21

Julia Miles Theater  
242 W. 55th Street  
(between 9th &  
10th Aves)

Come experience the NEW version of Playback: The children are still partnered with adults, but this time the children write the plays for the two of them to perform. It's like the One-on-Ones, but all kid-written.

## Don't Tread On Me! The Revolutionary Plays

The Fall 2007  
Playmaking Shows

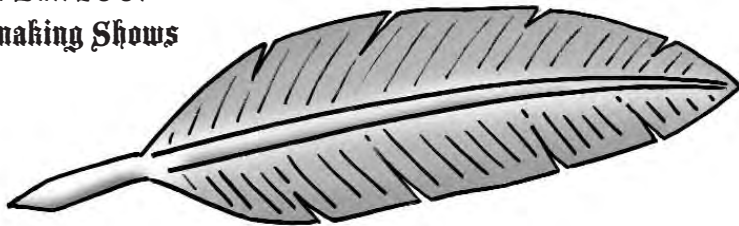

December 7-9, 2007

In September, 10 kids brand-new to the Project will begin a Playmaking class taught by Project Playmaking Director Reg Flowers. Come and see their final plays performed by adult professional actors.

The 52nd Street Project is a non-profit organization that brings children from the Hell's Kitchen neighborhood together with professional theater artists to create original theater. **RAIN OR SHINE** is a production of our One-on-One program, which is designed to give children the opportunity to go away for one-week stays in the country and enjoy the undivided attention of a professional theater artist who serves as friend, mentor, and collaborator. The Project is delighted to return to the Ensemble Studio Theatre, where we have been performing since our inception in 1981. We gratefully acknowledge the fact that if E.S.T. wasn't here, we'd be nowhere.

### The 52nd Street Project Board of Directors

Ben Barenholtz

Lisa Benavides

Rachel Chanoff

Cathy Dantchik

Wendy Ettinger, *chair emeritus*

Louis P. Friedman

Stephen Graham, *chair*

Larry Jones

James McDaniel

Frances McDormand

Noël Mihalow

Carol Ochs

Willie Reale, *founder*

Gus Rogerson

Shirley Rumierk, *alumni member*

José Soto, Jr., *alumni member*

Pamala Tyson

Wendy vanden Heuvel

John A. Vassilaros

Jenny Wiener

### Special Thanks

We're particularly grateful to the host families, the kind people of Wareham, Mass. who put up our kids and adults during the week we spent there. They are Kitty Benton; Wendy & Kevin Brogioli; Emily & John Morgan; Sidney Worthen & David Pearce; Gray & Rose Watson; Joe McNay & the entire McNay family; Peter, Helen & Christopher Randolph.

Sincere thanks also go to Robin Morse, Lucy & Francis Rogerson; Socrates Cruz; Bob Krystolfolski; The Wareham Gatemen, and the TDF Costume Collection.

### In-Kind Contributions

The Murphy Law Office; Benefit Cosmetics; Iris A. Brown; Comptoir Sud Pacifique, Ron Kastner and Capital Printing; Kenneth Cole Productions; D'Agostino's; ICI; Noggin; Entertainment Weekly; Newman's Own; Pharma Print/Omni Graphics; Sesame Workshop; Wendy Stuhlberg; John A. Vassilaros; Watkins, Inc.; Mayor's Office of Film & Television; Boylan's Bottling Co.; Lorraine Tobias & Imaginary Studios; Warner Chappell Music Group, Shapiro & Lobel; Simon Spotlight Entertainment, an imprint of Simon and Schuster; Hudson Scenic; Noggin/The N; Prime Films, Mario Badescu; Dlageo Chateau & Estate Wines Co.; Showman Fabricators; Frédéric Fekkai & Co., LLC and Paul, Weiss, Rifkind, Wharton & Garrison LLP, Shapiro & Lobel, and Whole Foods.

## Rain or Shine - Act I

All original music composed by Patrick Barnes  
*Rain or Shine Theme Song* lyrics by John Sheehy

### MAD SCIENTISTS

Written & Directed by Christopher Randolph  
for Emmett Goodman-Boyd, age 12

Dr. Alan Frisbee .....Emmett Goodman-Boyd  
Dr. Norman Nerf .....Christopher Randolph

*“Get Mad”* lyrics by Christopher Randolph

### GILDA GAINES, GIRL DETECTIVE

Written & Directed by Beatrice Terry for Kimberly Zenteno, age 11

Gilda Gaines .....Kimberly Zenteno  
Birdie Sawyer .....Beatrice Terry  
Officer .....Jonathan Dent

*“Private Eye”* lyrics by Beatrice Terry

### IN THE GARDEN

Written by Kate Ryan & Directed by Marsha Stephanie Blake  
for Mari Ulloa, age 10

Dahlia .....Mari Ulloa  
Caterpillar/Butterfly .....Marsha Stephanie Blake

*“What Is Unusual”* & *“Song For Dahlia”* lyrics by Kate Ryan

### THE WRONG BUS

Written & Directed by Reg Flowers for Jazmine Mikel, age 10

Bus Driver .....Jazmine Mikel  
Passenger .....Reg Flowers

*“The Fright Song”* lyrics by Reg Flowers

### WRESTLING WITH INTEREST

Written & Directed by Megan Cramer for Armando Cosme, Jr., age 11

Norman Rates .....Armando Cosme, Jr.  
Accura Balance .....Megan Cramer  
Winnie Williams/Bertha Borloff .....Kayelani Silva  
Willie Williams/Boris Borloff .....Jonathan Dent  
Announcer .....Howard W. Overshown

*“We’re Accountants”* & *“Get In The Ring And Fight”* lyrics by Megan Cramer

## Rain or Shine - Act II

### THE SPECTER DETECTORS

Written & Directed by George Babiak for Marlowe Mendez, age 11

Arlene Parker .....Marlowe Mendez  
Charlie Carson .....George Babiak  
J. Wellington Piccadilly .....John Sheehy  
The Ghost .....Lily Howard

*“Our World’s Been Rocked”* lyrics by George Babiak

### THE GREAT DISCOVERY

Written by Cindy Lou Johnson & Directed by Adriana Gaviria  
for Aleyni Aguilar, age 11

Cherisse .....Aleyni Aguilar  
Trixie .....Adriana Gaviria

*“One Little Step”* lyrics by Cindy Lou Johnson

### CYRANO: THE BLUES ARE BACK

Written by Bruce MacVittie & Directed by Patrick Jones  
for Tino Paduani, age 11

Cyrano de Bergerac .....Tino Paduani  
Christian .....Patrick Jones  
Roxanne .....Johanna Vidal  
Reverend Mother .....Lily Howard

*“Grow To Love Me,” “How Did It Happen,”* & *“I Will Always Love You”*  
lyrics by Bruce MacVittie

### OUT TO SEA

Written & Directed by Tonya Canada for Samantha Caldona, age 11

Kiwi .....Samantha Caldona  
Melly .....Tonya Canada  
The Postman .....Terrence Mack

*“The Retirement Song”* lyrics by Tonya Canada

### GOOD COP, BAD COP

Written by Craig Cox & Directed by Howard W. Overshown  
for Maximo Jimenez, age 12

Bad Cop .....Maximo Jimenez  
Good Cop .....Howard W. Overshown  
Suspect .....John Sheehy  
Officer .....Jonathan Dent

*“Good Cop, Bad Cop, Don’t Stop”* lyrics by Craig Cox

I  
N  
T  
E  
R  
M  
I  
S  
S  
I  
O  
N

The 52nd Street Project gratefully acknowledges the support of the following foundations and corporations: Alexandra Productions, Inc.; APA; BKS Architects LLP; Bloomberg; The Brenner Family Foundation; Carnegie Corporation of New York; CBL Center; CBS Corporation; Citigroup Foundation; Comedy Central; Consolidated Edison; Downtown Arts Development, Inc.; The Dramatists Guild Fund; Dramatists Play Service; The Horace W. Goldsmith Foundation; The William & Mary Greve Foundation; Holland Lodge Foundation, Inc.; The Saul Horowitz Jr. Fund; HBO; Hudson Scenic Studio; Hurlbut Family Charitable Lead Trust; Kekst & Company; Latham & Watkins LLP; Lloyd's TSB Bank plc; James A. Macdonald Foundation; Ann M. Martin Foundation; Mellon Bank, N.A.; The Philip D. & Tammy S. Murphy Foundation; The New York Times Company Foundation; Newman's Own; Noggin; Tony Randall Theatrical Fund; Jonathan Rose Companies, Inc.; St. Vincent De Paul Foundation; Sesame Workshop; Shapiro & Lobel; Shearman & Sterling, LLP; Jane & Tad Shepard Family Foundation; The Shubert Organization; Stranahan Foundation; John A. Vassilaros & Son, Inc; Law Offices of Claudia Wagner; The Wiener Family Foundation; Yorke Construction Corporation. In addition, the following individuals made gifts of over \$200 to The 52nd Street Project this past year (list is current as of 7/19/07):

Anonymous	Peter Jay Fernandez &	John Lyons	Tom Shadyac
Raymond & Elizabeth Abbott	Denise Burse	Grace Lyu-Volckhausen	Robert Shaffron & John Davis
Robert Abrams & Cynthia Vance	Tom Fetterman &	Marsue & Peter MacNicol	Aaron & Elaine Shapiro
Jace Alexander & Maddie Coman	Bonnie Mac Saveny	Greg MacPherson &	Pam Shaw & Victor Symis
James Auron	Alison Fraser & Nat Magee	Jane Perlmutter	Meg Simon
Dylan & Becky Baker	Katherine Freedman	Roma Maffia	Paul Logan
Ben Barenholtz	Louis & Patrice Friedman	Laurie Manifold	Dimitri & Helen Sogoloff
Patrick Barnes	Hank Gallo	Drew McCoy & Amy Aquino	Jean Stein
Andy Bart & Paige Bart	Emily Armstrong &	Paul McCrane & Dana Kellin	Michael & Marjorie Stern
Jessica Bauman	Thomas Gannon	Frances McDormand & Joel Coen	R.L. & Jane Stine
Laurie Becker	Beverly Gasner	Josie Merck & Jim Stevenson	Michael Stone
Liz Bell	Rose Gasner & Larry Chertoff	Noël & Joe Mihalow	Alexandra Styron & Ed Beason
Michael Bell & Carol Bell	Cora Cahana & Bernard Gersten	Bob & Adriana Mnuchin	Richard Sweren
Lisa Benavides & Tim Nelson	Paul & Liz Giamatti	Erin Moriarty	Jay & Rachel Tarses
Gavin Berger & Craig Berggren	Nancy Giles	Meg Mortimer & David Lloyd	Anne Torsiglieri & Michael Bernard
Stephanie Berger & Paul King	Jessalyn Gilisg	David & Sheri Mount	Adriana & Tim Stephenson
Elizabeth &	Stephen & Cathy Graham	Suzen Murakoshi & Mark Temme	Liz Tuccillo
Alexander Velazquez Bernstein	Connie Grappo & Lee Wilkof	Patricia M. Murphy, Esq. &	John Turturro & Katherine Borowitz
Richard Blackstone & Yldeez Yuksek	Fred Graver & Betsy Graver	Adam Spilka	Amanda Uprichard
Tessa Blake & Ian Williams	Joy Greenhouse	Stanley & Carol Nelson	Laura Valeroso & David Seidman
Buzz Bovshow	Lisa Gugenheim & Larry Nathanson	Fred Nelson	Josephine Eke & Jason Valk
Douglas & Samara Braunstein	William Henning	Randy & Rona Nelson	Katrina vanden Heuvel
Becky Browder & Ted Neustadt	Joy & Harry Henshel	James Neuburger &	Wendy vanden Heuvel &
Bill Camp	Peter Herdrich & Karen Trott	Helen Stambler	Brad Coley
Constance Casey	Hippeau & Barbara Hippeau	Lori O'Conner & Suzanne Poulin	John A. Vassilaros &
Alfred C. Cerullo III	Lawrence Hirsh	Kevin O'Rourke & Edith Thurber	Alexandra Gersten-Vassilaros
Kirk & Katherine Holt Citron	William Holtzman &	Carol Ochs & Bruce MacVittie	Gonzalo Vicente
David Cohen &	S. Sylvia Shepard	Jacki Ochs & Jan Kroeze	Mary Pat Walsh
Sandra Novak Cohen	Katy Homans & Patterson Sims	Sascha Paladino & Erin Torneo	Lynn & Sam Waterston
Ruth Cohen & Bob Usdin	Sarah Horowitz & David Venarde	F. Richard Pappas	Sally & Lenny Weiss
Geoffrey & Ann Coley	Charles Huntley	Bat-Sheva & Thomas Peters	Steve & Rita Weisskoff
Penny Collins	Whitney Scott & Peter Jacobson	Ana Rosa & Peter Phillips	Jane Bolster & Steve Wertimer
Jeffrey & Anna Cramer	Steven & Miriam Jacobson	Jeremy & Paulette Posner	Joe White & Iris Brown
John Cunningham	Marc & Tracy Jaffe	Peter & Helen Randolph	Margaret Whitton & Warren Spector
Mary D'Elia	Andrea Johnson	Willie Reale & Jenny Gersten	Jenny Wiener & Jon Steingart
Cathy Dantchik	Larry & Mary Jones	Jacquelyn Reingold	Michael & Zena Wiener
Leslie Dantchik	Douglas & Katie Jordan	Jeffrey Rogers	Elizabeth Williams &
Jill Davis & Edward Conard	Marcy & Max Kahn	David & Anita Rogerson	Joseph Forte
Peter & Judith Dawkins	Cindy Kaplan & David Froelich	David Rosenberg	Frank Wood
Kendra Decious & Curt Child	Mark Keoppen & Wendy Townsend	Russel & Debra Rosenthal	Joanne Woodward & Paul Newman
Neil DeSena & Carolyn DeSena	Judy Kuhn & David Schwab	Ida Roth	Bill Wrubel & Jennifer Crittenden
Oliver & Christina Dobbs	Roger & Belle Kuhn	Martha Roth & Bill Irwin	George Xenos
Whitney Dow &	Warren Leight	Erica Heilman	Jeffrey & Janine Yass
Thomasine Dolan Dow	Liza Lerner	Alan & Joan Safir	Luchia Yocabucci
Richard & Rebecca Dresser	Mark Linn-Baker & Adrienne Lobel	Laura Sametz & Anton Fig	
Greg Durkin & Vanessa Beecroft	John Bedford Lloyd &	Robert Sandberg	
Beth Emelson	Anne Twomey	Marcia Santoni & John Morris	
Michael Engerl & Steve Sumser	Michael & Marjorie Loeb	Karin & Tom Schall	
Wendy Ettinger & Derek McLane	Mark Lanow & Joanne Astrow	Robert Schnur	
Andrew & Sandi Farkas	Edith Lutnick	Lauren Seikaly & Michael Huber	

THE 52ND STREET PROJECT PRESENTS

# WHAT'S NEW?!?



PLAYBACK 2007  
THE JULIA MILES THEATER  
OCTOBER 19 - 21, 2007

**WHAT'S NEW?!?**  
**PLAYBACK 2007**  
**OCTOBER 19 -21**  
**THE JULIA MILES THEATER**

**The 52nd Street Project Staff:**

Gus Rogerson, Artistic Director  
 Carol Ochs, Executive Director  
 John Sheehy, Director of Development and Marketing  
 George "Foamcore Wizard" Babiak, Production Manager  
 Reg Flowers, Associate Artistic Director  
 Liz Bell, Director of Education  
 Megan Cramer, Program Director  
 Diana Rojas, Executive Assistant  
 Josh Moody, Development Assistant  
 Jan Gura, Capital Campaign Consultant  
 Chris Ceraso, Teen Dean  
 Iris A. Brown, Graphic Designer  
 Nicole Fargardo, Kayelani Silva, Receptionists  
 Courtney Fitzgerald, Stacy Towles, Interns

**Production Staff:**

**Composer:**

Andrew Sherman

**Set Designer:**

Kevin Joseph Roach

**Lighting Designers:**

Greg MacPherson & Sam Newman

**Costume Designers:**

Courtney Fitzgerald & Stacy Towles

**Sound:**

Drew Vanderburg

**Stage Manager:**

Karen Munkel

**Slide Designs:**

George Babiak, Josh Moody  
 and the Project Slide Archive

**Prop Design Team:**

George Babiak, Courtney Fitzgerald,  
 Josh Moody, Stacy Towles

**Crew:**

Doris Alcantara, Courtney Fitzgerald,  
 Andy Reyes, Stacy Towles

**Load-in and Light-hang Crew:**

Karen Munkel, Sam Newman, Elaine  
 Romanelli, Tom Schall, Manesha  
 Snoyer, Charlie Tocantins

**House Manager:**

Liz Bell, John Sheehy

**Chefs:**

Liz Bell & Carol Ochs

The Playback Program is made possible with public funds from The New York State Council on the Arts, a state agency; and the New York City Department of Cultural Affairs. The 52nd Street Project is supported by funds from the National Endowment for the Arts. The Project is a member of ART/NY.

From time to time, the Julia Miles Theater is available to independent producers. This production is produced independently and is not a production of Women's Project. In the event of fire, please proceed quietly to the nearest exit. Exits are located where you entered the theater and to the right of the stage. The use of cameras and other recording devices in this Theater is prohibited by law. There is no smoking anywhere in this theater, including lobby, stairways, and restrooms.



**COOL STUFF ON SALE IN THE LOBBY!**

The Fabulous Flyer Bar . . .\$2.50, \$2, \$1.50 & \$1  
*and featuring Shel Silverstein's "Fivey and Twoey" logo:*

Project T-shirts (*New Design*) . . . . . \$12.00  
 Project Hoodies . . . . . \$30.00  
 Project Mugs . . . . . \$5.00  
 Project Pencil 3-pack . . . . . \$1.00  
 Project Notebook . . . . . \$5.00  
 Playmaking Book . . . . . \$15.00

Thank you for coming to **WHAT'S NEW?!?** If you are not on our mailing list (or if your address has changed), please fill out this form and give it to us on your way out or mail it to the address below. We would also like to know if you are interested in becoming a volunteer. We need help in **all areas**, so be sure to fill out the entire form.

**PLEASE ADD ME TO YOUR MAILING LIST:**

10/07

NAME: \_\_\_\_\_

ADDRESS: \_\_\_\_\_

\_\_\_\_\_ ZIP \_\_\_\_\_

HOME PHONE: \_\_\_\_\_

DAYTIME PHONE: \_\_\_\_\_

E-MAIL ADDRESS: \_\_\_\_\_

MY OCCUPATION: \_\_\_\_\_

MY HOBBIES: \_\_\_\_\_

**YES, I WOULD LIKE TO BE OF HELP. I CAN:**

- |   |   |  |
|---|---|--|
| <input type="checkbox"/> Help load in and out for shows | <input type="checkbox"/> Draw and/or paint  | <input type="checkbox"/> Help kids with homework |
| <input type="checkbox"/> Hang lights                    | <input type="checkbox"/> Help with mailings | <input type="checkbox"/> Teach kids a skill      |
| <input type="checkbox"/> Work on a backstage crew       | <input type="checkbox"/> Do office work     | <input type="checkbox"/> Be a chef at an event   |
| <input type="checkbox"/> Do graphic design              | <input type="checkbox"/> Design sound       | <input type="checkbox"/> Design and sew costumes |
| <input type="checkbox"/> Other (please specify) _____   |   |  |

**MY SCHEDULE IS:**

- Very flexible. I'm often available during weekdays.  
 Somewhat flexible. I can help on the occasional morning or afternoon during the week.  
 Not very flexible at all, but I've got some free time on evenings and weekends.

If you would like to mail this (and you're always welcome to enclose a tax-deductible contribution), you can send it to: **The 52nd Street Project**, 500 West 52nd St., New York, NY 10019. Or fax it to (212) 333-5598.

## Don't Miss Our Upcoming Shows!

# Don't Tread On Me!

## The Revolutionary Plays

The Fall 2007  
Playmaking Shows

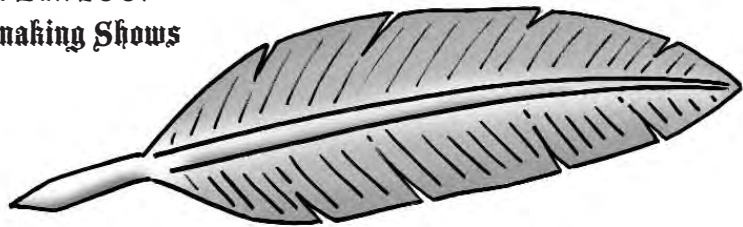

December 7-9, 2007

In September, 10 kids brand-new to the Project began a Playmaking class taught by Project Playmaking Director Reg Flowers. Come and see their final plays performed by adult professional actors.

# THE TWO-ON- TWOOS

FEBRUARY, 2008

Dare we let kids act with each other, with no adult in sight? You bet we do! Come see these six new plays in the New Year.



The 52nd Street Project is a non-profit organization that brings children from the Hell's Kitchen neighborhood together with professional theater artists to create original theater. **WHAT'S NEW?!?** is a production of our **Playback** program, in which kid actor/playwrights wrote plays for themselves and adult actor/director partners. Everyone ventured to the Hamptons for a rehearsal retreat over the Columbus Day weekend. All of the kids involved are veterans of the Playmaking classes which were adapted for the Project by Daniel Judah Sklar from his book *Playmaking: Children Writing and Performing Their Own Plays*.

### The 52nd Street Project Board of Directors

Ben Barenholtz	Noël Mihalow
Lisa Benavides	Carol Ochs
Rachel Chanoff	Willie Reale, <i>founder</i>
Cathy Dantchik	Gus Rogerson
Wendy Ettinger, <i>chair emeritus</i>	Shirley Rumierk, <i>alumni member</i>
Louis P. Friedman	José Soto, Jr., <i>alumni member</i>
Stephen Graham, <i>chair</i>	Pamala Tyson
Larry Jones	Wendy vanden Heuvel
James McDaniel	John A. Vassilaros
Frances McDormand	Jenny Wiener

### Special Thanks

We're extremely grateful to **John Vassilaros**, **Alex Gersten-Vassilaros**, their boys **Tonio**, **Luka** and **Stefano**, and the ever-helpful **Joyce** for allowing us to use their home as our headquarters on our rehearsal trip to the Hamptons. Thanks also to **Louis** and **Patrice Friedman**, who let some of our volunteers crash at their beach pad.

### In-Kind Contributions

The Murphy Law Office; Benefit Cosmetics; Iris A. Brown; Comptoir Sud Pacifique, Ron Kastner and Capital Printing; Kenneth Cole Productions; D'Agostino's; ICI; Noggin; Entertainment Weekly; Newman's Own; Pharma Print/Omni Graphics; Sesame Workshop; Wendy Stuhlberg; John A. Vassilaros; Watkins, Inc.; Mayor's Office of Film & Television; Boylan's Bottling Co.; Lorraine Tobias & Imaginary Studios; Warner Chappell Music Group, Shapiro & Lobel; Simon Spotlight Entertainment, an imprint of Simon and Schuster; Hudson Scenic; Noggin/The N; Prime Films, Mario Badescu; Dlageo Chateau & Estate Wines Co.; Showman Fabricators; Frédéric Fekkai & Co., LLC and Paul, Weiss, Rifkind, Wharton & Garrison LLP, Shapiro & Lobel, and Whole Foods.

## WHAT'S NEW ??? - ACT I

All original music composed by Andrew Sherman

### TACO FEVER

Written by Jason Gil, age 12  
Director/Dramaturge: Tim Cain

Sean .....Tim Cain  
John .....Jason Gil  
Lunch Lady .....Doris Alcantara  
Customers .....Courtney Fitzgerald, Stacy Towles

*Try It* lyrics by Jason Gil

### THE WAR BETWEEN LOVE AND HATE

Written by Ashley Smith, age 12  
Director/Dramaturge: Maile Holck

Jessica .....Ashley Smith  
Mom .....Maile Holck  
Chae .....Andy Reyes  
The Voice of God .....Nancy Giles

*It's Alright & Thank You* lyrics by Ashley Smith

### THE LOST KINGDOM

Written by Terrence Mack, age 13  
Director/Dramaturge: Jeremy Beck

King Johnny .....Jeremy Beck  
King Lew .....Terrence Mack  
Guard .....Andy Reyes  
Kew .....George Babiak  
Corpses .....Crew

*If I Was Ruler, This Means War & The Plan* lyrics by Terrence Mack

### VICKY

Written by Chloe Moore, age 12  
Director/Dramaturge: Reg Flowers

Vicky .....Chloe Moore  
Danny .....Reg Flowers  
Jessica .....Courtney Fitzgerald  
Natasha .....Stacy Towles  
Ms. Canada/Ms. Rich .....Doris Alcantara

*A Speech* lyrics by Chloe Moore

## INTERMISSION

## WHAT'S NEW ??? - ACT II

### MUSICAL RAPPING CANDY-LOVING SOLDIERS

Written by Georgie Zapata, age 13  
Director/Dramaturge: Josh Moody

Pipsqueak .....Josh Moody  
Peanut .....Georgie Zapata  
Announcer/Pilot .....George Babiak  
Enemy Soldiers .....Crew

*Candy* lyrics by Georgie Zapata

### JELLO FELLOWS

Written by Lily Houghton, age 12  
Director/Dramaturge: Megan Cramer (with thanks to Keira Naughton)

Abby Munchin .....Megan Cramer  
Izzy Munchin .....Lily Houghton  
Hardcore Fan .....Courtney Fitzgerald  
Announcer .....George Babiak

*For Better or For Worse* lyrics by Lily Houghton

### THE DEMON SLAYER

Written by Lordan Ulloa, age 13  
Director/Dramaturge: Nancy Giles

Tony .....Lordan Ulloa  
Betty .....Nancy Giles

*Bad and Good Things, Lies & The Truth* lyrics by Lordan Ulloa

### BEST FRIENDS OR NOTHING

Written by Stephanie Marion, age 12  
Director/Dramaturge: Angel Desai

Kyle .....Stephanie Marion  
Kylie .....Angel Desai  
Friends .....Courtney Fitzgerald, Stacy Towles  
Sasha .....George Babiak  
Announcer .....Andrew Sherman

*Reputation* lyrics by Stephanie Marion





The 52nd Street Project gratefully acknowledges the support of the following foundations and corporations: APA; Bear Stearns; BSKS Architects LLP; Bloomberg; The Brenner Family Foundation; Carnegie Corporation of New York; CBS Corporation; Comedy Central; Consolidated Edison; Deutsche Bank of Americas Foundation; The Dramatists Guild Fund; Dramatists Play Service; The William & Mary Greve Foundation; Holland Lodge Foundation, Inc.; HBO; Hudson Scenic Studio; Hurlbut Family Charitable Lead Trust; The Horace W. Goldsmith Foundation; Kekst & Co.; Latham & Watkins LLP; Lloyds TSB Bank plc; James A. Macdonald Foundation; Ann M. Martin Foundation; Mellon Bank, N.A.; Mellon Equity Associated, LLP; The Philip D. & Tammy S. Murphy Foundation; The New York Times Company Foundation; Newman's Own; Noggin; Tony Randall Theatrical Fund; Sesame Workshop; Shapiro & Lobel; Shearman & Sterling, LLP; Jane & Tad Shepard Family Foundation; The Shubert Organization; St. Vincent De Paul Foundation; Stranahan Foundation; The Surdna Foundation; Tax Pro Financial Network, Inc.; John A. Vassilaros & Son, Inc; The Vervane Foundation; Law Offices of Claudia Wagner; The Wiener Family Foundation; Yorke Construction Corporation. In addition, the following individuals made gifts of over \$250 to The 52nd Street Project this past year (list is current as of 7/19/07):

Anonymous	Terri Lee Freeman	Edith Lutnick	Robert Schnur
Raymond & Elizabeth Abbott	Louis & Patrice Friedman	John Lyons	Robert Shaffron & John Davis
Robert Abrams &	Hank Gallo	Grace Lyu-Volkhausen	Pam Shaw & Victor Syrms
Cynthia Vance	Thomas Gannon	Marsue & Peter MacNicol	Meg Simon
Jace Alexander &	Beverly Gasner	Greg MacPherson &	Paul Logan
Maddie Corman	Rose Gasner & Larry Chertoff	Jane Perlmutter	Jean Stein
James Auron	Cora Cahan & Bernard Gersten	Laurie Manifold	Jenny & Jon Steingart
Dylan & Becky Baker	Nancy Giles	Drew McCoy & Amy Aquino	R.L. & Jane Stine
Ben Barenholtz	Jessalyn Gilsig	Paul McCrane & Dana Kellin	Alexandra Styron & Ed Beason
Andy Bart & Paige Bart	James Gosnell	Frances McDormand &	Richard Sweren
Jessica Bauman	Stephen & Cathy Graham	Joel Coen	Jay & Rachel Tarses
Liz Bell	Connie Grappo & Lee Wilkof	Josie Merck & Jim Stevenson	Anne Torsiglieri &
Lisa Benavides & Tim Nelson	Fred Graver & Betsy Graver	Noël & Joe Mihalow	Michael Bernard
Gavin Berger & Craig Berggren	Joy Greenhouse	Erin Moriarty	Adriana & Tim Stephenson
Stephanie Berger & Paul King	Emily Grishman &	Meg Mortimer & David Lloyd	Liz Tuccillo
Elizabeth &	Susan Sampliner	David Mount & Sheri Mount	Amanda Uprichard
Alexander Velazquez Bernstein	Lisa Gugenheim &	Suzen Murakoshi &	Laura Valeroso &
Richard Blackstone &	Larry Nathanson	Mark Temme	David Seidman
Yildez Yuksek	William Henning	Fred Nelson	Josephine Eke &
Tessa Blake & Ian Williams	Joy Henshel	Randy & Rona Nelson	Jason Valk
Douglas & Samara Braunstein	Peter Herdrich & Karen Trott	James Neuberger &	Katrina vanden Heuvel
Becky Browder & Ted Neustadt	Hippeau & Barbara Hippeau	Helen Stambler	Wendy vanden Heuvel &
John Carr & Patricia Carr	Lawrence Hirsh	Lori O'Conner &	Brad Coley
Alfred C. Cerullo III	Megan Hollingshead	Suzanne Poulin	John A. Vassilaros &
Kirk & Katherine Holt Citron	William Holtzman &	Kevin O'Rourke &	Alex Gersten Vassilaros
David Cohen &	S. Sylvia Shepard	Edith Thurber	Gonzalo Vicente
Sandra Novak Cohen	Katy Homans & Patterson Sims	Carol Ochs & Bruce MacVittie	Lynn & Sam Waterston
Ruth Cohen & Bob Usdin	Sarah Horowitz &	Jacki Ochs & Jan Kroeze	Sally & Lenny Weiss
Geoffrey & Ann Coley	David Venarde	Sascha Paladino & Erin Torneo	Steve Weisskoff &
Penny Collins	Charles Huntley	F. Richard Pappas	Rita Weisskoff
John Cunningham	Whitney Scott & Peter Jacobson	Elizabeth Peters	Jane Bolster & Steve Wertimer
Cathy Dantchik	Steven & Miriam Jacobson	Bat-Sheva & Thomas Peters	Joe White & Iris Brown
Leslie Dantchik	Marc Jaffe & Tracy Jaffe	Peter & Ana Rosa Phillips	Margaret Whitton &
Jill Davis & Edward Conard	Andrea Johnson	Jeremy Posner	Warren Spector
Peter & Judith Dawkins	Larry & Mary Jones	Peter & Helen Randolph	Elizabeth Williams &
Kendra Decious & Curt Child	Marcy & Max Kahn	Willie Reale & Jenny Gersten	Joseph Forte
Carolyn & Neil DeSena	Cindy Kaplan &	Jennifer Reichle	Frank Wood
Oliver & Christina Dobbs	David Froelich	Brad Reifler & Ash Reifler	Joanne Woodward &
Whitney Dow & Thomasine	Mark Keoppen &	Jacquelyn Reingold	Paul Newman
Dolan Dow	Wendy Townsend	Richard Reiss & Bonnie Reiss	Bill Wrubel &
Richard & Rebecca Dresser	Judy Kuhn & David Schwab	David & Anita Rogerson	Jennifer Crittenden
Michael Engler	Stephen Lebovitz	David Rosenberg	George Xenos
Wendy Ettinger &	Warren Leight	Russel & Debra Rosenthal	Jeffrey & Janine Yass
Derek McLane	Liza Lerner	Ida Roth	Luchia Yocabucci
Peter Jay Fernandez &	Mark Linn-Baker &	Martha Roth & Bill Irwin	
Denise Burse	Adrienne Lobel	Erica Heilmann	
Tom Fetterman &	John Bedford Lloyd &	Laura Sametz & Anton Fig	
Bonnie Mac Saveny	Anne Twomey	Robert Sandberg	
Alison Fraser & Nat Magee	Michael & Marjorie Loeb	Marcia Santoni & John Morris	
Katherine Freedman	Mark Lanow & Joanne Astrow	Karin & Tom Schall	

The 52nd Street Project Presents

# Don't Tread On Me!

## The Revolutionary Plays



PLAYMAKING - FALL, 2007  
 AMERICAN THEATER OF ACTORS  
 DECEMBER 7 - 9, 2007

**DON'T TREAD ON ME  
PLAYMAKING FALL, 2007  
DECEMBER 7-9  
AMERICAN THEATER OF ACTORS**

**The 52nd Street Project Staff:**

Gus Rogerson, Artistic Director  
 Carol Ochs, Executive Director  
 John Sheehy, Director of Development and Marketing  
 George "Foamcore Wizard" Babiak, Production Manager  
 Reg Flowers, Associate Artistic Director  
 Liz Bell, Director of Education  
 Megan Cramer, Program Director  
 Diana Rojas, Executive Assistant  
 Josh Moody, Development Assistant  
 Jan Gura, Capital Campaign Consultant  
 Chris Ceraso, Teen Dean  
 Iris A. Brown, Graphic Designer  
 Nicole Fargardo, Kayelani Silva, Receptionists  
 Courtney Fitzgerald, Stacy Towles, Interns

**Production Staff:**

**Composer:** Konsin, Brandon Kruhm, John Sheehy,  
 Patrick Barnes  
 Stacy Towles

**Set Designer:** Kevin Joseph Roach  
**Crew:** Joyce Cheung, Courtney Fitzgerald,  
 Brandon Kruhm, Maximo Jimenez,  
 Greg MacPherson & Alex Gordon  
 Stacy Towles

**Lighting Designers:** Greg MacPherson & Alex Gordon  
**Load-in and Light-hang Crew:** Colleen Hodgetts, Laura Konsin,  
 Brandon Kruhm, Rick Meese, Doug  
**Costume Designers:** Crystal Thompson, Beth Goldenberg,  
 Jennifer Jimenez  
 Nervik, Christopher Randolph, Tom  
**Sound:** Maury Schott  
 Schall, Manisha Snoyer

**Stage Manager:** Sadie Bancroft  
**House Manager:** Liz Bell, Karin Schall,  
 Mary Pat Walsh

**Slide Designs:** George Babiak, Josh Moody  
 and the Project Slide Archive  
**Chefs:** Mary Pat Walsh, Iris Brown & Joe  
 White

**Prop Design Team:** George Babiak, Megan Cramer, Courtney  
 Fitzgerald, Patrick Jones, Laura

The Playmaking Program is made possible with public funds from The New York State Council on the Arts, a state agency; and the New York City Department of Cultural Affairs. The 52nd Street Project is supported by funds from the National Endowment for the Arts. The Project is a member of ART/NY.



**COOL STUFF ON SALE IN THE LOBBY!**

The Fabulous Flyer Bar ..\$2.50, \$2, \$1.50 & \$1  
*and featuring Shel Silverstein's "Fivey and Twoey" logo:*  
 Project T-shirts .....\$12.00  
 Project Hoodies (NEW DESIGN) .....\$30.00  
 Project Mugs .....\$5.00  
 Project Pencil 3-pack .....\$1.00  
 Project Notebook .....\$5.00  
 Playmaking Book .....\$15.00

Thank you for coming to **DON'T TREAD ON ME**. If you are not on our mailing list (or if your address has changed), please fill out this form and give it to us on your way out or mail it to the address below. We would also like to know if you are interested in becoming a volunteer. We need help in *all areas*, so be sure to fill out the entire form.

**PLEASE ADD ME TO YOUR MAILING LIST:**

12/07

NAME: \_\_\_\_\_

ADDRESS: \_\_\_\_\_

ZIP \_\_\_\_\_

HOME PHONE: \_\_\_\_\_

DAYTIME PHONE: \_\_\_\_\_

E-MAIL ADDRESS: \_\_\_\_\_

MY OCCUPATION: \_\_\_\_\_

MY HOBBIES: \_\_\_\_\_

**YES, I WOULD LIKE TO BE OF HELP. I CAN:**

- |   |   |  |
|---|---|--|
| <input type="checkbox"/> Help load in or out          | <input type="checkbox"/> Draw and/or paint  | <input type="checkbox"/> Help w/homework         |
| <input type="checkbox"/> Hang lights                  | <input type="checkbox"/> Help with mailings | <input type="checkbox"/> Teach kids a skill      |
| <input type="checkbox"/> Work on a backstage crew     | <input type="checkbox"/> Do office work     | <input type="checkbox"/> Be a chef at an event   |
| <input type="checkbox"/> Do graphic design            | <input type="checkbox"/> Design sound       | <input type="checkbox"/> Design and sew costumes |
| <input type="checkbox"/> Other (please specify) _____ |   |  |

**MY SCHEDULE IS:**

- Very flexible. I'm often available during weekdays.  
 Somewhat flexible. I can help mornings or afternoons during the week.  
 Not very flexible at all, but I've got some free time on evenings and weekends.

If you would like to mail this (and you're always welcome to enclose a tax-deductible contribution), you can send it to: **The 52nd Street Project**, 500 West 52nd St., New York, NY 10019. Or fax it to (212) 333-5598.

Don't Miss Our Upcoming Shows!



The 2008 Two-on-Two's - February 1-3, 2008

TBG Theater, 312 West 36th Street, 4th Floor

6 new plays, each with two kids as performers and two adults as writers and directors. Come watch the kids go it alone on stage!



March, 2008

Enjoying tonight's show? There's more where that came from! In January, 10 brand-new kids will begin the next Playmaking class taught by Project Playmaking Director Reg Flowers. Come and see their final plays performed by adult professional actors.

The 52nd Street Project is a non-profit organization that brings children from the Hell's Kitchen neighborhood together with professional theater artists to create original theater. **DON'T TREAD ON ME** is a production of our Playmaking program. Young people participate in a nine-week playwriting course taught by Reg Flowers and adapted for the Project by Daniel Judah Sklar from his book *Playmaking: Children Writing and Performing Their Own Plays*. At the end of the course, each child is given two actors, a theme, and a dramaturg/director who guides him or her through the writing of a play during a weekend retreat in the country (Stone Ridge, New York, for this show). Tonight's performance is the end result.

### The 52nd Street Project Board of Directors

Ben Barenholtz	Noël Mihalow
Lisa Benavides	Carol Ochs
Rachel Chanoff	Willie Reale, <i>founder</i>
Cathy Dantchik	Gus Rogerson
Carolyn DeSena	Shirley Rumierk, <i>alumni member</i>
Wendy Ettinger, <i>chair emeritus</i>	José Soto, Jr., <i>alumni member</i>
Louis P. Friedman	Jenny Steingart
Stephen Graham, <i>chair</i>	Pamala Tyson
Larry Jones	Wendy vanden Heuvel
James McDaniel	John A. Vassilaros
Frances McDormand	

### Special Thanks

We're extremely grateful to **Steve Gorn, Barbara Bash** and their son **Wiley**, for the use of their beautiful home in Stone Ridge, NY as our base of operations for the writer's retreat. We also owe loads of gratitude to **Mary Pat Walsh**, for cooking some mighty good meals. The indispensable host families were **Joe White & Iris Brown, Laura Shaine Cunningham, Melissa Leo, Elaine Musselman, Nicole & Paul Quinn, Deborah Freedman & Bill Woods, Charles Miles & Naomi Freundlich, and David Curtis & Anne Morse**.

### In-Kind Contributions

The Murphy Law Office; Benefit Cosmetics; Iris A. Brown; Comptoir Sud Pacifique, Ron Kastner and Capital Printing; Kenneth Cole Productions; D'Agostino's; ICI; Noggin; Entertainment Weekly; Newman's Own; Pharma Print/Omni Graphics; Sesame Workshop; Wendy Stuhlberg; John A. Vassilaros; Watkins, Inc.; Mayor's Office of Film & Television; Boylan's Bottling Co.; Lorraine Tobias & Imaginary Studios; Warner Chappell Music Group; Simon Spotlight Entertainment, an imprint of Simon and Schuster; Hudson Scenic; Noggin/The N; Prime Films, Mario Badescu; Diageo Chateau & Estate Wines Co.; Showman Fabricators; Frédéric Fekkai & Co., LLC; Paul, Weiss, Rifkind, Wharton & Garrison LLP, Shapiro & Lobel, and Whole Foods.

## DON'T TREAD ON ME - ACT I

*All original music composed by Patrick Barnes*

### THE HERO AND THE VILLAIN

Written by Alvin Garcia, age 11  
Director/Dramaturge: Larissa Lury  
Costumes by Crystal Thompson  
Octavius Knight .....Howard Overshown  
Maximus Knight .....Christopher Randolph  
*The Superhero* lyrics by Alvin Garcia

### WHO ARE YOU?

Written by Aisha Diaz, age 11  
Director/Dramaturge: Sarah Cameron Sunde  
Costumes by Beth Goldenberg  
Baby Tommy .....Yusef Bulos  
Blueblica .....Lois Smith  
*Twins* lyrics by Aisha Diaz

### THE MAGIC COMPUTER

Written by Kara Thiam, age 12  
Director/Dramaturge: David Dalton  
Costumes by Crystal Thompson  
Atlantic .....Noah Trepanier  
Dell .....Megan Cramer  
Mom .....Stacy Towles  
Little Sister .....Joyce Cheung  
*Secret & How to Act* lyrics by Kara Thiam

### TIME MACHINE EXTREME

Written by Natalia Caballero, age 11  
Director/Dramaturge: Leslie Kramer  
Costumes by Crystal Thompson  
Nina Rabbit .....Mia Barron  
Kina Dog .....Maggie Lacey  
Parents .....Brandon Kruhm, Courtney Fitzgerald  
*Lullaby & Orphanage Kids* lyrics by Natalia Caballero

### UGLY

Written by Nathaniel Butler, age 9  
Director/Dramaturge: Danny Goldstein  
Costumes by Beth Goldenberg  
Ugly .....Felix Solis  
John .....Stevie Ray Dallimore  
*Living in the Forest & Earth's Core* lyrics by Nathaniel Butler

## DON'T TREAD ON ME - ACT II

### WHAT THE SPINACH!!!

Written by Lincoln Bernard, age 9  
Director/Dramaturge: Carlos Armesto  
Costumes by Crystal Thompson  
Binerd .....Frances McDormand  
Sneeker .....John Ellison Conlee  
G.P.S. ....Courtney Fitzgerald  
Clerk .....Maximo Jimenez

### CREATURE + HUMAN = LOVE

Written by Stasia Bree Quinones, age 11  
Director/Dramaturge: Rick Meese  
Costumes by Beth Goldenberg  
Sally Lin .....Caroline Clay  
Loona .....Jeanine Serralles  
*Best Friends* lyrics by Stasia Bree Quinones

### BATTLE OF JAPAN

Written by David McCall, age 12  
Director/Dramaturge: John Sheehy  
Costumes by Beth Goldenberg  
Lee .....James Yaegashi  
Sapphire .....Jessica Hecht  
Jet .....Brandon Kruhm  
*Japan & It's Over* lyrics by David McCall

### MOM DISASTER

Written by Viviana Vazquez, age 11  
Director/Dramaturge: Nicole Watson  
Costumes by Jennifer Jimenez  
Jaime Jeffrey Cohen .....Brandon Dirden  
Fanny Frenchy Cohen .....Crystal Dickinson  
Mom .....Megan Cramer  
*Mom, I Hope You Know & Mom Will Still Be Here* lyrics by Viviana Vazquez

I  
N  
T  
E  
R  
M  
I  
S  
S  
I  
O  
N



The 52nd Street Project gratefully acknowledges the support of the following foundations and corporations: Alexandra Productions, Inc.; APA; BKS Architects LLP; Bloomberg; The Brenner Family Foundation; Carnegie Corporation of New York; CBL Center; CBS Corporation; Citigroup Foundation; Comedy Central; Consolidated Edison; Downtown Arts Development, Inc.; The Dramatists Guild Fund; Dramatists Play Service; The Horace W. Goldsmith Foundation; The William & Mary Greve Foundation; Holland Lodge Foundation, Inc.; The Saul Horowitz Jr. Fund; HBO; Hudson Scenic Studio; Hurlbut Family Charitable Lead Trust; Kekst & Company; Latham & Watkins LLP; Lloyd's TSB Bank plc; James A. Macdonald Foundation; Ann M. Martin Foundation; Mellon Bank, N.A.; The Philip D. & Tammy S. Murphy Foundation; The New York Times Company Foundation; Newman's Own; Noggin; Tony Randall Theatrical Fund; Jonathan Rose Companies, Inc.; St. Vincent De Paul Foundation; Sesame Workshop; Shapiro & Lobel; Shearman & Sterling, LLP; Jane & Tad Shepard Family Foundation; The Shubert Organization; Stranahan Foundation; John A. Vassilaros & Son, Inc; Law Offices of Claudia Wagner; The Wiener Family Foundation; Yorke Construction Corporation. In addition, the following individuals made gifts of over \$200 to The 52nd Street Project this past year (list is current as of 7/19/07):

Anonymous  
 Raymond & Elizabeth Abbott  
 Robert Abrams & Cynthia Vance  
 Jace Alexander & Maddie  
 Corman  
 James Auron  
 Dylan & Becky Baker  
 Ben Barenholtz  
 Patrick Barnes  
 Andy Bart & Paige Bart  
 Jessica Bauman  
 Laurie Becker  
 Liz Bell  
 Michael Bell & Carol Bell  
 Lisa Benavides & Tim Nelson  
 Gavin Berger & Craig Berggren  
 Stephanie Berger & Paul King  
 Elizabeth &  
 Alexander Velazquez Bernstein  
 Richard Blackstone &  
 Yldeez Yuksek  
 Tessa Blake & Ian Williams  
 Buzz Bovshow  
 Douglas & Samara Braunstein  
 Becky Browder & Ted Neustadt  
 Bill Camp  
 Constance Casey  
 Alfred C. Cerullo III  
 Kirk & Katherine Holt Citron  
 David Cohen &  
 Sandra Novak Cohen  
 Ruth Cohen & Bob Usdin  
 Geoffrey & Ann Coley  
 Penny Collins  
 Jeffrey & Anna Cramer  
 John Cunningham  
 Mary D'Elia  
 Cathy Dantchik  
 Leslie Dantchik  
 Jill Davis & Edward Conard  
 Peter & Judith Dawkins  
 Kendra Decious & Curt Child  
 Neil DeSena & Carolyn DeSena  
 Oliver & Christina Dobbs  
 Whitney Dow &  
 Thomasine Dolan Dow  
 Richard & Rebecca Dresser  
 Greg Durkin & Vanessa Beecroft  
 Beth Emelson  
 Michael Engerl & Steve Sumser  
 Wendy Ettinger & Derek McLane  
 Andrew & Sandi Farkas

Peter Jay Fernandez &  
 Denise Burse  
 Tom Fetterman &  
 Bonnie Mac Saveny  
 Alison Fraser & Nat Magee  
 Katherine Freedman  
 Louis & Patrice Friedman  
 Hank Gallo  
 Emily Armstrong &  
 Thomas Gannon  
 Beverly Gasner  
 Rose Gasner & Larry Chertoff  
 Cora Cahan & Bernard Gersten  
 Paul & Liz Giamatti  
 Nancy Giles  
 Jessalyn Gilsig  
 Stephen & Cathy Graham  
 Connie Grappo & Lee Wilkof  
 Fred Graver & Betsy Graver  
 Joy Greenhouse  
 Lisa Gugenheim &  
 Larry Nathanson  
 William Henning  
 Joy & Harry Henshel  
 Peter Herdrich & Karen Trott  
 Hippeau & Barbara Hippeau  
 Lawrence Hirsh  
 William Holtzman &  
 S. Sylvia Shepard  
 Katy Homans & Patterson Sims  
 Sarah Horowitz & David Venarde  
 Charles Huntley  
 Whitney Scott & Peter Jacobson  
 Steven & Miriam Jacobson  
 Marc & Tracy Jaffe  
 Andrea Johnson  
 Larry & Mary Jones  
 Douglas & Katie Jordan  
 Marcy & Max Kahn  
 Cindy Kaplan & David Froelich  
 Mark Keoppen & Wendy  
 Townsend  
 Judy Kuhn & David Schwab  
 Roger & Belle Kuhn  
 Warren Leight  
 Liza Lerner  
 Mark Linn-Baker & Adrienne  
 Lobel  
 John Bedford Lloyd &  
 Anne Twomey  
 Michael & Marjorie Loeb  
 Mark Lanow & Joanne Astrow

Edith Lutnick  
 John Lyons  
 Grace Lyu-Volckhausen  
 Marsue & Peter MacNicol  
 Greg MacPherson &  
 Jane Perlmutter  
 Roma Maffia  
 Laurie Manifold  
 Drew McCoy & Amy Aquino  
 Paul McCrane & Dana Kellin  
 Frances McDormand & Joel  
 Coen  
 Josie Merck & Jim Stevenson  
 Noël & Joe Mihalow  
 Bob & Adriana Mnuchin  
 Erin Moriarty  
 Meg Mortimer & David Lloyd  
 David & Sheri Mount  
 Suzen Murakoshi & Mark Temme  
 Patricia M. Murphy, Esq. &  
 Adam Spilka  
 Stanley & Carol Nelson  
 Fred Nelson  
 Randy & Rona Nelson  
 James Neuberger &  
 Helen Stambler  
 Lori O'Conner & Suzanne Poulin  
 Kevin O'Rourke & Edith Thurber  
 Carol Ochs & Bruce MacVittie  
 Jacki Ochs & Jan Kroeze  
 Sascha Paladino & Erin Torneo  
 F. Richard Pappas  
 Bat-Sheva & Thomas Peters  
 Ana Rosa & Peter Phillips  
 Jeremy & Paulette Posner  
 Peter & Helen Randolph  
 Willie Reale & Jenny Gersten  
 Jacquelyn Reingold  
 Jeffrey Rogers  
 David & Anita Rogerson  
 David Rosenberg  
 Russel & Debra Rosenthal  
 Ida Roth  
 Martha Roth & Bill Irwin  
 Erica Heilman  
 Alan & Joan Safir  
 Laura Sametz & Anton Fig  
 Robert Sandberg  
 Marcia Santoni & John Morris  
 Karin & Tom Schall  
 Robert Schnur  
 Lauren Seikaly & Michael Huber

THE 52ND STREET PROJECT PRESENTS  
**SCANDALOUS!**  
 PLAYS THAT TELL ALL!

**THE 2008  
 TWO-ON-TWO'S**



FRIDAY, FEBRUARY 1 AT 7:30 P.M.  
 SATURDAY, FEBRUARY 2 AT 7:30 P.M.  
 SUNDAY, FEBRUARY 3 AT 3:00 P.M.

**TBG THEATRE**

312 WEST 36TH ST., 3RD FLOOR  
 NEW YORK CITY

# SCANDALOUS!

PLAYS THAT TELL ALL  
THE 2008 TWO ON TWO'S  
FEBRUARY 1-3  
TBG THEATRE

## The 52nd Street Project Staff

Gus Rogerson, Artistic Director  
Carol Ochs, Executive Director  
John Sheehy, Director of Development and Marketing  
George Babiak, Production Manager  
Reg Flowers, Associate Artistic Director  
Liz Bell, Director of Education  
Megan Cramer, Program Director  
Diana Rojas, Executive Assistant  
Josh Moody, Development Assistant  
Jan Gura, Capital Campaign Consultant  
Chris Ceraso, Teen Dean  
Iris A. Brown, Graphic Designer  
Nicole Fargardo, Kayelani Silva, Receptionists  
Eli Phillips, Gillian Riley, Nathan Wright, Interns

## Production Staff

### Composer:

Justin Poindexter

### Set Designer:

Kevin Joseph Roach

### Lighting Designers:

Greg MacPherson, Thom Weaver, and  
Kathleen Dobbins

### Costume Designer:

Katherine Brown

### Soundboard Operator:

Sean Kenealy

### Stage Manager:

Sara Bennett

### Slide Designers:

George Babiak, Josh Moody, and the  
Project Slide Archive

### Prop Design Team:

George Babiak, Eli Phillips, Gillian  
Riley, Brandon Kruhm

### Stage Crew:

Jonathan Kaplan, Eli Phillips,  
Gillian Riley

### Load-in and Light Hang Crew:

David Comstock, Brandon Kruhm,  
Jason Loughlin, Eli Phillips, Gillian  
Riley, Tom Schall.

### House Managers:

Josh Moody and Liz Bell

### Chefs:

George Babiak, Liz Bell, Josh Moody,  
Carol Ochs, John Sheehy

### Hosts:

Maria Tucci and Robert Gottlieb,  
Frances McDormand and Joel Coen,  
and Lili Taylor

### Flyer/Program artwork:

Patrick Jones

The Two-on-Two Program is made possible with public funds from The New York State Council on the Arts, a state agency; and the New York City Department of Cultural Affairs. The 52nd Street Project is supported by funds from the National Endowment for the Arts. The Project is member of ART/NY.



## MAD COOL STUFF ON SALE!

Flyer Bars .....\$2.00, \$1.50 & \$1.00

*Shel Silverstein's "Fivey and Twoey" logo gear:*

Project Hoodies .....\$30.00

Project Caps .....\$20.00

Project Mugs .....\$5.00

Project Pencil 3-pack .....\$1.00

Project Notebooks .....\$5.00

Thank you for coming to **SCANDALOUS!**. If you are not on our mailing list (or if your address has changed), please fill out this form and give it to us on your way out or mail it to the address below. We would also like to know if you are interested in becoming a volunteer. We need help in **all areas**, so be sure to fill out the entire form.

### PLEASE ADD ME TO YOUR MAILING LIST:

02/08

NAME: \_\_\_\_\_

ADDRESS: \_\_\_\_\_

ZIP \_\_\_\_\_

HOME PHONE: \_\_\_\_\_

DAYTIME PHONE: \_\_\_\_\_

E-MAIL ADDRESS: \_\_\_\_\_

MY OCCUPATION: \_\_\_\_\_

MY HOBBIES: \_\_\_\_\_

### YES, I WOULD LIKE TO BE OF HELP. I CAN:

- |   |   |  |
|---|---|--|
| <input type="checkbox"/> Help load in and out for shows | <input type="checkbox"/> Draw and/or paint  | <input type="checkbox"/> Help kids with homework |
| <input type="checkbox"/> Hang lights                    | <input type="checkbox"/> Help with mailings | <input type="checkbox"/> Teach kids a skill      |
| <input type="checkbox"/> Work on a backstage crew       | <input type="checkbox"/> Do office work     | <input type="checkbox"/> Be a chef at an event   |
| <input type="checkbox"/> Do graphic design              | <input type="checkbox"/> Design sound       | <input type="checkbox"/> Design and sew costumes |
| <input type="checkbox"/> Other (please specify) _____   |   |  |

### MY SCHEDULE IS:

- Very flexible. I'm often available during weekdays.  
 Somewhat flexible. I can help on the occasional morning or afternoon during the week.  
 Not very flexible at all, but I've got some free time on evenings and weekends.

If you would like to mail this (and you're always welcome to enclose a tax-deductible contribution), you can send it to: **The 52nd Street Project**, 500 West 52nd St., New York, NY 10019. Or fax it to (212) 333-5598.

**Don't Miss Our Upcoming Shows!**

# STEP ONE: PLAYS WITH INSTRUCTIONS

The Spring Edition of the Project's  
Playmaking Program

*The Calhoun School Theater*

*March 29 - 31, 2008*

At this moment, 10 brand-new Project kids are taking Reg Flowers' Playmaking class. Come see the plays they write as performed by adult professional actors!

Call (212) 642-5052 for reservations.

Honorary co-chairs **Carl Capotorto, Dominic Chianese, & Edie Falco** and the Board of Directors, invite you to save the date... or else!

# The Mezzo Soprano



## MONDAY, MAY 5, 2008

*don't fuhgetaboutit!*

For more information, call Johnny "Bag O'Donuts" Sheehy  
at (212) 333-5252 or email [sheehy@52project.org](mailto:sheehy@52project.org)

The 52nd Street Project is a non-profit organization that brings children from the Hell's Kitchen neighborhood together with professional theater artists to create original theater. **SCANDALOUS!** is a production of our Two-on-Two's program, in which an adult playwright crafts a piece for a pair of Project kids to perform. Another adult directs the kids for a month that includes an intensive three-day weekend in upstate New York. Tonight's performance is the final result.

### The 52nd Street Project Board of Directors

Ben Barenholtz  
Lisa Benavides  
Rachel Chanoff  
Cathy Dantchik  
Carolyn DeSena  
Wendy Ettinger,  
*chair emeritus*  
Louis P. Friedman  
Stephen Graham, *chair*  
Larry Jones  
James McDaniel  
Frances McDormand

Noël Mihalow  
Carol Ochs  
Willie Reale, *founder*  
Gus Rogerson  
Shirley Rumierk,  
*alumni member*  
José Soto, Jr.,  
*alumni member*  
Jenny Steingart  
Pamala Tyson  
Wendy vanden Heuvel  
John A. Vassilaros

### Special Thanks

We owe many thanks to **Maria Tucci** and **Robert Gottlieb, Frances McDormand** and **Joel Coen**, and **Lili Taylor**, all of whom graciously allowed us to use their upstate homes for three tumultuous and fun-filled days. We are also grateful to **Seth, Lee, Porter, Joe**, and everyone else at **The Barrow Group Theatre**. While we're handing out thanks, we'd like to send a special round out to composer **Patrick Barnes**.

### In-Kind Contributions

The Murphy Law Office; Benefit Cosmetics; Iris A. Brown; Comptoir Sud Pacifique, Ron Kastner and Capital Printing; Kenneth Cole Productions; D'Agostino's; ICI; Noggin; Entertainment Weekly; Newman's Own; Pharma Print/Omni Graphics; Sesame Workshop; Wendy Stuhlberg; John A. Vassilaros; Watkins, Inc.; Mayor's Office of Film & Television; Boylan's Bottling Co.; Lorraine Tobias & Imaginary Studios; Warner Chappell Music Group, Shapiro & Lobel; Simon Spotlight Entertainment, an imprint of Simon and Schuster; Hudson Scenic; Noggin/The N; Prime Films, Mario Badescu; Dlageo Chateau & Estate Wines Co.; Showman Fabricators; Frédéric Fekkai & Co., LLC and Paul, Weiss, Rifkind, Wharton & Garrison LLP, Shapiro & Lobel, and Whole Foods.

# SCANDALOUS! □ ACT I

All original music composed and played by Justin Poindexter

## The Best Medicine

By Michael Bernard  
Directed by Joe Mihalow

Thelonius T. Jiggybottom .....Harlo Ulloa  
The Zombie .....Bryant Acosta  
Zombie Horde .....George Babiak, Jonathan Kaplan  
Eli Phillips, Gillian Riley

“The Last Human,” “On Being a Zombie,” and “The Laughter Song” lyrics by Michael Bernard.

## Wedding Bell Blues

By Deirdre O’Connor  
Directed by Erica Cardwell

Carly .....Stephanie Vamvoukakis  
Jessica .....Azalea Rosario  
Chas .....Eli Phillips

“Perfect Wedding Day” and “Fill In the Blank” lyrics by Deirdre O’Connor.

## The Big Beach Party

By Graeme Gillis  
Directed by Reg Flowers

Lady Lifeguard .....Jenisse Bouret  
Hot Dog Boy .....Junior Chatman  
Beach Partygoers .....Liz Bell, Megan Cramer,  
Jonathan Kaplan, Josh Moody,  
Eli Phillips, Gillian Riley

“Lady Lifeguard,” “Cause I’m a Lover,” and “I Guess I Miss the Bronx” lyrics by Graeme Gillis.



# SCANDALOUS □ ACT II

## Bobby’s Babes

By Keira Naughton  
Directed by Kate Marks

Shannon .....Erica Arce  
Wendy .....Jennifer Ramirez  
The Voice of Bobby .....Reg Flowers  
The Host .....George Babiak  
Darcy .....Megan Cramer  
Crew guy .....Eli Phillips

“Bobby’s Babes Theme” lyrics by Keira Naughton.

## War is a Game of Basketball

By Winter Miller  
Directed by Gus Rogerson

Man .....Pablo Maldonado  
Boy .....Mordecai Santiago

“Killing Time” and “I’ll Be Someone” lyrics by Winter Miller.

## Don’t You Make My Red Eye Blue

By Jeff Cox  
Directed by Becky White

Vickie .....Joyce Cheung  
Jack .....A.J. Welsh  
Captain .....Eli Phillips  
The Frenchman .....John Sheehy

“Flight Attendant Theme” and “Red Eye Blue” lyrics by Jeff Cox.





The 52nd Street Project gratefully acknowledges the support of the following foundations and corporations: APA, Bear Stearns; BKSK Architect; Bloomberg LLP; The Brenner Family Foundation; CBS Corporation; Comedy Central; Consolidated Edison; Dramatists Guild Fund; Dramatists Play Service; The Educational Foundation Of America; The Horace W. Goldsmith Foundation; The William & Mary Greve Foundation; HBO; Hudson Scenic Studio; Holland Lodge Foundation, Inc.; Hudson Scenic Studio; Hurlbut Family Charitable Lead Trust; James A. Macdonald Foundation; Ann M. Martin Foundation; Mellon Equity Associated, LLP; LuEsther T. Mertz Charitable Trust; The Philip D. & Tammy S. Murphy Foundation; Newman's Own; The New York Times Company Foundation; Noggin/The N; Tony Randall Theatrical Fund; Sesame Workshop; Shapiro & Lobel; The Shubert Organization; The Surdna Foundation; St. Vincent De Paul Foundation; Stranahan Foundation; TaxPro Financial Network, Inc.; John A. Vassilaros & Son; The Vervane Foundation; Law Offices of Claudia Wagner; The Wiener Family Foundation; Yorke Construction Corp. In addition, the following individuals made gifts over \$250 to The 52nd Street Project this past year (list current as of 3/28/08):

Anonymous	Peter Jay Fernandez &	Michael & Marjorie Loeb	Marcia Santoni & John Morris
Raymond & Elizabeth Abbott	Denise Burse	Mark Lanow &	Karin & Tom Schall
Robert Abrams	Alison Fraser & Nat Magee	Joanne Astrow	Robert Schnur
& Cynthia Vance	Katherine Freedman	Edith Lutnick	Robert Shaffron
Jace Alexander	Terri Lee Freeman	John Lyons	& John Steber
& Maddie Corman	Hank Gallo	Grace Lyu-Volckhausen	Neal Shapiro
James Auron	Thomas Gannon	Greg MacPherson	& Hyunju Chang
Dylan & Becky Baker	Beverly Gasner	& Jane Perlmutter	Pam Shaw & Victor Szymis
Ben Barenholtz	Rose Gasner	Laurie Manifold	Meg Simon
Andy Bart & Paige Bart	& Larry Chertoff	Drew McCoy	Paul Logan
Jessica Bauman	Cora Cahan	& Amy Aquino	Jean Stein
& Ben Posel	& Bernard Gersten	Frances McDormand	Jenny & Jon Steingart
Laurie Becker	Nancy Giles	& Joel Coen	R.L. & Jane Stine
Liz Bell	Jessalyn Gilsig	Josie Merck	Alexandra Styron
Michael Bell & Carol Bell	James Gosnell	& Jim Stevenson	& Ed Beason
Lisa Benavides & Tim Nelson	Richard Gottfried	Noël & Joe Mihalow	Richard Sweren
Gavin Berger & Craig	Stephen & Cathy Graham	Erin Moriarty	Anne Tilney
Berggren	Connie Grappo & Lee Wilkof	David Mount & Sheri Mount	& Douglas Kaden
Stephanie Berger	Fred Graver & Betsy Graver	Suzen Murakoshi	Anne Torsiglieri
& Paul King	Joy Greenhouse	& Mark Temme	& Michael Bernard
Elizabeth & Alexander	Lisa Gugenheim	Carol L. Nadell	Adriana & Tim Stephenson
Velazquez Bernstein	& Larry Nathanson	& Richard E. Van Deusen	Liz Tuccillo
Richard Blackstone	William Henning	Fred Nelson	Amanda Uprichard
& Yldeez Yuksek	Peter Herdrich & Karen Trott	Randy & Rona Nelson	Laura Valeroso
Emily Blavatnik	Lawrence Hirsh	James Neuberger	& David Seidman
Rabbi Laurie	Megan Hollingshead	& Helen Stambler	Josephine Eke & Jason Valk
& Andrew Braun	William Holtzman	Lori O'Conner	Wendy vanden Heuvel
Becky Browder	& S. Sylvia Shepard	& Suzanne Poulin	& Brad Coley
& Ted Neustadt	Katy Homans	Kevin O'Rourke	John A. Vassilaros
John Carr & Patricia Carr	& Patterson Sims	& Edith Thurber	& Son, Inc
Alfred C. Cerullo III	Sarah Horowitz	Carol Ochs	Gonzalo Vicente
Kirk & Katherine Holt Citron	& David Venarde	& Bruce MacVittie	Lynn & Sam Waterston
David Cohen & Sandra	Charles Huntley	Jacki Ochs & Jan Kroeze	Sally & Lenny Weiss
Novak Cohen	Whitney Scott	Sascha Paladino	Steve Weisskoff
Ruth Cohen & Bob Usdin	& Peter Jacobson	& Erin Torneo	& Rita Weisskoff
Penny Collins	Marc Jaffe & Tracy Jaffe	Jeremy Posner	Jane Bolster
John Cunningham	Andrea Johnson	Christopher Randolph	& Steve Wertimer
Cathy Dantchik	Douglas & Katie Jordan	Peter & Helen Randolph	Joe White & Iris Brown
Leslie Dantchik	Marcy & Max Kahn	Willie Reale & Jenny	Margaret Whitton
Peter & Judith Dawkins	Cindy Kaplan	Gersten	& Warren Spector
Neil DeSena	& David Froelich	Jennifer Reichle	Elizabeth Williams
& Carolyn DeSena	Colin Knudsen & Rita Knudsen	Jacquelyn Reingold	& Joseph Forte
Oliver Dobbs	Judy Kuhn & David Schwab	Anita Rogerson	Frank Wood
& Christina Dobbs	Warren Leight	David Rosenberg	Joanne Woodward
Whitney Dow	Liza Lerner	Russel & Debra Rosenthal	& Paul Newman
& Thomasine Dolan Dow	Mark Linn-Baker	Ida Roth	Bill Wrubel
Richard & Rebecca Dresser	& Adrienne Lobel	Martha Roth & Bill Irwin	& Jennifer Crittenden
Wendy Ettinger	John Bedford Lloyd	Erica Heilman	Jeffrey & Janine Yass
& Derek McLane	& Anne Twomey	Laura Sametz & Anton Fig	Luchia Yocabucci

GUS ROGERSON  
ARTISTIC DIRECTOR

REG FLOWERS  
PLAYMAKING DIRECTOR

CAROL OCHS  
EXECUTIVE DIRECTOR

## THE 52ND STREET PROJECT PRESENTS



## Plays With Instructions

**The Spring 2008  
Playmaking Show**

FRIDAY, MARCH 28 AT 7:30 P.M.  
SATURDAY, MARCH 29 AT 3:00 & 7:30 P.M.  
SUNDAY, MARCH 30 AT 3:00 P.M.

THE CALHOUN SCHOOL THEATER  
433 WEST END AVE.

# STEP ONE

PLAYS WITH INSTRUCTIONS - MARCH 28 -30, 2008  
THE CALHOUN SCHOOL THEATER

## The 52nd Street Project Staff

Gus Rogerson, Artistic Director  
Carol Ochs, Executive Director  
John Sheehy, Director of Development and Marketing  
George Babiak, Production Manager  
Reg Flowers, Associate Artistic Director  
Liz Bell, Director of Education  
Megan Cramer, Program Director  
Diana Rojas, Executive Assistant  
Josh Moody, Development Assistant  
Jan Gura, Capital Campaign Consultant  
Chris Ceraso, Teen Dean  
Iris A. Brown, Graphic Designer  
Nicole Fargardo, Kayelani Silva, Alex Tomas, Receptionists  
Nathan Wright, Intern

## Production Staff

### Composer:

Justin Poindexter

### Set Designer:

Kevin Joseph Roach

### Lighting Designer:

Greg MacPherson

### Costume Designers:

Bryan Gmitter, Jennifer Jimenez,  
Chris Rumery

### Sound Designer:

Maury Schott

### Stage Manager:

Linnae Caurdy

### Slide Designers:

George Babiak, Nathan Wright,

and the Project Slide Archive

### Prop Design Team:

George Babiak, Nathan Wright,

Megan Cramer

### Stage Crew:

Joyce Cheung, Joshua Joya,  
Alicia Violan Ryder, Chris Varmus,  
Nathan Wright

### Load-in and Light Hang Crew:

Jason Loughlin, Kevin Ryder,  
Tom Schall, Chris Varmus.

### House Managers:

Liz Bell, Karin Schall, Josh Moody &  
M.P. Walsh

### Chefs:

Liz Bell, Carol Ochs, John Sheehy

### Hosts:

Laurie Becker, John Vassilaros & Alex  
Gersten-Vassilaros, and their kids.

### Flyer/Program artwork:

Reg Flowers

The Playmaking Program is made possible with public funds from The New York State Council on the Arts, a state agency; and the New York City Department of Cultural Affairs. The 52nd Street Project is supported by funds from the National Endowment for the Arts. The Project is member of ART/NY.



## MAD COOL STUFF ON SALE!

Flyer Bars .....\$2.50, \$2, \$1.50 & \$1

*Shel Silverstein's "Fivey and Twoey" logo gear:*

Project Hoodies .....\$30

Project Caps .....\$20

Project Mugs .....\$5

Project Pencil 3-pack .....\$1

Project Notebooks .....\$5

Thank you for coming to **STEP ONE**. If you are not on our mailing list (or if your address has changed), please fill out this form and give it to us on your way out or mail it to the address below. We would also like to know if you are interested in becoming a volunteer. We need help in **all areas**, so be sure to fill out the entire form.

### PLEASE ADD ME TO YOUR MAILING LIST:

03/08

NAME: \_\_\_\_\_

ADDRESS: \_\_\_\_\_

ZIP \_\_\_\_\_

HOME PHONE: \_\_\_\_\_

DAYTIME PHONE: \_\_\_\_\_

E-MAIL ADDRESS: \_\_\_\_\_

MY OCCUPATION: \_\_\_\_\_

MY HOBBIES: \_\_\_\_\_

### YES, I WOULD LIKE TO BE OF HELP. I CAN:

- |   |   |  |
|---|---|--|
| <input type="checkbox"/> Help load in and out for shows | <input type="checkbox"/> Draw and/or paint  | <input type="checkbox"/> Help kids with homework |
| <input type="checkbox"/> Hang lights                    | <input type="checkbox"/> Help with mailings | <input type="checkbox"/> Teach kids a skill      |
| <input type="checkbox"/> Work on a backstage crew       | <input type="checkbox"/> Do office work     | <input type="checkbox"/> Be a chef at an event   |
| <input type="checkbox"/> Do graphic design              | <input type="checkbox"/> Design sound       | <input type="checkbox"/> Design and sew costumes |
| <input type="checkbox"/> Other (please specify) _____   |   |  |

### MY SCHEDULE IS:

- Very flexible. I'm often available during weekdays.  
 Somewhat flexible. I can help on the occasional morning or afternoon during the week.  
 Not very flexible at all, but I've got some free time on evenings and weekends.

If you would like to mail this (and you're always welcome to enclose a tax-deductible contribution), you can send it to: **The 52nd Street Project**, 500 West 52nd St., New York, NY 10019. Or fax it to (212) 333-5598.

## Don't Miss Our Upcoming Shows!

Honorary co-chairs **Carl Capotorto, Dominic Chianese, & Edie Falco** and the Board of Directors, invite you to save the date... or else!

# The Mezzo Sopranos

## MONDAY, MAY 5, 2008

*don't fuhgetaboutdit!*

For more information, call Johnny "Bag O'Donuts" Sheehy at (212) 333-5252 or email [sheehy@52project.org](mailto:sheehy@52project.org)

## ACT YOUR AGE!

### PLAYS THAT GROW ON YOU

THE 2008 ONE-ON-ONES - TWO SEPARATE PRODUCTIONS!  
KIDS AND ADULTS ON STAGE TOGETHER!

JULY 18-20 and AUGUST 15-17

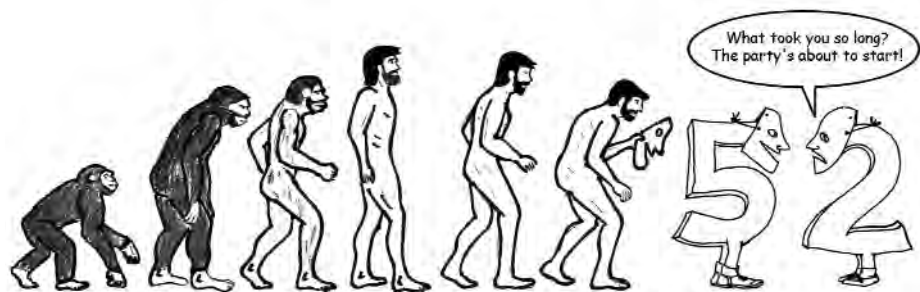

THE EVOLUTION OF FIVE

The 52nd Street Project is a non-profit organization that brings children from the Hell's Kitchen neighborhood together with professional theater artists to create original theater. **STEP ONE** is a production of our Playmaking program, in which young people participate in a nine-week playwriting course taught by Reg Flowers and adapted for the Project by Daniel Judah Sklar from his book *Playmaking: Children Writing and Performing Their Own Plays*. At the end of the course, each child is given two actors, a theme, and a dramaturg/director who guides him or her through the writing of a play during a weekend retreat in the country (Bridgehampton, Long Island, for this show). Tonight's performance is the end result.

### The 52nd Street Project Board of Directors

Ben Barenholtz  
Lisa Benavides  
Rachel Chanoff  
Cathy Dantchik  
Carolyn DeSena  
Wendy Ettinger,  
*chair emeritus*  
Louis P. Friedman  
Stephen Graham, *chair*  
Larry Jones  
James McDaniel  
Frances McDormand

Noël Mihalow  
Carol Ochs  
Willie Reale, *founder*  
Gus Rogerson  
Shirley Rumierk,  
*alumni member*  
José Soto, Jr.,  
*alumni member*  
Jenny Steingart  
Pamala Tyson  
Wendy vanden Heuvel  
John A. Vassilaros

### Special Thanks

We're extremely grateful to **John Vassilaros, Alex Gersten-Vassilaros**, their boys **Tonio, Luka** and **Stefano**, and the ever-helpful **Joyce** for allowing us to use their home as our headquarters and boy dormitory on our Playmaking retreat to Bridgehampton. We also owe some gratitude to **Laurie Becker**, who let some volunteers and the girl writers crash at her luxurious pad in Sag Harbor. Muchas gracias to **Brandon Kruhm, Erin Mallon, Michael Puzzo, Gillian Riley**, and **Melissa Shaw** for helping out in Playmaking class.

### In-Kind Contributions

The Murphy Law Office; Benefit Cosmetics; Iris A. Brown; Comptoir Sud Pacifique, Ron Kastner and Capital Printing; Kenneth Cole Productions; D'Agostino's; ICI; Noggin; Entertainment Weekly; Newman's Own; Pharma Print/Omni Graphics; Sesame Workshop; Wendy Stuhlberg; John A. Vassilaros; Watkins, Inc.; Mayor's Office of Film & Television; Boylan's Bottling Co.; Lorraine Tobias & Imaginary Studios; Warner Chappell Music Group, Shapiro & Lobel; Simon Spotlight Entertainment, an imprint of Simon and Schuster; Hudson Scenic; Noggin/The N; Prime Films, Mario Badescu; Diageo Chateau & Estate Wines Co.; Showman Fabricators; Frédéric Fekkai & Co., LLC and Paul, Weiss, Rifkind, Wharton & Garrison LLP, Shapiro & Lobel, and Whole Foods.

# STEP ONE - ACT I

All original music composed and performed by Justin Poindexter

## Losng Cat

by Katie Liu, age 10. Dramaturge/Director: Julia Gibson  
Costume Designer: Chris Rumery

Bunny .....Emily Dorsch  
Number 1 .....Annie Torsiglieri  
Street People .....The Crew

“So Bad” and “Climbing Tree” lyrics by Katie Liu

## The Haunted Cloverfield

by Dante Quiñones, age 10. Dramaturge/Director: Henry Wishcamper  
Costume Designer: Bryan Gmitter

Jouhn .....Michael Potts  
Markiss .....Reg E. Cathey

## The Love Story of Londin

by Zoe Keanna Norris, age 11. Dramaturge/Director: Jessica Bauman  
Costume Designer: Jennifer Jimenez

Londin .....Nana Mensah  
Keymani .....Brandon Kruhm  
Jrak .....John Sheehy  
Waiter .....Joshua Joya

“I Miss You” lyrics by Zoe Keanna Norris

## The Villain and The Hero

by Rene Paul Santiago, age 9. Dramaturge/Director: Drew Cortese  
Costume Designer: Chris Rumery

Victor .....Jordan Mahome  
Henrey .....Dan Colman  
The Bomb .....Megan Cramer  
The Mirror .....Nathan Wright

“Turning Into a Hero” lyrics by Rene Paul Santiago

## The Big Issue

by Haley Zoe Martinez, age 10. Dramaturge/Director: Jessica Davis-Irons  
Costume Designer: Bryan Gmitter

Jenny .....Denise Burse  
Janet .....Marva Hicks  
Monkeys .....Nathan Wright and Joshua Joya  
The Director .....Joyce Cheung

“We’re Going to the Circus” and “We’re Back Together” lyrics by Haley Zoe Martinez

# STEP ONE - ACT II

## Revenge of Capcom

by Frankie Williams, age 11. Dramaturge/Director: Melissa Shaw  
Costume Designer: Chris Rumery

Tarous .....Matt Citron  
Lea .....Zabryna Guevara  
Capcom .....Reg Flowers

## The Bad Day

by Davon Joseph, age 9. Dramaturge/Director: George Babiak  
Costume Designer: Bryan Gmitter

Josh .....Liche Ariza  
Mike .....Andrew Kelsey  
Counterman .....Joshua Joya  
French girl .....Joyce Cheung  
French Police .....Alicia Violan Ryder, Chris Varmus, and Nathan Wright  
The Referee .....John Sheehy

## Seafoam Beach

by Michael Bannister, age 11.  
Dramaturge/Director: Larry Nathanson, Costume Designer: Jennifer Jimenez

Stella .....Myra Lucretia Taylor  
James .....Larry Nathanson/Frank Wood  
Seafoam/James’ family .....The Crew  
Camerawoman .....Joyce Cheung

“Almost Here” lyrics by Michael Bannister

## The Mysterious Day

by Elena Caballero, age 10. Dramaturge/Director: Laura Konsin  
Costume Designer: Chris Rumery

Destiny .....Alexis McGuinness  
Sarah .....Lori Gardner  
The Guy/The Owner .....George Babiak  
Mom .....Alicia Violan Ryder  
Dad .....Chris Varmus

“I Am So Lonely” lyrics by Elena Caballero

## Crazy Spider Mom

by Elizabeth Vazquez, age 10. Dramaturge/Director: Emilio Delgado  
Costume Designer: Bryan Gmitter

Barbara .....Phyllis Somerville  
Roberto .....Patrick Jones  
Roberto’s friends .....The Crew

“I’m A Idiot” and “No Matter What” lyrics by Elizabeth Vazquez

I  
N  
T  
E  
R  
M  
I  
S  
S  
I  
O  
N

*Honorary Co-chairs*  
**Carl Capotorto, Dominic Chianese,  
and Edie Falco**  
*Corporate Host*  
**Ars Nova**  
*and the Board of Directors of  
The 52nd Street Project present*



**BOARD CHAIR**

Stephen Graham

**EXECUTIVE DIRECTOR**

Carol Ochs

**ARTISTIC DIRECTOR**

Gus Rogerson

**CO-CHAIRS**

Lisa Benavides  
Becky Browder  
Cathy Dantchik  
Carolyn DeSena  
Louis P. Friedman

Patrice Friedman  
Karin Schall  
Jenny Steingart  
Laura Valeroso  
Mary Pat Walsh

**THE BOARD OF DIRECTORS**

Ben Barenholtz  
Lisa Benavides  
Rachel Chanoff  
Cathy Dantchik  
Carolyn DeSena  
Wendy Ettinger,  
*chair emeritus*  
Louis P. Friedman  
Stephen Graham, *chair*  
Larry Jones  
James McDaniel  
Frances McDormand

Noël Mihalow  
Carol Ochs  
Willie Reale, *founder*  
Gus Rogerson  
Shirley Rumierk,  
*alumni member*  
José Soto, Jr.,  
*alumni member*  
Jenny Steingart  
Pamala Tyson  
Wendy vanden Heuvel  
John A. Vassilaros

**THE 52ND STREET PROJECT  
GRATEFULLY ACKNOWLEDGES...**

Abbeville Press  
Stephanie Berger Photography  
Lewis Black  
Iris A. Brown Design  
Carmine Campisi, Graphic Lab  
Kenneth Cole Productions  
William Curran, Curran Affair  
Diageo Chateau & Estate Wines Co.  
Fresh  
La Mer  
New Line Cinema  
Newman's Own  
The N/Nickelodeon  
Parfums Givenchy and Guerlain  
Paris Chocolates  
Pharma/Omni Printing  
Seaside Shakespeare  
Sesame Workshop  
Shapiro Lobel, LLP  
Wendy Stulberg  
John A. Vassilaros & Sons  
Tom Valenti and Ouest  
Watkins Incorporated  
*Healthier Living Since 1868*

**THE MEZZO-SOPRANOS**

**THE CAST**

Edie Falco .....Carmela  
Hashem Ahmed .....Momo  
Maximo Jimenez .....Nicky  
Azalea Rosario .....Rhoda  
Dominic Chianese .....Uncle Junior  
Carl Capotorto .....Little Paulie

**THE MUSICIANS**

Sean Kenealy .....Guitar  
Doug Nervik .....Accordion  
Justin Poindexter .....Mandolin

**DIRECTED BY**

Jonathan Bernstein

**LIGHTING DESIGN**

Greg MacPherson and  
Becky Sealander

**COSTUME DESIGN**

Crystal Thompson

**SET AND PROP DESIGN**

George Babiak and Nathan Wright

**SOUND DESIGN**

Rob Gould

**STAGE MANAGER**

Becky Sealander

**WRITTEN BY**

Willie Reale and John Sheehy

**SONG COMPOSED BY**

Justin Poindexter

**LYRICS BY**

John Sheehy

## **BADA BING! TABLES**

Emily Blavatnik  
The Dantchik Family  
Patrice & Louis Friedman  
Cathy & Stephen Graham  
Jenny & Jon Steingart, Ars Nova

## **GODFATHER TABLES**

Betsy MacIsaac & Robert Goldberg,  
Yorke Construction Corporation  
Wendy Ettinger & Derek McLane  
Janine & Jeffrey Yass

## **FAMILY BUSINESS TABLES**

Carolyn & Neil DeSena  
Freddie Gershon  
Joanne Woodward &  
Paul Newman Foundation

## **GOODFELLAS TABLES**

Denise Burse & Peter Jay Fernandez  
CBS Corporation  
The Dawkins Family Foundation  
Rose Gasner & Larry Chertoff  
Alexandra Gersten-Vassilaros &  
Johnny Coffeeshopolis  
Mrs. Saul Horowitz, Jr.  
Lloyds TSB Bank plc  
Fred Nelson  
Rona & Randolph Nelson  
Savoy Bank  
Sesame Workshop  
Wendy vanden Heuvel & Brad Coley

## **PINE BARRENS SEATS**

Elizabeth & Raymond Abbott  
Becky Ann & Dylan Baker  
Lisa Benavides Nelson & Tim Blake Nelson  
Gavin Berger & Craig Berggren  
Elizabeth & Alexander Bernstein  
Tessa Blake & Ian Williams  
Allison M. Blinken  
JuJu Chang & Neal Shapiro  
Jennifer Crittendon & Bill Wrubel  
Jessica Doty  
Andrew & Martin Farach-Colton  
Kay Gayner & Frank Wood

Nancy Giles  
Kilty Gilmour  
Jessalyn Gilsig & Bobby Salomon  
Susannah Gray & John Lyons  
Katheryn Holt & Kirk Citron  
Sarah Horowitz & David Venarde  
Felicia & Sy Jacobs  
William Johnston  
Cynthia Kaplan & David Froelich  
Mickey Lemle  
Barbra Locker & Penny Zuckerwise  
Marjorie & Michael Loeb  
John S. Lyons  
Jennifer Manocherian  
Frances McDormand & Joel Coen  
Ruth Nelson  
Lori O'Connor  
Jane Perlmutter & Greg MacPherson  
Suzanne Poulin  
Jonathan Rose Companies, Inc.  
Laura & David Ross  
Daryl Roth

Steve Sabba, Tax Pro Financial Network, Inc.  
Farrell & Steven Starker  
Richard Sweren  
Cynthia Vance & Robert Abrams  
Joe Versace  
Claudia Wagner & Don Lebowitz  
Elizabeth Williams & Joseph Forte  
Yildiz Yuksek & Richard Blackstone

## **WITNESS RELOCATION SEATS**

May Ameen  
Cecilia Arana-Grant  
Emily Armstrong &  
Thomas P. Gannon  
June Ballinger & Michael  
Goldstein  
Ben Barenholtz  
Stephen Bernstein  
BKSK Architects  
Cora Cahan &  
Bernard Gersten  
Tracey Caliendo &  
Dennis Schneck  
Danna Call  
Chris Ceraso  
Rachel Chanoff  
Maddie Corman &  
Jace Alexander  
David Costabile  
Craig Cox  
Marion & Alan Dienstag  
Rebecca & Richard Dresser  
Katie Flahive & Josh Bywater  
Liz Flahive & Jeff Cox  
Alison Fraser & Nat Magee  
Tom Gazianis  
Jenny Gersten & Willie Reale  
Jilian Cahan Gersten &  
Brian Shuman  
Felicia Gibson &  
Thomas Jaycox  
Karen Hauser &  
Warren Leight  
Annie Hausman  
Gayle & David Heller  
Sally Holmes & Doug Curtis  
Sarah Kay & Josh Lewis  
Joyce Krawiecki  
Judy Kuhn & David Schwab  
Darrell Larson  
Joshua Lehrer &  
Jeffrey Seller

Adrienne Lobel &  
Mark Linn-Baker  
Andy Marber  
Emily & John Morgan  
Erin Moriarty  
Suzen Murakoshi &  
Mark Temme  
Jane Musky &  
Tony Goldwyn  
Rachel & Larry Norton  
Jackie Ochs & Jan Kroeze  
Sue Phillips  
Judy & Michael Pillinger  
Christopher Randolph  
Jackie Reingold &  
Rich Campbell  
Anita A. Rogerson  
Martha Roth & Bill Irwin  
Marcia Santoni  
Karin & Thomas Schall  
Erica Schmidt &  
Peter Dinklage  
Maury Schott  
Whitney Scott &  
Peter Jacobson  
Sylvia Shepard &  
Will Holtzman  
Meg Simon  
Lois Smith  
John Steber &  
Robert Shaffron  
Edith Thurber &  
Kevin O'Rourke  
Anne Torsiglieri &  
Michael Bernard  
Karen Trott & Peter Herdrich  
Laura Valeroso &  
David Seidman  
Susan J. Vitucci  
Mary Pat Walsh  
Ali Marsh & Fred Weller  
Max Wilk  
Susanne Williams &  
Gerald Howard  
Carole Yass  
Connie & Marc Zand

List current as of 4/30/08

## **THE 52ND STREET PROJECT STAFF**

Carol Ochs, Executive Director  
Gus Rogerson, Artistic Director  
John Sheehy, Dir. of Development and Marketing  
George Babiak, Production Manager  
Reg Flowers, Associate Artistic Director  
Liz Bell, Director of Education  
Megan Cramer, Program Director  
Diana Rojas, Executive Assistant  
Josh Moody, Development Assistant  
Chris Ceraso, Teen Dean  
Iris A. Brown, Graphic Designer  
Jan Gura, Capital Campaign Consultant  
Nathan Wright, Intern

## **BENEFIT VOLUNTEERS**

Tim Cain, Mayleen Cancel,  
Heather and Martin Gobbee,  
Sean Kenealy, Catherine Mueller,  
Doug Nervik, Christopher Randolph,  
Kim D. Sherman, Vanessa Valdes

## **SPECIAL THANKS**

William Curran, Liz Flahive,  
Terry Fitzpatrick, Amy Friedman,  
Mark Jacobs, John Laird, Barbara McCrane,  
Karin & Tom Schall, Mary Pat Walsh

**The 52nd Street Project** is a non-profit theater company that brings children from the Hell's Kitchen neighborhood together with professional theater artists to create original theater.

The Teen Ensemble is the final step in the Project's theater programming: a two-year acting curriculum that culminates in the production of a full-length play by William Shakespeare. Past Teen Ensembles have taken their shows to London, the South of France, and Marfa, Texas. The teens you're seeing tonight are completing their first year.

### Special Thanks

We're grateful to **Chris Ceraso** and **Drew University** for hosting the Ensemble for a glorious weekend of rehearsing and performing last week. Thanks also to **Falconworks Artists Group** for the loan of their set chairs and to **Lana Silva** and **Jimmy Choo** for the loan of their fancy shoes. Finally, a big fat helping of thanks to **Brian Kulick**, **Jessica R. Jenen**, **Robert Goldberg**, **Lisa Barnes** and the **Classic Stage Company** for being so generous with their beautiful space.

### The Project Staff

Gus Rogerson . . . . . Artistic Director  
 Carol Ochs . . . . . Executive Director  
 John Sheehy . . . . . Director of Development and Marketing  
 George Babiak . . . . . Production Manager  
 Reg Flowers . . . . . Associate Artistic Director  
 Liz Bell . . . . . Director of Education  
 Megan Cramer . . . . . Program Director  
 Diana Rojas . . . . . Executive Assistant  
 Josh Moody . . . . . Development Assistant  
 Chris Ceraso . . . . . Teen Dean  
 Iris A. Brown . . . . . Graphic Designer  
 Nikki Fargardo, Kayelani Silva,  
 and Alex Tomas . . . . . Receptionists  
 Jan Gura . . . . . Capital Campaign Consultant  
 Sabina Friedman-Seitz, Ali Giacona,  
 and Joshua Hernandez . . . . . Interns

### The 52nd Street Project Board of Directors

Ben Barenholtz	Noël Mihalow
Lisa Benavides	Carol Ochs
Rachel Chanoff	Willie Reale, <i>founder</i>
Cathy Dantchik	Gus Rogerson
Carolyn DeSena	Shirley Rumierk, <i>alumni member</i>
Wendy Ettinger, <i>chair emeritus</i>	José Soto, Jr., <i>alumni member</i>
Louis P. Friedman	Jenny Steingart
Stephen Graham, <i>chair</i>	Pamala Tyson
Larry Jones	Wendy vanden Heuvel
James McDaniel	John A. Vassilaros
Frances McDormand	

The 52nd Street Project Presents

# Like It Is

The 2008 Teen Ensemble One-Act Play Festival



**5 playwrights met with  
 5 teens and wrote  
 5 original one-acts.**

**Here they are.**

Saturday, June 7, 2008 at 7:30 p.m.  
 Sunday, June 8, 2008 at 3:00 p.m.

**Presented at The East 13th Street Theatre  
 136 East 13th St.**

## A TAURIAN TALE

by Tarell Alvin McCraney

Taurian ..... Victor Cortes  
 Jennifer ..... Johanna Vidal  
 Megs ..... Merlaine Mendez  
 Robert ..... Kimani Lewis-Ashley  
 Kid from Pendleton ..... Kayelani Silva  
 Ms. Sannon/Taurian's Mother ..... Megan Cramer  
 Superintendent of Schools ..... Chris Ceraso

## WIRED UP

by Theresa Rebeck

Johanna ..... Johanna Vidal  
 Stella ..... Kayelani Silva  
 Lena ..... Merlaine Mendez  
 Reg ..... Kimani Lewis-Ashley

## CAR TALK

by Liz Tuccillo

Ronnie ..... Kayelani Silva  
 Joanne ..... Megan Cramer

## RECESS

by Zakiyyah Alexander

Jada ..... Merlaine Mendez  
 Kyle ..... Kimani Lewis-Ashley  
 Diego ..... Victor Cortes  
 Eva ..... Johanna Vidal  
 Mr. Klein ..... Chris Ceraso  
 Ms. Gregory ..... Megan Cramer

## MARATHON AND MUCILAGE

a contemplation on an appellation (in dream time)

by Chris Ceraso

“He” ..... Kimani Lewis-Ashley  
 Ms. Gummm ..... Megan Cramer  
 Other Classmates ..... The Ensemble  
 Learned Cat ..... Chris Ceraso  
 Hannibal ..... Reg Flowers  
 Elephants ..... The Ensemble  
 The Oracle of Delphi ..... Megan Cramer  
 The Theater Audience ..... Theater Audience  
 Mother ..... Megan Cramer  
 Father ..... Reg Flowers

Directed by Reg Flowers

Coaching: Emily Dorsch, Mercedes Herrero,  
Patricia McGregor, Jordan Mahome, and Michael Potts

Lighting Designer: Burke Brown

Original music by: Bill Zeffiro

Stage Manager/Sound Operator: Ali Giacona

Lights: Joshua Hernandez Props: Sabina Friedman-Seitz

*Like It Is will be performed without an intermission.*



REG FLOWERS



The **52nd Street Project** is a non-profit organization that brings children from the Hell's Kitchen neighborhood together with professional theater artists to create original theater. The Replay program gives children who are graduates of the Project's Playmaking class a chance to hone their skills in an advanced writing workshop taught by **Megan Cramer** and **Reg Flowers**. Over the nine weeks of Replay class, these young playwrights explored varied sources of inspiration, including a visit to the Whitney Museum, studied dramatic structure, and learned to embrace their own personal writing style. Excerpts from the resulting plays are featured in tonight's reading.

### Special Thanks

We're grateful to **James Houghton**, **Tara Geesaman**, and the rest of the staff at **The Signature Theatre** for making this evening possible. The plays wouldn't have made it to the page without the help of the Replay class volunteers: **Lauren Blumenfeld**, **Cynthia Kaplan**, **Graeme Gillis**, **Christine Grenier**, **Matt Sincell**, **Virginia Vitzthum**, and **Nathan Wright**. We'd especially like to thank the **Cohen** family and friends for their support of Replay.

### The Project Staff

Gus Rogerson . . . . . Artistic Director  
Carol Ochs . . . . . Executive Director  
John Sheehy . . . . . Director of Development and Marketing  
George Babiak . . . . . Production Manager  
Reg Flowers . . . . . Associate Artistic Director  
Liz Bell . . . . . Director of Education  
Megan Cramer . . . . . Program Director  
Diana Rojas . . . . . Executive Assistant  
Joshua A. Moody . . . . . Development Assistant  
Chris Ceraso . . . . . Teen Dean  
Iris A. Brown . . . . . Graphic Designer  
Jan Gura . . . . . Capital Campaign Consultant  
Receptionists . . . . . Nikki Fargardo, Kayelani Silva, Alex Tomas  
Interns . . . . . Sabina Friedman-Seitz, Ali Giacona, Joshua Hernandez

### The 52nd Street Project Board of Directors

Ben Barenholtz	Noël Mihalow
Lisa Benavides	Carol Ochs
Rachel Chanoff	Willie Reale, <i>founder</i>
Cathy Dantchik	Gus Rogerson
Carolyn C. DeSena	Shirley Rumierk, <i>alumni member</i>
Wendy Ettinger, <i>chair emeritus</i>	José Soto, Jr., <i>alumni member</i>
Louis P. Friedman	Jenny Steingart
Stephen Graham, <i>chair</i>	Pamala Tyson
Larry Jones	Wendy vanden Heuvel
James McDaniel	John A. Vassilaros
Frances McDormand	

The 52nd Street Project Presents  
The 2008 Lorraine Cohen

# Replay Readings

Excerpts\* from  
15 new plays by  
15 young playwrights

Monday, June 16, 2008  
7:30 p.m.

The Signature Theatre at  
The Peter Norton Space  
555 West 42nd Street

*\*Although we are presenting excerpts tonight, the complete plays have been published in a bound volume that is available in the lobby for the low price of \$10.00. You can take yours home and have your own Replay Readings whenever you want!*

*All proceeds benefit The 52nd Street Project.*

## THE WORLD OF THE PLAY

### **Stupid**

by Chamel Rodney, age 10. Directed by Tom Schall.

Stoop (Man, Candle) ..... Joel de la Fuente  
Stupidity IX ..... Elliot Villar  
Kids at Mall ..... Cynthia Kaplan, Matt Sincell, Virginia Vitzthum  
Man on TV ..... Matt Sincell

### **The Dilemma With Green**

by Aisha Diaz, age 11. Directed by Beatrice Terry.

Jenny ..... J. Smith-Cameron  
Money ..... Kevin Geer  
Weirdo ..... Nathan Wright

### **The Adventures of Angel and Goldy**

by Brandon Leon, age 10. Directed by Julie Boyd.

Angel ..... Edward O'Brien  
Goldy ..... Kathy Hiler

### **All Because of the Art Piece**

by Stasia Bree Quinones, age 10. Directed by Tom Schall.

Alex ..... Elliot Villar  
Willy ..... Joel de la Fuente  
Operator ..... Cynthia Kaplan

## PERSONAL STYLE

### **Stew Pit**

by Lincoln Bernard, age 10. Directed by Jonathan Bernstein.

Charlie Joe ..... Bill Camp  
Stew Pit ..... Oliver Platt  
Bully ..... Sabina Friedman-Seitz  
The Nerd ..... Graeme Gillis

### **Show Girls, School Girls, Love Girls**

by Jazmine Mikell, age 11. Directed by Nicole Watson.

Ciara ..... Mercedes Herrero  
Jazlina ..... Pascale Armand

### **Who's Afraid of Crickets?**

by Zoltan Lucas, age 11. Directed by Beatrice Terry.

Pip ..... Kevin Geer  
Gruj ..... J. Smith-Cameron  
Cricket ..... Nathan Wright

## GENRE

### **Dark World**

by Nathaniel Butler, age 10. Directed by Jonathan Bernstein.

Rick ..... Oliver Platt  
Chris ..... Bill Camp  
Guard ..... Graeme Gillis

## **Twinkle Twinkle On a Sister, How I Wonder Where You Are**

by Viviana Vazquez, age 12. Directed by Julie Boyd.

Marisol ..... Kathy Hiler  
Ken ..... Edward O'Brien  
Lilly ..... Lauren Blumenfeld  
Laura ..... Christine Grenier

## **INTERMISSION**

## LANGUAGE

### **The Love in the 1200**

by Tino Paduani, age 12. Directed by Julie Boyd.

Jacob ..... Edward O'Brien  
Henryate ..... Kathy Hiler  
Guard ..... Christine Grenier

### **Drama Queens**

by Kimberly Zenteno, age 12. Directed by Nicole Watson.

Lizzy ..... Pascale Armand  
Amy ..... Mercedes Herrero  
Mailer ..... Joshua Hernandez

### **The Battle of Icon versus Legend**

by David McCall, Jr., age 13. Directed by Tom Schall.

Announcer ..... Matt Sincell  
The Exotic "Icon" Eviserator ..... Elliot Villar  
JC "Legend" Classic ..... Joel de la Fuente  
Manager Jack ..... Virginia Vitzthum

## LEVELS

### **Carolina**

by Gabriella Dejesus, age 11. Directed by Beatrice Terry.

Carolina ..... J. Smith-Cameron  
Husky ..... Nathan Wright  
Melvin ..... Kevin Geer

### **1 Family + 1 Family = 2 Rivals!!!**

by Alvin Garcia, age 12. Directed by Jonathan Bernstein.

Michael Macheevy ..... Oliver Platt  
Castado "Sonny" Macheevy ..... Bill Camp

### **Monsterland**

by Natalia Caballero, age 11. Directed by Nicole Watson.

Mary ..... Pascale Armand  
Aunt ..... Mercedes Herrero

**A SPECIAL TALKBACK SEGMENT WILL FOLLOW.  
GET YOUR QUESTIONS READY!**

The 52nd Street Project gratefully acknowledges the support of the following foundations and corporations: APA, Bear Stearns; BSKS Architect; Bloomberg LLP; The Brenner Family Foundation; CBS Corporation; Comedy Central; Consolidated Edison; Dramatists Guild Fund; Dramatists Play Service; The Educational Foundation Of America; The Horace W. Goldsmith Foundation; St. William & Mary Greve Foundation; HBO; Hudson Scenic Studio; Holland Lodge Foundation, Inc.; Hudson Scenic Studio; Hurlbut Family Charitable Lead Trust; James A. Macdonald Foundation; Ann M. Martin Foundation; Mellon Equity Associated, LLP; LuEsther T. Mertz Charitable Trust; The Philip D. & Tammy S. Murphy Foundation; Newman's Own; The New York Times Company Foundation; Noggin/The N; Tony Randall Theatrical Fund; Sesame Workshop; Shapiro & Lobel; The Shubert Organization; The Surdna Foundation; St. Vincent De Paul Foundation; Stranahan Foundation; TaxPro Financial Network, Inc.; John A. Vassilaros & Son; The Vervane Foundation; Law Offices of Claudia Wagner; The Wiener Family Foundation; Yorke Construction Corp. In addition, the following individuals made gifts over \$250 to The 52nd Street Project this past year (list current as of 3/28/08):

Anonymous	Peter Jay Fernandez &	Michael & Marjorie Loeb	Marcia Santoni & John Morris
Raymond & Elizabeth Abbott	Denise Burse	Mark Lanow &	Karin & Tom Schall
Robert Abrams	Alison Fraser & Nat Magee	Joanne Astrow	Robert Schnur
& Cynthia Vance	Katherine Freedman	Edith Lutnick	Robert Shaffron
Jace Alexander	Terri Lee Freeman	John Lyons	& John Steber
& Maddie Corman	Hank Gallo	Grace Lyu-Volckhausen	Neal Shapiro
James Auron	Thomas Gannon	Greg MacPherson	& Hyunju Chang
Dylan & Becky Baker	Beverly Gasner	& Jane Perlmutter	Pam Shaw & Victor Szymis
Ben Barenholtz	Rose Gasner	Laurie Manifold	Meg Simon
Andy Bart & Paige Bart	& Larry Chertoff	Drew McCoy	Paul Logan
Jessica Bauman	Cora Cahan	& Amy Aquino	Jean Stein
& Ben Posel	& Bernard Gersten	Frances McDormand	Jenny & Jon Steingart
Laurie Becker	Nancy Giles	& Joel Coen	R.L. & Jane Stine
Liz Bell	Jessalyn Gilsig	Josie Merck	Alexandra Styron
Michael Bell & Carol Bell	James Gosnell	& Jim Stevenson	& Ed Beason
Lisa Benavides & Tim Nelson	Richard Gottfried	Noël & Joe Mihalow	Richard Sweren
Gavin Berger & Craig	Stephen & Cathy Graham	Erin Moriarty	Anne Tilney
Berggren	Connie Grappo & Lee Wilkof	David Mount & Sheri Mount	& Douglas Kaden
Stephanie Berger	Fred Graver & Betsy Graver	Suzen Murakoshi	Anne Torsiglieri
& Paul King	Joy Greenhouse	& Mark Temme	& Michael Bernard
Elizabeth & Alexander	Lisa Gugenheim	Carol L. Nadell	Adriana & Tim Stephenson
Velazquez Bernstein	& Larry Nathanson	& Richard E. Van Deusen	Liz Tuccillo
Richard Blackstone	William Henning	Fred Nelson	Amanda Uprichard
& Yldeez Yuksek	Peter Herdrich & Karen Trott	Randy & Rona Nelson	Laura Valeroso
Emily Blavatnik	Lawrence Hirsh	James Neuberger	& David Seidman
Rabbi Laurie	Megan Hollingshead	& Helen Stambler	Josephine Eke & Jason Valk
& Andrew Braun	William Holtzman	Lori O'Conner	Wendy vanden Heuvel
Becky Browder	& S. Sylvia Shepard	& Suzanne Poulin	& Brad Coley
& Ted Neustadt	Katy Homans	Kevin O'Rourke	John A. Vassilaros
John Carr & Patricia Carr	& Patterson Sims	& Edith Thurber	& Son, Inc
Alfred C. Cerullo III	Sarah Horowitz	Carol Ochs	Gonzalo Vicente
Kirk & Katherine Holt Citron	& David Venarde	& Bruce MacVittie	Lynn & Sam Waterston
David Cohen & Sandra	Charles Huntley	Jacki Ochs & Jan Kroeze	Sally & Lenny Weiss
Novak Cohen	Whitney Scott	Sascha Paladino	Steve Weisskoff
Ruth Cohen & Bob Usdin	& Peter Jacobson	& Erin Torneo	& Rita Weisskoff
Penny Collins	Marc Jaffe & Tracy Jaffe	Jeremy Posner	Jane Bolster
John Cunningham	Andrea Johnson	Christopher Randolph	& Steve Wertimer
Cathy Dantchik	Douglas & Katie Jordan	Peter & Helen Randolph	Joe White & Iris Brown
Leslie Dantchik	Marcy & Max Kahn	Willie Reale & Jenny	Margaret Whitton
Peter & Judith Dawkins	Cindy Kaplan	Gersten	& Warren Spector
Neil DeSena	& David Froelich	Jennifer Reichle	Elizabeth Williams
& Carolyn DeSena	Colin Knudsen & Rita Knudsen	Jacquelyn Reingold	& Joseph Forte
Oliver Dobbs	Judy Kuhn & David Schwab	Anita Rogerson	Frank Wood
& Christina Dobbs	Warren Leight	David Rosenberg	Joanne Woodward
Whitney Dow	Liza Lerner	Russel & Debra Rosenthal	& Paul Newman
& Thomasine Dolan Dow	Mark Linn-Baker	Ida Roth	Bill Wrubel
Richard & Rebecca Dresser	& Adrienne Lobel	Martha Roth & Bill Irwin	& Jennifer Crittenden
Wendy Ettinger	John Bedford Lloyd	Erica Heilman	Jeffrey & Janine Yass
& Derek McLane	& Anne Twomey	Laura Sametz & Anton Fig	Luchia Yocabucci

The 52nd Street Project Presents  
THE 2008 HAROLD AND MIMI STEINBERG  
CHARITABLE TRUST ONE-ON-ONES

# ACT YOUR AGE

## PLAYS THAT GROW ON YOU

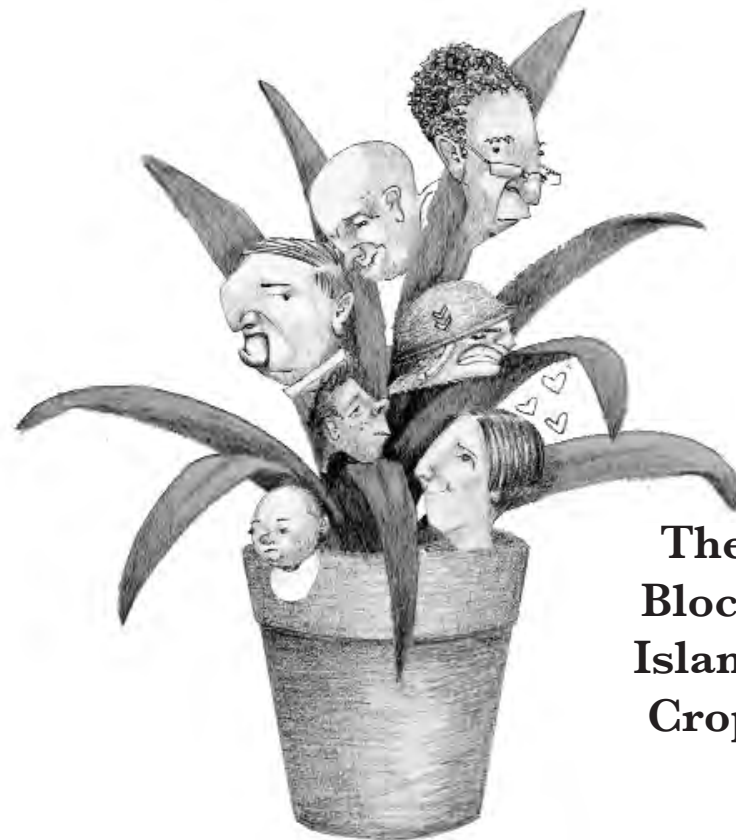

The  
Block  
Island  
Crop

July 18-20, 2008  
Theater Three  
311 West 43rd St.  
New York City

**ACT YOUR AGE: Plays That Grow On You**  
**The Block Island One-on-Ones**  
**July 18-20 - Theater Three**

**The 52nd Street Project Staff**

Gus Rogerson, Artistic Director  
 Carol Ochs, Executive Director  
 John Sheehy, Director of Development and Marketing  
 George Babiak, Production Manager  
 Reg Flowers, Associate Artistic Director  
 Liz Bell, Director of Education  
 Megan Cramer, Program Director  
 Diana Rojas, Associate Program Director  
 Josh Moody, Development Assistant  
 Jan Gura, Capital Campaign Consultant  
 Chris Ceraso, Teen Dean  
 Iris A. Brown, Graphic Designer  
 Nicole Fargardo, Kayelani Silva, Alex Tomas, Receptionists  
 Sabina Friedman-Seitz, Joshua Hernandez, Interns

**Production Staff:**

**Composers:**

Carlo Alban, Patrick Barnes,  
 Brian Feinstein, Greg Pliska,  
 Justin Poindexter, Andrew Sherman,  
 Kim D. Sherman

**Music Director:**

Doug Nervik

**Set Designer:**

Kevin Joseph Roach

**Lighting Designer:**

Greg MacPherson

**Costume Designers:**

Sarita Fellows, Jennifer Jimenez

**Costume Consultant**

Katherine Brown

**Goddess of Sound:**

Vanessa Valdes

**Stage Manager:**

Kathleen Foreman

**Slide Designs:**

George Babiak, Reg Flowers,  
 and the Project Slide Archive

**Prop Design Team:**

George Babiak, Megan Cramer,  
 Kathleen Foreman, Sabina Friedman-  
 Seitz, Joshua Hernandez, Terrence Mack,  
 Josh Moody, Fanneke Verhallen

**Backstage Crew:**

Sabina Friedman-Seitz, Joshua  
 Hernandez, Kimani Lewis-Ashley,  
 Terrence Mack, Noel Polanco,  
 Fanneke Verhallen

**Load-in and Light-hang Crew:**

Sara Bennett, Doug Nervik, Jamie  
 Richards, Tom Schall, Fanneke  
 Verhallen

**House Managers:**

Liz Bell, Karin Schall

**Chefs:**

Pat Ritter, Martha Velie-Gass, and  
 Vanessa Valdes

**Teen Counselor:**

Kimani Lewis-Ashley

**COOL STUFF ON SALE IN THE LOBBY!**

NEW! Replay Scripts .....\$10.00  
 The Fabulous Flyer Bar ..\$2.50, \$2, \$1.50 & \$1  
*and featuring Shel Silverstein's "Fivey and Twoey" logo:*  
 Project T-shirts .....\$12.00  
 Project Tank Tops .....\$12.00  
 Project Caps .....\$20.00  
 Project Mugs .....\$5.00  
 Project Pencil 3-pack .....\$1.00  
 Project Notebook .....\$5.00

Thank you for coming to **ACT YOUR AGE**. If you are not on our mailing list (or if your address has changed), please fill out this form and give it to us on your way out or mail it to the address below. We would also like to know if you are interested in becoming a volunteer. We need help in **all areas**, so be sure to fill out the entire form.

**PLEASE ADD ME TO YOUR MAILING LIST:**

7/08

NAME: \_\_\_\_\_

ADDRESS: \_\_\_\_\_

ZIP \_\_\_\_\_

HOME PHONE: \_\_\_\_\_

DAYTIME PHONE: \_\_\_\_\_

E-MAIL ADDRESS: \_\_\_\_\_

MY OCCUPATION: \_\_\_\_\_

MY HOBBIES: \_\_\_\_\_

**YES, I WOULD LIKE TO BE OF HELP. I CAN:**

- |   |   |  |
|---|---|--|
| <input type="checkbox"/> Help load in and out for shows | <input type="checkbox"/> Draw and/or paint  | <input type="checkbox"/> Help kids with homework |
| <input type="checkbox"/> Hang lights                    | <input type="checkbox"/> Help with mailings | <input type="checkbox"/> Teach kids a skill      |
| <input type="checkbox"/> Work on a backstage crew       | <input type="checkbox"/> Do office work     | <input type="checkbox"/> Be a chef at an event   |
| <input type="checkbox"/> Do graphic design              | <input type="checkbox"/> Design sound       | <input type="checkbox"/> Design and sew costumes |
| <input type="checkbox"/> Other (please specify) _____   |   |  |

**MY SCHEDULE IS:**

- Very flexible. I'm often available during weekdays.  
 Somewhat flexible. I can help on the occasional morning or afternoon during the week.  
 Not very flexible at all, but I've got some free time on evenings and weekends.

If you would like to mail this (and you're always welcome to enclose a tax-deductible contribution), you can send it to: **The 52nd Street Project**, 500 West 52nd St., New York, NY 10019. Or fax it to (212) 333-5598.



The One-on-One Program is made possible with public funds from The New York State Council on the Arts, a state agency; and the New York City Department of Cultural Affairs. The 52nd Street Project is supported by funds from the National Endowment for the Arts. The Project is a member of ART/NY.

## Don't Miss Our Upcoming Shows!

# I SAID, ACT YOUR AGE

MORE PLAYS THAT  
GROW ON YOU



10 New Kids!  
10 New Adults!  
10 New Plays!

Aug. 15-17  
at the  
**Peter Jay Sharp  
Theater at  
Playwrights  
Horizons**

## RUN FOR YOUR LIVES! THE DISASTER PLAYS

The Annual Playback Production - October, 2008  
Theater to be announced

In Playback, young teens are partnered with adults (just like in today's One-on-Ones) but the kids do the writing!

## LEMME PUT IT THIS WAY: THE STRAIGHT TALK PLAYS

The Fall Playmaking Shows - December, 2008  
Theater to be announced

In September, 10 brand-new kids will begin the next Playmaking class taught by Project Playmaking Director Reg Flowers. Come and see their final plays performed by adult professional actors.

The 52nd Street Project is a non-profit organization that brings children from the Hell's Kitchen neighborhood together with professional theater artists to create original theater. **ACT YOUR AGE** is a production of our One-on-One program, which is designed to give children the opportunity to go away for one-week stays in the country and enjoy the undivided attention of a professional theater artist who serves as friend, mentor, and collaborator.

### The 52nd Street Project Board of Directors

Ben Barenholtz  
Lisa Benavides  
Rachel Chanoff  
Cathy Dantchik  
Carolyn DeSena  
Wendy Ettinger, *chair emeritus*  
Louis P. Friedman  
Stephen Graham, *chair*  
Larry Jones  
James McDaniel  
Frances McDormand

Noël Mihalow  
Carol Ochs  
Willie Reale, *founder*  
Gus Rogerson  
Shirley Rumierk,  
*alumni member*  
José Soto, Jr., *alumni member*  
Jenny Steingart  
Pamala Tyson  
Wendy vanden Heuvel  
John A. Vassilaros

### Special Thanks

Our Host Families – Roberta & Alan Alpert; Sue Black; The Homans Family; Jennifer & Elliot Taubman; Ron & Judy Tierney; Norm and Shelly Topf; Joya Verde & Virginia Dare; and our headquarters host Dr. Christina Biaggi. Sincere thanks to our chefs Pat Ritter & Martha Velie-Gass; Lynn Reale; Kate Butcher & everyone at Block Island Realty; Block Island Maritime Institute; Robbie Brown; Rita & Steve Draper; Amelia Gallant at the Block Island Grocery; Cindy & Stan Geer at the Depot; Glenn & Annie Hall; Interstate Navigation; Josie Merck & Jim Stevenson; Kim Gaffett and the Ocean View Foundation; Tom & Carol LaValle; Ben Wohlberg; Sean & Amanda Gass; Sophia MacVittie, and Sherri Kotimsky and the Mint Theater Company.

### In-Kind Contributions

The Murphy Law Office; Benefit Cosmetics; Iris A. Brown; Comptoir Sud Pacifique, Ron Kastner and Capital Printing; Kenneth Cole Productions; D'Agostino's; ICI; Noggin; Entertainment Weekly; Newman's Own; Pharma Print/Omni Graphics; Sesame Workshop; Wendy Stuhlberg; John A. Vassilaros; Watkins, Inc.; Mayor's Office of Film & Television; Boylan's Bottling Co.; Lorraine Tobias & Imaginary Studios; Warner Chappell Music Group, Shapiro & Lobel; Simon Spotlight Entertainment, an imprint of Simon and Schuster; Hudson Scenic; Noggin/The N; Prime Films, Mario Badescu; Diageo Chateau & Estate Wines Co.; Showman Fabricators; Frédéric Fekkai & Co., LLC and Paul, Weiss, Rifkind, Wharton & Garrison LLP, Shapiro & Lobel, and Whole Foods.

## Act Your Age (BI) - Act I

Music director and pianist: Doug Nervik  
*Act Your Age Theme Song*  
music by Patrick Barnes, lyrics by John Sheehy

### AN AGENT OF CHANGE

Written and directed by Bruce MacVittie for Kyle Fargardo, age 12

Agent XY .....Sabina Friedman-Seitz  
Agent I .....Kyle Fargardo  
Dr. Doomsendunder .....Bruce MacVittie  
Les Femmes .....Megan Cramer, Katie Flahive  
& Alexis McGuinness

*I Am I Spy* and *I Want It All* music by Kim D. Sherman, lyrics by Bruce MacVittie

### WE LOVE IT ON THE FARM

Written by Erin Quinn Purcell and directed by Claudia Zelevansky  
for Haley Zoe Martinez, age 10

Sue .....Haley Zoe Martinez  
Irma .....Claudia Zelevansky  
Llama .....George Babiak  
Steve .....Joshua Hernandez

*We Love It On The Farm* and *Tomorrow Is Too Late* music by Justin  
Poindexter, lyrics by Erin Quinn Purcell

### WILD EAGLE VS. CRAZY WOLF

Written and directed by Jed Clarke for Frankie Williams, age 12

Crazy Wolf/Chauncey .....Jed Clarke  
Wild Eagle .....Frankie Williams

*Let's Fight* music by Andrew Sherman, lyrics by Jed Clarke

### GET YOUR FREAK ON

Written and directed by Megan Cramer for Melissa Rebolledo, age 11

Circus Barker Max .....George Babiak  
Maude .....Megan Cramer  
Electric Lady .....Melissa Rebolledo  
Audience Members .....Noel Polanco, Terrence Mack,  
& Fanneke Verhallen

*Life Of A Freak* music by Greg Pliska, lyrics by Megan Cramer

### A NUMBER ON YOUR HEAD

Written and directed by John Sheehy for Alvin Garcia, age 12

Leonard Shipley .....John Sheehy  
Dr. Romero Ebbinghaus .....Alvin Garcia

*Remember Youth* music by Kim D. Sherman, lyrics by John Sheehy

## Act Your Age (BI) - Act II

### THE ISLAND OF DOCTOR MORON

Written by Michael Bernard and directed by Annie Henk  
for Rafael Irizarry III, age 11

Doctor Moron .....Rafael Irizarry III  
Kylie .....Annie Henk  
Voice of Puffy 2 .....Fanneke Verhallen  
Science Woman .....Sabina Friedman-Seitz

*Potion Mixing Song* and *Being Human's Not Completely Lame* music by Justin  
Poindexter, lyrics by Michael Bernard.

### BABYSITTER, SHMAYBESITTER

Written by Megan Mostyn-Brown and directed by Alexis McGuinness  
for Lauren Robinson, age 11

The Princess .....Alexis McGuinness  
Sam .....Lauren Robinson

*What Do We Do* music by Andrew Sherman, lyrics by Megan Mostyn-Brown

### SPY GAMES

Written by Liz Flahive and directed by Katie Flahive  
for Chanel Rodney, age 11

Agent 0077 .....Chanel Rodney  
Agent 421 (Camille) .....Katie Flahive  
Mime/Claude .....George Babiak

*Just Dance* music by Brian Feinstein and lyrics by Liz Flahive

### THE PHANTOM OF THE CABARET

Written and directed by Reg Flowers for Gabriella Dejesus, age 11

Mel .....Terrence Mack  
Christophania .....Gabriella Dejesus  
The Phantom .....Reg Flowers  
Dance Chorus .....Joshua Hernandez & Kimani Lewis-Ashley

*It's Lonely At The Top, I'm the Phantom,* and *That Is What It's All About* music  
by Andrew Sherman, lyrics by Reg Flowers.

### YOU GOTTA

Written and directed by Carlo Alban for David McCall, age 13

Oliver .....Carlo Alban  
Jack .....David McCall  
Bandit .....Kimani Lewis-Ashley  
Death .....Joshua Hernandez

*Get Off Your Feet* music and lyrics by Carlo Alban

I  
N  
T  
E  
R  
M  
I  
S  
I  
O  
N

The 52nd Street Project Presents  
**THE 2008 WIENER FAMILY FOUNDATION ONE-ON-ONES**

The 52nd Street Project gratefully acknowledges the support of the following foundations and corporations: The Altman Foundation; Bloomberg; BKS Architects; The Brenner Family Foundation; Carnegie Corporation of New York; CBS Corporation; Consolidated Edison; The Dermot Company, Inc.; The Dramatists Guild Fund; Dramatists Play Service; Office of Thomas K. Duane; Eleanor, Adam & Mel Dubin Foundation; The Educational Foundation of America; Sidney E. Frank Foundation; Friars National Foundation; The Horace W. Goldsmith Foundation; Green Apple Entertainment, Inc.; Saul Horowitz, Jr. Fund; Hudson Scenic Studio; Hurlbut Family Charitable Lead Trust; JKW Foundation; Lemberg Foundation, Inc.; Lloyds TSB Bank plc; James A. Macdonald Foundation; Ann M. Martin Foundation; Mellon Equity Associated, Llp; LuEsther T. Mertz Foundation; Newman's Own; The New York Times Company Foundation; NYFA; Tony Randall Theatrical Fund; Jonathan Rose Companies; St. Vincent De Paul Foundation; Sallie Mae Fund; Savoy Bank; Peter Schoerfeld Asset Management; Sesame Workshop; Shapiro & Lobel; The Shubert Organization; The Starker Family Foundation; The Surdna Foundation; Susquehanna Foundation, Corp.; Tax Pro Financial Network, Inc.; Tiger Baron Foundation; Van Deusen Family Fund; John A. Vassilaros & Son, Inc.; The Vervane Foundation; Law Offices of Claudia Wagner, Watkins, Inc.; We Of Little Faith; I. Weiss & Sons, Inc.; The Wiener Family Foundation; Yorke Construction Corp. In addition, the following individuals made gifts over \$250 to The 52nd Street Project this past year. (list current as of 8/10/08):

Raymond & Elizabeth Abbott	Wendy Ettinger	Janet Kleinberg	Jennifer Reichle
Robert Abrams	& Derek McLane	Judy Kuhn & David Schwab	Jacquelyn Reingold
& Cynthia Vance	Andrew Farach-Colton	Warren Leight	David Ross & Laura Ross
May Ameen	& Martin Farach-Colton	Mickey Lemle	Daryl Roth
Lisa Andrade-Hicks	Peter Jay Fernandez	Joshua Lewis & Sarah Kay	Karin & Tom Schall
Emily Armstrong	& Denise Burse	Barbara Locker	George Schieferdecker
& Patrick Gannon	Liz Flahive & Jeff Cox	& Penny Zuckerwise	Robert Schnur
James Auron	Alison Fraser & Nat Magee	Michael & Marjorie Loeb	Robert Shaffron & John Davis
Dylan & Becky Baker	Beverly Gasner	Edith Lutnick	Neal Shapiro & Hyunju Chang
Ben Barenholtz	Rose Gasner & Larry Chertoff	John Lyons	Meg Simon
Jessica Bauman & Ben Posel	Cora Cahan	Greg MacPherson	Tom Slaughter
Laurie Becker	& Bernard Gersten	& Jane Perlmutter	Jenny & Jon Steingart
Michael Bell & Carol Bell	Jilian Gersten & Brian Shuman	Ian Madover & Arielle Madover	Richard Sweren
Lisa Benavides & Tim Nelson	Alexandra Gersten-Vassilaros	Jennifer Manocherian	Anne Tilney & Douglas Kaden
Gavin Berger & Craig Berggren	& John A. Vassilaros	Frances McDormand	Liz Tuccillo
Stephanie Berger & Paul King	Nancy Giles	& Joel Coen	Pamala & Sean Tyson
Elizabeth & Alexander Bernstein	Jessalyn Gilsig	Noël & Joe Mihalow	Laura Valeroso
Stephen Bernstein	Richard Gottfried	Emily & John Morgan	& David Seidman
Lewis Black	Stephen & Cathy Graham	Erin Moriarty	Josephine Eke & Jason Valk
Richard Blackstone	Emily Grishman	Suzen Murakoshi	Wendy vanden Heuvel
& Yildez Yuksek	& Susan Sampliner	& Mark Temme	& Brad Coley
Tessa Blake & Ian Williams	David & Ann Hausmann	Patricia M. Murphy, Esq.	Joe Versace
Emily Blavatnik	Peter Herdrich & Karen Trott	& Adam Spilka	Gonzalo Vicente
Allison & Robert Blinks	Megan Hollingshead	Fred Nelson	Grace Lyu-Volckhausen
Rabbi Laurie & Andrew Braun	Sally Holmes & Doug Curtis	Randy & Rona Nelson	Borah & Mildred Walton
John Carr & Patricia Carr	William Holtzman	Ruth Nelson	Lynn & Sam Waterston
Rachel Chanoff	& S. Sylvia Shepard	Rachel & Larry Norton	Jane Bolster
Kirk & Katherine Holt Citron	Katy Homans	Lori O'Connor	& Steve Wertimer
Ruth Cohen & Bob Usdin	& Patterson Sims	Carol Ochs & Bruce MacVittie	Margaret Whitton
Gayle Cohen Heller	Sarah Horowitz	Jacki Ochs & Jan Kroeze	& Warren Spector
& David Heller	& David Venarde	Paul & Maria Onderdonk	Elizabeth Williams
Cathy Dantchik	Gerald Howard	Elizabeth Peters	& Joseph Forte
Leslie Dantchik	Seymour & Felicia Jacobs	Judy Goldman	Frank Wood
Peter & Judith Dawkins	Whitney Scott	& Michael Pillinger	Joanne Woodward
Neil & Carolyn DeSena	& Peter Jacobson	Doug Polley & Stacy Polley	& Paul Newman
Marion & Alan Dienstag	Andrea Johnson	Christopher Randolph	Bill Wrubel
Jessica Doty	Douglas & Katie Jordan	Peter & Helen Randolph	& Jennifer Crittenden
Richard & Rebecca Dresser	Cindy Kaplan & David Froelich	Willie Reale & Jenny Gersten	Suzy Yengo

I SAID,  
**ACT  
 YOUR  
 AGE**

**MORE PLAYS THAT  
 GROW ON YOU**

**The  
 Wareham, Mass.  
 Crop**



**August 15-17, 2008  
 The Peter Jay Sharp Theater  
 416 West 42nd Street  
 New York City**

**I SAID, ACT YOUR AGE: *More Plays That Grow On You***  
**The Wareham, Mass. One-on-Ones**  
**August 15-17 - The Peter Jay Sharp Theater**

**The 52nd Street Project Staff**

Gus Rogerson, Artistic Director  
 Carol Ochs, Executive Director  
 John Sheehy, Director of Development and Marketing  
 George Babiak, Production Manager  
 Reg Flowers, Associate Artistic Director  
 Liz Bell, Director of Education  
 Megan Cramer, Program Director  
 Diana Rojas, Associate Program Director  
 Josh Moody, Development Assistant  
 Jan Gura, Capital Campaign Consultant  
 Chris Ceraso, Teen Dean  
 Iris A. Brown, Graphic Designer  
 Nicole Fargardo, Kayelani Silva, Alex Tomas, Receptionists  
 Sabina Friedman-Seitz, Joshua Hernandez, Interns

**Production Staff:**

**Composer/Music Director:**

Patrick Barnes

**Set Designer:**

Kevin Joseph Roach

**Lighting Designer:**

Greg MacPherson

**Costume Designers:**

Katherine Brown, Kate Cusack

**Sultan of Sound:**

Maury Schott

**Stage Manager:**

Karen Munkel

**Slide Designs:**

George Babiak, Josh Moody,  
and the Project Slide Archive

**Prop Design Team:**

George Babiak, Megan Cramer,  
Sabina Friedman-Seitz, Joshua  
Hernandez, Patrick Jones, Josh Moody,  
Karen Munkel, John Sheehy

**Backstage Crew:**

Doris Alcantara, Nicole Fargardo,  
Sabina Friedman-Seitz,  
Joshua Hernandez

**Load-in and Light-hang Crew:**

Jordan Benke, Karen Munkel,  
Howard Overshown,  
Alicia Violan Ryder,  
Kevin Ryder, Manisha Snoyer

**House Managers:**

Liz Bell, Karin Schall

**Chefs:**

Liz Bell, Carol Ochs, Christopher  
Randolph, John Sheehy

**Teen Counselor:**

Nicole Fargardo

**Hosts:**

Peter, Helen, and Christopher  
Randolph

**COOL STUFF ON SALE IN THE LOBBY!**

NEW! Replay Scripts .....\$10.00  
 The Fabulous Flyer Bar ..\$2.50, \$2, \$1.50 & \$1  
*and featuring Shel Silverstein's "Fivey and Twoey" logo:*  
 Project T-shirts .....\$12.00  
 Project Tank Tops .....\$12.00  
 Project Caps .....\$20.00  
 Project Mugs .....\$5.00  
 Project Pencil 3-pack .....\$1.00  
 Project Notebook .....\$5.00

Thank you for coming to **I SAID, ACT YOUR AGE**. If you are not on our mailing list (or if your address has changed), please fill out this form and give it to us on your way out or mail it to the address below. We would also like to know if you are interested in becoming a volunteer. We need help in **all areas**, so be sure to fill out the entire form.

**PLEASE ADD ME TO YOUR MAILING LIST:**

8/08

NAME: \_\_\_\_\_

ADDRESS: \_\_\_\_\_

ZIP \_\_\_\_\_

HOME PHONE: \_\_\_\_\_

DAYTIME PHONE: \_\_\_\_\_

E-MAIL ADDRESS: \_\_\_\_\_

MY OCCUPATION: \_\_\_\_\_

MY HOBBIES: \_\_\_\_\_

**YES, I WOULD LIKE TO BE OF HELP. I CAN:**

- |   |   |  |
|---|---|--|
| <input type="checkbox"/> Help load in and out for shows | <input type="checkbox"/> Draw and/or paint  | <input type="checkbox"/> Help kids with homework |
| <input type="checkbox"/> Hang lights                    | <input type="checkbox"/> Help with mailings | <input type="checkbox"/> Teach kids a skill      |
| <input type="checkbox"/> Work on a backstage crew       | <input type="checkbox"/> Do office work     | <input type="checkbox"/> Be a chef at an event   |
| <input type="checkbox"/> Do graphic design              | <input type="checkbox"/> Design sound       | <input type="checkbox"/> Design and sew costumes |
| <input type="checkbox"/> Other (please specify) _____   |   |  |

**MY SCHEDULE IS:**

- Very flexible. I'm often available during weekdays.  
 Somewhat flexible. I can help on the occasional morning or afternoon during the week.  
 Not very flexible at all, but I've got some free time on evenings and weekends.

If you would like to mail this (and you're always welcome to enclose a tax-deductible contribution), you can send it to: **The 52nd Street Project**, 500 West 52nd St., New York, NY 10019. Or fax it to (212) 333-5598.



The One-on-One Program is made possible with public funds from The New York State Council on the Arts, a state agency; and the New York City Department of Cultural Affairs. The 52nd Street Project is supported by funds from the National Endowment for the Arts. The Project is a member of ART/NY.



**Don't Miss Our Upcoming Shows!**

# **RUN FOR YOUR LIVES! THE DISASTER PLAYS**

**The Annual Playback Production - October, 2008  
Axis Theatre Company**

**1 Sheridan Square**

**(Barrow St. between West 4th St. and Washington Place)**

In Playback, young teens are partnered with adults (just like in today's One-on-Ones) but the kids do the writing!

# **LEMME PUT IT THIS WAY:**

## **THE STRAIGHT TALK PLAYS**

**The Fall Playmaking Shows - December, 2008  
Theater to be announced**

In September, 10 brand-new kids will begin the next Playmaking class taught by Project Playmaking Director Reg Flowers. Come and see their final plays performed by adult professional actors.

The 52nd Street Project is a non-profit organization that brings children from the Hell's Kitchen neighborhood together with professional theater artists to create original theater. **I SAID, ACT YOUR AGE** is a production of our One-on-One program, which is designed to give children the opportunity to go away for one-week stays in the country and enjoy the undivided attention of a professional theater artist who serves as friend, mentor, and collaborator.

### **The 52nd Street Project Board of Directors**

Ben Barenholtz	Noël Mihalow
Lisa Benavides	Carol Ochs
Rachel Chanoff	Willie Reale, <i>founder</i>
Cathy Dantchik	Gus Rogerson
Carolyn DeSena	Shirley Rumierk, <i>alumni member</i>
Wendy Ettinger, <i>chair emeritus</i>	José Soto, Jr., <i>alumni member</i>
Louis P. Friedman	Jenny Steingart
Stephen Graham, <i>chair</i>	Pamala Tyson
Larry Jones	Wendy vanden Heuvel
James McDaniel	John A. Vassilaros
Frances McDormand	

### **Special Thanks**

Our Host Families in Wareham, Massachusetts – Gerry & Sam Gray; Patty & David Straus; Gray & Rose Watson; Bob & Marina Whitman; Sidney Worthen & David Pearce; Joe McNay, Beth Pfeiffer & the entire McNay family; Peter, Helen & Christopher Randolph.

An untold number of thanks goes to Tim Sanford, Leslie Marcus and all the folks at Playwrights Horizons for donating the use of the fabulous Peter Jay Sharp theater.

### **In-Kind Contributions**

The Murphy Law Office; Abbeville Press; Stephanie Berger Photography; Iris A. Brown Design; Carmine Campisi & Graphic Lab; Kenneth Cole Productions; William Curran & A Curran Affair; Diageo Chateau & Estate Wines Co.; Fresh; ICI; La Mer; New Line Cinema; Newman's Own; Noggin/The N; Parfums Givenchy & Guerlain; Paris Chocolates; Pharma Print/Omni Graphics; Sesame Workshop; Wendy Stuhlberg; John A. Vassilaros; Watkins, Inc.; Mayor's Office of Film & Television; Boylan's Bottling Co.; Lorraine Tobias & Imaginary Studios; Shapiro & Lobel; Hudson Scenic; Prime Films, and Paul, Weiss, Rifkind, Wharton & Garrison LLP.

## I Said, Act Your Age! (Wareham, MA) - Act I

All original music written and played by Maestro Patrick Barnes  
*Act Your Age Theme Song* lyrics by John Sheehy

### SAVE YOUR TOES

Written by Betty Shamieh & Directed by Diana Rojas\*  
for Zoe Keana Norris, age 12

Flo .....Zoe Keana Norris  
Lorna .....Diana Rojas\*

*"When You Dance"* lyrics by Betty Shamieh

### PROSE AND CONS

Written & Directed by George Babiak for Nathaniel Butler, age 10

Icebox/McGuire .....Nathaniel Butler  
Knuckles/Kowalski .....George Babiak  
The Warden .....Megan Cramer  
Stand-ins .....Sabina Friedman-Seitz, Joshua Hernandez

*"Rathole"* lyrics by George Babiak

### BRAVE NEW GIRLS

Written & Directed by Maggie Lacey for Viviana Vazquez, age 12

Lulu .....Viviana Vazquez  
Alice Ann .....Maggie Lacey  
Patrick .....Patrick Barnes  
T.V. ....Sabina Friedman-Seitz, Joshua Hernandez

*"Lulu's Inspirational Song"* & *"Retribution Song"* lyrics by Maggie Lacey

### HIP-HOP NUMBERS

Written by Sean Kenealy & Directed by Paco Tolson for Katie Liu, age 11

Miss Zimmerman .....Katie Liu  
James .....Paco Tolson  
Student .....Nicole Fargardo

*"Everyone Dreams"* lyrics by Sean Kenealy

### JEKYLL AND BRAD

Written & Directed by Craig Cox for Devin Gonzalez, age 11

Dr. Jekyll/Mr. Hyde .....Devin Gonzalez  
Brad .....Craig Cox

*"I Need A Roommate"* & *"Let Loose"* lyrics by Craig Cox

## I Said, Act Your Age! (Wareham, MA) - Act II

### THE LAST LINDA

Written by Cynthia Kaplan & Directed by Shirley A. Rumierk\*  
for Zoltan Lucas, age 11

Dr. Boris K. Morris .....Zoltan Lucas  
Linda 43 .....Shirley A. Rumierk\*

*"The First Linda"* lyrics by Cynthia Kaplan

### FAIRY WINGS

Written by Jessica Bauman & Directed by Erin Mallon  
for Natalia Caballero, age 11

Sparkle .....Natalia Caballero  
Mona .....Erin Mallon  
Bird .....Sabina Friedman-Seitz

*"The Fight"* lyrics by Gus Rogerson

### THE LEAP

Written by Jihan Crowther & Directed by Howard W. Overshown  
for Michael Bannister, age 11

Cade .....Michael Bannister  
Daniel .....Howard W. Overshown

*"What If I'm Scared"* lyrics by Jihan Crowther

### PRESIDENT'S DAY OFF

Written & Directed by Tonya Canada for Lily Capstick, age 11

President .....Lily Capstick  
Vice-President .....Tonya Canada  
Bodyguard .....Nicole Fargardo

*"Pressure"* lyrics by Tonya Canada

### THE FOUNTAIN OF YU

Written & Directed by Christopher Randolph for Stasia Bree Quinones, age 10

Luella .....Stasia Bree Quinones  
Arthur .....Christopher Randolph  
Construction Foreman .....Megan Cramer  
Construction Crew .....Nicole Fargardo, Sabina Friedman-Seitz

*"Young Forever"* lyrics by Christopher Randolph



The 52nd Street Project gratefully acknowledges the support of the following foundations and corporations: The Altman Foundation; Bloomberg; BSKK Architects; The Brenner Family Foundation; Carnegie Corporation of New York; CBS Corporation; Consolidated Edison; The Dermot Company, Inc.; The Dramatists Guild Fund; Dramatists Play Service; Office of Thomas K. Duane; Eleanor, Adam & Mel Dubin Foundation; The Educational Foundation of America; Sidney E. Frank Foundation; Friars National Foundation; The Horace W. Goldsmith Foundation; Green Apple Entertainment, Inc.; Saul Horowitz, Jr. Fund; Hudson Scenic Studio; Hurlbut Family Charitable Lead Trust; JKW Foundation; Lemberg Foundation, Inc.; Lloyds TSB Bank plc; James A. Macdonald Foundation; Ann M. Martin Foundation; Mellon Equity Associated, Llp; LuEsther T. Mertz Foundation; Newman's Own; The New York Times Company Foundation; NYFA; Tony Randall Theatrical Fund; Jonathan Rose Companies; St. Vincent De Paul Foundation; Sallie Mae Fund; Savoy Bank; Peter Schoenfeld Asset Management; Sesame Workshop; Shapiro & Lobel; The Shubert Organization; The Starker Family Foundation; The Surdna Foundation; Susquehanna Foundation, Corp.; Tax Pro Financial Network, Inc.; Tiger Baron Foundation; Van Deusen Family Fund; John A. Vassilaros & Son, Inc.; The Vervane Foundation; Law Offices of Claudia Wagner; Watkins, Inc.; We Of Little Faith; I. Weiss & Sons, Inc.; The Wiener Family Foundation; Yorke Construction Corp. In addition, the following individuals made gifts over \$250 to The 52nd Street Project this past year. (list current as of 8/10/08):

Raymond & Elizabeth Abbott	Richard Dresser	Cindy Kaplan	Jennifer Reichle
Robert Abrams	& Rebecca Dresser	& David Froelich	Jacquelyn Reingold
& Cynthia Vance	Wendy Ettinger	Janet Kleinberg	David Ross & Laura Ross
May Ameen	& Derek McLane	Judy Kuhn & David Schwab	Daryl Roth
Lisa Andrade-Hicks	Andrew Farach-Colton	Warren Leight	Karin & Tom Schall
Emily Armstrong	& Martin Farach-Colton	Mickey Lemle	George Schieferdecker
& Patrick Gannon	Peter Jay Fernandez	Joshua Lewis & Sarah Kay	Robert Schnur
James Auron	& Denise Burse	Barbara Locker	Robert Shaffron
Dylan & Becky Baker	Liz Flahive & Jeff Cox	& Penny Zuckerwise	& John Davis
Ben Barenholtz	Alison Fraser & Nat Magee	Michael & Marjorie Loeb	Neal Shapiro
Jessica Bauman	Beverly Gasner	Edith Lutnick	& Hyunju Chang
& Ben Posel	Rose Gasner	John Lyons	Meg Simon
Laurie Becker	& Larry Chertoff	Greg MacPherson	Tom Slaughter
Michael Bell & Carol Bell	Cora Cahan	& Jane Perlmutter	Jenny & Jon Steingart
Lisa Benavides	& Bernard Gersten	Ian Madover	Richard Sweren
& Tim Nelson	Jilian Gersten	& Arielle Madover	Anne Tilney
Gavin Berger	& Brian Shuman	Jennifer Manocherian	& Douglas Kaden
& Craig Berggren	Alexandra	Frances McDormand	Liz Tuccillo
Stephanie Berger	Gersten-Vassilaros	& Joel Coen	Pamala & Sean Tyson
& Paul King	& John A. Vassilaros	Noël & Joe Mihalow	Laura Valeroso
Elizabeth	Nancy Giles	Emily & John Morgan	& David Seidman
& Alexander Bernstein	Jessalyn Gilsig	Erin Moriarty	Josephine Eke
Stephen Bernstein	Richard Gottfried	Suzen Murakoshi	& Jason Valk
Lewis Black	Stephen & Cathy Graham	& Mark Temme	Wendy vanden Heuvel
Richard Blackstone	Emily Grishman	Patricia M. Murphy, Esq.	& Brad Coley
& Yldeez Yuksek	& Susan Sampliner	& Adam Spilka	Joe Versace
Tessa Blake & Ian Williams	David & Ann Hausmann	Fred Nelson	Gonzalo Vicente
Emily Blavatnik	Peter Herdrich	Randy & Rona Nelson	Grace Lyu-Volckhausen
Allison & Robert Blinken	& Karen Trott	Ruth Nelson	Borah & Mildred Walton
Rabbi Laurie	Megan Hollingshead	Rachel & Larry Norton	Lynn & Sam Waterston
& Andrew Braun	Sally Holmes & Doug Curtis	Lori O'Connor	Jane Bolster
John Carr & Patricia Carr	William Holtzman	Carol Ochs	& Steve Wertimer
Rachel Chanoff	& S. Sylvia Shepard	& Bruce MacVittie	Margaret Whitton
Kirk & Katherine Holt Citron	Katy Homans	Jacki Ochs & Jan Kroeze	& Warren Spector
Ruth Cohen & Bob Usdin	& Patterson Sims	Paul & Maria Onderdonk	Elizabeth Williams
Gayle Cohen Heller	Sarah Horowitz	Elizabeth Peters	& Joseph Forte
& David Heller	& David Venarde	Judy Goldman	Frank Wood
Cathy Dantchik	Gerald Howard	& Michael Pillinger	Joanne Woodward
Leslie Dantchik	Seymour & Felicia Jacobs	Doug Polley & Stacy Polley	& Paul Newman
Peter & Judith Dawkins	Whitney Scott	Christopher Randolph	Bill Wrubel
Neil & Carolyn DeSena	& Peter Jacobson	Peter & Helen Randolph	& Jennifer Crittenden
Marion & Alan Dienstag	Andrea Johnson	Willie Reale	Suzy Yengo
Jessica Doty	Douglas & Katie Jordan	& Jenny Gersten	



**RUN FOR YOUR LIVES!**

**THE DISASTER PLAYS**

**THE 2008 PLAYBACK PRODUCTION**

3 PLAYS WRITTEN BY KIDS, EACH ONE PERFORMED BY THE PLAYWRIGHT AND AN ADULT PARTNER/DIRECTOR

FRI., OCT. 24 AT 7:30 P.M.  
SAT., OCT. 25 AT 3:00 & 7:30 P.M.  
SUN., OCT. 26 AT 3:00 P.M.

**THE AXIS THEATRE**  
ONE SHERIDAN SQUARE  
(AT THE CORNER OF BARROW & WEST 4TH)

## RUN FOR YOUR LIVES: THE DISASTER PLAYS

The 2008 Playback Production - Oct. 24-26, 2008, The Axis Theatre

### The 52nd Street Project Staff

Gus Rogerson, Artistic Director  
Carol Ochs, Executive Director  
John Sheehy, Director of Development and Marketing  
George Babiak, Production Manager  
Reg Flowers, Associate Artistic Director  
Liz Bell, Director of Education  
Megan Cramer, Program Director  
Diana Rojas, Associate Program Director  
Josh Moody, Development Assistant  
Jan Gura, Capital Campaign Consultant  
Chris Ceraso, Teen Dean  
Iris A. Brown, Graphic Designer  
Muhammad Cunningham, Carla Oliva, Azalea Rosario, Teen Receptionists  
Jenisse Bouret, Angel Silva, Teen Homework Helpers  
Mordecai Santiago, Teen Playmaking Class Assistant  
Jenni Lerche, Intern

### "Run For Your Lives" Production Staff

Composer/Music Director Loren Toolajian	Backstage Crew George Babiak, Jenni Lerche, Melissa Rebolledo, Chanel Rodney
Set Designer Kevin Joseph Roach	Load-in and Light-hang Crew Ray Harold, Jason Hare, Doug Nervik, Jay Scott, Tom Schall
Lighting Designer Greg MacPherson	House Managers Liz Bell, Karin Schall, Mary-Pat Walsh
Costume Designers Ciera Wells	Chefs Liz Bell, John Sheehy
Sound Designer Betsy Rhodes	Bridghampton Guest Intern Courtney Fitzgerald
Stage Manager Casey Keeler	Bridghampton Hosts John Vassilaros, Alex Gersten- Vassilaros, and Tonio, Luka, and Stefano Vassilaros.
Slide Designs George Babiak, Josh Moody, and the Project Slide Archive	
Prop Design Team George Babiak, Megan Cramer	



The Playback Program is made possible with public funds from The New York State Council on the Arts, a state agency; and the New York City Department of Cultural Affairs. The 52nd Street Project is supported by funds from the National Endowment for the Arts. The Project is a member of ART/NY.

## COOL STUFF ON SALE IN THE LOBBY!

NEW! REPLAY SCRIPTS.....\$10.00  
FABULOUS FLYER BARS ..... \$2.50, \$2, \$1.50

AND FEATURING SHEL SILVERSTEIN'S  
"FIVEY AND TWOEY" LOGO:

PROJECT T-SHIRTS.....\$12.00  
PROJECT HOODIES.....\$30.00  
PROJECT CAPS.....\$20.00  
PROJECT MUGS .....\$5.00  
PROJECT PENCIL 3-PACK .....\$1.00  
PROJECT NOTEBOOK.....\$5.00

Thank you for coming to RUN FOR YOUR LIVES! If you are not on our mailing list (or if your address has changed), please fill out this form and give it to us on your way out or mail it to the address below. We would also like to know if you are interested in becoming a volunteer. We need help in all areas, so be sure to fill out the entire form.

PLEASE ADD ME TO YOUR MAILING LIST:

10/08

NAME \_\_\_\_\_

ADDRESS \_\_\_\_\_

CITY \_\_\_\_\_

STATE \_\_\_\_\_

ZIP \_\_\_\_\_

HOME PHONE \_\_\_\_\_

DAYTIME OR MOBILE PHONE \_\_\_\_\_

E-MAIL ADDRESS \_\_\_\_\_

MY OCCUPATION \_\_\_\_\_

MY HOBBIES \_\_\_\_\_

YES, I WOULD LIKE TO BE OF HELP. I CAN:

- |   |   |  |
|---|---|--|
| <input type="checkbox"/> Help load in and out for shows | <input type="checkbox"/> Draw and/or paint  | <input type="checkbox"/> Help kids with homework |
| <input type="checkbox"/> Hang lights                    | <input type="checkbox"/> Help with mailings | <input type="checkbox"/> Teach kids a skill      |
| <input type="checkbox"/> Work on a backstage crew       | <input type="checkbox"/> Do office work     | <input type="checkbox"/> Be a chef at an event   |
| <input type="checkbox"/> Do graphic design              | <input type="checkbox"/> Design sound       | <input type="checkbox"/> Design and sew costumes |
| <input type="checkbox"/> Other (please specify) _____   |   |  |

MY SCHEDULE IS:

- Very flexible. I'm often available during weekdays.  
 Somewhat flexible. I can help on the occasional morning or afternoon during the week.  
 Not very flexible at all, but I've got some free time on evenings and weekends.

If you would like to mail this (and you're always welcome to enclose a tax-deductible contribution), you can send it to: The 52nd Street Project, 500 West 52nd St., New York, NY 10019. Or fax it to (212) 333-5598.

**DON'T MISS OUR UPCOMING SHOWS!**

## **LEMMIE PUT IT THIS WAY, THE STRAIGHT TALK PLAYS**

The Fall Playmaking Production  
Dec. 5-7, 2008 at The Anspacher Theater,  
The Public Theater, 425 Lafayette St.

At this moment, the youngest Project kids are taking  
Reg Flowers' class in the fine art of Playmaking.  
Come see their final plays performed by  
professional actors in a big professional theater.

## **DON'T BE LATE! PLAYS ON TIME**



The Annual Two-on-Twos  
January 30-February 1, 2009 at The TBG Theater  
312 West 36th St.

There comes a time when every Project kid must stride onto a stage and do a show with another kid. In the Two-on-Two format we pair 6 teams of two kids with two adults: a playwright and a director. They have some experienced help as they start out, but on opening night they're on their own.



**BE ON THE LOOKOUT!  
WE ARE ALWAYS  
SEARCHING FOR INTERNS.**

If you know of any college or graduate students who might enjoy working with us, playing with us, and going on trips with us for a semester, please have them contact George Babiak or Megan Cramer. We are especially looking for interns for January-May, 2009. Thanks!

The 52nd Street Project Board of Directors

Ben Barenholtz	Noël Mihalow
Lisa Benavides	Carol Ochs
Rachel Chanoff	Willie Reale, founder
Cathy Dantchik	Gus Rogerson
Carolyn DeSena	Shirley Rumierk, alumni member
Wendy Ettinger, chair emeritus	José Soto, Jr., alumni member
Louis P. Friedman	Jenny Steingart
Stephen Graham, chair	Pamala Tyson
Larry Jones	Wendy vanden Heuvel
James McDaniel	John A. Vassilaros
Frances McDormand	

### What's Going On Here?

The 52nd Street Project is a non-profit organization that brings children from the Hell's Kitchen neighborhood together with professional theater artists to create original theater. RUN FOR YOUR LIVES is a production of our Playback program, in which kid actor/playwrights wrote plays for themselves and adult actor/director partners. Everyone ventured to the Hamptons for a rehearsal retreat over the Columbus Day weekend. All of the kids involved are veterans of the Playmaking classes which were adapted for the Project by Daniel Judah Sklar from his book Playmaking: Children Writing and Performing Their Own Plays.

### In-Kind Contributions

The Murphy Law Office; Abbeville Press; Stephanie Berger Photography; Iris A. Brown Design; Carmine Campisi & Graphic Lab; Kenneth Cole Productions; William Curran & A Curran Affair; Diageo Chateau & Estate Wines Co.; Fresh; ICI; La Mer; New Line Cinema; Newman's Own; Noggin/The N; Parfums Givenchy & Guerlain; Paris Chocolates; Pharma Print/Omni Graphics; Sesame Workshop; Wendy Stuhlberg; John A. Vassilaros; Watkins, Inc.; Mayor's Office of Film & Television; Boylan's Bottling Co.; Lorraine Tobias & Imaginary Studios; Shapiro & Lobel; Hudson Scenic; Prime Films, and Paul, Weiss, Rifkind, Wharton & Garrison LLP.

### Special Thanks

We're extremely grateful to John Vassilaros, Alex Gersten-Vassilaros, their boys Tonio, Luka and Stefano, and the ever-helpful Joyce for allowing us to use their home as our headquarters on our rehearsal trip to the Hamptons. Thanks also to Louis and Patrice Friedman, who let some of our volunteers crash at their beach pad.

# RUN FOR YOUR LIVES: THE DISASTER PLAYS - ACT 1

All original music composed by Loren Toolajian

## VAMPIRE HOTEL

Written by Jamie Yip, age 12.  
Director/Dramaturge: Alexis McGuinness.

Wendy Lincoln ..... Jamie Yip  
Wendy Whatshername ..... Alexis McGuinness  
Guy from Dominos ..... Chanel Rodney  
Sorry to Be Friends lyrics by Jamie Yip.

## NEVER TRUST YOUR INSTINCTS

Written by Armando Cosme, Jr., age 13.  
Director/Dramaturge: Brad Aldous.

Booger Mousehead ..... Armando Cosme, Jr.  
Jack Lightfan ..... Brad Aldous  
Bar Lady/Pay-O-Matic Lady ..... Megan Cramer  
Together; Please; and Back Together lyrics by Armando Cosme, Jr.

## THE UNTOLD STORIES

Written by Kevin Kulego, age 12.  
Director/Dramaturge: Lauren Blumenfeld.

Jason ..... Kevin Kulego  
Jackie ..... Lauren Blumenfeld  
Boss ..... Jenni Lerche  
Soldiers ..... Melissa Rebolledo & Chanel Rodney  
The Want Need and The Need Want lyrics by Kevin Kulego.

## GO! GO! GO!

Written by Breanna Straker, age 12.  
Director/Dramaturge: Christine Grenier.

Lisa ..... Breanna Straker  
Rebecca ..... Christine Grenier  
Teacher ..... Jenni Lerche  
Chipmonk ..... Megan Cramer  
Cheer; Sadness; Silliness; and I'm Better Than You lyrics by Breanna Straker.



# RUN FOR YOUR LIVES: THE DISASTER PLAYS - ACT 2

## THE CAUSE

Written by Kara Thiam, age 13.  
Director/Dramaturge: Josh Moody.

Golar ..... Kara Thiam  
Ware ..... Josh Moody  
Dad ..... John Sheehy  
Boss ..... George Babiak

Lie lyrics by Kara Thiam.

## DREAMS DO REALLY HAPPEN

Written by Luz Maldonado, age 15.  
Director/Dramaturge: Reg Flowers.

Isabell ..... Luz Maldonado  
Dad ..... Reg Flowers  
Voice/Christine ..... Megan Cramer  
Where, Oh Where and The Gates Are Open lyrics by Luz Maldonado.

## PURPOSES O'PURPOSES

Written by Luisa Santiago, age 13.  
Director/Dramaturge: Annie Henk.

Jess ..... Luisa Santiago  
Courtney ..... Annie Henk  
Hot Dog Guy/Emergency Staff ..... George Babiak  
Explosions Ruin Everything and Forgiveness lyrics by Luisa Santiago.

## THE BULLY

Written by Andy Reyes, age 12.  
Director/Dramaturge: Kevin Dwyer.

Edward ..... Andy Reyes  
Steven ..... Kevin Dwyer  
Ms. Bloomsbury ..... Jenni Lerche  
Counselor ..... John Sheehy  
School kids ..... The Crew  
Bullies, Ooh Ooh Ahh Ahh Yesss; and Apologize/Still be Friends lyrics by Andy Reyes.



The 52nd Street Project gratefully acknowledges the support of the following foundations and corporations: The Altman Foundation; Bloomberg; BKS Architects; The Brenner Family Foundation; Carnegie Corporation of New York; CBS Corporation; Consolidated Edison; The Dermot Company, Inc.; The Dramatists Guild Fund; Dramatists Play Service; Office of Thomas K. Duane; Eleanor, Adam & Mel Dubin Foundation; The Educational Foundation of America; Sidney E. Frank Foundation; Friars National Foundation; The Horace W. Goldsmith Foundation; Green Apple Entertainment, Inc.; Saul Horowitz, Jr. Fund; Hudson Scenic Studio; Hurlbut Family Charitable Lead Trust; JKW Foundation; Lemberg Foundation, Inc.; Lloyds TSB Bank plc; James A. Macdonald Foundation; Ann M. Martin Foundation; Mellon Equity Associated, Llp; LuEsther T. Mertz Foundation; Newman's Own; The New York Times Company Foundation; NYFA; Tony Randall Theatrical Fund; Jonathan Rose Companies; St. Vincent De Paul Foundation; Sallie Mae Fund; Savoy Bank; Peter Schoenfeld Asset Management; Sesame Workshop; Shapiro & Lobel; The Shubert Organization; The Starker Family Foundation; The Surdna Foundation; Susquehanna Foundation, Corp.; Tax Pro Financial Network, Inc.; Tiger Baron Foundation; Van Deusen Family Fund; John A. Vassilaros & Son, Inc.; The Vervane Foundation; Law Offices of Claudia Wagner; Watkins, Inc.; We Of Little Faith; I. Weiss & Sons, Inc.; The Wiener Family Foundation; Yorke Construction Corp. In addition, the following individuals made gifts over \$250 to The 52nd Street Project this past year. (list current as of 8/10/08):

Raymond & Elizabeth Abbott	Richard Dresser	Cindy Kaplan	Jennifer Reichle
Robert Abrams	& Rebecca Dresser	& David Froelich	Jacquelyn Reingold
& Cynthia Vance	Wendy Ettinger	Janet Kleinberg	David Ross & Laura Ross
May Ameen	& Derek McLane	Judy Kuhn & David Schwab	Daryl Roth
Lisa Andrade-Hicks	Andrew Farach-Colton	Warren Leight	Karin & Tom Schall
Emily Armstrong	& Martin Farach-Colton	Mickey Lemle	George Schieferdecker
& Patrick Gannon	Peter Jay Fernandez	Joshua Lewis & Sarah Kay	Robert Schnur
James Auron	& Denise Burse	Barbara Locker	Robert Shaffron
Dylan & Becky Baker	Liz Flahive & Jeff Cox	& Penny Zuckerwise	& John Davis
Ben Barenholtz	Alison Fraser & Nat Magee	Michael & Marjorie Loeb	Neal Shapiro
Jessica Bauman	Beverly Gasner	Edith Lutnick	& Hyunju Chang
& Ben Posel	Rose Gasner	John Lyons	Meg Simon
Laurie Becker	& Larry Chertoff	Greg MacPherson	Tom Slaughter
Michael Bell & Carol Bell	Cora Cahan	& Jane Perlmutter	Jenny & Jon Steingart
Lisa Benavides	& Bernard Gersten	Ian Madover	Richard Sweren
& Tim Nelson	Jilian Gersten	& Arielle Madover	Anne Tilney
Gavin Berger	& Brian Shuman	Jennifer Manocherian	& Douglas Kaden
& Craig Berggren	Alexandra	Frances McDormand	Liz Tuccillo
Stephanie Berger	Gersten-Vassilaros	& Joel Coen	Pamala & Sean Tyson
& Paul King	& John A. Vassilaros	Noël & Joe Mihalow	Laura Valeroso
Elizabeth	Nancy Giles	Emily & John Morgan	& David Seidman
& Alexander Bernstein	Jessalyn Gilsig	Erin Moriarty	Josephine Eke
Stephen Bernstein	Richard Gottfried	Suzen Murakoshi	& Jason Valk
Lewis Black	Stephen & Cathy Graham	& Mark Temme	Wendy vanden Heuvel
Richard Blackstone	Emily Grishman	Patricia M. Murphy, Esq.	& Brad Coley
& Yldeez Yuksek	& Susan Sampliner	& Adam Spilka	Joe Versace
Tessa Blake & Ian Williams	David & Ann Hausmann	Fred Nelson	Gonzalo Vicente
Emily Blavatnik	Peter Herdrich	Randy & Rona Nelson	Grace Lyu-Volckhausen
Allison & Robert Blinken	& Karen Trott	Ruth Nelson	Borah & Mildred Walton
Rabbi Laurie	Megan Hollingshead	Rachel & Larry Norton	Lynn & Sam Waterston
& Andrew Braun	Sally Holmes & Doug Curtis	Lori O'Connor	Jane Bolster
John Carr & Patricia Carr	William Holtzman	Carol Ochs	& Steve Wertimer
Rachel Chanoff	& S. Sylvia Shepard	& Bruce MacVittie	Margaret Whittton
Kirk & Katherine Holt Citron	Katy Homans	Jacki Ochs & Jan Kroeze	& Warren Spector
Ruth Cohen & Bob Usdin	& Patterson Sims	Paul & Maria Onderdonk	Elizabeth Williams
Gayle Cohen Heller	Sarah Horowitz	Elizabeth Peters	& Joseph Forte
& David Heller	& David Venarde	Judy Goldman	Frank Wood
Cathy Dantchik	Gerald Howard	& Michael Pillinger	Joanne Woodward
Leslie Dantchik	Seymour & Felicia Jacobs	Doug Polley & Stacy Polley	& Paul Newman
Peter & Judith Dawkins	Whitney Scott	Christopher Randolph	Bill Wrubel
Neil & Carolyn DeSena	& Peter Jacobson	Peter & Helen Randolph	& Jennifer Crittenden
Marion & Alan Dienstag	Andrea Johnson	Willie Reale	Suzy Yengo
Jessica Doty	Douglas & Katie Jordan	& Jenny Gersten	

## The 52nd Street Project Presents

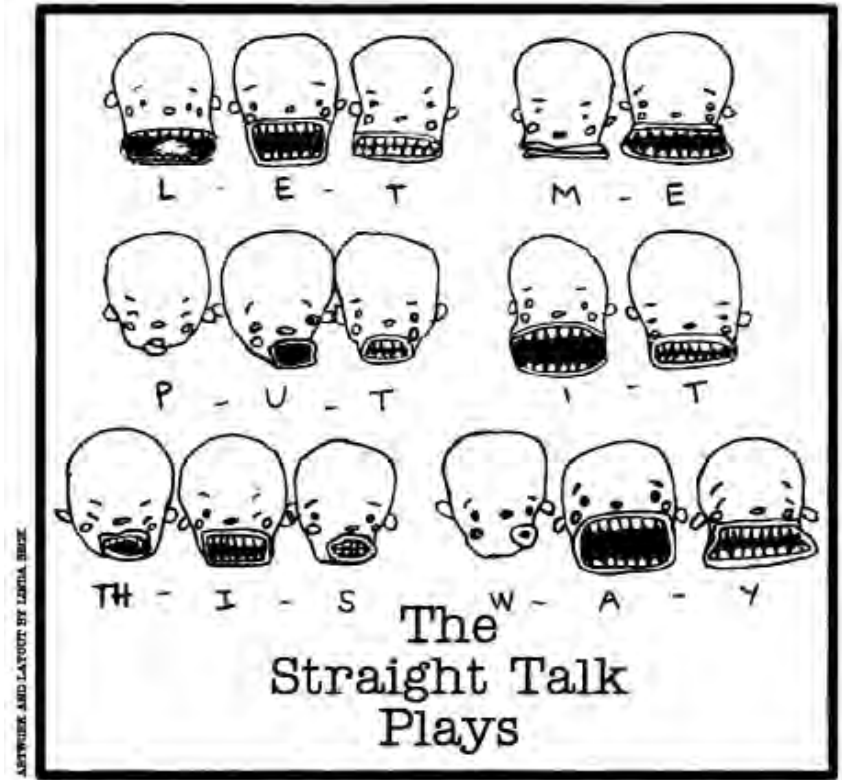

## The Fall 2008 Playmaking Show

The Anspacher Theater  
at the Public Theater

425 Lafayette St.  
Between Astor Place and East 4th St.

# Let Me Put It This Way: The Straight Talk Plays

The Fall 2008 Playmaking Production - Dec. 5-7, 2008, The Public Theater

## The 52nd Street Project Staff

Gus Rogerson, Artistic Director  
Carol Ochs, Executive Director  
John Sheehy, Director of Development and Marketing  
George Babiak, Production Manager  
Reg Flowers, Associate Artistic Director  
Liz Bell, Director of Education  
Megan Cramer, Program Director  
Diana Rojas, Associate Program Director  
Josh Moody, Development Assistant  
Jan Gura, Capital Campaign Consultant  
Chris Ceraso, Teen Dean  
Iris A. Brown, Graphic Designer  
Muhammad Cunningham, Carla Oliva, Azalea Rosario, Teen Receptionists  
Jenisse Bouret, Angel Silva, Teen Homework Helpers  
Mordecai Santiago, Teen Playmaking Class Assistant  
Jenni Lerche, Intern

## "Let Me Put It This Way" Production Staff

Composer/Music Director Patrick Barnes	Prop Design Team George Babiak, Megan Cramer, Patrick Jones, John Sheehy
Set Designer Kevin Joseph Roach	Backstage Crew Alvin Garcia, Casey Keeler, Ginny Lee, Jenni Lerche, David Paarlberg, Malik Velazquez
Lighting Designers Greg MacPherson & Lauren Parrish	Load-in and Light-hang Crew Jason Hare, Bruce MacVittie
Costume Designers Crystal Thompson & Chris Rumery	House Managers Liz Bell, Karin Schall
Costume Assistants Nancy Thompson & Mark Romer	Flyer Art: Linda Beck
Sultan of Sound Maury Schott	Chefs Joe White, Iris Brown, Megan Cramer, Diana Rojas, Jenni Lerche
Stage Manager Rachel Bauder	Class Volunteers Josh Bywater, Jason Hare, Alexandra O'Daly, Katie Rubin
Slide Designs George Babiak, Patrick Jones, and the Project Slide Archive	
Fight Choreographer: Tom Schall	



The Playback Program is made possible with public funds from The New York State Council on the Arts, a state agency; and the New York City Department of Cultural Affairs. The 52nd Street Project is supported by funds from the National Endowment for the Arts. The Project is a member of ART/NY.

## COOL STUFF ON SALE IN THE LOBBY!

NEW! REPLAY SCRIPTS.....\$10.00  
FABULOUS FLYER BARS ..... \$2.50, \$2, \$1.50

AND FEATURING SHEL SILVERSTEIN'S  
"FIVEY AND TWOEY" LOGO:

PROJECT T-SHIRTS.....\$12.00  
PROJECT HOODIES.....\$30.00  
PROJECT CAPS.....\$20.00  
PROJECT MUGS .....\$5.00  
PROJECT PENCIL 3-PACK .....\$1.00  
PROJECT NOTEBOOK.....\$5.00

Thank you for coming to LET ME PUT IT THIS WAY! If you are not on our mailing list (or if your address has changed), please fill out this form and give it to us on your way out or mail it to the address below. We would also like to know if you are interested in becoming a volunteer. We need help in all areas, so be sure to fill out the entire form.

PLEASE ADD ME TO YOUR MAILING LIST:

12/08

NAME \_\_\_\_\_

ADDRESS \_\_\_\_\_

CITY \_\_\_\_\_

STATE \_\_\_\_\_

ZIP \_\_\_\_\_

HOME PHONE \_\_\_\_\_

DAYTIME OR MOBILE PHONE \_\_\_\_\_

E-MAIL ADDRESS \_\_\_\_\_

MY OCCUPATION \_\_\_\_\_

MY HOBBIES \_\_\_\_\_

YES, I WOULD LIKE TO BE OF HELP. I CAN:

- |   |   |  |
|---|---|--|
| <input type="checkbox"/> Help load in and out for shows | <input type="checkbox"/> Draw and/or paint  | <input type="checkbox"/> Help kids with homework |
| <input type="checkbox"/> Hang lights                    | <input type="checkbox"/> Help with mailings | <input type="checkbox"/> Teach kids a skill      |
| <input type="checkbox"/> Work on a backstage crew       | <input type="checkbox"/> Do office work     | <input type="checkbox"/> Be a chef at an event   |
| <input type="checkbox"/> Do graphic design              | <input type="checkbox"/> Design sound       | <input type="checkbox"/> Design and sew costumes |
| <input type="checkbox"/> Other (please specify) _____   |   |  |

MY SCHEDULE IS:

- Very flexible. I'm often available during weekdays.  
 Somewhat flexible. I can help on the occasional morning or afternoon during the week.  
 Not very flexible at all, but I've got some free time on evenings and weekends.

If you would like to mail this (and you're always welcome to enclose a tax-deductible contribution), you can send it to: The 52nd Street Project, 500 West 52nd St., New York, NY 10019. Or fax it to (212) 333-5598.



**DON'T MISS OUR UPCOMING SHOWS!**

# **DON'T BE LATE!**

## **PLAYS ON TIME**



The Annual Two-on-Twos  
January 30-February 1, 2009 at The TBG Theater  
312 West 36th St.

There comes a time when every Project kid must stride onto a stage and do a show with another kid. In the Two-on-Two format we pair 6 teams of two kids with two adults: a playwright and a director. They have some experienced help as they start out, but on opening night they're on their own.



## **Can Do!**

### **Plays on the Bright Side**

The Spring Playmaking Production  
Late March or early April, 2009 at  
a theater to be announced.

In January, the youngest Project kids will begin Reg Flowers' next class in the fine art of Playmaking. Come see their final plays performed by professional actors in a big professional theater just like this one!



**BE ON THE LOOKOUT!**  
**WE ARE ALWAYS**  
**SEARCHING FOR INTERNS.**

If you know of any college or graduate students who might enjoy working with us, playing with us, and going on trips with us for a semester, please have them contact George Babiak or Megan Cramer. We are especially looking for interns for January-May, 2009. Thanks!

### The 52nd Street Project Board of Directors

Ben Barenholtz	Noël Mihalow
Lisa Benavides	Carol Ochs
Rachel Chanoff	Willie Reale, founder
Cathy Dantchik	Gus Rogerson
Carolyn DeSena	Shirley Rumierk, alumni member
Wendy Ettinger, chair emeritus	José Soto, Jr., alumni member
Louis P. Friedman	Jenny Steingart
Stephen Graham, chair	Pamala Tyson
Larry Jones	Wendy vanden Heuvel
James McDaniel	John A. Vassilaros
Frances McDormand	

### What's Going On Here?

The 52nd Street Project is a non-profit organization that brings children from the Hell's Kitchen neighborhood together with professional theater artists to create original theater. LET ME PUT IT THIS WAY is a production of our Playmaking program. Young people participate in a nine-week playwriting course taught by Reg Flowers and adapted for the Project by Daniel Judah Sklar from his book Playmaking: Children Writing and Performing Their Own Plays. At the end of the course, each child is given two actors, a theme, and a dramaturg/director who guides him or her through the writing of a play during a weekend retreat in the country (Stone Ridge, New York, for this show). Tonight's performance is the end result.

### In-Kind Contributions

The Murphy Law Office; Abbeville Press; Stephanie Berger Photography; Iris A. Brown Design; Carmine Campisi & Graphic Lab; Kenneth Cole Productions; William Curran & A Curran Affair; Diageo Chateau & Estate Wines Co.; Fresh; ICI; La Mer; New Line Cinema; Newman's Own; Noggin/The N; Parfums Givenchy & Guerlain; Paris Chocolates; Pharma Print/Omni Graphics; Sesame Workshop; Wendy Stuhlberg; John A. Vassilaros; Watkins, Inc.; Mayor's Office of Film & Television; Boylan's Bottling Co.; Lorraine Tobias & Imaginary Studios; Shapiro & Lobel; Hudson Scenic; Prime Films, and Paul, Weiss, Rifkind, Wharton & Garrison LLP.

### Special Thanks

We're extremely grateful to Steve Gorn, Barbara Bash and their son Wiley, for the use of their beautiful home in Stone Ridge, NY as our base of operations for the writer's retreat. The indispensable host families were Joe White & Iris Brown (who doubled as chefs), Laura Shaine Cunningham, Elaine Musselman, Deborah Freedman & Bill Woods, Charles Miles & Naomi Freundlich, Mary Louise Wilson, Denny Dillon and David Curtis & Anne Morris. Finally, we must express our profound thanks to Oskar Eustis, Jenny Gersten, Maria Goyanes, Bethany Ford, and everyone else at the amazing Public Theater.

## Let Me Put It This Way - ACT 1

All original music composed by Patrick Barnes

### BEST FRIENDS

Written by Diamond Deanna Graves, age 9.

Director/Dramaturge: Maria Goyanes Dramaturge: Diana Rojas.

Emily.....Zenzele Cooper

Sara.....Sharon Washington

Emily's Friends.....The Crew

Best Friends Forever lyrics by Diamond Deanna Graves.

### JOSH'S ANGEL

Written by Kenneth J. Smith, age 11.

Director/Dramaturge: John Sheehy.

Josh.....Tom Riis Farrell

Henry.....Sevan Greene

Mom.....Kathy Hiler

Hoo Ha Ya lyrics by Kenneth J. Smith.

### THE CUPCAKE MASTER INTERVIEW

Written by Samantha Paduani, age 9.

Director/Dramaturge: Maureen Towey.

Katie.....Celia Keenan-Bolger

Pratrisha.....James Yaegashi

Happy and The Love Song lyrics by Samantha Paduani.

### THE DIMENSION TRAVELER AND THE WHITE DWARF

Written by Jeremy Sanchez, age 11.

Director/Dramaturge: Sarah Cameron Sunde.

Jason.....Kenajuan Bentley

Sunny.....Uzo Aduba

Sun.....Malik Velazquez

### WHEN ALEX WANTS A FRIEND

Written by Jasmine Hernandez, age 11.

Director/Dramaturge: Nicole Watson.

Alex.....Keira Naughton

Ryan.....Tim Cain

Kids.....Malik Velazquez and Alvin Garcia

I Can't Help Myself, Everybody is Scared of Me, and Friends to the End lyrics by Jasmine Hernandez.

## Let Me Put It This Way - ACT 2

### THE LAST MATCH

Written by Besart Bequiri, age 11.

Director/Dramaturge: Felix Solis.

Mel.....Armando Riesco

Jack.....Kevin Geer

Bartender/Ref.....John Sheehy

Serbian.....Jake Hart

### VENGEANCE FRIENDSHIP

Written by Gerardo Escamilla, age 11.

Director/Dramaturge: Jonathan Bernstein.

Penny.....Mary Catherine Garrison

Bill Billionaire.....John Ellison Conlee

Lucky.....George Babiak

Announcer.....Jonathan Bernstein

Penny's Dream Song & Bill Flipping Dream lyrics by Gerardo Escamilla.

### DRAMA

Written by Alizette Zapata, age 10.

Director/Dramaturge: Davis McCallum.

Steven.....Peter Dinklage

Chassity.....Jessica Hecht

Guy at Club Exit.....Josh Moody

The Popo.....Alvin Garcia

Club people, studio dancers.....The Crew

Brother and Sis lyrics by Alizette Zapata.

### THE POPULAR ONE

Written by Tiara Varela, age 10.

Director/Dramaturge: Leslie Kramer.

Yasmine.....Sue Jean Kim

Casey.....Kathy Hiler

Harry.....Megan Cramer

I Don't Know, I Remember and Sorry lyrics by Tiara Varela.

### HAVE THE BIG FIGHT WITH MY SISTER

Written by Aidan Martinez, age 10.

Director/Dramaturge: Rick Meese.

Ashely.....Nancy Giles

Adrian.....Joe White

The We Get Along Song lyrics by Aidan Martinez.

The 52nd Street Project gratefully acknowledges the support of the following foundations and corporations: The Altman Foundation; Ann M. Martin Foundation; AON; APA Talent & Literary Agency; Big Wood Foundation; BKSK Architects; Bloomberg; The Brenner Family Foundation; Carnegie Corporation of New York; CBS Corporation; CMR Comedy; Consolidated Edison; Department of Cultural Affairs; The Dermot Company, Inc.; The Dramatists Guild Fund; Dramatists Play Service; Eleanor, Adam & Mel Dubin Foundation; The Educational Foundation of America; Sidney E. Frank Foundation; Friars National Foundation; The Horace W. Goldsmith Foundation; Green Apple Entertainment; The William and Mary Greve Foundation; Holland Lodge Foundation, Inc.; Saul Horowitz, Jr. Fund; JKW Foundation; Lemle Pictures, Inc.; Lloyds TSB Bank plc; James A. Macdonald Foundation; LuEsther T. Mertz Foundation; Mellon Equity Associated, Llp; J.P. Morgan Charitable Trust; Newman's Own; The New York Times Company Foundation; NYSOA; NYFA; Provident Foundation; Jonathan Rose Companies; Savoy Bank; Sesame Workshop; Shapiro & Lobel; The Shubert Organization; St. Vincent De Paul Foundation; Starker Family Foundation; Stranahan Foundation; Harold & Mimi Steinberg Charitable Trust; The Surdna Foundation; Susquehanna Foundation, Corp.; Tax Pro Financial Network, Inc.; Theatre Communications Group, Inc.; Tony Randall Theatrical Fund; Van Deusen Family Fund; John A. Vassilaros & Son, Law Offices of Claudia Wagner; Watkins, Inc.; I. Weiss & Sons, Inc.; Wiener Family Foundation; Yorke Construction Corp.Inc. In addition, the following individuals made gifts over \$250 to The 52nd Street Project this past year. (list current as of 1/30/09):

Anonymous	Wendy Ettinger	Harold Levison & Ilyse Levison	Jennifer Reichle
Raymond & Elizabeth Abbott	& Derek McLane	Joshua Lewis & Sarah Kay	Jacquelyn Reingold
Robert Abrams	Andrew Farach-Colton	Barbara Locker	Ira Resnick
& Cynthia Vance	& Martin Farach-Colton	& Penny Zuckerwise	David Ross & Laura Ross
May Ameen	Peter Jay Fernandez	Michael & Marjorie Loeb	Daryl Roth
Lisa Andrade-Hicks	& Denise Burse	Mark Lanow & Joanne Astrow	Robert Saget
Emily Armstrong	Suzanne Fine	Edith Lutnick	Karin & Tom Schall
& Patrick Gannon	& Christian Salomone	John Lyons	Robert Shaffron & John Davis
Dylan & Becky Baker	Angelina Fiordellisi	Greg MacPherson	Neal Shapiro & Hyunju Chang
Ben Barenholtz	& Matt Williams	& Jane Perlmutter	Jonathan Sheffer
Jessica Bauman & Ben Posel	Peter Fisch & Jill Levy Fisch	Ian Madover & Arielle Madover	Peter Shinoda
Michael Bell & Carol Bell	Liz Flahive & Jeff Cox	Drew McCoy & Amy Aquino	Meg Simon
Lisa Benavides & Tim Nelson	Rose Fraser & Nat Magee	Jennifer Manocherian	Tom Slaughter
Gavin Berger	Alison Gasner & Larry Chertoff	Frances McDormand	Robert Smigel
& Craig Berggren	Freddie Gershon	& Joel Coen	& Michelle Smigel
Elizabeth & Alexander	Jilian Gersten & Brian Shuman	Ann McLarty & Chuck Knauss	Steven Starker & Farrell
Velazquez Bernstein	Nancy Giles	Josie Merck & Jim Stevenson	Starker
Stephen Bernstein	Jessalyn Gilsig	Noël & Joe Mihalow	Jean Stein
Kerrison Black	James Gosnell	Emily & John Morgan	Jenny & Jon Steingart
Lewis Black	Richard Gottfried	Erin Moriarty	Michael & Marjorie Stern
Richard Blackstone	Stephen & Cathy Graham	Suzen Murakoshi	David Suehsdorf
& Yldez Yuksek	Emily Grishman & Susan	& Mark Temme	& Janet E. Muir
Tessa Blake & Ian Williams	Sampliner	Patricia M. Murphy, Esq. &	Richard Sweren
Lawrence Blau	David & Ann Hausmann	Adam Spilka	Liz Tuccillo
Emily Blavatnik	Peter Herdrich & Karen Trott	John Mustin & Kimberly Mustin	Pamala & Sean Tyson
Allison & Robert Blinken	Sally Holmes & Doug Curtis	Fred Nelson	Laura Valeroso
Rachel Chanoff	William Holtzman	Randy & Rona Nelson	& David Seidman
Kirk & Katherine Holt Citron	& S. Sylvia Shepard	Ruth Nelson	John A. Vassilaros
Ronald Cohen	Katy Homans	James Neuberger	& Alexandra Gersten
Ruth Cohen & Bob Usdin	& Patterson Sims	& Helen Stambler	Wendy vanden Heuvel
Gayle Cohen Heller	Sarah Horowitz	Cynthia Nixon	& Brad Coley
& David Heller	& David Venarde	Rachel & Larry Norton	Carol L. Nadell
Judith-Ann Corrente	Gerald Howard	Lori O'Connor	& Richard E. Van Deusen
Billy Crudup	Seymour & Felicia Jacobs	Carol Ochs & Bruce MacVittie	Joe Versace
Cathy Dantchik	Whitney Scott & Peter	Jacki Ochs & Jan Kroeze	Borah & Mildred Walton
Leslie Dantchik	Jacobson	Paul & Maria Onderdonk	Jane Bolster & Steve Wertimer
Peter & Judith Dawkins	Andrea Johnson	Elizabeth Peters	Michael & Zena Wiener
Neil DeSena	Douglas & Katie Jordan	Peter & Ana Rosa Phillips	Elizabeth Williams
& Carolyn DeSena	Maurice Kanbar	Judy Goldman	& Joseph Forte
Kenny Dichter	Cindy Kaplan & David Froelich	& Michael Pillingier	Geoffrey Wills
Marion & Alan Dienstag	Janet Kleinberg	Doug Polley & Stacy Polley	Frank Wood
Jessica Doty	Judy Kuhn & David Schwab	Christopher Randolph	Bill Wrubel
Richard & Rebecca Dresser	Jonathan Lefkowitz	Peter & Helen Randolph	& Jennifer Crittenden
Adam Dubin & Rochelle Dubin	Warren Leight	Willie Reale & Jenny Gersten	Suzu Yengo

THE 52ND STREET PROJECT  
PRESENTS

6 NEW PLAYS  
6 ADULT  
WRITERS  
6 ADULT  
DIRECTORS  
12 KID  
ACTORS

**DON'T BE LATE!**  
**PLAYS ON TIME**

THE 2009  
TWO-ON-TWOS

ILLUSTRATION BY RYTHON JONES

**January 30 - February 1, 2009**

**TBG THEATRE**  
**312 West 36th St.**

## Don't Be Late! Plays on Time

The 2009 Two-on-Twos - January 30 - February 1, TBG Theatre

### The 52nd Street Project Staff

Gus Rogerson, Artistic Director  
 Carol Ochs, Executive Director  
 John Sheehy, Director of Development and Marketing  
 George Babiak, Production Manager  
 Reg Flowers, Associate Artistic Director  
 Liz Bell, Director of Education  
 Megan Cramer, Program Director  
 Diana Rojas, Associate Program Director  
 Josh Moody, Development Assistant  
 Jan Gura, Capital Campaign Consultant  
 Chris Ceraso, Teen Dean  
 Iris A. Brown, Graphic Designer  
 Carla Olivia, Azalea Rosario, Angel Silva, Teen Receptionists  
 Jenisse Bouret, Fivey Magazine Teen Editor  
 Mordecai Santiago, Teen Playmaking Class Assistant  
 Alex Solomon, Shane West, Interns

### Production Staff

#### Composer/Music Director

Karl Mansfield

#### Set Designer

Kevin Joseph Roach

#### Lighting Designer

Burke Brown

#### Costume Designer

Sarita Fellows

#### Sound Designer

Maileen Cancel

#### Stage Manager

Carol Sullivan

#### Slide Designs

The Project Slide Archive

#### Prop Design Team

George Babiak, Josh Moody,  
 John Sheehy, Alex Solomon

#### Backstage Crew

Jason Hare, Alex Solomon,  
 Shane West, Andy Reyes,  
 Hashem Ahmed

#### Load-in and Light-hang Crew

Scott Bolman, Jason Hare,  
 Ray Harold, Doug Nervik,  
 Tom Schall, Chuck Turner

#### House Managers

Liz Bell, Karin Schall

#### Flyer/Program Art:

Patrick Jones

#### Chefs

John Sheehy, Liz Bell,  
 Carol Ochs



The Two-on-Two Program is made possible with public funds from The New York State Council on the Arts, a state agency; and the New York City Department of Cultural Affairs. The 52nd Street Project is supported by funds from the National Endowment for the Arts. The 52nd Street Project is a member of Art/NY and a participant in the New Generations Program, funded by Doris Duke Charitable Foundation/The Andrew W. Mellon Foundation and administered by Theatre Communications Group, the national organization for the American Theater.

## COOL STUFF ON SALE IN THE LOBBY!

REPLAY SCRIPT ANTHOLOGY .....\$10.00  
 FABULOUS FLYER BARS ..... \$2.50, \$2, \$1.50

AND FEATURING SHEL SILVERSTEIN'S  
 "FIVEY AND TWOEY" LOGO:

PROJECT T-SHIRTS.....\$12.00  
 PROJECT HOODIES.....\$30.00  
 PROJECT CAPS.....\$20.00  
 PROJECT MUGS .....\$5.00  
 PROJECT PENCIL 3-PACK .....\$1.00  
 PROJECT NOTEBOOK.....\$5.00

Thank you for coming to Don't Be Late! If you are not on our mailing list (or if your address has changed), please fill out this form and give it to us on your way out or mail it to the address below. We would also like to know if you are interested in becoming a volunteer. We need help in all areas, so be sure to fill out the entire form.

PLEASE ADD ME TO YOUR MAILING LIST:

01/09

NAME \_\_\_\_\_

ADDRESS \_\_\_\_\_

CITY \_\_\_\_\_

STATE \_\_\_\_\_

ZIP \_\_\_\_\_

HOME PHONE \_\_\_\_\_

DAYTIME OR MOBILE PHONE \_\_\_\_\_

E-MAIL ADDRESS \_\_\_\_\_

MY OCCUPATION \_\_\_\_\_

MY HOBBIES \_\_\_\_\_

YES, I WOULD LIKE TO BE OF HELP. I CAN:

- |   |   |  |
|---|---|--|
| <input type="checkbox"/> Help load in and out for shows | <input type="checkbox"/> Draw and/or paint  | <input type="checkbox"/> Help kids with homework |
| <input type="checkbox"/> Hang lights                    | <input type="checkbox"/> Help with mailings | <input type="checkbox"/> Teach kids a skill      |
| <input type="checkbox"/> Work on a backstage crew       | <input type="checkbox"/> Do office work     | <input type="checkbox"/> Be a chef at an event   |
| <input type="checkbox"/> Do graphic design              | <input type="checkbox"/> Design sound       | <input type="checkbox"/> Design and sew costumes |
| <input type="checkbox"/> Other (please specify) _____   |   |  |

MY SCHEDULE IS:

- Very flexible. I'm often available during weekdays.  
 Somewhat flexible. I can help on the occasional morning or afternoon during the week.  
 Not very flexible at all, but I've got some free time on evenings and weekends.

If you would like to mail this (and you're always welcome to enclose a tax-deductible contribution), you can send it to: The 52nd Street Project, 500 West 52nd St., #2E, New York, NY 10019. Or fax it to (212) 333-5598.

**DON'T MISS OUR UPCOMING SHOWS!**



## Can Do! Plays on the Bright Side

The Spring Playmaking Production

This month, the youngest Project kids began Reg Flowers' class in the fine art of Playmaking.

Come see their final plays performed by professional actors in a big professional theater.

## PACKING PEANUTS A MOVING EXPERIENCE

This year, the annual benefit celebrates the transition into the state-of-the-art new headquarters of the Project, scheduled for this summer. Come see fabulous performers do kids' tributes to our future home!



**MONDAY, MAY 11, 2009**

At Espace - West 42nd Street between 10th and 11th Ave.

(It's NOT the new space, but it's a pretty nice place to have a benefit.)

Call John "Handtruck" Sheehy at (212) 333-5252 or write him at sheehy@52project.org to reserve your place!



**BE ON THE LOOKOUT!**  
**WE'RE ALWAYS SEARCHING FOR INTERNS.**

If you know any college or graduate students who might enjoy working with us, playing with us, and going on trips with us for a semester, please have them contact George Babiak or Megan Cramer. We are currently seeking interns for June-August, 2009.

### The 52nd Street Project Board of Directors

Ben Barenholtz	Noël Mihalow
Lisa Benavides	Carol Ochs
Rachel Chanoff	Willie Reale, founder
Cathy Dantchik	Gus Rogerson
Carolyn DeSena	Shirley Rumierk, alumni member
Wendy Ettinger, chair emeritus	José Soto, Jr., alumni member
Louis P. Friedman	Jenny Steingart
Stephen Graham, chair	Pamala Tyson
Larry Jones	Wendy vanden Heuvel
James McDaniel	John A. Vassilaros
Frances McDormand	

### What's Going On Here?

The 52nd Street Project is a non-profit organization that brings children from the Hell's Kitchen neighborhood together with professional theater artists to create original theater. DON'T BE LATE! is a production of our Two-on-Two's program, in which an adult playwright crafts a piece for a pair of Project kids to perform. Another adult directs the kids for a month that includes an intensive three-day weekend in upstate New York. Tonight's performance is the final result.

### In-Kind Contributions

The Murphy Law Office; Abbeville Press; Stephanie Berger Photography; Iris A. Brown Design; Carmine Campisi & Graphic Lab; Kenneth Cole Productions; William Curran & A Curran Affair; Diageo Chateau & Estate Wines Co.; Fresh; ICI; La Mer; New Line Cinema; Newman's Own; Noggin/The N; Parfums Givenchy & Guerlain; Paris Chocolates; Pharma Print/Omni Graphics; Sesame Workshop; Wendy Stuhlberg; John A. Vassilaros; Watkins, Inc.; Mayor's Office of Film & Television; Boylan's Bottling Co.; Lorraine Tobias & Imaginary Studios; Shapiro & Lobel; Hudson Scenic; Prime Films; and Paul, Weiss, Rifkind, Wharton & Garrison LLP.

### Special Thanks

We owe many thanks to Maria Tucci and Robert Gottlieb, Vicki Mabrey, Wendy Ettinger and Derek McLane, all of whom graciously allowed us to use their upstate homes for three tumultuous and fun-filled days. We are also grateful to Seth Barrish, Lee Brock, Porter Pickard and everyone else at TBG Theatre.

## Don't Be Late - ACT 1

All original music composed by Karl Mansfield

### FORMAGGIA AND LA SCALALINO

Written by Michael Bernard

Directed by Patrick Jones

Formaggia ..... Jorge Zapata  
La Scalalino ..... Samantha Toro  
Announcer ..... Jason Hare  
Barbell Boys ..... Hashem Ahmed, Andy Reyes  
Lions ..... Josh Moody  
Women ..... Liz Bell, Megan Cramer, Alex Solomon

This Song Will Amaze You lyrics by Michael Bernard.

### SNO-GLOBE AND THE BIG ZIP

Written by Sharyn Rothstein

Directed by Laura Konsin

The Big Zip ..... Jason Gil  
Sno-Globe ..... Chloe Moore  
Evil Henchman ..... Jason Hare

Heroes Don't Need Company lyrics by Sharyn Rothstein.

### HERE COMES THE PROM

Written by Graeme Gillis

Directed by Carlos Armesto

Margaret ..... Carla Oliva  
Tootie ..... Stephanie Marion  
Johnnie Ghetto Blaster ..... Shane West  
Prom Boys ..... Andy Reyes, Hashem Ahmed  
Josh Moody, Jason Hare

Here Comes the Prom and I Can See Your Future From Here lyrics by Graeme Gillis.

**INTERMISSION**

## Don't Be Late - ACT 2

### BUTTER FINGER FEVER

Written by Deirdre O'Connor

Directed by David Dalton

Jack ..... Ethan Maldonado  
T Rex ..... Carlos "C.J." Muentes  
Coach ..... George Babiak  
Fans ..... The Crew

Fight the Fever lyrics by Deirdre O'Connor.

### WAIT! WAIT? WAIT...

Written by Winter Miller

Directed by Megan Cramer

Carla ..... Ashley Smith  
Betty ..... Luz Maldonado

Finding X and This Is A Test lyrics by Winter Miller.

### DOCTOR DEVIIOUS AND DOCTOR HYPNOTIC

Written by Michael Lew

Directed by Larissa Lury

Doctor Hypnotic ..... Terrence Mack  
Doctor Devious ..... Lordan Ulloa

Doc Rock lyrics by Michael Lew.



The 52nd Street Project gratefully acknowledges the support of the following foundations and corporations: The Altman Foundation; Ann M. Martin Foundation; AON; APA Talent & Literary Agency; Big Wood Foundation; BKS&K Architects; Bloomberg; The Brenner Family Foundation; Carnegie Corporation of New York; CBS Corporation; CMR Comedy; Consolidated Edison; Department of Cultural Affairs; The Dermot Company, Inc.; The Dramatists Guild Fund; Dramatists Play Service; Eleanor, Adam & Mel Dubin Foundation; The Educational Foundation of America; Sidney E. Frank Foundation; Friars National Foundation; The Horace W. Goldsmith Foundation; Green Apple Entertainment; The William and Mary Greve Foundation; Holland Lodge Foundation, Inc.; Saul Horowitz, Jr. Fund; JKW Foundation; Lemle Pictures, Inc.; Lloyds TSB Bank plc; James A. Macdonald Foundation; LuEsther T. Mertz Foundation; Mellon Equity Associated, Llp; J.P. Morgan Charitable Trust; Newman's Own; The New York Times Company Foundation; NYS&A; NYFA; Provident Foundation; Jonathan Rose Companies; Savoy Bank; Sesame Workshop; Shapiro & Lobel; The Shubert Organization; St. Vincent De Paul Foundation; Starker Family Foundation; Stranahan Foundation; Harold & Mimi Steinberg Charitable Trust; The Surdna Foundation; Susquehanna Foundation, Corp.; Tax Pro Financial Network, Inc.; Theatre Communications Group, Inc.; Tony Randall Theatrical Fund; Van Deusen Family Fund; John A. Vassilaros & Son; Law Offices of Claudia Wagner; Watkins, Inc.; I. Weiss & Sons, Inc.; Wiener Family Foundation; Yorke Construction Corp. Inc. In addition, the following individuals made gifts over \$250 to The 52nd Street Project this past year. (list current as of 1/30/09):

Anonymous	Wendy Ettinger	Harold Levison & Ilyse Levison	Jennifer Reichle
Raymond & Elizabeth Abbott	& Derek McLane	Joshua Lewis & Sarah Kay	Jacquelyn Reingold
Robert Abrams	Andrew Farach-Colton	Barbara Locker	Ira Resnick
& Cynthia Vance	& Martin Farach-Colton	& Penny Zuckerwise	David Ross & Laura Ross
May Ameen	Peter Jay Fernandez	Michael & Marjorie Loeb	Daryl Roth
Lisa Andrade-Hicks	& Denise Burse	Mark Lanow & Joanne Astrow	Robert Saget
Emily Armstrong	Suzanne Fine	Edith Lutnick	Karin & Tom Schall
& Patrick Gannon	& Christian Salomone	John Lyons	Robert Shaffron & John Davis
Dylan & Becky Baker	Angelina Fiordellisi	Greg MacPherson	Neal Shapiro & Hyunju Chang
Ben Barenholtz	& Matt Williams	& Jane Perlmutter	Jonathan Sheffer
Jessica Bauman & Ben Posel	Peter Fisch & Jill Levy Fisch	Ian Madover & Arielle Madover	Peter Shinoda
Michael Bell & Carol Bell	Liz Flahive & Jeff Cox	Drew McCoy & Amy Aquino	Meg Simon
Lisa Benavides & Tim Nelson	Aison Fraser & Nat Magee	Jennifer Manocherian	Tom Slaughter
Gavin Berger	Rosse Gasner & Larry Chertoff	Frances McDormand	Robert Smigel
& Craig Berggren	Freddie Gershon	& Joel Coen	& Michelle Smigel
Elizabeth & Alexander	Jilian Gersten & Brian Shuman	Ann McLarty & Chuck Knauss	Steven Starker
Bernstein	Nancy Giles	Josie Merck & Jim Stevenson	& Farrell Starker
Stephen Bernstein	Jessalyn Gilsig	Noël & Joe Mihalow	Jean Stein
Kerrison Black	James Gosnell	Emily & John Morgan	Jenny & Jon Steingart
Lewis Black	Richard Gottfried	Erin Moriarty	Michael & Marjorie Stern
Richard Blackstone	Stephen & Cathy Graham	Suzen Murakoshi	David Suehsdorf
& Yldez Yuksek	Emily Grishman &	& Mark Temme	& Janet E. Muir
Tessa Blake & Ian Williams	Susan Sampliner	Patricia M. Murphy, Esq.	Richard Sweren
Lawrence Blau	David & Ann Hausmann	& Adam Spilka	Liz Tuccillo
Emily Blavatnik	Peter Herdrich & Karen Trott	John Mustin & Kimberly Mustin	Pamala & Sean Tyson
Allison & Robert Blinken	Sally Holmes & Doug Curtis	Fred Nelson	Laura Valeroso
Rachel Chanoff	William Holtzman	Randy & Rona Nelson	& David Seidman
Kirk & Katherine Holt Citron	& S. Sylvia Shepard	Ruth Nelson	John A. Vassilaros
Ronald Cohen	Katy Homans	James Neuberger	& Alexandra Gersten
Ruth Cohen & Bob Usdin	& Patterson Sims	& Helen Stambler	Wendy vanden Heuvel
Gayle Cohen Heller	Sarah Horowitz	Cynthia Nixon	& Brad Coley
& David Heller	& David Venarde	Rachel & Larry Norton	Carol L. Nadell
Judith-Ann Corrente	Gerald Howard	Lori O'Connor	& Richard E. Van Deusen
Billy Crudup	Seymour & Felicia Jacobs	Carol Ochs & Bruce MacVittie	Joe Versace
Cathy Dantchik	Whitney Scott	Jacki Ochs & Jan Kroeze	Borah & Mildred Walton
Leslie Dantchik	& Peter Jacobson	Paul & Maria Onderdonk	Jane Bolster & Steve Wertimer
Peter & Judith Dawkins	Andrea Johnson	Elizabeth Peters	Michael & Zena Wiener
Neil DeSena	Douglas & Katie Jordan	Peter & Ana Rosa Phillips	Elizabeth Williams
& Carolyn DeSena	Maurice Kanbar	Judy Goldman	& Joseph Forte
Kenny Dichter	Cindy Kaplan & David Froelich	& Michael Pillinger	Geoffrey Wills
Marion & Alan Dienstag	Janet Kleinberg	Doug Polley & Stacy Polley	Frank Wood
Jessica Doty	Judy Kuhn & David Schwab	Christopher Randolph	Bill Wrubel
Richard & Rebecca Dresser	Jonathan Lefkowitz	Peter & Helen Randolph	& Jennifer Crittenden
Adam Dubin & Rochelle Dubin	Warren Leight	Willie Reale & Jenny Gersten	Suzu Yengo

The 52nd Street Project Presents



Friday, April 3 at 7:30 p.m.  
 Saturday, April 4 at 3:00 p.m. and 7:30 p.m.  
 Sunday, April 5 at 3:00 p.m.

The Public Theater  
 425 Lafayette St.

## Can Do! Plays on the Bright Side

The Spring 2009 Playmaking Production - April 3-5 at The Public Theater

### The 52nd Street Project Staff

Gus Rogerson, Artistic Director  
 Carol Ochs, Executive Director  
 John Sheehy, Director of Development and Marketing  
 George Babiak, Production Manager  
 Reg Flowers, Associate Artistic Director  
 Liz Bell, Director of Education  
 Megan Cramer, Program Director  
 Diana Rojas, Associate Program Director  
 Josh Moody, Development Assistant  
 Jan Gura, Capital Campaign Consultant  
 Chris Ceraso, Teen Dean  
 Iris A. Brown, Graphic Designer  
 Carla Oliva, Azalea Rosario, Angel Silva, Teen Receptionists  
 Jenisse Bouret, Teen Homework Helper  
 Mordecai Santiago, Teen Playmaking Class Assistant  
 Alex Solomon and Shane West, Interns

### "Can Do!" Production Staff

#### Composer/Music Director

Andrew Sherman

#### Set Designer

Kevin Joseph Roach

#### Lighting Designers

Greg MacPherson, Elizabeth Hintze,  
and Katrina Miller

#### Costume Designers

Chloe Chapin and Kathleen Doyle

#### Goddess of Sound

Vanessa Valdes

#### Stage Manager

Casey Keeler

#### Slide Designs

George Babiak and the  
Project Slide Archive

#### Prop Design Team

George Babiak, Megan Cramer,  
Alex Solomon, Shane West

#### Backstage Crew

Kyle Fargardo, Jason Gil,  
Jonathan Kaplan, Ariana Seigel,  
Alex Solomon, Shane West

#### Load-in and Light-hang Crew

Jessica Ellis, Kathleen Foreman,  
Jason Hare, Ray Harold,  
Ephraim Lopez, Doug Nervik,  
Tom Schall, Rory Scholl,  
Carol Sullivan

#### House Managers

Liz Bell, Josh Moody, Karin Schall,  
Mary Pat Walsh

#### Flyer Art: Heather Gobbee

#### Chefs

Liz Bell, John Sheehy

#### Class Volunteers

Chris Bachand, Philip Carlson,  
Evan Focht, Ariana Seigel, Fanneke  
Verhallen, Jacob Garrett White



The Playmaking Program is made possible with public funds from The New York State Council on the Arts, a state agency; and the New York City Department of Cultural Affairs. The 52nd Street Project is supported by funds from the National Endowment for the Arts. The 52nd Street Project is a member of Art/NY and a participant in the New Generations Program, funded by Doris Duke Charitable Foundation/The Andrew W. Mellon Foundation and administered by Theatre Communications Group, the national organization for the American Theater.

## COOL STUFF ON SALE IN THE LOBBY!

FABULOUS FLYER BARS ..... \$2.50, \$2, \$1.50

### AND FEATURING SHEL SILVERSTEIN'S "FIVEY AND TWOEY" LOGO:

PROJECT T-SHIRTS.....\$12.00  
 PROJECT HOODIES.....\$30.00  
 PROJECT CAPS.....\$20.00  
 PROJECT MUGS .....\$5.00  
 PROJECT PENCIL 3-PACK .....\$1.00  
 PROJECT NOTEBOOK.....\$5.00

Thank you for coming to CAN DO! If you are not on our mailing list (or if your address has changed), please fill out this form and give it to us on your way out or mail it to the address below. We would also like to know if you are interested in becoming a volunteer. We need help in all areas, so be sure to fill out the entire form.

### PLEASE ADD ME TO YOUR MAILING LIST:

04/09

NAME \_\_\_\_\_

ADDRESS \_\_\_\_\_

CITY \_\_\_\_\_

STATE \_\_\_\_\_

ZIP \_\_\_\_\_

HOME PHONE \_\_\_\_\_

DAYTIME OR MOBILE PHONE \_\_\_\_\_

E-MAIL ADDRESS \_\_\_\_\_

MY OCCUPATION \_\_\_\_\_

MY HOBBIES \_\_\_\_\_

### YES, I WOULD LIKE TO BE OF HELP. I CAN:

- |   |   |  |
|---|---|--|
| <input type="checkbox"/> Help load in and out for shows | <input type="checkbox"/> Draw and/or paint  | <input type="checkbox"/> Help kids with homework |
| <input type="checkbox"/> Hang lights                    | <input type="checkbox"/> Help with mailings | <input type="checkbox"/> Teach kids a skill      |
| <input type="checkbox"/> Work on a backstage crew       | <input type="checkbox"/> Do office work     | <input type="checkbox"/> Be a chef at an event   |
| <input type="checkbox"/> Do graphic design              | <input type="checkbox"/> Design sound       | <input type="checkbox"/> Design and sew costumes |
| <input type="checkbox"/> Other (please specify) _____   |   |  |

### MY SCHEDULE IS:

- Very flexible. I'm often available during weekdays.  
 Somewhat flexible. I can help on the occasional morning or afternoon during the week.  
 Not very flexible at all, but I've got some free time on evenings and weekends.

If you would like to mail this (and you're always welcome to enclose a tax-deductible contribution), you can send it to: The 52nd Street Project, 500 West 52nd St., #2E, New York, NY 10019. Or fax it to (212) 333-5598.



**COMING UP SOON!**

# **PACKING PEANUTS**

## **A MOVING EXPERIENCE**

This year, the annual benefit celebrates the transition into the state-of-the-art new headquarters of the Project, scheduled for this summer. Come see fabulous performers do kids' tributes to our future home!



**MONDAY, MAY 11, 2009**

At Espace - West 42nd Street between 10th and 11th Ave.

(It's NOT the new space, but it's a pretty nice place to have a benefit.)

Call John "Handtruck" Sheehy at (212) 333-5252 or write him at [sheehy@52project.org](mailto:sheehy@52project.org) to reserve your place!

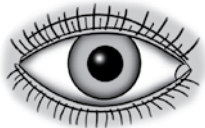

**BE ON THE LOOKOUT!**  
**WE ARE ALWAYS**  
**SEARCHING FOR INTERNS.**

If you know of any college or graduate students who might enjoy working with us, playing with us, and going on trips with us for a semester, please have them contact George Babiak or Megan Cramer. We are especially looking for interns for the Fall of 2009. Thanks!

### The 52nd Street Project Board of Directors

Ben Barenholtz  
Lisa Benavides  
Rachel Chanoff  
Cathy Dantchik  
Carolyn DeSena  
Wendy Ettinger, chair emeritus  
Louis P. Friedman  
Stephen Graham, chair  
Larry Jones  
James McDaniel  
Frances McDormand

Noël Mihalow  
Carol Ochs  
Willie Reale, founder  
Gus Rogerson  
Shirley Rumierk,  
alumni member  
José Soto, Jr., alumni member  
Jenny Steingart  
Pamala Tyson  
Wendy vanden Heuvel  
John A. Vassilaros

---

#### What's Going On Here?

The 52nd Street Project is a non-profit organization that brings children from the Hell's Kitchen neighborhood together with professional theater artists to create original theater. CAN DO! is a production of our Playmaking program. Young people participate in a nine-week playwriting course taught by Reg Flowers and adapted for the Project by Daniel Judah Sklar from his book Playmaking: Children Writing and Performing Their Own Plays. At the end of the course, each child is given two actors, a theme, and a dramaturg/director who guides him or her through the writing of a play during a weekend retreat in the country (Bridgehampton, Long Island, for this show). Tonight's performance is the end result.

---

#### In-Kind Contributions

The Murphy Law Office; Abbeville Press; Stephanie Berger Photography; Iris A. Brown Design; Carmine Campisi & Graphic Lab; Kenneth Cole Productions; William Curran & A Curran Affair; Diageo Chateau & Estate Wines Co.; Fresh; ICI; La Mer; New Line Cinema; Newman's Own; Noggin/The N; Parfums Givenchy & Guerlain; Paris Chocolates; Pharma Print/Omni Graphics; Sesame Workshop; Wendy Stuhlberg; John A. Vassilaros; Watkins, Inc.; Mayor's Office of Film & Television; Boylan's Bottling Co.; Lorraine Tobias & Imaginary Studios; Shapiro & Lobel; Hudson Scenic; Prime Films, and Paul, Weiss, Rifkind, Wharton & Garrison LLP.

---

#### Special Thanks

We're extremely grateful to John Vassilaros, Alex Gersten-Vassilaros, their boys Tonio, Luka and Stefano, the ever-helpful Joyce, and Zeus the dog for allowing us to use their home as our headquarters and boy dormitory on our Playmaking retreat to Bridgehampton last month. We also owe gratitude to Laurie Becker, who let some volunteers and the girl writers crash at her luxurious pad in Sag Harbor, and to the Blackstone family for additional housing. Finally, we must express our profound thanks to Oskar Eustis, Jenny Gersten, Maria Goyanes, Bethany Ford, and everyone else at the amazing Public Theater.

## Can Do! Plays on the Bright Side - ACT 1

All original music composed by Andrew Sherman

### CRYSTAL AND MANNY FOREVER

Written by Ashley Melón, age 10

Director/Dramaturge: Becky White, Costumes: Chloe Chapin

Crystal ..... Jackie Chung  
Manny ..... Donnetta Grays  
The Animals ..... The Crew  
Manager ..... Ariana Seigel

### THE EXCHANGE

Written by Lucas Ruedel, age 11

Director/Dramaturge: Kathleen Foreman, Costumes: Kathleen Doyle

Sally ..... Nitya Vidyasagar  
John ..... Ezra Knight

### PB AND J GO SOUR

Written by Eliza Leilanni Muñoz, age 12

Director/Dramaturge: Liz Flahive, Costumes: Chloe Chapin

PB ..... Jeremy Beck  
Jelly ..... Cynthia Vance  
Mom's Voice ..... Alex Solomon  
Old Man ..... John Sheehy  
Ode to PB and Yay lyrics by Eliza Leilanni Muñoz

### BEST DAUGHTER EVER

Written by Naomi R. Welch, age 11

Director/Dramaturge: Sonia Manzano, Costumes: Chloe Chapin

Sasha ..... Elizabeth Marvel  
Mongli ..... Eliza Baldi  
Grandaddy's Voice ..... Jonathan Kaplan  
I Need to Tell lyrics by Naomi R. Welch

### TWO WISHES

Written by Francis Rivera, age 11

Director/Dramaturge: George Babiak, Costumes: Kathleen Doyle

Stupid ..... Billy Crudup  
Cody ..... Elliot Villar  
Cyclops ..... John Sheehy  
Fairy ..... Megan Cramer  
Two Wishes Theme Song - Funny Version lyrics by Francis Rivera

## Can Do! Plays on the Bright Side - ACT 2

### LIVING THE LIFE WITH HOUSE AND JENNY

Written by Joseph Vasquez, age 10

Director: Michael Bernard, Dramaturge: Josh Moody

Costumes: Kathleen Doyle

House ..... Lee Wilkof  
Jenny ..... Jeanine Serralles  
Owner ..... Michael Bernard  
New Yorkers ..... The Company  
Liar and Wish lyrics by Joseph Vasquez

### TOGETHER FOREVER

Written by Nathaly Trinidad, age 10

Director/Dramaturge: Megan Cramer, Costumes: Chloe Chapin

Asheley ..... Annie Purcell  
Nathaniel ..... Reg E. Cathey  
Did You Know lyrics by Nathaly Trinidad

### OUT OF THE WOODS

Written by Venecia Escamilla, age 10, Director: Reg Flowers

Dramaturge: Alexandra Gersten-Vassilaros, Costumes: Chloe Chapin

Alexandra ..... Patrice Johnson  
Jeremy/Bob ..... Jordan Mahome  
The Woods Are So Spooky lyrics by Venecia Escamilla

### TWO RIVALS

Written by Kamil Kuzminski, age 10

Director/Dramaturge: David Costabile, Costumes: Kathleen Doyle

Alpha ..... Danyon Davis  
Elemental Lord ..... James McDaniel  
What Alpha Has To Do and Elemental Lord's Loss lyrics by Kamil Kuzminski

### THE BIG ARGUMENT

Written by Daquan Nelson, age 12.

Director/Dramaturge: Nigel Smith, Costumes: Kathleen Doyle

Andy ..... Steven Goldstein  
Brittney ..... Emily Dorsch  
Mom's Voice ..... Ariana Seigel  
Dad's Voice ..... Jonathan Kaplan  
Yes You Are, No I'm Not and Can't Fix Everything lyrics by Daquan Nelson

## **THE PROJECT'S BOARD OF DIRECTORS**

Ben Barenholtz  
Lisa Benavides  
Rachel Chanoff  
Cathy Dantchik  
Carolyn DeSena  
Wendy Ettinger,  
Chair Emeritus  
Louis P. Friedman  
Stephen Graham, Chair  
Larry Jones  
James McDaniel  
Frances McDormand

Noël Mihalow  
Carol Ochs  
Willie Reale, founder  
Gus Rogerson  
Shirley Rumierk,  
alumni member  
José Soto, Jr.,  
alumni member  
Jenny Steingart  
Pamala Tyson  
Wendy vanden Heuvel  
John A. Vassilaros

## **THE 52ND STREET PROJECT STAFF**

Carol Ochs, Executive Director  
Gus Rogerson, Artistic Director  
John Sheehy, Dir. of Development and Marketing  
George Babiak, Production Manager  
Reg Flowers, Associate Artistic Director  
Liz Bell, Director of Education  
Megan Cramer, Program Director  
Josh Moody, Development Assistant  
Diana Rojas, Associate Program Director  
Chris Ceraso, Teen Dean  
Iris A. Brown, Graphic Designer  
Jan Gura, Capital Campaign Consultant  
Alex Solomon and Shane West, Interns

## **BENEFIT VOLUNTEERS**

Tim Cain, Bryan Gmitter, Heather and Martin Gobbee,  
Jason Hare, Ray Harold, Jonathan Kaplan,  
Doug Nervik, Vanessa Valdes

## **SPECIAL THANKS**

William Curran, Liz Flahive,  
Terry Fitzpatrick, Amy Friedman,  
Mark Jacobs, Karin & Tom Schall,  
Mary Pat Walsh

Honorary Co-chairs Peter Dinklage & Mary Testa

Corporate Hosts Ars Nova & Yorke Construction Corp. and  
the Board of Directors of The 52nd Street Project present

# **PACKING**



# **PEANUTS**

## **A MOVING EXPERIENCE**

The 52nd Street Project's Annual Gala

Monday, May 11, 2009

Espace

Board Chair: Stephen Graham  
Executive Director: Carol Ochs  
Artistic Director: Gus Rogerson

## **PACKING PEANUTS BENEFIT CO-CHAIRS**

Lisa Benavides  
Cathy Dantchik  
Carolyn DeSena  
Louis P. Friedman  
Patrice Friedman  
Karin Schall  
Jenny Steingart  
Merritt Tilney  
Laura Valeroso  
Mary Pat Walsh

## **THE 52ND STREET PROJECT GRATEFULLY ACKNOWLEDGES...**

Abbeville Press  
Stephanie Berger Photography  
Lewis Black  
Richard Blackstone  
Bloomingdale's  
Iris A. Brown Design  
City Winery  
William Curran,  
A Curran Affair  
Kate Cusack  
EMI Records and Billy Mann  
Bob Goldberg & Yorke Construction  
Bill Lawrence from the S.F. Giants  
Newman's Own  
Macy's  
Noël Mihalow and PineRock  
The N/Nickelodeon  
Pharma/Omni Printing  
Sesame Workshop and Willie Reale  
Shapiro Lobel, LLP  
Wendy Stulberg  
Ryan Thorvaldsen from the Yankees  
John A. Vassilaros & Sons  
Watkins Incorporated  
Healthier Living Since 1868

## **STACKED BOX SEATS**

Emily Armstrong & Thomas P. Gannon  
Becky Ann & Dylan Baker  
Michael Bernard  
Ravi Bhandari  
Jane Bolster & Steve Wertimer  
Becky Browder & Ted Neustadt  
Chris Ceraso  
Rachel Chanoff & Wolf Chanoff  
David Costabile  
Craig Cox  
Margaret Crimmins  
Rebecca & Richard Dresser  
Denise Burse Fernandez  
& Peter Jay Fernandez  
Katie Flahive & Josh Bywater  
Liz Flahive & Jeff Cox  
Connie Garrido  
Jenny Gersten & Willie Reale  
Jilian Cahan Gersten  
& Brian Shuman  
Lisa J. Gugenheim  
& Lawrence Nathanson  
Gloria Gura  
Jan Gura & Alan Pickman  
Dolores & Merril Halpern  
Sally Holmes & Doug Curtis  
Katheryn Holt Citron & Kirk Citron  
Uma Jagtiani & Rajeev Bhandari  
Linda LeRoy Janklow  
Bonnie Kantor  
Susan & Steve Ko  
Joyce Krawiecki  
Henry Krieger & Robert Joy  
Belle & Roger Kuhn  
Judy Kuhn & David Schwab  
Mickey Lemle  
Tom Leonardis  
Martin Levine, The Par Group  
Abby & Anton Levy  
Anna Li & Frank Sposato  
Melissa Liebling-Goldberg  
& John Barrett  
Emily & John Morgan  
Carol Ochs & Bruce MacVittie  
Jacki Ochs & Jan Kroeze  
Paula Park, Wachovia Bank  
Jessica Pell  
Sue Phillips  
Judy & Michael Pillinger  
Christopher Randolph  
Jackie Reingold & Rich Campbell  
Anita A. Rogerson  
Joseph Rokacz  
Martha Roth & Bill Irwin  
Tatiana Rutkowsky  
& Andrew Blackman  
Laura Sametz  
Marcia Santoni  
Karin & Thomas Schall  
Maury Schott  
Whitney Scott & Peter Jacobson  
Robert Shaffron & John Steber  
Meg Simon  
Stephen Sondheim  
Susanna Styron  
Mary Lou Teel  
Meritt Tilney & Douglas Kaden  
Laura Valeroso & David Seidman  
Cynthia Vance & Robert Abrams  
Ali Marsh Weller & Fred Weller  
Carole Yass  
Connie & Marc Zand

Donor lists current as of May 5, 2009

## **SETTLING-IN SEATS**

Lisa Benavides Nelson & Tim Blake Nelson

Gavin Berger & Craig Berggren

Allison M. Blinken

DNA Inc.

Suzanne Fine & Christian Salomone

Kay Gayner & Frank Wood

Nancy Giles

Susannah Gray & John Lyons

Karen Hauser & Warren Leight

Sarah Horowitz & David Venarde

Cynthia Kaplan & David Froelich

John S. Lyons

Frances McDormand & Joel Coen

Stacey & Eric Mindich

Patricia Murphy & Adam Spilka

Jane Musky & Tony Goldwyn

New World Foundation

Rachel & Larry Norton

Jane Perlmutter & Greg MacPherson

Ira Resnick

Jonathan Rose Companies

David Rosenberg, I. Weiss, Inc.

Laura & David Ross

Steve Sabba, Tax Pro Financial Network, Inc.

George Schieferdecker, BSK Architects

Beth & David Shaw

Sylvia Shepard & Will Holtzman

Richard Sweren

Victor Szymis

Lisa Tilney

Joe Versace

Claudia Wagner & Don Lebowitz

Mary Pat Walsh

Fran & Barry Weissler

## **PACKING PEANUTS: THE SHOW**

### **EMCEE**

Robert Sean Leonard

### **THE LYRICISTS**

Doris Alcantara, Gerardo Escamilla, Katie Liu,

Aidan Martinez, Jazmine Mikell

### **THE COMPOSERS**

Henry Krieger, Dayna Kurtz, Sondre Lerche,

Robert Reale, Jeanine Tesori

### **THE SINGERS**

John Ellison Conlee, Lilli Cooper, Mandy Gonzalez,

Dayna Kurtz, Sondre Lerche, Mary Testa

### **PACK-UP VOCALISTS**

Tim Cain, Megan Cramer, Crystal Dickinson, & Alex Tomas

### **THE MUSICIANS**

Kimberly Grigsby, Piano

Peter Bernstein, Guitar

Ethan Eubanks, Drums

### **DIRECTED BY**

Jonathan Bernstein

### **MUSICAL DIRECTOR**

Kimberly Grigsby

### **MUSICAL COORDINATOR**

Kim D. Sherman

### **LIGHTING DESIGN**

Greg MacPherson

### **SOUND DESIGN**

Scott Lehrer

### **SET DESIGN**

George Babiak

### **STAGE MANAGER**

Rachel Bauder

### **WRITTEN BY**

John Sheehy

## **MOVING TO OUR FUTURE**

Lyrics by Gerardo Escamilla, age 12  
Composed and performed by Sondre Lerche

HOW MUCH AM I GONNA MISS THE OLD PLACE?  
WHERE I HAD ALL MY GREAT IDEAS ABOUT WRITING

BUT WE ALL HAVE TO MOVE ON  
WITH ALL OF OUR FRIENDS AND MEMORIES  
IT ALL STARTED WHEN MY COUSINS JOIN IN  
SO THEY OBLIGED ME AND MY SISTERS TO BOING IN

MEMORIES, DO I STORE THEM?  
MEMORIES, THEY COULD BE STORIES  
REMEMBERING THE PAST AND TELLING THE FUTURE  
WHILE RUNNING FAST ON A TIME LINE

HOW MUCH AM I GONNA MISS THE OLD PLACE?  
WHERE I HAD ALL MY GREAT IDEAS ABOUT WRITING

OUR NEIGHBORHOOD LOOKING AT US CUTTING THE RIBBON  
I GUESS THERE'LL BE A PARTY AFTER THE CELEBRATION  
I BET SOMEONE WILL BE COOKING SOME CHICKEN  
THERE'LL BE A MESS THAT I WON'T BE CLEANING UP

HEY BUT WE'RE KEEPING THE PING PONG TABLE AND THE PROPS  
I HOPE THE COPS DON'T STOP US  
THE KIDS READY TO RUSH IN  
BUT FIRST THEY HAVE TO CRUSH IN

HOW MUCH AM I GONNA MISS THE OLD PLACE?  
WHERE I HAD ALL MY GREAT IDEAS ABOUT WRITING  
HOW MUCH AM I GONNA MISS THE OLD PLACE?  
WHERE I HAD ALL MY GREAT IDEAS ABOUT WRITING

SAYING GOODBYE TO THE PAST  
AND SAYING HELLO TO THE FUTURE

SEE OUR NEW PLACE IT'S GREAT  
SEE OUR NEW PLACE IT'S GREAT  
SEE OUR NEW PLACE IT'S GREAT  
SEE OUR NEW PLACE IT'S GREAT  
SEE OUR NEW PLACE IT'S GREAT

HOW MUCH AM I GONNA MISS THE OLD PLACE?  
WHERE I HAD ALL MY GREAT IDEAS ABOUT WRITING

## **RELOCATION TABLES**

Cathy & Stephen Graham  
Betsy MacIsaac & Robert Goldberg,  
Yorke Construction Corporation  
Jenny & Jon Steingart

## **MOVING TABLES**

The Dantchik Family  
Patrice & Louis Friedman

## **NEW NEIGHBORS TABLES**

Wendy Ettinger & Derek McLane  
Fred Nelson  
Janine & Jeffrey Yass

## **WELCOME WAGONS TABLES**

CBS Corporation  
The Dawkins Family Foundation  
Carolyn & Neil DeSena  
Rose Gasner & Larry Chertoff  
Bev Gasner  
Freddie Gershon, Music Theater International  
Alexandra Gersten-Vassilaros & Johnny Coffeeshopolis  
Andrea Johnson  
Rona & Randolph Nelson  
Ruth Nelson  
Steve Martin Charitable Foundation  
Daryl Roth  
Wendy vanden Heuvel & Brad Coley

## CHANGE IS GREAT

Lyrics by Jazmine Mikell, age 12

Composed by Henry Krieger, performed by Mary Testa

Back-up singers:

Tim Cain, Megan Cramer, Crystal Dickinson, & Alex Tomas

CHANGE CAN BE GREAT, IT'S OKAY  
IF YOU WANT THIS PLACE TO STAY  
BUT THERE AIN'T NOTHING WRONG WITH CHANGE

(SPOKEN) LISTEN EVERYONE  
THERE AIN'T NOTHING WRONG WITH CHANGE  
OH, YOU MAY NOT LIKE CHANGE  
BUT I DON'T REALLY CARE

LISTEN TO OUR VOICES  
LISTEN TO OUR MELODY  
WE'RE SOO SERIOUS

WHEN YOU HEAR OUR VOICES  
WHEN YOU HEAR OUR MELODY  
YOU WILL SEE HOW GOOD CHANGE CAN BE

CHANGE IS GREAT, IT'S OKAY  
IF YOU WANT THIS PLACE TO STAY  
BUT THERE AIN'T NOTHING WRONG WITH CHANGE

SOMETIMES WE HAVE TO LET GO  
BUT CHANGE IS GOOD  
I'LL GIVE YOU MY HAND  
TO THE NEW SPECIAL PLACE

OH, AIN'T NOTHING WRONG WITH CHANGE  
AIN'T NOTHING WRONG WITH CHANGE  
AIN'T NOTHING WRONG, AIN'T NOTHING WRONG  
AIN'T NOTHING WRONG WITH CHANGE

ALL I CAN SEE IS A PICTURE OF ME  
ON TOP OF THE BALCONY  
WITH MY HAIR AND MY DRESS  
FLOWING IN THE WIND

CHANGE IS GREAT, IT'S OKAY  
IF YOU WANT THIS PLACE TO STAY  
BUT THERE AIN'T NOTHING WRONG WITH CHANGE

SOMETIMES WE HAVE TO LET GO  
BUT CHANGE IS GOOD  
I'LL GIVE YOU MY HAND  
TO THAT NEW SPECIAL PLACE

AIN'T NOTHING WRONG  
OH, NOTHING WRONG  
OH, AIN'T NOTHING WRONG WITH CHANGE

## IT CAN BE GOOD OR BAD

Lyrics by Katie Liu, age 11

Composed by Jeanine Tesori

Performed by Lilli Cooper and Mandy Gonzalez

IT CAN BE BAD OR GOOD  
IT CAN BE BAD OR GOOD  
TO BE IN FUTURE OF 52ND STREET PROJECT

IT'S BAD BECAUSE THERE'S A LOT OF POOP UNDER THE TREE  
AND IT'S SO BIG THAT YOU'RE LOST IN THERE  
ALSO IT FEELS I WAS GOING TO FALL DOWN

IT CAN BE BAD OR GOOD  
TO BE IN FUTURE OF 52ND STREET PROJECT

IT'S GOOD BECAUSE TO HAVE MORE PLACES  
AND TO STAY HERE ALL THE TIME  
AND BIGGER PLACES  
ALSO THE BUS STOP IS ACROSS THE STREET

I FEEL SAD AND HAPPY  
ALSO BAD AND GOOD  
I FEEL SAD AND HAPPY  
ALSO BAD AND GOOD

I THINK IT'S GOOD  
BECAUSE I LIKE A BIGGER PLACE

## **THE 52ND STREET SONG**

Lyrics by Aidan Martinez, age 11

Composed by Robert Reale, performed by John Ellison Conlee

Back-up singers:

Tim Cain, Megan Cramer, Crystal Dickinson, and Alex Tomas

I'LL MISS HOW I USED TO GO THERE FROM SCHOOL  
SUCH A LITTLE PLACE  
52ND STREET PROJECT  
WHY DID YOU REPLACE?

LIZ IS ASKING FOR HOMEWORK AGAIN  
IN A SQUEAKY VOICE  
SHE WAS BEGGING US TO LEARN  
I HAVE NO CHOICE

OH, THAT PROJECT ON 52ND STREET  
THAT PROJECT WHERE EVERYONE'S SO SWEET  
THAT PROJECT YOU'VE BEEN A GREAT HELP TO ME  
IT'S A MARVELOUS PLACE TO BE

WHEN I WALKED TO THE NEW PLACE  
I WAS FEARFUL  
BUT THEN I WALKED INTO THE NEW PLACE  
I FELT CHEERFUL

LIZ'S OFFICE IS SO VERY SMALL  
LIKE A HUNDRED PINKIES  
NOW'S SHE'S GONNA GET A BIG ONE  
DAYS GO BY AS FAST AS YOU BLINK

OH PROJECT ON 52ND STREET  
OH THAT PROJECT WHERE EVERYONE'S SO SWEET  
THAT PROJECT YOU'VE BEEN A GREAT HELP TO ME  
IT'S A MARVELOUS PLACE TO BE

THEY TAKE CARE OF ME...

## **I GOTTA MOVE ON**

Lyrics by Doris Alcantara, age 12

Composed and performed by Dayna Kurtz

I WANNA MOVE ON  
GOTTA GET GOIN' WITH MY LIFE  
WHAT MEANS THE WORLD HAS DISAPPEARED  
NEEDA HIDE FROM REALITY

I NEED SOMEWHERE TO GO  
SOMEWHERE TO HIDE  
SOMEONE TO HELP ME DECIDE  
NOW THAT YOU'RE GONE.....

I'M NOT GONNA STOP RUNNIN'  
NOT TILL I FIND YA  
THE RAIN AIN'T GONNA BRING ME DOWN  
AND THE WIND AIN'T GONNA SET ME BACK  
THOUGH THESE CHAINS MAY HOLD ME STEADY  
I'M GONNA BREAK OUT OF THEM WHEN I'M READY

I'M GONNA SPREAD MY WINGS AND FLY  
I'M GONNA REACH YOU IN THE SKY  
THERE AIN'T GONNA BE NO MORE REASONS TO CRY  
THERE'S ONLY ONE PROBLEM

I NEED SOMEWHERE TO GO  
SOMEWHERE TO HIDE  
SOMEONE TO HELP ME DECIDE  
NOW THAT YOU'RE GONE.....

I'M GONNA MOVE ON  
WITH YOU ALWAYS IN MIND  
YOU'LL NEVER BE LEFT BEHIND  
BUT I GOTTA MOVE ON



The 52nd Street Project is a non-profit organization that brings children from the Hell's Kitchen neighborhood together with professional theater artists to create original theater. The Replay program gives children who are graduates of the Project's Playmaking class a chance to hone their skills in an advanced writing workshop taught by Megan Cramer and Reg Flowers. Over the nine weeks of Replay class, these young playwrights explored varied sources of inspiration, including a visit to the Whitney Museum, studied dramatic structure, and learned to embrace their own personal writing style. The resulting plays are featured in tonight's reading.

### Special Thanks

We're grateful to James Houghton, Tara Geesaman, Kara Aghabekian, and the rest of the staff at The Signature Theatre for making this evening possible. The plays wouldn't have made it to the page without the help of these Replay class volunteers: Stephen Ellis, Ginny Lee, Don Nguyen, Jessica Provenz, Vickie Ramirez, Sharyn Rothstein, Rory Scholl, Shane West, and Pia Wilson. We'd especially like to thank the Cohen family and friends for their support of Replay.

### The Project Staff

Gus Rogerson ..... Artistic Director  
Carol Ochs..... Executive Director  
John Sheehy..... Director of Development and Marketing  
George Babiak..... Production Manager  
Liz Bell ..... Director of Education  
Megan Cramer..... Program Director  
Diana Rojas ..... Associate Program Director  
Joshua A. Moody..... Development Assistant  
Chris Ceraso..... Teen Dean  
Iris A. Brown ..... Graphic Designer  
Chassity Damiani..... Replay Class Assistant  
Jenisse Bouret, Carla Oliva,  
Azalea Rosario, Angel Silva ..... Receptionists  
Interns..... Alyssa Kuhn, Olivia Harris, Brent Rivers

### The 52nd Street Project Board of Directors

Ben Barenholtz	Noël Mihalow
Lisa Benavides	Carol Ochs
Rachel Chanoff	Willie Reale, founder
Cathy Dantchik	Gus Rogerson
Carolyn C. DeSena	Shirley Rumierk, alumni member
Wendy Ettinger, chair emeritus	José Soto, Jr., alumni member
Louis P. Friedman	Jenny Steingart
Stephen Graham, chair	Pamala Tyson
Larry Jones	Wendy vanden Heuvel
James McDaniel	John A. Vassilaros
Frances McDormand	

The 52nd Street Project Presents  
The 2009 Lorraine Cohen

# Replay Readings

8 new plays by  
8 young playwrights

Monday, June 15, 2009  
7:30 p.m.

The Signature Theatre at  
The Peter Norton Space  
555 West 42nd Street

The Theme Park, Yo  
 by Haley Zoe Martinez, age 11  
 Directed by John Steber

Nene ..... Edward O'Blenis  
 Jenny ..... Mercedes Herrero

Trouble With Friends  
 by Gerardo Escamilla, age 12  
 Directed by Tom Schall

Troublemaker ..... Christopher Evan Welch  
 Perry Jerry ..... Kevin Geer  
 Paco de Taco da Third..... George Babiak

Working My Butt Off!!!  
 by Tiara Varela, age 11  
 Directed by Maureen Towey

Daise ..... Emily Dorsch  
 Robber..... Howard Overshown  
 Announcer/Cashier..... Ginny Lee

The Freaky Pop-Star and the Regular Girl  
 by Samantha Paduani, age 10  
 Directed by Patricia McGregor

Ashley..... Phyllis Somerville  
 Carey Hilson..... Marsha Stephanie Blake  
 Poperatzis..... Stephen Ellis, Josh Moody, Rory Scholl

Pocket Masters Unlimited  
 by Frankie Williams, age 13  
 Directed by Tom Schall

Frankie, Jr..... Christopher Evan Welch  
 Steven, Jr..... Kevin Geer  
 Washington/Computer ..... George Babiak

Loving  
 by Alizette Zapata, age 11.  
 Directed by Maureen Towey

Nicole..... Emily Dorsch  
 Gerry..... Howard Overshown  
 Mom..... Ginny Lee

Security Guard  
 by Michael Bannister, age 12.  
 Directed by Patricia McGregor

Michelle ..... Phyllis Somerville  
 Lily ..... Marsha Stephanie Blake  
 Robber #1 ..... Rory Scholl  
 Robber #2..... Stephen Ellis  
 Boss..... Josh Moody

15, 4, 2, 1  
 by Elizabeth Vazquez, age 11  
 Directed by John Steber

Cheetohs Lay/Jonnifer..... Edward O'Blenis  
 Alicia (Ally)/Sugah Momma ..... Mercedes Herrero

**B  
R  
I  
E  
F  
  
I  
N  
T  
E  
R  
M  
I  
S  
S  
I  
O  
N**



Gus Rogerson, Artistic Director

Carol Ochs, Executive Director

## The 52nd Street Project Presents

The 52nd Street Project (The Project) is dedicated to the creation and production of new plays for and by kids between the ages of ten and eighteen who reside in the Hell's Kitchen neighborhood in New York City. The Project does this through unique mentoring programs that match kids with professional (and volunteer!) theater artists.

The Project is about making children proud of themselves. The Project is not about teaching children to act, although they will learn to. It is not about teaching them to write plays, although they will learn that as well. What it is about is giving a kid an experience of success. It is about giving a kid an opportunity to prove that he or she has something of value to offer, something that comes from within that he or she alone possesses, something that cannot be taken away.

The Project's Teen Ensemble is the final step in the kids' training: a two-year acting class that culminates in the production of a full-length play by William Shakespeare, the very one you are seeing tonight. This year's show is being done in New York and Marfa, Texas. We are very grateful to our Lone Star hosts for enabling this tour.



Directed by Megan Sandberg-Zakian

Adapted from William Shakespeare's

## King Lear

by Chris Ceraso with Reg Flowers and  
The 52nd Street Project Teen Ensemble

Produced by Megan Cramer

**New York City:**

June 26 and 27, 2009 - The East 13th St. Theater

**Marfa, Texas:**

July 3, 2009 - The Crowley Theater

The following foundations and government agencies have  
generously supported the Teen Program  
through their contributions:

City of New York Department of Cultural Affairs  
Horace W. Goldsmith Foundation  
National Endowment for the Arts  
New York State Council on the Arts  
The Surdna Foundation



# THE CAST

LEAR.....Chris Ceraso  
 GONERIL, 1st Daughter to Lear.....Caitlin McWethy  
 REGAN, 2nd Daughter to Lear.....Kayelani Almonte  
 CORDELIA, 3rd Daughter to Lear.....Merlaine Mendez  
 FOOL.....Merlaine Mendez  
 GLOUCESTER.....Megan Cramer  
 EDGAR, Son to Gloucester.....Kimani Lewis-Ashley  
 EDMUND, Bastard Son to Gloucester.....Victor Cortes

Time: The not-too-distant future.

# PRODUCTION STAFF

Movement Czar.....Noah Racey  
 Movement Czarina.....Sara Brians  
 Lighting Designer.....Burke Brown  
 Costume Designer.....Kathleen Doyle  
 Sound Designer.....Brent Rivers  
 Stage Manager/Board Operator.....Olivia Harris  
 Flyer/Program Art design.....Jessica Ellis

New York Thanks: Patrick Barnes, Ian Hersey, Catherine Mueller, Doug Nervik, Andrew Sherman, Becky White.

Marfa Thanks: Ree and Jason Willaford, Tim Crowley, Jennifer Bell, Rob Crowley, Evelyn Luciani, Saarin Keck and Pizza Foundation, Squeeze Marfa, Joe and Lanna Duncan and Jetts at The Paisano Hotel, Pablo Alvarado, David Beebe and Padres Restaurant, Austin Street Cafe, Krista Steinhauer and Adam Bork and Food Shark, Tom and Toshi and Cochineal Restaurant, John Wotowicz and Virginia Leberman, Thunderbird Hotel, Gallerie Urbane, Ball-room Marfa, Ayn Foundation, and Gretchen Coles.

An extra round of special thanks goes to Reg Flowers for his extraordinary contribution to this production and to this Teen Ensemble.

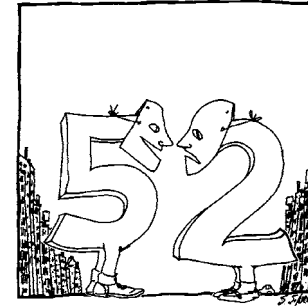

The 52nd Street Project

## The Project Staff

Gus Rogerson.....Artistic Director  
 Carol Ochs.....Executive Director  
 John Sheehy.....Director of Development and Marketing  
 George Babiak.....Production Manager  
 Liz Bell.....Director of Education  
 Megan Cramer.....Program Director  
 Diana Rojas.....Associate Program Director  
 Joshua A. Moody.....Development Assistant  
 Chris Ceraso.....Teen Dean  
 Iris A. Brown.....Graphic Designer  
 Jenisse Bouret, Azalea Rosario, Angel Silva.....Receptionists  
 Olivia Harris, Brent Rivers.....Interns

## The 52nd Street Project Board of Directors

Ben Barenholtz	Carol Ochs
Lisa Benavides	Willie Reale, founder
Rachel Chanoff	Gus Rogerson
Cathy Dantchik	Shirley Rumierk,
Carolyn C. DeSena	alumni member
Wendy Ettinger, chair emeritus	José Soto, Jr.,
Louis P. Friedman	alumni member
Stephen Graham, chair	Jenny Steingart
Larry Jones	Merritt Tilney
James McDaniel	Pamala Tyson
Frances McDormand	Wendy vanden Heuvel
Noël Mihalow	John A. Vassilaros



## PROJECT LEAR - THE SYNOPSIS - ACT 1

Lear has three daughters: Goneril, Regan, and Cordelia. His caretaker, Mrs. Gloucester, has two sons: Edgar (her legitimate son) and Edmund (born out of wedlock).

The ailing Lear decides to give up the responsibilities of his household. He calls his daughters together, intending to divide his great wealth and property between the three of them. He asks them to tell him how much they love him, and Goneril and Regan oblige with exaggerated expressions of their affection. Plainspoken Cordelia, however, states simply that he is her father and she loves him, and refuses to say more. Angry, Lear disinherits her and divides his property only between Goneril and Regan. Gloucester fails to prevent Lear from making this rash decision, but she does manage to help Cordelia by sending her towards Dover, where she will find shelter at Gloucester's property. The two remaining sisters reflect that his increasing unpredictability may have unpleasant consequences for them as well, and devise their own strategy for dealing with him.

Seeing how easy it is for a parent's allegiances to turn from one child to another, Edmund concocts a plan to make his mother turn against his brother Edgar, and make Edmund the legal heir. He forges a letter to himself from Edgar, which outlines a plan to kill their mother and take her money. When Gloucester discovers him reading this letter, she learns of the supposed plot and sends Edmund off to look for his brother. Edmund finds Edgar, and advises him to hide until further notice, which Edgar does.

Meanwhile, Lear has gone to stay at Goneril's house with his crew of one hundred followers, including his partner-in-crime, The Fool. Their wild behavior is so annoying that Goneril demands her father reduce his entourage. Angrily refusing, Lear storms out dramatically (followed by the Fool), declaring that he -- and his men -- will now stay with Regan. He sends the Fool ahead to Regan with a letter announcing his arrival.

That night, the cunning Edmund convinces Edgar that his mother is sending someone to kill him, and urges him to run away. As Edgar leaves, Edmund wounds himself to give the appearance of having fought to capture his brother. Gloucester swears that she will catch, punish, and disown Edgar, promising to give everything to Edmund. Just then, Regan appears. She has heard of Edgar's alleged plot and is impressed with Edmund, pressing him into her service. She then reveals that she has come to stay with Gloucester for the night in order to avoid being home when her father and his crew arrive at her house. She found out about their impending arrival from the Fool, whom she has put in the stocks for his rudeness, and brought with her to Gloucester's.

Meanwhile, Edgar runs from his home into the forest and disguises himself as a scratchy-voiced beggar, "Poor Tom."

Lear finally arrives at Gloucester's house, having followed Regan there. Furious at finding the Fool restrained, he storms in. Lear demands to come and stay with Regan, but she refuses, saying that she isn't at home and isn't prepared for his visit yet. Just then, Goneril appears. The two sisters confront their father together, insisting that if he is going to live with them, he should come to their houses alone, with no followers. Livid, Lear says he would rather be homeless than agree to such a thing, and storms out with the Fool into the stormy night. Gloucester vows to help Lear anyhow, and also decides to write to Cordelia in Dover, telling her about her sisters' actions.



## PROJECT LEAR - THE SYNOPSIS - ACT 1

Lear has three daughters: Goneril, Regan, and Cordelia. His caretaker, Mrs. Gloucester, has two sons: Edgar (her legitimate son) and Edmund (born out of wedlock).

The ailing Lear decides to give up the responsibilities of his household. He calls his daughters together, intending to divide his great wealth and property between the three of them. He asks them to tell him how much they love him, and Goneril and Regan oblige with exaggerated expressions of their affection. Plainspoken Cordelia, however, states simply that he is her father and she loves him, and refuses to say more. Angry, Lear disinherits her and divides his property only between Goneril and Regan. Gloucester fails to prevent Lear from making this rash decision, but she does manage to help Cordelia by sending her towards Dover, where she will find shelter at Gloucester's property. The two remaining sisters reflect that his increasing unpredictability may have unpleasant consequences for them as well, and devise their own strategy for dealing with him.

Seeing how easy it is for a parent's allegiances to turn from one child to another, Edmund concocts a plan to make his mother turn against his brother Edgar, and make Edmund the legal heir. He forges a letter to himself from Edgar, which outlines a plan to kill their mother and take her money. When Gloucester discovers him reading this letter, she learns of the supposed plot and sends Edmund off to look for his brother. Edmund finds Edgar, and advises him to hide until further notice, which Edgar does.

Meanwhile, Lear has gone to stay at Goneril's house with his crew of one hundred followers, including his partner-in-crime, The Fool. Their wild behavior is so annoying that Goneril demands her father reduce his entourage. Angrily refusing, Lear storms out dramatically (followed by the Fool), declaring that he -- and his men -- will now stay with Regan. He sends the Fool ahead to Regan with a letter announcing his arrival.

That night, the cunning Edmund convinces Edgar that his mother is sending someone to kill him, and urges him to run away. As Edgar leaves, Edmund wounds himself to give the appearance of having fought to capture his brother. Gloucester swears that she will catch, punish, and disown Edgar, promising to give everything to Edmund. Just then, Regan appears. She has heard of Edgar's alleged plot and is impressed with Edmund, pressing him into her service. She then reveals that she has come to stay with Gloucester for the night in order to avoid being home when her father and his crew arrive at her house. She found out about their impending arrival from the Fool, whom she has put in the stocks for his rudeness, and brought with her to Gloucester's.

Meanwhile, Edgar runs from his home into the forest and disguises himself as a scratchy-voiced beggar, "Poor Tom."

Lear finally arrives at Gloucester's house, having followed Regan there. Furious at finding the Fool restrained, he storms in. Lear demands to come and stay with Regan, but she refuses, saying that she isn't at home and isn't prepared for his visit yet. Just then, Goneril appears. The two sisters confront their father together, insisting that if he is going to live with them, he should come to their houses alone, with no followers. Livid, Lear says he would rather be homeless than agree to such a thing, and storms out with the Fool into the stormy night. Gloucester vows to help Lear anyhow, and also decides to write to Cordelia in Dover, telling her about her sisters' actions.

## ACT 2

The night grows stormier. Lear runs out into the storm, insane with grief and anger over his daughters' behavior. The Fool finally succeeds in dragging him towards a shack where they run into "Poor Tom" (Edgar in disguise). Gloucester comes rushing out into the storm, failing to recognize her son Edgar, and tells the Fool that she fears that Goneril and Regan want their father dead. Gloucester begs the Fool to hurry with Lear to Dover where they will be safe with Cordelia. The Fool drags Lear off through the storm towards Dover, while Edgar marvels at the sad state of the once-great Lear.

Back at Gloucester's house, Edmund has revealed his mother's communication with Cordelia to his new mistress Regan. When Regan and Goneril realize the extent of Gloucester's treachery -- that she helped Cordelia AND has now sent Lear to Dover to join her -- they plot revenge. When Gloucester returns home, she is confronted by Goneril and Regan, who tie her up and demand explanation. When Gloucester defiantly says that she didn't want to see a father as good as Lear destroyed by evil children, Regan declares that she shall never see such a thing, and the sisters gouge out her eyes in fury. When Gloucester calls on Edmund to help her, the sisters reveal that Edmund was the one who gave them the incriminating letter.

The blinded and devastated Gloucester stumbles out into the night, encountering Edgar, who is horrified by the sight of his blind mother. She declares that she is trying to get to Dover, where she will throw herself off the cliffs to end her worthless life. Still pretending to be "Poor Tom", Edgar offers to lead her to Dover, hoping to find a way to restore her desire to live.

Having found out that Cordelia plans to wage war against them, Goneril and Regan leave Gloucester's house separately to prepare their armies to go to battle. Edmund escorts Goneril to her house, where they flirt dangerously. Regan suspects something is going on between them, and warns Edmund to stay away from her sister. Now, everyone is making their way towards Dover -- Goneril, Regan, and Edmund with their armies, Lear with the Fool, and Gloucester with "Poor Tom". Cordelia is already there, furious at her sisters and ready to rumble.

When "Poor Tom" and Gloucester arrive in Dover, Edgar makes his blind mother believe that they are on the top of the highest cliff, although they are really on level ground. Gloucester believes him, and jumps, thinking to end her life. Edgar then runs up to her, pretending to be a stranger who watched her fall, and praises the miracle of her survival. Gloucester agrees, and vows to live.

When Lear and the Fool arrive in Dover, the Fool collapses from exhaustion and dies. Cordelia arrives to find Lear half-crazed, but he soon recognizes her and they have a tearful reunion.

When Goneril, Regan, and Edmund arrive in Dover, the sisters quarrel over their mutual desire for Edmund. He convinces them to focus on the business at hand, and they prepare for battle. Edmund realizes that one of the sisters must die for him to achieve his goals. The battle commences and Edgar (still pretending to be a stranger) leaves Gloucester in a safe place while he helps fight for Cordelia. But when Cordelia tragically loses the battle, he runs off. Edmund sends Lear and Cordelia to prison, with a Captain, whose instructions are to hang Cordelia in the prison and make it look like suicide. Goneril and Regan congratulate Edmund on the military victory, and Regan declares her intention to marry him, although she seems to be feeling very sick. They are interrupted by a mysterious stranger (Edgar, yet again!), who challenges Edmund to a duel. They fight, and Edmund falls. Devastated, Regan, now very sick, crawls towards Edmund's fallen body. Goneril, also devastated, chastises Edmund for fighting a stranger, and then carries the ailing Regan off to rest.

Edgar reveals himself to Edmund, and explains his journey towards Dover with their mother. He reveals that when he finally told Gloucester who he was, her heart was unable to handle all the emotion, and "burst, smilingly." Goneril then comes staggering back in, a bloody weapon in her hand. She confesses that she poisoned Regan, who is now dead, and in regret stabbed herself. She also dies. Edmund realizes they have both died because of him. Repenting, with his last breath he begs Edgar to run to the prison and rescue Lear and Cordelia, then he dies. But Edgar is too late. Lear enters carrying the dead body of Cordelia. Edgar tries to comfort him, but Lear, overcome, collapses and dies. Edgar stands alone, the sole heir to a devastated land.

## ACT 2

The night grows stormier. Lear runs out into the storm, insane with grief and anger over his daughters' behavior. The Fool finally succeeds in dragging him towards a shack where they run into "Poor Tom" (Edgar in disguise). Gloucester comes rushing out into the storm, failing to recognize her son Edgar, and tells the Fool that she fears that Goneril and Regan want their father dead. Gloucester begs the Fool to hurry with Lear to Dover where they will be safe with Cordelia. The Fool drags Lear off through the storm towards Dover, while Edgar marvels at the sad state of the once-great Lear.

Back at Gloucester's house, Edmund has revealed his mother's communication with Cordelia to his new mistress Regan. When Regan and Goneril realize the extent of Gloucester's treachery -- that she helped Cordelia AND has now sent Lear to Dover to join her -- they plot revenge. When Gloucester returns home, she is confronted by Goneril and Regan, who tie her up and demand explanation. When Gloucester defiantly says that she didn't want to see a father as good as Lear destroyed by evil children, Regan declares that she shall never see such a thing, and the sisters gouge out her eyes in fury. When Gloucester calls on Edmund to help her, the sisters reveal that Edmund was the one who gave them the incriminating letter.

The blinded and devastated Gloucester stumbles out into the night, encountering Edgar, who is horrified by the sight of his blind mother. She declares that she is trying to get to Dover, where she will throw herself off the cliffs to end her worthless life. Still pretending to be "Poor Tom", Edgar offers to lead her to Dover, hoping to find a way to restore her desire to live.

Having found out that Cordelia plans to wage war against them, Goneril and Regan leave Gloucester's house separately to prepare their armies to go to battle. Edmund escorts Goneril to her house, where they flirt dangerously. Regan suspects something is going on between them, and warns Edmund to stay away from her sister. Now, everyone is making their way towards Dover -- Goneril, Regan, and Edmund with their armies, Lear with the Fool, and Gloucester with "Poor Tom". Cordelia is already there, furious at her sisters and ready to rumble.

When "Poor Tom" and Gloucester arrive in Dover, Edgar makes his blind mother believe that they are on the top of the highest cliff, although they are really on level ground. Gloucester believes him, and jumps, thinking to end her life. Edgar then runs up to her, pretending to be a stranger who watched her fall, and praises the miracle of her survival. Gloucester agrees, and vows to live.

When Lear and the Fool arrive in Dover, the Fool collapses from exhaustion and dies. Cordelia arrives to find Lear half-crazed, but he soon recognizes her and they have a tearful reunion.

When Goneril, Regan, and Edmund arrive in Dover, the sisters quarrel over their mutual desire for Edmund. He convinces them to focus on the business at hand, and they prepare for battle. Edmund realizes that one of the sisters must die for him to achieve his goals. The battle commences and Edgar (still pretending to be a stranger) leaves Gloucester in a safe place while he helps fight for Cordelia. But when Cordelia tragically loses the battle, he runs off. Edmund sends Lear and Cordelia to prison, with a Captain, whose instructions are to hang Cordelia in the prison and make it look like suicide. Goneril and Regan congratulate Edmund on the military victory, and Regan declares her intention to marry him, although she seems to be feeling very sick. They are interrupted by a mysterious stranger (Edgar, yet again!), who challenges Edmund to a duel. They fight, and Edmund falls. Devastated, Regan, now very sick, crawls towards Edmund's fallen body. Goneril, also devastated, chastises Edmund for fighting a stranger, and then carries the ailing Regan off to rest.

Edgar reveals himself to Edmund, and explains his journey towards Dover with their mother. He reveals that when he finally told Gloucester who he was, her heart was unable to handle all the emotion, and "burst, smilingly." Goneril then comes staggering back in, a bloody weapon in her hand. She confesses that she poisoned Regan, who is now dead, and in regret stabbed herself. She also dies. Edmund realizes they have both died because of him. Repenting, with his last breath he begs Edgar to run to the prison and rescue Lear and Cordelia, then he dies. But Edgar is too late. Lear enters carrying the dead body of Cordelia. Edgar tries to comfort him, but Lear, overcome, collapses and dies. Edgar stands alone, the sole heir to a devastated land.

The 52nd Street Project gratefully acknowledges the support of the following foundations and corporations: The Altman Foundation; AON; APA Talent Agency; Big Wood Foundation; BKSK Architects; Bloomberg; The Brenner Family Foundation; The Margaret A. Cargill Foundation; Carnegie Corporation of New York; CBS Corporation; CMR Comedy; Consolidated Edison; The Dermot Company; The Educational Foundation Of America; The Dramatists Guild Fund; Dramatists Play Service; Gio Productions, Inc.; The Horace W. Goldsmith Foundation; The William & Mary Greve Foundation; Holland Lodge Foundation, Inc.; Saul Horowitz, Jr. Fund; Hudson Scenic Studio; JKW Foundation; Kresge Foundation; Law Offices of Claudia Wagner; Lightspeed Financial LLC; James A. Macdonald Foundation; Ann M. Martin Foundation; Mellon Equity Associated, Lp; LuEsther T. Mertz Foundation; J.P. Morgan Charitable Trust; The New World Foundation; Newman's Own Foundation; The New York Times Company Foundation; NYFA; Primiano Electric Corp.; Tony Randall Theatrical Fund; Jonathan Rose Companies, Inc.; Shapiro & Lobel; The Shaw Family Endowment Fund; The Shubert Organization; St. Vincent De Paul Foundation; The Harold & Mimi Steinberg Charitable Trust; Stranahan Foundation; Surdna Foundation; Susquehanna Foundation, Corp.; Tax Pro Financial Network, Inc.; Theatre Communications Group, Inc.; Watkins, Inc.; Wiener Family Foundation; John A. Vassilaros & Son, Inc; Yorke Construction Corp. In addition, the following individuals made gifts over \$250 to The 52nd Street Project this past year. (list current as of 7/23/09):

Robert Abrams & Cynthia Vance	Liz Flahive & Jeff Cox	John Lyons	David Ross & Laura Ross
Emily Armstrong	Kristen Frank & Tamir Hashem	Grace Lyu-Volkhausen	Daryl Roth
Dylan & Becky Baker	Louis & Patrice Friedman	Greg MacPherson & Jane Perlmutter	Robert Saget
Jessica Bauman & Ben Posel	Connie Garrido & Ray Rotolo	Steve Martin	Marcia Santoni & John Morris
Lisa Benavides & Tim Nelson	Beverly Gasner	Freddie Gershon	Meredith Beeuwkes Scarlet
Gavin Berger & Craig Berggren	Christina Gerber	Drew McCoy & Amy Aquino	Karin & Tom Schall
Rajeev Bhandari	Freddie Gershon	Frances McDormand & Joel Coen	Whitney Scott & Peter Jacobson
Pat Birch	Jillian Gersten & Brian Shuman	Ann McLarty & Chuck Knauss	Robert Shaffron & John Davis
Kerrison Black	Alex Gersten-Vassilaros & John A. Vassilaros	Josie Merck & Jim Stevenson	Pam Shaw & Victor Symis
Lewis Black	Nancy Giles	Al Minafo	Jonathan Sheffer
Andrew Blackman & Tatiana Rutkowski	Tony Goldwyn & Jane Musky	Eric Mindich & Stacey Mindich	Peter Shinoda
Lawrence Blau	James Gosnell	Emily & John Morgan	Meg Simon
Emily Blavatnik	Richard Gottfried	Bruce Moulton	Tom Slaughter
Allison & Robert Blinken	Stephen & Cathy Graham	Karen "Special K" Munkel	Robert Smigel & Michelle Smigel
Becky Browder & Ted Neustadt	Susannah Gray & John Lyons	Patricia M. Murphy, Esq. & Adam Spilka	Jonathan & Jennifer Soros
Al Cardinali	Jan Gura & Alan Pickman	John Mustin & Kimberly Mustin	Paul Logan
Robert & Holly Carter	David & Ann Hausmann	Fred Nelson	Dimitri & Helen Sogoloff
Judy Cashmore	Sally Holmes & Doug Curtis	Randy & Rona Nelson	Gavin & Joan Solotar
Rachel Chanoff	William Holtzman & S. Sylvia Shepard	Ruth Nelson	Steven & Farrell Starker
Kirk & Katherine Holt Citron	Katy Homans & Patterson Sims	James Neuberger & Helen Stambler	Jenny & Jon Steingart
Ronald Cohen	Saul Horowitz & Sarah Horowitz & David Venarde	Cynthia Nixon	Michael & Marjorie Stern
Ruth Cohen & Bob Usdin	Andrea Johnson	Rachel & Larry Norton	Michael Stone
Judith-Ann Corrente	Douglas & Katie Jordan	Carol Ochs & Bruce MacVittie	David Suehsdorf & Janet E. Muir
David Costabile	Bob Joy	Jacki Ochs & Jan Kroeze	Richard Sweren
Billy Crudup	Michael Joyce	Paula Park	Jeanine Tesori
Arthur Dantchik	Maurice Kanbar	Jessica Pell	Anne Torsiglieri & Michael Bernard
Cathy Dantchik	Cindy Kaplan & David Froelich	Elizabeth Peters	Pamala & Sean Tyson
Leslie Dantchik	Stephen & Susan Ko	Peter & Ana Rosa Phillips	Carol L. Nadell & Richard E. Van Deusen
Peter & Judith Dawkins	Judy Kuhn & David Schwab	Michael Pillinger	Wendy vanden Heuvel & Brad Coley
Jim Delaney	Howard Laks & Irena Laks	Peter & Helen Randolph	Ed Vassallo
Neil DeSena & Carolyn DeSena	Michael P. Lawrence	Willie Reale & Jenny Gersten	Joe Versace
William Dockery	Warren Leight	Jennifer Reichle	Mary Pat Walsh
Richard & Rebecca Dresser	Robert Sean Leonard & Gabby Salick	Jacquelyn Reingold	Lynn & Sam Waterston
Adam Dubin & Rochelle Dubin	Tom Leonardis	Ira Resnick	Ali Marsh
Peter Jay Fernandez & Denise Burse	Martin Levine	Burt Resnick & Judy Resnick	Jane Bolster & Steve Wertimer
Suzanne Fine & Christian Salomone	Harold Levison & Ilyse Levison	Kevin Louis Reymond & Dana Lee Reymond	Michael & Zena Wiener
Angelina Fiordellisi & Matt Williams	Anna Li & Frank Sposato	Michael Richter & Veronica Richter	Richard Willis & Jill Willis
Peter Fisch & Jill Levy Fisch	Melissa Liebling-Goldberg & John Barrett	Joseph Rokacz & Larry Gordon	Geoffrey Wills
Katie Flahive	Michael & Marjorie Loeb	David Rosenberg	Frank Wood
	Mark Lonow & JoAnne Astrow	David Rosenberg	Lynne Zeavin & Donald Moss

## The 52nd Street Project Presents

Gus Rogerson,  
Artistic Director

Carol Ochs,  
Executive Director

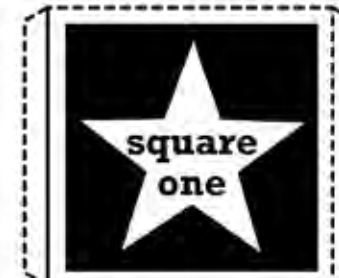

The  
Original  
Plays

Friday, July 24<sup>th</sup>  
7:30 pm  
Saturday, July 25<sup>th</sup>  
7:30 pm  
Sunday, July 26<sup>th</sup>  
3:00 pm

Ensemble  
Studio  
Theatre  
549 W. 52nd St.  
2nd Floor

The  
**BLOCK  
ISLAND**  
One-on-Ones



1. cut along dotted lines.
2. crease solid black lines.
3. fold into cube with flaps tucked under.
4. tape together with see-through tape.

# Square One: The Original Plays

The Annual Block Island One-on-Ones - July, 2009 at the Ensemble Studio Theatre

## The 52nd Street Project Staff

Gus Rogerson, Artistic Director  
 Carol Ochs, Executive Director  
 John Sheehy, Director of Development and Marketing  
 George Babiak, Production Manager  
 Liz Bell, Director of Education  
 Megan Cramer, Program Director  
 Diana Rojas, Associate Program Director  
 Josh Moody, Development Assistant  
 Jan Gura, Capital Campaign Consultant  
 Chris Ceraso, Teen Dean  
 Iris A. Brown, Graphic Designer  
 Azalea Rosario, Angel Silva, Teen Receptionists  
 Jenisse Bouret, Teen Homework Helper  
 Olivia Harris and Brent Rivers, Interns

## "Square One" Production Staff

Composer/Music Director Klm D. Sherman	Megan Cramer, Olivia Harris, Rafael Irrizarry III, Josh Moody,
Set Designer Kevin Joseph Roach	John Sheehy
Lighting Designer Greg MacPherson	Backstage Crew Doris Alcantara,
Costume Designer Katherine Brown	Carlos Dumé, Olivia Harris, Brent Rivers
Assistant Costume Designer Doris Alcantara	Load-in and Light-hang Crew Doris Alcantara, Jason Hare,
Goddess of Sound Vanessa Valdes	Ray Harold, Christopher Randolph, Tom Schall
Stage Manager Casey Keeler	House Managers Liz Bell,
Slide Designs George Babiak and the Project Slide Archive	Josh Moody, Karin Schall
Prop Design Team Doris Alcantara, George Babiak, Liz Bell, Katherine Brown,	Flyer/Program Art: Linda Beck
	Chefs Martha Velie-Gass, Pat Ritter



The One-on-One Program is made possible with public funds from The New York State Council on the Arts, a state agency; and the New York City Department of Cultural Affairs. The 52nd Street Project is supported by funds from the National Endowment for the Arts. The 52nd Street Project is a member of Art/NY and a participant in the New Generations Program, funded by Doris Duke Charitable Foundation/ The Andrew W. Mellon Foundation and administered by Theatre Communications Group, the national organization for the American Theater.

## COOL STUFF ON SALE IN THE LOBBY! FABULOUS FLYER BARS ..... \$2.50, \$2, \$1.50

AND FEATURING SHEL SILVERSTEIN'S  
 "FIVEY AND TWOEY" LOGO:

PROJECT T-SHIRTS AND TANKS.....\$12.00  
 PROJECT CAPS.....\$20.00  
 PROJECT MUGS .....\$5.00  
 PROJECT PENCIL 3-PACK .....\$1.00  
 PROJECT NOTEBOOK.....\$5.00

Thank you for coming to SQUARE ONE! If you are not on our mailing list (or if your address has changed), please fill out this form and give it to us on your way out or mail it to the address below. We would also like to know if you are interested in becoming a volunteer. We need help in all areas, so be sure to fill out the entire form.

PLEASE ADD ME TO YOUR MAILING LIST:

07/09

NAME \_\_\_\_\_

ADDRESS \_\_\_\_\_

CITY \_\_\_\_\_

STATE \_\_\_\_\_

ZIP \_\_\_\_\_

HOME PHONE \_\_\_\_\_

DAYTIME OR MOBILE PHONE \_\_\_\_\_

E-MAIL ADDRESS \_\_\_\_\_

MY OCCUPATION \_\_\_\_\_

MY HOBBIES \_\_\_\_\_

### YES, I WOULD LIKE TO BE OF HELP. I CAN:

- |   |   |  |
|---|---|--|
| <input type="checkbox"/> Help load in and out for shows | <input type="checkbox"/> Draw and/or paint  | <input type="checkbox"/> Help kids with homework |
| <input type="checkbox"/> Hang lights                    | <input type="checkbox"/> Help with mailings | <input type="checkbox"/> Teach kids a skill      |
| <input type="checkbox"/> Work on a backstage crew       | <input type="checkbox"/> Do office work     | <input type="checkbox"/> Be a chef at an event   |
| <input type="checkbox"/> Do graphic design              | <input type="checkbox"/> Design sound       | <input type="checkbox"/> Design and sew costumes |
| <input type="checkbox"/> Other (please specify) _____   |   |  |

### MY SCHEDULE IS:

- Very flexible. I'm often available during weekdays.  
 Somewhat flexible. I can help on the occasional morning or afternoon during the week.  
 Not very flexible at all, but I've got some free time on evenings and weekends.

If you would like to mail this (and you're always welcome to enclose a tax-deductible contribution), you can send it to: The 52nd Street Project, 500 West 52nd St., #2E, New York, NY 10019. Or fax it to (212) 333-5598.



# COMING UP SOON!

The 52nd Street Project Presents:

Gus Rogerson, Artistic Director  
Carol Ochs, Executive Director

back to  
**square one**

wow!

MORE  
Original  
Plays

Friday, Aug. 21<sup>st</sup>  
7:30 pm  
Saturday, Aug. 22<sup>nd</sup>  
7:30 pm  
Sunday, Aug. 23<sup>rd</sup>  
3:00 pm

Ensemble  
Studio  
Theatre  
549 W. 52nd St.  
2nd Floor

THE  
WAREHAM, MASS.  
ONE-ON-ONES

Come see the next batch of One-on-Ones next month in this very space!

10 new kids!  
10 new adults!  
10 new plays!

Same old theme!

52  
The 52nd Street Project

## The 52nd Street Project Board of Directors

Ben Barenholtz	Carol Ochs
Lisa Benavides	Willie Reale, founder
Rachel Chanoff	Gus Rogerson
Cathy Dantchik	Shirley Rumierk, alumni member
Carolyn DeSena	José Soto, Jr., alumni member
Wendy Ettinger, chair emeritus	Jenny Steingart
Louis P. Friedman	Merritt Tilney
Stephen Graham, chair	Pamala Tyson
James McDaniel	Wendy vanden Heuvel
Frances McDormand	John A. Vassilaros
Noël Mihalow	

### What's Going On Here?

The 52nd Street Project is a non-profit organization that brings children from the Hell's Kitchen neighborhood together with professional theater artists to create original theater. SQUARE ONE! is a production of our One-on-One program, which is designed to give children the opportunity to go away for one-week stays in the country and enjoy the undivided attention of a professional theater artist who serves as friend, mentor, and collaborator.

### In-Kind Contributions

The Murphy Law Office; Abbeville Press; Stephanie Berger Photography; Lewis Black; Richard Blackstone; Bloomingdale's; Iris A. Brown Design; City Winery; A Curran Affair; Kate Cusack; EMI Records; Yorke Construction; The S.F. Giants; Newman's Own; Macy's; PineRock; The N/Nickelodeon; Pharma/Omni Printing; Shapiro Lobel, LLP; Wendy Stulberg; The Yankees; John A. Vassilaros & Sons; Watkins Incorporated; Mayor's Office of Film & Television; Boylan's Bottling Co.; Hudson Scenic; and Paul, Weiss, Rifkind, Wharton & Garrison LLP.

### Special Thanks

Our Host Families – Elliot & Amy Nerenberg; Sue Black; The Homans Family; Jennifer & Elliot Taubman; Ron & Judy Tierney; Joya Verde & Virginia Dare; Martha Velie-Gass & Pat Ritter; and our headquarters host Dr. Christina Biaggi. Sincere thanks to our chefs Pat Ritter & Martha Velie-Gass; Lynn Reale; Kate Butcher & everyone at Block Island Realty; Block Island Maritime Institute; Block Island Airport; McQuade's Marketplace; Robbie Brown; Rita & Steve Draper; Amelia Gallant at the Block Island Grocery; Cindy & Stan Geer at the Depot; Glenn & Annie Hall; Interstate Navigation; Josie Merck & Jim Stevenson; Kim Gaffett and the Ocean View Foundation; Ben Wohlberg; Amanda Gass; Greg MacPherson and Doug Nervik; and Bruce MacVittie.



**BE ON THE LOOKOUT!  
WE ARE ALWAYS  
SEARCHING FOR INTERNS.**

If you know of any college or graduate students who might enjoy working with us, playing with us, and going on trips with us for a semester, please have them contact George Babiak or Megan Cramer. We are especially looking for interns for the Fall of 2009 and the Spring of 2010. Thanks!

## Square One: The Original Plays - ACT 1

All original music composed by Kim D. Sherman

### THE CASE OF THE SWEET-TOOTHED BUTLER

Written and directed by Josh Moody for Lucas Ruedel, age 11

Sherlock Holmes ..... Lucas Ruedel  
Watson ..... Josh Moody  
Butler ..... George Babiak  
J. Wellington Piccadilly ..... John Sheehy

Work isn't Work Without Play lyrics by Josh Moody.

### THUNDER FAST

Written by Sharyn Rothstein & directed by Annie Henk  
for Daquan Nelson, age 13

Thunder Bolt ..... Daquan Nelson  
Jane Jane ..... Annie Henk  
Reporters ..... Olivia Harris, Doris Alcantara,  
George Babiak, Brent Rivers, Carlos Dumé

Best of the Best lyrics by Sharyn Rothstein.

### THE EXTREME PAINTER

Written by Sean Kenealy and directed by Jackie Chung  
for Elena Caballero, age 12

Anna Green ..... Elena Caballero  
Suzie ..... Jackie Chung

Paint What You Love lyrics by Sean Kenealy.

### HOT DOCS

Written by Jeff Cox and directed by Tim Cain for Rene Paul Santiago, age 10

Dr. McSmoldery ..... Rene Paul Santiago  
Dr. McSimmery ..... Tim Cain  
The Chief ..... Dr. Brent Rivers, MD  
Jenny ..... Megan Cramer

Attractive Surgeons, Don't Fall lyrics by Jeff Cox.

### ESCAPE FROM GUMDROP MOUNTAIN

Written by Michael Bernard and directed by Erin Mallon  
for Alizette Zapata, age 11

Piece Two ..... Alizette Zapata  
Piece One ..... Erin Mallon  
Granny Nutt ..... Megan Cramer  
New Piece ..... Carlos Dumé  
Supercool Piece ..... Brent Rivers  
Thimble ..... George Babiak

The Candy Land Song, Beyond The Board lyrics by Michael Bernard.

## Square One: The Original Plays - ACT 2

### ROCK AGE

Written and directed by John Sheehy  
for Jeremy Sanchez, age 13

Crom ..... Jeremy Sanchez  
Trog ..... John Sheehy

Wanna Rock lyrics by John Sheehy.

### THE GREATEST MEMORY ON EARTH

Written by Pia Wilson and directed by Crystal Dickinson  
for Elizabeth Vazquez, age 12

Penelope ..... Elizabeth Vazquez  
Dee ..... Crystal Dickinson

Girlfriend Grab lyrics by Pia Wilson.

### OUTTA THE PARK

Written by Sascha Paladino and directed by Kyle Haden  
for Joseph Vasquez, age 11

Neil A. Namai ..... Joseph Vasquez  
Billy Burton ..... Kyle Haden  
Sal ..... Brent Rivers  
FBI Agent/Announcer ..... Carlos Dume

Aliens and Baseball lyrics by Sascha Paladino.

### GREENER STILL

Written and directed by Katie Meister  
for Dante Quiñones, age 11

Franz ..... Dante Quiñones  
Mumbles ..... Katie Meister  
Mailman ..... Doris Alcantara  
Waiter ..... Brent Rivers

Walk the Walk, Anything and Everything lyrics by Katie Meister.

### IT ANT OVER 'TIL IT'S OVER

Written by Cynthia Kaplan and directed by Brandon Dirden  
for Tiara Varela, age 11

Carla ..... Tiara Varela  
Bob ..... Brandon Dirden

Our Rock lyrics by Cynthia Kaplan.

Square One Theme Song lyrics by John Sheehy

The 52nd Street Project gratefully acknowledges the support of the following foundations and corporations: The Altman Foundation; AON; APA Talent Agency; Big Wood Foundation; BSK Architects; Bloomberg; The Brenner Family Foundation; The Margaret A. Cargill Foundation; Carnegie Corporation of New York; CBS Corporation; CMR Comedy; Consolidated Edison; The Dermot Company; The Educational Foundation Of America; The Dramatists Guild Fund; Dramatists Play Service; Gio Productions, Inc.; The Horace W. Goldsmith Foundation; The William & Mary Greve Foundation; Holland Lodge Foundation, Inc.; Saul Horowitz, Jr. Fund; Hudson Scenic Studio; JKW Foundation; Kresge Foundation; Law Offices of Claudia Wagner; Lightspeed Financial LLC; James A. Macdonald Foundation; Ann M. Martin Foundation; Mellon Equity Associated, Llp; LuEsther T. Mertz Foundation; J.P. Morgan Charitable Trust; The New World Foundation; Newman's Own Foundation; The New York Times Company Foundation; NYFA; Primiano Electric Corp.; Tony Randall Theatrical Fund; Jonathan Rose Companies, Inc.; Shapiro & Lobel; The Shaw Family Endowment Fund; The Shubert Organization; St. Vincent De Paul Foundation; The Harold & Mimi Steinberg Charitable Trust; Stranahan Foundation; Surdna Foundation; Susquehanna Foundation, Corp.; Tax Pro Financial Network, Inc.; Theatre Communications Group, Inc.; Watkins, Inc.; Wiener Family Foundation; John A. Vassilaros & Son, Inc; Yorke Construction Corp. In addition, the following individuals made gifts over \$250 to The 52nd Street Project this past year. (list current as of 7/23/09):

Robert Abrams & Cynthia Vance	Liz Flahive & Jeff Cox	John Lyons	David Ross & Laura Ross
Emily Armstrong	Kristen Frank & Tamir Hashem	Grace Lyu-Volkhausen	Daryl Roth
Dylan & Becky Baker	Louis & Patrice Friedman	Greg MacPherson & Jane Perlmutter	Robert Saget
Jessica Bauman & Ben Posel	Beverly Gasner	Steve Martin	Marcia Santoni & John Morris
Lisa Benavides & Tim Nelson	Christina Gerber	Drew McCoy & Amy Aquino	Meredith Beeuwkes Scarlet
Gavin Berger & Craig Berggren	Freddie Gershon	Frances McDormand & Joel Coen	Karin & Tom Schall
Rajeev Bhandari	Jillian Gersten & Brian Shuman	Joel Coen	Whitney Scott & Peter Jacobson
Pat Birch	Alex Gersten-Vassilaros & John A. Vassilaros	Ann McLarty & Chuck Knauss	Robert Shaffron & John Davis
Kerrison Black	Nancy Giles	Josie Merck & Jim Stevenson	Pam Shaw & Victor Symis
Lewis Black	Tony Goldwyn & Jane Musky	Al Minafo	Jonathan Sheffer
Andrew Blackman & Tatiana Rutkowski	James Gosnell	Eric Mindich & Stacey Mindich	Peter Shinoda
Lawrence Blau	Richard Gottfried	Emily & John Morgan	Meg Simon
Emily Blavatnik	Stephen & Cathy Graham	Bruce Moulton	Tom Slaughter
Allison & Robert Blinken	Susannah Gray & John Lyons	Karen "Special K" Munkel	Robert Smigel & Michelle Smigel
Becky Browder & Ted Neustadt	Jan Gura & Alan Pickman	Patricia M. Murphy, Esq. & Adam Spilka	Jonathan & Jennifer Soros
Al Cardinali	David & Ann Hausmann	John Mustin & Kimberly Mustin	Paul Logan
Robert & Holly Carter	Sally Holmes & Doug Curtis	Fred Nelson	Dimitri & Helen Sogoloff
Judy Cashmore	William Holtzman & S. Sylvia Shepard	Randy & Rona Nelson	Gavin & Joan Solotar
Rachel Chanoff	Katy Homans & Patterson Sims	Ruth Nelson	Steven & Farrell Starker
Kirk & Katherine Holt Citron	Saul Horowitz	James Neuberger & Helen Stambler	Jenny & Jon Steingart
Ronald Cohen	Sarah Horowitz & David Venarde	Cynthia Nixon	Michael & Marjorie Stern
Ruth Cohen & Bob Usdin	Andrea Johnson	Rachel & Larry Norton	Michael Stone
Judith-Ann Corrente	Douglas & Katie Jordan	Carol Ochs & Bruce MacVittie	David Suehsdorf & Janet E. Muir
David Costabile	Bob Joy	Jacki Ochs & Jan Kroeze	Richard Sweren
Billy Crudup	Michael Joyce	Paula Park	Jeanine Tesori
Arthur Dantchik	Maurice Kanbar	Jessica Pell	Anne Torsiglieri & Michael Bernard
Cathy Dantchik	Cindy Kaplan & David Froelich	Elizabeth Peters	Pamala & Sean Tyson
Leslie Dantchik	Stephen & Susan Ko	Peter & Ana Rosa Phillips	Pamala & Sean Tyson
Peter & Judith Dawkins	Judy Kuhn & David Schwab	Judy Goldman & Richard E. Van Deusen	Carol L. Nadell & Richard E. Van Deusen
Jim Delaney	Howard Laks & Irena Laks	Michael Pillinger	Wendy vanden Heuvel & Brad Coley
Neil DeSena & Carolyn DeSena	Michael P. Lawrence	Peter & Helen Randolph	Ed Vassallo
William Dockery	Warren Leight	Willie Reale & Jenny Gersten	Joe Versace
Richard & Rebecca Dresser	Robert Sean Leonard & Gaby Salick	Jennifer Reichle	Mary Pat Walsh
Adam Dubin & Rochelle Dubin	Tom Leonardis	Jacquelyn Reingold	Lynn & Sam Waterston
Peter Jay Fernandez & Denise Burse	Martin Levine	Ira Resnick	Ali Marsh
Suzanne Fine & Christian Salomone	Harold Levison & Ilyse Levison	Burt Resnick & Judy Resnick	Jane Bolster & Steve Wertimer
Angelina Fiordellisi & Matt Williams	Anna Li & Frank Sposato	Kevin Louis Raymond & Dana Lee Raymond	Michael & Zena Wiener
Peter Fisch & Jill Levy Fisch	Melissa Liebling-Goldberg & John Barrett	Michael Richter & Veronica Richter	Richard Willis & Jill Willis
Katie Flahive	Michael & Marjorie Loeb	Joseph Rokacz & Larry Gordon	Geoffrey Wills
	Mark Lonow & JoAnne Astrow	David Rosenberg	Frank Wood
			Lynne Zeavin & Donald Moss

## The 52nd Street Project Presents

Gus Rogerson,  
Artistic Director  
Carol Ochs,  
Executive Director

The 52nd Street Project Presents:

**BACK TO square one**

**MORE Original Plays**

Friday, Aug. 21<sup>st</sup>  
7:30 pm

Saturday, Aug. 22<sup>nd</sup>  
7:30 pm

Sunday, Aug. 23<sup>rd</sup>  
3:00 pm

**Ensemble Studio Theatre**  
549 W. 52nd St.  
2nd Floor

**THE WAREHAM, MASS. ONE-ON-ONES**

**52**  
The 52nd Street Project

1. cut along dotted lines.
2. crease solid black lines.
3. fold into cube with flaps tucked under.
4. tape together with see-through tape.

## Back To Square One: More Original Plays

The Annual Wareham, MA One-on-Ones - August, 2009 at the Ensemble Studio Theatre

### The 52nd Street Project Staff

Gus Rogerson, Artistic Director  
 Carol Ochs, Executive Director  
 John Sheehy, Director of Development and Marketing  
 George Babiak, Production Manager  
 Liz Bell, Director of Education  
 Megan Cramer, Program Director  
 Diana Rojas, Associate Program Director  
 Josh Moody, Development Assistant  
 Jan Gura, Capital Campaign Consultant  
 Chris Ceraso, Teen Dean  
 Iris A. Brown, Graphic Designer  
 Azalea Rosario, Teen Receptionist  
 Jenisse Bouret, Teen Homework Helper  
 Olivia Harris and Brent Rivers, Interns

### "Back to Square One" Production Staff

#### Composer/Music Director

Patrick Barnes

#### Set Designer

Kevin Joseph Roach

#### Lighting Designer

Greg MacPherson

#### Costume Designers

Crystal Thompson  
 and Kathleen Doyle

#### Nabob of Noise

Maury Schott

#### Stage Manager

Karen Munkel

#### Load-in and Light-hang Crew

Jason Hare, Ray Harold,  
 Karen Munkel, Christopher Randolph

#### Slide Designs

George Babiak and the  
 Project Slide Archive

#### Prop Design Team

George Babiak, Megan Cramer,  
 Olivia Harris, Aidan Martinez,  
 Josh Moody, Karen Munkel,  
 Brent Rivers, Lee Rosen,  
 John Sheehy

#### Backstage Crew

Devin Gonzalez, Olivia Harris,  
 Rafael Irizarry III, Brent Rivers,  
 Mordecai Santiago

#### House Managers

Liz Bell, Josh Moody,  
 Karin Schall

#### Flyer/Program Art: Linda Beck

#### Chefs

Liz Bell, Carol Ochs,  
 John Sheehy

#### Teen Counselor

Mordecai Santiago



The One-on-One Program is made possible with public funds from The New York State Council on the Arts, a state agency; and the New York City Department of Cultural Affairs. The 52nd Street Project is supported by funds from the National Endowment for the Arts. The 52nd Street Project is a member of Art/NY and a participant in the New Generations Program, funded by Doris Duke Charitable Foundation/ The Andrew W. Mellon Foundation and administered by Theatre Communications Group, the national organization for the American Theater.

## COOL STUFF ON SALE IN THE LOBBY!

FABULOUS FLYER BARS ..... \$2.50, \$2, \$1.50

### AND FEATURING SHEL SILVERSTEIN'S "FIVEY AND TWOEY" LOGO:

PROJECT T-SHIRTS AND TANKS.....\$12.00  
 PROJECT CAPS.....\$20.00  
 PROJECT MUGS .....\$5.00  
 PROJECT PENCIL 3-PACK .....\$1.00  
 PROJECT NOTEBOOK.....\$5.00

Thank you for coming to BACK TO SQUARE ONE! If you are not on our mailing list (or if your address has changed), please fill out this form and give it to us on your way out or mail it to the address below. We would also like to know if you are interested in becoming a volunteer. We need help in all areas, so be sure to fill out the entire form.

### PLEASE ADD ME TO YOUR MAILING LIST:

08/09

NAME \_\_\_\_\_

ADDRESS \_\_\_\_\_

CITY \_\_\_\_\_

STATE \_\_\_\_\_

ZIP \_\_\_\_\_

HOME PHONE \_\_\_\_\_

DAYTIME OR MOBILE PHONE \_\_\_\_\_

E-MAIL ADDRESS \_\_\_\_\_

MY OCCUPATION \_\_\_\_\_

MY HOBBIES \_\_\_\_\_

### YES, I WOULD LIKE TO BE OF HELP. I CAN:

- |   |   |  |
|---|---|--|
| <input type="checkbox"/> Help load in and out for shows | <input type="checkbox"/> Draw and/or paint  | <input type="checkbox"/> Help kids with homework |
| <input type="checkbox"/> Hang lights                    | <input type="checkbox"/> Help with mailings | <input type="checkbox"/> Teach kids a skill      |
| <input type="checkbox"/> Work on a backstage crew       | <input type="checkbox"/> Do office work     | <input type="checkbox"/> Be a chef at an event   |
| <input type="checkbox"/> Do graphic design              | <input type="checkbox"/> Design sound       | <input type="checkbox"/> Design and sew costumes |
| <input type="checkbox"/> Other (please specify) _____   |   |  |

### MY SCHEDULE IS:

- Very flexible. I'm often available during weekdays.
- Somewhat flexible. I can help on the occasional morning or afternoon during the week.
- Not very flexible at all, but I've got some free time on evenings and weekends.

If you would like to mail this (and you're always welcome to enclose a tax-deductible contribution), you can send it to: The 52nd Street Project, 500 West 52nd St., #2E, New York, NY 10019. Or fax it to (212) 333-5598.

**COMING UP SOON!**



**YOU ARE HERE!**  
**NEW PLAYS IN NEW PLACES**

THE ANNUAL PLAYBACK SHOW  
8 kids write plays for themselves and their adult partners to perform together. It's like the One-on-Ones, but in reverse.

**OCTOBER 23-25, 2009**  
Don't miss this extra-special show, the very first to be performed in our beautiful new theater at 789 10th Avenue.



**BE ON THE LOOKOUT!**  
**WE ARE ALWAYS**  
**SEARCHING FOR INTERNS.**

If you know of any college or graduate students who might enjoy working with us, playing with us, and going on trips with us for a semester, please have them contact George Babiak or Megan Cramer. We are especially looking for interns for the Spring and Summer of 2010. Thanks!

The 52nd Street Project Board of Directors

Ben Barenholtz	Carol Ochs
Lisa Benavides	Willie Reale, founder
Rachel Chanoff	Gus Rogerson
Cathy Dantchik	Shirley Rumierk, alumni member
Carolyn DeSena	José Soto, Jr., alumni member
Wendy Ettinger, chair emeritus	Jenny Steingart
Louis P. Friedman	Merritt Tilney
Stephen Graham, chair	Pamala Tyson
James McDaniel	Wendy vanden Heuvel
Frances McDormand	John A. Vassilaros
Noël Mihalow	

What's Going On Here?

The 52nd Street Project is a non-profit organization that brings children from the Hell's Kitchen neighborhood together with professional theater artists to create original theater. **BACK TO SQUARE ONE!** is a production of our One-on-One program, which is designed to give children the opportunity to go away for one-week stays in the country and enjoy the undivided attention of a professional theater artist who serves as friend, mentor, and collaborator.

In-Kind Contributions

The Murphy Law Office; Abbeville Press; Stephanie Berger Photography; Lewis Black; Richard Blackstone; Bloomingdale's; Iris A. Brown Design; City Winery; A Curran Affair; Kate Cusack; EMI Records; Yorke Construction; The S.F. Giants; Newman's Own; Macy's; PineRock; The N/Nickelodeon; Pharma/Omni Printing; Shapiro Lobel, LLP; Wendy Stulberg; The Yankees; John A. Vassilaros & Sons; Watkins Incorporated; Mayor's Office of Film & Television; Boylan's Bottling Co.; Hudson Scenic; and Paul, Weiss, Rifkind, Wharton & Garrison LLP.

Special Thanks

Our Host Families – Emily & John Morgan; Patty & David Straus; Gray & Rosemary Watson; Bob & Marina Whitman; Sidney Worthen & David Pearce; Joe McNay; Peter, Helen & Christopher Randolph.

Sincere Thanks to Robin Morse, Lucy & Francis Rogerson; Bob Krystolfolski; George Hurd.

A hearty round of applause for Billy, Paul, Tim, Annie, and the rest of the staff of the Ensemble Studio Theater for providing their space on this occasion and countless others over the last 28 years.

## Back to Square One: More Original Plays - ACT 1

All original music composed by Patrick Barnes  
Back to Square One Theme Song lyrics by Megan Cramer

### MORE THAN YOU KNOW

Written & Directed by Carlo Alban  
for Nathaly Trinidad, age 11. Costume Designer: Kathleen Doyle  
The Great Fenestra, a.k.a. Fanny .....Nathaly Trinidad  
Frank Frank ..... Carlo Alban  
"You Know More Than You Know You Know, You Know" lyrics by Carlo Alban

### MIRACLE ROCK

Written & Directed by Jedidiah Clarke\*  
for Francis Rivera, age 12. Costume Designer: Crystal Thompson  
Captain James "Chipper" Johnson .....Francis Rivera  
Dr. Trevor McNulty .....Jedidiah Clarke\*  
Alien Bodybuilder.....John Sheehy  
Space Serpent.....Brent Rivers  
"Miracle Rock Soul Anthem" lyrics by Jedidiah Clarke\*

### YOU CAN'T BLEND IN

Written & Directed by Julie Sharbutt  
for Eliza Muñoz, age 13. Costume Designer: Crystal Thompson  
Val ..... Eliza Muñoz  
Gert .....Julie Sharbutt  
"Everyone Loves Animals" lyrics by Julie Sharbutt

### CASE 24: ROSWELL, NEW MEXICO

Written by Vickie Ramirez & Directed by Ginny Lee  
for Samantha Paduani, age 10. Costume Designer: Kathleen Doyle  
Brioni Maxwell ..... Samantha Paduani  
Linda Marquart ..... Ginny Lee  
"Makeover" lyrics by Megan Cramer

### CRASH COURSE

Written & Directed by George Babiak  
for Aidan Martinez, age 11. Costume Designer: Kathleen Doyle  
Marty .....Aidan Martinez  
Bob ..... George Babiak  
Eddie ..... Mordecai Santiago  
Announcer ..... Patrick Barnes  
"Be Your Own Man" lyrics by George Babiak

## Back to Square One: More Original Plays - ACT 2

### GRADY AND ROGER

Written by Tommy Smith & Directed by Felix Solis.  
for Gerardo Escamilla, age 12. Costume Designer: Crystal Thompson  
Grady ..... Gerardo Escamilla  
Roger ..... Felix Solis  
"Hollywood" lyrics by Tommy Smith & Patrick Barnes

### BACON THE RULES

Written & Directed by Annie Purcell  
for Katie Liu, age 12. Costume Designer: Crystal Thompson  
Terry .....Katie Liu  
Ghost .....Annie Purcell  
Time Transporter ..... Craig Cox  
"Rules" lyrics by Annie Purcell

### ROCKIN' HOOD

Written & Directed by Christopher Randolph  
for Lincoln Bernard, age 11. Costume Designer: Crystal Thompson  
Rockin' Hood .....Lincoln Bernard  
The Sheriff of Rottingham.....Christopher Randolph  
Marion.....Megan Cramer  
Cliché.....Mordecai Santiago  
"Battle Royal" lyrics by Christopher Randolph

### THE WISH SWITCH

Written by Jihan Crowther & Directed by Shirley A. Rumierk\*  
for Ashley Melón, age 11. Costume Designer: Kathleen Doyle  
Gabrielle ..... Ashley Melón  
Ursula ..... Shirley A. Rumierk\*  
"I Want My Wish" lyrics by Jihan Crowther

### MABEL'S BIG BREAK

Written & Directed by Craig Cox  
for Jasmine Hernandez, age 12. Costume Designer: Kathleen Doyle  
Mabel Honeytree .....Jasmine Hernandez  
The Grim Reaper..... Craig Cox  
Dancer #1 ..... Mordecai Santiago  
Dancer #2 ..... Olivia Harris  
"Dance Your Face Off" lyrics by Craig Cox

\* 52nd Street Project alumni

The 52nd Street Project gratefully acknowledges the support of the following foundations and corporations: The Altman Foundation; AON; APA Talent Agency; Big Wood Foundation; BSK Architects; Bloomberg; The Brenner Family Foundation; The Margaret A. Cargill Foundation; Carnegie Corporation of New York; CBS Corporation; CMR Comedy; Consolidated Edison; The Dermot Company; The Educational Foundation Of America; The Dramatists Guild Fund; Dramatists Play Service; Gio Productions, Inc.; The Horace W. Goldsmith Foundation; The William & Mary Greve Foundation; Holland Lodge Foundation, Inc.; Saul Horowitz, Jr. Fund; Hudson Scenic Studio; JKW Foundation; Kresge Foundation; Law Offices of Claudia Wagner; Lightspeed Financial LLC; James A. Macdonald Foundation; Ann M. Martin Foundation; Mellon Equity Associated, Llp; LuEsther T. Mertz Foundation; J.P. Morgan Charitable Trust; The New World Foundation; Newman's Own Foundation; The New York Times Company Foundation; NYFA; Primiano Electric Corp.; Tony Randall Theatrical Fund; Jonathan Rose Companies, Inc.; Shapiro & Lobel; The Shaw Family Endowment Fund; The Shubert Organization; St. Vincent De Paul Foundation; The Harold & Mimi Steinberg Charitable Trust; Stranahan Foundation; Surdna Foundation; Susquehanna Foundation, Corp.; Tax Pro Financial Network, Inc.; Theatre Communications Group, Inc.; Watkins, Inc.; Wiener Family Foundation; John A. Vassilaros & Son, Inc; Yorke Construction Corp. In addition, the following individuals made gifts over \$250 to The 52nd Street Project this past year. (list current as of 7/23/09):

Robert Abrams & Cynthia Vance	Liz Flahive & Jeff Cox	John Lyons	David Ross & Laura Ross
Emily Armstrong	Kristen Frank & Tamir Hashem	Grace Lyu-Volkhausen	Daryl Roth
Dylan & Becky Baker	Louis & Patrice Friedman	Greg MacPherson & Jane Perlmutter	Robert Saget
Jessica Bauman & Ben Posel	Connie Garrido & Ray Rotolo	Steve Martin	Marcia Santoni & John Morris
Lisa Benavides & Tim Nelson	Beverly Gasner	Drew McCoy & Amy Aquino	Meredith Beeuwkes Scarlet
Gavin Berger & Craig Berggren	Christina Gerber	Frances Gershon	Karin & Tom Schall
Rajeev Bhandari	Freddie Gershon	Joel Coen	Whitney Scott & Peter Jacobson
Pat Birch	Jillian Gersten & Brian Shuman	Ann McLarty & Chuck Knauss	Robert Shaffron & John Davis
Kerrison Black	Alex Gersten-Vassilaros & John A. Vassilaros	Josie Merck & Jim Stevenson	Pam Shaw & Victor Symis
Lewis Black	Nancy Giles	Al Minafo	Jonathan Sheffer
Andrew Blackman & Tatiana Rutkowski	Tony Goldwyn & Jane Musky	Eric Mindich & Stacey Mindich	Peter Shinoda
Lawrence Blau	James Gosnell	Emily & John Morgan	Meg Simon
Emily Blavatnik	Richard Gottfried	Bruce Moulton	Tom Slaughter
Allison & Robert Blinken	Stephen & Cathy Graham	Karen "Special K" Munkel	Robert Smigel & Michelle Smigel
Becky Browder & Ted Neustadt	Susannah Gray & John Lyons	Patricia M. Murphy, Esq. & Adam Spilka	Jonathan & Jennifer Soros
Al Cardinali	Jan Gura & Alan Pickman	John Mustin & Kimberly Mustin	Paul Logan
Robert & Holly Carter	David & Ann Hausmann	Fred Nelson	Dimitri & Helen Sogoloff
Judy Cashmore	Sally Holmes & Doug Curtis	Randy & Rona Nelson	Gavin & Joan Solotar
Rachel Chanoff	William Holtzman & S. Sylvia Shepard	Ruth Nelson	Steven & Farrell Starker
Kirk & Katherine Holt Citron	Katy Homans & Patterson Sims	James Neuberger & Helen Stambler	Jenny & Jon Steingart
Ronald Cohen	Saul Horowitz	Cynthia Nixon	Michael & Marjorie Stern
Ruth Cohen & Bob Usdin	Sarah Horowitz & David Venarde	Rachel & Larry Norton	Michael Stone
Judith-Ann Corrente	Andrea Johnson	Carol Ochs & Bruce MacVittie	David Suehsdorf & Janet E. Muir
David Costabile	Douglas & Katie Jordan	Jacki Ochs & Jan Kroeze	Richard Sweren
Billy Crudup	Bob Joy	Paula Park	Jeanine Tesori
Arthur Dantchik	Michael Joyce	Jessica Pell	Anne Tilney & Douglas Kaden
Cathy Dantchik	Maurice Kanbar	Elizabeth Peters	Ali Torsiglieri & Michael Bernard
Leslie Dantchik	Cindy Kaplan & David Froelich	Peter & Ana Rosa Phillips	Pamala & Sean Tyson
Peter & Judith Dawkins	Stephen & Susan Ko	Judy Kuhn & David Schwab	Carol L. Nadell & Richard E. Van Deusen
Jim Delaney	Judy Kuhn & David Schwab	Michael Pillinger	Wendy vanden Heuvel & Brad Coley
Neil DeSena & Carolyn DeSena	Howard Laks & Irena Laks	Peter & Helen Randolph	Ed Vassallo
William Dockery	Michael P. Lawrence	Willie Reale & Jenny Gersten	Joe Versace
Richard & Rebecca Dresser	Warren Leight	Jennifer Reichle	Mary Pat Walsh
Adam Dubin & Rochelle Dubin	Robert Sean Leonard & Gaby Salick	Jacquelyn Reingold	Lynn & Sam Waterston
Peter Jay Fernandez & Denise Burse	Tom Leonardis	Ira Resnick	Ali Marsh
Suzanne Fine & Christian Salomone	Martin Levine	Burt Resnick & Judy Resnick	Jane Bolster & Steve Wertimer
Angelina Fiordellisi & Matt Williams	Harold Levison & Ilyse Levison	Kevin Louis Reymond & Dana Lee Reymond	Michael & Zena Wiener
Peter Fisch & Jill Levy Fisch	Anna Li & Frank Sposato	Michael Richter & Veronica Richter	Richard Willis & Jill Willis
Katie Flahive	Melissa Liebling-Goldberg & John Barrett	Joseph Rokacz & Larry Gordon	Geoffrey Wills
	Michael & Marjorie Loeb	David Rosenberg	Frank Wood
	Mark Lonow & JoAnne Astrow		Lynne Zeavin & Donald Moss

The 52nd Street Project Presents

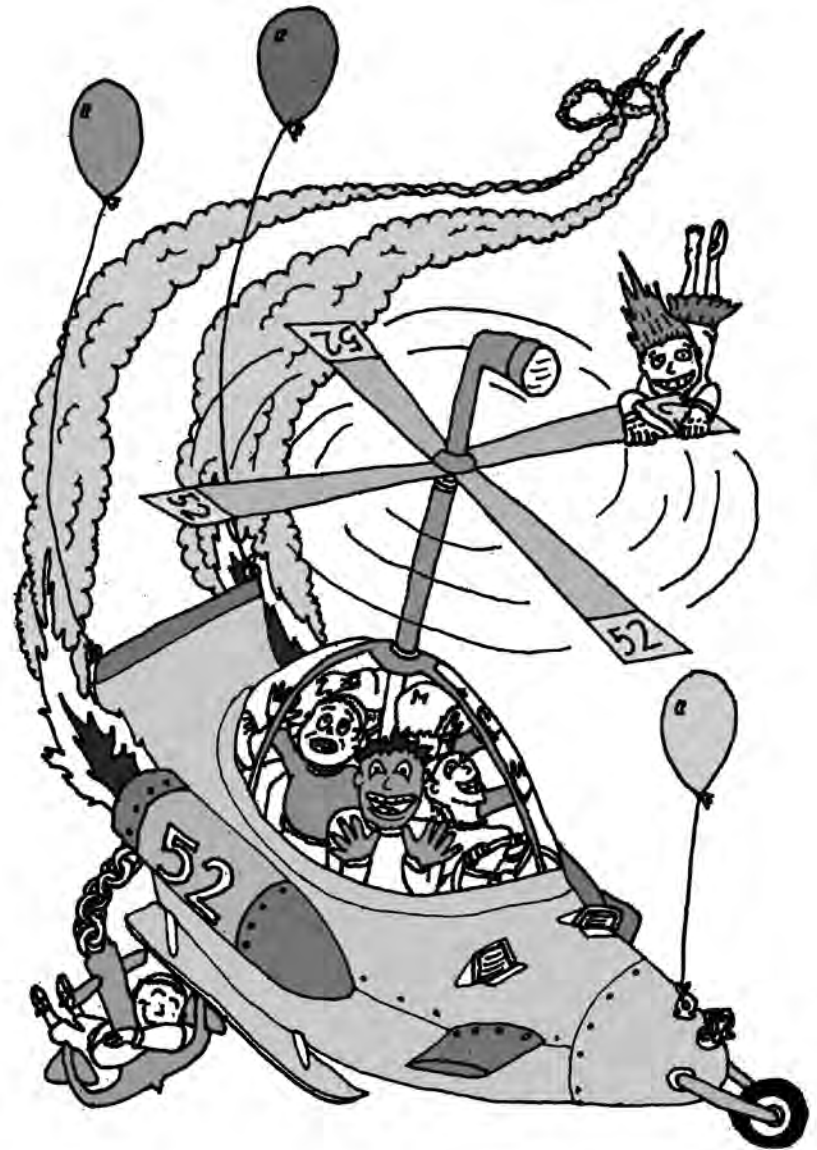

ART BY JOSH MOODY

## GETTING THERE: THE JOURNEY PLAYS

Playback 2009

The TBG Theatre - 326 West 36th St., 3rd Floor

October 23-25, 2009

# GETTING THERE: THE JOURNEY PLAYS

Playback 2009 - Oct. 23-25, 2009, The TBG Theatre

## The 52nd Street Project Staff

Gus Rogerson, Artistic Director  
 Carol Ochs, Executive Director  
 John Sheehy, Director of Development and Marketing  
 George Babiak, Production Manager  
 Ray Harold, Technical Director  
 Liz Bell, Director of Education  
 Megan Cramer, Program Director  
 Diana Rojas, Associate Program Director  
 Josh Moody, Development Assistant  
 Chris Ceraso, Teen Dean  
 Iris A. Brown, Graphic Designer  
 Jenisse Bouret, Azalea Rosario, Malik Velasquez, Teen Receptionists  
 Jenisse Bouret, Carlos Dume, Fivey Magazine assistants  
 Jorge Zapata, Teen Playmaking Class Assistant  
 Joanna Gurin, Daniel Johnsen, Norma Kuhling, Interns

## "Getting There" Production Staff

### Composer/Music Director

Kim D. Sherman

### Set Designer

Kevin Joseph Roach

### Lighting Designer

Jay Scott

### Costume Designers

Chris Rumery  
 and Lara de Bruijn

### Sound Designer

Jessica Bauer

### Stage Manager

Charles M. Turner III

### Slide Designs

George Babiak, Josh Moody,  
 and the Project Slide Archive

### Prop Design Team

George Babiak, Megan Cramer,  
 Joanna Gurin, Daniel Johnsen,

Norma Kuhling, Lee Rosen,  
 John Sheehy

### Backstage Crew

Hashem Ahmed, Andy Reyes,  
 Azalea Rosario Joanna Gurin,  
 Daniel Johnsen, Norma Kuhling

### Load-in and Light-hang Crew

Doug Nervik, Anne O'Sullivan,  
 Lee Rosen, Jay Scott, Tom Schall

### House Managers

Liz Bell, Karin Schall

### Show Photographer

Rob White

### Chefs

Liz Bell, John Sheehy

### Bridgethampton Hosts

John Vassilaros, Alex Gersten-  
 Vassilaros, and Tonio, Luka, and  
 Stefano Vassilaros.



The Playback Program is made possible with public funds from The New York State Council on the Arts, a state agency; and the New York City Department of Cultural Affairs. The 52nd Street Project is supported by funds from the National Endowment for the Arts. The Project is a member of ART/NY.

## COOL STUFF ON SALE IN THE LOBBY!

NEW! REPLAY SCRIPTS.....\$10.00  
 FABULOUS FLYER BARS ..... \$2.50, \$2, \$1.50

AND FEATURING SHEL SILVERSTEIN'S  
 "FIVEY AND TWOEY" LOGO:

PROJECT T-SHIRTS.....\$12.00  
 PROJECT HOODIES.....\$30.00  
 PROJECT CAPS.....\$20.00  
 PROJECT MUGS .....\$5.00  
 PROJECT PENCIL 3-PACK .....\$1.00  
 PROJECT NOTEBOOK.....\$5.00

Thank you for coming to GETTING THERE! If you are not on our mailing list (or if your address has changed), please fill out this form and give it to us on your way out or mail it to the address below. We would also like to know if you are interested in becoming a volunteer. We need help in all areas, so be sure to fill out the entire form.

PLEASE ADD ME TO YOUR MAILING LIST:

10/09

NAME \_\_\_\_\_

ADDRESS \_\_\_\_\_

CITY \_\_\_\_\_

STATE \_\_\_\_\_

ZIP \_\_\_\_\_

HOME PHONE \_\_\_\_\_

DAYTIME OR MOBILE PHONE \_\_\_\_\_

E-MAIL ADDRESS \_\_\_\_\_

MY OCCUPATION \_\_\_\_\_

MY HOBBIES \_\_\_\_\_

YES, I WOULD LIKE TO BE OF HELP. I CAN:

- |   |   |  |
|---|---|--|
| <input type="checkbox"/> Help load in and out for shows | <input type="checkbox"/> Draw and/or paint  | <input type="checkbox"/> Help kids with homework |
| <input type="checkbox"/> Hang lights                    | <input type="checkbox"/> Help with mailings | <input type="checkbox"/> Teach kids a skill      |
| <input type="checkbox"/> Work on a backstage crew       | <input type="checkbox"/> Do office work     | <input type="checkbox"/> Be a chef at an event   |
| <input type="checkbox"/> Do graphic design              | <input type="checkbox"/> Design sound       | <input type="checkbox"/> Design and sew costumes |
| <input type="checkbox"/> Other (please specify) _____   |   |  |

MY SCHEDULE IS:

- Very flexible. I'm often available during weekdays.  
 Somewhat flexible. I can help on the occasional morning or afternoon during the week.  
 Not very flexible at all, but I've got some free time on evenings and weekends.

If you would like to mail this (and you're always welcome to enclose a tax-deductible contribution), you can send it to: The 52nd Street Project, 500 West 52nd St., New York, NY 10019. Or fax it to (212) 333-5598.



**COMING UP SOON!**

*All Good Things:*

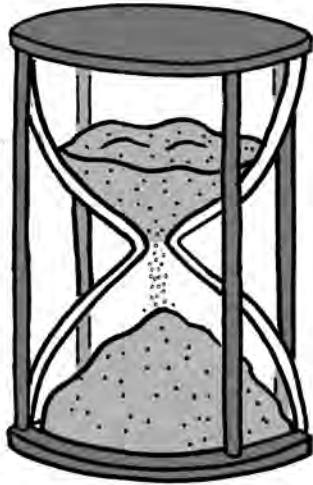

*The Patient Plays*

**December 11-13, 2009  
at a theater to be announced**

Last month, the youngest Project kids began Megan Cramer's class in the fine art of Playmaking. Come see their final plays performed by professional actors in a big professional theater.



**BE ON THE LOOKOUT!  
WE ARE ALWAYS  
SEARCHING FOR INTERNS.**

If you know of any college or graduate students who might enjoy working with us, playing with us, and going on trips with us for a semester, please have them contact George Babiak or Megan Cramer. We are especially looking for interns for the Spring and Summer of 2010. Thanks!

**The 52nd Street Project Board of Directors**

Ben Barenholtz	Carol Ochs
Lisa Benavides	Willie Reale, founder
Rachel Chanoff	Gus Rogerson
Cathy Dantchik	Shirley Rumierk, alumni member
Carolyn DeSena	José Soto, Jr., alumni member
Wendy Ettinger, chair emeritus	Jenny Steingart
Louis P. Friedman	Merritt Tilney
Stephen Graham, chair	Pamala Tyson
James McDaniel	Wendy vanden Heuvel
Frances McDormand	John A. Vassilaros
Noël Mihalow	

**What's Going On Here?**

The 52nd Street Project is a non-profit organization that brings children from the Hell's Kitchen neighborhood together with professional theater artists to create original theater. GETTING THERE is a production of our Playback program, in which kid actor/playwrights wrote plays for themselves and adult actor/director partners. Everyone ventured to the Hamptons for a rehearsal retreat over the Columbus Day weekend. All of the kids involved are veterans of the Playmaking classes which were adapted for the Project by Daniel Judah Sklar from his book Playmaking: Children Writing and Performing Their Own Plays.

**In-Kind Contributions**

The Murphy Law Office; Abbeville Press; Stephanie Berger Photography; Lewis Black; Richard Blackstone; Iris A. Brown Design; City Winery; William Curran & A Curran Affair; Kate Cusack; EMI Records; ICI; The S.F. Giants; Newman's Own; Macy's; Pharma Print; PineRock; The N; Shapiro Lobel, LLP; Wendy Stuhlberg; The Yankees; John A. Vassilaros; Watkins, Inc.; Mayor's Office of Film & Television; Boylan's Bottling Co.; Hudson Scenic; and Paul, Weiss, Rifkind, Wharton & Garrison LLP.

**Special Thanks**

We're extremely grateful to John Vassilaros, Alex Gersten-Vassilaros, their boys Tonio, Luka and Stefano, and the ever-helpful Joyce for allowing us to use their home as our headquarters on our rehearsal trip to the Hamptons. Thanks also to Cathy Dantchik and Yildiz Yuksik and Richard Blackstone, who let some of our volunteers crash at their homes out in the South Fork.

## GETTING THERE: THE JOURNEY PLAYS - ACT 1

All original music composed by Kim D. Sherman

### **MATIKAMTA: THE LONELIEST ISLAND**

Written by Kiana Hernandez, age 13.

Director/Dramaturge: Armando Riesco.

Luna..... Kiana Hernandez

Mr. Thing..... John Sheehy

*My Life's Dream Smashed to Pieces* and *My Life on Matikamta* lyrics by Kiana Hernandez.

### **MY LIFE**

Written by Wendell Joseph, age 13.

Director/Dramaturge: Josh Moody.

Chris..... Wendell Joseph

John..... Josh Moody

Mom..... Joanna Gurin

*You Are* and *My Life* lyrics by Wendell Joseph.

### **DREAMS OF THE WOLF**

Written by Marlowe Mendez, age 13.

Director/Dramaturge: Erin Mallon.

Jordan..... Marlowe Mendez

Sophia..... Erin Mallon

Train Conductor..... Zenzele Cooper

*Battitude* lyrics by Marlowe Mendez.

### **BEYOND THE FRIENDSHIP**

Written by Laron Holt, age 13.

Director/Dramaturge: Lee Rosen.

Coco..... Laron Holt

Josh..... Lee Rosen

Kids..... The Crew

Kid's Mom/Ceara..... Joanna Gurin

*Feeling Good* lyrics by Laron Holt.

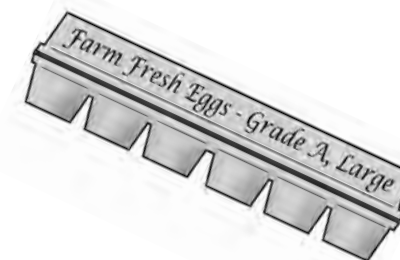

## GETTING THERE: THE JOURNEY PLAYS - ACT 2

### **IDENTITY CRISIS**

Written by Rafael Irizarry III, age 13.

Director/Dramaturge: Carl Capotorto.

Al/Alfred..... Rafael Irizarry III

Cory Thomson..... Carl Capotorto

Mr. J..... George Babiak

Kid in class..... Azalea Rosario

*I'm Me* lyrics by Rafael Irizarry III.

### **BREAK FREE AND RUN**

Written by Zoe Keana Norris, age 13.

Dramaturge: Liz Bell Director/Dramaturge: Zenzele Cooper.

Ezparanza Diaz..... Zoe Keana Norris

Stacey Green..... Zenzele Cooper

Mr. Sylup..... John Sheehy

Clubbers..... The Crew

Spokesman for the Dance Contest..... John Sheehy

*I'm Free* lyrics by Zoe Keana Norris.

### **JED AND MOM**

Written by Frankie Williams, age 13.

Director/Dramaturge: Catherine Mueller.

Jed/Sir Master..... Frankie Williams

Mom/Icebolt..... Catherine Mueller

Draco..... George Babiak

*Miss America*, *My Wish* and *Do I Get a Wish?* lyrics by Frankie Williams.

### **LOVE AND DIFFERENCE**

Written by Samantha Caldon, age 13.

Director/Dramaturge: Megan Cramer.

Katie Cruton..... Samantha Caldon

Michelle Cruton..... Megan Cramer

*Difference* lyrics by Samantha Caldon.

The 52nd Street Project gratefully acknowledges the support of the following foundations and corporations: The Altman Foundation; Bloomberg; BSKK Architects; The Brenner Family Foundation; Carnegie Corporation of New York; CBS Corporation; Consolidated Edison; The Dermot Company, Inc.; The Dramatists Guild Fund; Dramatists Play Service; Office of Thomas K. Duane; Eleanor, Adam & Mel Dubin Foundation; The Educational Foundation of America; Sidney E. Frank Foundation; Friars National Foundation; The Horace W. Goldsmith Foundation; Green Apple Entertainment, Inc.; Saul Horowitz, Jr. Fund; Hudson Scenic Studio; Hurlbut Family Charitable Lead Trust; JKW Foundation; Lemberg Foundation, Inc.; Lloyds TSB Bank plc; James A. Macdonald Foundation; Ann M. Martin Foundation; Mellon Equity Associated, Llp; LuEsther T. Mertz Foundation; Newman's Own; The New York Times Company Foundation; NYFA; Tony Randall Theatrical Fund; Jonathan Rose Companies; St. Vincent De Paul Foundation; Sallie Mae Fund; Savoy Bank; Peter Schoenfeld Asset Management; Sesame Workshop; Shapiro & Lobel; The Shubert Organization; The Starker Family Foundation; The Surdna Foundation; Susquehanna Foundation, Corp.; Tax Pro Financial Network, Inc.; Tiger Baron Foundation; Van Deusen Family Fund; John A. Vassilaros & Son, Inc.; The Vervane Foundation; Law Offices of Claudia Wagner; Watkins, Inc.; We Of Little Faith; I. Weiss & Sons, Inc.; The Wiener Family Foundation; Yorke Construction Corp. In addition, the following individuals made gifts over \$250 to The 52nd Street Project this past year. (list current as of 8/10/08):

Raymond & Elizabeth Abbott	Richard Dresser & Rebecca Dresser	Cindy Kaplan & David Froelich	Jennifer Reichle Jacquelyn Reingold
Robert Abrams & Cynthia Vance	Wendy Ettinger & Derek McLane	Janet Kleinberg Judy Kuhn & David Schwab	David Ross & Laura Ross Daryl Roth
May Ameen	Andrew Farach-Colton & Martin Farach-Colton	Warren Leight Mickey Lemle	Karin & Tom Schall George Schieferdecker
Lisa Andrade-Hicks	Peter Jay Fernandez & Denise Burse	Joshua Lewis & Sarah Kay Barbara Locker	Robert Schnur Robert Shaffron
Emily Armstrong & Patrick Gannon	Liz Flahive & Jeff Cox Alison Fraser & Nat Magee	Greg MacPherson & Jane Perlmutter	& John Davis Neal Shapiro
James Auron	Beverly Gasner Rose Gasner	Michael & Marjorie Loeb Edith Lutnick	& Hyunju Chang Meg Simon
Dylan & Becky Baker	& Larry Chertoff Cora Cahan	John Lyons Greg MacPherson	Tom Slaughter Jenny & Jon Steingart
Ben Barenholtz	& Bernard Gersten Jilian Gersten	Ian Madover & Arielle Madover	Richard Sweren Anne Tilney
Jessica Bauman & Ben Posel	& Brian Shuman Alexandra	Jennifer Manocherian Frances McDormand	& Douglas Kaden Liz Tuccillo
Laurie Becker	Gersten-Vassilaros & John A. Vassilaros	& Joel Coen Noël & Joe Mihalow	Pamala & Sean Tyson Laura Valeroso
Michael Bell & Carol Bell	Nancy Giles Jessalyn Gilsig	Erin Moriarty Suzen Murakoshi	& David Seidman Josephine Eke
Lisa Benavides & Tim Nelson	Richard Gottfried Stephen & Cathy Graham	& Mark Temme Patricia M. Murphy, Esq.	& Jason Valk Wendy vanden Heuvel
Gavin Berger & Craig Berggren	Emily Grishman & Susan Sampliner	& Adam Spilka Fred Nelson	& Brad Coley Joe Versace
Stephanie Berger & Paul King	David & Ann Hausmann Peter Herdrich	Randy & Rona Nelson Ruth Nelson	Gonzalo Vicente Grace Lyu-Volckhausen
Elizabeth & Alexander Bernstein	& Karen Trott Megan Hollingshead	Rachel & Larry Norton Lori O'Connor	Borah & Mildred Walton Lynn & Sam Waterston
Stephen Bernstein	Sally Holmes & Doug Curtis William Holtzman	Carol Ochs & Bruce MacVittie	Jane Bolster & Steve Wertimer
Lewis Black	& S. Sylvia Shepard Katy Homans	Jacki Ochs & Jan Kroeze Paul & Maria Onderdonk	Margaret Whitton & Warren Spector
Richard Blackstone & Yldeez Yuksek	& Patterson Sims Sarah Horowitz	Elizabeth Peters Judy Goldman	Elizabeth Williams & Joseph Forte
Tessa Blake & Ian Williams	& David Venarde Gerald Howard	Michael Pillinger Doug Polley & Stacy Polley	Frank Wood Joanne Woodward
Emily Blavatnik	Seymour & Felicia Jacobs Whitney Scott	& Peter Jacobson Christopher Randolph	& Paul Newman Bill Wrubel
Allison & Robert Blinksen	& Peter Jacobson Andrea Johnson	Peter & Helen Randolph Willie Reale	& Jennifer Crittenden Suzy Yengo
Rabbi Laurie & Andrew Braun	Douglas & Katie Jordan	& Jenny Gersten	
John Carr & Patricia Carr			
Rachel Chanoff			
Kirk & Katherine Holt Citron			
Ruth Cohen & Bob Usdin			
Gayle Cohen Heller & David Heller			
Cathy Dantchik			
Leslie Dantchik			
Peter & Judith Dawkins			
Neil & Carolyn DeSena			
Marion & Alan Dienstag			
Jessica Doty			

The 52nd Street Project Presents

All Good Things:

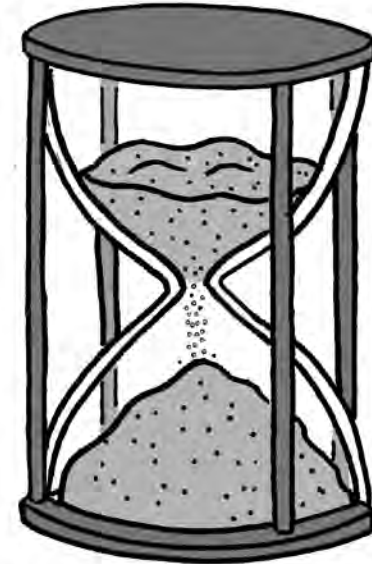

The Patient Plays

The Fall Playmaking Show  
December 11-13, 2009

The very first production at  
**The Five Angels Theater**  
at The 52nd Street Project

789 10th Avenue  
Between 52nd and 53rd Streets

**All Good Things: The Patient Plays**  
The Fall 2009 Playmaking Production - Dec. 11-13, The Five Angels Theater

**The 52nd Street Project Staff**

Gus Rogerson, Artistic Director  
 Carol Ochs, Executive Director  
 John Sheehy, Director of Development and Marketing  
 George Babiak, Production Manager  
 Liz Bell, Director of Education  
 Megan Cramer, Associate Artistic Director  
 Diana Rojas, Associate Program Director  
 Josh Moody, Development Assistant  
 Ray Harold, Technical Director  
 Chris Ceraso, Teen Dean  
 Nicole A. Watson, Teen Shakespeare Director  
 Iris A. Brown, Graphic Designer  
 Joanna Gurin, Daniel Johnsen, Norma Kuhling, Interns  
**Teen Employees:**  
 Jenisse Bouret, Azalea Rosario, Malik Velazquez, Receptionists  
 Jenisse Bouret, Carlos Dume, Wordplay Assistants/Fivey Junior Editors  
 Jorge Zapata, Playmaking Class Assistant  
 Carlos Dume, Theater Greeter  
 Merlaine Mendez, Luisa Santiago, Ushers

**“All Good Things” Production Staff**

Composer/Music Director Patrick Barnes	Daniel Johnsen, Norma Kuhling, Daquan Nelson
Set Designer Kevin Joseph Roach	Volunteer Light-hang Crew Jason Hare, Doug Nervik, Deborah Gaffaney, Steve Monarque
Lighting Designer Greg MacPherson	Pro Rigging Technicians Danny Naish, Jack Walker-Pearson Kevin Ramsey, Tom Goehring
Costume Designer Crystal Thompson	Pro Sound Technicians Brady Hislop, Nathan McKinney, Arielle Edwards
Costume Assistant Nancy Thompson	House Managers Liz Bell, Karin Schall
Goddess of Sound Vanessa Valdes	Flyer Art: Jessica Ellis
Stage Manager Hannah Cohen	Chefs Joe White, Iris Brown, Liz Bell, Carol Ochs
Slide Design: George Babiak and the Project Slide Archive	Playmaking Class Volunteers Zakiyyah Alexander, Dylan Dawson, Joanna Gurin, Carly Mensch, Camille Travis, Shane West, Jordan Young
Prop Design Team George Babiak, Liz Bell, Megan Cramer, Deborah Gaffaney, Lee Rosen, John Sheehy	
Backstage Crew Kyle Fargardo, Joanna Gurin,	

**COOL STUFF ON SALE IN THE LOBBY!**  
**NEW! REPLAY SCRIPTS.....\$10.00**  
**FABULOUS FLYER BARS ..... \$2.50, \$2, \$1.50**

**AND FEATURING SHEL SILVERSTEIN'S  
"FIVEY AND TWOEY" LOGO:**

**PROJECT T-SHIRTS.....\$12.00**  
**PROJECT HOODIES.....\$30.00**  
**PROJECT CAPS.....\$20.00**  
**PROJECT MUGS ..... \$5.00**  
**PROJECT PENCIL 3-PACK ..... \$1.00**  
**PROJECT NOTEBOOK..... \$5.00**

Thank you for coming to **ALL GOOD THINGS!** If you are not on our mailing list (or if your address has changed), please fill out this form and give it to us on your way out or mail it to the address below. We would also like to know if you are interested in becoming a volunteer. We need help in all areas, so be sure to fill out the entire form.

PLEASE ADD ME TO YOUR MAILING LIST: 12/09

---

NAME \_\_\_\_\_

---

ADDRESS \_\_\_\_\_

---

CITY \_\_\_\_\_ STATE \_\_\_\_\_ ZIP \_\_\_\_\_

---

HOME PHONE \_\_\_\_\_

---

DAYTIME OR MOBILE PHONE \_\_\_\_\_ E-MAIL ADDRESS \_\_\_\_\_

---

MY OCCUPATION \_\_\_\_\_

---

MY HOBBIES \_\_\_\_\_

**YES, I WOULD LIKE TO BE OF HELP. I CAN:**

<input type="checkbox"/> Help load in and out for shows	<input type="checkbox"/> Draw and/or paint	<input type="checkbox"/> Help kids with homework
<input type="checkbox"/> Hang lights	<input type="checkbox"/> Help with mailings	<input type="checkbox"/> Teach kids a skill
<input type="checkbox"/> Work on a backstage crew	<input type="checkbox"/> Do office work	<input type="checkbox"/> Be a chef at an event
<input type="checkbox"/> Do graphic design	<input type="checkbox"/> Design sound	<input type="checkbox"/> Design and sew costumes
<input type="checkbox"/> Other (please specify) _____		

**MY SCHEDULE IS:**

Very flexible. I'm often available during weekdays.

Somewhat flexible. I can help on the occasional morning or afternoon during the week.

Not very flexible at all, but I've got some free time on evenings and weekends.

If you would like to mail this (and you're always welcome to enclose a tax-deductible contribution), you can send it to: The 52nd Street Project, 500 West 52nd St., New York, NY 10019. Or fax it to (212) 333-5598.



**DON'T MISS OUR NEXT SHOW!**

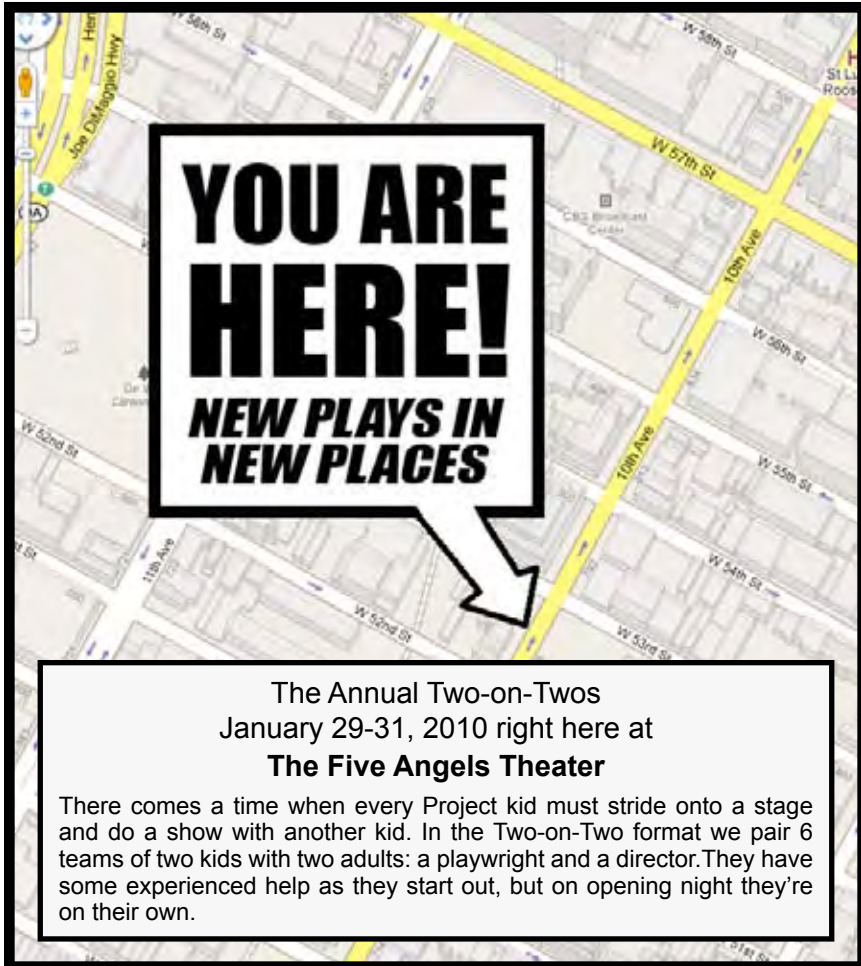

**YOU ARE  
HERE!**  
**NEW PLAYS IN  
NEW PLACES**

The Annual Two-on-Twos  
January 29-31, 2010 right here at  
**The Five Angels Theater**

There comes a time when every Project kid must stride onto a stage and do a show with another kid. In the Two-on-Two format we pair 6 teams of two kids with two adults: a playwright and a director. They have some experienced help as they start out, but on opening night they're on their own.



**BE ON THE LOOKOUT!  
WE ARE ALWAYS  
SEARCHING FOR INTERNS.**

If you know of any college or graduate students who might enjoy working with us, playing with us, and going on trips with us for a semester, please have them contact George Babiak or Megan Cramer. We are especially looking for interns for January-May, 2010. Thanks!

### **The 52nd Street Project Board of Directors**

Ben Barenholtz	Noël Mihalow
Lisa Benavides	Carol Ochs
Rachel Chanoff	Willie Reale, founder
Cathy Dantchik	Gus Rogerson
Carolyn DeSena	Shirley Rumierk, alumni member
Wendy Ettinger, chair emeritus	José Soto, Jr., alumni member
Louis P. Friedman	Jenny Steingart
Stephen Graham, chair	Pamala Tyson
Larry Jones	Wendy vanden Heuvel
James McDaniel	John A. Vassilaros
Frances McDormand	

### **What's Going On Here?**

The 52nd Street Project is a non-profit organization that brings children from the Hell's Kitchen neighborhood together with professional theater artists to create original theater. ALL GOOD THINGS is a production of our Playmaking program. Young people participate in a nine-week playwriting course taught by Megan Cramer and adapted for the Project by Daniel Judah Sklar from his book Playmaking: Children Writing and Performing Their Own Plays. At the end of the course, each child is given two actors, a theme, and a dramaturg/director who guides him or her through the writing of a play during a weekend retreat in the country (Stone Ridge, New York, for this show). Tonight's performance is the end result.

### **In-Kind Contributions**

The Murphy Law Office; Abbeville Press; Stephanie Berger Photography; Iris A. Brown Design; Carmine Campisi & Graphic Lab; Kenneth Cole Productions; William Curran & A Curran Affair; Diageo Chateau & Estate Wines Co.; Fresh; ICI; La Mer; New Line Cinema; Newman's Own; Noggin/The N; Parfums Givenchy & Guerlain; Paris Chocolates; Pharma Print/Omni Graphics; Sesame Workshop; Wendy Stuhlberg; John A. Vassilaros; Watkins, Inc.; Mayor's Office of Film & Television; Boylan's Bottling Co.; Lorraine Tobias & Imaginary Studios; Shapiro & Lobel; Hudson Scenic; Prime Films, and Paul, Weiss, Rifkind, Wharton & Garrison LLP.

### **Special Thanks**

We're extremely grateful to Steve Gorn, Barbara Bash and their son Wiley, for the use of their beautiful home in Stone Ridge, NY as our base of operations for the writer's retreat. The indispensable host families were Joe White & Iris Brown (who doubled as chefs), Laura Shaine Cunningham, Elaine Musselman, Deborah Freedman & Bill Woods, Charles Miles & Naomi Freundlich, Nicole & Paul Quinn, and Erica Schmidt & Peter Dinklage.

# All Good Things - ACT 1

All original music composed by Patrick Barnes

## MELANIE AND AQUAMARINE FOREVER

Written by Britney Trinidad, age 10.  
Director/ Dramaturge: Rick Meese.

Melanie ..... Lisa Benavides  
Aquamarine ..... Krystel Lucas  
Boy ..... Kyle Fargardo  
Ms. O ..... Joanna Gurin

*Fixing It Up* and *My Ways* lyrics by Britney Trinidad

## BANK ROBBED

Written by Miguel Vazquez, age 10.  
Director/Dramaturge: Emilio Delgado.

Jeff ..... Joe White  
Hunter ..... Joe Paulik  
Cops ..... Kyle Fargardo, Daquan Nelson, Joanna Gurin  
*I Miss My Best Friend and Enemy* lyrics by Miguel Vazquez.

## THE MIST

Written by Nicholas Carrero, age 11.  
Director/Dramaturge: Erica Schmidt.

Jake ..... Peter Jay Fernandez  
Mary ..... Saidah Arrika Ekulona

## JACKIE AND LILY

Written by Asia Hoa Rosado, age 10.  
Director/Dramaturge: Tlaloc Rivas.

Lily ..... Sue Jean Kim  
Jackie ..... Myra Lucretia Taylor  
Mom ..... Megan Cramer  
*Lily's Musical Nightmare* lyrics by Asia Hoa Rosado

## THE BROTHERS

Written by Adnan Ahmed, age 10.  
Director/Dramaturge: Davis McCallum.

Ric ..... Carson Elrod  
Eric ..... Bruce MacVittie  
People in Airport ..... The Crew  
*Why, Live Your Dream,* and *I'm Sorry* lyrics by Adnan Ahmed.

# All Good Things - ACT 2

## WORLD TRAVELER AND SWIMMER BOY

Written by Cassidy Capstick, age 10.  
Director/ Dramaturge: Kel Haney.

Kiwa Chay ..... Alexis McGuinness  
Leno Paie ..... Kenajuan Bentley  
*Scary Things in the World* lyrics by Cassidy Capstick.

## SPOOKY

Written by Carlos Breton, age 10.  
Director/Dramaturge: Kate Forbes

Pete Jefferson ..... Christopher Evan Welch  
Jeff Peterson ..... Joel de la Fuente  
Ghost ..... Megan Cramer  
*The Spooky Song* lyrics by Carlos Breton.

## THE IMPORTANT BIRTHDAY PARTY

Written by Leah Kiara Macuilt, age 10.  
Director/Dramaturge: Taibi Magar.

Anna ..... Aya Cash  
Jennifer ..... Elizabeth Canavan  
*I Feel Good* lyrics by Leah Kiara Macuilt

## TRAPPED IN TIME

Written by Edison Sibri, age 12.  
Director/Dramaturge: John Sheehy.

Jeremy ..... Will Harper  
Amanda ..... Mia Barron  
Boss ..... Daniel Johnsen  
Tour Group ..... The Crew



## THE CAPITAL CAMPAIGN DONORS

### Indispensable Supporters

*The City of New York*

Michael R. Bloomberg, Mayor  
Christine C. Quinn, New York City Council Speaker  
Scott Stringer, Manhattan Borough President

Kate D. Levin, Commissioner, NYC Department of Cultural Affairs

*The State of New York*

David A. Paterson, Governor  
Thomas K. Duane, Senator  
Richard Gottfried, Assembly Member  
Linda B. Rosenthal, Assembly Member

### Extraordinary Supporters

Lewis Black  
Dermot Company  
Stephen & Cathy Graham  
Kresge Foundation  
Wendy vanden Heuvel & Brad Coley

### Significant Supporters

Booth Ferris Foundation  
CLAWS Foundation  
The Educational Foundation Of America  
Patrice & Louis Friedman  
The Horace W. Goldsmith Foundation  
Frances McDormand, Pedro & Joel Coen  
The New York Community Trust - LuEsther T. Mertz Advised Fund  
The Harold & Mimi Steinberg Charitable Trust  
Jenny & Jon Steingart, The Wiener Family Foundation

### Generous Supporters

Altman Foundation  
Lisa Benavides & Tim Nelson  
The Big Wood Foundation  
Clinton Seed Fund  
Consolidated Edison Company of New York  
Kyle Czepiel  
The Dawkins Family Foundation  
Neil & Carolyn DeSena  
Entertainment Industry Foundation  
ETC  
Randy Frankel  
The Gasner Family  
Robert Goldberg,  
Yorke Construction Corporation  
Hudson Scenic  
Mark Jacobs  
Grace Lyu-Volckhausen  
Chris Mazzilli & Gotham Comedy Club  
The Andrew W. Mellon &  
New York Foundation for the Arts  
Joe & Noël Mihalow  
The Philip D. & Tammy S. Murphy Foundation  
New Generations Program, funded by the  
Doris Duke Charitable Foundation/  
The Andrew W. Mellon Foundation &  
administered by  
Theatre Communications Group  
Newman's Own  
Judith Resnick  
Tom Shadyac  
The Surdna Foundation  
Tiger Baron Foundation  
Matt Williams &  
Angelina Fiordellisi

Andrew Actman,  
Lightspeed Financial, LLC  
Jace Alexander & Maddie Corman  
Michael Alicastro  
Aon Corporation  
APA Talent & Literary Agency  
Jeff Arsenault  
Ben Barenholtz  
Jessica Bauman & Ben Posel  
Dr. & Mrs. Michael C. Bell  
Samara & Doug Braunstein  
Shawn Byron  
Cantor Foundation  
Lawrence Catena  
Rachel Chanoff  
Ruth Anne Cohen & Robert Usdin  
Ann & Geoff Coley  
Edward Conard & Jill Davis  
Ann & Jeff Cramer  
Billy Crudup  
Wendy Ettinger & Derek McLane  
Bill & Doreen Conley  
Kevin Darien  
Downtown Arts Development, Inc.  
Brian Duggan  
Nigel Faulkner  
James Formisano  
Henry Gallo  
Christina Gerber  
Emily Grishman  
Music Preparation  
Karen Hauser & Warren Leight  
The DuBose & Dorothy Heyward  
Memorial Fund

Alexandra Productions, Inc.  
Elton Andrews  
Ronald Artzi  
Joel Asarch  
Dylan & Becky Ann Baker  
Patrick Barnes & Kent McIngvale  
Laurie Becker  
Liz Bell  
Stephanie Berger & Paul King  
Kerrison Black  
Tessa Blake & Ian Williams  
Lawrence Blau  
Buzz Bovshow  
Michelle Buffington  
Michael Busado  
Luciano Caramanica  
Constance Casey  
Rochelle & Adam Dubin  
Beth Emelson, Joe Weber &  
Beatrix Weber  
Tom Fetterman & Bonnie Mac Saveny  
Elizabeth & Paul Giamatti  
Sandi Goff & Andrew Farkas  
David Grant  
George M. Grant

### Loyal Supporters

Eric & Barbara Hippeau  
Megan Hollingshead  
Kirk & Katheryn Holt Citron  
The JKW Foundation  
Larry & Mary Jones  
Doug & Katie Jordan  
Kevin Kelly  
The Nat R. & Martha M. Knaster  
Charitable Trust, Aaron Shapiro  
& Michael A. Lobel, Trustees  
Chuck Knauss & Ann McLarty  
Colin & Rita Knudson  
Belle & Roger Kuhn  
Howard Laks  
Linden Advisors, LP  
David Lloyd &  
Megan Mortimer Lloyd  
Marsue & Peter MacNicol  
Greg MacPherson & Jane  
Perlmutter  
Roma Maffia  
Fabio Mariani  
Drew McCoy & Amy Aquino  
Al Minafo, Greenmoor  
Financial Group, LLC  
The Monteforte Foundation, Inc.  
Robin Morse & Gus Rogerson  
Rishi Nangalia  
James & Olivia O'Connor  
Carol Ochs & Bruce MacVittie  
F. Richard Pappas  
Sue Phillips  
Bat-Sheva & Thomas Peters  
Alex Primiano Jr.

### Groundswell Supporters

Connie Grappo & Lee Wilkof  
Joy Greenhouse  
Bryan Gronau  
Amy Gross  
Michael Gross  
Leigh Hampton  
Joy & Harry Henshel  
Warner Howe  
The Kaplan & Froelich Families  
Mark Keoppen &  
Wendy Townsend  
Shari Kirshner  
Judy Kuhn & David Schwab  
Justin Lerner  
Liza Lerner  
Mark & Joanne Lonow  
Jennifer Manocherian  
Paul McCrane & Dana Kellin  
James & Hannelore McDaniel  
Christian Meyer  
Adirana & Bob Mnuchin  
John Moriarty  
Bruce Moulton  
Patricia Murphy, Esq.  
John & Kimberly Mustin  
Willie Reale & Jenny Gersten  
Dan Reed  
Reifler/Sky Blue Farm  
Bonnie & Richard Reiss  
Danon Robinson  
Jeffrey Rogers  
Anita Rogerson  
Jonathan Rose Companies, Inc.  
Joan & Alan Safir  
Bob Saget  
Deb Savo & Paul Giordano  
Lauren Seikaly & Michael Huber  
The Jane & Tad Shepard  
Family Foundation  
Robert & Michelle Smigel  
Helen Sogoloff  
Farrell & Steven Starker  
Jeffrey Strauss  
Richard Sweren  
Terrance Travis  
Gregory Tusar  
Pamala Tyson & Sean Mudd  
Vanessa Valdes &  
George Babiak  
Laura Valeroso & David Seidman  
Katrina vanden Heuvel  
John A. Vassilaros & Son, Inc  
Brian Villante  
Mark Whatley  
Joe White & Iris Brown  
Elizabeth Williams &  
Joseph Forte  
John William  
J.P. Xenakis  
Carol & Stanley Nelson  
Cynthia Nixon  
Jacki Ochs & Jan Kroeze  
Sean Rider  
Veronica & Michael Richter  
Ida Roth  
Shirley A. Rumierk  
Sandberg -Zakian Family  
Marcia Santoni & John Morris  
Karin & Tom Schall  
John Sheehy & Kim Sherman  
David Sleeman  
Brian Sklar  
Christopher Solomon  
John Stefanelli  
Edward Thomas  
Martin Timmins  
Erin Torneo & Sascha Paladino  
Angela Trento  
Christopher Tufano  
Ed Vassallo  
Law Offices of Claudia Wagner  
Mary Pat Walsh  
Geoffrey & Hilary Wills  
Carole Yass

## Loyal Supporters

Andrew Actman,  
Lightspeed Financial, LLC  
Jace Alexander & Maddie Corman  
Michael Alicastro  
Aon Corporation  
APA Talent & Literary Agency  
Jeff Arsenault  
Ben Barenholtz  
Jessica Bauman & Ben Posel  
Dr. & Mrs. Michael C. Bell  
Samara & Doug Braunstein  
Shawn Byron  
Cantor Foundation  
Lawrence Catena  
Rachel Chanoff  
Ruth Anne Cohen & Robert Usdin  
Ann & Geoff Coley  
Edward Conard & Jill Davis  
Ann & Jeff Cramer  
Billy Crudup  
Wendy Ettinger & Derek McLane  
Bill & Doreen Conley  
Kevin Darien  
Downtown Arts Development, Inc.  
Brian Duggan  
Nigel Faulkner  
James Formisano  
Henry Gallo  
Christina Gerber  
Emily Grishman  
Music Preparation  
Karen Hauser & Warren Leight  
The DuBose & Dorothy Heyward  
Memorial Fund

Eric & Barbara Hippeau  
Megan Hollingshead  
Kirk & Katheryn Holt Citron  
The JKW Foundation  
Larry & Mary Jones  
Doug & Katie Jordan  
Kevin Kelly  
The Nat R. & Martha M. Knaster  
Charitable Trust, Aaron Shapiro  
& Michael A. Lobel, Trustees  
Chuck Knauss & Ann McLarty  
Colin & Rita Knudson  
Belle & Roger Kuhn  
Howard Laks  
Linden Advisors, LP  
David Lloyd &  
Megan Mortimer Lloyd  
Marsue & Peter MacNicol  
Greg MacPherson & Jane  
Perlmutter  
Roma Maffia  
Fabio Mariani  
Drew McCoy & Amy Aquino  
Al Minafo, Greenmoor  
Financial Group, LLC  
The Monteforte Foundation, Inc.  
Robin Morse & Gus Rogerson  
Rishi Nangalia  
James & Olivia O'Connor  
Carol Ochs & Bruce MacVittie  
F. Richard Pappas  
Sue Phillips  
Bat-Sheva & Thomas Peters  
Alex Primiano Jr.

Willie Reale & Jenny Gersten  
Dan Reed  
Reifer/Sky Blue Farm  
Bonnie & Richard Reiss  
Danon Robinson  
Jeffrey Rogers  
Anita Rogerson  
Jonathan Rose Companies, Inc.  
Joan & Alan Safir  
Bob Saget  
Deb Savo & Paul Giordano  
Lauren Seikaly & Michael Huber  
The Jane & Tad Shepard  
Family Foundation  
Robert & Michelle Smigel  
Helen Sogoloff  
Farrell & Steven Starker  
Jeffrey Strauss  
Richard Sweren  
Terrance Travis  
Gregory Tusar  
Pamala Tyson & Sean Mudd  
Vanessa Valdes &  
George Babiak  
Laura Valeroso & David Seidman  
Katrina vanden Heuvel  
John A. Vassilaros & Son, Inc  
Brian Villante  
Mark Whatley  
Joe White & Iris Brown  
Elizabeth Williams &  
Joseph Forte  
John William  
J.P. Xenakis

## Groundswell Supporters

Alexandra Productions, Inc.  
Elton Andrews  
Ronald Artzi  
Joel Asarch  
Dylan & Becky Ann Baker  
Patrick Barnes & Kent McIngvale  
Laurie Becker  
Liz Bell  
Stephanie Berger & Paul King  
Kerrison Black  
Tessa Blake & Ian Williams  
Lawrence Blau  
Buzz Bovshow  
Michelle Buffington  
Michael Busado  
Luciano Caramanica  
Constance Casey  
Rochelle & Adam Dubin  
Beth Emelson, Joe Weber &  
Beatrix Weber  
Tom Fetterman & Bonnie Mac Saveny  
Elizabeth & Paul Giamatti  
Sandi Goff & Andrew Farkas  
David Grant  
George M. Grant

Connie Grappo & Lee Wilkof  
Joy Greenhouse  
Bryan Gronau  
Amy Gross  
Michael Gross  
Leigh Hampton  
Joy & Harry Henshel  
Warner Howe  
The Kaplan & Froelich Families  
Mark Keoppen &  
Wendy Townsend  
Shari Kirshner  
Judy Kuhn & David Schwab  
Justin Lerner  
Liza Lerner  
Mark & Joanne Lonow  
Jennifer Manocherian  
Paul McCrane & Dana Kellin  
James & Hannelore McDaniel  
Christian Meyer  
Adirana & Bob Mnuchin  
John Moriarty  
Bruce Moulton  
Patricia Murphy, Esq.  
John & Kimberly Mustin

Carol & Stanley Nelson  
Cynthia Nixon  
Jacki Ochs & Jan Kroeze  
Sean Rider  
Veronica & Michael Richter  
Ida Roth  
Shirley A. Rumierk  
Sandberg -Zakian Family  
Marcia Santoni & John Morris  
Karin & Tom Schall  
John Sheehy & Kim Sherman  
David Sleeman  
Brian Sklar  
Christopher Solomon  
John Stefanelli  
Edward Thomas  
Martin Timmins  
Erin Torneo & Sascha Paladino  
Angela Trento  
Christopher Tufano  
Ed Vassallo  
Law Offices of Claudia Wagner  
Mary Pat Walsh  
Geoffrey & Hilary Wills  
Carole Yass

## THE CAPITAL CAMPAIGN DONORS

### Indispensable Supporters

*The City of New York*  
Michael R. Bloomberg, Mayor  
Christine C. Quinn, New York City Council Speaker  
Scott Stringer, Manhattan Borough President  
Kate D. Levin, Commissioner, NYC Department of Cultural Affairs

*The State of New York*  
David A. Paterson, Governor  
Thomas K. Duane, Senator  
Richard Gottfried, Assembly Member  
Linda B. Rosenthal, Assembly Member

### Extraordinary Supporters

Lewis Black  
Dermot Company  
Stephen & Cathy Graham  
Kresge Foundation  
Wendy vanden Heuvel & Brad Coley

### Significant Supporters

Booth Ferris Foundation  
CLAWS Foundation  
The Educational Foundation of America  
Patrice & Louis Friedman  
The Horace W. Goldsmith Foundation  
Frances McDormand, Pedro & Joel Coen  
The New York Community Trust - LuEsther T. Mertz Advised Fund  
The Harold & Mimi Steinberg Charitable Trust  
Jenny & Jon Steingart, The Wiener Family Foundation

### Generous Supporters

Altman Foundation  
Lisa Benavides & Tim Nelson  
The Big Wood Foundation  
Clinton Seed Fund  
Consolidated Edison Company of New York  
Kyle Czepiel  
The Dawkins Family Foundation  
Neil & Carolyn DeSena  
Entertainment Industry Foundation  
ETC  
Randy Frankel  
The Gasner Family  
Robert Goldberg,  
Yorke Construction Corporation  
Hudson Scenic  
Mark Jacobs  
Grace Lyu-Volckhausen  
Chris Mazzilli & Gotham Comedy Club  
The Andrew W. Mellon &  
New York Foundation for the Arts  
Joe & Noël Mihalow  
The Philip D. & Tammy S. Murphy Foundation  
New Generations Program, funded by the  
Doris Duke Charitable Foundation/  
The Andrew W. Mellon Foundation &  
administered by  
Theatre Communications Group  
Newman's Own  
Judith Resnick  
Tom Shadyac  
The Surdna Foundation  
Tiger Baron Foundation  
Matt Williams &  
Angelina Fiordellisi



The 52nd Street Project gratefully acknowledges the support of the following foundations and corporations: The Altman Foundation; Bloomberg; BSKS Architects; The Brenner Family Foundation; Carnegie Corporation of New York; CBS Corporation; Consolidated Edison; The Dermot Company, Inc.; The Dramatists Guild Fund; Dramatists Play Service; Office of Thomas K. Duane; Eleanor, Adam & Mel Dubin Foundation; The Educational Foundation of America; Sidney E. Frank Foundation; Friars National Foundation; The Horace W. Goldsmith Foundation; Green Apple Entertainment, Inc.; Saul Horowitz, Jr. Fund; Hudson Scenic Studio; Hurlbut Family Charitable Lead Trust; JKW Foundation; Lemberg Foundation, Inc.; Lloyds TSB Bank plc; James A. Macdonald Foundation; Ann M. Martin Foundation; Mellon Equity Associated, Llp; LuEsther T. Mertz Foundation; Newman's Own; The New York Times Company Foundation; NYFA; Tony Randall Theatrical Fund; Jonathan Rose Companies; St. Vincent De Paul Foundation; Sallie Mae Fund; Savoy Bank; Peter Schoenfeld Asset Management; Sesame Workshop; Shapiro & Lobel; The Shubert Organization; The Starkor Family Foundation; The Sordna Foundation; Susquehanna Foundation, Corp.; Tax Pro Financial Network, Inc.; Tiger Baron Foundation; Van Deusen Family Fund; John A. Vassilaros & Son, Inc.; The Vervane Foundation; Law Offices of Claudia Wagner; Watkins, Inc.; We Of Little Faith; I. Weiss & Sons, Inc.; The Wiener Family Foundation; Yorke Construction Corp. In addition, the following individuals made gifts over \$250 to The 52nd Street Project this past year. (list current as of 8/10/08):

- |                              |                            |                          |                        |
|------------------------------|----------------------------|--------------------------|------------------------|
| Raymond & Elizabeth Abbott   | Jessica Doty               | Andrea Johnson           | Willie Reale           |
| Robert Abrams                | Richard & Rebecca Dresser  | Douglas & Katie Jordan   | & Jenny Gersten        |
| & Cynthia Vance              | Wendy Ettinger             | Cindy Kaplan             | Jennifer Reichle       |
| May Ameen                    | & Derek McLane             | & David Froelich         | Jacquelyn Reingold     |
| Lisa Andrade-Hicks           | Andrew & Martin            | Janet Kleinberg          | David & Laura Ross     |
| Emily Armstrong              | Farach-Colton              | Judy Kuhn                | Daryl Roth             |
| & Patrick Gannon             | Peter Jay Fernandez        | & David Schwab           | Karin & Tom Schall     |
| James Auron                  | & Denise Burse             | Warren Leight            | George Schieferdecker  |
| Dylan & Becky Baker          | Liz Flahive & Jeff Cox     | Mickey Lemle             | Robert Schnur          |
| Ben Barenholtz               | Alison Fraser              | Joshua Lewis & Sarah Kay | Robert Shaffron        |
| Jessica Bauman               | & Nat Magee                | Barbara Locker           | & John Davis           |
| & Ben Posel                  | Beverly Gasner             | & Penny Zuckerwise       | Neal Shapiro           |
| Laurie Becker                | Rose Gasner                | Michael & Marjorie Loeb  | & Hyunju Chang         |
| Michael & Carol Bell         | & Larry Chertoff           | Edith Lutnick            | Meg Simon              |
| Lisa Benavides               | Cora Cahan                 | John Lyons               | Tom Slaughter          |
| & Tim Nelson                 | & Bernard Gersten          | Greg MacPherson          | Jenny & Jon Steingart  |
| Gavin Berger                 | Jilian Gersten             | & Jane Perlmutter        | Richard Sweren         |
| & Craig Berggren             | & Brian Shuman             | Ian & Arielle Madover    | Anne Tilney            |
| Stephanie Berger             | Alexandra                  | Jennifer Manocherian     | & Douglas Kaden        |
| & Paul King                  | Gersten-Vassilaros         | Frances McDormand        | Liz Tuccillo           |
| Elizabeth                    | & John A. Vassilaros       | & Joel Coen              | Pamala & Sean Tyson    |
| & Alexander Bernstein        | Nancy Giles                | Noël & Joe Mihalow       | Laura Valeroso         |
| Stephen Bernstein            | Jessalyn Gilsig            | Emily & John Morgan      | & David Seidman        |
| Lewis Black                  | Richard Gottfried          | Erin Moriarty            | Josephine Eke          |
| Richard Blackstone           | Stephen & Cathy Graham     | Suzen Murakoshi          | & Jason Valk           |
| & Yldeez Yuksek              | Emily Grishman             | & Mark Temme             | Wendy vanden Heuvel    |
| Tessa Blake & Ian Williams   | & Susan Sampliner          | Patricia M. Murphy, Esq. | & Brad Coley           |
| Emily Blavatnik              | David & Ann Hausmann       | & Adam Spilka            | Joe Versace            |
| Allison & Robert Blinken     | Peter Herdrich             | Fred Nelson              | Gonzalo Vicente        |
| Rabbi Laurie                 | & Karen Trott              | Randy & Rona Nelson      | Grace Lyu-Volckhausen  |
| & Andrew Braun               | Megan Hollingshead         | Ruth Nelson              | Borah & Mildred Walton |
| John & Patricia Carr         | Sally Holmes & Doug Curtis | Rachel & Larry Norton    | Lynn & Sam Waterston   |
| Rachel Chanoff               | William Holtzman           | Lori O'Connor            | Jane Bolster           |
| Kirk & Katherine Holt Citron | & S. Sylvia Shepard        | & Steve Wertimer         | & Steve Wertimer       |
| Ruth Cohen & Bob Usdin       | Katy Homans                | Margaret Whittton        | & Warren Spector       |
| Gayle Cohen Heller           | & Patterson Sims           | Elizabeth Williams       | Elizabeth Williams     |
| & David Heller               | Sarah Horowitz             | & Joseph Forte           | & Joseph Forte         |
| Cathy Dantchik               | & David Venarde            | Frank Wood               | Frank Wood             |
| Leslie Dantchik              | Gerald Howard              | Joanne Woodward          | Joanne Woodward        |
| Peter & Judith Dawkins       | Seymour & Felicia Jacobs   | Bill Wrubel              | Bill Wrubel            |
| Neil & Carolyn DeSena        | Whitney Scott              | & Jennifer Crittenden    | & Jennifer Crittenden  |
| Marion & Alan Dienstag       | & Peter Jacobson           | Suzi Yengo               | Suzi Yengo             |

## THE 52ND STREET PROJECT PRESENTS



**THE 2010 TWO-ON-TWO'S**  
JANUARY 29-31, 2010

**THE FIVE ANGELS THEATER**  
AT THE 52ND STREET PROJECT

**789 10TH AVENUE**  
**BETWEEN 52ND AND 53RD STREETS**

# YOU ARE HERE! NEW PLAYS IN NEW PLACES

The 2010 Two-on-Two's - January 29-31, The Five Angels Theater

## The 52nd Street Project Staff

Gus Rogerson, Artistic Director  
Carol Ochs, Executive Director  
John Sheehy, Director of Development and Marketing  
George Babiak, Production Manager  
Liz Bell, Director of Education  
Megan Cramer, Associate Artistic Director  
Diana Rojas, Associate Program Director  
Josh Moody, Development Assistant  
Ray Harold, Technical Director  
Chris Ceraso, Teen Dean  
Nicole A. Watson, Teen Shakespeare Director  
Iris A. Brown, Graphic Designer  
Lisa Kerner, Jeremy Keaveny, Interns  
Teen Employees:

Jenisse Bouret, Carlos Dumé, Merlaine Mendez, Azalea Rosario,  
Luisa Santiago, Malik Velazquez, Jorge Zapata

## "You Are Here" Production Staff

### Composer/Music Director

Justin Poindexter

### Set Designer

Kevin Joseph Roach

### Lighting Designer

Greg MacPherson

### Costume Designer

Lara de Bruijn

### Sound Designer

Maury Schott

### Zombie Make-up Consultants

Jason Schuler & Keith Chandler

### Stage Manager

Carol Sullivan

**Slide Design:** George Babiak and the  
Project Slide Archive

### Prop Creation Team

George Babiak, Katherine Brown,  
Megan Cramer, Deborah Gaffaney,  
Jeremy Keaveny, Lisa Kerner,  
Eliza Muñoz, John Sheehy,  
Britney Trinidad,  
and Nathaly Trinidad

### Backstage Crew

Doris Alcantara, Livia de Paolis,  
Jeremy Keaveny, Lisa Kerner,  
Chamel Rodney

### House Managers

Liz Bell, Karin Schall

### Chefs

John Sheehy, Liz Bell,  
Carol Ochs



The Two-on-Two Program is made possible with public funds from The New York State Council on the Arts, a state agency; and the New York City Department of Cultural Affairs. The 52nd Street Project is supported by funds from the National Endowment for the Arts. The Project is a member of ART/NY.

## COOL STUFF ON SALE IN THE LOBBY!

NEW! REPLAY SCRIPTS.....\$10.00  
FABULOUS FLYER BARS ..... \$2.50, \$2, \$1.50

AND FEATURING SHEL SILVERSTEIN'S  
"FIVEY AND TWOEY" LOGO:

PROJECT T-SHIRTS.....\$12.00  
PROJECT HOODIES.....\$30.00  
PROJECT CAPS.....\$20.00  
PROJECT MUGS .....\$5.00  
PROJECT PENCIL 3-PACK .....\$1.00  
PROJECT NOTEBOOK.....\$5.00

Thank you for coming to **YOU ARE HERE!** If you are not on our mailing list (or if your address has changed), please fill out this form and give it to us on your way out or mail it to the address below. We would also like to know if you are interested in becoming a volunteer. We need help in all areas, so be sure to fill out the entire form.

PLEASE ADD ME TO YOUR MAILING LIST:

1/10

NAME \_\_\_\_\_

ADDRESS \_\_\_\_\_

CITY \_\_\_\_\_

STATE \_\_\_\_\_

ZIP \_\_\_\_\_

HOME PHONE \_\_\_\_\_

DAYTIME OR MOBILE PHONE \_\_\_\_\_

E-MAIL ADDRESS \_\_\_\_\_

MY OCCUPATION \_\_\_\_\_

MY HOBBIES \_\_\_\_\_

YES, I WOULD LIKE TO BE OF HELP. I CAN:

- |   |   |  |
|---|---|--|
| <input type="checkbox"/> Help load in and out for shows | <input type="checkbox"/> Draw and/or paint  | <input type="checkbox"/> Help kids with homework |
| <input type="checkbox"/> Hang lights                    | <input type="checkbox"/> Help with mailings | <input type="checkbox"/> Teach kids a skill      |
| <input type="checkbox"/> Work on a backstage crew       | <input type="checkbox"/> Do office work     | <input type="checkbox"/> Be a chef at an event   |
| <input type="checkbox"/> Do graphic design              | <input type="checkbox"/> Design sound       | <input type="checkbox"/> Design and sew costumes |
| <input type="checkbox"/> Other (please specify) _____   |   |  |

MY SCHEDULE IS:

- Very flexible. I'm often available during weekdays.  
 Somewhat flexible. I can help on the occasional morning or afternoon during the week.  
 Not very flexible at all, but I've got some free time on evenings and weekends.

If you would like to mail this (and you're always welcome to enclose a tax-deductible contribution), you can send it to: The 52nd Street Project, 789 10th Ave., New York, NY 10019. Or fax it to (212) 333-5598.

**DON'T MISS OUR NEXT SHOW!**

Gus Rogerson, Artistic Director

Carol Ochs, Executive Director

Megan Cramer, Playmaking Director

THE 52ND STREET PROJECT PRESENTS

# ME FIRST! THE PIONEER PLAYS

THE SPRING 2010 PLAYMAKING SHOWS

At The 52nd Street Project's

**FIVE ANGELS THEATER**

789 10th Ave., 2nd Floor  
between 52nd & 53rd St.

Admission is free, but reservations  
are strongly recommended.

To book your seats,  
call (212) 642-5052

Friday, March 26 @ 7:30 p.m.  
Saturday, March 27 @ 3:00 & 7:30 p.m.  
Sunday, March 28 @ 3:00 p.m.

10 new plays written by kids  
and performed by adult actors.



**BE ON THE LOOKOUT!  
WE ARE ALWAYS  
SEARCHING FOR INTERNS.**

If you know of any college or graduate students who might enjoy working with us, playing with us, and going on trips with us for a semester, please have them contact George Babiak or Megan Cramer. We are especially looking for interns for this summer (June through August). Thanks!

## The 52nd Street Project Board of Directors

Ben Barenholtz  
Lisa Benavides  
Rachel Chanoff  
Cathy Dantchik  
Carolyn DeSena  
Wendy Ettinger, *chair emeritus*  
Louis P. Friedman  
Stephen Graham, *chair*  
Larry Jones  
James McDaniel  
Frances McDormand  
Noël Mihalow

Carol Ochs  
Willie Reale, *founder*  
Gus Rogerson  
Shirley Rumierk,  
*alumni member*  
José Soto, Jr.,  
*alumni member*  
Jenny Steingart  
Merritt Tilney  
Pamala Tyson  
Wendy vanden Heuvel  
John A. Vassilaros

## What's Going On Here?

The 52nd Street Project is a non-profit organization that brings children from the Hell's Kitchen neighborhood together with professional theater artists to create original theater. **YOU ARE HERE!** is a production of our Two-on-Two's program, in which an adult playwright crafts a piece for a pair of Project kids to perform. Another adult directs the kids for a month that includes an intensive three-day weekend in upstate New York. Tonight's performance is the final result.

## In-Kind Contributions

The Murphy Law Office; Abbeville Press; Stephanie Berger Photography; Iris A. Brown Design; Carmine Campisi & Graphic Lab; Kenneth Cole Productions; William Curran & A Curran Affair; Diageo Chateau & Estate Wines Co.; Fresh; ICI; La Mer; New Line Cinema; Newman's Own; Noggin/The N; Parfums Givenchy & Guerlain; Paris Chocolates; Pharma Print/Omni Graphics; Sesame Workshop; Wendy Stuhlberg; John A. Vassilaros; Watkins, Inc.; Mayor's Office of Film & Television; Boylan's Bottling Co.; Lorraine Tobias & Imaginary Studios; Shapiro & Lobel; Hudson Scenic; Prime Films; and Paul, Weiss, Rifkind, Wharton & Garrison LLP.

## Special Thanks

We owe many thanks to Maria Tucci, Robert Gottlieb and Nicky Gottlieb, Vicki Mabrey, Lili Taylor, and Nick Flynn, all of whom graciously allowed us to use their upstate homes for three exhilarating and fun-filled days.

# YOU ARE HERE - ACT 1

All original music composed by Justin Poindexter

## ROOM 5252

Written by Emily Chadick Weiss

Directed by Shane West

Francesca Landscape ..... Kimberly Zenteno

Sal Celery ..... Armando Cosme, Jr.

*Perfect Place, I Deserve It More, and Perfect Place Reprise*  
lyrics by Emily Chadick Weiss.

## DANCE DANCE REVOLUTION

Written by Carly Mensch

Directed by Mary Kate Burke

Fabiana ..... Luisa Santiago

Zadie ..... Breanna Straker

*Pyramid Scheme* lyrics by Carly Mensch.

## THE ROCKET BOYS

Written by Don Nguyen

Directed by Jason Hare

Franky ..... Emmett Goodman-Boyd

Barry ..... Marcus Quiñones

*Me Moon, You Mars* lyrics by Don Nguyen.

# INTERMISSION

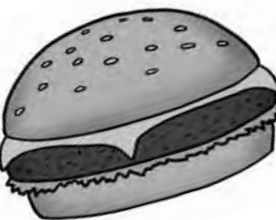

# YOU ARE HERE - ACT 2

## CHARLIE'S ANGEL

Written by Dylan Dawson

Directed by Katherine Brown

Angel ..... Viviana Vazquez

Charlie ..... Maximo Jimenez

Director ..... John Sheehy

Film Crew ..... Stage Crew

*There's No "I" in Oscar* lyrics by Dylan Dawson.

## THE POWER OF SUGGESTION

Written by Karen Trott

Directed by Suzanne Agins

Thalia deGlaze ..... Eliza Muñoz

Phoebe Carrier ..... Lily Houghton

*Hypnosis Song and It's All Thanks to Phoebe* lyrics by Karen Trott.

## ZOMBIES ALRIGHT

Written by Lloyd Suh

Directed by Jordan Mahome

Darryl ..... Malik Velazquez

Melvin ..... David McCall

Zombie Horde ..... Doris Alcantara & Chamel Rodney

*The Ballad of Darryl and Melvin* lyrics by Lloyd Suh.

## THE CAPITAL CAMPAIGN DONORS

### Indispensable Supporters

*The City of New York*

Michael R. Bloomberg, Mayor  
Christine C. Quinn, New York City Council Speaker  
Scott Stringer, Manhattan Borough President

Kate D. Levin, Commissioner, NYC Department of Cultural Affairs

*The State of New York*

David A. Paterson, Governor  
Thomas K. Duane, Senator  
Richard Gottfried, Assembly Member  
Linda B. Rosenthal, Assembly Member

### Extraordinary Supporters

Lewis Black  
Dermot Company  
Stephen & Cathy Graham  
Kresge Foundation  
Wendy vanden Heuvel & Brad Coley

### Significant Supporters

Booth Ferris Foundation  
CLAWS Foundation  
The Educational Foundation Of America  
Patrice & Louis Friedman  
The Horace W. Goldsmith Foundation  
Frances McDormand, Pedro & Joel Coen  
The New York Community Trust - LuEsther T. Mertz Advised Fund  
The Harold & Mimi Steinberg Charitable Trust  
Jenny & Jon Steingart, The Wiener Family Foundation  
Stranahan Foundation

### Generous Supporters

Altman Foundation  
Lisa Benavides & Tim Nelson  
The Big Wood Foundation  
Clinton Seed Fund  
Consolidated Edison Company of New York  
Kyle Czepiel  
The Dawkins Family Foundation  
Neil & Carolyn DeSena  
Entertainment Industry Foundation  
ETC  
Randy Frankel  
The Gasner Family  
Robert Goldberg,  
Yorke Construction Corporation  
Hudson Scenic  
Mark Jacobs  
Grace Lyu-Volckhausen

Chris Mazzilli & Gotham Comedy Club  
The Andrew W. Mellon &  
New York Foundation for the Arts  
Joe & Noël Mihalow  
The Philip D. & Tammy S. Murphy Foundation  
New Generations Program, funded by the  
Doris Duke Charitable Foundation/  
The Andrew W. Mellon Foundation &  
administered by  
Theatre Communications Group  
Newman's Own  
Judith Resnick  
Tom Shadyac  
The Surdna Foundation  
Tiger Baron Foundation  
Matt Williams &  
Angelina Fiordellisi

Andrew Actman,  
Lightspeed Financial, LLC  
Jace Alexander & Maddie Corman  
Michael Alicastro  
Aon Corporation  
APA Talent & Literary Agency  
Jeff Arsenault  
Ben Barenholtz  
Jessica Bauman & Ben Posel  
Dr. & Mrs. Michael C. Bell  
Samara & Doug Braunstein  
Shawn Byron  
Cantor Foundation  
Lawrence Catena  
Rachel Chanoff  
Ruth Anne Cohen & Robert Usdin  
Ann & Geoff Coley  
Edward Conard & Jill Davis  
Ann & Jeff Cramer  
Billy Crudup  
Wendy Ettinger & Derek McLane  
Bill & Doreen Conley  
Kevin Darien  
Downtown Arts Development, Inc.  
Brian Duggan  
Nigel Faulkner  
James Formisano  
Henry Gallo  
Christina Gerber  
Emily Grishman  
Music Preparation  
Karen Hauser & Warren Leight  
The DuBose & Dorothy Heyward  
Memorial Fund

Alexandra Productions, Inc.  
Elton Andrews  
Ronald Artzi  
Joel Asarch  
Dylan & Becky Ann Baker  
Patrick Barnes & Kent McIngvale  
Laurie Becker  
Liz Bell  
Stephanie Berger & Paul King  
Kerrison Black  
Tessa Blake & Ian Williams  
Lawrence Blau  
Buzz Bovshow  
Michelle Buffington  
Michael Busado  
Luciano Caramanica  
Constance Casey  
Rochelle & Adam Dubin  
Beth Emelson, Joe Weber &  
Beatrix Weber  
Tom Fetterman & Bonnie Mac Saveny  
Elizabeth & Paul Giamatti  
Sandi Goff & Andrew Farkas  
David Grant  
George M. Grant

### Loyal Supporters

Eric & Barbara Hippeau  
Megan Hollingshead  
Kirk & Katheryn Holt Citron  
The JKW Foundation  
Larry & Mary Jones  
Doug & Katie Jordan  
Kevin Kelly  
The Nat R. & Martha M. Knaster  
Charitable Trust, Aaron Shapiro  
& Michael A. Lobel, Trustees  
Chuck Knauss & Ann McLarty  
Colin & Rita Knudson  
Belle & Roger Kuhn  
Howard Laks  
Linden Advisors, LP  
David Lloyd &  
Megan Mortimer Lloyd  
Marsue & Peter MacNicol  
Greg MacPherson & Jane  
Perlmutter  
Roma Maffia  
Fabio Mariani  
Drew McCoy & Amy Aquino  
Al Minafo, Greenmoor  
Financial Group, LLC  
The Monteforte Foundation, Inc.  
Robin Morse & Gus Rogerson  
Rishi Nangalia  
James & Olivia O'Connor  
Carol Ochs & Bruce MacVittie  
F. Richard Pappas  
Sue Phillips  
Bat-Sheva & Thomas Peters  
Alex Primiano Jr.

### Groundswell Supporters

Connie Grappo & Lee Wilkof  
Joy Greenhouse  
Bryan Gronau  
Amy Gross  
Michael Gross  
Leigh Hampton  
Joy & Harry Henshel  
Warner Howe  
The Kaplan & Froelich Families  
Mark Keoppen &  
Wendy Townsend  
Shari Kirshner  
Judy Kuhn & David Schwab  
Justin Lerner  
Liza Lerner  
Mark & Joanne Lonow  
Jennifer Manocherian  
Paul McCrane & Dana Kellin  
James & Hannelore McDaniel  
Christian Meyer  
Adirana & Bob Mnuchin  
John Moriarty  
Bruce Moulton  
Patricia Murphy, Esq.  
John & Kimberly Mustin

Willie Reale & Jenny Gersten  
Dan Reed  
Reifer/Sky Blue Farm  
Bonnie & Richard Reiss  
Danon Robinson  
Jeffrey Rogers  
Anita Rogerson  
Jonathan Rose Companies, Inc.  
Joan & Alan Safir  
Bob Saget  
Deb Savo & Paul Giordano  
Lauren Seikaly & Michael Huber  
The Jane & Tad Shepard  
Family Foundation  
Robert & Michelle Smigel  
Helen Sogoloff  
Farrell & Steven Starker  
Jeffrey Strauss  
Richard Sweren  
Terrance Travis  
Gregory Tusar  
Pamala Tyson & Sean Mudd  
Vanessa Valdes &  
George Babiak  
Laura Valeroso & David Seidman  
Katrina vanden Heuvel  
John A. Vassilaros & Son, Inc  
Brian Villante  
Mark Whatley  
Joe White & Iris Brown  
Elizabeth Williams &  
Joseph Forte  
John William  
J.P. Xenakis

Carol & Stanley Nelson  
Cynthia Nixon  
Jacki Ochs & Jan Kroeze  
Sean Rider  
Veronica & Michael Richter  
Ida Roth  
Shirley A. Rumierk  
Sandberg-Zakian Family  
Marcia Santoni & John Morris  
Karin & Tom Schall  
John Sheehy & Kim Sherman  
David Sleeman  
Brian Sklar  
Christopher Solomon  
John Stefanelli  
Edward Thomas  
Martin Timmins  
Erin Torneo & Sascha Paladino  
Angela Trento  
Christopher Tufano  
Ed Vassallo  
Law Offices of Claudia Wagner  
Mary Pat Walsh  
Geoffrey & Hilary Wills  
Carole Yass

The 52nd Street Project gratefully acknowledges the support of the following foundations and corporations: Aberdeen Investments; The Altman Foundation; BGC ; BKSK Architects; Bloomberg ; The Brenner Family Foundation; The BWF Foundation, Inc.; The Margaret A. Cargill Foundation; Carnegie Corporation of New York; CBS Corporation; CMR Comedy; Consolidated Edison Co.; The Neil V. DeSena Foundation; Dramatists Guild Fund; Dramatists Play Service; Office of Thomas K. Duane; EIF; Sidney E. Frank Foundation; FISH Foundation; Friars National Foundation; Gio Productions, Inc.; Goldman, Sachs & Co.; The Horace W. Goldsmith Foundation; Heisman Foundation; Hudson Scenic Studio ; Saul Horowitz, Jr. Fund; Integra Realty Resources, Inc.; I. Weiss & Sons, Inc.; Jammy Productions, Inc.; JKW Foundation; James MacDonald Foundation; Ann M. Martin Foundation; Steve Martin Charitable Foundation; Marusi Family Foundation; MTI; Newman's Own ; NYFA; PAR Plumbing Co., Inc.; Pinerock Productions, Inc.; Punchline Magazine ; Ira M. Resnick Foundation, Inc.; Jonathan Rose Companies; Sesame Workshop; Shapiro & Lobel LLP; The Shaw Family Endowment Fund; The Shubert Organization; The Starker Family Foundation ; St. Vincent De Paul Foundation; Stranahan Foundation; The Surdna Foundation; Susquehanna Foundation; TaxPro Financial Network, Inc.; Tiger Baron Foundation; Van Deusen Family Fund; John A. Vassilaros & Son, Inc.; Law Offices of Claudia Wagner; Watkins, Inc.; Whoop, Inc.; Wiener Family Foundation; and Yorke Construction Corp. In addition, the following individuals made gifts over \$250 to The 52nd Street Project this past year. (list current as of 3/26/10):

Robert Abrams	Peter Jay Fernandez &	Greg MacPherson &	Pam Shaw & Victor Szymis
Cynthia Vance	Denise Burse	Jane Perlmutter	Todd Silverberg
Michael Alicastro	Suzanne Fine &	Fabio Mariani	Meg Simon
Elton Andrews	Christian Salomone	Paul McCrane & Dana Kellin	Brian Sklar
Emily Armstrong	Angelina Fiordellisi &	Frances McDormand &	Tom Slaughter
Jeff Arsenault	Matt Williams	Joel Coen	David Sleeman
Dylan & Becky Baker	Katie Flahive	Noël & Joe Mihalow	Dimitri & Helen Sogoloff
Jessica Bauman & Ben Posel	Liz Flahive & Jeff Cox	Eric Mindich & Stacey Mindich	Christopher Solomon
Lisa Benavides & Tim Nelson	Kristen Frank & Tamir Hashem	Emily & John Morgan	Gavin Solotar & Joan Solotar
Gavin Berger & Craig Berggren	Randy Frankel	John David Moriarty	Jonathan Soros &
Brett Berk	Gary Garelick	Patricia M. Murphy, Esq. &	Jennifer Soros
Rajeev Bhandari	Connie Garrido & Ray Rotolo	Adam Spilka	John Stefanelli
Pat Birch	Beverly Gasner	Rishi Nangalia	Jenny & Jon Steingart
Lewis Black	Freddie Gershon	Fred Nelson	Jeffrey Strauss
Andrew Blackman &	Jilian Gersten & Brian Shuman	Randy & Rona Nelson	Richard Sweren
Tatiana Rutkowski	Nancy Giles	Ruth Nelson	Jeanine Tesori
Emily Blavatnik	Tony Goldwyn & Jane Musky	Duncan Niederauer	Timothy Thomas
Allison & Robert Blinken	Stephen & Cathy Graham	Cynthia Nixon	Merritt Tilney & Douglas Kaden
Becky Browder & Ted Neustadt	Susannah Gray & John Lyons	Rachel & Larry Norton	Martin Timmins
Shawn Byron & Laura Byron	Jan Gura & Alan Pickman	James O'Connor &	Anne Torsiglieri &
Robert & Holly Carter	David & Ann Hausmann	Olivia O'Connor	Michael Bernard
Lawrence Catena	Sally Holmes & Doug Curtis	Carol Ochs & Bruce MacVittie	Terrance Travis & Kathy Travis
Rachel Chanoff	William Holtzman &	Jacki Ochs & Jan Kroeze	Christopher Tufano
Kirk & Katherine Holt Citron	S. Sylvia Shepard	F. Richard Pappas	Gregory Tuser
David Cohen &	Katy Homans &	Paula Park	Carol L. Nadell &
Sandra Novak Cohen	Patterson Sims	Jessica Pell	Richard E. Van Deusen
Ruth Cohen & Bob Usdin	Sarah Horowitz &	Susan Ochs Phillips	Wendy vanden Heuvel &
William Conley &	David Venarde	Judy Goldman &	Brad Coley
Doreen Conley	Warner Howe	Michael Pillinger	Ed Vassallo
David Costabile	Andrea Johnson	David Pollard	Joe Versace
Jeffrey & Anna Cramer	Cindy Kaplan & David Froelich	Peter & Helen Randolph	Brian Villante
Billy Crudup	Kevin Kelly	Willie Reale & Jenny Gersten	Richard Wagner
Kyle Czepiel	Patrick Kelly & Diane Kelly	Dan Reed	Kevin Waldron
Cathy Dantchik	Stephen Ko & Susan Ko	Jacquelyn Reingold	Mary Pat Walsh
Leslie Dantchik	Judy Kuhn & David Schwab	Burt Resnick & Judy Resnick	Lynn & Sam Waterston
Peter & Judith Dawkins	Lisa Leguillou	Michael Richter &	Ali Marsh Weller & Fred Weller
Richard & Rebecca Dresser	Warren Leight & Karen Hauser	Veronica Richter	Jane Bolster & Steve Wertimer
Brian Duggan & Carol Duggan	Robert Sean Leonard &	Danon Robinson	Michael & Zena Wiener
Greg Durkin &	Gaby Salick	Anita Rogerson	Elizabeth Williams &
Vanessa Beecroft	Anna Li & Frank Sposato	Joseph Rokacz & Larry Gordon	Joseph Forte
Wendy Ettinger &	Melissa Liebling-Goldberg &	David Ross & Laura Ross	John & Suzanne Willian
Derek McLane	John Barrett	Daryl Roth	Richard & Jill Willis
Nigel Faulkner &	Michael & Marjorie Loeb	Marcia Santoni & John Morris	J.P. Xenakis
Amanda Faulkner	John Lyons	Karin & Tom Schall	Daniel Zarkowsky
Adam Felber &	Grace Lyu-Volckhausen	Robert Shaffron & John Davis	Lynne Zeavin & Donald Moss

Gus Rogerson, Artistic Director

Carol Ochs, Executive Director

Megan Cramer, Playmaking Director

THE 52ND STREET PROJECT PRESENTS

# ME FIRST!

## THE PIONEER PLAYS

THE SPRING 2010 PLAYMAKING SHOWS

At The 52nd Street Project's

**FIVE ANGELS THEATER**

789 10th Ave., 2nd Floor  
between 52nd & 53rd St.

Friday, March 26 @ 7:30 p.m.  
Saturday, March 27 @ 3:00 & 7:30 p.m.  
Sunday, March 28 @ 3:00 p.m.

10 new plays written by kids  
and performed by adult actors.



# ME FIRST: THE PIONEER PLAYS

The Spring 2010 Playmaking Production - March 26-28, Five Angels Theater

## The 52nd Street Project Staff

Gus Rogerson, Artistic Director  
 Carol Ochs, Executive Director  
 John Sheehy, Director of Development and Marketing  
 George Babiak, Production Manager  
 Liz Bell, Director of Education  
 Megan Cramer, Associate Artistic Director  
 Diana Rojas, Associate Program Director  
 Josh Moody, Development Assistant  
 Ray Harold, Technical Director  
 Chris Ceraso, Teen Dean  
 Nicole A. Watson, Teen Shakespeare Director  
 Iris A. Brown, Graphic Designer  
 Jeremy Keaveny, Lisa Kerner, Interns  
 Teen Employees: Jenisse Bouret, Carlos Dume, Merlaine Mendez, Chloe Moore,  
 C.J. Muentes, Azalea Rosario, Jonathan Rosario, Luisa Santiago,  
 Malik Velazquez, Jorge Zapata

## "Me First" Production Staff

Composer/Music Director Matt Schatz	Lisa Kerner, Lee Rosen, Britney Trinidad, Nathaly Trinidad
Piano Patrick Barnes	Backstage Crew Ralphie Irizarry III, Jeremy Keaveny, Lisa Kerner, Brielle Silvestri, Viviana Vazquez
Set Designer Kevin Joseph Roach	House Managers Liz Bell, Karin Schall
Lighting Designer Greg MacPherson	Flyer Art Patrick Jones
Costume Designers Katherine Brown, Kate Cusack	Chefs John Sheehy, Liz Bell, Carol Ochs
Sound Designer Maury Schott	Playmaking Class Volunteers Patrick Clair, Nehassaiu deGannes, Nancy Giles, Erica Jensen, Shelly Oria, Matt Schatz, Brad Weinstock
Stage Manager Charles M. Turner, III	
Slide Design: George Babiak and the Project Slide Archive	
Prop Design Team George Babiak, Liz Bell, Megan Cramer, Jeremy Keaveny,	



The Playmaking Program is made possible with public funds from The New York State Council on the Arts, a state agency; and the New York City Department of Cultural Affairs. The 52nd Street Project is supported by funds from the National Endowment for the Arts. The Project is a member of ART/NY.

## COOL STUFF ON SALE IN THE LOBBY!

NEW! REPLAY SCRIPTS.....\$10.00  
 FABULOUS FLYER BARS ..... \$2.50, \$2, \$1.50

AND FEATURING SHEL SILVERSTEIN'S  
 "FIVEY AND TWOEY" LOGO:

PROJECT T-SHIRTS.....\$12.00  
 PROJECT HOODIES.....\$30.00  
 PROJECT CAPS.....\$20.00  
 PROJECT MUGS .....\$5.00  
 PROJECT PENCIL 3-PACK .....\$1.00  
 PROJECT NOTEBOOK.....\$5.00

Thank you for coming to **ME FIRST!** If you are not on our mailing list (or if your address has changed), please fill out this form and give it to us on your way out or mail it to the address below. We would also like to know if you are interested in becoming a volunteer. We need help in all areas, so be sure to fill out the entire form.

PLEASE ADD ME TO YOUR MAILING LIST:

03/10

NAME \_\_\_\_\_

ADDRESS \_\_\_\_\_

CITY \_\_\_\_\_ STATE \_\_\_\_\_ ZIP \_\_\_\_\_

HOME PHONE \_\_\_\_\_

DAYTIME OR MOBILE PHONE \_\_\_\_\_ E-MAIL ADDRESS \_\_\_\_\_

MY OCCUPATION \_\_\_\_\_

MY HOBBIES \_\_\_\_\_

YES, I WOULD LIKE TO BE OF HELP. I CAN:

- |   |   |  |
|---|---|--|
| <input type="checkbox"/> Help load in and out for shows | <input type="checkbox"/> Draw and/or paint  | <input type="checkbox"/> Help kids with homework |
| <input type="checkbox"/> Hang lights                    | <input type="checkbox"/> Help with mailings | <input type="checkbox"/> Teach kids a skill      |
| <input type="checkbox"/> Work on a backstage crew       | <input type="checkbox"/> Do office work     | <input type="checkbox"/> Be a chef at an event   |
| <input type="checkbox"/> Do graphic design              | <input type="checkbox"/> Design sound       | <input type="checkbox"/> Design and sew costumes |
| <input type="checkbox"/> Other (please specify) _____   |   |  |

MY SCHEDULE IS:

- Very flexible. I'm often available during weekdays.  
 Somewhat flexible. I can help on the occasional morning or afternoon during the week.  
 Not very flexible at all, but I've got some free time on evenings and weekends.

If you would like to mail this (and you're always welcome to enclose a tax-deductible contribution), you can send it to: The 52nd Street Project, 789 10th Avenue, New York, NY 10019. Or fax it to (212) 333-5598.

## COMING UP:

The Board of Directors of The 52nd Street Project invite you to

# SAVE THE DATE! MONDAY, MAY 10, 2010

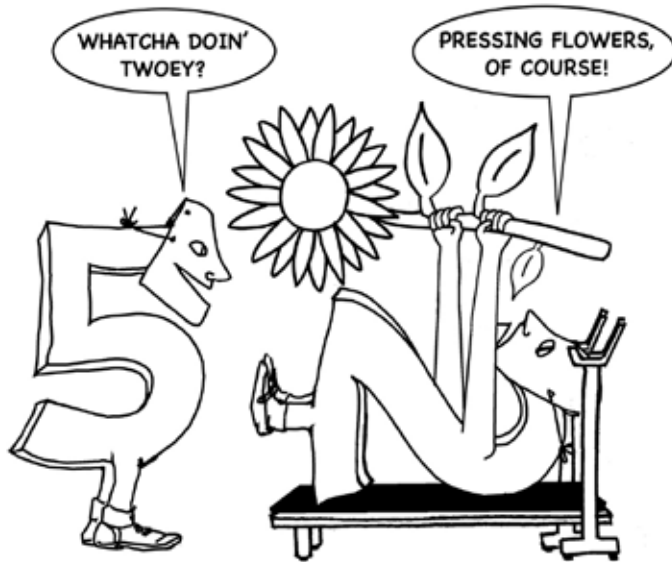

## The Spring Sing Thing A Garden Variety Benefit

The 52nd Street Project's Annual Gala

For information and reservations,  
contact John "The Constant Gardener" Sheehy  
at (212) 333-5252 or sheehy@52project.org



### BE ON THE LOOKOUT!

WE ARE ALWAYS SEARCHING FOR INTERNS.

If you know any college or graduate students who might enjoy working with us, playing with us, and going on trips with us for a semester, please have them contact George Babiak or Megan Cramer. We are looking for interns for June-August, 2010. Thanks!

## The 52nd Street Project Board of Directors

Ben Barenholtz	Noël Mihalow
Lisa Benavides	Carol Ochs
Rachel Chanoff	Willie Reale, founder
Cathy Dantchik	Gus Rogerson
Carolyn DeSena	Shirley Rumierk, alumni member
Wendy Ettinger, chair emeritus	José Soto, Jr., alumni member
Louis P. Friedman	Jenny Steingart
Stephen Graham, chair	Pamala Tyson
Larry Jones	Wendy vanden Heuvel
James McDaniel	John A. Vassilaros
Frances McDormand	

### What's Going On Here?

The 52nd Street Project is a non-profit organization that brings children from the Hell's Kitchen neighborhood together with professional theater artists to create original theater. ME FIRST is a production of our Playmaking program. Young people participate in a nine-week playwriting course taught by Megan Cramer and adapted for the Project by Daniel Judah Sklar from his book *Playmaking: Children Writing and Performing Their Own Plays*. At the end of the course, each child is given two actors, a theme, and a dramaturg/director who guides him or her through the writing of a play during a weekend retreat in the country (Bridgehampton for this show). Tonight's performance is the end result.

### In-Kind Contributions

Abbeville Press; Stephanie Berger Photography; Iris A. Brown Design; Kenneth Cole Productions; William Curran & A Curran Affair; ICI; Newman's Own; Noggin/The N; Paris Chocolates; Pharma Print/Omni Graphics; Sesame Workshop; Wendy Stuhlberg; John A. Vassilaros; Watkins, Inc.; Mayor's Office of Film & Television; Ron Fiorina and Boylan's Bottling Co.; Shapiro & Lobel; Hudson Scenic; Prime Films, and Paul, Weiss, Rifkind, Wharton & Garrison LLP. , Empanada Mama's, Fat Sal's Pizza, Mitchell London Foods, Wendy Stuhlberg, Steve Olsen and the Westbank Cafe, and Mary Pat Walsh.

### Special Thanks

We're extremely grateful to John Vassilaros, Alex Gersten-Vassilaros, their boys Tonio, Luka and Stefano, the ever-helpful Joyce, and Zeus the dog for allowing us to use their home as our headquarters and boy dormitory on our Playmaking retreat to Bridgehampton last month. We also owe gratitude to Laurie Becker, who let some volunteers and the girl writers crash at her luxurious pad in Sag Harbor.



# ME FIRST - ACT 1

All original music composed by Matt Schatz

## SAMANTHA AND RILEY UNITE

Written by Deborah Welch, age 10.

Director/ Dramaturge: Laura Konsin.

Samantha ..... Nancy Giles  
Riley.....Phyllis Somerville  
Mom.....Megan Cramer  
Popular Girls..... Crew

*Differences, Notice Me, and Friends* lyrics by Deborah Welch.

## BRAIN STORM

Written by Eric Carrero, age 10.

Dramaturge: Josh Moody, Director: Henry Wishcamper.

Brain Man .....Tim Cain  
Brain Kid .....Jinn S. Kim  
Evil Devil.....George Babiak  
White Castle Worker..... Jeremy Keaveny

*Chicken* lyrics by Eric Carrero.

## THE HALL OF MIRRORS

Written by Delia Cadman, age 10.

Director/Dramaturge: Jordan Young.

Luna Wolff .....Nitya Vidyasagar  
Venus Fullmon.....Opal Alladin

## DOUG AND SETH FAMILY FINDING

Written by Brandon Draude, age 10.

Director/Dramaturge: Josh Lewis.

Doug ..... Pun Bandhu  
Seth ..... Hannah Cabell  
The Kid ..... Viviana Vazquez

*We've Been Traveling, and We've Been Traveling Reprise*  
lyrics by Brandon Draude.

## BOB AND BOBBIE

Written by Ruby Zamora, age 9.

Director/Dramaturge: Nicole A. Watson.

Bob .....Robert Stanton  
Bobbie ..... Jeanine Serralles  
Rats with Alien Heads..... The Crew

*Bob and Bobbie* lyrics by Ruby Zamora.

# ME FIRST - ACT 2

## BEST-IST OF FREN-ZIES

Written by Jocelyn Ochoa, age 10.

Dramaturge: Alex Gersten-Vassilaros, Director: Patricia McGregor.

Christal ..... Lucy DeVito  
Sarah..... Nikiya Mathis  
Judge.....John Sheehy

*I Wanna Win and Friends* lyrics by Jocelyn Ochoa.

## THE REVENGE OF THE PSYCHO PLATYPUS

Written by Enrique Caballero, age 10.

Director/Dramaturge: Kirsten Kelly.

Shockwave ..... Cary Donaldson  
Dirt Bag/Computer .....Marguerite Stimpson  
Mom..... Brielle Silvestri  
Pizza Guy ..... Jeremy Keaveny

*I Eat Rats and Ooooo It Was an Accident* lyrics by Enrique Caballero.

## BLOODY BOOM BOXES

Written by Tatiana Goode, age 10.

Director/Dramaturge: Awoye Timpo.

Jeffrey ..... Michael Potts  
Maria..... Nehassaiu deGannes

*Together* lyrics by Tatiana Goode.

## BACK TO HIGH SCHOOL OR DIES

Written by Richard Brea, age 10.

Director/Dramaturge: Stephen Ruddy.

Chum Chum ..... Bill Camp  
John T-Mobile ..... Daniel Jenkins  
Assistants/School Kids ..... Crew

*Chum Chum and John Song* lyrics by Richard Brea.



## THE CAPITAL CAMPAIGN DONORS

### Indispensable Supporters

*The City of New York*

Michael R. Bloomberg, Mayor  
Christine C. Quinn, New York City Council Speaker  
Scott Stringer, Manhattan Borough President

Kate D. Levin, Commissioner, NYC Department of Cultural Affairs

*The State of New York*

David A. Paterson, Governor  
Thomas K. Duane, Senator  
Richard Gottfried, Assembly Member  
Linda B. Rosenthal, Assembly Member

### Extraordinary Supporters

Lewis Black  
Dermot Company  
Stephen & Cathy Graham  
Kresge Foundation  
Wendy vanden Heuvel & Brad Coley

### Significant Supporters

Booth Ferris Foundation  
CLAWS Foundation  
The Educational Foundation Of America  
Patrice & Louis Friedman  
The Horace W. Goldsmith Foundation  
Frances McDormand, Pedro & Joel Coen  
The New York Community Trust - LuEsther T. Mertz Advised Fund  
The Harold & Mimi Steinberg Charitable Trust  
Jenny & Jon Steingart, The Wiener Family Foundation

### Generous Supporters

Altman Foundation	Chris Mazzilli & Gotham Comedy Club
Lisa Benavides & Tim Nelson	The Andrew W. Mellon &
The Big Wood Foundation	New York Foundation for the Arts
Clinton Seed Fund	Joe & Noël Mihalow
Consolidated Edison Company of New York	The Philip D. & Tammy S. Murphy Foundation
Kyle Czepiel	New Generations Program, funded by the
The Dawkins Family Foundation	Doris Duke Charitable Foundation/ The Andrew W. Mellon Foundation &
Neil & Carolyn DeSena	administered by
Entertainment Industry Foundation	Theatre Communications Group
ETC	Newman's Own
Randy Frankel	Judith Resnick
The Gasner Family	Tom Shadyac
Robert Goldberg,	The Surdna Foundation
Yorke Construction Corporation	Tiger Baron Foundation
Hudson Scenic	Matt Williams &
Mark Jacobs	Angelina Fiordellisi
Grace Lyu-Volckhausen	

### Loyal Supporters

Andrew Actman, Lightspeed Financial, LLC	Eric & Barbara Hippeau	Willie Reale & Jenny Gersten
Jace Alexander & Maddie Corman	Megan Hollingshead	Dan Reed
Michael Alicastro	Kirk & Katheryn Holt Citron	Reifer/Sky Blue Farm
Aon Corporation	The JKW Foundation	Bonnie & Richard Reiss
APA Talent & Literary Agency	Larry & Mary Jones	Danon Robinson
Jeff Arsenault	Doug & Katie Jordan	Jeffrey Rogers
Ben Barenholtz	Kevin Kelly	Anita Rogerson
Jessica Bauman & Ben Posel	The Nat R. & Martha M. Knaster Charitable Trust, Aaron Shapiro & Michael A. Lobel, Trustees	Jonathan Rose Companies, Inc.
Dr. & Mrs. Michael C. Bell	Chuck Knauss & Ann McLarty	Joan & Alan Safir
Samara & Doug Braunstein	Colin & Rita Knudson	Bob Saget
Shawn Byron	Belle & Roger Kuhn	Deb Savo & Paul Giordano
Cantor Foundation	Howard Laks	Lauren Seikaly & Michael Huber
Lawrence Catena	Linden Advisors, LP	The Jane & Tad Shepard Family Foundation
Rachel Chanoff	David Lloyd &	Robert & Michelle Smigel
Ruth Anne Cohen & Robert Usdin	Megan Mortimer Lloyd	Helen Sogoloff
Ann & Geoff Coley	Marsue & Peter MacNicol	Farrell & Steven Starker
Edward Conard & Jill Davis	Greg MacPherson & Jane	Jeffrey Strauss
Ann & Jeff Cramer	Perlmutter	Richard Sweren
Billy Crudup	Roma Maffia	Terrance Travis
Wendy Ettinger & Derek McLane	Fabio Mariani	Gregory Tusar
Bill & Doreen Conley	Drew McCoy & Amy Aquino	Pamala Tyson & Sean Mudd
Kevin Darien	Al Minafo, Greenmoor Financial Group, LLC	Vanessa Valdes & George Babiak
Downtown Arts Development, Inc.	The Monteforte Foundation, Inc.	Laura Valeroso & David Seidman
Brian Duggan	Robin Morse & Gus Rogerson	Katrina vanden Heuvel
Nigel Faulkner	Rishi Nangalia	John A. Vassilaros & Son, Inc
James Formisano	James & Olivia O'Connor	Brian Villante
Henry Gallo	Carol Ochs & Bruce MacVittie	Mark Whatley
Christina Gerber	F. Richard Pappas	Joe White & Iris Brown
Emily Grishman	Sue Phillips	Elizabeth Williams & Joseph Forte
Music Preparation	Bat-Sheva & Thomas Peters	John William
Karen Hauser & Warren Leight	Alex Primiano Jr.	J.P. Xenakis
The DuBose & Dorothy Heyward Memorial Fund		

### Groundswell Supporters

Alexandra Productions, Inc.	Connie Grappo & Lee Wilkof	Carol & Stanley Nelson
Elton Andrews	Joy Greenhouse	Cynthia Nixon
Ronald Artzi	Bryan Gronau	Jacki Ochs & Jan Kroeze
Joel Asarch	Amy Gross	Sean Rider
Dylan & Becky Ann Baker	Michael Gross	Veronica & Michael Richter
Patrick Barnes & Kent McIngvale	Leigh Hampton	Ida Roth
Laurie Becker	Joy & Harry Henshel	Shirley A. Rumierk
Liz Bell	Warner Howe	Sandberg -Zakian Family
Stephanie Berger & Paul King	The Kaplan & Froelich Families	Marcia Santoni & John Morris
Kerrison Black	Mark Keoppen &	Karin & Tom Schall
Tessa Blake & Ian Williams	Wendy Townsend	John Sheehy & Kim Sherman
Lawrence Blau	Shari Kirshner	David Sleeman
Buzz Bovshow	Judy Kuhn & David Schwab	Brian Sklar
Michelle Buffington	Justin Lerner	Christopher Solomon
Michael Busado	Liza Lerner	John Stefanelli
Luciano Caramanica	Mark & Joanne Lonow	Edward Thomas
Constance Casey	Jennifer Manocherian	Martin Timmins
Rochelle & Adam Dubin	Paul McCrane & Dana Kellin	Erin Torneo & Sascha Paladino
Beth Emelson, Joe Weber & Beatrix Weber	James & Hannelore McDaniel	Angela Trento
Tom Fetterman & Bonnie Mac Saveny	Christian Meyer	Christopher Tufano
Elizabeth & Paul Giamatti	Adirana & Bob Mnuchin	Ed Vassallo
Sandi Goff & Andrew Farkas	John Moriarty	Law Offices of Claudia Wagner
David Grant	Bruce Moulton	Mary Pat Walsh
George M. Grant	Patricia Murphy, Esq.	Geoffrey & Hilary Wills
	John & Kimberly Mustin	Carole Yass

## Loyal Supporters

Andrew Actman,  
Lightspeed Financial, LLC  
Jace Alexander & Maddie Corman  
Michael Alicastro  
Aon Corporation  
APA Talent & Literary Agency  
Jeff Arsenault  
Ben Barenholtz  
Jessica Bauman & Ben Posel  
Dr. & Mrs. Michael C. Bell  
Samara & Doug Braunstein  
Shawn Byron  
Cantor Foundation  
Lawrence Catena  
Rachel Chanoff  
Ruth Anne Cohen & Robert Usdin  
Ann & Geoff Coley  
Edward Conard & Jill Davis  
Ann & Jeff Cramer  
Billy Crudup  
Wendy Ettinger & Derek McLane  
Bill & Doreen Conley  
Kevin Darien  
Downtown Arts Development, Inc.  
Brian Duggan  
Nigel Faulkner  
James Formisano  
Henry Gallo  
Christina Gerber  
Emily Grishman  
Music Preparation  
Karen Hauser & Warren Leight  
The DuBose & Dorothy Heyward  
Memorial Fund

Eric & Barbara Hippeau  
Megan Hollingshead  
Kirk & Katheryn Holt Citron  
The JKW Foundation  
Larry & Mary Jones  
Doug & Katie Jordan  
Kevin Kelly  
The Nat R. & Martha M. Knaster  
Charitable Trust, Aaron Shapiro  
& Michael A. Lobel, Trustees  
Chuck Knauss & Ann McLarty  
Colin & Rita Knudson  
Belle & Roger Kuhn  
Howard Laks  
Linden Advisors, LP  
David Lloyd &  
Megan Mortimer Lloyd  
Marsue & Peter MacNicol  
Greg MacPherson & Jane  
Perlmutter  
Roma Maffia  
Fabio Mariani  
Drew McCoy & Amy Aquino  
Al Minafo, Greenmoor  
Financial Group, LLC  
The Monteforte Foundation, Inc.  
Robin Morse & Gus Rogerson  
Rishi Nangalia  
James & Olivia O'Connor  
Carol Ochs & Bruce MacVittie  
F. Richard Pappas  
Sue Phillips  
Bat-Sheva & Thomas Peters  
Alex Primiano Jr.

Willie Reale & Jenny Gersten  
Dan Reed  
Reifer/Sky Blue Farm  
Bonnie & Richard Reiss  
Danon Robinson  
Jeffrey Rogers  
Anita Rogerson  
Jonathan Rose Companies, Inc.  
Joan & Alan Safir  
Bob Saget  
Deb Savo & Paul Giordano  
Lauren Seikaly & Michael Huber  
The Jane & Tad Shepard  
Family Foundation  
Robert & Michelle Smigel  
Helen Sogoloff  
Farrell & Steven Starker  
Jeffrey Strauss  
Richard Sweren  
Terrance Travis  
Gregory Tusar  
Pamala Tyson & Sean Mudd  
Vanessa Valdes &  
George Babiak  
Laura Valeroso & David Seidman  
Katrina vanden Heuvel  
John A. Vassilaros & Son, Inc  
Brian Villante  
Mark Whatley  
Joe White & Iris Brown  
Elizabeth Williams &  
Joseph Forte  
John William  
J.P. Xenakis

## Groundswell Supporters

Alexandra Productions, Inc.  
Elton Andrews  
Ronald Artzi  
Joel Asarch  
Dylan & Becky Ann Baker  
Patrick Barnes & Kent McIngvale  
Laurie Becker  
Liz Bell  
Stephanie Berger & Paul King  
Kerrison Black  
Tessa Blake & Ian Williams  
Lawrence Blau  
Buzz Bovshow  
Michelle Buffington  
Michael Busado  
Luciano Caramanica  
Constance Casey  
Rochelle & Adam Dubin  
Beth Emelson, Joe Weber &  
Beatrix Weber  
Tom Fetterman & Bonnie Mac Saveny  
Elizabeth & Paul Giamatti  
Sandi Goff & Andrew Farkas  
David Grant  
George M. Grant

Connie Grappo & Lee Wilkof  
Joy Greenhouse  
Bryan Gronau  
Amy Gross  
Michael Gross  
Leigh Hampton  
Joy & Harry Henshel  
Warner Howe  
The Kaplan & Froelich Families  
Mark Keoppen &  
Wendy Townsend  
Shari Kirshner  
Judy Kuhn & David Schwab  
Justin Lerner  
Liza Lerner  
Mark & Joanne Lonow  
Jennifer Manocherian  
Paul McCrane & Dana Kellin  
James & Hannelore McDaniel  
Christian Meyer  
Adirana & Bob Mnuchin  
John Moriarty  
Bruce Moulton  
Patricia Murphy, Esq.  
John & Kimberly Mustin

Carol & Stanley Nelson  
Cynthia Nixon  
Jacki Ochs & Jan Kroeze  
Sean Rider  
Veronica & Michael Richter  
Ida Roth  
Shirley A. Rumierk  
Sandberg -Zakian Family  
Marcia Santoni & John Morris  
Karin & Tom Schall  
John Sheehy & Kim Sherman  
David Sleeman  
Brian Sklar  
Christopher Solomon  
John Stefanelli  
Edward Thomas  
Martin Timmins  
Erin Torneo & Sascha Paladino  
Angela Trento  
Christopher Tufano  
Ed Vassallo  
Law Offices of Claudia Wagner  
Mary Pat Walsh  
Geoffrey & Hilary Wills  
Carole Yass

## THE CAPITAL CAMPAIGN DONORS

### Indispensable Supporters

*The City of New York*  
Michael R. Bloomberg, Mayor  
Christine C. Quinn, New York City Council Speaker  
Scott Stringer, Manhattan Borough President  
Kate D. Levin, Commissioner, NYC Department of Cultural Affairs

*The State of New York*  
David A. Paterson, Governor  
Thomas K. Duane, Senator  
Richard Gottfried, Assembly Member  
Linda B. Rosenthal, Assembly Member

### Extraordinary Supporters

Lewis Black  
Dermot Company  
Stephen & Cathy Graham  
Kresge Foundation  
Wendy vanden Heuvel & Brad Coley

### Significant Supporters

Booth Ferris Foundation  
CLAWS Foundation  
The Educational Foundation of America  
Patrice & Louis Friedman  
The Horace W. Goldsmith Foundation  
Frances McDormand, Pedro & Joel Coen  
The New York Community Trust - LuEsther T. Mertz Advised Fund  
The Harold & Mimi Steinberg Charitable Trust  
Jenny & Jon Steingart, The Wiener Family Foundation

### Generous Supporters

Altman Foundation  
Lisa Benavides & Tim Nelson  
The Big Wood Foundation  
Clinton Seed Fund  
Consolidated Edison Company of New York  
Kyle Czepiel  
The Dawkins Family Foundation  
Neil & Carolyn DeSena  
Entertainment Industry Foundation  
ETC  
Randy Frankel  
The Gasner Family  
Robert Goldberg,  
Yorke Construction Corporation  
Hudson Scenic  
Mark Jacobs  
Grace Lyu-Volckhausen  
Chris Mazzilli & Gotham Comedy Club  
The Andrew W. Mellon &  
New York Foundation for the Arts  
Joe & Noël Mihalow  
The Philip D. & Tammy S. Murphy Foundation  
New Generations Program, funded by the  
Doris Duke Charitable Foundation/  
The Andrew W. Mellon Foundation &  
administered by  
Theatre Communications Group  
Newman's Own  
Judith Resnick  
Tom Shadyac  
The Surdna Foundation  
Tiger Baron Foundation  
Matt Williams &  
Angelina Fiordellisi

## The 52nd Street Project Board of Directors

Lisa Benavides  
Rachel Chanoff  
Cathy Dantchik  
Carolyn DeSena  
Wendy Ettinger,  
*Chair Emeritus*  
Louis P. Friedman  
Stephen Graham, *Chair*  
James McDaniel  
Frances McDormand  
Noël Mihalow  
Carol Ochs

Willie Reale,  
*founder*  
Gus Rogerson  
Shirley Rumierk,  
*alumni member*  
José Soto, Jr.,  
*alumni member*  
Jenny Steingart  
Merritt Tilney  
Pamala Tyson  
Wendy vanden Heuvel  
John A. Vassilaros

## The 52nd Street Project Staff

Carol Ochs, Executive Director  
Gus Rogerson, Artistic Director  
John Sheehy, Dir. of Development and Marketing  
George Babiak, Production Manager  
Liz Bell, Director of Education  
Megan Cramer, Associate Artistic Director  
Josh Moody, Development Assistant  
Diana Rojas, Associate Program Director  
Ray Harold, Technical Director  
Chris Ceraso, Teen Dean  
Nicole A. Watson, Teen Shakespeare Director  
Iris A. Brown, Graphic Designer  
Jeremy Keaveny and Lisa Kerner, Interns

## Benefit Volunteers

Kyle Haden, Jason Hare, Jessica Hare, Joanna Parsons,  
Kim D. Sherman, Felix Solis, Vanessa Valdes, Nicole A. Watson

## Special Thanks

Becky Browder, Kate Cusack, Michael Dorf,  
Scott Dougan, Terry Fitzpatrick, Jenny Gersten, Jessalyn Gilsig,  
Emily Grishman, Mark Jacobs, Lisa Leguillou, Daniel Levy,  
Josh Lewis, Marshall Neilson, Steve Olsen, Willie Reale,  
Adam Platt, Oliver Platt, Karin & Tom Schall, Mary Pat Walsh

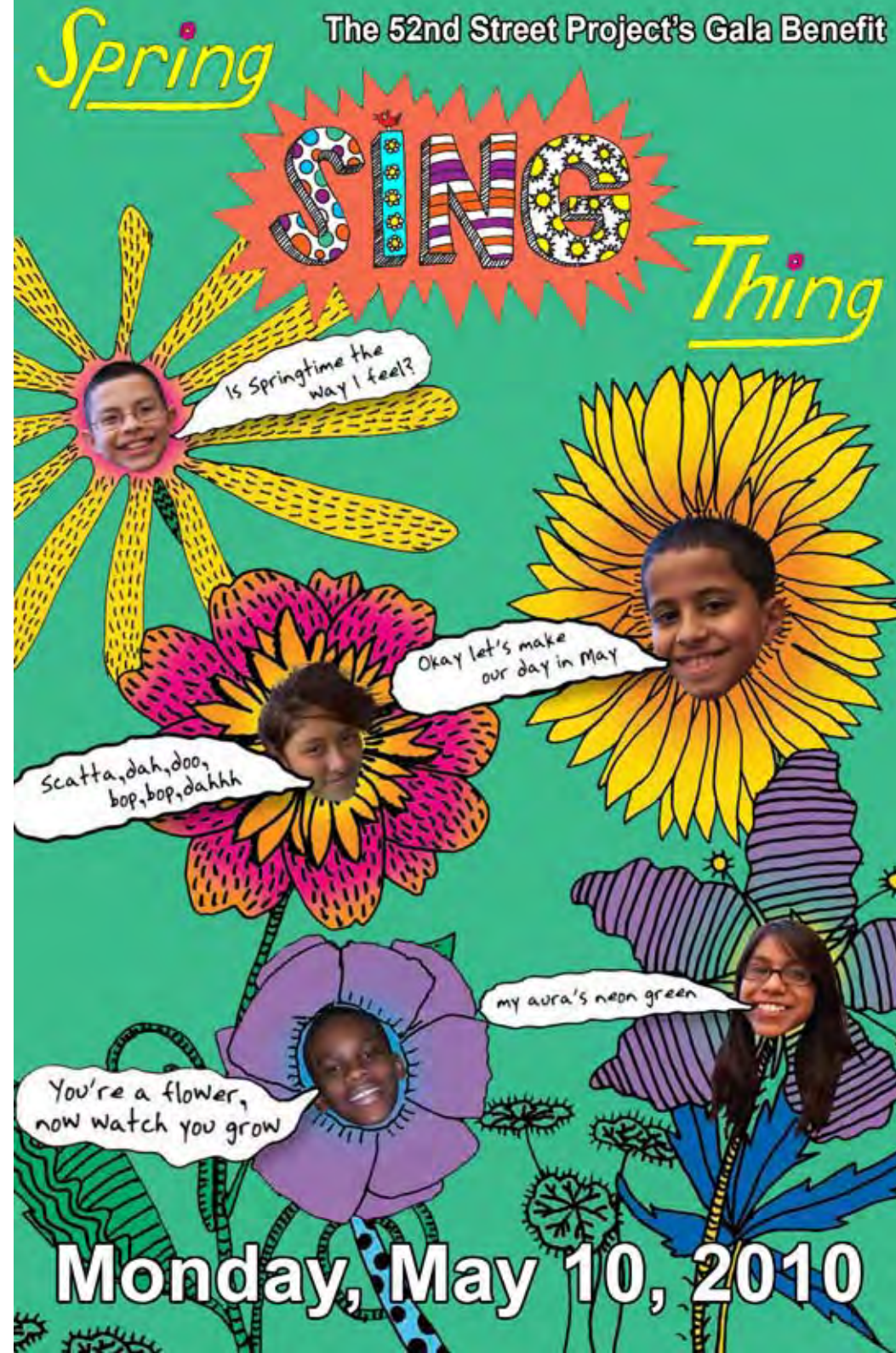

## Spring Sing Thing Benefit Co-Chairs

Lisa Benavides	Karin Schall
Cathy Dantchik	Jenny Steingart
Carolyn DeSena	Merritt Tilney
Louis P. Friedman	Laura Valeroso
Patrice Friedman	Mary Pat Walsh

## Rock Seats

Cecilia Arana-Grant	Yvette McLarty
Emily Armstrong & Thomas P. Gannon	Matthew Moreno, Siemens Industry Emily & John Morgan
Beth & Eric Berman	Suzen Murakoshi & Mark Temme
Stephen Bernstein	Patricia Murphy & Adam Spilka Jodi Nussbaum
BKSK Architects	Jacki Ochs & Jan Kroeze
Jane Bolster & Steve Wertimer	Paul & Maria Onderdonk Sue Phillips
Buzz Bovshov	Judy & Michael Pillinger
Patrick Breen	Christopher Randolph
Becky Browder & Ted Neustadt	Jackie Reingold & Rich Campbell Maury Schott
Denise Burse & Peter Jay Fernandez	David Schwab
Rachel Chanoff & Wolf Chanoff	Sylvia Shepard & Will Holtzman Rob Shore
Melissa Cohn & John Paris	Meg Simon
Margaret Crimmins	Jeanne Simpson & Adam Felber Lois Smith
Rebecca & Richard Dresser	Tracy Straus
Anita Durst	Lynn Street & Donald Margulies Susanna Styron
Liz Flahive & Jeff Cox	Alice Phillips Swistel
Anita Flanagan & Jeff Potter	Edith Thurber & Kevin O'Rourke Lisa Tilney & Chris Lawrence
Alison Fraser & Nat Magee	Karen Trott & Peter Herdrich Liz Tuccillo
Sally Froelich	Laura Valeroso & David Seidman Susan J. Vitucci
Jenny Gersten & Willie Reale	Yildiz Yuksek & Richard Blackstone Connie & Marc Zand
Nancy Giles	
Kilty Gilmour	
Bonnie Gross	
Jan Gura & Alan Pickman	
Annie Hausmann	
Linda LeRoy Janklow	
Frances & Fred Langbecker	
Mickey Lemle	
Martin Levine, The Par Group	
Susan & Jeff Lucier	

## The 52nd Street Project gratefully acknowledges...

Abbeville Press  
Lewis Black  
Richard Blackstone  
Iris A. Brown Design  
City Winery  
William Curran,  
A Curran Affair  
Disney Hyperion  
Fox Television  
Howard Grier, Seventeen  
Bill Lawrence, S.F. Giants  
Steve Olsen, Westbank Cafe  
John Paris  
Pharma/Omni Printing  
Sesame Workshop  
Shapiro Lobel, LLP  
Ryan Thorvaldsen, N.Y. Yankees  
John A. Vassilaros & Sons  
Rob White  
Watkins Incorporated  
Healthier Living Since 1868

## I Never Promised You a Rose Seats

Becky Ann & Dylan Baker  
Julia & Adam Beaser  
Lisa Benavides & Tim Blake Nelson  
Gavin Berger & Craig Berggren  
Allison M. Blinken  
Michelle Bork & Jonathan Levine  
Laura & Scott Gewirtz  
Karen Hauser & Warren Leight  
Katheryn Holt Citron & Kirk Citron  
Sarah Horowitz & David Venarde  
Andrea Johnson  
Cynthia Kaplan & David Froelich  
Adrienne Lobel  
John S. Lyons  
Grace Lyu-Volckhausen  
Frances McDormand  
Stacey & Eric Mindich  
The Monteforte Foundation  
Jane Musky & Tony Goldwyn  
Cynthia Nixon  
Jane Perlmutter & Greg MacPherson  
Ira Resnick  
Anita A. Rogerson  
Laura & David Ross  
Carla Sacks & John Morris  
Karin & Thomas Schall  
Jennifer & Jonathan Allan Soros  
Richard Sweren  
Victor Syrmis  
Jennifer Tangleff & David Rosenberg  
Gina Torres & Laurence Fishburne  
Cynthia Vance & Robert Abrams  
Susan Wallace, Jonathan Rose Companies  
Mary Pat Walsh  
Elizabeth Williams & Joseph Forte  
Carole Yass

Carol Ochs,  
Executive Director

Stephen Graham,  
Board Chair

Gus Rogerson,  
Artistic Director

# Spring Sing Thing

A Garden-Variety Benefit for The 52nd Street Project

*Honorary Chairs: Idina Menzel and Taye Diggs*

Monday, May 10, 2010

Espace

## The Show

### Emcee

Martha Plimpton

### The Lyricists

Adnan Ahmed, Wendell Joseph,  
Brandon Leon, Melissa Rebolledo, Elizabeth Vazquez

### The Composers

Michael Cerveris, Tom Kitt, Brian Lowdermilk,  
Greg Naughton, Jeanine Tesori

### The Singers

Michael Cerveris, James Monroe Iglehart, Rebecca Naomi Jones,  
Matthew Morrison, Greg Naughton, Kelli O'Hara, Martha Plimpton

### Back-Up Springers

Emma Hunton, Gabriel Violett

### The Musicians

Thad DeBrock, Guitar  
Kimberly Grigsby, Piano  
Jeff Potter, Drums

### Director

Jonathan Bernstein

### Music Director

Kimberly Grigsby

### Music Coordinator

Kim D. Sherman

### Lighting Designer

Greg MacPherson

### Sound Designer

Charles Coe

### Set Design

George Babiak

### Stage Manager

Charles M. Turner, III

### Written by

John Sheehy

# She the Best

By Adnan Ahmed, age 10

Composed by Brian Lowdermilk

Performed by James Monroe Iglehart, Gabriel Violett & Martha Plimpton

**HE:**

HERE I GO RIGHT NOW

I'M HERE ALL ALONE  
THINKING HOW I'M GONNA SAY  
TO THIS GIRL WHO I LIKE  
BUT THE ONLY THING, SHE IS NOT ALWAYS ALONE  
SO I GOTTA MAKE MY VOICE  
LOW 'CAUSE SHE IS NOT ALWAYS ALONE  
I HATE TO SEE HER SAY NO  
BUT I LOVE TO SEE HER SAY  
"OKAY LET'S MAKE OUR DAY IN MAY"  
AND IF SHE SAY THAT  
SHE ROCK YEAH

SHE THE BEST  
SHE THE BEST  
I SAY WHAT  
SHE THE BEST  
A'IGHT SHE THE BEST

HERE I GO RIGHT NOW

PEOPLE THINK SHE  
AIN'T GONNA SAY YES  
'CAUSE SHE SO PRETTY  
AND I LOOK DORKY  
PSYCH!  
I'M JUST SAYING THAT TO RHYME WITH PRETTY YEAH  
I'M SO COOL THAT I'M COOLER THAN HER  
I'M JUST ASKING HER 'CAUSE SHE SO PRETTY  
PRETTIER THAN MILEY CYRUS YEAH  
AND THAT MEANS SHE SO PRETTY

SHE THE BEST AND PRETTY  
SHE THE BEST  
SHE LOOK SO PRETTY SHE LOOK LIKE BEYONCÉ  
YEAH  
SHE THE BEST

NOW I GOTTA TELL HER SO WISH ME LUCK  
HERE I GO RIGHT NOW  
HEY GIRL DO YOU WANT TO GO OUT WITH ME?

**SHE:**

OKAY LET'S MAKE OUR DAY IN MAY OKAY.

**HE:**

ALRIGHT NOW MY WISH WAS RIGHT  
SHE SAID THE SAME WORDS THAT I WANTED  
HER TO TELL ME  
SHE THE BEST  
GOODBYE.

# Eden Tables

The Dantchik Family  
Cathy & Stephen Graham  
Jenny & Jon Steingart

# Earthy Delights Tables

Patrice & Louis Friedman  
Betsy MacIsaac & Robert Goldberg,  
Yorke Construction Corporation

# Octopus's Tables

Bloomberg  
Wendy Ettinger & Derek McLane  
Fred Nelson

# Madison Square Tables

Blavatnik Family  
CBS Corporation  
The Dawkins Family Foundation  
Carolyn & Neil DeSena  
Bev Gasner  
Freddie Gershon, Music Theater International  
Alexandra Gersten-Vassilaros & Johnny Coffeeshopolis  
Rona & Randolph Nelson  
Ruth Nelson  
Steve Sabba, TaxPro Financial Network, Inc.  
Meritt Tilney & Douglas Kaden  
Wendy vanden Heuvel & Brad Coley  
Mildred & Borah Walton

## Springtime the Joyful Time

By Brandon Leon, age 12  
Composed by Greg Naughton  
Performed by Greg Naughton and Kelli O'Hara  
Back-up singers: Emma Hunton and Gabriel Violett

SPRINGTIME, A TIME OF PEOPLE  
HAVING FUN  
PLAYING IN THE PARK  
THE BIRDS ARE CHIRPING  
AND THE CLOUDS ARE SINGING  
THE SUN IS COMING  
AND THE FLOWERS ARE HUMMING

SAYS TO HIMSELF...  
SAYS TO HIMSELF...

IS SPRINGTIME THE WAY I FEEL?  
IS IT EVEN REAL?  
DOES THIS FEELING EVER LAST?  
WILL I EVER KNOW?

THE SKY IS BLUE  
THE GRASS IS GREEN  
THE TREES HAVE LEAVES  
BUT DOES IT SEEM  
SO REAL  
CAN I FEEL THIS FEELING?

SAYS TO HIMSELF...  
SAYS TO HIMSELF...

IS SPRINGTIME THE WAY I FEEL?  
IS IT EVEN REAL?  
DOES THIS FEELING EVER LAST?  
WILL I EVER KNOW?

SPRINGTIME THE JOYFUL TIME  
IT WILL LAST IT WILL LAST  
THE APPLES ARE FALLING  
FROM THE TREE  
CAN'T YOU SEE THEM  
COMING TO ME

OH SPRING OH SPRING  
IT IS THE WAY I FEEL  
IT IS REAL TO ME  
THIS FEELING DOES LAST  
AND I SEE AND BELIEVE  
IT WILL LAST

SAYS TO HIMSELF...  
SAYS TO HIMSELF...

IS SPRINGTIME THE WAY I FEEL?  
IS IT EVEN REAL?  
DOES THIS FEELING EVER LAST?  
WILL I EVER KNOW?

IT WILL LAST  
AND SPRING WILL COME AGAIN

## Immortal Powers

Lyrics by Melissa Rebolledo, age 13  
Composed and Performed by Michael Cerveris  
Back-up singers: Emma Hunton and Gabriel Violett

THE GAME IS ON, POWER IS ALL I WANT  
ONCE THE STATUS BAR IS FULL A SHOUT GOES OFF  
DEFEATING A MONSTER, GUARDIAN OF IMMORTAL POWERS

I'M HYPER, ENERGETIC, MY AURA'S NEON GREEN  
IT MIGHT BE ALL A GAME, BUT A SHOUT'S THE WAY IT CAME  
WANNA LET IT BE, GAMES ARE THE BEST THERAPY

VIRTUAL STRENGTH, GATHERING BREATHS  
THE STATUS BAR'S TWO THIRDS FULL  
A SHOUT'S BEING GAINED, LOUDER BY THE SECOND,  
WANTING TO BE FREED,  
ONLY FOR A MINUTE

IT'S HYPER, ENERGETIC, A COLOR OF NEON GREEN  
IT MIGHT BE IN A GAME, BUT A SHOUT'S THE WAY IT CAME  
IT WANTS TO BE FREE, ONLY IN A GAME IT CAN BE

A BAD DAY AT SCHOOL, ONLY BECAUSE I'M NOT COOL  
BULLIES TO OVERCOME, MONSTERS TO DEFEAT  
MONSTERS IN SCHOOL, BULLIES IN THE GAME

IT'S HYPER, ENERGETIC, A COLOR OF NEON GREEN  
IT MIGHT BE IN A GAME, BUT A SHOUT'S THE WAY IT CAME  
IT WANTS TO BE FREE, ONLY IN A GAME IT CAN BE

THE STATUS BAR'S FULL, 100 BREATHS  
GREENER THAN GRASS, STRONGER THAN A BEAR  
RIPPLES OF WIND, A MONSTER MOTIONLESS ON THE GROUND  
A SHOUT IS RELEASED  
ACROSS THE WORLD IT'S HEARD  
IN A MINUTE IT'S YELLED AND DONE

WE'RE HYPER, ENERGETIC, ONE AND THE SAME  
IT MIGHT'VE BEEN A GAME, BUT A SHOUT'S THE WAY IT CAME  
WE'VE BEEN FREED, ONLY OUR WORLD IT CAN BE.



## To The Beat of New York

Lyrics by Elizabeth Vazquez, age 12

Composed by Tom Kitt

Performed by Rebecca Naomi Jones

Back-up singers: Emma Hunton and Gabriel Violett

FLIES DON'T SMELL LIKE ANYTHING  
BUT THAT'S BECAUSE WE DON'T  
DARE TO PICK THEM UP  
AND LIFT THEM UP TO OUR NOSE  
AND SNIFF THEM

WHAT IF BY SOME ACCIDENT YOU  
SNIFF THEM UP  
LIKE A TORNADO SUCKING EVERY-  
THING

FLIES AREN'T BETTER THAN PIES  
THEY ARE LIKE LIES  
WHAT PERSON WOULD PREFER FLIES  
OVER PIES?

AHHHZZZZZZZZ IS ALL THEY SAY

BUT THEY HAVE RHYTHM  
BUT THEY HAVE RHYTHM  
THEY HAVE RHYTHM

THEIR BIG WEIRD SHAPED EYES STAR-  
ING AT YOU  
THEIR WEIRD LABELLUM  
ORANGE AND LONG SHAPED  
I JUST HATE FLIES  
RIGHT WHEN YOU WANT TO KILL 'EM  
AND DESTROY THEM

THEY FLY AWAY WITH YOUR TASTY  
FOOD  
AND YOU WANT TO SHOW THEM THAT  
THIS  
IS YOUR TERRITORY AND YOURS AND  
YOURS ONLY  
THEY DON'T BELONG IN THE  
STREETS OF NEW YORK

AHHHZZZZZZZZ IS ALL THEY SAY

BUT THEY HAVE RHYTHM  
BUT THEY HAVE RHYTHM  
THEY HAVE RHYTHM

I KNOW MOMMY HAS TAUGHT  
ME THAT SHARING IS CARING

AND IT'S NO LAUGHING MATTER  
BUT NO MATTER HOW MUCH I WANT TO  
SHARE  
I CANT CAUSEAHHHHZZZZZZZZZZ

WHEN I LOOK INTO THEIR EYES  
THEY AREN'T ALRIGHT  
YOU MAKE MY LIFE A LIVING NIGHT-  
MARE  
AND THAT'S NOT RIGHT  
THEY'RE EVERYWHERE!

BUT THEY HAVE RHYTHM  
BUT THEY HAVE RHYTHM  
THEY HAVE RHYTHM

THE NOISE, THE SOUND, THE RHYTHM  
THEIR UGLY ANTENNAS THEY BOTHER  
ME  
THEY DON'T WASH THEIR HANDS OR  
TAKE A SHOWER  
THEY AREN'T HOT PINK OR SIZZLING  
BLUE  
THEY'RE LIKE ANNOYING BROTHERS  
AND SISTERS  
THEY MIGHT HAVE DIFFERENT POINT  
OF VIEWS  
BUT THIS IS MINE

BUT MAYBE THERE'S A GOOD SIDE TO  
THEM  
THEY FILL THE STREETS WITH MUSIC  
THEY BECOME PART OF  
THE CITY THAT NEVER SLEEPS  
MAYBE I CAN LEARN TO LIKE THEM

AHHHZZZZZZZZ IS ALL THEY SAY

AND THEY HAVE RHYTHM  
AND THEY HAVE RHYTHM  
THEY RHYTHM

SCAT, DOOP, BOP, SCATTA  
DOOO, BOP, PAH, SCAT DOO, DA, DADA  
SCATTA DOO, DAH, DAH, OOOH YEA!

## Need U

Lyrics by Wendell Joseph, age 13

Composed by Jeanine Tesori

Performed by Matthew Morrison

Back-up singers: Emma Hunton and Gabriel Violett

PLEASE DON'T CRY IN SORROW  
IF YOU LEAVE, THERE'S NO TOMORROW  
I'M STUPID TO THINK THIS WILL NEVER END  
NOW I'M HEARTBROKEN IN MY BED

YOU'RE A FLOWER, NOW WATCH YOU GROW  
YOU'RE BEAUTIFUL LIKE A ROSE  
WHY CAN'T IT BE YOU AND ME IN THE HOTEL  
DREAMING

ALL I NEED IS YOU AGAIN  
TO BE IN MY LIFE  
TO SEE WHAT I'M REALLY FOR  
I PROMISE YOU'LL BE MINE AGAIN  
ALL I NEED IS YOU

I'M LOOKING OUT MY WINDOW  
I'M LOOKING FOR YOUR LOVE  
OH, IT'S NOWHERE TO BE FOUND  
I WANT IT TO FEEL LIKE SPRING AGAIN  
OH, HOW I WAS BLOOMING

ALL I NEED IS YOU AGAIN  
TO BE IN MY LIFE  
TO SEE WHAT I'M REALLY FOR  
I PROMISE YOU'LL BE MINE AGAIN  
ALL I NEED IS YOU

LOOK AT ME, JUST SAY YES  
AND I'LL MAKE IT BETTER  
THIS TIME I'LL BE A BETTER MAN  
I'M IN DARKNESS, AND NOW I CAN'T MOVE  
JUST MAKE IT SUMMER AGAIN  
SO I CAN SEE YOUR FACE

ALL I NEED IS YOU AGAIN  
TO BE IN MY LIFE  
TO GIVE ME YOUR LOVE  
I'LL BE A BETTER MAN  
ALL I NEED IS YOU  
TO BE IN MY LIFE  
JUST TAKE MY HAND  
ALL I NEED IS YOU AGAIN  
TO BE IN MY LIFE  
TO SEE WHAT I'M REALLY FOR  
I PROMISE YOU'LL BE MINE AGAIN

ALL I NEED IS YOU

Gus Rogerson, Artistic Director

Carol Ochs, Executive Director

Megan Cramer, Associate Artistic Director

The 52nd Street Project Presents

The 52nd Street Project (the Project) is dedicated to the creation and production of new plays for and by kids between the ages of ten and eighteen who reside in the Hell's Kitchen neighborhood in New York City. The Project does this through unique mentoring programs that match kids with professional (and volunteer!) theater artists.

"THE NEXT LEVEL" is a production of our Teen Ensemble Program. The Teen Ensemble is a two year acting conservatory program, which includes several public performances of original material and culminates in a full Shakespeare production. This show is the last stage of their first year.

After a year that included classes in movement, improvisation, mask performance, scene study, and singing, the teens met with these five adult playwrights, who were charged to create the plays we're presenting.

Special thanks to all of our wonderful volunteer guest artists who have worked with the Teen Ensemble this year: **Carlos Armesto, Sara Brians, Molly Cogan, Con Creal, Andrea Day, Doug Nervik, Karl Mansfield, Sarah Peteriel, & Joe White.**

The Project would also like to thank **Wendy vanden Heuvel** and **Brad Coley** for the use of their country home on Lake Lucille for the Teen Weekend trip. Also, big thanks to **Radha**, who cooked a fine lunch for our hungry ensemble.

The following foundations and government agencies have generously supported the Teen Program through their contributions:

City of New York Department of Cultural Affairs  
Horace W. Goldsmith Foundation  
National Endowment for the Arts  
New York State Council on the Arts  
The Surdna Foundation



**Five One-Act Plays**  
featuring

**The 52nd Street Project Teen Ensemble**

**Five Angels Theater**

Friday, June 4 at 7:30 p.m.

Saturday, June 5 at 3:00 p.m.



### The Project Staff

Gus Rogerson ..... Artistic Director  
 Carol Ochs.....Executive Director  
 John Sheehy..... Director of Development and Marketing  
 George Babiak..... Production Manager  
 Liz Bell..... Director of Education  
 Megan Cramer..... Associate Artistic Director  
 Diana Rojas.....Associate Program Director  
 Josh Moody..... Development Assistant  
 Ray Harold..... Technical Director  
 Chris Ceraso..... Teen Dean  
 Nicole A. Watson ..... Teen Shakespeare Director  
 Iris A. Brown ..... Graphic Designer  
 Merlaine Mendez, Malik Velazquez, George Zapata..... Receptionists  
 Viviana Vazquez, Malik Velazquez ..... Ushers  
 Jesse Bertron, Rosalee Gelpi, Lisa Kerner, Sarah Lewis.....Interns

### “The Next Level” Team

Burke Brown..... Lighting Designer  
 Kathleen Doyle ..... Costume Designer  
 Jesse Bertron ..... Sound Designer  
 Tom Schall .....Fight Choreographer  
 Sarah Lewis..... Stage Manager  
 Rosalee Gelpi.....Running crew  
 Lisa Kerner .....Running crew

### The 52nd Street Project Board of Directors

Lisa Benavides	Willie Reale, <i>founder</i>
Rachel Chanoff	Gus Rogerson
Cathy Dantchik	Shirley Rumierk, <i>alumni member</i>
Carolyn C. DeSena	José Soto, Jr., <i>alumni member</i>
Wendy Ettinger, <i>chair emeritus</i>	Jenny Steingart
Louis P. Friedman	Lisa Tilney
Stephen Graham, chair	Merritt Tilney
Larry Jones	Pamala Tyson
James McDaniel	Wendy vanden Heuvel
Frances McDormand	John A. Vassilaros
Noël Mihalow	
Carol Ochs	

### HOW EVANGELINE GOT HER PRINCE

Written by Jihan Crowther  
 Directed by Nicole A. Watson

Evangeline..... Janiece Aponte  
 Guardian..... Erica Arce  
 Woody ..... A.J. Welsh  
 Little Girl ..... Azalea Rosario  
 The Prince ..... Carlos Dumé

### NO APOLOGIES

Written by Raúl Castillo  
 Directed by David Dalton

Junior..... Muhammad Cunningham  
 Manny..... Jonathan Rosario

### MARABEL’S PRAYER

Written by Bekah Brunstetter  
 Directed by Danny Goldstein

Marabel..... Jenisse Bouret  
 George..... Josh Moody  
 Customers ..... The Company

### GOLDEN

Written by José Rivera  
 Directed by Jeremy Beck

Brooke .....Hera Andre-Bergmann  
 C.Y. .... A.J. Welsh  
 Lou.....Carlos Dumé

### IT’S LIKE...

Written by Zakiyyah Alexander  
 Directed by Rebecca White

Tatiana ..... Erica Arce  
 Kayla..... Azalea Rosario  
 Mom/Mama.....Megan Cramer  
 Pop ..... Josh Moody

*The Next Level is performed without an intermission*

The 52nd Street Project is a non-profit organization that brings children from the Hell's Kitchen neighborhood together with professional theater artists to create original theater. The Replay program gives children who are graduates of the Project's Playmaking class a chance to hone their skills in an advanced writing workshop taught by Megan Cramer. Over the nine weeks of Replay class, these young playwrights explored varied sources of inspiration, studied dramatic structure, and learned to embrace their own personal writing style. The resulting plays are featured in tonight's reading.

### Special Thanks

The plays wouldn't have made it to the page without the help of these Replay class volunteers: Chris Bachand, Tasha Gordon-Solmon, Jeremy Keaveny, Jon Kern, and Lisa Kerner. We'd especially like to thank the Cohen family and friends for their support of Replay.

### The Project Staff

Gus Rogerson ..... Artistic Director  
Carol Ochs..... Executive Director  
John Sheehy..... Director of Development and Marketing  
George Babiak..... Production Manager  
Liz Bell..... Director of Education  
Megan Cramer..... Associate Artistic Director  
Diana Rojas..... Associate Program Director  
Joshua A. Moody..... Development Assistant  
Ray Harold..... Technical Director  
Chris Ceraso..... Teen Dean  
Nicole A. Watson..... Teen Shakespeare Director  
Iris A. Brown..... Graphic Designer  
Tino Paduani..... Replay Class Assistant  
Merlaine Mendez, Chloe Moore,  
C.J. Muentes, Viviana Vazquez, Malik Velazquez..... Teen Employees  
Interns..... Jesse Bertron, Rosalee Gelpi, Sarah Lewis

### The 52nd Street Project Board of Directors

Lisa Benavides  
Rachel Chanoff  
Cathy Dantchik  
Carolyn C. DeSena  
Wendy Ettinger, *chair emeritus*  
Louis P. Friedman  
Stephen Graham, *chair*  
James McDaniel  
Frances McDormand  
Noël Mihalow  
Carol Ochs  
Willie Reale, *founder*

Gus Rogerson  
Shirley Rumierk,  
*alumni member*  
José Soto, Jr.,  
*alumni member*  
Jenny Steingart  
Lisa Tilney  
Merritt Tilney  
Pamala Tyson  
Wendy vanden Heuvel  
John A. Vassilaros

The 52nd Street Project Presents  
The 2010 Lorraine Cohen

# Replay Readings

11 new plays by  
11 young playwrights

Monday, June 14, 2010  
7:30 p.m.

The Five Angels Theater  
The 52nd Street Project  
789 10th Avenue

## Reduce, Reuse, Recycle

by Britney Trinidad, age 11. Directed by Evan Cabnet

Hazil..... Alexis McGuinness  
Erica ..... Marin Ireland

*Best Friends Forever* lyrics by Britney Trinidad

## The American Dream

by Lucas Ruedel, age 12. Directed by Jonathan Bernstein

Raymond ..... Neal Bledsoe  
Quintin ..... Kevin Geer

## Santiago!

by Nathaly Trinidad, age 12. Directed by Jessica Bauman

Daniela ..... Marsha Stephanie Blake  
Vanessa ..... Patrice Johnson  
Carry ..... Tasha Gordon-Solmon  
Katherin ..... Rosalee Gelpi

## The Embarrassing Moment

by Leah Kiara Macuilt, age 10. Directed by Nicole A. Watson

Ashley ..... Martha Plimpton  
Joe ..... Ezra Knight  
Dad ..... Chris Bachand  
Kids ..... Rosalee Gelpi, Jon Kern

## Catty Pressure, Olympics!

by Cassidy Capstick, age 10. Directed by Evan Cabnet

Alice ..... Marin Ireland  
Kobi ..... Alexis McGuinness

## Bad Teacher Goes Good

by Miguelangel Vazquez, age 11. Directed by Felix Solis

Mr. Striker ..... James McDaniel  
John ..... James Yaegashi  
Kids ..... Krystal Lucas, Rosalee Gelpi, Jon Kern

## Shermock Twig's Case

by Edison Rafael Sibri, age 12. Directed by Jonathan Bernstein

Shermock Twig ..... Neal Bledsoe  
Dr. Patson ..... Kevin Geer  
Patson's Mom/Ms. Beak ..... Krystal Lucas  
Bird/Tatson ..... John Sheehy

## Sisters

by Venecia Escamilla, age 11. Directed by Evan Cabnet

Isabella ..... Marin Ireland  
Jamie ..... Alexis McGuinness  
Kids ..... Rosalee Gelpi, Tasha Gordon-Solmon

## The Awesome Week

by Joseph Vasquez, age 12. Directed by Felix Solis

Ozzy ..... James McDaniel  
Joe ..... James Yaegashi  
Lady/Joyce ..... Krystal Lucas

## Natashia, Nia and the Community

by Naomi R. Welch, age 11. Directed by Jessica Bauman

Nia ..... Marsha Stephanie Blake  
Natashia ..... Patrice Johnson  
Kids ..... Rosalee Gelpi, Tasha Gordon-Solmon

## The School Prez in Babyville

by Asia Hoa Rosado, age 11. Directed by Nicole A. Watson

Jacob ..... Ezra Knight  
Carlo ..... Martha Plimpton  
Bubby ..... Chris Bachand  
Mrs. Babeekins ..... Krystal Lucas  
Background people ..... Rosalee Gelpi, Jon Kern

*When I Become King* lyrics by Asia Hoa Rosado

**B  
R  
I  
E  
F  
  
I  
N  
T  
E  
R  
M  
I  
S  
I  
O  
N**





The 52nd Street Project Presents:  
**Teen Cabaret**  
Thursday, June 17th, 2010  
Five Angels Theater



**Musical Director and Pianist: Karl Mansfield**

**Azalea Rosario**

*"A Blessing"* by James Wright

**Jenisse Bouret**

*"Happily Ever After"*

Music by Mary Rodgers,

Lyrics by Marshall Barer

**Jonathan Rosario**

*"At a Window"* by Carl Sandburg

**Jorge Zapata**

*"Mr. Cellophane"*

Music by John Kander, Lyrics by Fred Ebb

**Erica Arce**

*"Wild Geese"* by Mary Oliver

**Janiece Aponte**

*"Feelin' Good"*

Music & Lyrics by Leslie Bricusse  
and Anthony Newley

**Carlos Dume**

*"Miracles"* by Walt Whitman

**A.J. Welsh**

*"You Can't Take That Away From Me"*

Music by George Gershwin,

Lyrics by Ira Gershwin

**Jenisse Bouret**

*"Fatal Interview: XI"* by Edna St. Vincent Millay

**Hera Andre-Bergmann**

*"Fine, Fine Line"*

Music and Lyrics by Robert Lopez & Jeff Marx

**Jorge Zapata**

*"The Triple Foole"* by John Donne

**Muhammad Cunningham**

*"On the Street Where You Live"*

Music by Frederick Loewe,

Lyrics by Alan Jay Lerner

**Janiece Aponte**

*"Life is Fine"* by Langston Hughes

**Azalea Rosario**

*"Hopelessly Devoted to You"*

Music & Lyrics by Jim Jacobs & Warren Casey

**Muhammad Cunningham**

*"Ode to the Midwest"* by Kevin Young

**Carlos Dumé**

*"My Funny Valentine"*

Music by Richard Rodgers,

Lyrics by Lorenz Hart

**Hera Andre-Bergmann**

*"The Waking"* by Theodore Roethke

**Erica Arce**

*"Taylor, the Latte Boy"*

Music by Zina Goldrich,

Lyrics by Marcy Heisler

**A.J. Welsh**

*"Bright Star"* by John Keats

**Jonathan Rosario**

*"Push Ka Pi Shi Pie"*

Music and Lyrics by Louis Jordan

The 52nd Street Project gratefully acknowledges the support of the following foundations and corporations: AOL Time Warner, Inc.; Aberdeen Investments; The Altman Foundation; AON; BGC; The Big Wood Foundation; BSKS Architects; Bloomberg; Carnegie Corporation of New York; CBS Corporation; Consolidated Edison; The Neil V. DeSena Foundation; Dramatists Play Service; The Educational Foundation Of America; Eleanor, Adam & Mel Dubin Foundation; EIF; Goldman, Sachs & Co.; The Horace W. Goldsmith Foundation; Grant's Financial Publishing, Inc.; Heisman Foundation; The Henlopen Foundation; Hudson Scenic Studio; The Suzanne Nora Johnson & David G. Johnson Foundation; The Kresge Foundation; Lemle Pictures, Inc.; The Lotos Foundation; Marusi Family Foundation; Ann M. Martin Foundation; The Monteforte Foundation; J.P. Morgan Charitable Trust; MTI; National Philanthropic Trust; Newman's Own; NYFA; NYS Energy Research and Development Authority; Par Plumbing Co., Inc.; Pinerock Productions, Inc.; Punchline Magazine; Jonathan Rose Companies; St. Vincent De Paul Foundation; Shapiro & Lobel; The Shubert Organization; Siemens Building Technologies Inc.; Simon & Eisenberg; Harold & Mimi Steinberg Charitable Trust; Stranahan Foundation; The Surdna Foundation; Susquehanna Foundation, Corp.; Tax Pro Financial Network, Inc.; Tiger Baron Foundation; United Real Estate Ventures, Inc.; Van Deusen Family Fund; Watkins, Inc.; Wiener Family Foundation; I. Weiss & Sons, Inc.; Yorke Construction Corp. In addition, the following individuals made gifts over \$250 to The 52nd Street Project this past year. (list current as of 7/23/10):

Robert Abrams	Wendy Ettinger	Warren Leight	Jeffrey Rogers
& Cynthia Vance	& Derek McLane	Melissa Liebling-Goldberg	Anita Rogerson
Michael Alicastro	Nigel Faulkner	& John Barrett	David Ross & Laura Ross
Jonathan Soros	& Amanda Faulkner	Adrienne Lobel	Carla Sacks & John Morris
& Jennifer Soros	Adam Felber & Jeanne	& Mark Linn Baker	Karin & Tom Schall
Elton Andrews	Simpson	Paul Logan	Pam Shaw & Victor Szymis
Emily Armstrong	Peter Jay Fernandez	John Lyons	Todd Silverberg
Jeff Arsenault	& Denise Burse	Greg MacPherson & Jane	Meg Simon
Dylan & Becky Baker	Angelina Fiordellisi	Perlmutter	Brian Sklar
Dominick & Ilene Balletta	& Matt Williams	Fabio Mariani	David Sleeman
Jessica Bauman & Ben Posel	Randy Frankel	Paul McCrane & Dana Kellin	Christopher Solomon
Lisa Benavides & Tim Nelson	Alison Fraser & Nat Magee	Frances McDormand	John Stefanelli
Gavin Berger & Craig Berggren	Louis & Patrice Friedman	& Joel Coen	Jenny & Jon Steingart
Brett Berk	Gary Garelick	Noël & Joe Mihalow	Tracy Straus
Eric Berman	Beverly Gasner	Eric Mindich & Stacey Mindich	Jeffrey Strauss
& Elizabeth Berman	Alexandra Gersten	Emily & John Morgan	Richard Sweren
Lewis Black	& John Vassilaros	John David Moriarty	Timothy Thomas
Richard Blackstone	Scott Aaron Gewirtz	Dexter Morse	Lisa Tilney
& Yildez Yuksek	& Laura Gewirtz	Suzen Murakoshi	Margaret & Rusty Tilney
Allison & Robert Blinken	Nancy Giles	& Mark Temme	Merritt Tilney & Douglas Kaden
Michelle Bork	Tony Goldwyn & Jane Musky	Rishi Nangalia	Martin Timmins
& Jonathan Levine	Stephen & Cathy Graham	Fred Nelson	Terrance Travis & Kathy Travis
Liz Brixius	Emily Grishman	Randy & Rona Nelson	Liz Tuccillo
Becky Browder & Ted Neustadt	& Susan Sampliner	Ruth Nelson	Christopher Tufano
Shawn Byron & Laura Byron	Jonathan Groff	Duncan Niederauer	Gregory Tusar
Lawrence Catena	Jan Gura & Alan Pickman	Cynthia Nixon	Laura Valeroso
Rachel Chanoff	David & Ann Hausmann	Rachel & Larry Norton	& David Seidman
Nora Charles	Peter Herdrich & Karen Trott	Jodi Nussbaum	Wendy vanden Heuvel
Kirk & Katherine Holt Citron	Susan Hess Lucier	James & Olivia O'Connor	& Brad Coley
David Cohen	Eric & Barbara Hippeau	Kevin O'Rourke	Ed Vassallo
& Sandra Novak Cohen	William Holtzman	& Edith Thurber	Brian Villante
Ruth Cohen & Bob Usdin	& S. Sylvia Shepard	Carol Ochs & Bruce MacVittie	Richard Wagner
Melissa Cohn	Katy Homans	F. Richard Pappas	Kevin Waldron
William Conley	& Patterson Sims	Elizabeth Peters	Mary Pat Walsh
& Doreen Conley	Sarah Horowitz	Bat-Sheva & Thomas Peters	Borah & Mildred Walton
Jeffrey & Anna Cramer	& David Venarde	Susan Ochs Phillips	Lynn & Sam Waterston
Billy Crudup	Warner Howe	Judy Goldman	Jane Bolster & Steve Wertimer
Kyle Czepiel	Andrea Johnson	& Michael Pillinger	Thomas Whatley
Arthur Dantchik	Bob Joy	David Pollard	Elizabeth Williams
Cathy Dantchik	Cindy Kaplan & David Froelich	Peter & Helen Randolph	& Joseph Forte
Leslie Dantchik	Kevin Kelly	Willie Reale & Jenny Gersten	John William & Suzanne William
Peter & Judith Dawkins	Patrick Kelly & Diane Kelly	Dan Reed	J.P. Xenakis
Richard & Rebecca Dresser	John Kyles & Sefanie Kyles	Jacquelyn Reingold	Carole Yass & Randy Ginsburg
Brian Duggan & Carol Duggan	Michael P. Lawrence	Ira Resnick	Daniel Zarkowsky
Greg Durkin	Lisa Leguillou	Danon Robinson	
& Vanessa Beecroft			

The 52nd Street Project Presents

# NOW WE'RE COOKIN'!

ALL THE PLAYS YOU CAN EAT!



THE 2010 HAROLD AND MIMI STEINBERG CHARITABLE TRUST ONE-ON-ONES

THE 52ND STREET PROJECT'S  
**FIVE ANGELS THEATER**  
 789 10TH AVE, BETWEEN 52ND AND 53RD ST.

FRIDAY, JULY 23 @ 7:30 P.M.

SATURDAY, JULY 24 @ 7:30 P.M.

SUNDAY, JULY 25 @ 3:00 P.M.

# Now We're Cookin'! All The Plays You Can Eat

The Annual Block Island One-on-Ones - July, 2010 at the Five Angels Theater

## The 52nd Street Project Staff

Gus Rogerson, Artistic Director  
 Carol Ochs, Executive Director  
 John Sheehy, Director of Development and Marketing  
 George Babiak, Production Manager  
 Megan Cramer, Associate Artistic Director  
 Liz Bell, Director of Education  
 Diana Rojas, Associate Program Director  
 Josh Moody, Development Assistant  
 Ray Harold, Technical Director  
 Chris Ceraso, Teen Dean  
 Nicole A. Watson, Teen Shakespeare Director  
 Iris A. Brown, Graphic Designer  
 Jesse Bertron, Rosalee Gelpi, Sarah Lewis, Interns  
 Teen Employees: Carlos Dumé, Merlaine Mendez, Chloe Moore,  
 C.J. Muentes, Azalea Rosario, Jonathan Rosario, Luisa Santiago,  
 Malik Velazquez, Jorge Zapata

## "Now We're Cookin'!" Production Staff

### Composer/Music Director

Kim D. Sherman

### Set Designer

Kevin Joseph Roach

### Lighting Designer

Greg MacPherson

### Costume Designer

Katherine Brown

### Assistant Costume Designer

Suzanna Grobman

### Goddess of Sound

Vanessa Valdes

### Stage Manager

Liz Bell

### Slide Designs

George Babiak and the  
 Project Slide Archive

### Prop Design Team

George Babiak, Liz Bell,  
 Jesse Bertron, Megan Cramer,  
 Deborah Gaffaney, Rosalee Gelpi,  
 Sarah Lewis, Josh Moody,  
 India Quinby, Lee Rosen,  
 Julie Sharbutt, Sean Smith

### Backstage Crew

Jesse Bertron, Samantha Caldoni,  
 Rosalee Gelpi, Sarah Lewis

### House Managers

Karin Schall, Mary Pat Walsh

### Flyer/Program Art:

Patrick Jones

### Chefs

Martha Velie-Gass,  
 Pat Ritter



The One-on-One Program is made possible with public funds from The New York State Council on the Arts, a state agency; and the New York City Department of Cultural Affairs. The 52nd Street Project is a member of Art/NY and a participant in the New Generations Program, funded by Doris Duke Charitable Foundation/The Andrew W. Mellon Foundation and administered by Theatre Communications Group, the national organization for the American Theater.

## COOL STUFF ON SALE IN THE LOBBY!

FABULOUS FLYER BARS ..... \$2.50, \$2, \$1.50

AND FEATURING SHEL SILVERSTEIN'S  
 "FIVEY AND TWOEY" LOGO:

PROJECT T-SHIRTS AND TANKS..... \$12.00  
 PROJECT CAPS..... \$20.00  
 PROJECT MUGS ..... \$5.00  
 PROJECT PENCIL 3-PACK ..... \$1.00  
 PROJECT NOTEBOOK..... \$5.00

Thank you for coming to NOW WE'RE COOKIN'! If you are not on our mailing list (or if your address has changed), please fill out this form and give it to us on your way out or mail it to the address below. We would also like to know if you are interested in becoming a volunteer. We need help in all areas, so be sure to fill out the entire form.

PLEASE ADD ME TO YOUR MAILING LIST:

07/10

NAME \_\_\_\_\_

ADDRESS \_\_\_\_\_

CITY \_\_\_\_\_

STATE \_\_\_\_\_

ZIP \_\_\_\_\_

HOME PHONE \_\_\_\_\_

DAYTIME OR MOBILE PHONE \_\_\_\_\_

E-MAIL ADDRESS \_\_\_\_\_

MY OCCUPATION \_\_\_\_\_

MY HOBBIES \_\_\_\_\_

YES, I WOULD LIKE TO BE OF HELP. I CAN:

- |   |   |  |
|---|---|--|
| <input type="checkbox"/> Help load in and out for shows | <input type="checkbox"/> Draw and/or paint  | <input type="checkbox"/> Help kids with homework |
| <input type="checkbox"/> Hang lights                    | <input type="checkbox"/> Help with mailings | <input type="checkbox"/> Teach kids a skill      |
| <input type="checkbox"/> Work on a backstage crew       | <input type="checkbox"/> Do office work     | <input type="checkbox"/> Be a chef at an event   |
| <input type="checkbox"/> Do graphic design              | <input type="checkbox"/> Design sound       | <input type="checkbox"/> Design and sew costumes |
| <input type="checkbox"/> Other (please specify) _____   |   |  |

MY SCHEDULE IS:

- Very flexible. I'm often available during weekdays.  
 Somewhat flexible. I can help on the occasional morning or afternoon during the week.  
 Not very flexible at all, but I've got some free time on evenings and weekends.

If you would like to mail this (and you're always welcome to enclose a tax-deductible contribution), you can send it to: The 52nd Street Project, 500 West 52nd St., #2E, New York, NY 10019. Or fax it to (212) 333-5598.



COME BACK NEXT MONTH FOR...

THE 52ND STREET PROJECT PRESENTS

# NOW WE'RE REALLY COOKIN'!

ALL THE PLAYS YOU CAN EAT!



CUS ROGERSON, ARTISTIC DIRECTOR

CAROL OCHS, EXECUTIVE DIRECTOR

THE 2010 WIENER FAMILY FOUNDATION ONE-ON-ONES

THE 52ND STREET PROJECT'S  
**FIVE ANGELS THEATER**

789 10TH AVE, BETWEEN 52ND AND 53RD ST.

FRIDAY, AUG. 20 @ 7:30 P.M.  
SATURDAY, AUG. 21 @ 7:30 P.M.  
SUNDAY, AUG. 22 @ 3:00 P.M.

ADMISSION IS FREE, BUT  
RESERVATIONS ARE STRONGLY  
RECOMMENDED!  
CALL (212) 642-5052 TO RESERVE.



## BE ON THE LOOKOUT!

WE ARE ALWAYS SEARCHING FOR INTERNS.

If you know of any college or graduate students who might enjoy working with us, playing with us, and going on trips with us for a semester, please have them contact George Babiak or Megan Cramer. We are especially looking for interns for the Spring of 2011. Thanks!

## The 52nd Street Project Board of Directors

Lisa Benavides	Willie Reale, founder
Rachel Chanoff	Gus Rogerson
Cathy Dantchik	Shirley Rumierk, alumni member
Carolyn DeSena	José Soto, Jr., alumni member
Wendy Ettinger, chair emeritus	Jenny Steingart
Louis P. Friedman	Lisa Tilney
Stephen Graham, chair	Merritt Tilney
James McDaniel	Pamala Tyson
Frances McDormand	Wendy vanden Heuvel
Noël Mihalow	John A. Vassilaros
Carol Ochs	

### What's Going On Here?

The 52nd Street Project is a non-profit organization that brings children from the Hell's Kitchen neighborhood together with professional theater artists to create original theater. NOW WE'RE COOKIN'! is a production of our One-on-One program, which is designed to give children the opportunity to go away for one-week stays in the country and enjoy the undivided attention of a professional theater artist who serves as friend, mentor, and collaborator.

### In-Kind Contributions

The Murphy Law Office; Abbeville Press; Stephanie Berger Photography; Lewis Black; Iris A. Brown Design; City Winery; A Curran Affair; Kate Cusack; Disney Hyperion; Fox Television; Seventeen Magazine; Steve Olsen and the Westbank Cafe; Jon Paris; Yorke Construction; The S.F. Giants; Newman's Own; Macy's; PineRock; Pharma/Omni Printing; Shapiro Lobel, LLP; Rob White; Sesame Workshop; The NY Yankees; John A. Vassilaros & Sons; Watkins Incorporated; Mayor's Office of Film & Television; Boylan's Bottling Co.; Hudson Scenic; and Paul, Weiss, Rifkind, Wharton & Garrison LLP.

### Special Thanks

Our Host Families – Sue Black; Susan Bush; Socha Cohen; Mimi Leveille; Leslie Parsons; Ron & Judy Tierney; Joya Verde & Virginia Dare; and our headquarters host Dr. Christina Biaggi. Sincere thanks to our chefs Pat Ritter & Martha Velie-Gass; Kate Butcher & everyone at Block Island Realty; Block Island Maritime Institute; Block Island Airport; McQuade's Marketplace; Robbie Brown; Rita & Steve Draper; Amelia Gallant at the Block Island Grocery; Cindy & Stan Geer at the Depot; Glenn & Annie Hall; Interstate Navigation; Josie Merck & Jim Stevenson; Greg MacPherson and Doug Nervik; and Sophia MacVittie.

## Now We're Cookin'! - ACT 1

All original music composed by Kim D. Sherman

### **MORGUE THAN YOU KNOW**

Written and directed by John Sheehy for Brandon Draude, age 10

Dr. Ian McMurphy ..... Brandon Draude  
Dr. Anton Lestrangle ..... John Sheehy  
Corpse ..... Jesse Bertron

*Have A Heart* lyrics by John Sheehy.

### **HOT**

Written by Mike Lew and directed by Joanna Parson  
for Edison Rafael Sibri, age 13

Ruben ..... Edison Rafael Sibri  
Bianca ..... Joanna Parson

*The Omelet Song* lyrics by Mike Lew.

### **THE F.R.B.**

Written by Cynthia Kaplan and directed by Ephraim López  
for Tatiana Goode, age 10

Cheryl ..... Tatiana Goode  
Chuck ..... Ephraim Lopez  
The Guanábana ..... Jesse Bertron  
Chairperson Banana ..... Azalea Rosario

*Use Me As A Marmalade* (Part One) and *Use Me As A Marmalade* (Part Two) lyrics by Cynthia Kaplan.

### **STEAK TARTARE**

Written by Graeme Gillis and directed by Brian Hastert for Carlos Breton, age 12

Johnny Lucky ..... Carlos Breton  
Darrell ..... Brian Hastert  
Customers ..... George Babiak, Jesse Bertron, & Azalea Rosario

*It's Good To Have A Job You're Good At* lyrics by Graeme Gillis.

### **DAZZLING STARS**

Written by Sascha Paladino and directed by Gretchen Hall  
for Delia Cadman, age 10

Bettina Ocarina Salong ..... Delia Cadman  
Natalie Marsh ..... Gretchen Hall  
Ground Control ..... Jesse Bertron  
Alien Duo ..... Jesse Bertron and Azalea Rosario  
Music of the Spheres ..... Carlo Alban, Megan Cramer,  
Emily Dorsch, and Joanna Parson

*My Thing Is To Sing* and *We Are Stars* lyrics by Sascha Paladino.

## Now We're Cookin'! - ACT 2

### **THE SWITCHIE THINGIE 3000**

Written and directed by Dylan Dawson for Kamil Kuzminski, age 11

Delivery Guy ..... Kamil Kuzminski  
Rogue Agent ..... Dylan Dawson  
Receptionist (Fay) ..... Azalea Rosario

*Worse Than Broccoli* lyrics by Dylan Dawson.

### **READY**

Written by Tasha Gordon-Solmon and directed by Brielle Silvestri  
for Leah Kiara Macuilt, age 11

Clara ..... Leah Kiara Macuilt  
Juliette ..... Brielle Silvestri  
Stage Manager ..... Azalea Rosario  
Presenters ..... George Babiak & John Sheehy

*I'm Not Ready* lyrics by Tasha Gordon-Solmon.

### **WHEN YOU'RE FALLING**

Written and directed by Carlo Alban for Richard Brea, age 10

Alpha ..... Richard Brea  
Beta ..... Carlo Alban  
Turkeys ..... George Babiak, Jesse Bertron, & Azalea Rosario

*Now's The Time* lyrics by Carlo Alban.

### **LEONA BY THE BAYOU**

Written by Vickie Ramirez and directed by Emily Dorsch  
for Venecia Escamilla, age 11

Bayou La Batre ..... Venecia Escamilla  
Leona Coronada ..... Emily Dorsch  
Passers-by ..... Jesse Bertron & Azalea Rosario

*One New Thing* lyrics by Vickie Ramirez.

### **SAMMY AND THE SIREN**

Written and directed by Megan Cramer for Chanel Rodney, age 12

Sammy ..... Chanel Rodney  
Sirena ..... Megan Cramer

*I Might Die Out Here Tonight* and *Saved* lyrics by Megan Cramer.

*Now We're Cookin'! Theme Song* lyrics by John Sheehy

The 52nd Street Project gratefully acknowledges the support of the following foundations and corporations: AOL Time Warner, Inc.; Aberdeen Investments; The Altman Foundation; AON; BGC; The Big Wood Foundation; BSK Architects; Bloomberg; Carnegie Corporation of New York; CBS Corporation; Consolidated Edison; The Neil V. DeSena Foundation; Dramatists Play Service; The Educational Foundation Of America; Eleanor, Adam & Mel Dubin Foundation; EIF; Goldman, Sachs & Co.; The Horace W. Goldsmith Foundation; Grant's Financial Publishing, Inc.; Heisman Foundation; The Henlopen Foundation; Hudson Scenic Studio; The Suzanne Nora Johnson & David G. Johnson Foundation; The Kresge Foundation; Lemle Pictures, Inc.; The Lotos Foundation; Marusi Family Foundation; Ann M. Martin Foundation; The Monteforte Foundation; J.P. Morgan Charitable Trust; MTI; National Philanthropic Trust; Newman's Own; NYFA; NYS Energy Research and Development Authority; Par Plumbing Co., Inc.; Pinerock Productions, Inc.; Punchline Magazine; Jonathan Rose Companies; St. Vincent De Paul Foundation; Shapiro & Lobel; The Shubert Organization; Siemens Building Technologies Inc.; Simon & Eisenberg; Harold & Mimi Steinberg Charitable Trust; Stranahan Foundation; The Surdna Foundation; Susquehanna Foundation, Corp.; Tax Pro Financial Network, Inc.; Tiger Baron Foundation; United Real Estate Ventures, Inc.; Van Deusen Family Fund; Watkins, Inc.; Wiener Family Foundation; I. Weiss & Sons, Inc.; Yorke Construction Corp. In addition, the following individuals made gifts over \$250 to The 52nd Street Project this past year. (list current as of 7/23/10):

Robert Abrams	Wendy Ettinger	Warren Leight	Jeffrey Rogers
& Cynthia Vance	& Derek McLane	Melissa Liebling-Goldberg	Anita Rogerson
Michael Alicastro	Nigel Faulkner	& John Barrett	David Ross & Laura Ross
Jonathan Soros	& Amanda Faulkner	Adrienne Lobel	Carla Sacks & John Morris
& Jennifer Soros	Adam Felber & Jeanne	& Mark Linn Baker	Karin & Tom Schall
Elton Andrews	Simpson	Paul Logan	Pam Shaw & Victor Szymis
Emily Armstrong	Peter Jay Fernandez	John Lyons	Todd Silverberg
Jeff Arsenault	& Denise Burse	Greg MacPherson & Jane	Meg Simon
Dylan & Becky Baker	Angelina Fiordellisi	Perlmutter	Brian Sklar
Dominick & Ilene Balletta	& Matt Williams	Fabio Mariani	David Sleeman
Jessica Bauman & Ben Posel	Randy Frankel	Paul McCrane & Dana Kellin	Christopher Solomon
Lisa Benavides & Tim Nelson	Alison Fraser & Nat Magee	Frances McDormand	John Stefanelli
Gavin Berger & Craig Berggren	Louis & Patrice Friedman	& Joel Coen	Jenny & Jon Steingart
Brett Berk	Gary Garelick	Noël & Joe Mihalow	Tracy Straus
Eric Berman	Beverly Gasner	Eric Mindich & Stacey Mindich	Jeffrey Strauss
& Elizabeth Berman	Alexandra Gersten	Emily & John Morgan	Richard Sweren
Lewis Black	& John Vassilaros	John David Moriarty	Timothy Thomas
Richard Blackstone	Scott Aaron Gewirtz	Dexter Morse	Lisa Tilney
& Yldeez Yuksek	& Laura Gewirtz	Suzen Murakoshi	Margaret & Rusty Tilney
Allison & Robert Blinken	Nancy Giles	& Mark Temme	Merritt Tilney & Douglas Kaden
Michelle Bork	Tony Goldwyn & Jane Musky	Rishi Nangalia	Martin Timmins
& Jonathan Levine	Stephen & Cathy Graham	Fred Nelson	Terrance Travis & Kathy Travis
Liz Brixius	Emily Grishman	Randy & Rona Nelson	Liz Tuccillo
Becky Browder & Ted Neustadt	& Susan Sampliner	Ruth Nelson	Christopher Tufano
Shawn Byron & Laura Byron	Jonathan Groff	Duncan Niederauer	Gregory Tusar
Lawrence Catena	Jan Gura & Alan Pickman	Cynthia Nixon	Laura Valeroso
Rachel Chanoff	David & Ann Hausmann	Rachel & Larry Norton	& David Seidman
Nora Charles	Peter Herdrich & Karen Trott	Jodi Nussbaum	Wendy vanden Heuvel
Kirk & Katherine Holt Citron	Susan Hess Lucier	James & Olivia O'Connor	& Brad Coley
David Cohen	Eric & Barbara Hippeau	Kevin O'Rourke	Ed Vassallo
& Sandra Novak Cohen	William Holtzman	& Edith Thurber	Brian Villante
Ruth Cohen & Bob Usdin	& S. Sylvia Shepard	Carol Ochs & Bruce MacVittie	Richard Wagner
Melissa Cohn	Katy Homans	F. Richard Pappas	Kevin Waldron
William Conley	& Patterson Sims	Elizabeth Peters	Mary Pat Walsh
& Doreen Conley	Sarah Horowitz	Bat-Sheva & Thomas Peters	Borah & Mildred Walton
Jeffrey & Anna Cramer	& David Venarde	Susan Ochs Phillips	Lynn & Sam Waterston
Billy Crudup	Warner Howe	Judy Goldman	Jane Bolster & Steve Wertimer
Kyle Czepiel	Andrea Johnson	& Michael Pillinger	Thomas Whatley
Arthur Dantchik	Bob Joy	David Pollard	Elizabeth Williams
Cathy Dantchik	Cindy Kaplan & David Froelich	Peter & Helen Randolph	& Joseph Forte
Leslie Dantchik	Kevin Kelly	Willie Reale & Jenny Gersten	John William & Suzanne William
Peter & Judith Dawkins	Patrick Kelly & Diane Kelly	Dan Reed	J.P. Xenakis
Richard & Rebecca Dresser	John Kyles & Sefanie Kyles	Jacquelyn Reingold	Carole Yass & Randy Ginsburg
Brian Duggan & Carol Duggan	Michael P. Lawrence	Ira Resnick	Daniel Zarkowsky
Greg Durkin	Lisa Leguillou	Danon Robinson	
& Vanessa Beecroft			

The 52nd Street Project Presents

# NOW WE'RE REALLY COOKIN'!

ALL THE PLAYS YOU CAN EAT!



THE 2010 WIENER FAMILY FOUNDATION ONE-ON-ONES

THE 52ND STREET PROJECT'S  
**FIVE ANGELS THEATER**  
789 10TH AVE, BETWEEN 52ND AND 53RD ST.

Friday, August 20 @ 7:30 p.m.

Saturday, August 21 @ 7:30 p.m.

Sunday, August 22 @ 3:00 p.m.

## Now We're REALLY Cookin'! All The Plays You Can Eat

The Annual Wareham One-on-Ones - August, 2010 at the Five Angels Theater

### The 52nd Street Project Staff

Gus Rogerson, Artistic Director  
Carol Ochs, Executive Director  
John Sheehy, Director of Development and Marketing  
George Babiak, Production Manager  
Megan Cramer, Associate Artistic Director  
Liz Bell, Director of Education  
Diana Rojas, Associate Program Director  
Josh Moody, Development Assistant  
Ray Harold, Technical Director  
Chris Ceraso, Teen Dean  
Nicole A. Watson, Teen Shakespeare Director  
Iris A. Brown, Graphic Designer  
Jesse Bertron, Rosalee Gelpi, Sarah Lewis, Interns  
Teen Employees: Jenisse Bouret, Carlos Dumé, Kyle Fargardo, Merlaine Mendez, Chloe Moore, C.J. Muentes, Tino Paduani, Azalea Rosario, Jonathan Rosario, Luisa Santiago, Viviana Vazquez, Malik Velazquez, Jorge Zapata

### "Now We're REALLY Cookin'!" Production Staff

#### Composer/Music Director

Patrick Barnes

#### Set Designer

Kevin Joseph Roach

#### Lighting Designer

Greg MacPherson

#### Costume Designer

Ciera Wells

#### Assistant Costume Designer

Suzanna Grobman

#### Sound Designer

Jeanne Wu

#### Stage Manager

Karen Munkel

#### Slide Designs

George Babiak and the  
Project Slide Archive

#### Prop Design Team

George Babiak, Liz Bell,  
Jesse Bertron, Megan Cramer,  
Rosalee Gelpi, Sarah Lewis,  
Josh Moody, Karen Munkel,  
Lee Rosen, John Sheehy

#### Backstage Crew

Doris Alcantara, Jesse Bertron,  
Rosalee Gelpi, Sarah Lewis,  
Merlaine Mendez, Jonathan Rosario

#### House Managers

Karin Schall, Mary Pat Walsh

#### Flyer/Program Art:

Patrick Jones

#### Chefs

John Sheehy, Liz Bell, Carol Ochs



The One-on-One Program is made possible with public funds from The New York State Council on the Arts, a state agency; and the New York City Department of Cultural Affairs. The 52nd Street Project is a member of Art/NY and a participant in the New Generations Program, funded by Doris Duke Charitable Foundation/The Andrew W. Mellon Foundation and administered by Theatre Communications Group, the national organization for the American Theater.

## COOL STUFF ON SALE IN THE LOBBY!

FABULOUS FLYER BARS ..... \$2.50, \$2, \$1.50

AND FEATURING SHEL SILVERSTEIN'S  
"FIVEY AND TWEY" LOGO:

PROJECT T-SHIRTS AND TANKS..... \$12.00  
PROJECT CAPS..... \$20.00  
PROJECT MUGS ..... \$5.00  
PROJECT PENCIL 3-PACK ..... \$1.00  
PROJECT NOTEBOOK..... \$5.00

Thank you for coming to NOW WE'RE REALLY COOKIN'! If you are not on our mailing list (or if your address has changed), please fill out this form and give it to us on your way out or mail it to the address below. We would also like to know if you are interested in becoming a volunteer. We need help in all areas, so be sure to fill out the entire form.

PLEASE ADD ME TO YOUR MAILING LIST:

08/10

NAME

ADDRESS

CITY

STATE

ZIP

HOME PHONE

DAYTIME OR MOBILE PHONE

E-MAIL ADDRESS

MY OCCUPATION

MY HOBBIES

YES, I WOULD LIKE TO BE OF HELP. I CAN:

- Draw and/or color props       Teach kids a skill       Help kids with homework  
 Hang lights       Help with mailings       Design and sew costumes  
 Work on a backstage crew       Be a chef at an event  
 Do graphic design       Design sound  
 Other (please specify) \_\_\_\_\_

MY SCHEDULE IS:

- Very flexible. I'm often available during weekdays.  
 Somewhat flexible. I can help on the occasional morning or afternoon during the week.  
 Not very flexible at all, but I've got some free time on evenings and weekends.

If you would like to mail this (and you're always welcome to enclose a tax-deductible contribution), you can send it to: The 52nd Street Project, 789 10th Avenue, New York, NY 10019. Or fax it to (212) 333-5598.

COMING SOON TO THE PROJECT...

**PSSST!**

**THE  
SECRET  
PLAYS**

**THE  
FALL, 2010  
PLAYBACK  
PLAYS**

8 kids write plays for themselves to perform with their adult partners.

October 22-24 right here at The Five Angels Theater



**BE ON  
THE LOOKOUT!**

**WE ARE ALWAYS  
SEARCHING FOR INTERNS.**

If you know of any college or graduate students who might enjoy working with us, playing with us, and going on trips with us for a semester, please have them contact George Babiak or Megan Cramer. We are especially looking for interns for the Spring of 2011. Thanks!

**The 52nd Street Project Board of Directors**

Lisa Benavides	Willie Reale, founder
Rachel Chanoff	Gus Rogerson
Cathy Dantchik	Shirley Rumierk, alumni member
Carolyn DeSena	José Soto, Jr., alumni member
Wendy Ettinger, chair emeritus	Jenny Steingart
Louis P. Friedman	Lisa Tilney
Stephen Graham, chair	Merritt Tilney
James McDaniel	Pamala Tyson
Frances McDormand	Wendy vanden Heuvel
Noël Mihalow	John A. Vassilaros
Carol Ochs	

**What's Going On Here?**

The 52nd Street Project is a non-profit organization that brings children from the Hell's Kitchen neighborhood together with professional theater artists to create original theater. NOW WE'RE REALLY COOKIN'! is a production of our One-on-One program, which is designed to give children the opportunity to go away for one-week stays in the country and enjoy the undivided attention of a professional theater artist who serves as friend, mentor, and collaborator.

**In-Kind Contributions**

The Murphy Law Office; Abbeville Press; Stephanie Berger Photography; Lewis Black; Iris A. Brown Design; City Winery; A Curran Affair; Kate Cusack; Disney Hyperion; Fox Television; Seventeen Magazine; Steve Olsen and the Westbank Cafe; Jon Paris; Yorke Construction; The S.F. Giants; Newman's Own; Macy's; PineRock; Pharma/Omni Printing; Shapiro Lobel, LLP; Rob White; Sesame Workshop; The NY Yankees; John A. Vassilaros & Sons; Watkins Incorporated; Mayor's Office of Film & Television; Boylan's Bottling Co.; Hudson Scenic; and Paul, Weiss, Rifkind, Wharton & Garrison LLP.

**Special Thanks**

An extra special helping of gratitude goes to our host families; the people who housed our kids and adult volunteers during our week in Wareham, Mass.: Emily & John Morgan; Patty & David Strauss; Gray, Rosemary & Nancy Watson; Andrea & Emmanuel Daskalaskis; Jamie & Cathy Herring; Joe McNay; Peter, Helen & Christopher Randolph.

Sincere thanks also go to Robin Morse, Lucy & Francis Rogerson; Bruce MacVittie; Vanessa Valdes; Bob Krystolfolski; and George Hurd.

## Now We're REALLY Cookin'! - ACT 1

All original music composed by Patrick Barnes

### MACRAME VS. TOWER

Written by Kate E. Ryan & Directed by Susan McGinnis  
for Jocelyn Ochoa, age 10

Juneau.....Jocelyn Ochoa  
Mary.....Susan McGinnis  
Counselor's Voice.....Jesse Bertron

*The Tower Song* lyrics by Kate E. Ryan.

### PERSONAL INJURY

Written by Craig Cox & Directed by Lee Aaron Rosen  
for Miguelangel Vazquez, age 11

Bobby Dee.....Miguelangel Vazquez  
Mickey Hoot.....Lee Aaron Rosen  
Orderly.....Jonathan Rosario  
Sister Mary Ignatius.....Merlaine Mendez

*Lawyers!* lyrics by Craig Cox.

### FOOD CHAMPIONS

Written & Directed by Jedidiah Clarke for Diamond Deanna Graves, age 11

Lisa Berklee.....Diamond Deanna Graves  
Tony Jacobs.....Jedidiah Clarke  
Spotters.....Rosalee Gelpi, Sarah Lewis  
Announcer.....Jonathan Rosario

*Another Level* and *We Are The Champions of Food* lyrics by Jed Clarke.

### ETERNITY TIME

Written by Nikole Beckwith & Directed by Flor De Liz Perez  
for Asia Hoa Rosado, age 11

Amarantha.....Asia Hoa Rosado  
Paula.....Flor De Liz Perez  
Wilson.....Brandon Leon

*Making the Most* lyrics by Nikole Beckwith.

### THE PRETTY GOOD TRAIN ROBBERY

Written & Directed by George Babiak for Adnan Ahmed, age 10

Ned Walker.....Adnan Ahmed  
Big Words Bill.....George Babiak  
The Passengers.....Jonathan Rosario, Merlaine Mendez  
Rosalee Gelpi, Sarah Lewis

*The Biggest Buckle* lyrics by George Babiak.

## Now We're REALLY Cookin'! - ACT 2

### GREAT DATE

Written by Willie Reale & Directed by Megan Cramer  
for Cassidy Capstick, age 10

Jeannette.....Cassidy Capstick  
Andrea.....Megan Cramer

*Everything's Great* lyrics by Willie Reale.

### GREENBEARD'S TREASURE

Written & Directed by Christopher Randolph for Brandon Leon, age 12

Capt. Marcel Gentil.....Brandon Leon  
Capt. Jacques La Feet.....Christopher Randolph

*X Marks The Spot* lyrics by Christopher Randolph.

### [SELF-TITLED]

Written by Jon Kern & Directed by Jackie Chung for Britney Trinidad, age 10

Britney.....Britney Trinidad  
Jackie.....Jackie Chung

*You Gotta Be You* lyrics by Jon Kern.

### KILLING TIME

Written and Directed by Josh Moody for Haley Zoe Martinez, age 13

Norma.....Haley Zoe Martinez  
Fred.....Josh Moody

*More Important Than Murder* lyrics by Josh Moody.

### OVER ONE THOUSAND

Written by Sean Kenealy & Directed by Armando Riesco  
for Nicholas Carrero, age 12

Nico.....Nicholas Carrero  
Mikey.....Armando Riesco

*Weight Lift Every Second* lyrics by Sean Kenealy.

*Now We're REALLY Cookin'! Theme Song*  
Lyrics by John Sheehy

The 52nd Street Project gratefully acknowledges the support of the following foundations and corporations: The Altman Foundation; AON; APA Talent Agency; Big Wood Foundation; BSK Architects; Bloomberg; The Brenner Family Foundation; The Margaret A. Cargill Foundation; Carnegie Corporation of New York; CBS Corporation; CMR Comedy; Consolidated Edison; The Dermot Company; The Educational Foundation Of America; The Dramatists Guild Fund; Dramatists Play Service; Gio Productions, Inc.; The Horace W. Goldsmith Foundation; The William & Mary Greve Foundation; Holland Lodge Foundation, Inc.; Saul Horowitz, Jr. Fund; Hudson Scenic Studio; JKW Foundation; Kresge Foundation; Law Offices of Claudia Wagner; Lightspeed Financial LLC; James A. Macdonald Foundation; Ann M. Martin Foundation; Mellon Equity Associated, Llp; LuEsther T. Mertz Foundation; J.P. Morgan Charitable Trust; The New World Foundation; Newman's Own Foundation; The New York Times Company Foundation; NYFA; Primiano Electric Corp.; Tony Randall Theatrical Fund; Jonathan Rose Companies, Inc.; Shapiro & Lobel; The Shaw Family Endowment Fund; The Shubert Organization; St. Vincent De Paul Foundation; The Harold & Mimi Steinberg Charitable Trust; Stranahan Foundation; Surdna Foundation; Susquehanna Foundation, Corp.; Tax Pro Financial Network, Inc.; Theatre Communications Group, Inc.; Watkins, Inc.; Wiener Family Foundation; John A. Vassilaros & Son, Inc; Yorke Construction Corp. In addition, the following individuals made gifts over \$250 to The 52nd Street Project this past year. (list current as of 7/23/09):

Robert Abrams & Cynthia Vance	Liz Flahive & Jeff Cox	John Lyons	David Ross & Laura Ross
Emily Armstrong	Kristen Frank & Tamir Hashem	Grace Lyu-Volkhausen	Daryl Roth
Dylan & Becky Baker	Louis & Patrice Friedman	Greg MacPherson & Jane Perlmutter	Robert Saget
Jessica Bauman & Ben Posel	Connie Garrido & Ray Rotolo	Steve Martin	Marcia Santoni & John Morris
Lisa Benavides & Tim Nelson	Beverly Gasner	Drew McCoy & Amy Aquino	Meredith Beeuwkes Scarlet
Gavin Berger & Craig Berggren	Christina Gerber	Frances McDormand & Joel Coen	Karin & Tom Schall
Rajeev Bhandari	Freddie Gershon	Ann McLarty & Chuck Knauss	Whitney Scott & Peter Jacobson
Pat Birch	Jillian Gersten & Brian Shuman	Josie Merck & Jim Stevenson	Robert Shaffron & John Davis
Kerrison Black	Alex Gersten-Vassilaros & John A. Vassilaros	Al Minafo	Pam Shaw & Victor Symis
Lewis Black	Nancy Giles	Eric Mindich & Stacey Mindich	Jonathan Sheffer
Andrew Blackman & Tatiana Rutkowski	Tony Goldwyn & Jane Musky	Emily & John Morgan	Peter Shinoda
Lawrence Blau	James Gosnell	Bruce Moulton	Meg Simon
Emily Blavatnik	Richard Gottfried	Karen "Special K" Munkel	Tom Slaughter
Allison & Robert Blinken	Stephen & Cathy Graham	Patricia M. Murphy, Esq. & Adam Spilka	Robert Smigel & Michelle Smigel
Becky Browder & Ted Neustadt	Susannah Gray & John Lyons	John Mustin & Kimberly Mustin	Jonathan & Jennifer Soros
Al Cardinali	Jan Gura & Alan Pickman	Fred Nelson	Paul Logan
Robert & Holly Carter	David & Ann Hausmann	Randy & Rona Nelson	Dimitri & Helen Sogoloff
Judy Cashmore	Sally Holmes & Doug Curtis	Ruth Nelson	Gavin & Joan Solotar
Rachel Chanoff	William Holtzman & S. Sylvia Shepard	James Neuberger & Helen Stambler	Steven & Farrell Starker
Kirk & Katherine Holt Citron	Katy Homans & Patterson Sims	Cynthia Nixon	Jenny & Jon Steingart
Ronald Cohen	Saul Horowitz	Rachel & Larry Norton	Michael & Marjorie Stern
Ruth Cohen & Bob Usdin	Sarah Horowitz & David Venarde	Carol Ochs & Bruce MacVittie	Michael Stone
Judith-Ann Corrente	Andrea Johnson	Jacki Ochs & Jan Kroeze	David Suehsdorf & Janet E. Muir
David Costabile	Douglas & Katie Jordan	Paula Park	Richard Sweren
Billy Crudup	Bob Joy	Jessica Pell	Jeanine Tesori
Arthur Dantchik	Michael Joyce	Elizabeth Peters	Anne Tilney & Douglas Kaden
Cathy Dantchik	Maurice Kanbar	Peter & Ana Rosa Phillips	Anne Torsiglieri & Michael Bernard
Leslie Dantchik	Cindy Kaplan & David Froelich	Judy Goldman & Michael Pillingner	Pamala & Sean Tyson
Peter & Judith Dawkins	Stephen & Susan Ko	Peter & Helen Randolph	Carol L. Nadell & Richard E. Van Deusen
Jim Delaney	Judy Kuhn & David Schwab	Willie Reale & Jenny Gersten	Wendy vanden Heuvel & Brad Coley
Neil DeSena & Carolyn DeSena	Howard Laks & Irena Laks	Jennifer Reichle	Ed Vassallo
William Dockery	Michael P. Lawrence	Jacquelyn Reingold	Joe Versace
Richard & Rebecca Dresser	Warren Leight	Ira Resnick	Mary Pat Walsh
Adam Dubin & Rochelle Dubin	Robert Sean Leonard & Gaby Salick	Burt Resnick & Judy Resnick	Lynn & Sam Waterston
Peter Jay Fernandez & Denise Burse	Tom Leonardis	Kevin Louis Reymond & Dana Lee Reymond	Michael & Zena Wiener
Suzanne Fine & Christian Salomone	Martin Levine	Michael Richter & Veronica Richter	Richard Willis & Jill Willis
Angelina Fiordellisi & Matt Williams	Harold Levison & Ilyse Levison	Joseph Rokacz & Larry Gordon	Geoffrey Wills
Peter Fisch & Jill Levy Fisch	Anna Li & Frank Sposato	David Rosenberg	Frank Wood
Katie Flahive	Melissa Liebling-Goldberg & John Barrett		Lynne Zeavin & Donald Moss
	Michael & Marjorie Loeb		
	Mark Lonow & JoAnne Astrow		



## The 52nd Street Project Presents



The Five Angels Theater  
789 10th Avenue

October 22-24, 2010

ART BY DEBO GAFFANEY



# PSSST! THE SECRET PLAYS

Playback 2010 - Oct. 22-24, The Five Angels Theater

## The 52nd Street Project Staff

Gus Rogerson, Artistic Director  
Carol Ochs, Executive Director  
John Sheehy, Director of Development and Marketing  
George Babiak, Production Manager  
Ray Harold, Technical Director  
Liz Bell, Director of Education  
Megan Cramer, Associate Artistic Director  
Diana Rojas, Associate Program Director  
Josh Moody, Development Assistant  
Chris Ceraso, Teen Dean  
Nicole A. Watson, Teen Shakespeare Director  
Iris A. Brown, Graphic Designer  
Samantha Caldon, Ralphie Irizarry III, Daquan Nelson, Azalea Rosario, Malik Velazquez, Francis Williams, Jorge Zapata, Teen Employees  
Mikhaela Mahony, Rafael Miguel, Lauren Rissman, Kieran Sequoia, Interns

## "PSSST" Production Staff

### Composer/Music Director

Andrew Sherman

### Set Designer

Kevin Joseph Roach

### Lighting Designer

Greg McPherson

### Costume Designer

Lara de Bruijn

### Sultan of Sound

Maury Schott

### Stage Manager

Carol Sullivan

### Slide Designs

George Babiak, John Sheehy,  
and the Project Slide Archive

### Prop Design Team

George Babiak, Megan Cramer,  
Lee Rosen, Kieran Sequoia,  
John Sheehy

### Backstage Crew

Mikhaela Mahony, Rafael Miguel,  
Lauren Rissman, Kieran Sequoia,  
Nathaly Trinidad

### House Managers

Liz Bell, Karin Schall,  
Mary Pat Walsh

### Show Photographer

Winston Rodney

### Chefs

Liz Bell, John Sheehy

### Bridgehampton Hosts

John Vassilaros,  
Alex Gersten-Vassilaros,  
and Tonio, Luka, and  
Stefano Vassilaros.

## COOL STUFF ON SALE IN THE LOBBY!

FABULOUS FLYER BARS ..... \$2.50, \$2, \$1.50

AND FEATURING SHEL SILVERSTEIN'S  
"FIVEY AND TWOEY" LOGO:

PROJECT T-SHIRTS.....\$12.00

PROJECT HOODIES.....\$30.00

PROJECT CAPS.....\$20.00

PROJECT MUGS ..... \$5.00

PROJECT PENCIL 3-PACK ..... \$1.00

PROJECT NOTEBOOK..... \$5.00

Thank you for coming to PSSST! THE SECRET PLAYS! If you are not on our mailing list (or if your address has changed), please fill out this form and give it to us on your way out or mail it to the address below. We would also like to know if you are interested in becoming a volunteer. We need help in all areas, so be sure to fill out the entire form.

PLEASE ADD ME TO YOUR MAILING LIST:

10/10

NAME

ADDRESS

CITY

STATE

ZIP

HOME PHONE

DAYTIME OR MOBILE PHONE

E-MAIL ADDRESS

MY OCCUPATION

MY HOBBIES

YES, I WOULD LIKE TO BE OF HELP. I CAN:

- |   |  |  |
|---|--|--|
| <input type="checkbox"/> Draw and/or paint            | <input type="checkbox"/> Help kids with homework |  |
| <input type="checkbox"/> Hang lights                  | <input type="checkbox"/> Help with mailings      | <input type="checkbox"/> Teach kids a skill      |
| <input type="checkbox"/> Work on a backstage crew     | <input type="checkbox"/> Do office work          | <input type="checkbox"/> Be a chef at an event   |
| <input type="checkbox"/> Do graphic design            | <input type="checkbox"/> Design sound            | <input type="checkbox"/> Design and sew costumes |
| <input type="checkbox"/> Other (please specify) _____ |  |  |

MY SCHEDULE IS:

- Very flexible. I'm often available during weekdays.  
 Somewhat flexible. I can help on the occasional morning or afternoon during the week.  
 Not very flexible at all, but I've got some free time on evenings and weekends.

If you would like to mail this (and you're always welcome to enclose a tax-deductible contribution), you can send it to: The 52nd Street Project, 789 10th Avenue, New York, NY 10019. Or fax it to (212) 333-5598.



The Playback Program is made possible with public funds from The New York State Council on the Arts, a state agency; and the New York City Department of Cultural Affairs. The Project is a member of ART/NY.



**COMING UP SOON!**



**THE FALL 2010 PLAYMAKING PLAYS**

**December 10-12, 2010 at The Five Angels Theater**

Last month, the youngest Project kids began Megan Cramer's class in the fine art of Playmaking. Come celebrate our first anniversary in this theater by seeing these shows.



**BE ON THE LOOKOUT!  
WE ARE ALWAYS  
SEARCHING FOR INTERNS.**

If you know of any college or graduate students who might enjoy working with us, playing with us, and going on trips with us for a semester, please have them contact George Babiak or Megan Cramer. We are especially looking for interns for the Spring and Summer of 2011. Thanks!

**The 52nd Street Project Board of Directors**

Lisa Benavides	Carol Ochs
Rachel Chanoff	Willie Reale, founder
Cathy Dantchik	Gus Rogerson
Carolyn DeSena	Shirley Rumierk, alumni member
Wendy Ettinger, chair emeritus	José Soto, Jr., alumni member
Louis P. Friedman	Jenny Steingart
Robert Goldberg	Lisa Tilney
Stephen Graham, chair	Merritt Tilney
James McDaniel	Pamala Tyson
Frances McDormand	Wendy vanden Heuvel
Noël Mihalow	John A. Vassilaros

---

**What's Going On Here?**

The 52nd Street Project is a non-profit organization that brings children from the Hell's Kitchen neighborhood together with professional theater artists to create original theater. PSSST! THE SECRET PLAYS is a production of our Playback program, in which kid actor/playwrights wrote plays for themselves and adult actor/director partners. Everyone ventured to the Hamptons for a rehearsal retreat over the Columbus Day weekend. All of the kids involved are veterans of the Playmaking classes which were adapted for the Project by Daniel Judah Sklar from his book Playmaking: Children Writing and Performing Their Own Plays.

---

**In-Kind Contributions**

The Murphy Law Office; Abbeville Press; Stephanie Berger Photography; Lewis Black; Richard Blackstone; Iris A. Brown Design; City Winery; William Curran & A Curran Affair; Kate Cusack; EMI Records; ICI; The S.F. Giants; Newman's Own; Macy's; Pharma Print; PineRock; The N; Shapiro Lobel, LLP; Wendy Stuhlberg; The Yankees; John A. Vassilaros; Watkins, Inc.; Mayor's Office of Film & Television; Boylan's Bottling Co.; Hudson Scenic; and Paul, Weiss, Rifkind, Wharton & Garrison LLP.

---

**Special Thanks**

We're extremely grateful to John Vassilaros, Alex Gersten-Vassilaros, their boys Tonio, Luka and Stefano, and the ever-helpful Joyce for allowing us to use their home as our headquarters on our rehearsal trip to the Hamptons. Thanks also to Louis and Patrice Friedman who let some of our volunteers crash at their home in Bridgehampton.

# POOST! THE SECRET PLAYS - ACT 1

All original music composed by Andrew Sherman

## **FIXING INVENTIONS**

Written by Lauren Robinson, age 13.

Director/Dramaturge: Nehassaiu deGannes.

Milly ..... Lauren Robinson  
 Dr. Jen Jouhsmilly ..... Nehassaiu deGannes  
 Justin ..... Rafael Miguel  
 Milly From the Past ..... Lauren Rissman  
 Jen's Mother ..... Kieran Sequoia  
 Jen's Father ..... George Babiak  
 Jen From the Past ..... Nathaly Trinidad  
*What Else Could Go Wrong?* lyrics by Lauren Robinson.

## **CARL AND JIMMY**

Written by Devin Gonzalez, age 13.

Director/Dramaturge: Jason Hare.

Carl ..... Devin Gonzalez  
 Jimmy ..... Jason Hare  
 Carl's Mom ..... Mikhaela Mahony  
*Two Best Friends* lyrics by Devin Gonzalez.

## **INTRUDER ALERT!**

Written by Mari Ulloa, age 13.

Director/Dramaturge: Katie Meister.

Taylor Perrie ..... Mari Ulloa  
 Zork Smith ..... Katie Meister  
 Commander/Blackberry ..... George Babiak  
*What I Want* and *We're Going to Earth* lyrics by Mari Ulloa.

## **FAKE THUG**

Written by Hashem Ahmed, age 13.

Director/Dramaturge: Shane West.

Mike ..... Hashem Ahmed  
 Ike ..... Shane West  
 Cashier/Security ..... Rafael Miguel  
 Old Lady/ Mike's Mom ..... Megan Cramer  
 Judge ..... Kieran Sequoia  
*I Don't Know Why* and *Goodbye* lyrics by Hashem Ahmed.



# POOST! THE SECRET PLAYS - ACT 2

## **FRIENDLESS**

Written by Gabriella DeJesus, age 13.

Director/Dramaturge: Krystel Lucas.

Giselle ..... Gabriella DeJesus  
 Alivia ..... Krystel Lucas  
 Cup ..... Lauren Rissman  
 Cake/Woman Cop 1 ..... Mikahela Mahony  
 Teacher/ Woman Cop 2 ..... Kieran Sequoia  
 Nike & Jordan ..... Rafael Miguel, Nathaly Trinidad  
*Behind the Bars* and *Regret* lyrics by Gabriella DeJesus.

## **SWEET OLD GRANNY**

Written by Michael Bannister, age 13.

Dramaturge: Neal Bledsoe Director: Josh Moody.

Grandmomma ..... Michael Bannister  
 Nicky Brown ..... Josh Moody  
 Bully #1 ..... Megan Cramer  
 Bully #2 ..... George Babiak  
 Mugger/Cashier ..... John Sheehy  
*No Yes and Sorry* lyrics by Michael Bannister.

## **A FRIENDSHIP THAT COULDN'T BE**

Written by Zoltan Lucas, age 13.

Director/Dramaturge: Lucas Caleb Rooney.

Edward ..... Zoltan Lucas  
 David ..... Lucas Caleb Rooney  
 Student ..... Lauren Rissman  
*Wonderful Place Do Whatever You Want* and *One Day I'll Be Sultan*  
 lyrics by Zoltan Lucas.

## **HAUNTED HOUSE DRAMA**

Written by Jasmine Hernandez, age 13.

Director/Dramaturge: Molly Coogan.

Darkness ..... Jasmine Hernandez  
 Melisa ..... Molly Coogan  
*One Song Wonder* and *One Song Wonder Reprise* lyrics by Jasmine Hernandez.



The 52nd Street Project gratefully acknowledges the support of the following foundations and corporations: BGC; Big Wood Foundation; Bloomberg; Carnegie Corporation of New York; CBS Corporation; Consolidated Edison; The Neil V. DeSena Foundation; The Dramatists Guild Fund; Dramatists Play Service; Eleanor, Adam & Mel Dublin Foundation; The Educational Foundation Of America; Flexis Capital LLC; Sidney E. Frank Foundation; Fund for the City of New York; Grant's Financial Publishing, Inc.; The William and Mary Greve Foundation; Heisman Foundation; The Henlopen Foundation; The Horace W. Goldsmith Foundation; Hudson Scenic Studio; I. Weiss; Integra Realty; The Suzanne Nora Johnson & David G. Johnson Foundation; Ann M. Martin Foundation; J.P. Morgan Charitable Trust; MTI; National Philanthropic Trust; NYFA; Punchline Magazine; Jonathan Rose Companies; The Shubert Organization; Simon & Eisenberg; St. Vincent De Paul Foundation; Harold & Mimi Steinberg Charitable Trust; Stranahan Foundation; Susquehanna Foundation, Corp.; Tax Pro Financial Network, Inc.; Theater Subdistrict Council; Theatre Communications Group, Inc.; Tiger Baron Foundation; United Real Estate Ventures, Inc.; Van Deusen Family Fund; Watkins, Inc.; Yorke Construction Corp. In addition, the following individuals made gifts over \$250 to The 52nd Street Project this past year. (list current as of 12/09/10):

Robert Abrams & Cynthia Vance	Arthur Dantchik	Kevin Kelly	David & Laura Ross
George Ackert	Cathy Dantchik	Patrick & Diane Kelly	Carla Sacks & John Morris
Michael Alicastro	Leslie Dantchik	Ed Keslo	Christian Sauska
Elton Andrews	Peter & Judith Dawkins	John & Sefanie Kyles	Karin & Tom Schall
Richard Anthony	Russell Dodson	Michael P. Lawrence	George Schieferdecker
Emily Armstrong	Michael Dougherty	Lisa Leguillou	Mike Shaheen
Dylan & Becky Baker	Richard & Rebecca Dresser	Warren Leight	Phil Shaheen
Dominick & Ilene Balletta	Brian & Carol Duggan	Martin Levine	Pam Shaw & Victor Symris
Ken Bantum	Greg Durkin & Vanessa Beecroft	Adrienne Lobel	Kim Sherman & John Sheehy
Jessica Bauman & Ben Posel	Rick Elliott	Paul Logan	Meg Simon
Lisa Benavides & Tim Nelson	Nigel Faulkner & Amanda Faulkner	Susan Hess Lucier	Ravi Singh
Gavin Berger & Craig Berggren	Adam Felber & Jeanne Simpson	Thomas Lynch	Brian Sklar
Brett Berk	Peter Jay Fernandez & Denise Burse	John Lyons	Christopher Solomon
Eric & Elizabeth Berman	Michael Ferrara	Grace Lyu-Volckhausen	Jonathan & Jennifer Soros
David Beth	Angelina Fiordellisi & Matt Williams	Greg MacPherson & Jane Perlmutter	Steven & Farrell Starker
Lewis Black	Randy Frankel	Paul McCrane & Dana Kellin	Melvin Stecher
Richard Blackstone & Yildez Yuksek	Alison Fraser & Nat Magee	Frances McDormand & Joel Coen	Jenny & Jon Steingart
Emily Blavatnik	Beverly Gasner	Eric & Stacey Mindich	Tracy Straus
Allison & Robert Blinken	Alexandra Gersten & John Vassilaros	Emily & John Morgan	Richard Sweren
Michelle Bork & Jonathan Levine	Scott Aaron Gewirtz & Laura Gewirtz	John David Moriarty	Mike Szwajkowski
Margo Boyle	Nancy Giles	Dexter Morse	Timothy Thomas
Liz Brixius	Paul Giordano	Suzen Murakoshi & Mark Temme	Anne Tilney & Douglas Kaden
Becky Browder & Ted Neustadt	Tony Goldwyn & Jane Musky	T.J. Nelligan	Lisa Tilney
Brian Byrnes	Stephen & Cathy Graham	Fred Nelson	Liz Tuccillo
Shawn Byron & Laura Byron	Emily Grishman & Susan Sampliner	Randy & Rona Nelson	Gregory Tuzar
Rich Cancro	Jonathan Groff	Ruth Nelson	Matthew Tuzman
Lawrence Catena	Jan Gura & Alan Pickman	Duncan Niederauer	Laura Valeroso & David Seidman
Rachel Chanoff	David & Ann Hausmann	Cynthia Nixon	Wendy vanden Heuvel & Brad Coley
Nora Charles	Peter Herdich & Karen Trott	Rachel & Larry Norton	Brian Villante
Kirk Citron & Katherine Holt Citron	Eric & Barbara Hippeau	Jodi Nuss	Richard Wagner
David Cohen & Sandra Novak Cohen	William Holtzman & S. Sylvia Shepard	Kevin O'Rourke & Edith Thurber	Mary Pat Walsh
Larry Cohen	Katy Homans & Patterson Sims	Carol Ochs & Bruce MacVittie	Borah & Mildred Walton
Ruth Cohen & Bob Usdin	Sarah Horowitz & David Venarde	F. Richard Pappas	Scott Ward
Melissa Cohn	Mrs. Saul Horowitz	Elizabeth Peters	Lynn & Sam Waterston
Judith-Ann Corrente	Andrea Johnson	Bat-Sheva & Thomas Peters	Sally & Lenny Weiss
Janet Coviello	Cindy Kaplan & David Froelich	Susan Ochs Phillips	Jane Bolster & Steve Wertimer
Jeffrey & Anna Cramer	Anita Rogerson	Judy Goldman & Michael Pillinger	Thomas Whatley
Carolyn Cushman & Neil DeSena		Stephanie Plousis	Elizabeth Williams & Joseph Forte
Kyle Czepiel		Willie Reale & Jenny Gersten	John William & Suzanne William
		Jacquelyn Reingold	J.P. Xenakis
		James Rogan	Carole Yass & Randy Ginsburg
		Daniel Zarkowsky	Jarrod Yuster

## THE 52ND STREET PROJECT PRESENTS THE FALL 2010 PLAYMAKING SHOWS

GUS ROGERSON,  
ARTISTIC DIRECTOR

CAROL OCHS,  
EXECUTIVE DIRECTOR

MEGAN CRAMER,  
PLAYMAKING DIRECTOR

# HOLY COW! THE ASTONISHING PLAYS

# 10

NEW PLAYS  
WRITTEN BY KIDS  
AND PERFORMED BY  
ADULT ACTORS

AT THE 52ND STREET PROJECT'S  
**FIVE ANGELS THEATER**

FRIDAY, DEC. 10 @ 7:30 P.M.,  
SATURDAY, DEC. 11 @ 3:00 AND 7:30 P.M.,  
AND SUNDAY, DEC. 12 @ 3:00 P.M.



ART BY LEE ROSEN

# HOLY COW! THE ASTONISHING PLAYS

The Fall 2010 Playmaking Production - Dec. 10-12, The Five Angels Theater

## The 52nd Street Project Staff

Gus Rogerson, Artistic Director  
 Carol Ochs, Executive Director  
 John Sheehy, Director of Development and Marketing  
 George Babiak, Production Manager  
 Liz Bell, Director of Education  
 Megan Cramer, Associate Artistic Director  
 Diana Rojas, Associate Program Director  
 Josh Moody, Development Associate  
 Ray Harold, Technical Director  
 Lisa Kerner, General Management Associate  
 Chris Ceraso, Teen Dean  
 Nicole A. Watson, Teen Shakespeare Director  
 Iris A. Brown, Graphic Designer  
 Mikhaela Mahony, Rafael Miguel, Lauren Rissman, Kieran Sequoia, Interns

### Teen Employees:

Samantha Caldon, Carlos Dume, Emmett Goodman-Boyd, Raphael Irizarry, III, Chloe Moore, Daquan Nelson, Tino Paduani, Azalea Rosario, Luisa Santiago, Viviana Vazquez, Malik Velazquez, Francis Williams, Jorge Zapata  
 Chloe Moore, Tino Paduani, and Malik Velazquez, Ushers.

## "Holy Cow" Production Staff

Composer/Music Director Patrick Barnes	Julie Sharbutt, John Sheehy
Set Designer Kevin Joseph Roach	Backstage Crew Wendell Joseph, Mikhaela Mahony, Ashley Melon, Rafael Miguel, Kieran Sequoia
Lighting Designer Cat Tate Starmer	House Managers Liz Bell, Lisa Kerner, Mary Pat Walsh
Costume Designer Viviane Galloway, Crystal Thompson, Ciera Wells	Flyer Art Lee Rosen
Goddess of Sound Vanessa Valdes	Chefs Iris Brown, Joe White, Liz Bell, Carol Ochs
Stage Manager Charles M. Turner, III	Playmaking Class Volunteers Diana Buirski, Larkin Clark, Jed Clarke, Sam Ghosh, Matthew Jellison, Reza Salazar, Cynthia Wong
Fight Choreographer Tom Schall	Playmaking Class Teen Assistant Samantha Caldon
Slide Design: George Babiak, Julie Sharbutt, and the Project Slide Archive	Production Photographer Winston Rodney
Prop Design Team George Babiak, Liz Bell, Megan Cramer, Angel Desai, Mikhaela Mahony, Ashley Melon,	



The Playmaking Program is made possible with public funds from The New York State Council on the Arts, a state agency; and the New York City Department of Cultural Affairs. The 52nd Street Project is a member of ART/NY.

## COOL STUFF ON SALE IN THE LOBBY!

NEW! REPLAY SCRIPTS.....\$10.00  
 FABULOUS FLYER BARS ..... \$2.50, \$2, \$1.50

AND FEATURING SHEL SILVERSTEIN'S  
 "FIVEY AND TWOEY" LOGO:

PROJECT T-SHIRTS.....\$12.00  
 PROJECT HOODIES.....\$30.00  
 PROJECT CAPS.....\$20.00  
 PROJECT MUGS .....\$5.00  
 PROJECT PENCIL 3-PACK .....\$1.00  
 PROJECT NOTEBOOK.....\$5.00

Thank you for coming to **HOLY COW!** If you are not on our mailing list (or if your address has changed), please fill out this form and give it to us on your way out or mail it to the address below. We would also like to know if you are interested in becoming a volunteer. We need help in all areas, so be sure to fill out the entire form.

PLEASE ADD ME TO YOUR MAILING LIST:

12/10

NAME \_\_\_\_\_

ADDRESS \_\_\_\_\_

CITY \_\_\_\_\_ STATE \_\_\_\_\_ ZIP \_\_\_\_\_

HOME PHONE \_\_\_\_\_

DAYTIME OR MOBILE PHONE \_\_\_\_\_ E-MAIL ADDRESS \_\_\_\_\_

MY OCCUPATION \_\_\_\_\_

MY HOBBIES \_\_\_\_\_

### YES, I WOULD LIKE TO BE OF HELP. I CAN:

- |   |  |
|---|--|
| <input type="checkbox"/> Draw and/or paint            | <input type="checkbox"/> Help kids with homework |
| <input type="checkbox"/> Hang lights                  | <input type="checkbox"/> Help with mailings      |
| <input type="checkbox"/> Work on a backstage crew     | <input type="checkbox"/> Do office work          |
| <input type="checkbox"/> Do graphic design            | <input type="checkbox"/> Design sound            |
| <input type="checkbox"/> Other (please specify) _____ | <input type="checkbox"/> Teach kids a skill      |
|   | <input type="checkbox"/> Be a chef at an event   |
|   | <input type="checkbox"/> Design and sew costumes |

### MY SCHEDULE IS:

- Very flexible. I'm often available during weekdays.  
 Somewhat flexible. I can help on the occasional morning or afternoon during the week.  
 Not very flexible at all, but I've got some free time on evenings and weekends.

If you would like to mail this (and you're always welcome to enclose a tax-deductible contribution), you can send it to: The 52nd Street Project, 789 10th Ave., New York, NY 10019. Or fax it to (212) 333-5598.

## DON'T MISS OUR NEXT SHOW!

THE 52ND STREET PROJECT PRESENTS THE 2011 TWO-ON-TWO'S



# FRIENDS LIKE THESE: THE ENEMY PLAYS

6 NEW PLAYS \* 6 ADULT WRITERS \* 6 ADULT DIRECTORS \* 12 KID ACTORS

FRIDAY, JAN. 28 @ 7:30 P.M.  
SATURDAY, JAN. 29 @ 7:30 P.M.  
SUNDAY, JAN. 30 @ 3:00 P.M.

ALL PERFORMANCES RIGHT HERE AT THE 52ND STREET PROJECT'S

**FIVE ANGELS THEATER**



**BE ON THE LOOKOUT!  
WE ARE ALWAYS  
SEARCHING FOR INTERNS.**

If you know of any college or graduate students who might enjoy working with us, playing with us, and going on trips with us for a semester, please have them contact George Babiak or Megan Cramer. We are currently looking for interns for January-May, 2011 and the summer of 2011. Thanks!

## The 52nd Street Project Board of Directors

Lisa Benavides	Carol Ochs
Rachel Chanoff	Willie Reale, founder
Cathy Dantchik	Gus Rogerson
Carolyn DeSena	Shirley Rumierk, alumni member
Wendy Ettinger, chair emeritus	José Soto, Jr., alumni member
Louis P. Friedman	Jenny Steingart
Robert Goldberg	Lisa Tilney
Stephen Graham, chair	Merritt Tilney
James McDaniel	Pamala Tyson
Frances McDormand	Wendy vanden Heuvel
Noël Mihalow	John A. Vassilaros

## What's Going On Here?

The 52nd Street Project is a non-profit organization that brings children from the Hell's Kitchen neighborhood together with professional theater artists to create original theater. *HOLY COW* is a production of our Playmaking program. Young people participate in a nine-week playwriting course taught by Megan Cramer and adapted for the Project by Daniel Judah Sklar from his book *Playmaking: Children Writing and Performing Their Own Plays*. At the end of the course, each child is matched with two actors and a dramaturg/director who guides him or her through the writing of a play during a weekend retreat in the country (Stone Ridge, New York, for this show). This performance is the end result.

## In-Kind Contributions

The Murphy Law Office; Abbeville Press; Stephanie Berger Photography; Lewis Black; Richard Blackstone; Iris A. Brown Design; City Winery; William Curran & A Curran Affair; Kate Cusack; EMI Records; ICI; The S.F. Giants; Newman's Own; Macy's; Pharma Print; PineRock; The N; Shapiro Lobel, LLP; Wendy Stuhlberg; The Yankees; John A. Vassilaros; Watkins, Inc.; Mayor's Office of Film & Television; Boylan's Bottling Co.; Hudson Scenic; and Paul, Weiss, Rifkind, Wharton & Garrison LLP.

## Special Thanks

We're extremely grateful to Steve Gorn and Barbara Bash for the use of their beautiful home in Stone Ridge, NY as our base of operations for the writer's retreat. The indispensable host families were Joe White & Iris Brown (who doubled as chefs), Sean Cullen & Tess Hartman, Laura Shaine Cunningham, David Curtis & Ann Morris, Elaine Musselman, Nicole & Paul Quinn and Deborah Freedman and Bill Woods.

## HOLY COW: THE ASTONISHING PLAYS - ACT 1

All original music composed by Patrick Barnes

### THE BIG PROBLEM OF APRIL AND JUNE

Written by Melody Cruz, age 11.  
Director/ Dramaturge: Erin Quinn Purcell.  
Costume Designer: Crystal Thompson.

April ..... January LaVoy  
June ..... Jennifer Ikeda  
Guppies ..... Megan Cramer, Mikhaela Mahony, Rafael Miguel  
*I Apologize* lyrics by Melody Cruz.

### A DREAM COME TRUE

Written by Jeremy Vazquez, age 11.  
Director/Dramaturge: Tim Cain.  
Costume Designer: Viviane Galloway.

Jason ..... Grant Harrison  
Nick ..... Matthew Jellison  
Coach ..... Gus Rogerson  
Football Players ..... Crew and Staff

### THE RUN WALKER

Written by Ahmed Nasser, age 11.  
Dramaturge: Rafael Miguel Director: Angel Desai.  
Costume Designer: Ciera Wells.

Walker ..... Kevin O'Rourke  
Runner ..... Ned Eisenberg  
*It's So Hard in the Woods* and *We Are On the Shore* lyrics by Ahmed Nasser.

### FRIENDSHIP DAY OR ELSE

Written by Kaitlin Feliciano, age 10.  
Director/Dramaturge: Sonia Manzano.  
Costume Designer: Crystal Thompson.

Rainbow ..... Lili Taylor  
Selfy ..... Liza Fernandez  
Photographer ..... Rafael Miguel  
Unicorns ..... Crew

### THE BEAUTY AND THE RICHNESS

Written by Lambert Whitney, age 9.  
Dramaturge: Josh Moody Director: John Sheehy.  
Costume Designer: Ciera Wells.

Big Joe ..... Bhavesh Patel  
Big Melony ..... Judy Kuhn  
*The Big Chase*, *O So Pretty*, and *Now and Again* lyrics by Lambert Whitney.

## HOLY COW: THE ASTONISHING PLAYS - ACT 2

### TREE WITH AN EYE

Written by Faisal Afridi, age 10.  
Director/ Dramaturge: Felix Solis.  
Costume Designer: Crystal Thompson.

Maniac Tree With an Eye ..... Keith Randolph Smith  
Zombie Slayer Dude ..... Ray Anthony Thomas  
Kid ..... Wendell Joseph  
Newscaster ..... George Babiak  
Zombie Horde ..... Crew

*The Tree is a Maniac* lyrics by Faisal Afridi.

### A MEAN REPTILE

Written by Amanda Rosa, age 10.  
Director/Dramaturge: Justin Waldman.  
Costume Designer: Vivane Galloway.

Kacapout ..... Patrick Breen  
Crystal ..... Diane Davis  
Kacapout's Mom ..... Mikhaela Mahony

*A Sad Song* and *Worry Song* lyrics by Amanda Rosa.

### KILLING SPREE

Written by Derek Tineo, age 11.  
Director/Dramaturge: Martin Moran.  
Costume Designer: Viviane Galloway.

Anna Chicken ..... Sam Ghosh  
Sammy Weak ..... Annie Purcell

### LONG NECK/ SWEET SIXTEEN

Written by Edelys Tiana Guerrero, age 10.  
Director/Dramaturge: Crystal Dickinson.  
Costume Designer: Ciera Wells.

Zoe Long Neck ..... Liza Colon-Zayas  
Sam Long Neck ..... Ken Robinson

*Without You* lyrics by Edelys Tiana Guerrero.

### THE SINGING DISAGREEMENT

Written by Genesis Hires, age 10.  
Director/Dramaturge: Diana Buirski.  
Costume Designer: Ciera Wells.

Raven ..... Christina Robinson  
Terra ..... Frances McDormand  
Announcer ..... Rafael Miguel

*Let it Go* and *Singing Friends* lyrics by Genesis Hires.



# SHOW PROGRAMS 2011-2015

## THE 52ND STREET PROJECT PRESENTS THE 2011 TWO-ON-TWO'S

The 52nd Street Project gratefully acknowledges the support of the following foundations and corporations: BGC; Big Wood Foundation; Bloomberg; Carnegie Corporation of New York; CBS Corporation; Consolidated Edison; The Neil V. DeSena Foundation; The Dramatists Guild Fund; Dramatists Play Service; Eleanor, Adam & Mel Dubin Foundation; The Educational Foundation Of America; Flexis Capital LLC; Sidney E. Frank Foundation; Fund for the City of New York; Grant's Financial Publishing, Inc.; The William and Mary Greve Foundation; Heisman Foundation; The Henlopen Foundation; The Horace W. Goldsmith Foundation; Hudson Scenic Studio; I. Weiss; Integra Realty; The Suzanne Nora Johnson & David G. Johnson Foundation; Ann M. Martin Foundation; J.P. Morgan Charitable Trust; MTI; National Philanthropic Trust; NYFA; Punchline Magazine; Jonathan Rose Companies; The Shubert Organization; Simon & Eisenberg; St. Vincent De Paul Foundation; Harold & Mimi Steinberg Charitable Trust; Stranahan Foundation; Susquehanna Foundation, Corp.; Tax Pro Financial Network, Inc.; Theater Subdistrict Council; Theatre Communications Group, Inc.; Tiger Baron Foundation; United Real Estate Ventures, Inc.; Van Deusen Family Fund; Watkins, Inc.; Yorke Construction Corp. In addition, the following individuals made gifts over \$250 to The 52nd Street Project this past year. (list current as of 12/09/10):

Robert Abrams & Cynthia Vance	Arthur Dantchik	Kevin Kelly	David & Laura Ross
George Ackert	Cathy Dantchik	Patrick & Diane Kelly	Carla Sacks & John Morris
Michael Alicastro	Leslie Dantchik	Ed Keslo	Christian Sauska
Elton Andrews	Peter & Judith Dawkins	John & Sefanie Kyles	Karin & Tom Schall
Richard Anthony	Russell Dodson	Michael P. Lawrence	George Schieferdecker
Emily Armstrong	Michael Dougherty	Lisa Leguillou	Mike Shaheen
Dylan & Becky Baker	Richard & Rebecca Dresser	Warren Leight	Phil Shaheen
Dominick & Ilene Balletta	Brian & Carol Duggan	Martin Levine	Pam Shaw & Victor Symis
Ken Bantum	Greg Durkin & Vanessa Beecroft	Adrienne Lobel	Kim Sherman & John Sheehy
Jessica Bauman & Ben Posel	Rick Elliott	Paul Logan	Meg Simon
Lisa Benavides & Tim Nelson	Nigel Faulkner & Amanda Faulkner	Susan Hess Lucier	Ravi Singh
Gavin Berger & Craig Berggren	Adam Felber & Jeanne Simpson	Thomas Lynch	Brian Sklar
Brett Berk	Peter Jay Fernandez & Denise Burse	John Lyons	Christopher Solomon
Eric & Elizabeth Berman	Michael Ferrara	Grace Lyu-Volckhausen	Jonathan & Jennifer Soros
David Beth	Angelina Fiordellisi & Matt Williams	Greg MacPherson & Jane Perlmutter	Steven & Farrell Starker
Lewis Black	Randy Frankel	Paul McCrane & Dana Kellin	Melvin Stecher
Richard Blackstone & Yldez Yuksek	Alison Fraser & Nat Magee	Frances McDormand & Joel Coen	Jenny & Jon Steingart
Emily Blavatnik	Beverly Gasner	Eric & Stacey Mindich	Tracy Straus
Allison & Robert Blinken	Alexandra Gersten & John Vassilaros	Emily & John Morgan	Richard Sweren
Michelle Bork & Jonathan Levine	Scott Aaron Gewirtz & Laura Gewirtz	John David Moriarty	Mike Szwajkowski
Margo Boyle	Nancy Giles	Dexter Morse	Timothy Thomas
Liz Brixius	Paul Giordano	Suzen Murakoshi & Mark Temme	Anne Tilney & Douglas Kaden
Becky Browder & Ted Neustadt	Tony Goldwyn & Jane Musky	T.J. Nelligan	Lisa Tilney
Brian Byrnes	Stephen & Cathy Graham	Fred Nelson	Liz Tuccillo
Shawn Byron & Laura Byron	Emily Grishman & Susan Sampliner	Randy & Rona Nelson	Gregory Tusar
Rich Cancro	Jonathan Groff	Ruth Nelson	Matthew Tuzman
Lawrence Catena	Jan Gura & Alan Pickman	Duncan Niederauer	Laura Valeroso & David Seidman
Rachel Chanoff	David & Ann Hausmann	Cynthia Nixon	Wendy vanden Heuvel & Brad Coley
Nora Charles	Peter Herdrich & Karen Trott	Rachel & Larry Norton	Brian Villante
Kirk Citron & Katherine Holt Citron	Eric & Barbara Hippeau	Jodi Nuss	Richard Wagner
David Cohen & Sandra Novak Cohen	William Holtzman & S. Sylvia Shepard	Kevin O'Rourke & Edith Thurber	Mary Pat Walsh
Larry Cohen	Katy Homans & Patterson Sims	Carol Ochs & Bruce MacVittie	Borah & Mildred Walton
Ruth Cohen & Bob Usdin	Sarah Horowitz & David Venarde	F. Richard Pappas	Scott Ward
Melissa Cohn	Mrs. Saul Horowitz	Elizabeth Peters	Lynn & Sam Waterston
Judith-Ann Corrente	Andrea Johnson	Bat-Sheva & Thomas Peters	Sally & Lenny Weiss
Janet Coviello	Cindy Kaplan & David Froelich	Susan Ochs Phillips	Jane Bolster & Steve Wertimer
Jeffrey & Anna Cramer	Anita Rogerson	Judy Goldman & Michael Pillinger	Thomas Whatley
Carolyn Cushman & Neil DeSena		Stephanie Plouvis	Elizabeth Williams & Joseph Forte
Kyle Czepiel		Willie Reale & Jenny Gersten	John William & Suzanne William
		Jacquelyn Reingold	J.P. Xenakis
		James Rogan	Carole Yass & Randy Ginsburg
			Jarrod Yuster
			Daniel Zarkowsky



ART BY PATRICK JONES

# FRIENDS LIKE THESE: THE ENEMY PLAYS

6 NEW PLAYS ★ 6 ADULT WRITERS ★ 6 ADULT DIRECTORS ★ 12 KID ACTORS

FRIDAY, JAN. 28 @ 7:30 P.M.

SATURDAY, JAN. 29 @ 7:30 P.M.

SUNDAY, JAN. 30 @ 3:00 P.M.

THE 52ND STREET PROJECT'S

## FIVE ANGELS THEATER



## FRIENDS LIKE THESE: THE ENEMY PLAYS

The 2011 Two-on-Two's - January 28-30, The Five Angels Theater

### The 52nd Street Project Staff

Gus Rogerson, Artistic Director  
 Carol Ochs, Executive Director  
 John Sheehy, Director of Development and Marketing  
 George Babiak, Production Manager  
 Liz Bell, Director of Education  
 Megan Cramer, Associate Artistic Director  
 Diana Rojas, Associate Program Director  
 Josh Moody, Development Associate  
 Ray Harold, Technical Director  
 Lisa Kerner, General Management Associate  
 Chris Ceraso, Teen Dean  
 Nicole A. Watson, Teen Shakespeare Director  
 Iris A. Brown, Graphic Designer  
 Anna Gyorgy, Julia Lawler, Adam Levine, Interns  
 Teen Employees:

Samantha Caldon, Joyce Cheung, Carlos Dume, Emmett Goodman-Boyd, Alvin Garcia,  
 Raphael Irizarry, III, David McCall, Chloe Moore, Daquan Nelson, Tino Paduani, Luisa  
 Santiago, Viviana Vazquez, Malik Velazquez, Jorge Zapata  
 Michael Bannister, Azalea Rosario, Francis Williams, Ushers.

### "Friends Like These" Production Staff

#### Composer/Music Director

Cynthia Wong

#### Set Designer

Kevin Joseph Roach

#### Lighting Designer

Greg MacPherson

#### Costume Designer

Sarita Fellows

#### Sound Designer

Maileen Cancel

#### Stage Manager

Colleen Sherry

#### Projection Design:

George Babiak,  
 Julie Sharbutt, and the Project  
 Slide Archive

#### Prop Fabrication Team

George Babiak, Anna Gyorgy,  
 Julia Lawler, Adam Levine

#### Knitting Specialist

John Sheehy

#### Backstage Crew

Pedro Coen, Anna Gyorgy,  
 Julia Lawler, Adam Levine,  
 Rene Paul Santiago

#### House Managers

Liz Bell, Karin Schall

#### Chefs

John Sheehy, Liz Bell,  
 Carol Ochs



The Two-on-Two Program is made possible with public funds from The New York State Council on the Arts, a state agency; and the New York City Department of Cultural Affairs. The Project is a member of ART/NY.

### COOL STUFF ON SALE IN THE LOBBY!

NEW! Replay Scripts ..... \$10.00  
 Fabulous Flyer Bars ..... \$2.00 & \$3.00

and featuring Shel Silverstein's  
 "Fivey and Twoey" logo:

Project T-shirts ..... \$12.00  
 Project Hoodies ..... \$30.00  
 Project Caps ..... \$20.00  
 Project Mugs ..... \$5.00  
 Project Pencil 3-pack ..... \$1.00  
 Project Notebook ..... \$5.00

Thank you for coming to **FRIENDS LIKE THESE!** If you are not on our mailing list (or if your address has changed), please fill out this form and give it to us on your way out or mail it to the address below. We would also like to know if you are interested in becoming a volunteer. We need help in all areas, so be sure to fill out the entire form.

PLEASE ADD ME TO YOUR MAILING LIST:

1/11

NAME \_\_\_\_\_

ADDRESS \_\_\_\_\_

CITY \_\_\_\_\_

STATE \_\_\_\_\_

ZIP \_\_\_\_\_

HOME PHONE \_\_\_\_\_

DAYTIME OR MOBILE PHONE \_\_\_\_\_

E-MAIL ADDRESS \_\_\_\_\_

MY OCCUPATION \_\_\_\_\_

MY HOBBIES \_\_\_\_\_

YES, I WOULD LIKE TO BE OF HELP. I CAN:

- |   |  |  |
|---|--|--|
| <input type="checkbox"/> Draw and/or paint            | <input type="checkbox"/> Help kids with homework | <input type="checkbox"/> Teach kids a skill      |
| <input type="checkbox"/> Hang lights                  | <input type="checkbox"/> Help with mailings      | <input type="checkbox"/> Be a chef at an event   |
| <input type="checkbox"/> Work on a backstage crew     | <input type="checkbox"/> Do office work          | <input type="checkbox"/> Design and sew costumes |
| <input type="checkbox"/> Do graphic design            | <input type="checkbox"/> Design sound            |  |
| <input type="checkbox"/> Other (please specify) _____ |  |  |

MY SCHEDULE IS:

- Very flexible. I'm often available during weekdays.  
 Somewhat flexible. I can help on the occasional morning or afternoon during the week.  
 Not very flexible at all, but I've got some free time on evenings and weekends.

If you would like to mail this (and you're always welcome to enclose a tax-deductible contribution), you can send it to: The 52nd Street Project, 789 10th Ave., New York, NY 10019. Or fax it to (212) 333-5598.

DON'T MISS OUR UPCOMING EVENTS!

# WHADDAYA NEED?

**PLAYS MADE TO ORDER**

THE SPRING 2011 PLAYMAKING SHOWS

**APRIL 1-3, 2011**

**RIGHT HERE AT  
THE 52ND STREET PROJECT'S  
FIVE ANGELS THEATER**

This month, 10 brand-new Project kids began Playmaking classes with Megan Cramer.

Come see their final plays performed by professional adult actors!



HOST LEWIS BLACK AND THE 52ND STREET PROJECT BOARD OF DIRECTORS INVITE YOU TO POINT A FEW FINGERS AND SAVE THE DATE FOR ...

**HE STARTED IT!**

THE 52ND STREET PROJECT'S  
30TH ANNIVERSARY

A GALA CELEBRATION  
OF OUR FOUNDER

**WILLIE REALE**

MONDAY, MAY 9, 2011 AT

**ESPACE**

635 W. 42ND ST.  
BETWEEN 11TH AND 12TH AVENUES

**IT'S THE ANNUAL  
PROJECT BENEFIT!**



FOR INFORMATION AND RESERVATIONS, CONTACT JOHN 'IT WASN'T ME' SHEEHY  
AT (212) 333-5252 OR SHEEHY@52PROJECT.ORG



## WE ARE ON THE LOOK-OUT FOR INTERNS!

If you know any college or graduate students who might enjoy working with us for a semester please have them contact Lisa Kerner here at the Project. We are currently looking for interns for the summer of 2011. Thanks!

## The 52nd Street Project Board of Directors

Lisa Benavides	Carol Ochs
Rachel Chanoff	Willie Reale, founder
Cathy Dantchik	Gus Rogerson
Carolyn DeSena	Shirley Rumierk, alumni member
Wendy Ettinger, chair emeritus	José Soto, Jr., alumni member
Louis P. Friedman	Jenny Steingart
Robert Goldberg	Lisa Tilney
Stephen Graham, chair	Merritt Tilney
James McDaniel	Pamala Tyson
Frances McDormand	Wendy vanden Heuvel
Noël Mihalow	John A. Vassilaros

## What's Going On Here?

The 52nd Street Project is a non-profit organization that brings children from the Hell's Kitchen neighborhood together with professional theater artists to create original theater. FRIENDS LIKE THESE! is a production of our Two-on-Two's program, in which an adult playwright crafts a piece for a pair of Project kids to perform. Another adult directs the kids for a month that includes an intensive three-day weekend in upstate New York. Tonight's performance is the final result.

## In-Kind Contributions

The Murphy Law Office; Abbeville Press; Stephanie Berger Photography; Lewis Black; Richard Blackstone; Iris A. Brown Design; City Winery; William Curran & A Curran Affair; Kate Cusack; EMI Records; ICI; The S.F. Giants; Newman's Own; Macy's; Pharma Print; PineRock; The N; Shapiro Lobel, LLP; Wendy Stuhlberg; The Yankees; John A. Vassilaros; Watkins, Inc.; Mayor's Office of Film & Television; Boylan's Bottling Co.; Hudson Scenic; and Paul, Weiss, Rifkind, Wharton & Garrison LLP.

## Special Thanks

We owe many thanks to Maria Tucci, Robert Gottlieb & Nicky Gottlieb, Maggie Gray & Andrew Ross, Lili Taylor & Nick Flynn, all of whom graciously allowed us to use their upstate homes for three exhilarating and fun-filled days.

## FRIENDS LIKE THESE - ACT 1

All original music composed by Cynthia Wong

### DIAMOND DOG AND THE HURRICANE

Written by Jeff Cox

Directed by Howard Overshown

Diamond Dog.....Andy Reyes

The Hurricane..... Daquan Nelson

Caller..... George Babiak

*Morning Guys and Morning Guys Reprise* lyrics by Jeff Cox.

### 2020

Written by Adam Felber

Directed by Ian Hersey

Chloe.....Melissa Rebolledo

Frankie..... Raphael Irizarry, III

Zombies..... Crew

Major Baz Sturgeonson..... George Babiak

*The Last Stand* lyrics by Adam Felber.

### RALLY UNDERGROUND

Written by Janine Nabers

Directed by Donya Washington

Katie..... Lily Capstick

Dominique..... Zoe Keana Norris

Offstage Voice..... Julia Lawler

*Go Into the Light* lyrics by Janine Nabers.

## INTERMISSION



## FRIENDS LIKE THESE - ACT 2

### LEAVING US BEHIND

Written by Matthew Paul Olmos

Directed by Jeremy Johnson

Nigel..... Kyle Fargardo

Niles..... Alvin Garcia

Hecklers..... The Crew

*It's Not Going Very Well* lyrics by Matthew Paul Olmos.

### AMERICA'S NEXT TOP FLORIST

Written by Kim Rosenstock

Directed by Lisa Kerner

Violet..... Doris Alcantara

Poppy..... Elena Caballero

*I Listen to the Flowers, Why Me and I Listen to the Flowers Reprise* lyrics by Kim Rosenstock.

### HI-ZAP!: THE CHRONICLES OF CAROL AND BOB

Written by Larkin Clark

Directed by Erica Sullivan

Bob..... Tino Paduani

Carol..... Natalia Caballero

Supersensor 1& 2..... Anna Gyorgy

Police Chief's voice..... Rene Paul Santiago

Mayor..... Megan Cramer

Kidnappers..... George Babiak and Josh Moody

*Young Again* lyrics by Larkin Clark.

The 52nd Street Project gratefully acknowledges the support of the following foundations and corporations: BGC; Big Wood Foundation; Bloomberg; Brenner Family Foundation; Carnegie Corporation of New York; CBS Corporation; Consolidated Edison; Dawkins Family Foundation; The Neil V. DeSena Foundation; The Dramatists Guild Fund; Dramatists Play Service; Eleanor, Adam & Mel Dubin Foundation; The Educational Foundation Of America; Flexis Capital LLC; Sidney E. Frank Foundation; Fund for the City of New York; Goldman Sachs Gives; The Horace W. Goldsmith Foundation; Grant's Financial Publishing, Inc.; The William and Mary Greve Foundation; Heisman Foundation; The Henlopen Foundation; Hudson Scenic Studio; I. Weiss; Integra Realty; The Suzanne Nora Johnson & David G. Johnson Foundation; Lotos Foundation; Ann M. Martin Foundation; Monteforte Foundation; J.P. Morgan Charitable Trust; MTI; National Philanthropic Trust; NYFA; Punchline Magazine; Jonathan Rose Companies; The Shubert Organization; Simon & Eisenberg; St. Vincent De Paul Foundation; Harold & Mimi Steinberg Charitable Trust; Stranahan Foundation; Susquehanna Foundation, Corp.; Tax Pro Financial Network, Inc.; TCG; Theater Subdistrict Council; Theatre Communications Group, Inc.; Tiger Baron Foundation; United Real Estate Ventures, Inc.; Van Deusen Family Fund; Watkins, Inc.; WMEE Foundation; Yorke Construction Corp. In addition, the following individuals made gifts over \$250 to The 52nd Street Project this past year. (list current as of 4/1/11):

Robert Abrams & Cynthia Vance	Cathy Dantchik	John Kyles & Stefanie Kyles	Mike Shaheen
George Ackert	Leslie Dantchik	Michael P. Lawrence	Phil Shaheen
Michael Alicastro	Peter & Judith Dawkins	Warren Leight	Pam Shaw & Victor Syrmis
Jonathan Soros & Jennifer Soros	Russell Dodson	Adrienne Lobel & Mark Linn Baker	Kim Sherman & John Sheehy
Elton Andrews	Michael Dougherty	Susan Hess Lucier	Meg Simon
Richard Anthony	Brian Duggan & Carol Duggan	Thomas Lynch	Ravi Singh
Emily Armstrong	Rick Elliott	John Lyons	Brian Sklar
Dominick & Ilene Balletta	Nigel Faulkner & Amanda Faulkner	Frances McDormand & Joel Coen	Christopher Solomon
Ken Bantum	Peter Jay Fernandez & Denise Burse	Eric Mindich & Stacey Mindich	Steven Starker & Farrell Starker
Lisa Benavides & Tim Nelson	Michael Ferrara	Emily & John Morgan	Jenny & Jon Steingart
Eric Berman & Elizabeth Berman	Randy Frankel	Dexter Morse	Tracy Straus
David Beth	Alison Fraser & Nat Magee	Suzen Murakoshi & Mark Temme	Mike Szwajkowski
Lewis Black	Beverly Gasner	T.J. Nelligan	Jonathan Rose Companies, Inc.
Richard Blackstone & Yildez Yuksek	Alexandra Gersten & John Vassilaros	Randy & Rona Nelson	Anne Tilney & Douglas Kaden
Emily Blavatnik	Scott Aaron Gewirtz & Laura Gewirtz	Ruth Nelson	Liz Tuccillo
Michelle Bork & Jonathan Levine	Stephen & Cathy Graham	Cynthia Nixon	Gregory Tular
Liz Brixius	Jonathan Groff	Rachel & Larry Norton	Laura Valeroso & David Seidman
Becky Browder & Ted Neustadt	Jan Gura & Alan Pickman	Jodi Nuss	Wendy vanden Heuvel & Brad Coley
Brian Byrnes	David & Ann Hausmann	Kevin O'Rourke & Edith Thurber	Mary Pat Walsh
Shawn Byron & Laura Byron	Peter Herdrich & Karen Trott	Elizabeth Peters	Borah & Mildred Walton
Rich Cancro	Eric & Barbara Hippeau	Bat-Sheva & Thomas Peters	Scott Ward
Lawrence Catena	William Holtzman & S. Sylvia Shepard	Judy Goldman & Michael Pillinger	Sally & Lenny Weiss
Rachel Chanoff	Mary Horowitz	Stephanie Plouvis	Jane Bolster & Steve Wertimer
Nora Charles	Sarah Horowitz & David Venarde	Willie Reale & Jenny Gersten	Thomas Whatley
David Cohen & Sandra Novak Cohen	Andrea Johnson	Jacquelyn Reingold	Elizabeth Williams & Joseph Forte
Larry Cohen	Cindy Kaplan & David Froelich	James Rogan	John Willian & Suzanne Willian
Melissa Cohn	Kevin Kelly	David Ross & Laura Ross	J.P. Xenakis
Judith-Ann Corrente	Patrick Kelly & Diane Kelly	Carla Sacks & John Morris	Carole Yass & Randy Ginsburg
Janet Coviello	Ed Keslo	Christian Sauska	Jarrod Yuster

THE 52ND STREET PROJECT PRESENTS

WHADDAYA NEED?



ART BY BOB SHEA

PLAYS MADE TO ORDER  
THE SPRING 2011 PLAYMAKING SHOWS

PRESENTED AT THE 52ND STREET PROJECT'S  
**FIVE ANGELS THEATER**

FRIDAY, APRIL 1 @ 7:30 P.M., SATURDAY, APRIL 2 @ 3:00 P.M.  
SATURDAY, APRIL 2 @ 7:30 P.M., SUNDAY, APRIL 3 @ 3:00 P.M.

# WHADDAYA NEED? PLAYS MADE TO ORDER

The Spring 2011 Playmaking Production - April 1-3, Five Angels Theater

## The 52nd Street Project Staff

Gus Rogerson, Artistic Director  
Megan Cramer, Associate Artistic Director  
George Babiak, Production Manager  
Ray Harold, Technical Director

Carol Ochs, Executive Director  
Lisa Kerner, General Mgmt. Associate  
John Sheehy, Dir. of Development & Marketing  
Josh Moody, Development Associate

Liz Bell, Director of Education  
Diana Rojas, Associate Program Director

### Consultants:

Iris A. Brown, Graphic Designer; Chris Ceraso, Teen Dean;  
Nicole A. Watson, Teen Shakespeare Director

### Interns:

Julia Lawler, Adam Levine

### Teen Employees:

Doris Alcantara, Samantha Caldon, Joyce Cheung, Carlos Dume,  
Emmett Goodman-Boyd, Alvin Garcia, Raphael Irizarry III, David McCall, Terrence Mack,  
Chloe Moore, Tino Paduani, Azalea Rosario, Luisa Santiago, Malik Velazquez,  
Francis Williams, Jorge Zapata

Your ushers tonight: Michael Bannister, Daquan Nelson, and Viviana Vazquez.

## "Whaddaya Need?" Production Staff

Composer/Music Director  
Justin Poindexter

Set Designer  
Kevin Joseph Roach

Lighting Designers  
Greg MacPherson, Jay Scott,  
and Karim Badwan

Costume Designers  
Chloe Chapin, Kate Cusack

Sound Designer  
Betsy Rhodes

Stage Manager  
Erica Genreux Smith

Slide Design: George Babiak and the  
Project Slide Archive

Prop Design Team  
George Babiak, Liz Bell,  
Megan Cramer, Julia Lawler,  
Adam Levine, Lee Rosen, Maury Schott,  
Julie Sharbutt, John Sheehy

Backstage Crew  
Julia Lawler, Adam Levine,  
Leah Macuilt, Rory Scholl,  
Britney Trinidad

House Managers  
Liz Bell, Karin Schall

Flyer Art  
Bob Shea

Chefs  
John Sheehy, Liz Bell

Playmaking Class Volunteers  
Zachary Fine, Grant Harrison,  
Ruy Iskandar, Adam Levine,  
Nancy Noto, Ashley Marie Ortiz,  
Jeremy Rishe, Brielle Silvestri

Playmaking Class Assistant  
Chloe Moore

Weekend hosts:  
The Gersten-Vassilaros family,  
Laurie Becker, and Marie Rubin.



The Playmaking Program is made possible with public funds from The New York State Council on the Arts, a state agency; and the New York City Department of Cultural Affairs. The Project is a member of ART/NY.

## COOL STUFF ON SALE IN THE LOBBY!

REPLAY SCRIPT COLLECTION .....\$10.00  
FABULOUS FLYER BARS ..... \$2.00 & \$3.00

AND FEATURING SHEL SILVERSTEIN'S  
"FIVEY AND TWOEY" LOGO:

PROJECT T-SHIRTS.....\$12.00  
PROJECT HOODIES.....\$30.00  
PROJECT CAPS.....\$20.00  
PROJECT MUGS .....\$5.00  
PROJECT PENCIL 3-PACK .....\$1.00  
PROJECT NOTEBOOK.....\$5.00

Thank you for coming to **WHADDAYA NEED?!** If you are not on our mailing list (or if your address has changed), please fill out this form and give it to us on your way out or mail it to the address below. We would also like to know if you are interested in becoming a volunteer. We need help in all areas, so be sure to fill out the entire form.

PLEASE ADD ME TO YOUR MAILING LIST:

3/11

NAME

ADDRESS

CITY

STATE

ZIP

HOME PHONE

DAYTIME OR MOBILE PHONE

E-MAIL ADDRESS

MY OCCUPATION

MY HOBBIES

YES, I WOULD LIKE TO BE OF HELP. I CAN:

- |   |  |  |
|---|--|--|
| <input type="checkbox"/> Draw and/or paint            | <input type="checkbox"/> Help kids with homework |  |
| <input type="checkbox"/> Hang lights                  | <input type="checkbox"/> Help with mailings      | <input type="checkbox"/> Teach kids a skill      |
| <input type="checkbox"/> Work on a backstage crew     | <input type="checkbox"/> Do office work          | <input type="checkbox"/> Be a chef at an event   |
| <input type="checkbox"/> Do graphic design            | <input type="checkbox"/> Design sound            | <input type="checkbox"/> Design and sew costumes |
| <input type="checkbox"/> Other (please specify) _____ |  |  |

MY SCHEDULE IS:

- Very flexible. I'm often available during weekdays.
- Somewhat flexible. I can help on the occasional morning or afternoon during the week.
- Not very flexible at all, but I've got some free time on evenings and weekends.

If you would like to mail this (and you're always welcome to enclose a tax-deductible contribution), you can send it to: The 52nd Street Project, 789 10th Ave., New York, NY 10019. Or fax it to (212) 333-5598.

## COMING UP AT THE 52ND STREET PROJECT

Come see the start of a brand-new Project program featuring 6 short original dances choreographed by kids and performed by kids and adults

A free one-hour performance on **Monday, April 11 at 6:00 p.m.** right here at **The Five Angels**.



# Dancemaking

*The 52nd Street Project 2011 Inaugural Dance Concert*

HOST LEWIS BLACK AND THE 52ND STREET PROJECT BOARD OF DIRECTORS INVITE YOU TO POINT A FEW FINGERS AND SAVE THE DATE FOR ...

HE STARTED IT!

THE 52ND STREET PROJECT'S  
30TH ANNIVERSARY

A GALA CELEBRATION  
OF OUR FOUNDER

**WILLIE REALE**

MONDAY, MAY 9, 2011 AT

**ESPACE**

635 W. 42ND ST.

BETWEEN 11TH AND 12TH AVENUES

IT'S THE ANNUAL  
PROJECT BENEFIT!

FOR INFORMATION AND RESERVATIONS, CONTACT JOHN "IT WASN'T ME" SHEEHY  
AT (212) 333-5252 OR SHEEHY@52PROJECT.ORG



### WE ARE ON THE LOOK-OUT FOR INTERNS!

If you know any college or graduate students who might enjoy working with us for a semester please have them contact Lisa Kerner here at the Project. We are currently looking for interns for the Fall of 2011. Thanks!

### The 52nd Street Project Board of Directors

Lisa Benavides	Carol Ochs
Rachel Chanoff	Willie Reale, founder
Cathy Dantchik	Gus Rogerson
Carolyn DeSena	Shirley Rumierk, alumni member
Wendy Ettinger, chair emeritus	José Soto, Jr., alumni member
Louis P. Friedman	Jenny Steingart
Robert Goldberg	Lisa Tilney
Stephen Graham, chair	Merritt Tilney
James McDaniel	Pamala Tyson
Frances McDormand	Wendy vanden Heuvel
Noël Mihalow	John A. Vassilaros

### What's Going On Here?

The 52nd Street Project is a non-profit organization that brings children from the Hell's Kitchen neighborhood together with professional theater artists to create original theater. WHADDAYA NEED? is a production of our Playmaking program. Young people participate in a nine-week playwriting course taught by Megan Cramer and adapted for the Project by Daniel Judah Sklar from his book *Playmaking: Children Writing and Performing Their Own Plays*. At the end of the course, each child is given two actors, a theme, and a dramaturge/director who guides him or her through the writing of a play during a weekend retreat in the country (Bridgehampton for this show). Tonight's performance is the end result.

### In-Kind Contributions

Abbeville Press; Stephanie Berger Photography; Iris A. Brown Design; Kenneth Cole Productions; William Curran & A Curran Affair; ICI; Newman's Own; Noggin/The N; Paris Chocolates; Pharma Print/Omni Graphics; Sesame Workshop; Wendy Stuhlberg; John A. Vassilaros; Watkins, Inc.; Mayor's Office of Film & Television; Ron Fiorina and Boylan's Bottling Co.; Shapiro & Lobel; Hudson Scenic; Prime Films, and Paul, Weiss, Rifkind, Wharton & Garrison LLP. , Empanada Mama's, Fat Sal's Pizza, Mitchell London Foods, Wendy Stuhlberg, Steve Olsen and the Westbank Cafe, and Mary Pat Walsh.

### Special Thanks

We're extremely grateful to John Vassilaros, Alex Gersten-Vassilaros, their boys Tonio, Luka and Stefano, the ever-helpful Joyce, and Zeus the dog for allowing us to use their home as our headquarters and boy dormitory on our Playmaking retreat to Bridgehampton last month. We also owe gratitude to Laurie Becker, who let some volunteers and the girl writers crash at her luxurious pad in Sag Harbor, and Marie Rubin who hosted two dramaturges.

## WHADDAYA NEED? - ACT 1

All original music composed by Justin Poindexter

### THE BEGINNING

Written by Julissa Peralta, age 12.

Director/Dramaturge: Lisa Rothe.

Rosy ..... Susan Pourfar

Cali ..... Amelia Campbell

*Sister Song* lyrics by Julissa Peralta.

### EXPERIMENT 999 IS ALIVE

Written by Justin Bannister, age 9.

Director/Dramaturge: George Babiak.

Flash ..... Raul Castillo

Experiment 999 ..... Dominic Comperatore

People on Sidewalk ..... Crew

The Owner ..... Rory Scholl

Ms. Crazy ..... Megan Cramer

*Out of the Lab* and *Sorry, Experiment 999* lyrics by Justin Bannister.

### ALEXANDER VS. THE PHOENIX

Written by Martin Sanchez, age 12.

Director/Dramaturge: Gus Rogerson.

Alexander ..... Debargo Sanyal

Queen Phoenix ..... Alexandra Metz

### THE HAUNTED MANSION

Written by Siara Feliciano, age 11.

Director/Dramaturge: Tasha Gordon-Solmon.

Drake Goldsworthy ..... Catherine Mueller

Kate Miller ..... Ashley Marie Ortiz

### BUTTOX SHOW

Written by Edwin Rodriguez, age 10.

Director/Dramaturge: Michael Walkup.

Buttwarby ..... Michael Chernus

Jackie Buttoxin ..... Kathy Hiler

Feets ..... Crew

*The Jackie Song*, and *Hot Sauce* lyrics by Edwin Rodriguez.

## WHADDAYA NEED? - ACT 2

### TWO WONDERFUL COPS

Written by Jade Cuevas, age 10.

Director/Dramaturge: Zachary Fine.

Ashley ..... Cecilia Arana

Jerry Lee ..... Ezra Knight

Old Lady ..... Megan Cramer

Man ..... George Babiak

Robber ..... Rory Scholl

*I Hate Old People* and *Bad People are Terrible* lyrics by Jade Cuevas.

### THE DEAD MAN

Written by Alex Malan, age 9.

Director/ Dramaturge: Kel Haney.

Dane ..... Betsy Aidem

Lief ..... Ruy Iskandar

Wolf ..... Adam Levine

Dead Man ..... George Babiak

Toll Booth Attendant ..... Leah Macuilt

### EVIL PUPPET DOG

Written by Amber Urena, age 10.

Director/Dramaturge: Liz Tuccillo.

Elizabeth de Frenche ..... Nikiya Mathis

Tushito ..... Neal Bledsoe

*Our Relationship* lyrics by Amber Urena.

### READY OR NOT

Written by Daniel Martinez, age 10.

Dramaturge: Jeremy Keaveny/ Director: James Yaegashi

Mick ..... Maxon Davis

Grandpa ..... Greg Keller

Computer ..... Rory Scholl

Bully ..... Adam Levine

Crowd ..... Crew

### TOGETHER

Written by Valeria Oliva, age 10.

Dramaturge: Lisa Kerner/ Director: Florencia Lozano.

Looky ..... Amirah Vann

Nick ..... Danyon Davis

*Dear Diary*, *Friends*, and *Together* lyrics by Valeria Oliva

## The 52nd Street Project Board of Directors

Lisa Benavides  
Rachel Chanoff  
Cathy Dantchik  
Carolyn DeSena  
Wendy Ettinger,  
*Chair Emeritus*  
Louis P. Friedman  
Robert Goldberg  
Stephen Graham, *Chair*  
James McDaniel  
Frances McDormand  
Noël Mihalow  
Carol Ochs

Willie Reale,  
*founder*  
Gus Rogerson  
Shirley Rumierk,  
*alumni member*  
José Soto, Jr.,  
*alumni member*  
Jenny Steingart  
Lisa Tilney  
Merritt Tilney  
Pamala Tyson  
Wendy vanden Heuvel  
John A. Vassilaros

## The 52nd Street Project Staff

Gus Rogerson, Artistic Director  
Megan Cramer, Associate Artistic Director  
George Babiak, Production Manager  
Ray Harold, Technical Director  
Carol Ochs, Executive Director  
Lisa Kerner, General Mgmt. Associate  
John Sheehy, Dir. of Development & Marketing  
Josh Moody, Development Associate  
Liz Bell, Director of Education  
Diana Rojas, Associate Program Director

### Consultants:

Iris A. Brown, Graphic Designer; Chris Ceraso, Teen Dean;  
Nicole A. Watson, Teen Shakespeare Director

### Interns:

Julia Lawler, Adam Levine

### Teen Employees:

Doris Alcantara, Michael Bannister, Samantha Caldon, Joyce Cheung, Carlos Dume,  
Emmett Goodman-Boyd, Alvin Garcia, Raphael Irizarry III, David McCall, Terrence Mack,  
Chloe Moore, Daquan Nelson, Tino Paduani, Azalea Rosario, Luisa Santiago,  
Viviana Vazquez, Malik Velazquez, Francis Williams, Jorge Zapata

## Benefit Volunteers

Katherine Brown, Dylan Dawson, Katie Flahive, Lee Rosen,  
Flor De Liz Perez, Christopher Randolph,  
Kim D. Sherman, Vanessa Valdes

## Special Thanks

Becky Browder, Michael Dorf, Terry Fitzpatrick, Katie Flahive,  
Jenny Gersten, Graeme Gillis, Jessalyn Gilsig, Emily Grishman,  
Mark Jacobs, Lisa Leguillou, Daniel Levy, Josh Lewis, Marshall  
Neilson, Steve Olsen, Willie Reale, Adam Platt, Oliver Platt, Karin  
& Tom Schall, Rory Scholl, Mary Pat Walsh

# HE STARTED IT!

The  
52nd Street  
Project's  
30th  
Anniversary  
Gala



Celebrating  
Founder  
Willie Reale

Monday,  
May 9,  
2011



## Spring Sing Thing Benefit Co-Chairs

Lisa Benavides	Karin Schall
Cathy Dantchik	Jenny Steingart
Carolyn DeSena	Merritt Tilney
Louis P. Friedman	Laura Valeroso
Patrice Friedman	Mary Pat Walsh

## Starter Seats

Jen & Anton Anikst	Sonia Manzano & Richard Reagan
Aon	Jodie Markell
Cecilia Arana	Yvette McLarty
Emily Armstrong & Thomas P. Gannon	Tanya Melich
June Ballinger & Michael Goldstein	Emily & John Morgan
Becky Ann & Dylan Baker	Suzen Murakoshi & Mark Temme
Tosh & Tom Barron	Patricia Murphy & Adam Spilka
Beth & Eric Berman	Carol Ochs & Bruce MacVittie
Stephen Bernstein	Jacki Ochs & Jan Kroeze
Mark Blum	F. Richard Pappas
Jane Bolster & Steve Wertimer	Leigh Pennebaker & Taro Alexander
Buzz Bovshow	Sue Phillips
Becky Browder & Ted Neustadt	Gina & James Pickens, Jr.
Iris Brown, Joe White &	Judy & Michael Pillinger
Walker White	Christopher Randolph
Chris Ceraso	Anita A. Rogerson
John D. Clarke	Ellen B. Rudolph
Elizabeth Clemants	Carla Sacks & John Morris
Maddie Corman & Jace Alexander	Laura Sametz & Anton Fig
Catherine Corpeny & Max D. Mayer	Joan Stein Schimke
Chas Cowing	Maury Schott
Elizabeth & John Doble	Lisa & Michael Schultz
Rebecca & Richard Dresser	Robert Shaffron & John Steber
Ned Eisenberg	Sylvia Shepard & Willy Holtzman
Lynn Ellenberg	Michael Shuman
Liz Flahive & Jeff Cox	Lois Smith
Alison Fraser	Liza Steinberg-Demby
Sally Froelich	Marjorie & Michael Stern
Nancy Giles	Susanna Styron
Jilian Cahan Gersten &	Edith Thurber & Kevin O'Rourke
Brian Shuman	Lisa Tilney & Chris Lawrence
Lisa J. Gugenheim &	Erin Torneo & Sascha Paladino
Lawrence Nathanson	Karen Trott & Peter Herdrich
Jan Gura & Alan Pickman	Liz Tuccillo
Jessica Hecht & Adam Bernstein	Laura Valeroso
Beth Ifcher	Susan J. Vitucci
Dana Ivey	Teri & Barry Volpert
Valerie Kay & Bruce Graham	Mary Pat Walsh
Sheila Kehoe	Jennifer Dorr White & John C. Eisner
Joyce Krawiecki	Lee Wilkof
Judy Kuhn & David Schwab	WME2
Jennifer Lerner	Carole Yass
Liza Lerner	Yildiz Yuksek & Richard Blackstone
Ilana Levine, Dominic Fumusa &	Connie & Marc Zand
Georgia Fumusa	Blake Zidell

## The 52nd Street Project gratefully acknowledges...

Abbeville Press  
Richard Blackstone  
Brooklyn Fare  
Iris A. Brown Design  
City Winery  
William Curran,  
A Curran Affair  
Drive 495  
HBO and Howard Korder  
Bill Lawrence, S.F. Giants  
Noël Mihalow and PineRock  
Steve Olsen, Westbank Cafe  
Pharma/Omni Printing  
Martha Plimpton  
Sesame Workshop  
Shapiro Lobel, LLP  
Wendy Stuhlberg  
Merritt Tilney & Douglas Kaden  
John A. Vassilaros & Sons  
Mary Pat Walsh  
Watkins Incorporated  
Healthier Living Since 1868  
Yorke Construction

## Onset Seats

Gavin Berger & Craig Berggren  
Elizabeth & Alexander Bernstein  
Allison Blinken  
Blaise R. Box  
Polly Brandmeyer  
Patrick Breen  
Tate Donovan  
Kay & Frank Gayner-Wood  
Jenny Gersten & Willie Reale  
Laura & Scott Gewirtz  
Kimberly Grigsby  
Emily Grishman & Susan Sampliner  
Jane & Michael Hoffman  
Sarah Horowitz & David Venarde  
Alexandra & Philip Howard  
Cynthia Kaplan & David Froelich  
Shari Kirshner  
Kate Lear & Jonathan LaPook  
Martin Levine, The Par Group  
Adrienne Lobel  
Marjorie & Michael Loeb  
Jo Anne & Mark Lonow  
Steve Olsen  
Jane Perlmutter & Greg MacPherson  
Suzanne Poulin  
Helaine & Michael Pruzan  
Helen & Peter Randolph  
Joe Robertson  
Daryl & Steven Roth  
Karin & Thomas Schall  
Whitney Scott & Peter Jacobson  
Marilyn Sterrenberg-Rose  
Richard Sweren  
Cynthia Vance & Robert Abrams  
I. Weiss  
Dana L. Williams & Donald Scardino

Carol Ochs,  
Executive Director

Stephen Graham,  
Board Chair

Gus Rogerson,  
Artistic Director

# He Started It

The 52nd Street Project's 30th Anniversary Gala  
Celebrating Founder Willie Reale

Monday, May 9, 2011  
Espace

## The Show

### Host

Lewis Black  
(with Frances McDormand, Jose Soto, and Willie Reale)

### The Lyricists

Nicholas Carrero, Edelys Tiana Guerrero,  
Genesis Hires, Haley Zoe Martinez, Malik Velazquez

### The Composers

Bela Fleck, J. Michael Friedman, Henry Krieger,  
Rob Reale, Duncan Sheik

### The Singers

Lisa Benavides, Renee Elise Goldsberry, Christopher Fitzgerald,  
Tim Blake Nelson, Duncan Sheik, Abigail Washburn

### Back-Up Singers

Hannah Sielatycki & Timothy Young

### The Musicians

Charlie Alterman, Piano  
Thad DeBrock, Guitar  
Ethan Eubanks, Drums

### Director

Jonathan Bernstein

### Music Director

Charlie Alterman

### Music Coordinator

Kim D. Sherman

### Lighting Designer

Greg MacPherson

### Sound Designer

Scott Lehrer

### Set Design

George Babiak

### Stage Manager

Colleen Sherry

### Written by

John Sheehy

## 30 Is Not Old

By Edelys Tiana Guerrero, age 10  
Composed by J. Michael Friedman  
Performed by Lisa Benavides & Tim Blake Nelson

**BOY:** HEY KIDS  
HAVE YOUR PARENTS TOLD YOU  
THAT THEY WERE 30  
AND YOU SAY THAT WAS OLD?

**GIRL:** HEY PARENTS  
HAVE YOUR KIDS TOLD YOU  
THAT 30 WAS OLD?

**BOY & GIRL:** IF YOU SAID NO  
THEN THIS IS NOT THE SONG FOR YOU

**GIRL:** PARENTS, DO NOT BELIEVE  
YOUR KIDS WHEN THEY SAY  
YOU ARE OLD  
WHEN YOU TELL THEM YOU'RE 30

**BOY:** KIDS, DON'T TELL YOUR PARENTS  
THEY'RE OLD

**GIRL:** PARENTS,  
YOUR KIDS ARE SAYING  
THINGS THAT ARE IN THEIR MINDS

**BOY:** KIDS, DON'T LISTEN  
TO YOUR MIND  
BECAUSE

**BOY & GIRL:** 30 IS NOT OLD!

**BOY:** YOUR PARENTS  
CAN DO THE THINGS YOU DO  
BECAUSE

**BOY & GIRL:** 30 IS NOT OLD

**GIRL:** YOUR PARENTS  
CAN RIDE A SCOOTER

**BOY:** YOUR PARENTS  
CAN BUY 100 DOGS

**GIRL:** YOUR PARENTS  
CAN WATCH TV ALL DAY

**BOY:** YOUR PARENTS  
CAN PLAY WITH THE WII

**BOY & GIRL:** THEY CAN KNOCK YOU  
OUT OF BEING A KID  
BECAUSE THEY CAN DO STUFF  
BETTER THAN YOU.  
BECAUSE THEY WERE A KID ONCE TOO

**GIRL:** THEY REMEMBER BEING A KID

**BOY:** AND YOU

**GIRL:** YOU YOU YOU

**BOY:** ARE LUCKY TO BE A KID

**BOY & GIRL:** BECAUSE

**GIRL:** YOUR PARENTS  
HAVE TO GO TO WORK

**BOY:** THEY PAY BILLS

**GIRL:** THEY GET YOU TOYS

**BOY & GIRL:** THEY GET YOU  
ANYTHING YOU WANT  
SO YOU SHOULD THANK THEM OF  
WHAT THEY DO

**BOY:** BECAUSE...

**GIRL:** THEY BROUGHT YOU  
TO THIS WORLD

**BOY:** SO EVERY TIME YOUR PARENTS  
DO SOMETHING NICE  
SAY THANK YOU

**GIRL:** FOR EVERYTHING THEY DO

**BOY & GIRL:** BUT REMEMBER THAT  
30 IS NOT OLD!  
NO, 30 IS NOT OLD!  
NO, 30 IS NOT OLD!

## Founding Tables

The Dantchik Family  
Cathy & Stephen Graham  
Jenny & Jon Steingart

## Establishing Tables

Patrice & Louis Friedman  
Betsy MacIsaac & Robert Goldberg,  
Yorke Construction Corporation  
Fred Nelson

## Drawing Board Tables

Blavatnik Family  
Freddie Gershon, Music Theater International  
Laura & David Ross  
Suehnholz Family  
Tiger Baron Foundation  
Gregory Tusar

## Beginning Tables

Denise Burse Fernandez & Peter Jay Fernandez  
CBS Corporation  
Dawkins Family Foundation  
Carolyn & Neil DeSena  
Wendy Ettinger & Derek McLane  
Terry Fitzpatrick, Sesame Workshop  
Bev Gasner  
Alexandra Gersten-Vassilaros & John Vassilaros  
Mrs. Saul Horowitz, Jr.  
Frances, Joel & Pedro McCoen  
Rona & Randolph Nelson  
Ruth Nelson  
Steve Sabba, Tax Pro Financial Network, Inc.  
Wendy vanden Heuvel & Brad Coley

## Life is Like a Roller Coaster

By Haley Zoe Martinez, age 13  
Composed and performed by Duncan Sheik

HE STARTED SOMETHING ...  
A BRAND NEW PATH  
IT MAY LEAD TO SOMETHING NEW, A NEW FRIEND,  
A BRAND NEW START

HE STARTED SOMETHING  
A BRAND NEW LIFE  
THIS CAN HAPPEN IF YOU LIVE LIFE NOW  
AND NEVER BACK DOWN

LIFE IS LIKE A ROLLER COASTER  
BUT THE RIDE IS NOT SO LONG  
WHEN YOU GET ON, YOU HAVE TO CHOOSE  
WILL YOU RIDE IT RIGHT OR WRONG?

LIFE MAY HAVE A TOUGH BEGINNING  
YOU MAY CARRY A HEAVY LOAD  
THERE MAY BE TERRIBLE TIMES - THE PATH IS HARD TO FIND  
BUT YOU MAY FIND THE YELLOW BRICK ROAD

THIS ROLLER COASTER OF A LIFE,  
TAKES A LOT OF GUTS  
YOU NEVER KNOW WHAT'S GOING TO HAPPEN GOING UP  
AND COMING DOWN IS PRETTY NUTS

LIFE IS LIKE A ROLLER COASTER  
IT GOES AROUND AROUND MANY TIMES  
YOU CAN ALWAYS START YOUR LIFE OVER  
IF YOU MAKE UP YOUR MIND

YES, LIFE IS LIKE A ROLLER COASTER  
THOSE CLIMBS SEEM LIKE FOREVER  
BUT HEADING DOWN TAKES NO TIME AT ALL  
AS THE WEIGHT LIFTS OFF YOUR SHOULDER

HE STARTED SOMETHING NEW  
WENT THROUGH A NEW DOOR  
HE ACCOMPLISHED HIS GOAL ... AND SO MUCH MORE ...

## Problem Blues

Lyrics by Nicholas Carrero, age 12  
Composed by Bela Fleck and  
Performed by Bela Fleck and Abigail Washburn

SO MANY PROBLEMS  
THAT YOU HAVE TO FIGURE OUT  
TO ME IT'S CRAPPY  
IT MAKES ME WANT TO SHOUT  
I HAVEN'T FOUND THE SOLUTION

FRIENDS ALWAYS FIGHT  
BUT HEAR EACH OTHER OUT  
COOPERATE AND  
DON'T SIT THERE AND POUT

BAD GRADES RUIN YOUR CHANCES  
IN YOUR LIFE  
SO STUDY REALLY HARD  
AND PAY ATTENTION A LOT

SO MANY PROBLEMS BUT  
I'VE DISCOVERED A SOLUTION  
SO NEVER GIVE UP  
DEPEND ON YOURSELF  
BE INDEPENDENT

SIXTEEN AND PREGNANT  
THAT'S WHAT I WON'T BE  
'CAUSE I'LL BE SAFE  
AND NOT HAVE A BABY

SO GIRLS HAVE COMMON SENSE  
BUILD YOURSELF A FENCE  
PROTECT YOURSELF  
AND THINK BEFORE YOU ACT

PEOPLE ARE ON DRUGS  
'CAUSE THEY DON'T GET HUGS  
BUT PERSONALLY I GOT  
MY MOMMA TO HUG ME

THEY LOST THEIR CHANCES  
IN THEIR LIFE  
SO GO TO REHAB  
FOR MORE THAN JUST ONE NIGHT

THERE'S ALWAYS A SOLUTION  
SO NEVER GIVE UP  
BELIEVE IN YOURSELF  
AND HAVE NO DOUBT  
STAND STRAIGHT AND TALL  
IF YOU HAVE THE PRIDE  
TO STAND THERE AT ALL

## Starting From Scratch

Lyrics by Genesis Hires, age 10

Composed by Henry Krieger

Performed by Renee Elise Goldsberry

SOMETIMES THE HARD STEPS ARE AT THE BEGINNING  
TAKING A RISK IS THE SAME THING AS WINNING  
MAYBE YOU'LL FALL AND MAYBE YOU'LL SHINE  
BUT NO MATTER WHAT  
IN THE END YOU'LL BE FINE

FITTING IN IS PRETTY HARD  
PEOPLE DON'T KNOW WHO YOU ARE  
YOU DON'T KNOW WHY  
YOU'RE SO SHY  
BUT NOW YOU WANT TO LEAVE  
AND SAY GOODBYE

YOU TRY TO RUN REALLY FAR  
'CAUSE YOU DON'T KNOW WHO THEY ARE  
WHEN YOU TRY TO TALK TO THEM  
YOU JUST CAN'T  
THEN YOU SUDDENLY FEEL  
WET AND DAMP

SOMETIMES THE HARD STEPS ARE AT THE BEGINNING  
TAKING A RISK IS THE SAME THING AS WINNING  
MAYBE YOU'LL FALL AND MAYBE YOU'LL SHINE  
BUT NO MATTER WHAT  
IN THE END YOU'LL BE FINE

IT'S STUCK IN MY HEAD  
I DREAM IT IN BED  
I WANNA KNOW IF THEY LIKE ME

JUST WAIT AND SEE  
THEY'RE ALWAYS STARING AT ME  
I JUST WANNA KNOW WHAT THEY THINK OF ME

I FEEL KIND OF SHY  
I WISH I KNEW WHY  
PLEASE PLEASE PLEASE TELL ME WHY

SOMETIMES THE HARD STEPS ARE AT THE BEGINNING.  
TAKING A RISK IS THE SAME THING AS WINNING.  
MAYBE YOU'LL FALL AND MAYBE YOU'LL SHINE  
BUT NO MATTER WHAT  
IN THE END YOU'LL BE FINE

SO I TRIED TO TALK AND IT WENT WELL  
I'M SO HAPPY  
I CAN SCREAM AND YELL  
BUT NOW I KNOW  
NEXT TIME DON'T BE SHY  
AND YOU'LL SHINE

## The Unstoppable Project

Lyrics by Malik Velazquez, age 15

Composed by Rob Reale

Performed by Christopher Fitzgerald

Back-up singers: Hannah Sielatycki and

WALKING THROUGH THE CITY THERE'S  
NEW BUILDINGS EVERYWHERE  
ONE OF THOSE NEW BUILDINGS IS  
RIGHT UNDER YOUR CHAIR  
I'M BEING DEAD SERIOUS,  
SO LOOK UNDER RIGHT NOW  
NOW THAT YOU SEE IT,  
I BET YOU'RE HAVING A COW

WE WERE ONCE IN A SMALL BUILDING,  
BUT CHANGE HAS US MOVING ALONG  
WE MAY BE RISING UP TO THE SKY,  
BUT OUR FOUNDATION IS STRONG  
OUR PROJECT IS UNSTOPPABLE,  
WE'VE BEEN HERE SO LONG  
THIS IS WHAT I'M TRYING TO SAY  
I'M SINGING THIS SONG

THE UNSTOPPABLE PROJECT  
THE 52ND STREET PROJECT  
THE THING THAT WILL NEVER ENNNND  
IT'S SPREAD AROUND  
FROM FRIEND TO FRIEND  
IT'S IMMORTAL IN THE END  
WILLIE FOUND IT  
AND HE'S NO FOOL  
A DEED WE MUST COMMEND

HIS PROJECT  
OUR JEWEL  
WE LOVE IT  
IT'S COOL  
IT'S FUN FOR LADIES AND GENTS

LOOKING AT THE CITY THERE'S  
UNIQUENESS EVERYWHERE  
THERE'S GREENS AND BLUES AND  
REDS STREAKED INTO PEOPLE'S HAIR  
JUST LIKE AT THE PROJECT, PEOPLE  
ARE DIFFERENT; WE DON'T CARE  
WE KNOW IT'S SAFE, DON'T ALIENATE  
AND ALWAYS BE FAIR

WHEN YOU'RE AT THE PROJECT  
YOU'RE PART OF HISTORY  
I THINK OF THE PROJECT  
AS A HUGE COMMUNITY  
LIVING IN THE CITY,  
WHAT AN OPPORTUNITY  
LIKE HERE AT THE PROJECT,  
THEY'LL HELP YOU GET YOUR DEGREE

THE UNSTOPPABLE PROJECT  
THE 52ND STREET PROJECT  
THE THING THAT WILL NEVER ENNNND  
IT'S SPREAD AROUND  
FROM FRIEND TO FRIEND  
IT'S IMMORTAL IN THE END  
WILLIE FOUND IT  
AND WE'LL KEEP IT SAFE  
JUST LIKE A VAULT IN THE BANK

HIS PROJECT, OUR JEWEL  
WE LOVE IT, IT'S COOL  
ITS FUN FOR LADIES AND GENTS

HIS PROJECT, OUR JEWEL  
WE LOVE IT, IT'S COOL  
SO HAVE FUN LADIES AND GENTS

HIS PROJECT, OUR JEWEL  
WE LOVE IT, IT'S COOL  
IT'S FUN FOR LADIES AND GENTS

The 52nd Street Project proudly presents  
**The “Stage Combat!” Program’s Final Performance**

Friday, June 17<sup>th</sup>, 6:00 p.m.

This program was led by leading Broadway and Off-Broadway fight choreographer and long-time Project volunteer Tom Schall.

**Mad To The Max**

Written by Maximo Jimenez, age 12

Directed by Josh Moody

Chris.....Maximo Jimenez

Blaze.....Josh Moody

**The Ghetto Teaches You**

Written by Breanna Straker, age 15

Directed by Becky White

Latasha.....Breanna Straker

Lessie.....Becky White

**Win Or Lose?**

Written by Britney Trinidad, age 12

Directed by Ginny Lee

Karen Martinez.....Britney Trinidad

Amy Hernandez.....Ginny Lee

Referee.....George Babiak

Coaches.....Chris Bachand/Jacob Grigolia-Rosenbaum

Karen’s Younger Brothers.....Maximo Jimenez/Josh Moody

Amy’s Mom.....Nathalie Martin

**Brown Paper Bag**

Written by Marcus Quinones, age 15

Directed by Jacob Grigolia-Rosenbaum

Tyrek J. Marley.....Marcus Quinones

Bob J. Marley.....Jacob Grigolia-Rosenbaum

**The Disagreement ≠ Fish And Chips**

Written by Elizabeth Vazquez, age 14

Directed by Natalie Martin

Queen Shaba Alaba Beautiful Petushka.....Elizabeth Vazquez

Lulu Lacross.....Natalie Martin

**Champions**

Written by Michael Bannister, age 14

Directed by Chris Bachand

Michaelangelo.....Michael Bannister

Brock.....Chris Bachand

The 52nd Street Project is a non-profit organization that brings children from the Hell's Kitchen neighborhood together with professional theater artists to create original theater. The Replay program gives children who are graduates of the Project's Playmaking class a chance to hone their skills in an advanced writing workshop taught by Megan Cramer. Over the nine weeks of Replay class, these young playwrights explored varied sources of inspiration, studied dramatic structure, and learned to embrace their own personal writing style. The resulting plays are featured in tonight's reading.

### Special Thanks

The plays wouldn't have made it to the page without the help of these Replay class volunteers: Jessica Almasy, Robert Askins, Julia Lawler, Adam Levine, Beto O'Byrne, Christopher O. Pena, Susan Pourfar, Michael Propster, Rachel Rusch, Emily Simoness, and Melisa Tien. Thank you also to Elliot Villar, Bhavesh Patel, and the cast of "War Horse," whose performances we adored, and who patiently and graciously answered all of our questions! We'd especially like to thank the Cohen family and friends for their support of Replay.

### The 52nd Street Project Staff

Gus Rogerson, Artistic Director	Carol Ochs, Executive Director
Megan Cramer, Associate Artistic Director	Lisa Kerner, General Mgmt. Associate
George Babiak, Production Manager	John Sheehy, Dir. of Development & Marketing
Ray Harold, Technical Director	Josh Moody, Development Associate
Liz Bell, Director of Education	
Diana Rojas, Associate Program Director	

### Consultants:

Iris A. Brown, Graphic Designer; Chris Ceraso, Teen Dean;  
Nicole A. Watson, Teen Shakespeare Director

### Interns:

Jordana De La Cruz, Emma Miller, Ben Vigil

### Teen Employees:

Doris Alcantara, Samantha Caldonga, Joyce Cheung, Carlos Dume, Emmett Goodman-Boyd, Alvin Garcia, Raphael Irizarry III, David McCall, Terrence Mack, Chloe Moore, Tino Paduani, Azalea Rosario, Luisa Santiago, Malik Velazquez, Francis Williams, Jorge Zapata.

Your ushers tonight: Ralph Irizarry III and Daquan Nelson.

### The 52nd Street Project Staff

Lisa Benavides	Carol Ochs
Rachel Chanoff	Willie Reale, <i>founder</i>
Cathy Dantchik	Gus Rogerson
Carolyn C. DeSena	Shirley Rumierk, <i>alumni member</i>
Wendy Ettinger, <i>chair emeritus</i>	José Soto, Jr., <i>alumni member</i>
Louis P. Friedman	Jenny Steingart
Stephen Graham, chair	Lisa Tilney
James McDaniel	Merritt Tilney
Frances McDormand	Pamala Tyson
Noël Mihalow	Wendy vanden Heuvel
	John A. Vassilaros

The 52nd Street Project Presents  
The 2011 Lorraine Cohen

# Replay Readings

12 new plays by  
12 young playwrights

Monday, June 13, 2011  
7:30 p.m.

The Five Angels Theater  
The 52nd Street Project  
789 10th Avenue

## The Criminal That Went Good!

by Kaitlin Feliciano, age 10. Directed by Michael Potts.

Superhero..... Pascale Armand  
Criminal ..... Patrice Johnson

## Blue Monkey

by Brandon Draude, age 11. Directed by David Costabile.

Scown..... Peter Dinklage  
A.I..... Bill Camp  
Green Monkey..... Michael Propster  
Coach ..... Josh Moody  
Guards..... Jessica Almasy, Julia Lawler, Beto O'Byrne

## Plant Lover + Sailor = ?

by Delia Cadman, age 11. Directed by Julia Gibson.

Annie Seeslier ..... Marin Ireland  
Juglena ..... Phyllis Somerville  
Luna..... Rachel Rusch

## Fire Planet

by Eric Carrero, age 11. Directed by John Steber.

Fireballs..... Armando Riesco  
Fire Unknown Gender ..... Jimonn Cole

## The Peterson Monkeys

by Lambert Whitney, age 10. Directed by Diana Buirski.

Bob/Britney..... Robert Sella  
Jack/Joe ..... Robert Stanton  
John..... John Sheehy

## Different Nightmare Friends

by Jocelyn Ochoa, age 11. Directed by Erica Schmidt.

Billy Bob..... Christopher Evan Welch  
Agatha ..... Lucy DeVito  
Announcer ..... Emily Simoness

## The Candy Store

by Tatiana Goode, age 10. Directed by Michael Potts.

Linda..... Patrice Johnson  
Lisa ..... Pascale Armand  
Mom..... Julia Lawler  
Dad ..... George Babiak  
Jawbreaker King..... Josh Moody  
Waiter ..... Rachel Rusch

## Stop Being Snotty

by Jeremy Vazquez, age 11. Directed by John Steber.

Jace..... Jimonn Cole  
Snotty Kid ..... Armando Riesco  
Customer..... Jessica Almasy  
Snotty Kid's Dad ..... John Sheehy

## The True Story of Red Riding Hood

by Ahmed Nasser, age 11. Directed by Erica Schmidt.

Blue Blooming Bird..... Lucy DeVito  
The So Kind Cough Cough Wolf ..... Christopher Evan Welch  
Butcher ..... Robert Askins  
Protester..... Emily Simoness  
Hot Dog Guy..... Beto O'Byrne

## A Sister Life is Annoying!

by Genesis Hires, age 10. Directed by Julia Gibson.

Lisa..... Marin Ireland  
Vicky ..... Phyllis Somerville

## Dead Man Walking

by Richard Brea, age 11. Directed by David Costabile.

Raft..... Bill Camp  
Evil Bob ..... Peter Dinklage  
Billy Bob..... Michael Propster

## The Earth Does Not End in 2012

by Faisal Afridi, age 11. Directed by Diana Buirski.

Bob the Geek..... Robert Sella  
Luke the Space Guy ..... Robert Stanton  
George Donkeyton ..... George Babiak  
Donkeys/Guards..... Jessica Almasy, Julia Lawler, Beto O'Byrne

**B  
R  
I  
E  
F  
  
I  
N  
T  
E  
R  
M  
I  
S  
I  
O  
N**



## **Lorraine Cohen** **1927-2005**

For more than forty years, Lorraine Cohen dedicated herself to all facets of the theater, including acting, directing and teaching. Her deeply memorable performances as Amanda in *The Glass Menagerie* and as Emily Dickinson in *The Belle of Amherst* were often compared favorably with the very well known actors who had played those roles before her. Those who knew her as a teacher, remember the amazing annual Shakespeare productions of her fifth graders and the many stunning performances of her high school students.

In the 1960's Laurie performed in a series of plays at the Bergen County Players in New Jersey including *Ring Around Elizabeth* (1960), *Fumed Oak* (1961), *Blithe Spirit* (1962), and *The Waltz of the Toreadors* (1961). In 1969 she performed in *No Bed of Roses* at the Showplace Summer Theatre. Laurie also spent many productive years at The New Dimension Theatre Studio in Englewood, New Jersey where Dr. Richard Imundo was the Artistic Director. At The New Dimension she taught acting to children and young adults, and also performed in many productions including *Animal* (1971), *The Glass Menagerie*, and *Uncle Vanya* (1970). She also directed and acted in many evenings of scenes at The New Dimension. One of her early students at The New Dimension was a young man by the name of John Travolta who also performed with her in *Who'll Save the Plowboy?* (1966).

Having obtained her college degree from Fairleigh Dickinson University in Teaneck, New Jersey, she performed in a series of plays produced by the University Players, including *Ghosts*, *The Glass Menagerie*, and *J.B.* While studying for her masters degree at Montclair State College, she performed in several productions there including *The Hostage*, *Plaza Suite*, and *Not Now Darling*. Laurie also performed in *Cinderella* at the William Paterson College Summer Theatre Workshop, and in 1984 she performed in *The Devil's Disciple* at the Williamstown Theatre Festival in Williamstown, Massachusetts.

In 1983 Laurie starred as Emily Dickinson in the one-woman show *The Belle of Amherst*, directed by her friend and colleague, John Brancato. *The Belle of Amherst* had a limited run at The Tyson Studio in New York City to rave reviews in *The New York Times* and *The Daily News*.

Though many encouraged Laurie to pursue a professional acting career, she always made it clear that her true love was teaching and she dedicated much of her life to filling young students' hearts and minds with the love of theatre, both in its literary form and as a performing art. During her tenure in the 1970's as a fifth grade teacher at the Longfellow School in Teaneck, New Jersey, she directed an annual Shakespeare play starring her fifth grade students, performing the likes of *Macbeth*, *Julius Caesar* and *Hamlet*. Laurie's love of theater and teaching reached its pinnacle during her many years teaching English and Drama at Teaneck High School in Teaneck, New Jersey. She truly loved teaching drama to high school students, introducing them to the joys of acting and play-writing, and she directed an enormous number of full length productions, musicals, scenes, and student-written original plays. She directed too many shows to list individually, but they included *Cabaret*, *Diary of Anne Frank*, *A Midsummer Night's Dream*, *The Crucible*, *The Man Who Came To Dinner*, *Don't Drink the Water* and *Waiting for Godot*. In addition to these productions, she directed the students in an annual *Evening of Scenes*. Her students won many awards for their work at the annual Bucks County Playhouse Drama Festivals in Pennsylvania. Even after retirement from teaching, she continued to direct performances at Leonia High School, in Leonia, New Jersey.

In addition to acting and teaching, Laurie also edited three books for the theatre: *Scenes for Young Actors*, *Monologues for Young Actors*, and *Scenes for Mature Actors*, all published by Avon Books. These three books continue to be used today in acting classes and auditions around the country.

Laurie is remembered lovingly by her five children, her three siblings, her eight grandchildren, her companion Dick, her many colleagues and friends, and her innumerable students. It is in her memory that they support the 52nd Street Project. It is what she would have wanted.



## **Lorraine Cohen** **1927-2005**

For more than forty years, Lorraine Cohen dedicated herself to all facets of the theater, including acting, directing and teaching. Her deeply memorable performances as Amanda in *The Glass Menagerie* and as Emily Dickinson in *The Belle of Amherst* were often compared favorably with the very well known actors who had played those roles before her. Those who knew her as a teacher, remember the amazing annual Shakespeare productions of her fifth graders and the many stunning performances of her high school students.

In the 1960's Laurie performed in a series of plays at the Bergen County Players in New Jersey including *Ring Around Elizabeth* (1960), *Fumed Oak* (1961), *Blithe Spirit* (1962), and *The Waltz of the Toreadors* (1961). In 1969 she performed in *No Bed of Roses* at the Showplace Summer Theatre. Laurie also spent many productive years at The New Dimension Theatre Studio in Englewood, New Jersey where Dr. Richard Imundo was the Artistic Director. At The New Dimension she taught acting to children and young adults, and also performed in many productions including *Animal* (1971), *The Glass Menagerie*, and *Uncle Vanya* (1970). She also directed and acted in many evenings of scenes at The New Dimension. One of her early students at The New Dimension was a young man by the name of John Travolta who also performed with her in *Who'll Save the Plowboy?* (1966).

Having obtained her college degree from Fairleigh Dickinson University in Teaneck, New Jersey, she performed in a series of plays produced by the University Players, including *Ghosts*, *The Glass Menagerie*, and *J.B.* While studying for her masters degree at Montclair State College, she performed in several productions there including *The Hostage*, *Plaza Suite*, and *Not Now Darling*. Laurie also performed in *Cinderella* at the William Paterson College Summer Theatre Workshop, and in 1984 she performed in *The Devil's Disciple* at the Williamstown Theatre Festival in Williamstown, Massachusetts.

In 1983 Laurie starred as Emily Dickinson in the one-woman show *The Belle of Amherst*, directed by her friend and colleague, John Brancato. *The Belle of Amherst* had a limited run at The Tyson Studio in New York City to rave reviews in *The New York Times* and *The Daily News*.

Though many encouraged Laurie to pursue a professional acting career, she always made it clear that her true love was teaching and she dedicated much of her life to filling young students' hearts and minds with the love of theatre, both in its literary form and as a performing art. During her tenure in the 1970's as a fifth grade teacher at the Longfellow School in Teaneck, New Jersey, she directed an annual Shakespeare play starring her fifth grade students, performing the likes of *Macbeth*, *Julius Caesar* and *Hamlet*. Laurie's love of theater and teaching reached its pinnacle during her many years teaching English and Drama at Teaneck High School in Teaneck, New Jersey. She truly loved teaching drama to high school students, introducing them to the joys of acting and play-writing, and she directed an enormous number of full length productions, musicals, scenes, and student-written original plays. She directed too many shows to list individually, but they included *Cabaret*, *Diary of Anne Frank*, *A Midsummer Night's Dream*, *The Crucible*, *The Man Who Came To Dinner*, *Don't Drink the Water* and *Waiting for Godot*. In addition to these productions, she directed the students in an annual *Evening of Scenes*. Her students won many awards for their work at the annual Bucks County Playhouse Drama Festivals in Pennsylvania. Even after retirement from teaching, she continued to direct performances at Leonia High School, in Leonia, New Jersey.

In addition to acting and teaching, Laurie also edited three books for the theatre: *Scenes for Young Actors*, *Monologues for Young Actors*, and *Scenes for Mature Actors*, all published by Avon Books. These three books continue to be used today in acting classes and auditions around the country.

Laurie is remembered lovingly by her five children, her three siblings, her eight grandchildren, her companion Dick, her many colleagues and friends, and her innumerable students. It is in her memory that they support the 52nd Street Project. It is what she would have wanted.





**The Banff Centre**  
inspiring **creativity**



UNIVERSITY OF  
**CALGARY**  
FACULTY OF ARTS

Gus Rogerson, Artistic Director

Carol Ochs, Executive Director

The 52nd Street Project Presents

The 52nd Street Project (The Project) is dedicated to the creation and production of new plays for and by kids between the ages of ten and eighteen who reside in the Hell's Kitchen neighborhood in New York City. The Project does this through unique mentoring programs that match kids with professional (and volunteer!) theater artists.

The Project is about making children proud of themselves. The Project is not about teaching children to act, although they will learn to. It is not about teaching them to write plays, although they will learn that as well. What it is about is giving a kid an experience of success. It is about giving a kid an opportunity to prove that he or she has something of value to offer, something that comes from within that he or she alone possesses, something that cannot be taken away.

The Project's Teen Ensemble is the final step in the kids' training: a two-year acting class that culminates in the production of a full-length play by William Shakespeare, the very one you are seeing tonight. This year's show is being done in New York, Calgary, and Banff. We are very grateful to all our American and Canadian friends for enabling this tour.

The following foundations and government agencies have generously supported the Teen Program through their contributions:

City of New York Department of Cultural Affairs  
Horace W. Goldsmith Foundation  
New York State Council on the Arts  
The Surdna Foundation



**Directed by Nicole A. Watson**

**Adapted from William Shakespeare's Play by  
Chris Ceraso  
and The 52nd Street Project Teen Ensemble**

**Produced by Megan Cramer**

*New York City, June 25 and 26, 2011 - The Five Angels Theater*

*Calgary, July 2, 2011 - The University of Calgary*

*The Banff Centre, July 4, 2011 - The Margaret Greenham Theatre*

# The Cast

Valentine.....	A.J. Welsh
Proteus.....	Carlos Dumé
Speed.....	Hera Andre-Bergmann
Julia.....	Azalea Rosario
Sylvia.....	Erica Arce
Lucetta.....	Jenisse Bouret
Launce.....	Jenisse Bouret
Thurio.....	Matthew Jellison*
Eglamour.....	Matthew Jellison*
Panthina.....	Janiece Aponte
Antonia.....	Megan Cramer
Outlaws.....	Janiece Aponte, Jenisse Bouret, Megan Cramer, Matthew Jellison*
Duke.....	Chris Ceraso
Host.....	Chris Ceraso
Hostess.....	Megan Cramer
Ursula.....	Megan Cramer

# Production Staff

Composer/Music Director.....	Andrew Sherman
Lighting Designer.....	Burke Brown
Costume Designer.....	Lara de Bruijn
Costume Associate.....	Karyn Folino
Sound Designer.....	Vanessa Valdes
Stage Manager/Board Operator (NYC).....	Emma Miller
Flyer/Program Art design.....	Jessica Ellis
Shakespeare Coaches.....	Jeremy Beck, Diana Buirsky, Dave Dalton, Judy Kuhn, Larry Nathanson, Emily Dorsch, Mikhaela Mahony

**New York Thanks:** Muhammad Cunningham, Jason Hare, Catherine Mueller, Tom Schall.

**Calgary Thanks:** Clem Martini, Kathleen Foreman, Elena Sinitsyna, Caitlyn Spencer, The University of Calgary, Wagon Stage, Rick Hilton and the Curiously Canadian Improv Guild, Stephen Hunt, and Alan and Faylene Valdes.

**Banff Thanks:** Kelly Robinson, Roxanne Miller, Heloise Veillette, The Banff Centre, Connie Brill and Precipice Theater Company, and Joni Cooper.



# The 52nd Street Project Staff

Gus Rogerson, Artistic Director	Carol Ochs, Executive Director
Megan Cramer, Assoc. Artistic Director	Lisa Kerner, General Mgmt. Associate
George Babiak, Production Manager	John Sheehy, Dir. of Devel. & Marketing
Ray Harold*, Technical Director	Josh Moody, Development Associate
Liz Bell, Director of Education	
Diana Rojas*, Associate Program Director	

## Consultants:

Iris A. Brown, Graphic Designer; Chris Ceraso, Teen Dean;  
Nicole A. Watson, Teen Shakespeare Director

## Interns:

Jordana De La Cruz, Emma Miller, Ben Vigil

## Teen Employees:

Doris Alcantara, Michael Bannister, Samantha Caldon, Joyce Cheung, Carlos Dume, Emmett Goodman-Boyd, Alvin Garcia, Raphael Irizarry III, David McCall, Terrence Mack, Chloe Moore, Tino Paduani, Azalea Rosario, Luisa Santiago, Malik Velazquez, Francis Williams, Jorge Zapata.

# The 52nd Street Project Board of Directors

Lisa Benavides	Carol Ochs
Rachel Chanoff	Willie Reale, <i>founder</i>
Cathy Dantchik	Gus Rogerson
Carolyn C. DeSena	Shirley Rumierk*, <i>alumni member</i>
Wendy Ettinger, <i>chair emeritus</i>	José Soto, Jr.*, <i>alumni member</i>
Louis P. Friedman	Jenny Steingart
Stephen Graham, chair	Lisa Tilney
James McDaniel	Merritt Tilney
Frances McDormand	Pamala Tyson
Noël Mihalow	Wendy vanden Heuvel
	John A. Vassilaros

\*Alumnus of The 52nd Street Project Teen Ensemble

\*Alumnus of The 52nd Street Project Teen Ensemble



## THE SYNOPSIS - ACT 1

Valentine and Proteus, two friends who have lived in Verona all their life, say a fond farewell as Valentine goes to seek his fortune in Milan. Valentine urges his friend to come with him, but knows the real reason Proteus won't leave Verona: Proteus has fallen hard for a local girl named Julia. Valentine departs. Proteus has asked Valentine's servant, Speed, to deliver a love letter to Julia. Speed delivered the letter, but her heart wasn't in it, especially for no pay. The servant follows her master to Milan, leaving Proteus frustrated about getting his messages to Julia.

Julia has many local suitors, and she questions her servant and friend, Lucetta, about her would-be boyfriends. Lucetta knows that Julia secretly has eyes for Proteus. She reveals that Proteus has sent Julia a love letter, which Lucetta accepted from Speed in Julia's person. Julia, outraged that Lucetta would accept a love token in her name, scolds Lucetta and tears Proteus' letter to bits. Julia immediately regrets her impulsive behavior, and soon sends Proteus a message of her own. But Proteus' mother, knowing nothing of her son's love affairs, decides that it would be best for her son to join Valentine at the Imperial Court. Proteus is heartbroken, especially knowing of Julia's love, but must obey his mother.

Meanwhile, Love has found Valentine in Milan! He has fallen for the Duke's daughter, Silvia. Though Silvia at first plays hard-to-get, it is obvious, especially to Speed, that she has feelings for Valentine. But her father, the Duke, has other plans for her: a young nobleman named Thurio.

Back in Verona, Julia and Proteus say goodbye and exchange rings as a token of love and faith. Proteus calls for his own servant, Launce, to accompany him on his journey. Launce is also heartbroken to be leaving her home and loved ones. She is also angry at her cold-hearted dog, Crab, who seems to have no feelings at all about the matter.

Valentine is thrilled to see his friend at Court and is quick to tell Proteus about his newly-hatched plans to steal Silvia away from the Duke and rich Thurio. Proteus is instantly dazzled by Silvia's beauty. He decides, despite his better judgment, to turn on both Julia and Valentine and work his own plan to get with Silvia. He tells the Duke of Valentine's plot to elope with his daughter. When the Duke sees the evidence for himself, he banishes Valentine from Milan on pain of death. Proteus pretends to commiserate with Valentine's plight. He promises his unfortunate friend that he will deliver all of Valentine's letters to Silvia personally. Only Launce seems to see through Proteus.



## ACT TWO

Under pretense of coaching Thurio in the art of courtship, Proteus makes plans to woo Silvia for himself. Meanwhile, back in Verona, Julia can't stand being apart from Proteus. She decides to make the dangerous journey to Milan dressed as a man to protect herself from thieves and scoundrels. Just such a band of rascally Outlaws overtakes Valentine and Speed in the woods outside Milan. Impressed by Valentine's charismatic personality, the Outlaws decide to make him the leader of their band.

Julia arrives in Verona just in time to see Proteus, and dull-witted Thurio, serenading Silvia. Proteus gets rid of Thurio and professes his love to Silvia. Silvia is disgusted because she knows from Valentine that Proteus is promised to another. Proteus pronounces his old love dead, and manages to convince Silvia to let him have her picture to adore, if he can't have her. Overhearing all this, Julia is heartsick. She decides to stay in disguise a while longer to see how it plays out. After Launce and her bad-mannered mutt, Crab, embarrass Proteus in his pursuit of Silvia, Proteus hires the genteel (disguised) Julia to become his new go-between. In return for Silvia's picture, Proteus sends Julia to Silvia with a love letter... and the same ring Julia gave him at their parting.

Silvia refuses Proteus' gifts, knowing that the ring rightfully belongs to another. Julia is impressed with Silvia's kind and noble heart. Silvia, meanwhile, gains the help of a trustworthy knight, Sir Eglamour, to escape from the house arrest under which her father has placed her, and to find Valentine. The Duke enlists Proteus, Thurio and Julia (disguised) to find his daughter. But the Outlaws find Silvia first. Eglamour flees, but Proteus and Julia come to Silvia's rescue. When Silvia protests that she'd rather die than let Proteus save her, the enraged and crazed Proteus tries to force himself on Silvia. Valentine appears just in the nick.

Valentine berates and shames Proteus for his brutish behavior, but forgives his old friend when he believes that Proteus is stricken with true remorse. As a token of friendship and healing, Valentine offers Silvia to Proteus. Silvia is stunned. Julia faints.

The crazy world comes around when Proteus revives his page and discovers the "boy" carrying the ring he gave to Julia. Julia reveals herself, and Proteus reasserts his true love for her, which she accepts at Valentine's urging. The remaining Outlaws show up with the Duke and Thurio in tow. Thurio proves a coward in the Duke's eyes, and the forgiving monarch deems Valentine worthy of his daughter's hand. A festive wedding is planned. Valentine promises to make Proteus pay for his bad behavior by singing his story to the world, after which they will all share One Feast, One House, One Mutual Happiness...and One Love.

The 52nd Street Project gratefully acknowledges the support of the following foundations and corporations: BGC; Big Wood Foundation; Bloomberg; Brenner Family Foundation; Carnegie Corporation of New York; CBS Corporation; Consolidated Edison; Dawkins Family Foundation; The Neil V. DeSena Foundation; The Dramatists Guild Fund; Dramatists Play Service; Eleanor, Adam & Mel Dubin Foundation; The Educational Foundation Of America; Flexis Capital LLC; Sidney E. Frank Foundation; Fund for the City of New York; Goldman Sachs Gives; The Horace W. Goldsmith Foundation; Grant's Financial Publishing, Inc.; The William and Mary Greve Foundation; Heisman Foundation; The Henlopen Foundation; Hudson Scenic Studio; I. Weiss; Integra Realty; The Suzanne Nora Johnson & David G. Johnson Foundation; Lotos Foundation; Ann M. Martin Foundation; Monteforte Foundation; J.P. Morgan Charitable Trust; MTI; National Philanthropic Trust; NYFA; Punchline Magazine; Jonathan Rose Companies; The Shubert Organization; Simon & Eisenberg; St. Vincent De Paul Foundation; Harold & Mimi Steinberg Charitable Trust; Stranahan Foundation; Susquehanna Foundation, Corp.; Tax Pro Financial Network, Inc.; TCG; Theater Subdistrict Council; Theatre Communications Group, Inc.; Tiger Baron Foundation; United Real Estate Ventures, Inc.; Van Deusen Family Fund; Watkins, Inc.; WMEE Foundation; Yorke Construction Corp. In addition, the following individuals made gifts over \$250 to The 52nd Street Project this past year. (list current as of 4/1/11):

Robert Abrams & Cynthia Vance	Cathy Dantchik	John Kyles & Stefanie Kyles	Mike Shaheen
George Ackert	Leslie Dantchik	Michael P. Lawrence	Phil Shaheen
Michael Alicastro	Peter & Judith Dawkins	Warren Leight	Pam Shaw & Victor Syrmis
Jonathan Soros & Jennifer Soros	Russell Dodson	Adrienne Lobel & Mark Linn Baker	Kim Sherman & John Sheehy
Elton Andrews	Michael Dougherty	Mark Linn Baker	Meg Simon
Richard Anthony	Brian Duggan & Carol Duggan	Susan Hess Lucier	Ravi Singh
Emily Armstrong	Rick Elliott	Thomas Lynch	Brian Sklar
Dominick & Ilene Balletta	Nigel Faulkner & Amanda Faulkner	John Lyons	Christopher Solomon
Ken Bantum	Peter Jay Fernandez & Denise Burse	Frances McDormand & Joel Coen	Steven Starker & Farrell Starker
Lisa Benavides & Tim Nelson	Michael Ferrara	Eric Mindich & Stacey Mindich	Jenny & Jon Steingart
Eric Berman & Elizabeth Berman	Randy Frankel	Emily & John Morgan	Tracy Straus
David Beth	Alison Fraser & Nat Magee	Dexter Morse	Mike Szwajkowski
Lewis Black	Beverly Gasner	Suzen Murakoshi & Mark Temme	Jonathan Rose Companies, Inc.
Richard Blackstone & Yildez Yuksek	Alexandra Gersten & John Vassilaros	T.J. Nelligan	Anne Tilney & Douglas Kaden
Emily Blavatnik	Scott Aaron Gewirtz & Laura Gewirtz	Randy & Rona Nelson	Liz Tuccillo
Michelle Bork & Jonathan Levine	Stephen & Cathy Graham	Ruth Nelson	Gregory Tusar
Liz Brixius	Jonathan Groff	Cynthia Nixon	Laura Valeroso & David Seidman
Becky Browder & Ted Neustadt	Jan Gura & Alan Pickman	Rachel & Larry Norton	Wendy vanden Heuvel & Brad Coley
Brian Byrnes	David & Ann Hausmann	Jodi Nuss	Mary Pat Walsh
Shawn Byron & Laura Byron	Peter Herdrich & Karen Trott	Kevin O'Rourke & Edith Thurber	Borah & Mildred Walton
Rich Cancro	Eric & Barbara Hippeau	Elizabeth Peters	Scott Ward
Lawrence Catena	William Holtzman & S. Sylvia Shepard	Bat-Sheva & Thomas Peters	Sally & Lenny Weiss
Rachel Chanoff	Mary Horowitz	Thomas Peters	Jane Bolster & Steve Wertimer
Nora Charles	Sarah Horowitz & David Venarde	Judy Goldman & Michael Pillingier	Thomas Whatley
David Cohen & Sandra Novak Cohen	Andrea Johnson	Stephanie Plousis	Elizabeth Williams & Joseph Forte
Larry Cohen	Cindy Kaplan & David Froelich	Willie Reale & Jenny Gersten	John William & Suzanne William
Melissa Cohn	Kevin Kelly	Jacquelyn Reingold	J.P. Xenakis
Judith-Ann Corrente	Janet Coviello	James Rogan	Carole Yass & Randy Ginsburg
Kyle Czepiel	Patrick Kelly & Diane Kelly	David Ross & Laura Ross	Jarrold Yuster
Arthur Dantchik	Ed Keslo	Carla Sacks & John Morris	
		Christian Sauska	

The 52nd Street Project Presents

# HEADS OR TAILS

The Chancy Plays



July 22-24

The Five Angels Theater

## Heads or Tails: The Chancy Plays

The Annual Block Island One-on-Ones - July 22-24, 2011 at the Five Angels Theater

### The 52nd Street Project Staff

Gus Rogerson, Artistic Director  
 Megan Cramer, Associate Artistic Director  
 George Babiak, Production Manager  
 Ray Harold, Technical Director

Carol Ochs, Executive Director  
 Lisa Kerner, General Mgmt. Associate  
 John Sheehy, Dir. of Development & Marketing  
 Josh Moody, Development Associate

Liz Bell, Director of Education  
 Diana Rojas, Associate Program Director

#### Consultants:

Iris A. Brown, Graphic Designer; Chris Ceraso, Teen Dean

#### Interns:

Jordana De La Cruz, Emma Miller, Ben Vigil

#### Teen Employees:

Receptionists: Samantha Caldon, Alvin Garcia  
 Block Island Teen Counselor: Malik Velazquez  
 Ushers: David McCall, Tino Paduani, Azalea Rosario

### “HEADS OR TAILS” Production Staff

#### Composer/Music Director

Eric March

#### Set Designer

Kevin Joseph Roach

#### Lighting Designer

Greg MacPherson

#### Lightboard Programmer

Jit Seneviratne

#### Costume Designer

Viviane Galloway and Ciera Wells

#### Sound Designer

Chris Steele-Nicholson

#### Stage Manager

Liz Bell

#### Projection Designs

George Babiak, Liz Bell,  
 Heather Carnduff-Gobbee,  
 DeeDee Maguire, Josh Moody,  
 John Sheehy, and the Slide Archive

#### Prop Design Team

Anju Andre-Bergmann,  
 George Babiak, Liz Bell,  
 Megan Cramer, Deborah Gaffaney,  
 Emma Miller, Josh Moody,  
 Lee Rosen, John Sheehy

#### Backstage Crew

Jordana De La Cruz,  
 Jasmine Hernandez, Emma Miller,  
 Edison Sibri, Malik Velazquez,  
 Ben Vigil

#### House Managers

Karin Schall  
 Mary Pat Walsh

#### Flyer/Program Art:

Patrick Jones

#### Chefs

Martha Velie-Gass  
 and Pat Ritter



The One-on-One Program is made possible with public funds from The National Endowment for the Arts, The New York State Council on the Arts, a state agency; and the New York City Department of Cultural Affairs. The 52nd Street Project is supported by the Open Society Foundations and the Fund for the City of New York. The 52nd Street Project is a member of Art/NY.

## COOL STUFF ON SALE IN THE LOBBY!

Fabulous Flyer Bars .....\$2.50 and \$2.00  
*and featuring Shel Silverstein's "Fivey and Twoey" logo:*

Project T-shirts and tanks ..... \$12.00  
 Project Caps .....\$20.00  
 Project Mugs ..... \$5.00  
 Project Pencil 3-pack ..... \$1.00  
 Project Notebook ..... \$5.00

Thank you for coming to HEADS OR TAILS! If you are not on our mailing list (or if your address has changed), please fill out this form and give it to us on your way out or mail it to the address below. We would also like to know if you are interested in becoming a volunteer. We need help in all areas, so be sure to fill out the entire form.

PLEASE ADD ME TO YOUR MAILING LIST:

07/11

NAME \_\_\_\_\_

ADDRESS \_\_\_\_\_

CITY \_\_\_\_\_

STATE \_\_\_\_\_

ZIP \_\_\_\_\_

HOME PHONE \_\_\_\_\_

DAYTIME OR MOBILE PHONE \_\_\_\_\_

E-MAIL ADDRESS \_\_\_\_\_

MY OCCUPATION \_\_\_\_\_

MY HOBBIES \_\_\_\_\_

YES, I WOULD LIKE TO BE OF HELP. I CAN:

- |   |   |  |
|---|---|--|
| <input type="checkbox"/> Help load in and out for shows | <input type="checkbox"/> Draw and/or paint  | <input type="checkbox"/> Help kids with homework |
| <input type="checkbox"/> Hang lights                    | <input type="checkbox"/> Help with mailings | <input type="checkbox"/> Teach kids a skill      |
| <input type="checkbox"/> Work on a backstage crew       | <input type="checkbox"/> Do office work     | <input type="checkbox"/> Be a chef at an event   |
| <input type="checkbox"/> Do graphic design              | <input type="checkbox"/> Design sound       | <input type="checkbox"/> Design and sew costumes |
| <input type="checkbox"/> Other (please specify) _____   |   |  |

MY SCHEDULE IS:

- Very flexible. I'm often available during weekdays.
- Somewhat flexible. I can help on the occasional morning or afternoon during the week.
- Not very flexible at all, but I've got some free time on evenings and weekends.

If you would like to mail this (and you're always welcome to enclose a tax-deductible contribution), you can send it to: The 52nd Street Project, 500 West 52nd St., #2E, New York, NY 10019. Or fax it to (212) 333-5598.

**COME BACK NEXT MONTH FOR...**

IGUS ROGERSON, ARTISTIC DIRECTOR

THE 52ND STREET PROJECT PRESENTS

CAROL OCHS, EXECUTIVE DIRECTOR

# HEADS OR TAILS

## The Chancy Plays **II**



The 2011 Wiener Family Foundation  
**Wareham, Massachusetts One-on-Ones**



10 new plays featuring  
kids with adult partners

**Friday, August 19 at 7:30,  
Saturday, August 20 at 7:30,  
and Sunday, August 21 at 3:00**

**The 52nd Street Project's Five Angels Theater**

789 10th Avenue, between 52nd and 53rd St.

Admission is free, but reservations are strongly recommended!  
Call (212) 642-5052 to reserve your tickets.



### **BE ON THE LOOKOUT!**

We are always searching for interns.

If you know of any college or graduate students who might enjoy working with us, playing with us, and going on trips with us for a semester, please have them contact Lisa Kerner. We are especially looking for interns for Fall, 2011, and Spring, 2012. Thanks!

### **The 52nd Street Project Board of Directors**

Lisa Benavides	Carol Ochs
Rachel Chanoff	Willie Reale, founder
Cathy Dantchik	Gus Rogerson
Carolyn DeSena	Shirley Rumierk, alumni member
Wendy Ettinger, chair emeritus	José Soto, Jr., alumni member
Louis P. Friedman	Jenny Steingart
Robert Goldberg	Lisa Tilney
Stephen Graham, chair	Merritt Tilney
James McDaniel	Pamala Tyson
Frances McDormand	Wendy vanden Heuvel
Noël Mihalow	John A. Vassilaros

### **What's Going On Here?**

The 52nd Street Project is a non-profit organization that brings children from the Hell's Kitchen neighborhood together with professional theater artists to create original theater. HEADS OR TAILS! is a production of our One-on-One program, which is designed to give children the opportunity to go away for one-week stays in the country and enjoy the undivided attention of a professional theater artist who serves as friend, mentor, and collaborator.

### **In-Kind Contributions**

Abbeville Press; Stephanie Berger Photography; Iris A. Brown Design; City Winery; William Curran & A Curran Affair; Drive 495; HBO; ICI; Paris Chocolates; Pharma Print/Omni Graphics; Sesame Workshop; Wendy Stuhlberg; John A. Vassilaros and Sons; Watkins, Inc.; Ron Fiorina and Boylan's Bottling Co.; Shapiro & Lobel; Hudson Scenic; Prime Films, and Paul, Weiss, Rifkind, Wharton & Garrison LLP. , Fat Sal's Pizza, Mitchell London Foods, Wendy Stuhlberg, Steve Olsen and the Westbank Cafe, Mary Pat Walsh, and Yorke Construction.

### **Special Thanks**

Our Host Families – Sue Black; Susan Bush; Socha Cohen; Mimi Leveille; Elliot & Amy Nerenberg; Leslie Parsons; Lisa Stipock & Allen McKay; George & Jean Taber; Ron & Judy Tierney; Joya Verde & Virginia Dare; and our headquarters host Dr. Christina Biaggi. Sincere thanks to our chefs Pat Ritter & Martha Velie-Gass; Kate Butcher & everyone at Block Island Realty; Block Island Maritime Institute; Block Island Airport; McQuade's Marketplace; Robbie Brown; Rita & Steve Draper; Amelia Gallant at the Block Island Grocery; Cindy & Stan Geer at the Depot; Glenn & Annie Hall; Interstate Navigation; and Sophia MacVittie.

## Heads or Tails – ACT 1

All original music composed by Eric March, except as indicated.  
*Now We're Cookin'! Theme Song* lyrics by John Sheehy

### SPERLOCK AND WHITSUN

Written and directed by Robert Askins for Enrique Caballero, age 11

Sperlock..... Enrique Caballero  
Whitsun..... Robert Askins

*I'll Be Your Best Best Friend* lyrics by Robert Askins.

### LOST IN THE BORDERLANDS

Written by Carly Mensch and directed by Nehassaiu deGannes  
for Jade Cuevas, age 11

Monica “Babyface” Malone..... Jade Cuevas  
Canadian Mountie ..... Nehassaiu deGannes  
Justin Bieber..... Malik Velazquez

*You and Me* lyrics by Carly Mensch.

### STEALING BASICS

Written and directed by John Sheehy for Eric Carrero, age 11

Wiley E. Steele ..... Eric Carrero  
Lou Suar ..... John Sheehy

*Change* lyrics by John Sheehy.

### BON CHANCE

Written by Cynthia Kaplan and directed by Jennifer Ikeda  
for Daniel Martinez, age 10

Chance ..... Daniel Martinez  
Marcelle ..... Jennifer Ikeda  
TV Reporter ..... Jasmine Hernandez  
Gendarme..... George Babiak  
Judge..... Megan Cramer  
Juror ..... Malik Velazquez

*The Winds of Change* music and lyrics by Cynthia Kaplan.

### THE GENIUS OF MADAME FROU FROU

Written by Michael Bernard and directed by Keira Naughton  
for Amber Urena, age 10

Madame Frou Frou Leftovers ..... Amber Ureña  
Sally Nolife..... Keira Naughton  
Fashionable people ..... Megan Cramer and Jordana De La Cruz

*The Amazing Madame Frou Frou, Blah, and Big Shants Number* lyrics by Michael Bernard.

## Heads or Tails – ACT 2

### ARMORED TRUCKERS

Written and directed by Jed Clarke for Justin Bannister, age 10

Howard ..... Justin Bannister  
Timothy ..... Jed Clarke  
Ninja ..... Megan Cramer  
Announcer ..... Jordana De La Cruz  
Subway Crowd ..... The Crew  
The Mayor ..... George Babiak

*Armored Trucker Anthem* lyrics by Jed Clarke.

### BEEBLE AND CHICKEN FOREVER

Written by Don Nguyen and directed by Christina Robinson  
for Valeria Oliva, age 10

Beeble App ..... Valeria Oliva  
Chicken App ..... Christina Robinson  
Pointer ..... Jordana De La Cruz  
Other Apps..... Jasmine Hernandez, Edison Sibri, Ben Vigil

*App's Lament and Beeble and Chicken* lyrics by Don Nguyen.

### THE PERFECT FIT

Written by Sean Kenealy and directed by Grant Harrison  
for Edwin Rodriguez, age 11

Bernie ..... Edwin Rodriguez  
Joey ..... Grant Harrison  
Old Lady ..... Megan Cramer

*The Perfect Fit* lyrics by Sean Kenealy.

### IN DOG YEARS

Written and directed by Erin Mallon for Melody Cruz, age 11

Pandora ..... Melody Cruz  
Mabel..... Erin Mallon  
Kylie the Komondor ..... Megan Cramer  
Pearl the Standard Poodle ..... Malik Velazquez  
Scotty the Scottish Terrier..... Jordana De La Cruz

*Build Each Other Up* lyrics by Erin Mallon.

### A CROAK BEFORE DYING

Written and directed by Dylan Dawson for Faisal Afridi, age 11

Detective Bellhorn ..... Faisal Afridi  
Detective Greentree ..... Dylan Dawson  
Biology Teacher ..... George Babiak  
Frog Doe..... Malik Velazquez

*Frog Anatomy (Of A Murder!)* lyrics by Dylan Dawson.



The 52nd Street Project gratefully acknowledges the support of the following foundations and corporations: BGC; Big Wood Foundation; Bloomberg; Brenner Family Foundation; Carnegie Corporation of New York; CBS Corporation; Consolidated Edison; Dawkins Family Foundation; The Neil V. DeSena Foundation; The Dramatists Guild Fund; Dramatists Play Service; Eleanor, Adam & Mel Dubin Foundation; The Educational Foundation Of America; Flexis Capital LLC; Sidney E. Frank Foundation; Fund for the City of New York; Goldman Sachs Gives; The Horace W. Goldsmith Foundation; Grant's Financial Publishing, Inc.; The William and Mary Greve Foundation; Heisman Foundation; The Henlopen Foundation; Hudson Scenic Studio; I. Weiss; Integra Realty; The Suzanne Nora Johnson & David G. Johnson Foundation; Lotos Foundation; Ann M. Martin Foundation; Monteforte Foundation; J.P. Morgan Charitable Trust; MTI; National Philanthropic Trust; NYFA; Punchline Magazine; Jonathan Rose Companies; The Shubert Organization; Simon & Eisenberg; St. Vincent De Paul Foundation; Harold & Mimi Steinberg Charitable Trust; Stranahan Foundation; Susquehanna Foundation, Corp.; Tax Pro Financial Network, Inc.; TCG; Theater Subdistrict Council; Theatre Communications Group, Inc.; Tiger Baron Foundation; United Real Estate Ventures, Inc.; Van Deusen Family Fund; Watkins, Inc.; WMEE Foundation; Yorke Construction Corp. In addition, the following individuals made gifts over \$250 to The 52nd Street Project this past year. (list current as of 4/1/11):

Robert Abrams & Cynthia Vance	Cathy Dantchik	John Kyles & Stefanie Kyles	Mike Shaheen
George Ackert	Leslie Dantchik	Michael P. Lawrence	Phil Shaheen
Michael Alicastro	Peter & Judith Dawkins	Warren Leight	Pam Shaw & Victor Syrmis
Jonathan Soros & Jennifer Soros	Russell Dodson	Adrienne Lobel & Mark Linn Baker	Kim Sherman & John Sheehy
Elton Andrews	Michael Dougherty	Mark Linn Baker	Meg Simon
Richard Anthony	Brian Duggan & Carol Duggan	Susan Hess Lucier	Ravi Singh
Emily Armstrong	Rick Elliott	Thomas Lynch	Brian Sklar
Dominick & Ilene Balletta	Nigel Faulkner & Amanda Faulkner	John Lyons	Christopher Solomon
Ken Bantum	Peter Jay Fernandez & Denise Burse	Frances McDormand & Joel Coen	Steven Starker & Farrell Starker
Lisa Benavides & Tim Nelson	Michael Ferrara	Eric Mindich & Stacey Mindich	Jenny & Jon Steingart
Eric Berman & Elizabeth Berman	Randy Frankel	Emily & John Morgan	Tracy Straus
David Beth	Alison Fraser & Nat Magee	Dexter Morse	Mike Szwajkowski
Lewis Black	Beverly Gasner	Suzen Murakoshi & Mark Temme	Jonathan Rose Companies, Inc.
Richard Blackstone & Yildez Yuksek	Alexandra Gersten & John Vassilaros	T.J. Nelligan	Anne Tilney & Douglas Kaden
Emily Blavatnik	Scott Aaron Gewirtz & Laura Gewirtz	Randy & Rona Nelson	Liz Tuccillo
Michelle Bork & Jonathan Levine	Stephen & Cathy Graham	Ruth Nelson	Gregory Tuser
Liz Brixius	Jonathan Groff	Cynthia Nixon	Laura Valeroso & David Seidman
Becky Browder & Ted Neustadt	Jan Gura & Alan Pickman	Rachel & Larry Norton	Wendy vanden Heuvel & Brad Coley
Brian Byrnes	David & Ann Hausmann	Jodi Nuss	Mary Pat Walsh
Shawn Byron & Laura Byron	Peter Herdrich & Karen Trott	Kevin O'Rourke & Edith Thurber	Borah & Mildred Walton
Rich Cancro	Eric & Barbara Hippeau	Elizabeth Peters	Scott Ward
Lawrence Catena	William Holtzman & S. Sylvia Shepard	Bat-Sheva & Thomas Peters	Sally & Lenny Weiss
Rachel Chanoff	Mary Horowitz	Thomas Peters	Jane Bolster & Steve Wertimer
Nora Charles	Sarah Horowitz & David Venarde	Judy Goldman & Michael Pilling	Thomas Whatley
David Cohen & Sandra Novak Cohen	Andrea Johnson	Stephanie Plouvis	Elizabeth Williams & Joseph Forte
Larry Cohen	Cindy Kaplan & David Froelich	Willie Reale & Jenny Gersten	John Willian & Suzanne Willian
Melissa Cohn	Kevin Kelly	Jacquelyn Reingold	J.P. Xenakis
Judith-Ann Corrente	Patrick Kelly & Diane Kelly	James Rogan	Carole Yass & Randy Ginsburg
Janet Coviello	Ed Keslo	David Ross & Laura Ross	Jarrod Yuster
Kyle Czepiel		Carla Sacks & John Morris	
Arthur Dantchik		Christian Sauska	

The 52nd Street Project Presents

# HEADS OR TAILS

The Chancy Plays



The Wareham, Mass "Flip Side"

The 2011 Wiener Family Foundation  
**One-on-Ones**

August 19-21

The Five Angels Theater

## Heads or Tails: The Chancy Plays

The Annual Wareham One-on-Ones - August, 2011 at the Five Angels Theater

### The 52nd Street Project Staff

Gus Rogerson, Artistic Director  
Megan Cramer, Associate Artistic Director  
George Babiak, Production Manager  
Ray Harold, Technical Director

Carol Ochs, Executive Director  
Lisa Kerner, General Mgmt. Associate  
John Sheehy, Dir. of Development & Marketing  
Josh Moody, Development Associate

Liz Bell, Director of Education  
Diana Rojas, Associate Program Director

#### Consultants:

Iris A. Brown, Graphic Designer; Chris Ceraso, Teen Dean

#### Interns:

Jordana De La Cruz, Emma Miller, Ben Vigil

#### Teen Employees:

Receptionists: Samantha Caldon, Alvin Garcia, Jason Gil  
Wareham Teen Counselor: Doris Alcantara  
Ushers: Michael Bannister, Joyce Cheung, Daquan Nelson

### “Heads or Tails” Production Staff

#### Composer/Music Director

Kim D. Sherman

#### Set Designer

Kevin Joseph Roach

#### Lighting Designer

Greg MacPherson

#### Costume Designers

Katherine Brown, Chloe Chapin,  
Kate Cusack, Kathleen Doyle,  
Crystal Thompson

#### Sound Designer

Maury Schott

#### Stage Manager

Karen Munkel

#### Slide Designs

George Babiak and the  
Project Slide Archive

#### Prop Design Team

George Babiak, Liz Bell,  
Megan Cramer, Maximo Jimenez,  
Brandon Leon, Josh Moody,  
Karen Munkel, Flor De Liz Perez,  
Dee Dee Maguire, Lee Rosen,  
John Sheehy, Ruby Zamora

#### Backstage Crew

Doris Alcantara, Jordana De La Cruz,  
Maximo Jimenez, Brandon Leon,  
Emma Miller

#### House Managers

Karin Schall, Mary Pat Walsh

#### Flyer/Program Art:

Patrick Jones

#### Chefs

John Sheehy, Liz Bell, Carol Ochs

## COOL STUFF ON SALE IN THE LOBBY!

Fabulous Flyer Bars .....\$2.50 and \$2.00

and featuring Shel Silverstein's "Fivey and Twoey" logo:

Project T-shirts and tanks ..... \$12.00

Project Caps .....\$20.00

Project Mugs ..... \$5.00

Project Pencil 3-pack ..... \$1.00

Project Notebook ..... \$5.00

Thank you for coming to HEADS OR TAILS. If you are not on our mailing list (or if your address has changed), please fill out this form and give it to us on your way out or mail it to the address below. We would also like to know if you are interested in becoming a volunteer. We need help in all areas, so be sure to fill out the entire form.

PLEASE ADD ME TO YOUR MAILING LIST:

08/11

NAME

ADDRESS

CITY

STATE

ZIP

HOME PHONE

DAYTIME OR MOBILE PHONE

E-MAIL ADDRESS

MY OCCUPATION

MY HOBBIES

YES, I WOULD LIKE TO BE OF HELP. I CAN:

- Draw and/or color props  
 Hang lights  
 Work on a backstage crew  
 Do graphic design  
 Other (please specify) \_\_\_\_\_
- Teach kids a skill  
 Help with mailings  
 Be a chef at an event  
 Design sound
- Help kids with homework  
 Design and sew costumes

MY SCHEDULE IS:

- Very flexible. I'm often available during weekdays.  
 Somewhat flexible. I can help on the occasional morning or afternoon during the week.  
 Not very flexible at all, but I've got some free time on evenings and weekends.

If you would like to mail this (and you're always welcome to enclose a tax-deductible contribution), you can send it to: The 52nd Street Project, 789 10th Avenue, New York, NY 10019. Or fax it to (212) 333-5598.



The One-on-One Program is made possible with public funds from The National Endowment for the Arts, The New York State Council on the Arts, a state agency; and the New York City Department of Cultural Affairs. The 52nd Street Project is supported by the Open Society Foundations and the Fund for the City of New York. The 52nd Street Project is a member of Art/NY.

COMING SOON TO THE PROJECT...

# No Strings Attached

## THE INDEPENDENT PLAYS



## THE 2011 PLAYBACK PLAYS

The reverse of the One-on-One's!

Kids write plays for themselves and an adult partner to perform together.

October 21-23 right here at

## THE FIVE ANGELS THEATER



### BE ON THE LOOKOUT!

We are always searching for interns.

If you know of any college or graduate students who might enjoy working with us, playing with us, and going on trips with us for a semester, please have them contact Lisa Kerner. We are especially looking for interns for the Fall of 2011 and Spring of 2012. Thanks!

### The 52nd Street Project Board of Directors

Lisa Benavides	Willie Reale, founder
Rachel Chanoff	Gus Rogerson
Cathy Dantchik	Shirley Rumierk, alumni member
Carolyn DeSena	José Soto, Jr., alumni member
Wendy Ettinger, chair emeritus	Jenny Steingart
Louis P. Friedman	Lisa Tilney
Stephen Graham, chair	Merritt Tilney
James McDaniel	Pamala Tyson
Frances McDormand	Wendy vanden Heuvel
Noël Mihalow	John A. Vassilaros
Carol Ochs	

### What's Going On Here?

The 52nd Street Project is a non-profit organization that brings children from the Hell's Kitchen neighborhood together with professional theater artists to create original theater. HEADS OR TAILS is a production of our One-on-One program, which is designed to give children the opportunity to go away for one-week stays in the country and enjoy the undivided attention of a professional theater artist who serves as friend, mentor, and collaborator.

### In-Kind Contributions

Abbeville Press; Stephanie Berger Photography; Iris A. Brown Design; City Winery; William Curran & A Curran Affair; Drive 495; HBO; ICI; Paris Chocolates; Pharma Print/Omni Graphics; Sesame Workshop; Wendy Stuhlberg; John A. Vassilaros and Sons; Watkins, Inc.; Ron Fiorina and Boylan's Bottling Co.; Shapiro & Lobel; Hudson Scenic; Prime Films, and Paul, Weiss, Rifkind, Wharton & Garrison LLP. , Fat Sal's Pizza, Mitchell London Foods, Wendy Stuhlberg, Steve Olsen and the Westbank Cafe, Mary Pat Walsh, and Yorke Construction.

### Special Thanks

An extra special helping of gratitude goes to our host families; the people who housed our kids and adult volunteers during our week in Wareham, Mass.: Andrea & Emmanuel Daskalakis; Debbie Herring; Jamie Herring; Joe McNay; Alice McNay; Beth Pfeiffer; Gray & Rosemary Watson; Sidney Worthen, Sherbie & Tom Worthen; Peter, Helen & Christopher Randolph.

Sincere Thanks to Sophia MacVittie; Robin Morse, Lucy & Francis Rogerson; Vanessa Valdes; Bob Krystolfolski; George Hurd

## HEADS OR TAILS – ACT 1

All original music composed by Kim D. Sherman  
“Heads Or Tails” Theme Song lyrics by John Sheehy

### SWAP MEET

Written & Directed by George Babiak for Ruby Zamora, age 11  
Costume Designer: Crystal Thompson

Zorbina ..... Ruby Zamora  
Wesley ..... George Babiak  
Line Dancers ..... Josh Moody & the Crew  
Alien Overlord ..... Brandon Leon

*Don't Mess With the Earth* lyrics by George Babiak.

### CONTROLLED CHAOS

Written & Directed by Megan Cramer for Rene Paul Santiago, age 12  
Costume Designer: Kate Cusack

The Great Lord ..... Rene Paul Santiago  
Chaotica ..... Megan Cramer

*The Beauty of Control* and *The Emptiness Inside* lyrics by Megan Cramer.

### TURTLE DERBY

Written by Jihan Crowther & Directed by Eliza Baldi for Kaitlin Feliciano, age 11  
Costume Designer: Kate Cusack

Tilly Turtleman ..... Kaitlin Feliciano  
Myrtle Turtleworth ..... Eliza Baldi  
Announcer ..... Jordana De La Cruz

*The Time is Now* lyrics by Jihan Crowther.

### THE BALLAD OF LUCKY LARUE

Written & Directed by Christopher Randolph for Derek Tineo, age 11  
Costume Designer: Katherine Brown

Lucky LaRue ..... Derek Tineo  
Ralph “Snake-Eye” Snedaker ..... Christopher Randolph  
Clementine ..... Emma Miller  
Shep ..... Maximo Jimenez  
Maybelle ..... Doris Alcantara

*The Town that Luck Forgot* lyrics by Christopher Randolph.

### THE HONEY BADGER LONGS TO DANCE

Written by Graeme Gillis & Directed by Amirah Vann for Amanda Rosa, age 11  
Costume Designer: Kate Cusack

Cousin Hobbit ..... Amanda Rosa  
Olive Penny ..... Amirah Vann  
Racoon ..... Doris Alcantara  
Honey Badger ..... Josh Moody

*Don't Take Your Garbage Out On Me* and *Here's How You Get to Study Dance at Alvin Ailey* lyrics by Graeme Gillis.

## HEADS OR TAILS – ACT 2

### THE EDUCATION OF BUBBLEFACE

Written by Nick Jones & Directed by Tim Cain for Edelys Tiana Guerrero, age 11  
Costume Designer: Katherine Brown

Mrs. Doodles ..... Edelys Tiana Guerrero  
Bucky Bubbleface ..... Tim Cain

*Clown Into the Night* lyrics by Nick Jones.

### A BEAR WALKS INTO A RESTAURANT

Written & Directed by Lauren Blumenfeld for Julissa Peralta, age 12

Chef Pineapple ..... Julissa Peralta  
Signora Dissa Satisfido III ..... Lauren Blumenfeld  
Restaurant Customers ..... Maximo Jimenez, Brandon Leon

*Dinner Disaster* lyrics by Lauren Blumenfeld.

### ESCAPE FROM THE BRONX ZOO

Written & Directed by Matthew Jellison for Alex Malan, age 10  
Costume Designer: Crystal Thompson

Kerouac ..... Alex Malan  
Dauntless ..... Matthew Jellison  
Voice ..... Doris Alcantara  
Guards ..... Doris Alcantara, Jordana De La Cruz, Maximo Jimenez, Emma Miller

*I'm a Cobra in a Cage* and *My Own Authority* lyrics by Matthew Jellison.

### SKI TO WIN

Written by Emily Chadick Weiss & Directed by Ashley Marie Ortiz  
for Siara Feliciano, age 12  
Costume Designer: Kathleen Doyle

Woman O'War ..... Siara Feliciano  
Pia Piranha ..... Ashley Marie Ortiz  
Announcer ..... Josh Moody  
Giant Squid ..... Josh Moody & the Crew

*Winning Would Be Everything* lyrics by Emily Chadick Weiss.

### DON'T GO TO DINNER

Written by Beto O'Byrne & Directed by Carlo Alban for Jeremy Vasquez, age 11  
Ricky ..... Jeremy Vasquez  
Tomás ..... Carlo Alban

*I Got Problems* lyrics by Beto O'Byrne.

*Additional costume assistance during tech week  
provided by Chloe Chapin and Luis Ortiz.*

The 52nd Street Project gratefully acknowledges the support of the following foundations and corporations: BGC; Big Wood Foundation; Bloomberg; Brenner Family Foundation; Carnegie Corporation of New York; CBS Corporation; Consolidated Edison; Dawkins Family Foundation; The Neil V. DeSena Foundation; The Dramatists Guild Fund; Dramatists Play Service; Eleanor, Adam & Mel Dubin Foundation; The Educational Foundation Of America; Flexis Capital LLC; Sidney E. Frank Foundation; Fund for the City of New York; Goldman Sachs Gives; The Horace W. Goldsmith Foundation; Grant's Financial Publishing, Inc.; The William and Mary Greve Foundation; Heisman Foundation; The Henlopen Foundation; Hudson Scenic Studio; I. Weiss; Integra Realty; The Suzanne Nora Johnson & David G. Johnson Foundation; Lotos Foundation; Ann M. Martin Foundation; Monteforte Foundation; J.P. Morgan Charitable Trust; MTI; National Philanthropic Trust; NYFA; Punchline Magazine; Jonathan Rose Companies; The Shubert Organization; Simon & Eisenberg; St. Vincent De Paul Foundation; Harold & Mimi Steinberg Charitable Trust; Stranahan Foundation; Susquehanna Foundation, Corp.; Tax Pro Financial Network, Inc.; TCG; Theater Subdistrict Council; Theatre Communications Group, Inc.; Tiger Baron Foundation; United Real Estate Ventures, Inc.; Van Deusen Family Fund; Watkins, Inc.; WMEE Foundation; Yorke Construction Corp. In addition, the following individuals made gifts over \$250 to The 52nd Street Project this past year. (list current as of 4/1/11):

Robert Abrams & Cynthia Vance	Cathy Dantchik	John Kyles & Stefanie Kyles	Mike Shaheen
George Ackert	Leslie Dantchik	Michael P. Lawrence	Phil Shaheen
Michael Alicastro	Peter & Judith Dawkins	Warren Leight	Pam Shaw & Victor Syrmis
Jonathan Soros & Jennifer Soros	Russell Dodson	Adrienne Lobel & Mark Linn Baker	Kim Sherman & John Sheehy
Elton Andrews	Michael Dougherty	Susan Hess Lucier	Meg Simon
Richard Anthony	Brian Duggan & Carol Duggan	Thomas Lynch	Ravi Singh
Emily Armstrong	Rick Elliott	John Lyons	Brian Sklar
Dominick & Ilene Balletta	Nigel Faulkner & Amanda Faulkner	Frances McDormand & Joel Coen	Christopher Solomon
Ken Bantum	Peter Jay Fernandez & Denise Burse	Eric Mindich & Stacey Mindich	Steven Starker & Farrell Starker
Lisa Benavides & Tim Nelson	Michael Ferrara	Emily & John Morgan	Jenny & Jon Steingart
Eric Berman & Elizabeth Berman	Randy Frankel	Dexter Morse	Tracy Straus
David Beth	Alison Fraser & Nat Magee	Suzen Murakoshi & Mark Temme	Mike Szwajkowski
Lewis Black	Beverly Gasner	T.J. Nelligan	Jonathan Rose Companies, Inc.
Richard Blackstone & Yildez Yuksek	Alexandra Gersten & John Vassilaros	Randy & Rona Nelson	Anne Tilney & Douglas Kaden
Emily Blavatnik	Scott Aaron Gewirtz & Laura Gewirtz	Ruth Nelson	Liz Tuccillo
Michelle Bork & Jonathan Levine	Stephen & Cathy Graham	Cynthia Nixon	Gregory Tuser
Liz Brixius	Jonathan Groff	Rachel & Larry Norton	Laura Valeroso & David Seidman
Becky Browder & Ted Neustadt	Jan Gura & Alan Pickman	Jodi Nuss	Wendy vanden Heuvel & Brad Coley
Brian Byrnes	David & Ann Hausmann	Kevin O'Rourke & Edith Thurber	Mary Pat Walsh
Shawn Byron & Laura Byron	Peter Herdrich & Karen Trott	Elizabeth Peters	Borah & Mildred Walton
Rich Cancro	Eric & Barbara Hippeau	Bat-Sheva & Thomas Peters	Scott Ward
Lawrence Catena	William Holtzman & S. Sylvia Shepard	Judy Goldman & Michael Pillingier	Sally & Lenny Weiss
Rachel Chanoff	Mary Horowitz	Stephanie Plousis	Jane Bolster & Steve Wertimer
Nora Charles	Sarah Horowitz & David Venarde	Willie Reale & Jenny Gersten	Thomas Whatley
David Cohen & Sandra Novak Cohen	Andrea Johnson	Jacquelyn Reingold	Elizabeth Williams & Joseph Forte
Larry Cohen	Cindy Kaplan & David Froelich	James Rogan	John William & Suzanne William
Melissa Cohn	Kevin Kelly	David Ross & Laura Ross	J.P. Xenakis
Judith-Ann Corrente	Janet Coviello	Carla Sacks & John Morris	Carole Yass & Randy Ginsburg
Kyle Czepiel	Kyle Czepiel	Christian Sauska	Jarrold Yuster
Arthur Dantchik	Ed Keslo		

THE 52ND STREET PROJECT PRESENTS

# NO STRINGS ATTACHED

## THE INDEPENDENT PLAYS

PLAYBACK  
2011

FRIDAY, OCT. 21  
7:30 P.M.

SATURDAY, OCT. 22  
7:30 P.M.

SUNDAY, OCT. 23  
3:00 P.M.

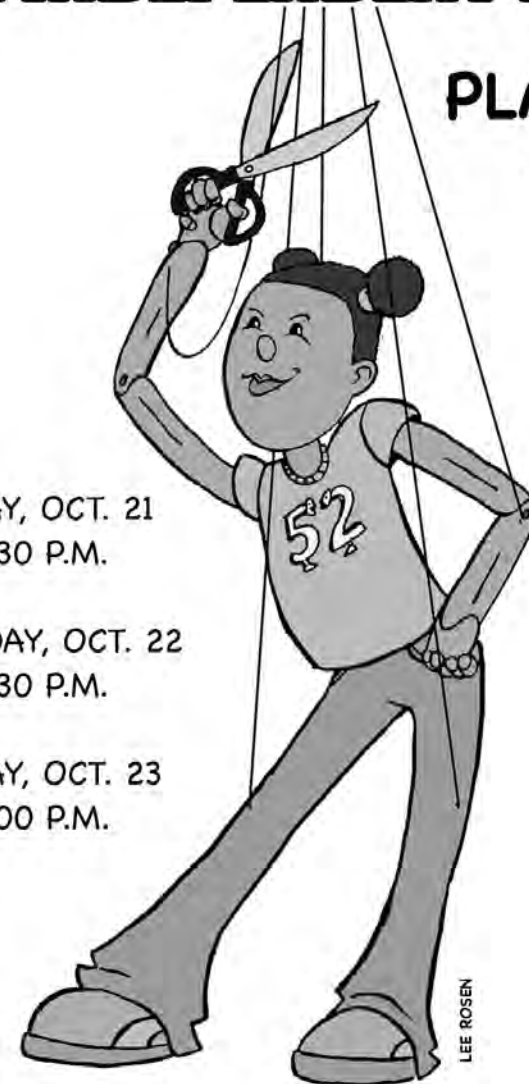

LEE ROSEN

# No Strings Attached: The Independent Plays

Playback 2011 - Oct. 21-23, The Five Angels Theater

## The 52nd Street Project Staff

Gus Rogerson, Artistic Director  
Megan Cramer, Associate Artistic Director  
George Babiak, Production Manager  
Ray Harold, Technical Director  
Carol Ochs, Executive Director  
Lisa Kerner, General Mgmt. Associate  
John Sheehy, Dir. of Development & Marketing  
Josh Moody, Development Associate  
Liz Bell, Director of Education  
Diana Rojas, Community Coordinator

### Consultants:

Iris A. Brown, Graphic Designer; Chris Ceraso, Teen Dean

### Interns:

Steven Hajar, Christina McCarver, Mikaela Mahony

### Teen Employees:

Receptionists: Doris Alcantara, Alvin Garcia, Jason Gil, Jorge Zapata  
Ushers: Michael Bannister, Zoe Norris, Tino Paduani, Francis Williams

## "No Strings Attached" Production Staff

### Composer/Music Director

Cynthia Wong

### Set Designer

Kevin Joseph Roach

### Lighting Designer

Greg McPherson

### Costume Designer

Sarah Swafford

### Sound Designer

Chris Steele-Nicholson

### Stage Manager

Liz Bell

### Slide Designs

George Babiak  
and the Project Slide Archive

### Prop Design Team

George Babiak, Megan Cramer,  
Steven Hajar, Ashley Melon,  
Josh Moody, Lee Rosen

### Backstage Crew

Jon Bass, Tatiana Goode,  
Christina McCarver, Ashley Smith

### House Managers

Liz Bell, Karin Schall,  
Mary Pat Walsh

### Show Photographer

Winston Rodney

### Chefs

Liz Bell, John Sheehy

### Bridgeton Hosts

John Vassilaros,  
Alex Gersten-Vassilaros,  
and Tonio, Luka, and  
Stefano Vassilaros

## COOL STUFF ON SALE IN THE LOBBY!

Fabulous Flyer Bars ..... \$2.50, \$2, \$1.50

and featuring Shel Silverstein's  
"Fivey and Twoey" logo:

Project T-shirts ..... \$12.00  
Project Hoodies ..... \$30.00  
Project Caps ..... \$20.00  
Project Mugs ..... \$5.00  
Project Pencil 3-pack ..... \$1.00  
Project Notebook ..... \$5.00

Thank you for coming to NO STRINGS ATTACHED! If you are not on our mailing list (or if your address has changed), please fill out this form and give it to us on your way out or mail it to the address below. We would also like to know if you are interested in becoming a volunteer. We need help in all areas, so be sure to fill out the entire form.

PLEASE ADD ME TO YOUR MAILING LIST:

10/11

NAME \_\_\_\_\_

ADDRESS \_\_\_\_\_

CITY \_\_\_\_\_

STATE \_\_\_\_\_

ZIP \_\_\_\_\_

HOME PHONE \_\_\_\_\_

DAYTIME OR MOBILE PHONE \_\_\_\_\_

E-MAIL ADDRESS \_\_\_\_\_

MY OCCUPATION \_\_\_\_\_

MY HOBBIES \_\_\_\_\_

YES, I WOULD LIKE TO BE OF HELP. I CAN:

- |   |  |  |
|---|--|--|
| <input type="checkbox"/> Draw and/or paint            | <input type="checkbox"/> Help kids with homework |  |
| <input type="checkbox"/> Hang lights                  | <input type="checkbox"/> Help with mailings      | <input type="checkbox"/> Teach kids a skill      |
| <input type="checkbox"/> Work on a backstage crew     | <input type="checkbox"/> Do office work          | <input type="checkbox"/> Be a chef at an event   |
| <input type="checkbox"/> Do graphic design            | <input type="checkbox"/> Design sound            | <input type="checkbox"/> Design and sew costumes |
| <input type="checkbox"/> Other (please specify) _____ |  |  |

MY SCHEDULE IS:

- Very flexible. I'm often available during weekdays.  
 Somewhat flexible. I can help on the occasional morning or afternoon during the week.  
 Not very flexible at all, but I've got some free time on evenings and weekends.

If you would like to mail this (and you're always welcome to enclose a tax-deductible contribution), you can send it to: The 52nd Street Project, 789 10th Avenue, New York, NY 10019. Or fax it to (212) 333-5598.



This program is supported, in part, by public funds from The New York City Department of Cultural Affairs in partnership with the City Council. The Playback Program is also made possible with public funds from The National Endowment for the Arts and The New York State Council on the Arts, a state agency. The 52nd Street Project is supported by the Open Society Foundations and the Fund for the City of New York. The Project is a member of ART/NY.

**COMING UP SOON AT THE PROJECT!**

**BOUNCING  
BACK!**



# THE RESILIENT PLAYS

*THE FALL 2011 PLAYMAKING SHOWS*

**December 9-11, 2011**

**at The Five Angels Theater**

Last month, the youngest Project members began Playmaking Director Megan Cramer's class in the fine art of Playmaking.

Come see N.Y.'s best adult actors interpret the work of 10 year old playwrights.



**BE ON THE LOOKOUT!  
WE ARE ALWAYS  
SEARCHING FOR INTERNS.**

If you know of any college or graduate students who might enjoy working with us, playing with us, and going on trips with us for a semester, please have them contact Lisa Kerner. We are especially looking for interns for the Spring and Summer of 2012. Thanks!

## **The 52nd Street Project Board of Directors**

Lisa Benavides	Carol Ochs
Rachel Chanoff	Willie Reale, founder
Cathy Dantchik	Gus Rogerson
Carolyn DeSena	Shirley Rumierk, <i>alumni member</i>
Wendy Ettinger, <i>chair emeritus</i>	José Soto, Jr., <i>alumni member</i>
Louis P. Friedman	Jenny Steingart
Robert Goldberg	Lisa Tilney
Stephen Graham, chair	Merritt Tilney
Valerie Kay	Pamala Tyson
James McDaniel	Wendy vanden Heuvel
Frances McDormand	John A. Vassilaros
Noël Mihalow	

---

### **What's Going On Here?**

The 52nd Street Project is a non-profit organization that brings children from the Hell's Kitchen neighborhood together with professional theater artists to create original theater. NO STRINGS ATTACHED is a production of our Playback program, in which kid actor/playwrights wrote plays for themselves and adult actor/director partners. Everyone ventured to the Hamptons for a rehearsal retreat over the Columbus Day weekend. All of the kids involved are veterans of the Playmaking classes which were adapted for the Project by Daniel Judah Sklar from his book *Playmaking: Children Writing and Performing Their Own Plays*.

---

### **In-Kind Contributions**

The Murphy Law Office; Abbeville Press; Stephanie Berger Photography; Lewis Black; Richard Blackstone; Iris A. Brown Design; City Winery; William Curran & A Curran Affair; Kate Cusack; EMI Records; ICI; The S.F. Giants; Newman's Own; Macy's; Pharma Print; PineRock; The N; Shapiro Lobel, LLP; Wendy Stuhlberg; The Yankees; John A. Vassilaros; Watkins, Inc.; Mayor's Office of Film & Television; Boylan's Bottling Co.; Hudson Scenic; and Paul, Weiss, Rifkind, Wharton & Garrison LLP.

---

### **Special Thanks**

We're extremely grateful to John Vassilaros, Alex Gersten-Vassilaros, their boys Tonio, Luka and Stefano, and the ever-helpful Joyce for allowing us to use their home as our headquarters on our rehearsal trip to the Hamptons. Thanks also to Laurie Becker, the Rubin family, and the Friedman family, who let some of our volunteers crash at their homes in Bridgehampton.

## No Strings Attached - Act 1

All original music composed by Cynthia Wong, except where noted.

### ARE YOU JEALOUS OF ME NOW?

Written by Tiara Varela, age 13.

Director/Dramaturge: Brielle Silvestri.

Andrea .....Tiara Varela  
 Jennifer ..... Brielle Silvestri  
 Fuché.....George Babiak  
 Party Person.....Christina McCarver  
 Party People .....Backstage Crew

*The Truth Came Out* lyrics by Tiara Varela.

### THE SWITCH

Written by Nathaniel Butler, age 13.

Director/Dramaturge: Michael Propster.

Billy Jack..... Nathaniel Butler  
 Blank.....Michael Propster  
 Security Guards..... Ashley Smith & Tatiana Goode

*The Weird Song* lyrics by Nathaniel Butler.

### GET THAT RAISE!

Written by Ashley Melon, age 13.

Director/Dramaturge: Donya K. Washington.

Elizabeth Trunkinbottom ..... Ashley Melon  
 Melissa Petalfoot .....Donya Washington  
 Boss.....Megan Cramer

*Gotta Get Outta Here* and *Spritz Co. Jingle* lyrics by Ashley Melon.

### HOT DOGS AND BASEBALL

Written by Joseph Vasquez, age 13.

Director/Dramaturge: Jeremy Beck.

Tino Jimenez ..... Joseph Vasquez  
 Remy Epton ..... Jeremy Beck  
 Joe.....Gus Rogerson  
 Baseball Team .....Backstage Crew

*Baseball* lyrics by Joseph Vasquez.



## No Strings Attached - Act 2

### SOMEBODY

Written by Lucas Ruedel, age 13.

Director/Dramaturge: Matt Citron.

Chris .....Lucas Ruedel  
 Troy ..... Matt Citron  
 Mr. Baws.....George Babiak  
 Shy the Lizard..... Matt Citron  
 Reporter..... Christina McCarver

*Burning Wizard, Argument Song, Melting Rock* lyrics by Lucas Ruedel.

Music by Lucas Ruedel & Matt Citron.

### ZOMBIES ATTACK

Written by Venecia Escamilla, age 12.

Director/Dramaturge: Charise Castro Smith.

Tiana.....Venecia Escamilla  
 Mia.....Charise Castro Smith  
 People in Ice Cream Shop.....Backstage Crew

*Zombie Family* lyrics by Venecia Escamilla.

### PARTNERS NO MATTER WHAT

Written by Nicholas Carrero, age 13.

Director/Dramaturge: Raul Castillo.

Detective Nicholson.....Nicholas Carrero  
 Detective Lopez.....Raul Castillo  
 Investigator .....John Sheehy

*Why Did You Do It* lyrics by Nicholas Carrero.

### THINGS DON'T ALWAYS TURN OUT PICTURE PERFECT

Written by Alizette Zapata, age 13.

Director/Dramaturge: Emily Dorsch.

Nicole.....Alizette Zapata  
 Khloe .....Emily Dorsch  
 Barista ..... Tatiana Goode

*I'm Done* lyrics by Alizette Zapata.





The 52nd Street Project gratefully acknowledges the support of the following foundations and corporations: BGC; Big Wood Foundation; Bloomberg; Brenner Family Foundation; Carnegie Corporation of New York; CBS Corporation; Consolidated Edison; Dawkins Family Foundation; The Neil V. DeSena Foundation; The Dramatists Guild Fund; Dramatists Play Service; Eleanor, Adam & Mel Dubin Foundation; The Educational Foundation Of America; Flexis Capital LLC; Sidney E. Frank Foundation; Fund for the City of New York; Goldman Sachs Gives; The Horace W. Goldsmith Foundation; Grant's Financial Publishing, Inc.; The William and Mary Greve Foundation; Heisman Foundation; The Henlopen Foundation; Hudson Scenic Studio; I. Weiss; Integra Realty; The Suzanne Nora Johnson & David G. Johnson Foundation; Lotos Foundation; Ann M. Martin Foundation; Monteforte Foundation; J.P. Morgan Charitable Trust; MTI; National Philanthropic Trust; NYFA; Punchline Magazine; Jonathan Rose Companies; The Shubert Organization; Simon & Eisenberg; St. Vincent De Paul Foundation; Harold & Mimi Steinberg Charitable Trust; Stranahan Foundation; Susquehanna Foundation, Corp.; Tax Pro Financial Network, Inc.; TCG; Theater Subdistrict Council; Theatre Communications Group, Inc.; Tiger Baron Foundation; United Real Estate Ventures, Inc.; Van Deusen Family Fund; Watkins, Inc.; WMEE Foundation; Yorke Construction Corp. In addition, the following individuals made gifts over \$250 to The 52nd Street Project this past year. (list current as of 4/1/11):

Robert Abrams & Cynthia Vance  
George Ackert  
Michael Alicastro  
Jonathan Soros & Jennifer Soros  
Elton Andrews  
Richard Anthony  
Emily Armstrong  
Dominick & Ilene Balletta  
Ken Bantum  
Lisa Benavides & Tim Nelson  
Eric Berman & Elizabeth Berman  
David Beth  
Lewis Black  
Richard Blackstone & Yildez Yuksek  
Emily Blavatnik  
Michelle Bork & Jonathan Levine  
Liz Brixius  
Becky Browder & Ted Neustadt  
Brian Byrnes  
Shawn Byron & Laura Byron  
Rich Cancro  
Lawrence Catena  
Rachel Chanoff  
Nora Charles  
David Cohen & Sandra Novak Cohen  
Larry Cohen  
Melissa Cohn  
Judith-Ann Corrente  
Janet Coviello  
Kyle Czepiel  
Arthur Dantchik

Cathy Dantchik  
Leslie Dantchik  
Peter & Judith Dawkins  
Russell Dodson  
Michael Dougherty  
Brian Duggan & Carol Duggan  
Rick Elliott  
Nigel Faulkner & Amanda Faulkner  
Peter Jay Fernandez & Denise Burse  
Michael Ferrara  
Randy Frankel  
Alison Fraser & Nat Magee  
Beverly Gasner  
Alexandra Gersten & John Vassilaros  
Scott Aaron Gewirtz & Laura Gewirtz  
Stephen & Cathy Graham  
Jonathan Groff  
Jan Gura & Alan Pickman  
David & Ann Hausmann  
Peter Herdrich & Karen Trott  
Eric & Barbara Hippeau  
William Holtzman & S. Sylvia Shepard  
Mary Horowitz  
Sarah Horowitz & David Venarde  
Andrea Johnson  
Cindy Kaplan & David Froelich  
Kevin Kelly  
Patrick Kelly & Diane Kelly  
Ed Keslo

John Kyles & Stefanie Kyles  
Michael P. Lawrence  
Warren Leight  
Adrienne Lobel & Mark Linn Baker  
Susan Hess Lucier  
Thomas Lynch  
John Lyons  
Frances McDormand & Joel Coen  
Eric Mindich & Stacey Mindich  
Emily & John Morgan  
Dexter Morse  
Suzen Murakoshi & Mark Temme  
T.J. Nelligan  
Randy & Rona Nelson  
Ruth Nelson  
Cynthia Nixon  
Rachel & Larry Norton  
Jodi Nuss  
Kevin O'Rourke & Edith Thurber  
Elizabeth Peters  
Bat-Sheva & Thomas Peters  
Judy Goldman & Michael Pillinger  
Stephanie Plouvis  
Willie Reale & Jenny Gersten  
Jacquelyn Reingold  
James Rogan  
David Ross & Laura Ross  
Carla Sacks & John Morris  
Christian Sauska

Mike Shaheen  
Phil Shaheen  
Pam Shaw & Victor Syrmis  
Kim Sherman & John Sheehy  
Meg Simon  
Ravi Singh  
Brian Sklar  
Christopher Solomon  
Steven Starker & Farrell Starker  
Jenny & Jon Steingart  
Tracy Straus  
Mike Szwajkowski  
Jonathan Rose Companies, Inc.  
Anne Tilney & Douglas Kaden  
Liz Tuccillo  
Gregory Tusar  
Laura Valeroso & David Seidman  
Wendy vanden Heuvel & Brad Coley  
Mary Pat Walsh  
Borah & Mildred Walton  
Scott Ward  
Sally & Lenny Weiss  
Jane Bolster & Steve Wertimer  
Thomas Whatley  
Elizabeth Williams & Joseph Forte  
John William & Suzanne William  
J.P. Xenakis  
Carole Yass & Randy Ginsburg  
Jarrod Yuster

THE 52ND STREET PROJECT PRESENTS

# BOUNCING BACK!

## THE RESILIENT PLAYS

THE FALL 2011 PLAYMAKING PLAYS

9

NEW PLAYS  
WRITTEN BY  
KIDS AND  
PERFORMED BY  
ADULT ACTORS



GUS ROGERSON,  
ARTISTIC DIRECTOR

CAROL OCHS,  
EXECUTIVE DIRECTOR

MEGAN CRAMER,  
PLAYMAKING DIRECTOR

AT THE PROJECT'S OWN

## FIVE ANGELS THEATER

FRIDAY, DEC. 9 AT 7:30 P.M.,  
SATURDAY, DEC. 10 AT 3:00 AND 7:30 P.M.,  
SUNDAY, DEC. 11 AT 3:00 P.M.

# BOUNCING BACK: THE RESILIENT PLAYS

The Fall 2011 Playmaking Production - Dec. 9-11, The Five Angels Theater

## The 52nd Street Project Staff

Gus Rogerson, Artistic Director  
 Megan Cramer, Associate Artistic Director  
 George Babiak, Production Manager  
 Ray Harold, Technical Director

Carol Ochs, Executive Director  
 Lisa Kerner, General Mgmt. Associate  
 John Sheehy, Dir. of Development & Marketing  
 Josh Moody, Development Associate

Liz Bell, Director of Education  
 Diana Rojas, Community Coordinator

### Consultants:

Iris A. Brown, Graphic Designer; Chris Ceraso, Teen Dean

### Interns:

Steven Hajar, Christina McCarver

### Teen Employees:

Receptionists: Doris Alcantara, Alvin Garcia, Jason Gil, Jorge Zapata  
 Ushers: Michael Bannister, Maximo Jimenez, Luisa Santiago, Kara Thiam

## “Bouncing Back” Production Staff

Composer/Music Director Patrick Barnes	Set Designer Kevin Joseph Roach	Lighting Designer Greg MacPherson	Costume Designers Lara deBruijn, Crystal Thompson, Corie Wallace	Goddess of Sound Vanessa Valdes	Stage Manager Laura Kim	Projection Design: George Babiak, Julie Sharbutt, and the Project Slide Archive	Prop Design Team George Babiak, Liz Bell, Megan Cramer, Steven Hajar, Lisa Kerner, Julie Sharbutt	Backstage Crew Steven Hajar, Christina McCarver, Chamel Rodney, Ruby Zamora	House Managers Liz Bell, Lisa Kerner, Mary Pat Walsh	Flyer Art Nathan Wright	Chefs Iris Brown, Joe White, Liz Bell, Carol Ochs	Playmaking Class Volunteers Carlo Alban, Steven Boyer, Sofia Duran, Nancy Giles, Lucas Kavner, Judy Kuhn, Victor Lesniewski, Jo Mei, Corliss Parker	Playmaking Class Teen Assistant Joyce Cheung	Production Photographer Winston Rodney
---	------------------------------------	--------------------------------------	--	------------------------------------	----------------------------	---	--	---	---	----------------------------	---	---	---	---



This program is supported, in part, by public funds from The New York City Department of Cultural Affairs in partnership with the City Council. The Playmaking Program is also made possible with public funds from The National Endowment for the Arts and The New York State Council on the Arts, a state agency. The 52nd Street Project is supported by the Open Society Foundations and the Fund for the City of New York. The Project is a member of ART/NY.

## COOL STUFF ON SALE IN THE LOBBY!

Fabulous Flyer Bars ..... \$2.50, \$2, \$1.50

and featuring Shel Silverstein's  
 "Fivey and Twoey" logo:

Project T-shirts ..... \$12.00  
 Project Hoodies ..... \$30.00  
 Project Caps ..... \$20.00  
 Project Mugs ..... \$5.00  
 Project Pencil 3-pack ..... \$1.00  
 Project Notebook ..... \$5.00

Thank you for coming to **BOUNCING BACK!** If you are not on our mailing list (or if your address has changed), please fill out this form and give it to us on your way out or mail it to the address below. We would also like to know if you are interested in becoming a volunteer. We need help in all areas, so be sure to fill out the entire form.

PLEASE ADD ME TO YOUR MAILING LIST:

12/11

NAME \_\_\_\_\_

ADDRESS \_\_\_\_\_

CITY \_\_\_\_\_ STATE \_\_\_\_\_ ZIP \_\_\_\_\_

HOME PHONE \_\_\_\_\_

DAYTIME OR MOBILE PHONE \_\_\_\_\_ E-MAIL ADDRESS \_\_\_\_\_

MY OCCUPATION \_\_\_\_\_

MY HOBBIES \_\_\_\_\_

### YES, I WOULD LIKE TO BE OF HELP. I CAN:

- |   |  |
|---|--|
| <input type="checkbox"/> Draw and/or paint            | <input type="checkbox"/> Help kids with homework |
| <input type="checkbox"/> Hang lights                  | <input type="checkbox"/> Help with mailings      |
| <input type="checkbox"/> Work on a backstage crew     | <input type="checkbox"/> Do office work          |
| <input type="checkbox"/> Do graphic design            | <input type="checkbox"/> Design sound            |
| <input type="checkbox"/> Other (please specify) _____ | <input type="checkbox"/> Teach kids a skill      |
|   | <input type="checkbox"/> Be a chef at an event   |
|   | <input type="checkbox"/> Design and sew costumes |

### MY SCHEDULE IS:

- Very flexible. I'm often available during weekdays.
- Somewhat flexible. I can help on the occasional morning or afternoon during the week.
- Not very flexible at all, but I've got some free time on evenings and weekends.

If you would like to mail this (and you're always welcome to enclose a tax-deductible contribution), you can send it to: The 52nd Street Project, 789 10th Ave., New York, NY 10019. Or fax it to (212) 333-5598.

DON'T MISS OUR NEXT SHOW!

Gus Rogerson,  
Artistic Director

The 52nd Street Project Presents  
The 2012 2-on-2's

Carol Ochs,  
Executive Director

# WIDE OPEN SPACES

THE OUTDOOR PLAYS

6 NEW PLAYS ★ 6 ADULT WRITERS ★ 6 ADULT DIRECTORS ★ 12 KID ACTORS



FRIDAY, JAN. 27 @ 7:30 P.M., SATURDAY, JAN. 28 @ 7:30 P.M.  
AND SUNDAY, JAN. 29 @ 3:00 P.M.

ALL PERFORMANCES AT THE 52ND STREET PROJECT'S

**FIVE ANGELS THEATER**

789 10TH AVENUE, BETWEEN 52ND & 53RD ST.

ADMISSION IS FREE, BUT RESERVATIONS ARE HIGHLY RECOMMENDED! CALL (212) 642-5052 TO BOOK YOUR SEATS.

## The 52nd Street Project Board of Directors

Lisa Benavides	Carol Ochs
Rachel Chanoff	Willie Reale, founder
Cathy Dantchik	Gus Rogerson
Carolyn DeSena	Shirley Rumierk, alumni member
Wendy Ettinger, chair emeritus	José Soto, Jr., alumni member
Louis P. Friedman	Jenny Steingart
Robert Goldberg	Lisa Tilney
Stephen Graham, chair	Merritt Tilney
James McDaniel	Pamala Tyson
Frances McDormand	Wendy vanden Heuvel
Noël Mihalow	John A. Vassilaros

### What's Going On Here?

The 52nd Street Project is a non-profit organization that brings children from the Hell's Kitchen neighborhood together with professional theater artists to create original theater. *BOUNCING BACK* is a production of our Playmaking program. Young people participate in a nine-week playwriting course taught by Megan Cramer and adapted for the Project by Daniel Judah Sklar from his book *Playmaking: Children Writing and Performing Their Own Plays*. At the end of the course, each child is matched with two actors and a dramaturg/director who guides him or her through the writing of a play during a weekend retreat in the country (Stone Ridge, New York, for this show). This performance is the end result.

### In-Kind Contributions

The Murphy Law Office; Abbeville Press; Stephanie Berger Photography; Lewis Black; Richard Blackstone; Iris A. Brown Design; City Winery; William Curran & A Curran Affair; Kate Cusack; EMI Records; ICI; The S.F. Giants; Newman's Own; Macy's; Pharma Print; PineRock; The N; Shapiro Lobel, LLP; Wendy Stuhlberg; The Yankees; John A. Vassilaros; Watkins, Inc.; Boylan's Bottling Co.; Hudson Scenic; and Paul, Weiss, Rifkind, Wharton & Garrison LLP.

### Special Thanks

We're extremely grateful to Steve Gorn and Barbara Bash for the use of their beautiful home in Stone Ridge, NY as our base of operations for the writer's retreat. The indispensable host families were Joe White & Iris Brown (who doubled as chefs), Charlie Miles & Naomi Freundlich, Sean Cullen & Tess Hartman, Jeff Madalena & Jason Gnewikow, David Curtiss & Ann Morris, Amy Weiss & Michael McClatchy, and Nicole & Paul Quinn.



**BE ON THE LOOKOUT!**  
WE ARE ALWAYS  
SEARCHING FOR INTERNS.

If you know of any college or graduate students who might enjoy working with us, playing with us, and going on trips with us for a semester, please have them contact George Babiak or Megan Cramer. We are currently looking for interns for the summer of 2012. Thanks!

## **BOUNCING BACK: THE RESILIENT PLAYS - ACT 1**

All original music composed by Patrick Barnes

### **BALLERINA TROUBLE**

Written by Imani Lewis, age 11

Director/Dramaturge: John Sheehy

Costume Designer: Crystal Thompson

Lowkey Lisa..... Wrenn Schmidt

Jake.....Robert Stanton

### **THE CROW AND THE ROBBER**

Written by Kate Mendoza, age 10

Director/Dramaturge: Maureen Towey

Costume Designer: Corie Wallace

Jack..... Maria-Christina Oliveras

Rachel the Crow.....Francis Benhamou

*My Evil Plan* lyrics by Kate Mendoza

### **THE WIMPY PLAYER**

Written by Alex Bonnet, age 11

Dramaturge: Alexandra O'Daly. Director: Davis McCallum

Costume Designer: Corie Wallace

Greg.....Alex Draper

Joe.....Brandon Dirden

Mom's Voice/Computer.....Christina McCarver

Dad's Voice/Somebody.....Steven Hajar

### **THE MONKEY ADVENTURE**

Written by Maria Martinez, age 10

Director/Dramaturge: Carlos Armesto

Costume Designer: Lara deBruijn

Megan.....Kimiye Corwin

Max.....A.Z. Kelsey

Dad.....John Sheehy

Ghost Mom.....Alexandra O'Daly

*The Wishes and We Are the Family* lyrics by Maria Martinez

### **ME AND SIS**

Written by Joseph Cruz, age 10

Director/Dramaturge: Awoye Timpo

Costume Designer: Lara deBruijn

Jack.....Edward O'Blenis

Mairy.....Shirley Rumierk

*Heart and Me and You* lyrics by Joseph Cruz

## **BOUNCING BACK: THE RESILIENT PLAYS - ACT 2**

### **THE ZOO**

Written by Chayse Peña, age 11

Director/Dramaturge: Don Nguyen

Costume Designer: Lara deBruijn

John..... Joe Paulik

Mr. Grumpy.....Felix Solis

Pigs and Cows..... The Crew

*Animals Talk* lyrics by Chayse Peña

### **BEST FRIENDS**

Written by Jasmine Nicole Correa, age 11

Director/Dramaturge: Tamara Fisch

Costume Designer: Corie Wallace

Emmerson Wellington..... Jo Mei

Maria Sanchez.....Megan Ketch

*I Wish I Could Change Time* lyrics by Jasmine Nicole Correa

### **THE MAD SCIENTIST AND THE WEIRDO**

Written by Bamba Thiam, age 10

Director/Dramaturge: Lucas Caleb Rooney

Costume Designer: Corie Wallace

Grady McShady.....Carson Elrod

Don Jockervictsteron.....Bill Camp

Audience Member.....George Babiak

Rock.....Ruby Zamora

Dead Bodies.....The Crew

*Beautiful* lyrics by Bamba Thiam

### **LUCY & MADISON**

Written by Ashley Thomas, age 11

Director/Dramaturge: Patricia McGregor

Costume Designer: Lara deBruijn

Madison Perez.....Jessica Hecht

Lucy Roberston.....Mia Barron

*Madison's Rap, Lucy's Dancing and Doesn't Matter Who You Are*  
lyrics by Ashley Thomas

The 52nd Street Project gratefully acknowledges the support of the following foundations and corporations: BGC; Big Wood Foundation; Bloomberg; Brenner Family Foundation; Carnegie Corporation of New York; CBS Corporation; Consolidated Edison; Dawkins Family Foundation; The Neil V. DeSena Foundation; The Dramatists Guild Fund; Dramatists Play Service; Eleanor, Adam & Mel Dubin Foundation; The Educational Foundation Of America; Flexis Capital LLC; Sidney E. Frank Foundation; Fund for the City of New York; Goldman Sachs Gives; The Horace W. Goldsmith Foundation; Grant's Financial Publishing, Inc.; The William and Mary Greve Foundation; Heisman Foundation; The Henlopen Foundation; Hudson Scenic Studio; I. Weiss; Integra Realty; The Suzanne Nora Johnson & David G. Johnson Foundation; Lotos Foundation; Ann M. Martin Foundation; Monteforte Foundation; J.P. Morgan Charitable Trust; MTI; National Philanthropic Trust; NYFA; Punchline Magazine; Jonathan Rose Companies; The Shubert Organization; Simon & Eisenberg; St. Vincent De Paul Foundation; Harold & Mimi Steinberg Charitable Trust; Stranahan Foundation; Susquehanna Foundation, Corp.; Tax Pro Financial Network, Inc.; TCG; Theater Subdistrict Council; Theatre Communications Group, Inc.; Tiger Baron Foundation; United Real Estate Ventures, Inc.; Van Deusen Family Fund; Watkins, Inc.; WMEE Foundation; Yorke Construction Corp. In addition, the following individuals made gifts over \$250 to The 52nd Street Project this past year. (list current as of 4/1/11):

Robert Abrams & Cynthia Vance	Cathy Dantchik	John Kyles & Stefanie Kyles	Mike Shaheen
George Ackert	Leslie Dantchik	Michael P. Lawrence	Phil Shaheen
Michael Alicastro	Peter & Judith Dawkins	Warren Leight	Pam Shaw & Victor Syrmis
Jonathan Soros & Jennifer Soros	Russell Dodson	Adrienne Lobel & Mark Linn Baker	Kim Sherman & John Sheehy
Elton Andrews	Michael Dougherty	Susan Hess Lucier	Meg Simon
Richard Anthony	Brian Duggan & Carol Duggan	Thomas Lynch	Ravi Singh
Emily Armstrong	Rick Elliott	John Lyons	Brian Sklar
Dominick & Ilene Balletta	Nigel Faulkner & Amanda Faulkner	Frances McDormand & Joel Coen	Christopher Solomon
Ken Bantum	Eric Mindich & Stacey Mindich	Eric Mindich & Stacey Mindich	Steven Starker & Farrell Starker
Lisa Benavides & Tim Nelson	Eric Mindich & Stacey Mindich	Eric Mindich & Stacey Mindich	Jenny & Jon Steingart
Eric Berman & Elizabeth Berman	Eric Mindich & Stacey Mindich	Eric Mindich & Stacey Mindich	Tracy Straus
David Beth	Eric Mindich & Stacey Mindich	Eric Mindich & Stacey Mindich	Mike Szwajkowski
Lewis Black	Eric Mindich & Stacey Mindich	Eric Mindich & Stacey Mindich	Jonathan Rose Companies, Inc.
Richard Blackstone & Yildez Yuksek	Eric Mindich & Stacey Mindich	Eric Mindich & Stacey Mindich	Anne Tilney & Douglas Kaden
Emily Blavatnik	Eric Mindich & Stacey Mindich	Eric Mindich & Stacey Mindich	Liz Tuccillo
Michelle Bork & Jonathan Levine	Eric Mindich & Stacey Mindich	Eric Mindich & Stacey Mindich	Gregory Tusar
Liz Brixius	Eric Mindich & Stacey Mindich	Eric Mindich & Stacey Mindich	Laura Valeroso & David Seidman
Becky Browder & Ted Neustadt	Eric Mindich & Stacey Mindich	Eric Mindich & Stacey Mindich	Wendy vanden Heuvel & Brad Coley
Brian Byrnes	Eric Mindich & Stacey Mindich	Eric Mindich & Stacey Mindich	Mary Pat Walsh
Shawn Byron & Laura Byron	Eric Mindich & Stacey Mindich	Eric Mindich & Stacey Mindich	Borah & Mildred Walton
Rich Cancro	Eric Mindich & Stacey Mindich	Eric Mindich & Stacey Mindich	Scott Ward
Lawrence Catena	Eric Mindich & Stacey Mindich	Eric Mindich & Stacey Mindich	Sally & Lenny Weiss
Rachel Chanoff	Eric Mindich & Stacey Mindich	Eric Mindich & Stacey Mindich	Jane Bolster & Steve Wertimer
Nora Charles	Eric Mindich & Stacey Mindich	Eric Mindich & Stacey Mindich	Thomas Whatley
David Cohen & Sandra Novak Cohen	Eric Mindich & Stacey Mindich	Eric Mindich & Stacey Mindich	Elizabeth Williams & Joseph Forte
Larry Cohen	Eric Mindich & Stacey Mindich	Eric Mindich & Stacey Mindich	James Willian & Suzanne Willian
Melissa Cohn	Eric Mindich & Stacey Mindich	Eric Mindich & Stacey Mindich	J.P. Xenakis
Judith-Ann Corrente	Eric Mindich & Stacey Mindich	Eric Mindich & Stacey Mindich	Carole Yass & Randy Ginsburg
Janet Coviello	Eric Mindich & Stacey Mindich	Eric Mindich & Stacey Mindich	Jarrold Yuster
Kyle Czepiel	Eric Mindich & Stacey Mindich	Eric Mindich & Stacey Mindich	
Arthur Dantchik	Eric Mindich & Stacey Mindich	Eric Mindich & Stacey Mindich	

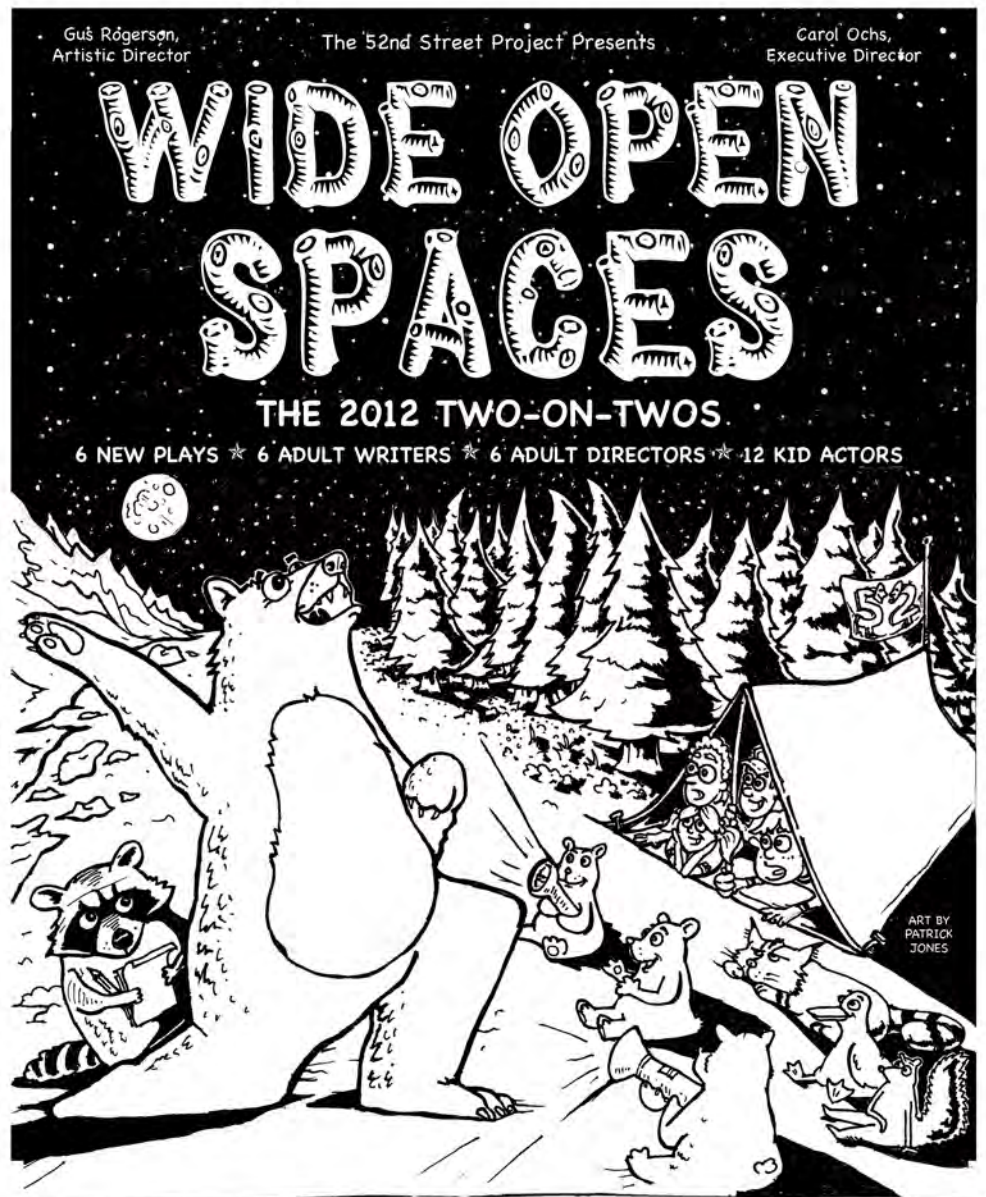

## THE FIVE ANGELS THEATER

FRIDAY, JAN. 27 @ 7:30 P.M.,

SATURDAY, JAN. 28 @ 7:30 P.M.

AND SUNDAY, JAN. 29 @ 3:00 P.M.

# WIDE OPEN SPACES: THE OUTDOOR PLAYS

The 2012 Two-on-Two's - January 27-29, The Five Angels Theater

## The 52nd Street Project Staff

Gus Rogerson, Artistic Director  
 Megan Cramer, Associate Artistic Director  
 George Babiak, Production Manager  
 Ray Harold, Technical Director

Carol Ochs, Executive Director  
 Lisa Kerner, General Mgmt. Associate  
 John Sheehy, Dir. of Development & Marketing  
 Josh Moody, Development Associate

Liz Bell, Director of Education  
 Diana Rojas, Community Coordinator

### Consultants:

Iris A. Brown, Graphic Designer; Chris Ceraso, Teen Dean

### Interns:

Liam Dailey, Selina Petschek, Olivia Strauss, Elisabeth Sutherland

### Teen Employees:

Receptionists: Alvin Garcia, Jason Gil, Jorge Zapata  
 Ushers: Samantha Caldon, Carlos Dume, Kyle Fargardo, Azalea Rosario, Luisa Santiago

## "Wide Open Spaces" Production Staff

### Composer/Music Director

Eric March

### Set Designer

Kevin Joseph Roach

### Lighting Designer

Greg MacPherson

### Lighting Assistants

Josh Langman, Jit Seneviratne

### Costume Designer

Sarah Swafford

### Sound Designer

Maileen Cancel

### Stage Manager

Winnie Lok

### Projection Design:

George Babiak, Elisabeth Sutherland, and the Project Slide Archive.

### Prop Fabrication Team

George Babiak,  
 Liam Dailey,  
 Lee Aaron Rosen,  
 Selina Petschek,  
 Olivia Strauss,  
 Elisabeth Sutherland.

### Backstage Crew

Adnan Ahmed, Jade Cuevas,  
 Liam Dailey, Selina Petschek,  
 Olivia Strauss,  
 Elisabeth Sutherland

### Chefs

John Sheehy, Liz Bell,

## COOL STUFF ON SALE IN THE LOBBY!

Fabulous Flyer Bars .....\$2.00 & \$3.00

and featuring Shel Silverstein's  
 "Fivey and Twoey" logo:

Project T-shirts ..... \$12.00  
 Project Hoodies ..... \$30.00  
 Project Caps.....\$20.00  
 Project Mugs..... \$5.00  
 Project Pencil 3-pack ..... \$1.00  
 Project Notebook..... \$5.00

Thank you for coming to **WIDE OPEN SPACES**. If you are not on our mailing list (or if your address has changed), please fill out this form and give it to us on your way out or mail it to the address below. We would also like to know if you are interested in becoming a volunteer. We need help in all areas, so be sure to fill out the entire form.

PLEASE ADD ME TO YOUR MAILING LIST:

1/12

NAME \_\_\_\_\_

ADDRESS \_\_\_\_\_

CITY \_\_\_\_\_

STATE \_\_\_\_\_

ZIP \_\_\_\_\_

HOME PHONE \_\_\_\_\_

DAYTIME OR MOBILE PHONE \_\_\_\_\_

E-MAIL ADDRESS \_\_\_\_\_

MY OCCUPATION \_\_\_\_\_

MY HOBBIES \_\_\_\_\_

### YES, I WOULD LIKE TO BE OF HELP. I CAN:

- |   |  |
|---|--|
| <input type="checkbox"/> Draw and/or paint            | <input type="checkbox"/> Help kids with homework |
| <input type="checkbox"/> Hang lights                  | <input type="checkbox"/> Help with mailings      |
| <input type="checkbox"/> Work on a backstage crew     | <input type="checkbox"/> Do office work          |
| <input type="checkbox"/> Do graphic design            | <input type="checkbox"/> Design sound            |
| <input type="checkbox"/> Other (please specify) _____ | <input type="checkbox"/> Teach kids a skill      |
|   | <input type="checkbox"/> Be a chef at an event   |
|   | <input type="checkbox"/> Design and sew costumes |

### MY SCHEDULE IS:

- Very flexible. I'm often available during weekdays.
- Somewhat flexible. I can help on the occasional morning or afternoon during the week.
- Not very flexible at all, but I've got some free time on evenings and weekends.

If you would like to mail this (and you're always welcome to enclose a tax-deductible contribution), you can send it to: The 52nd Street Project, 789 10th Ave., New York, NY 10019. Or fax it to (212) 333-5598.



This program is supported, in part, by public funds from The New York City Department of Cultural Affairs in partnership with the City Council. The Two-on-Two's are also made possible with public funds from The National Endowment for the Arts and The New York State Council on the Arts, a state agency. The 52nd Street Project is supported by the Open Society Foundations and the Fund for the City of New York. The Project is a member of ART/NY.

DON'T MISS OUR UPCOMING EVENTS!

# JUMPING OFF THE PAGE PLAYS IN 3D

THE SPRING 2012 PLAYMAKING SHOWS

March 30-April 1 right here at the Five Angels Theater

This month 10 brand-new kids began Playmaking classes with Megan Cramer. Come see their final plays performed by professional adult actors!

Host Billy Crudup and The Board of Directors of The 52nd Street Project invite you to take a second to save the date

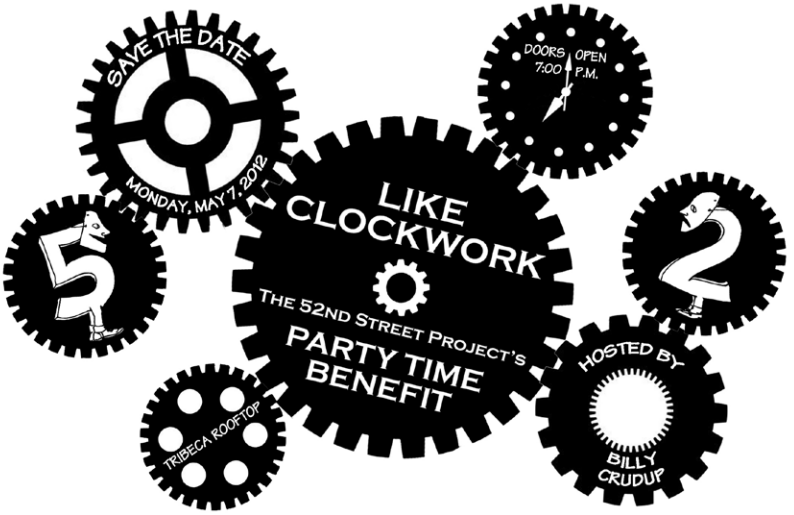

For information or reservations call John "The Watchman" Sheehy @ (212) 333-5252 x. 16 or email [sheehy@52project.org](mailto:sheehy@52project.org)

#### WE ARE ON THE LOOK-OUT FOR INTERNS!

If you know any college or graduate students who might enjoy working with us for a semester please have them contact Lisa Kerner here at the Project. We are currently looking for interns for the summer of 2012. Thanks!

#### The 52nd Street Project Board of Directors

Lisa Benavides	Carol Ochs
Rachel Chanoff	Willie Reale, founder
Cathy Dantchik	Gus Rogerson
Carolyn DeSena	Shirley Rumierk, alumni member
Wendy Ettinger, chair emeritus	José Soto, Jr., alumni member
Louis P. Friedman	Jenny Steingart
Robert Goldberg	Lisa Tilney
Stephen Graham, chair	Merritt Tilney
Valerie Kay	Pamala Tyson
James McDaniel	Wendy vanden Heuvel
Frances McDormand	John A. Vassilaros
Noël Mihalow	

#### What's Going On Here?

The 52nd Street Project is a non-profit organization that brings children from the Hell's Kitchen neighborhood together with professional theater artists to create original theater. WIDE OPEN SPACES is a production of our Two-on-Two's program, in which an adult playwright crafts a piece for a pair of Project kids to perform. Another adult directs the kids for a month that includes an intensive three-day weekend in upstate New York. Tonight's performance is the final result.

#### In-Kind Contributions

The Murphy Law Office; Abbeville Press; Stephanie Berger Photography; Lewis Black; Richard Blackstone; Iris A. Brown Design; City Winery; William Curran & A Curran Affair; Kate Cusack; EMI Records; ICI; The S.F. Giants; Newman's Own; Macy's; Pharma Print; PineRock; The N; Shapiro Lobel, LLP; Wendy Stuhlberg; The Yankees; John A. Vassilaros; Watkins, Inc.; Boylan's Bottling Co.; Hudson Scenic; and Paul, Weiss, Rifkind, Wharton & Garrison LLP.

#### Special Thanks

We owe many thanks to Susanna Styron, Wendy vanden Heuvel & Brad Coley, and Barbara Rosenthal, all of whom graciously allowed us to use their upstate homes for three exhilarating and fun-filled days. We'd also like to thank Sue Webb for her help.

# WIDE OPEN SPACES - ACT 1

All original music composed by Eric March

## NIC AND LUCY IN THE WOODS

Written by Christopher Oscar Peña

Directed by Michael Walkup

Nic ..... Edison Sibri

Lucy/Athena ..... Elizabeth Vazquez

*I'm Afraid of the Night and Now I Know More* lyrics by Christopher Oscar Peña

## POLAR AMBITION

Written by Larkin Clark

Directed by Lee Aaron Rosen

Ned ..... Devin Gonzalez

Ed ..... Wendell Joseph

Elves ..... Adnan Ahmed and Jade Cuevas

Polar Bear ..... Liam Dailey

*Where Caviar Dreams Come True; I, Myself, and Me; and Elf You Up* lyrics by Larkin Clark

## SWAMP!

Written by Melisa Tien

Directed by Molly Coogan

Gigi ..... Gabriella DeJesus

Ella ..... Lauren Robinson

Piranhas ..... The Crew

*Not Just Anyone and All I Needed* lyrics by Melisa Tien

# INTERMISSION

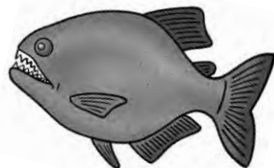

# WIDE OPEN SPACES - ACT 2

## THE INTERROGATION ROOM

Written by Michael Mitnick

Directed by Katie Flahive

Officer Kramer ..... Mari Ulloa

Detective Twist ..... Jasmine Hernandez

*I Love the Great Outdoors* lyrics by Michael Mitnick

## BETTER LIVING THROUGH FORESTRY

Written by Dustin Chinn

Directed by Jacob Grigolia-Rosenbaum

Colby ..... Hashem Ahmed

Kevan ..... Chanel Rodney

Bear ..... Liam Dailey

*We Are Woodsmen* lyrics by Dustin Chinn

## OLD SCHOOL

Written by Liz Flahive

Directed by Rachel Dart

Jimm Special ..... Michael Bannister

Jenny Sue ..... Katie Liu

Magician's Assistants ..... The Crew

Cameraman ..... Adnan Ahmed

*A New Kind of Magic* lyrics by Liz Flahive



The 52nd Street Project gratefully acknowledges the support of the following foundations and corporations: BGC; Big Wood Foundation; Bloomberg; Brenner Family Foundation; Carnegie Corporation of New York; CBS Corporation; Consolidated Edison; Dawkins Family Foundation; The Neil V. DeSena Foundation; The Dramatists Guild Fund; Dramatists Play Service; Eleanor, Adam & Mel Dubin Foundation; The Educational Foundation Of America; Flexis Capital LLC; Sidney E. Frank Foundation; Fund for the City of New York; Goldman Sachs Gives; The Horace W. Goldsmith Foundation; Grant's Financial Publishing, Inc.; The William and Mary Greve Foundation; Heisman Foundation; The Henlopen Foundation; Hudson Scenic Studio; I. Weiss; Integra Realty; The Suzanne Nora Johnson & David G. Johnson Foundation; Lotos Foundation; Ann M. Martin Foundation; Monteforte Foundation; J.P. Morgan Charitable Trust; MTL; National Philanthropic Trust; NYFA; Punchline Magazine; Jonathan Rose Companies; The Shubert Organization; Simon & Eisenberg; St. Vincent De Paul Foundation; Harold & Mimi Steinberg Charitable Trust; Stranahan Foundation; Susquehanna Foundation, Corp.; Tax Pro Financial Network, Inc.; TCG; Theater Subdistrict Council; Theatre Communications Group, Inc.; Tiger Baron Foundation; United Real Estate Ventures, Inc.; Van Deusen Family Fund; Watkins, Inc.; WMEE Foundation; Yorke Construction Corp. In addition, the following individuals made gifts over \$250 to The 52nd Street Project this past year. (list current as of 4/1/11):

Robert Abrams & Cynthia Vance	Cathy Dantchik	John Kyles & Stefanie Kyles	Mike Shaheen
George Ackert	Leslie Dantchik	Michael P. Lawrence	Phil Shaheen
Michael Alicastro	Peter & Judith Dawkins	Warren Leight	Pam Shaw & Victor Syrmis
Jonathan Soros & Jennifer Soros	Russell Dodson	Adrienne Lobel & Mark Linn Baker	Kim Sherman & John Sheehy
Elton Andrews	Michael Dougherty	Mark Linn Baker	Meg Simon
Richard Anthony	Brian Duggan & Carol Duggan	Susan Hess Lucier	Ravi Singh
Emily Armstrong	Rick Elliott	Thomas Lynch	Brian Sklar
Dominick & Ilene Balletta	Nigel Faulkner & Amanda Faulkner	John Lyons	Christopher Solomon
Ken Bantum	Frances McDormand & Joel Coen	Frances McDormand & Joel Coen	Steven Starker & Farrell Starker
Lisa Benavides & Tim Nelson	Peter Jay Fernandez & Denise Burse	Eric Mindich & Stacey Mindich	Jenny & Jon Steingart
Eric Berman & Elizabeth Berman	Michael Ferrara	Emily & John Morgan	Tracy Straus
David Beth	Randy Frankel	Dexter Morse	Mike Szwajkowski
Lewis Black	Alison Fraser & Nat Magee	Suzen Murakoshi & Mark Temme	Jonathan Rose Companies, Inc.
Richard Blackstone & Yildez Yuksek	Beverly Gasner	Mark Temme	Anne Tilney & Douglas Kaden
Emily Blavatnik	Alexandra Gersten & John Vassilaros	T.J. Nelligan	Liz Tuccillo
Michelle Bork & Jonathan Levine	Scott Aaron Gewirtz & Laura Gewirtz	Randy & Rona Nelson	Gregory Tusal
Liz Brixius	Ruth Nelson	Ruth Nelson	Laura Valeroso & David Seidman
Becky Browder & Ted Neustadt	Cynthia Nixon	Cynthia Nixon	Wendy vanden Heuvel & Brad Coley
Brian Byrnes	Rachel & Larry Norton	Rachel & Larry Norton	Mary Pat Walsh
Shawn Byron & Laura Byron	Jodi Nuss	Jodi Nuss	Borah & Mildred Walton
Rich Cancro	Kevin O'Rourke & Edith Thurber	Kevin O'Rourke & Edith Thurber	Scott Ward
Lawrence Catena	Elizabeth Peters	Elizabeth Peters	Sally & Lenny Weiss
Rachel Chanoff	Bat-Sheva & Thomas Peters	Bat-Sheva & Thomas Peters	Jane Bolster & Steve Wertimer
Nora Charles	Judy Goldman & Michael Pillinger	Judy Goldman & Michael Pillinger	Thomas Whatley
David Cohen & Sandra Novak Cohen	Stephanie Plouvis	Stephanie Plouvis	Elizabeth Williams & Joseph Forte
Larry Cohen	Willie Reale & Jenny Gersten	Willie Reale & Jenny Gersten	John William & Suzanne William
Melissa Cohn	Jacquelyn Reingold	Jacquelyn Reingold	J.P. Xenakis
Judith-Ann Corrente	James Rogan	James Rogan	Carole Yass & Randy Ginsburg
Janet Coviello	David Ross & Laura Ross	David Ross & Laura Ross	Jarrold Yuster
Kyle Czepiel	Carla Sacks & John Morris	Carla Sacks & John Morris	
Arthur Dantchik	Christian Sauska	Christian Sauska	

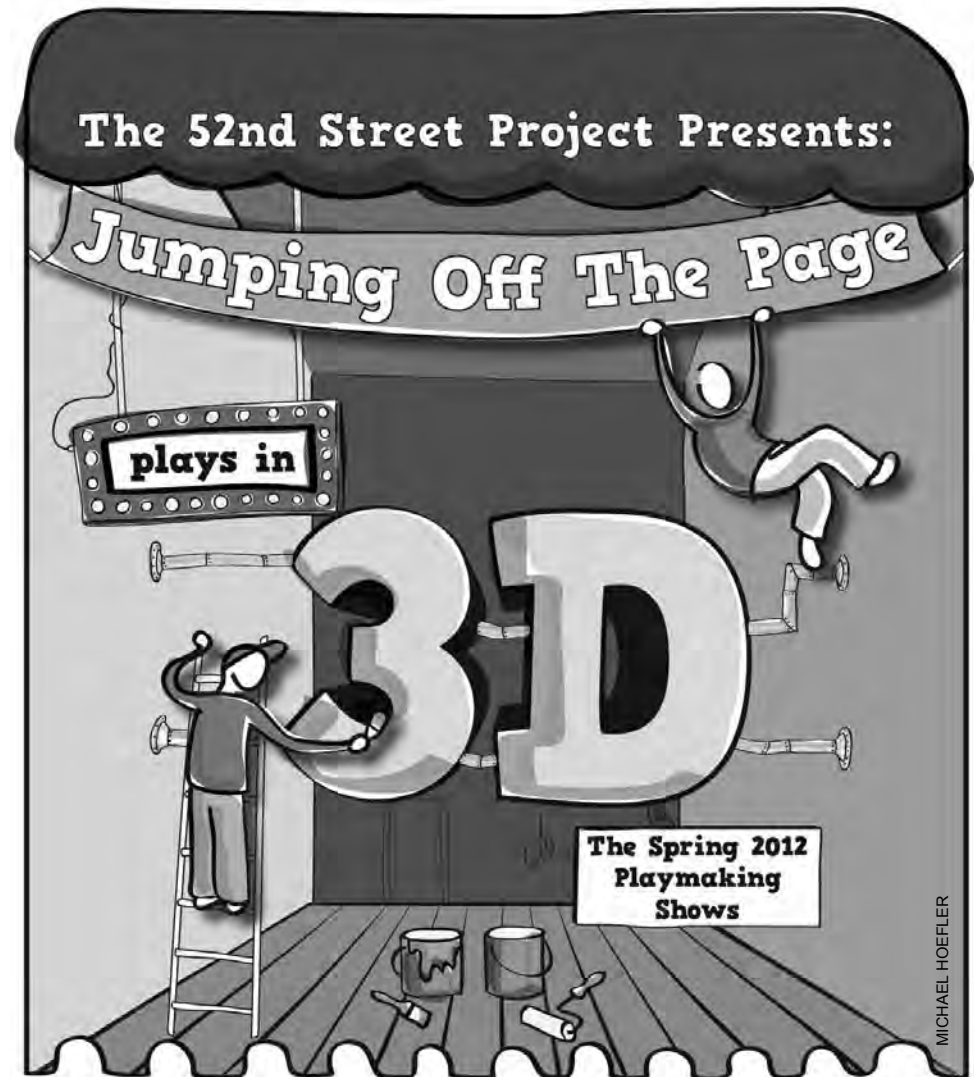

**10 new plays written by kids  
and performed by adult actors.**

Friday, March 30 at 7:30 p.m.  
Saturday, March 31 at 3:00 and 7:30 p.m.  
Sunday, April 1 at 3:00 p.m.

**THE FIVE ANGELS THEATER**

# JUMPING OFF THE PAGE: PLAYS IN 3D

The Spring 2012 Playmaking Production - March 30-April 1, The Five Angels Theater

## The 52nd Street Project Staff

Gus Rogerson, Artistic Director  
 Megan Cramer, Associate Artistic Director  
 George Babiak, Production Manager  
 Ray Harold, Technical Director  
 Carol Ochs, Executive Director  
 Lisa Kerner, General Mgmt. Associate  
 John Sheehy, Dir. of Development & Marketing  
 Josh Moody, Development Associate  
 Liz Bell, Director of Education  
 Diana Rojas, Community Coordinator

### Consultants:

Iris A. Brown, Graphic Designer; Chris Ceraso, Teen Dean

### Interns:

Jonathan Sokolow, Olivia Strauss, Elisabeth Sutherland

### Teen Employees:

Receptionists: Joyce Cheung, Alvin Garcia, Jason Gil, Jorge Zapata  
 Ushers: Doris Alcantara, Elena Caballero, David McCall, Malik Velazquez

## “Jumping Off the Page” Production Staff

Composer/Music Director Cynthia Wong	Set Designer Kevin Joseph Roach	Lighting Designer Greg MacPherson	Costume Designers Sarita Fellows, Chris Rumery	Sound Designer Betsy Rhodes	Stage Manager Charles M. Turner, III	Projection Design: George Babiak, Julie Sharbutt, Elisabeth Sutherland and the Project Slide Archive	Prop Design Team George Babiak, Lisa Kerner, Julie Sharbutt, Jonathan Sokolow, Olivia Strauss, Elisabeth Sutherland	Backstage Crew Eric Carrero, Jonathan Sokolow, Olivia Strauss, Elisabeth Sutherland, Kara Thiam, Amber Urefia	House Managers Liz Bell, Lisa Kerner, Mary Pat Walsh	Flyer Art Michael Hoeffler	Chefs John Sheehy, Liz Bell, Carol Ochs	Playmaking Class Volunteers Todd Bartels, Jon Bass, Erin Cherry, Evan Enderle, Aaron Levy, Nick Mills, Larry Nathanson, Lucas Caleb Rooney, Christina Roussos, Blake Whitney	Playmaking Class Teen Assistant Terrence Mack	Production Photographer Winston Rodney
---	------------------------------------	--------------------------------------	---	--------------------------------	---	---	--	--	---	-------------------------------	--	--	--	---



This program is supported, in part, by public funds from The New York City Department of Cultural Affairs in partnership with the City Council. The Playmaking Program is also made possible with public funds from The National Endowment for the Arts and The New York State Council on the Arts, a state agency. The 52nd Street Project is supported by the Open Society Foundations and the Fund for the City of New York. The Project is a member of ART/NY.

## COOL STUFF ON SALE IN THE LOBBY!

Fabulous Flyer Bars .....\$2.00 & \$3.00

and featuring Shel Silverstein's  
 “Fivey and Twoey” logo:

Project T-shirts ..... \$12.00  
 Project Hoodies ..... \$30.00  
 Project Caps ..... \$20.00  
 Project Mugs ..... \$5.00  
 Project Pencil 3-pack ..... \$1.00  
 Project Notebook ..... \$5.00

Thank you for coming to **JUMPING OFF THE PAGE!** If you are not on our mailing list (or if your address has changed), please fill out this form and give it to us on your way out or mail it to the address below. We would also like to know if you are interested in becoming a volunteer. We need help in all areas, so be sure to fill out the entire form.

PLEASE ADD ME TO YOUR MAILING LIST: 3/12

NAME \_\_\_\_\_

ADDRESS \_\_\_\_\_

CITY \_\_\_\_\_ STATE \_\_\_\_\_ ZIP \_\_\_\_\_

HOME PHONE \_\_\_\_\_

DAYTIME OR MOBILE PHONE \_\_\_\_\_ E-MAIL ADDRESS \_\_\_\_\_

MY OCCUPATION \_\_\_\_\_

MY HOBBIES \_\_\_\_\_

### YES, I WOULD LIKE TO BE OF HELP. I CAN:

- |   |  |
|---|--|
| <input type="checkbox"/> Draw and/or paint            | <input type="checkbox"/> Help kids with homework |
| <input type="checkbox"/> Hang lights                  | <input type="checkbox"/> Help with mailings      |
| <input type="checkbox"/> Work on a backstage crew     | <input type="checkbox"/> Do office work          |
| <input type="checkbox"/> Do graphic design            | <input type="checkbox"/> Design sound            |
| <input type="checkbox"/> Other (please specify) _____ | <input type="checkbox"/> Teach kids a skill      |
|   | <input type="checkbox"/> Be a chef at an event   |
|   | <input type="checkbox"/> Design and sew costumes |

### MY SCHEDULE IS:

- Very flexible. I'm often available during weekdays.  
 Somewhat flexible. I can help on the occasional morning or afternoon during the week.  
 Not very flexible at all, but I've got some free time on evenings and weekends.

If you would like to mail this (and you're always welcome to enclose a tax-deductible contribution), you can send it to: The 52nd Street Project, 789 10th Ave., New York, NY 10019. Or fax it to (212) 333-5598.

OUR NEXT PRESENTATION...

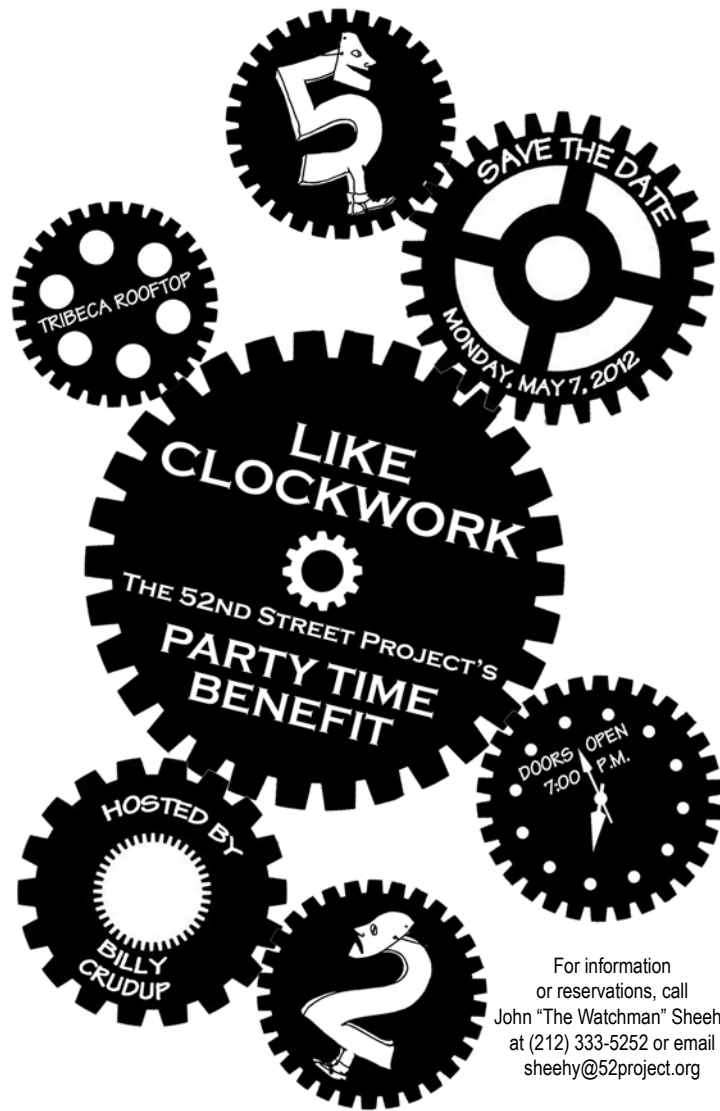

For information  
or reservations, call  
John "The Watchman" Sheehy  
at (212) 333-5252 or email  
sheehy@52project.org



**BE ON THE LOOKOUT!**  
WE ARE ALWAYS  
SEARCHING FOR INTERNS.

If you know of any college or graduate students who might enjoy working with us, playing with us, and going on trips with us for a semester, please have them contact Lisa Kerner. We are currently looking for interns for the Summer and Fall of 2012. Thanks!

## The 52nd Street Project Board of Directors

Lisa Benavides	Carol Ochs
Rachel Chanoff	Willie Reale, founder
Cathy Dantchik	Gus Rogerson
Carolyn DeSena	Shirley Rumierk, alumni member
Wendy Ettinger, chair emeritus	José Soto, Jr., alumni member
Louis P. Friedman	Jenny Steingart
Robert Goldberg	Lisa Tilney
Stephen Graham, chair	Merritt Tilney
James McDaniel	Pamala Tyson
Frances McDormand	Wendy vanden Heuvel
Noël Mihalow	John A. Vassilaros

---

## What's Going On Here?

The 52nd Street Project is a non-profit organization that brings children from the Hell's Kitchen neighborhood together with professional theater artists to create original theater. *JUMPING OFF THE PAGE* is a production of our Playmaking program. Young people participate in a nine-week playwriting course taught by Megan Cramer and adapted for the Project by Daniel Judah Sklar from his book *Playmaking: Children Writing and Performing Their Own Plays*. At the end of the course, each child is matched with two actors and a dramaturg/director who guides him or her through the writing of a play during a weekend retreat in the country (Bridgehampton, NY, for this show). This performance is the end result.

---

## In-Kind Contributions

The Murphy Law Office; Abbeville Press; Stephanie Berger Photography; Lewis Black; Richard Blackstone; Iris A. Brown Design; City Winery; William Curran & A Curran Affair; Kate Cusack; EMI Records; ICI; The S.F. Giants; Newman's Own; Macy's; Pharma Print; PineRock; The N; Shapiro Lobel, LLP; Wendy Stuhlberg; The Yankees; John A. Vassilaros; Watkins, Inc.; Boylan's Bottling Co.; Hudson Scenic; and Paul, Weiss, Rifkind, Wharton & Garrison LLP.

---

## Special Thanks

We're extremely grateful to John Vassilaros & Alex Gersten-Vassilaros for the use of their beautiful home in Bridgehampton, NY as our base of operations for the writer's retreat. Also thanks to Joyce, Stefano, Tonio and Luca for having us in their home. Still more thanks must go Laurie Becker, who housed the girls in nearby Sag Harbor.

## JUMPING OFF THE PAGE: PLAYS IN 3D - ACT 1

All original music composed by Cynthia Wong.

### THE SOLUTION BETWEEN BEES AND FLIES

Written by Ricardo Currin, age 10

Dramaturge: Olivia Strauss; Director: Megan Cramer

Costume Designer: Chris Rumery

Fly..... John Ellison Conlee

Bee ..... Christopher Evan Welch

Flies and Bees..... Crew

*Together As One* lyrics by Ricardo Currin

### THE WAY OF THE NINJA

Written by Kwaku Abangan, age 11

Director/Dramaturge: Snehal Desai

Costume Designer: Chris Rumery

Ninja Man..... Pun Bandhu

Ninja Lady..... Gretchen Hall

Ninja Dad..... Jonathan Sokolow

Shoe Salesman..... Kara Thiam

### CHUNKY AND RAMI'S DISCOVERIES

Written by Makice Pacheco, age 11

Director/Dramaturge: Nicole A. Watson

Costume Designer: Chris Rumery

Chunky..... Rachel Rusch

Rami..... Erin Cherry

Customers..... Crew

*Chameleon, It's a Hard Life* and *Alone* lyrics by Makice Pacheco

### I'M WITH A DUMMY

Written by Tyleek Mark Powell, age 10

Director/Dramaturge: Nick Mills

Costume Designer: Sarita Fellows

Nick..... Lucas Near-Verbrugge

Baby J..... Todd Bartels

### SKY RULERS

Written by Sabrina Caldoni, age 10

Director/Dramaturge: Maggie Lacey

Costume Designer: Sarita Fellows

Pande..... Marin Ireland (Fri. & Sat.); Maggie Lacey (Sun.)

Moona..... Irene Sofia Lucio

Somebody..... Amber Ureña

People..... Olivia Strauss, Elisabeth Sutherland

*My Big Wish* lyrics by Sabrina Caldoni

## JUMPING OFF THE PAGE: PLAYS IN 3D - ACT 2

### THE FRIENDS

Written by Allyssia Feliciano, age 10

Dramaturge/Director: Flor de Liz Perez; Costume Designer: Chris Rumery

Aprill..... Evan Enderle

Matasen..... Hannah Cabell

Dad's Voice..... George Babiak

*Richest and Daddy's Little Song* lyrics by Allyssia Feliciano

### TWO BROTHERS: THE MATTER OF DEATH

Written by Bryan Lopez, age 10

Director/Dramaturge: Martin Moran; Costume Designer: Sarita Fellows

Michael Ray..... Ruy Iskandar

Myers..... Florencia Lozano

Information Desk Guy..... Jonathan Sokolow

Airport Travellers..... Crew

Dead Bully..... Josh Moody

Guards..... Jonathan Sokolow, Kara Thiam

Head Killer..... George Babiak

### PRETEND FRIENDS

Written by Tiniyah Renee Powell, age 11

Director/Dramaturge: George Babiak; Costume Designer: Chris Rumery

Natalia..... Cecilia Arana-Grant

Ryan..... Juan Villa

Fernando & Sally..... Eric Carrero & Amber Ureña

Ms. Bridger..... Olivia Strauss

Owner of Papisito's..... Jonathan Sokolow

Customers/Students..... Crew

*My Own Way* and *I'm Sorry* lyrics by Tiniyah Renee Powell

### GHOSTLY DREAMS

Written by Steven Baez-Padilla, age 12 (turns 13 on Sunday)

Director/Dramaturge: Armando Riesco; Costume Designer: Sarita Fellows

Jason..... Korey Jackson

Will..... Howard Overshown

Doctor..... Kara Thiam

*Dream, I Hate Ghosts,* and *Reapers* lyrics by Steven Baez-Padilla

### THE STORY OF THE FATHERS

Written by Fallyn Vega, age 11

Director/Dramaturge: Christina Roussos; Costume Designer: Sarita Fellows

Fight Choreographer: Lee Aaron Rosen

Marisa..... Sue Jean Kim

Conch Shell Quing..... January LaVoy

*Conch Shell Quing Story* and *We Could Do a Lot* lyrics by Fallyn Vega

The 52nd Street Project is a non-profit arts organization that brings children from the Hell's Kitchen neighborhood together with professional theater artists to create original theater. The Dancemaking program gives children a chance to express themselves creatively through movement. Over the nine weeks of Dancemaking class, led by Lili-ana Amador-Marty, these young choreographers and performers developed their own movement vocabulary, explored shapes, pathways, actions, and choreographic elements to create their own 3-minute duets. The resulting dances are featured in tonight's performance.

### The 52nd Street Project Staff

Gus Rogerson, Artistic Director	Carol Ochs, Executive Director
Megan Cramer, Associate Artistic Director	Lisa Kerner, General Mgmt. Associate
George Babiak, Production Manager	John Sheehy, Dir. of Development & Marketing
Ray Harold, Technical Director	Josh Moody, Development Associate
Liz Bell, Director of Education	
Diana Rojas, Associate Program Director	

#### Consultants:

Iris A. Brown, Graphic Designer; Chris Ceraso, Teen Dean;

#### Interns:

Jonathan Sokolow, Olivia Strauss, Elisabeth Sutherland

**Ushers:** Carlos Dume, Ralphie Irizarry, Azalea Rosario

**Lighting Design:** Jay Scott & Ray Harold

### The 52nd Street Project Board of Directors

Lisa Benavides	Carol Ochs
Rachel Chanoff	Willie Reale, founder
Cathy Dantchik	Gus Rogerson
Carolyn DeSena	Shirley Rumierk, alumni member
Wendy Ettinger, chair emeritus	José Soto, Jr., alumni member
Louis P. Friedman	Jenny Steingart
Robert Goldberg	Lisa Tilney
Stephen Graham, chair	Merritt Tilney
James McDaniel	Pamala Tyson
Frances McDormand	Wendy vanden Heuvel
Noël Mihalow	John A. Vassilaros



The Dancemaking Program is made possible with public funds from The New York State Council on the Arts, a state agency; and the New York City Department of Cultural Affairs. The Project is a member of ART/NY.

The 52nd Street Project Presents

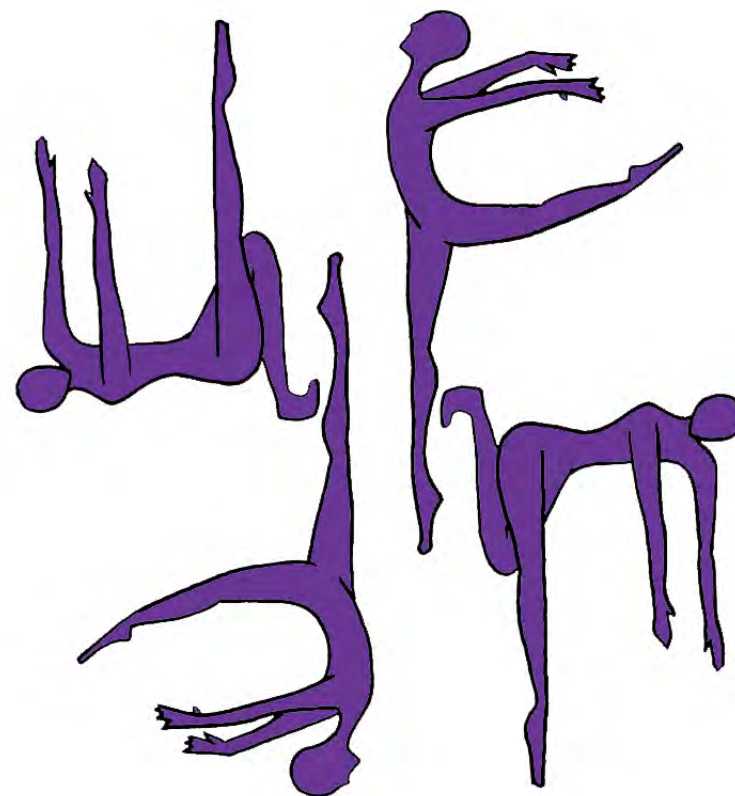

# Dancemaking

*The 52nd Street Project 2012 Dance Concert*

Featuring 8 short original dances choreographed by kids and performed by kids and adults.

Dancemaking Director: Lili-ana Amador-Marty

Wednesday, April 18, 2012 – 6:00 p.m.

The Five Angels Theater  
The 52nd Street Project  
789 10th Avenue

## Prelude

Choreographed by: Liliana Amador-Marty, with Armando Cosme, Jr.  
Performed by: The Dancemaking Company  
Music: Michael Riesman

## It's Time For Me To Be Famous

Choreographed by: Daquan Nelson  
Performed by: Daquan Nelson & Kevin Dwyer  
Music: Astor Piazzolla, "Tres Minutos Con Realidad"

*My dance piece is based on photography as well as to the fact it reflects the process of it, and what photography is itself. Photography in my perspective is a machine that enables you to capture time at that exact moment.--Daquan Nelson*

## Around the World

Choreographed by: Daniel Martinez  
Performed by: Daniel Martinez & Jeremy Rishe  
Music: Kings of Leon, "Use Somebody"

*Our dance story is when a boy broke his ankle. His friend and he were looking at a flashback of how the boy broke his ankle. So at the end the boy's friend heals the ankle.--Daniel Martinez*

## The Fairy and the Gumdrops

Choreographed by: Nathaly Trinidad  
Performed by: Nathaly Trinidad & Jennifer Ikeda  
Music: Michael Nyman, "Deep Into the Forest"

*In my dance my theme is fairy tale. I chose that theme because I love fairy tales. My inspiration for the fairy was from the show "Fairly Odd Parents." She's a fairy but I have watched lots of movies with fairies. My inspiration for the gumdrop is from Candyland. I have played that game many times.--Nathaly Trinidad*

## Little Guy and Big Guy Dancing

Choreographed by: Adnan Ahmed  
Performed by: Adnan Ahmed & Brian Hastert  
Music: Michael Nyman, "String Quartet #4"

*That thing that inspired me was my dance teacher Ms. Ayndow by her choreography. And I want to make people feel mysterious.--Adnan Ahmed*

## Discovery

Choreographed by: Tatiana Goode  
Performed by: Tatiana Goode & Nehassaiu deGannes  
Music: Matthew Bellamy, "The Resistance"

*My dance is about Family and Loss. And having fun with my family in Panama and after that when I have to go back to New York. "Always dream about a dream."--Tatiana Goode*

## We're Back

Performed in 3 Parts by:  
Armando Cosme, Jr., Wendell Joseph, & Gus Rogerson.

### Part 1: Enjoy the Ride... to Heaven

Choreographed by: Armando Cosme, Jr.  
Music: Aaron Copland, "Billy the Kid: Celebration"

### Part 2: Party Time!

Choreographed by: Wendell Joseph  
Music: Aaron Copland, "Rodeo: Hoedown"

### Part 3: Yes! Yes! I Said Yes!

Choreographed by: Armando Cosme, Jr.  
Music: Aaron Copland, "Billy the Kid: The Open Prairie Again"

*Rockin' slidin' shakin' and bakin', join me in my journey to heaven through the dance steps of an imaginary forest and deserts on my path to heaven.--Armando Cosme, Jr.*

*I made this piece because this dance shows the fun part of dancing. This dance is inspired by my dance partners. This dance will make you laugh and be surprised of what's going to happen next.-- Wendell Joseph*

## Postlude

Choreographed by: Liliana Amador-Marty, with Armando Cosme, Jr.  
Performed by: The Dancemaking Company  
Music: Michael Riesman

**Special Thanks: Sofia Elizalde, Jay Scott, Jonathan Sokolow,  
Olivia Strauss, Lily Sutherland**

**Extra-special thanks to the seven adult partners who appear in this performance,  
for their enormous help in Dancemaking.**

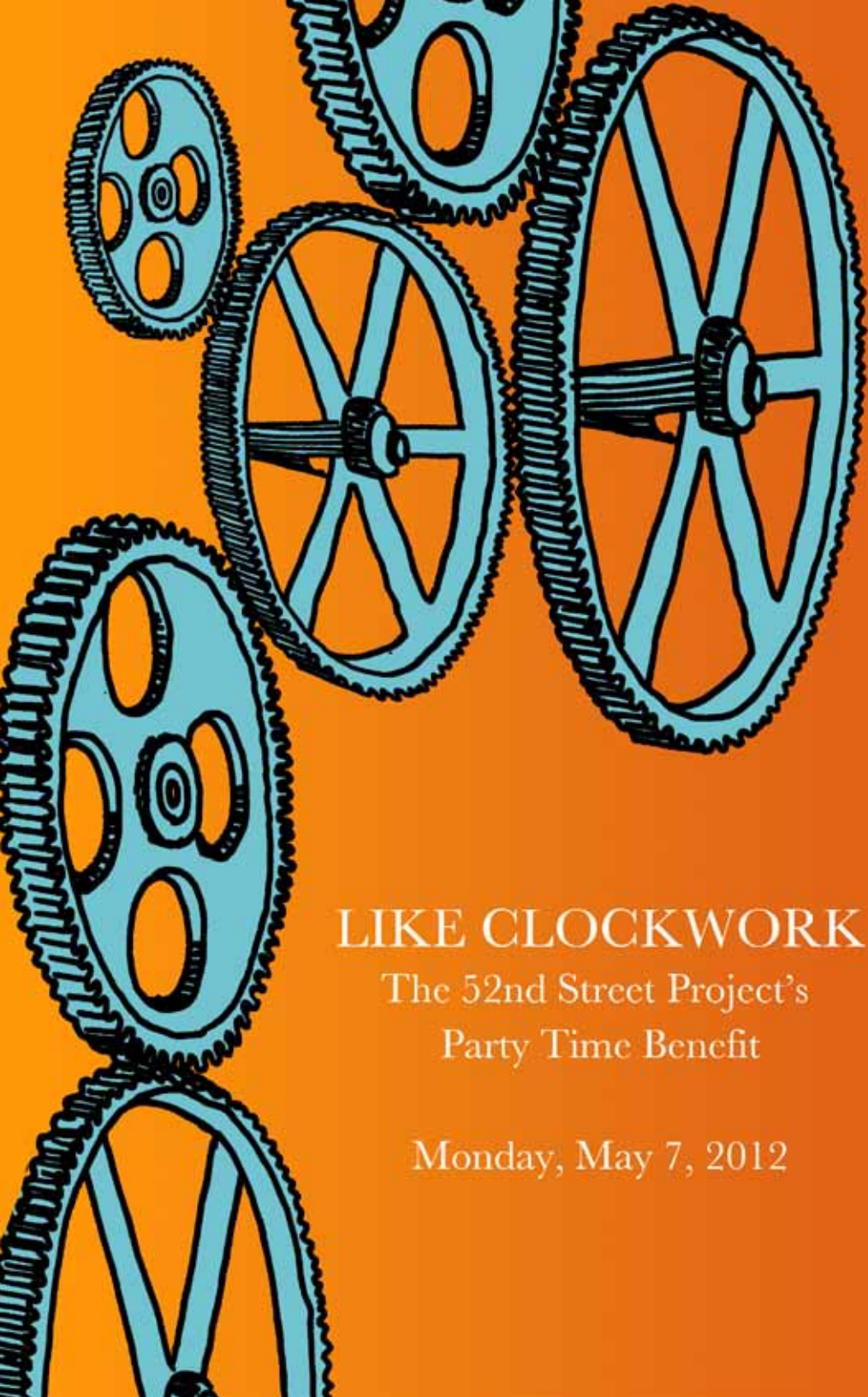

# LIKE CLOCKWORK

The 52nd Street Project's  
Party Time Benefit

Monday, May 7, 2012

## **“Like Clockwork” Benefit Co-Chairs**

Lisa Benavides	Karin Schall
Cathy Dantchik	Jenny Steingart
Carolyn DeSena	Merritt Tilney
Louis P. Friedman	Laura Valeroso
Patrice Friedman	Mary Pat Walsh

### **The 52nd Street Project gratefully acknowledges...**

abc kitchen  
Richard Anthony  
Iris A. Brown Design  
Larkin Clark and Daily Candy  
William Curran,  
A Curran Affair  
Ferragamo  
Lauren Friedman, Pharma/Omni Printing  
Louis and Patrice Friedman  
Godspell on Broadway  
Neil Mazzella and Hudson Scenic  
Randy and Rona Nelson  
Martha Plimpton  
Sesame Workshop  
Shapiro Lobel, LLP  
Wendy Stuhlberg  
Adriana Trigiani and Harper Collins  
Merritt Tilney and Doug Kaden  
John A. Vassilaros & Sons  
Mark Jacobs and Watkins Incorporated  
Healthier Living Since 1868



Carol Ochs,  
Executive Director

Stephen Graham,  
Board Chair

Gus Rogerson,  
Artistic Director

# Like Clockwork

The 52nd Street Project's Party Time Benefit

Monday, May 7, 2012

Tribeca Rooftop

## The Show

### Host

Bobby Cannavale

### The Lyricists

Richard Brea, Kyle Fargardo, Eliza Muñoz,  
Julissa Peralta, Edwin Rodriguez

### The Composers

Will Butler, Jeremy Gara, and Tim Kingsbury of Arcade Fire;  
Joe Iconis; Jessica Molaskey and John Pizzarelli;  
Arthur Lewis, Lin-Manuel Miranda, and Chris "Shockwave" Sullivan of  
Freestyle Love Supreme; and Kim D. Sherman

### The Performers

Uzo Aduba, Telly Leung, Arthur Lewis, Lin-Manuel Miranda,  
Lindsay Mendez, Jessica Molaskey and John Pizzarelli,  
Matt Saldivar, and Chris "Shockwave" Sullivan

### The Musicians

Kimberly Grigsby, Piano  
Thad DeBrock, Guitar/Bass  
Trey Files, Drums

### Director

Jonathan Bernstein

### Music Director

Kimberly Grigsby

### Music Coordinator

Kim D. Sherman

### Lighting Designer

Greg MacPherson

### Sound Designer

Bart Fasbender

### Set Design

George Babiak  
(based on the art of Iris A. Brown)

### Stage Manager

Colleen Sherry

### Written by

John Sheehy

# Coming and Going

Lyrics by Julissa Peralta, age 13

Composed by Joe Iconis

JUST LIKE DAYS  
CLOUDS COME AND GO  
BUT THE FUN NEVER STOPS  
AND WINTER AND SUMMER COME AND GO

JUST LIKE DAYS  
THE CLOUDS THEY COME AND GO  
LIKE FIREWORKS—SURPRISE ME  
LIKE AN EARTHQUAKE—SHOCK ME

HOW COULD YOU DO THIS TO MEEE  
HOW COULD YOU STOP ME LIKE THAT  
HOW COULD YOU PLAY ME LIKE THAT  
YOU NEVER UNDERSTOOD ME  
AND NOW YOU NEVER WOULD  
BUT THE TIME WILL COME TO TAKE US AWAY, AWAY

JUST LIKE DAYS  
THE CLOUDS THEY COME AND GO

WHY DON'T YOU FORGET ME, JUST FORGET ME  
OOOH LEAVE ME  
THERE'S NO WAY WE CAN CHANGE  
THERE'S NO WAY  
THERE'S NO TELLING WHAT WE CAN DO

JUST LIKE DAYS  
THE CLOUDS THEY COME AND GO

I KNOW LIFE WOULD BE BETTER  
ONCE WE'RE THROUGH  
NOW I'M SPEECHLESS  
NOW THIS MUST END  
WE'RE GAINING NOTHING BUT PAIN

BUT NOW, SOMEHOW YOU GOTTA  
LEAVE ME ALL ALONE IN MY SHADOW  
YOU'RE BLOCKING MY VIEW, MY WAY  
IT'S NOTHING BUT THE END NOW

JUST LIKE DAYS  
THE CLOUDS THEY COME AND GO

OOOOOOOOO UH UH UH UH  
LA, LA LA, LA, LA LA, LA, LAAAAAA

JUST LIKE DAYS  
THE CLOUDS THEY COME AND GO

THERE'S NO TELLING WHAT WE CAN DO!

# The Difference Between Similarities

By Eliza Muñoz, age 15

Composed by Kim D. Sherman

Performed by Uzo Aduba, Telly Leung, and Lindsay Mendez

RUNNING OUT OF TIME TO SPEND WITH FRIENDS  
DIFFERENT SEASONS DIFFERENT PACE OF TIME  
STYLES CHANGE WITH EVERY  
DIFFERENT MOOD

EVEN WITH ALL THAT CHANGING, FRIENDS STAY THE SAME  
DON'T MATTER IF YOU'VE KNOWN THEM  
SINCE YOU WERE A KID, OR FOR A WEEK  
OH, THAT DON'T CHANGE

WINTERS SLOWER, SUMMERS FASTER  
MOODS ARE CHANGING WITH THE SEASON  
FRIENDS ARE CRAZY THROUGHOUT  
ALL THAT CHANGE

TIME, SEASONS, MOODS AND STYLES CHANGING  
BUT FRIENDS ALWAYS STAY THE SAME

MUSIC POUNDING THROUGH YOUR EARS TO YOUR HEART  
BODIES DANCING TO THE BEAT  
SWEATING EVERYWHERE ON THE DANCE FLOOR  
HITTING THE BEAT WITH YOUR FIST  
ONCE YOU START HAVING FUN TIME FLIES BY

LEAVING EARLY IN THE WINTER  
STAYING LONGER IN THE SUMMER  
BUT NO MATTER WHAT, YOUR STYLE  
IS STILL ROCKING

HEAD BOBBING TO THE BEAT  
CHANGING UP YOUR MOOD  
FRIENDS ACTING CRAZY  
BOBBING ALONG WITH YOU

TIME, SEASONS, MOODS AND STYLES CHANGING  
BUT FRIENDS WOULD STAY THE SAME

# Clocks Can Rock

By Edwin Rodriguez, age 11

Composed by Will Butler, Jeremy Gara, and Tim Kingsbury of Arcade Fire

Performed by Matt Saldivar

TIME IS GOING FAST AND I CAN'T SLOW IT DOWN  
FRIED CHICKEN IS THE BEST IN THE WHOLE TOWN  
TIME IS TOO FAST THAT I CAN'T PARTY ENOUGH  
SO NOW I KNOW THAT THIS IS REALLY REALLY TOUGH

I GO TAKE A BATH AT 2 P.M.  
I COME OUT AND IT'S ALREADY EIGHT  
MY MOM TELLS ME, "EDWIN BREAKFAST IS READY"  
BUT THEN I TELL HER "I'M RUNNING LATE"

I'M RUNNING LATE  
I'M RUNNING LATE  
I'M RUNNING LATE  
LAAAAAAAAAAAAATE!

I'M LATE FOR WORK  
I GOTTA GO TO WORK  
OR ELSE THEY ARE GONNA FIRE ME  
AND I'LL BE POOR  
I GOTTA HURRY UP  
"HEY HONEY CAN YOU DRIVE ME TO WORK  
OR ELSE THEY ARE GONNA FIRE ME"

(WIFE: HELL NO!!)

I'M LOOKING FOR MY TIE  
I'M LOOKING FOR MY SHOE  
I'M GONNA FLIP OUT  
I FORGOT TO BRUSH MY TEETH  
NO GIRL WOULD WANNA KISS ME  
I GOTTA FEED MY BIRD  
I GOTTA FEED MY CAT  
I FORGOT TO LOOK FOR MY DAMN HAT

BUT WAIT  
I'M STILL RUNNING LATE

I'M RUNNING LATE  
I'M RUNNING LATE  
I'M RUNNING  
RUNNING LATE!

I'M RUNNING LATE  
I'M RUNNING LATE  
I'M RUNNING  
RUNNING LATE!

PEACE OUT

# Slow the Show

Lyrics by Kyle Fargardo, age 15

Composed and Performed by Jessica Molaskey and John Pizzarelli  
With Larry Fuller (Piano), Martin Pizzarelli (Bass), Tony Tedesco (Drums)

IF YOU SLOW THE FLOW  
YOU BLOW THE SHOW  
HOLD YOUR OWN  
AND HOLD YOUR ZONE

IF YOU SLOW THE FLOW  
YOU BLOW THE SHOW  
BEFORE YOU KNOW IT  
YOU'RE ALONE

I'M HERE TO BRING  
YOU LADIES AND GENTS  
AN OUTRAGEOUS EVENT  
TO EXPRESS TIME VOCALLY  
REMEMBER THIS RHYME LOCALLY

EVERYWHERE YOU GO  
IT'LL BE LIKE YOU  
SPOKE WITH ME

TIME IS ON THE CLOCK  
WITH YOU EVERY SPOT

YEAR TO A CENTURY  
PEERS TO A MEMORY

IF YOU SLOW THE FLOW  
YOU BLOW THE SHOW  
HOLD YOUR OWN  
AND HOLD YOUR ZONE

IF YOU SLOW THE FLOW  
YOU BLOW THE SHOW  
BEFORE YOU KNOW IT  
YOU'RE ALONE

YOU HAD FUN WITH LOVE  
AND FELL IN LOVE WITH TIME:

12 HOURS IS  
12 SHOWERS  
11 BRAINSTORMS  
10 MYSTICAL POWERS  
9 SUNSHINE AFTER  
THE BRAIN RAIN GONE  
8 YOU'RE SAFE  
LIFE'S GREAT  
YOU'RE WHERE YOU BELONG

7 IS TIME  
WHERE JUST FOR A DIME  
YOU'RE IN HEAVEN  
6 YOU NEED A PIC  
TO TAKE YOUR SHOT  
5 IT'S POURIN'  
4 YOU'RE SNORIN'  
3 YA ME  
2 YOU'RE YOU  
1 YOU'RE DONE

HAD FUN WITH LOVE  
AND FELL IN LOVE WITH TIME  
FUN WITH LOVE  
AND FELL IN LOVE WITH TIME

I'VE BEEN ALONE IN MY HOME  
WITH PEOPLE I DON'T KNOW  
FOR THE PAST TWENTY  
LOOKING FOR A JOB  
NEEDING FAST MONEY  
YOU GOTTA BE A DIFFERENCE MAKER  
HOLD YOUR SAME NOTE  
EVEN ON A DIFFERENT PAPER  
WHEN YOU DON'T MOVE AND GROOVE  
YOU GET CAUGHT UP  
YOU SNOOZE YOU LOSE  
BUT LOOK HOW I WAS BROUGHT UP  
I AM A PREACHER  
OR TO SOME A LYRICAL SPEAKER  
MOTHER TIME IS HIDING  
I CAN NOT SEEK HER  
I NEED HELP FROM SOMEONE  
SHE CAN BE MY TEACHER

I HOPE YOU ENJOYED MY RHYME ON TIME  
I BROUGHT YOU AND TAUGHT YOU  
BE CLEVER AND REMEMBER

IF YOU SLOW THE FLOW  
YOU BLOW THE SHOW  
HOLD YOUR OWN  
AND HOLD YOUR ZONE

IF YOU SLOW THE FLOW  
YOU BLOW THE SHOW  
BEFORE YOU KNOW IT  
YOU'RE ALONE

# Battle John vs. Clock

Lyrics by Richard Brea, age 12

Composed and performed by Arthur Lewis, Lin-Manuel Miranda,  
and Chris "Shockwave" Sullivan of Freestyle Love Supreme

## JOHN

HELLO MY NAME IS JOHN, WHAT?  
TONIGHT I'M GOING TO SHOW YOU  
WHO'S BOSS  
'CAUSE I'M A BOSS, SON  
I'M GOING TO BEAT YOU  
TAKE THE CHAMPIONSHIP  
AND THE MONEY  
IT'S MY GOAL

## CLOCK

HELLO MY NAME IS CLOCK  
I'M THE CHAMPION  
NOBODY CAN BEAT ME  
I'M THE BEST  
I'M GOING TO TAKE THIS MONEY AND GO  
WHEN I AM DONE WITH YOU

OW YEAH, ONE THING  
WHO DO YOU THINK YOU ARE  
COMING AND TELLING PEOPLE  
THAT YOU GOING TO BEAT ME?  
IT'S MY GOAL

## JOHN

THE CLOCK GOES TICKING  
IT'S ALMOST PARTY TIME  
EVERYBODY GET READY SET-Y  
THIS CLOCK CAME OUT OF NOWHERE  
WHERE'S THE BATTERY?  
I NEED A HAMBURGER BUN  
TO THROW AT THIS CLOCK  
IT'S ANNOYING  
HELP ME  
STOP IT  
AHHHHHH

## CLOCK

IT'S RAINING HAMBURGERS,  
HALLELUJAH  
IT'S TIME FOR PARTY TIME, BO-BEBOT-  
OW  
YEAH EVERYBODY GET UP AND CLAP  
YOUR HANDS LIKE THIS  
(CLAP, CLAP, CLAP, CLAP, CLAP)  
WAIT I HAVE NO HANDS  
SO JUST KEEP CLAPPING

## JOHN

HEY CLOCK, GUESS WHAT?  
PUT THE SHUT TO THE UP  
AND LET ME SHOW YOU  
HOW TO ROCK THIS STAGE  
HEY CLOCK, YOU LOOK LIKE A RICH MAN  
THAT CAN'T AFFORD SHOES,  
YOU LOSER  
I BET YOU YOU CAN'T AFFORD PENCILS,  
YOU UGLY HOBO  
YOU JUST GOT JOHN-A-FINED

## CLOCK

WELL HERE I GO JOHN  
YOU CAN RAP AND SING BETTER  
THAN ME  
BUT AT LEAST I CAN TIE MY OWN SHOES  
YOU LOSE  
BUY A CLOCK  
GO BACK TO SCHOOL  
'CAUSE I THINK YOU JUST GOT  
SCHOOLED BY ME  
THE CLOCK ALWAYS WINS

## JOHN

OH YEAH  
AT LEAST I'M NOT A CIRCLE LIKE YOU

## CLOCK

YOU JUST GOT ME STARTED  
AT LEAST MY MOM IS NOT STUPID  
GIVING THE ROBBER THE TV REMOTE  
WHEN SHE JUST GOT ROBBED  
OW YEAH  
I JUST END THIS BATTLE  
'CAUSE THE CLOCK ALWAYS WINS  
YOU JUST GOT CLOCK-A-FINED  
NOW I WON THIRTY CHAMPIONSHIPS

## JOHN

YOU MADE ME SAD  
I WISH YOU CAN'T RAP NO MORE  
IT'S NOT FAIR  
YOU ALWAYS WIN

## **Atomic Clock Tables**

Ars Nova & the Weiner Family

## **Big Ben Tables**

The Dantchik Family

Fred Nelson, People's Choice Awards

## **Grandfather Clock Tables**

Patrice & Louis Friedman

Cathy & Stephen Graham

## **Alarm Clock Tables**

Lisa Benavides Nelson & Tim Blake Nelson

Denise Burse Fernandez & Peter Jay Fernandez

CBS Corporation

The Dawkins Family Foundation

Carolyn & Neil DeSena

Terry Fitzpatrick, Sesame Workshop

Bev Gasner

Alexandra Gersten-Vassilaros & John Vassilaros

Mrs. Saul Horowitz, Jr.

Valerie Kay & Bruce Graham

Grace Lyu-Volckhausen

Betsy Maclsaac & Robert Goldberg,

Yorke Construction Corporation

Rona & Randolph Nelson

Merritt Tilney & Douglas Kaden

Wendy vanden Heuvel & Brad Coley

## **Pocket Watch Seats**

Gavin Berger & Craig Berggren  
Allison Blinken  
Buzz Bovshow  
Blaise R. Box  
Penny Collins  
Doug Eisenberg  
Nora Ephron & Nicholas Pileggi  
Sally Froelich  
Laura & Scott Gewirtz  
Karen Hauser & Warren Leight  
Sarah Horowitz & David Venarde  
Carine Joannou  
Kristen Johanson  
Andrea Johnson  
Christina Gerber  
Freddie Gershon, Music Theater International  
Elizabeth Giamatti  
Cynthia Kaplan & David Froelich  
Henry Krieger & Robert Joy  
Mickey Lemle  
Jonathan Levine  
Martin Levine, The Par Group  
Amanda & Neal Moszkowski  
Lori O'Connor  
Suzanne Poulin  
Joe Robertson, Free to Be Under Three  
Laura & David Ross  
Dr. Steve Rudin  
Steve Sabba, Tax Pro Financial Network, Inc.  
Karin & Thomas Schall  
Cynthia Vance & Robert Abrams  
Mary Pat Walsh  
Carole Yass



## Kitchen Timer Seats

Cecilia Arana	Judy Kuhn & David Schwab
Becky Ann & Dylan Baker	Frances & Fred Langbecker
Tosh & Tom Barron	Gabrielle Lansner & Dean Taucher
Carolyn Bechtel	Adrienne Lobel
Louisa Benton	Ali Marsh
Stephanie Berger & Paul King	Emily & John Morgan
Stephen Bernstein	Suzen Murakoshi & Mark Temme
Jane Bolster & Steve Wertimer	Carol Ochs & Bruce MacVittie
Becky Browder & Ted Neustadt	Jacki Ochs & Jan Kroeze
Iris A. Brown & Joe White	Jane Perlmutter & Greg MacPherson
Cora Cahan & Bernard Gersten	Sue Phillips
Leah Carr	Helaine & Michael Pruzan
Chris Ceraso	Christopher Randolph
Katie Clark	Helen & Peter Randolph
Elizabeth Clemants	Anita A. Rogerson
Kumi Craig	Laura Sametz & Anton Fig
Rebecca & Richard Dresser	Maury Schott
Lynn Ellenberg	Susan Schroeder & Britt Adams
Martha & Mark Fishman	Whitney Scott & Peter Jacobson
Liz Flahive & Jeff Cox	Coco & Frank Sellman
Wendy Flanagan & Chris O'Malley	Sylvia Shepard & Willy Holtzman
Alison Fraser	Meg Simon
Alexandra Garrison	David Stott
Celia Gerard & Mark McGrath	Danny Strong
Jenny Gersten & Willie Reale	Al Styron & Ed Beason
Emily Grishman & Susan Sampliner	Susanna Styron
Lisa J. Gugenheim &	Richard Sweren
Lawrence Nathanson	Edith Thurber & Kevin O'Rourke
Jan Gura & Alan Pickman	Lisa Tilney & Chris Lawrence
Susan Hanson	Lorraine Tobias & Alex Draper
Jessica Hecht & Adam Bernstein	Liz Tuccillo
Kathy & Jamie Herring	Laura Valeroso & David Seidman
Paten Hughes	Susan J. Vitucci
Beth Ifcher	Brenda Wehle & John C. Lynch
Sandy & Jack Kaplan	Carol Whitesides
Louise Klebanoff	Yildiz Yuksek & Richard Blackstone
Belle & Roger Kuhn	Connie & Marc Zand

Donor lists current as of May 3, 2012

# The 52nd Street Project Board of Directors

Lisa Benavides  
Rachel Chanoff  
Cathy Dantchik  
Carolyn DeSena  
Wendy Ettinger,  
*Chair Emeritus*  
Louis P. Friedman  
Robert Goldberg  
Stephen Graham, *Chair*  
Valerie Kay  
James McDaniel  
Frances McDormand  
Noël Mihalow

Carol Ochs  
Willie Reale, *founder*  
Gus Rogerson  
Shirley Rumierk,  
*alumni member*  
José Soto, Jr.,  
*alumni member*  
Jenny Steingart  
Lisa Tilney  
Merritt Tilney  
Pamala Tyson  
Wendy vanden Heuvel  
John A. Vassilaros

## The 52nd Street Project Staff

Gus Rogerson, Artistic Director  
Megan Cramer, Associate Artistic Director  
George Babiak, Production Manager  
Ray Harold, Technical Director  
Carol Ochs, Executive Director  
Lisa Kerner, General Mgmt. Associate  
John Sheehy, Dir. of Development & Marketing  
Josh Moody, Development Associate  
Liz Bell, Director of Education  
Diana Rojas, Associate Program Director

### Consultants:

Iris A. Brown, Graphic Designer; Chris Ceraso, Teen Dean;

### Interns:

Jonathan Sokolow, Olivia Strauss, Elisabeth Sutherland

### Teen Employees:

Doris Alcantara, Michael Bannister, Samantha Caldon, Joyce Cheung, Carlos Dume, Emmett Goodman-Boyd, Alvin Garcia, Raphael Irizarry III, David McCall, Terrence Mack, Chloe Moore, Daquan Nelson, Tino Paduani, Azalea Rosario, Luisa Santiago, Viviana Vazquez, Malik Velazquez, Francis Williams, Jorge Zapata

## Benefit Volunteers

Lauren Blumenfeld, Diana Burski, Joselyn Florence,  
Joanna Parson, Flor De Liz Perez, Rachel Rusch,  
Kim D. Sherman, Vanessa Valdes

## Special Thanks

Jillian Apfelbaum, Becky Browder, Rachel Chanoff,  
Terry Fitzpatrick, Jenny Gersten, Daniel Goldstein,  
Tom Schall, and Maureen Towey.

The 52nd Street Project (the Project) is dedicated to the creation and production of new plays for and by kids between the ages of ten and eighteen who reside in the Hell's Kitchen neighborhood in New York City. The Project does this through unique mentoring programs that match kids with professional (and volunteer!) theater artists.

'BRINGING DOWN THE HOUSE' is a production of our Teen Ensemble Program. The Teen Ensemble is a two year acting conservatory program, which includes several public performances of original material and culminates in a full Shakespeare production. This show is the last stage of their first year.

After a year that included classes in movement, improvisation, mask performance, scene study, and singing, the teens met with six adult playwrights, who were charged to create the plays we are now presenting.

Special thanks to all of our wonderful volunteer guest artists who have worked with the Teen Ensemble this year: **Mary Kate Burke, Danyon Davis, Max Davis, Ian Hersey, Judy Kuhn, Eric March, Doug Nervik, Krystel Lucas, Sarah Petersiel, Lynne Rosenberg, & R.J. Tolan.**

The Project would also like to thank **Wendy vanden Heuvel** and **Brad Coley** for the use of their country home on Lake Lucille for the Teen Weekend trip, where we rehearsed these plays, swam in a cold lake, and ate delicious food. Also, big thanks to **Susanna Styron**, who housed our girls for a night in nearby Nyack, NY.

The following foundations and government agencies have generously supported the Teen Program through their contributions:

City of New York Department of Cultural Affairs  
Horace W. Goldsmith Foundation  
National Endowment for the Arts  
New York State Council on the Arts  
The Surdna Foundation

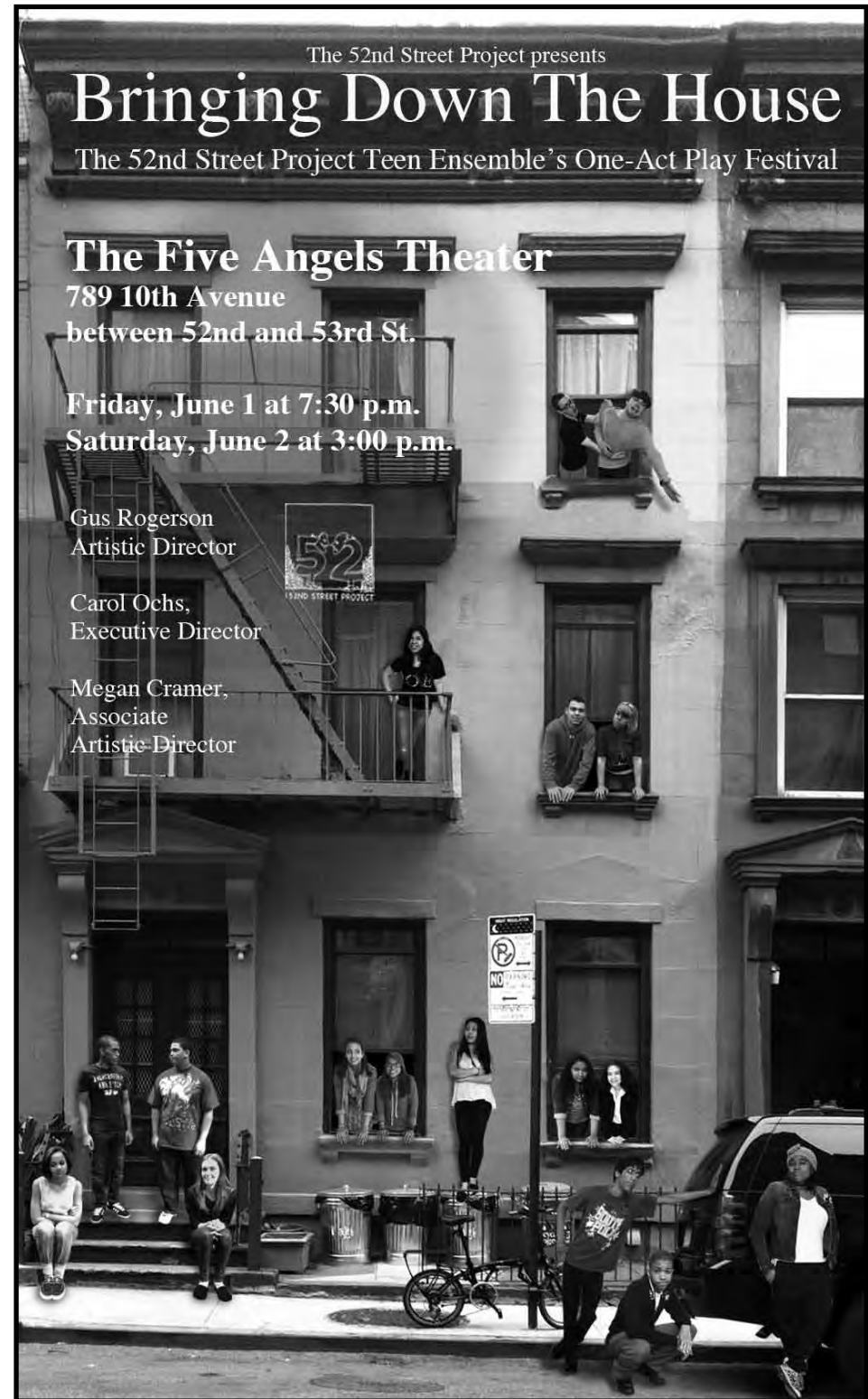



**The 52nd Street Project Staff**

Gus Rogerson, Artistic Director Carol Ochs, Executive Director  
Megan Cramer, Associate Artistic Director Lisa Kerner, General Mgmt. Associate  
George Babiak, Production Manager John Sheehy, Dir. of Development & Marketing  
Ray Harold, Technical Director Josh Moody, Development Associate  
Liz Bell, Director of Education  
Diana Rojas, Community Coordinator

**Consultants:**

Iris A. Brown, Graphic Designer; Chris Ceraso, Teen Dean

**Interns:**

Justin Cimino, Frank Oleszko

**Teen Employees:**

Receptionists: Alvin Garcia, Jason Gil, Jorge Zapata  
Ushers: Michael Bannister, Terrence Mack  
Concessions: Carlos Dume

**“Bringing Down the House” Team**

Jay Scott.....Lighting Designer  
Lara deBruijn.....Costume Designer  
Justin Cimino.....Sound Designer  
Drew Cortese.....Fight Choreographer  
Lisa Kerner.....Stage Manager  
Frank Oleszko and The Teen Ensemble.....Running crew  
Olivia Strauss, Jonathan Sokolow, Justin Cimino  
Megan Cramer, George Babiak.....Prop Design

**The 52nd Street Project Board of Directors**

Lisa Benavides Carol Ochs  
Rachel Chanoff Willie Reale, *founder*  
Cathy Dantchik Gus Rogerson  
Carolyn C. DeSena Shirley Rumierk,  
Wendy Ettinger, *alumni member*  
*chair emeritus* José Soto, Jr.,  
Louis P. Friedman *alumni member*  
Stephen Graham, chair Jenny Steingart  
Larry Jones Lisa Tilney  
Valerie Kay Merritt Tilney  
James McDaniel Pamala Tyson  
Frances McDormand Wendy vanden Heuvel  
Noël Mihalow John A. Vassilaros

**RUB SOME DIRT IN IT**

Written by Erin Quinn Purcell and directed by Eliza Baldi

Denise.....Luisa Santiago  
Tonya/ Cheeks.....Kimberly Zenteno  
Nico.....Tino Paduani  
Clowns.....Doris Alcantara, Chris Ceraso,  
Armando Cosme, Jr., Megan Cramer

**TEST RUN**

Written by Jerome Hairston and directed by Stephen Ruddy

Keener.....Francis Williams  
Jake.....Emmett Goodman-Boyd

**THE SUPERPOWERS THAT BE**

Written by Matthew Paul Olmos and directed by Jordan Mahome

DJ Quik.....Alvin Garcia  
Bruja.....Ashley Smith  
Flame.....Maximo Jimenez  
Citizens.....Doris Alcantara, Tino Paduani,  
Luisa Santiago, Kimberly Zenteno

**INTERMISSION**

**FOUR DOGS**

Written by Cynthia Kaplan and directed by Andrew Grosso

Angel.....Lily Capstick  
Duke.....Jason Gil  
Coco.....Zakiya Jacob  
Willy.....Armando Cosme, Jr.  
Bob.....Chris Ceraso

**G.L.O.W.**

Written by Alexandra Gersten-Vassilaros  
and directed by Alexandra O’Daly

Mario.....Kiana Hernandez  
Eliza.....Melissa Rebolledo  
Waitress.....Viviana Vazquez

**FOR REAL THOUGH**

Written by David Lindsay-Abaire/ Directed by Nikiya Mathis

Tracy.....Samantha Caldona  
Sandra.....Doris Alcantara

The 52nd Street Project proudly presents  
**The “Stage Combat!” Program’s Final Performance**

Friday, June 15<sup>th</sup>, 2012, 6:00 p.m.

This program was led by fight choreographer and long-time Project volunteer Lee Rosen

**The Missing Ruby**

Written by Ruby Zamora, age 11

Directed by Kimiye Corwin

Madison..... Ruby Zamora  
Victoria ..... Kimiye Corwin

**World War Three**

Written by Brandon Draude, age 12

Directed by Dominic Comperatore

Sgt. Billy Bob ..... Brandon Draude  
Vlad the Impaler ..... Dominic Comperatore

**Time Is Stolen**

Written by Mari Ulloa, age 15

Directed by Amirah Vann

Kelsey..... Mari Ulloa  
Jess..... Amirah Vann

**School**

Written by Valeria Oliva, age 11

Directed by Julia Lawler

Selena..... Valeria Oliva  
Miss Julia ..... Julia Lawler

**The Crazy School Fight**

Written by Justin Bannister, age 10

Directed by Josh Moody

Carl ..... Justin Bannister  
Kevin ..... Josh Moody

**Where’s The Money?**

Written by Faisal Afridi, age 12

Directed by Jimonn Cole

Jeff ..... Faisal Afridi  
Bobby ..... Jimonn Cole

**Warrior’s Sword**

Written by Alex Malan, age 10

Directed by Vayu O’Donnell

Ninja Jhon a.k.a Jhon ..... Alex Malan  
Karate Man a.k.a Dylan ..... Vayu O’Donnell

The 52nd Street Project gratefully acknowledges the support of the following foundations and corporations: Bloomberg; Brenner Family Foundation; Cantor Fitzgerald; CBS Corporation; Consolidated Edison; Dawkins Family Foundation; The Neil V. DeSena Foundation; The Dramatists Guild Fund; Dramatists Play Service; The Educational Foundation Of America; Sidney E. Frank Foundation; Fund for the City of New York; Goldman Sachs; The Horace W. Goldsmith Foundation; Heisman Foundation; Hudson Scenic Studio; Lotos Foundation; Ann M. Martin Foundation; Marusi Family Foundation; Monteforte Foundation; The PAR Group; The People's Choice Awards; Quadra Productions; Sesame Workshop; The Shubert Organization; Simon & Eisenberg; Starker Family Foundation; Harold & Mimi Steinberg Charitable Trust; Surdna Foundation; Susquehanna Investment Group; Tax Pro Financial Network, Inc.; TCG; Theater Subdistrict Council; Tiger Baron Foundation; Van Deusen Family Fund; Vervane Foundation; Watkins, Inc.; WMEE Foundation; Yorke Construction Corp. (list current as of 7/20/12)

Robert Abrams & Cynthia Vance	Penelope Collins Judith-Ann Corrente	Sarah Horowitz & David Venarde	Sue Phillips Todd Poisson
George Ackert	Janet Coviello	Andrea Johnson	Suzanne Poulin
Michael Alicastro	William Crudup	Beth Ifcher	Helaine & Michael Pruzan
Elton Andrews	Kyle Czepiel	Carine Joannou	Christopher Randolph
Richard Anthony	Arthur Dantchik	Kristen Johanson	Helen & Peter Randolph
Cecilia Arana	Cathy Dantchik	Andrea Johnson	Jacquelyn Reingold
Emily Armstrong	Leslie Dantchik	Cindy Kaplan & David Froelich	Anita A. Rogerson
James Armstrong	Peter & Judith Dawkins	Valerie Kay & Bruce Graham	David Ross & Laura Ross
Dominick & Ilene Balletta	Carolyn & Neil DeSena	Louise Klebanoff	Dr. Steve Rudin
Becky Ann & Dylan Baker	Rebecca & Richard Dresser	Henry Krieger & Robert Joy	Laura Sametz & Anton Fig
Ken Bantum	Peter Doyle	Jacki Ochs & Jan Kroeze	Karin & Thomas Schall
Carolyn Bechtel	Max Dyksterhouse & David Roady	Judy Kuhn & David Schwab	Maury Schott
Lisa Benavides & Tim Blake Nelson	Doug Eisenberg	Frances & Fred Langbecker	Susan Schroeder & Britt Adams
Louisa Benton	Lynn Ellenberg	Gabrielle Lansner & Dean Taucher	Whitney Scott & Peter Jacobson
Gavin Berger & Craig Berggren	Nora Ephron & Nicholas Pileggi	Brian Lapin	Meg Simon
Stephanie Berger & Paul King	Peter Jay Fernandez & Denise Burse Fernandez	Michael Lawrence & Glen Gillen	Christopher Solomon
Beth & Eric Berman	Liz Flahive & Jeff Cox	Warren Leight & Karen Hauser	Jonathan Soros & Jennifer Soros
David Beth	Wendy Flanagan & Chris O'Malley	Mickey Lemle	Jenny & Jon Steingart
Lewis Black	Karen & Paul Freitas	Jonathan Levine	Tracy Straus
Emily Blavatnik	Sally Froelich	Helen Levy	Danny Strong
Allison Blinks	Alexandra Garrison	Melissa Liebling-Goldberg & John Barrett	Al Styron & Ed Beason
Noah Bogan	Beverly Gasner	Kay M. Lim	Susanna Styron
Jane Bolster & Steve Wertimer	Rose Gasner & Larry Chertoff	Adrienne Lobel	Richard Sweren
Buzz Bovshow	Celia Gerard & Mark McGrath	John Lynch	Lili Taylor
Blaise R. Box	Christina Gerber	Grace Lyu-Volckhausen	Lisa Tilney & Chris Lawrence
Becky Browder & Ted Neustadt	Freddie & Myrna Gershon	Julie & Alex Margolies	Merritt Tilney & Douglas Kaden
Carlton T. Brown	Jenny Gersten & Willie Reale	Ali Marsh	Lorraine Tobias & Alex Draper
Iris A. Brown & Joe White	Alexandra Gersten-Vassilaros & John Vassilaros	Lin Manuel Miranda	Liz Tuccillo
Justin Brownhill	Scott Aaron Gewirtz & Laura Gewirtz	Frances McDormand & Joel Coen	Laura Valeroso & David Seidman
Brian Byrnes	Elizabeth Giamatti	Emily & John Morgan	Wendy vanden Heuvel & Brad Coley
Shawn & Laura Byron	Robert Goldberg & Betsy MacIsaac	Amanda & Neal Moszkowski	Susan J. Vitucci
Joseph Capozzi	Stephen & Cathy Graham	Suzen Murakoshi & Mark Temme	Mary Pat Walsh
Leah Carr	Jan Gura & Alan Pickman	Fred Nelson	Dr. Mildred Walton
Lawrence Catena	Susan Hanson	Randy & Rona Nelson	Brenda Wehle & John C. Lynch
Chris Ceraso	Jessica Hecht & Adam Bernstein	Ruth Nelson	Carol Whitesides
Rachel Chanoff	Kathy & Jamie Herring	Lori O'Connor	Zee Wiener
Todd Christie	Peter Herdrich & Karen Trott	Carol Ochs & Bruce MacVittie	Ruth Ann Wynter
Damien Clancy	William Holtzman & S. Sylvia Shepard	Jacki Ochs & Jan Kroeze	J.P. Xenakis
Matthew Clancy	Mary Horowitz	Kevin O'Rourke & Edith Thurber	Carole Yass
Katie Clark		Jane Perlmutter & Greg MacPherson	Yildiz Yuksek & Richard Blackstone
Elizabeth Clemants		Elizabeth Peters	Connie & Marc Zand
David Cohen & Sandra Novak Cohen			
Larry Cohen			

The 52nd Street Project Presents



# DRESS THE PART: 10 TAILOR-MADE PLAYS

The 2012 Harold and Mimi Steinberg Charitable Trust  
Block Island One-on-Ones

July 20-22  
The Five Angels Theater

## Dress the Part: 10 Tailor-made Plays

The Annual Block Island One-on-Ones - July 20-22, 2012 at the Five Angels Theater

### The 52nd Street Project Staff

Gus Rogerson, Artistic Director  
Megan Cramer, Associate Artistic Director  
George Babiak, Production Manager  
Ray Harold, Technical Director

Carol Ochs, Executive Director  
Lisa Kerner, General Mgmt. Associate  
John Sheehy, Dir. of Development & Marketing  
Josh Moody, Development Associate

Liz Bell, Director of Education  
Diana Rojas, Community Coordinator

#### Consultants

Iris A. Brown, Graphic Designer; Chris Ceraso, Teen Dean

#### Interns

Justin Cimino, Wiley Gorn, Frank Oleszko

#### Teen Employees

Receptionists: Joyce Cheung, Gabriella deJesus, Alvin Garcia, Jason Gil  
Block Island Teen Counselor: Ashley Smith  
Ushers: Doris Alcantara, Haley Martinez, Eliza Muñoz

### “DRESS THE PART” Production Staff

#### Composer/Music Director

Kim D. Sherman

#### Set Designer

Kevin Joseph Roach

#### Lighting Designer

Greg MacPherson

#### Costume Designers

Ciera Wells, Kim Goings

#### Goddess of Sound

Vanessa Valdes

#### Stage Manager

Liz Bell

#### Projection Designs

George Babiak and The  
52nd Street Project Slide Archive

#### Prop Design Team

George Babiak, Lisa Kerner,  
Justin Cimino, Wiley Gorn, Leah Macuilt,  
Frank Oleszko, Ashley Smith

#### Backstage Crew

Justin Cimino, Wiley Gorn, Leah Macuilt,  
Frank Oleszko, Ashley Smith

#### House Managers

Karin Schall  
Mary Pat Walsh

#### Flyer/Program Art

Patrick Jones

#### Chefs

Martha Velie-Gass  
and Pat Ritter



The One-on-One Program is made possible with public funds from The National Endowment for the Arts, The New York State Council on the Arts, a state agency, and the New York City Department of Cultural Affairs. The 52nd Street Project is supported by the Open Society Foundations and the Fund for the City of New York. The 52nd Street Project is a member of Art/NY.

## COOL STUFF ON SALE IN THE LOBBY!

Fabulous Flyer Bars .....\$2.50 and \$2.00  
*and featuring Shel Silverstein's "Fivey and Twoey" logo:*  
Project Hoodies .....\$30.00  
Project Caps .....\$20.00  
Project T-shirts and tanks ..... \$12.00  
Project Mugs ..... \$5.00  
Project Notebook ..... \$5.00  
Project Pencil 3-pack ..... \$1.00

Thank you for coming to DRESS THE PART. If you are not on our mailing list (or if your address has changed), please fill out this form and give it to us on your way out or mail it to the address below. We would also like to know if you are interested in becoming a volunteer. We need help in all areas, so be sure to fill out the entire form.

PLEASE ADD ME TO YOUR MAILING LIST:

07/12

NAME \_\_\_\_\_

ADDRESS \_\_\_\_\_

CITY \_\_\_\_\_

STATE \_\_\_\_\_

ZIP \_\_\_\_\_

HOME PHONE \_\_\_\_\_

DAYTIME OR MOBILE PHONE \_\_\_\_\_

E-MAIL ADDRESS \_\_\_\_\_

MY OCCUPATION \_\_\_\_\_

MY HOBBIES \_\_\_\_\_

YES, I WOULD LIKE TO BE OF HELP. I CAN:

- Help load in and out for shows     Draw and/or paint     Help kids with homework  
 Hang lights     Help with mailings     Teach kids a skill  
 Work on a backstage crew     Do office work     Be a chef at an event  
 Do graphic design     Design sound     Design and sew costumes  
 Other (please specify) \_\_\_\_\_

MY SCHEDULE IS:

- Very flexible. I'm often available during weekdays.  
 Somewhat flexible. I can help on the occasional morning or afternoon during the week.  
 Not very flexible at all, but I've got some free time on evenings and weekends.

If you would like to mail this (and you're always welcome to enclose a tax-deductible contribution), you can send it to: The 52nd Street Project, 789 10th Avenue, New York, NY 10019. Or fax it to (212) 333-5598.

**COME BACK NEXT MONTH FOR...**

GUS ROGERSON, ARTISTIC DIRECTOR

THE 52ND STREET PROJECT PRESENTS

CAROL OCHS, EXECUTIVE DIRECTOR

# DRESS THE PART

## 10 MORE TAILOR-MADE PLAYS



### THE 2012 WIENER FAMILY FOUNDATION WAREHAM ONE-ON-ONES

**10 new adult-written musicals  
featuring kids with adult partners**

**Friday, August 17 at 7:30**  
**Saturday, August 18 at 7:30**  
**Sunday, August 19 at 3:00**

**The 52nd Street Project's Five Angels Theater**  
**789 10th Avenue, between 52nd and 53rd St.**

Admission is free, but reservations are strongly recommended!

To reserve your tickets visit our website ([www.52project.org](http://www.52project.org)) or call (212) 642-5052.



### KEEP AN EYE OUT!

We are always searching for interns.

If you know of any college or graduate students who might enjoy working with us, playing with us, and going on trips with us for a semester, please have them contact Lisa Kerner. We are especially looking for interns for Fall, 2012, and Spring, 2013. Thanks!

### The 52nd Street Project Board of Directors

Lisa Benavides	Noël Mihalow
Rachel Chanoff	Carol Ochs
Cathy Dantchik	Willie Reale, founder
Carolyn DeSena	Gus Rogerson
Wendy Ettinger, chair emeritus	Shirley Rumierk, alumni member
Louis P. Friedman	José Soto, Jr., alumni member
Robert Goldberg	Jenny Steingart
Stephen Graham, chair	Lisa Tilney
Valerie Kay	Merritt Tilney
James McDaniel	Wendy vanden Heuvel
Frances McDormand	John A. Vassilaros

### What's Going On Here?

The 52nd Street Project is a non-profit organization that brings children from the Hell's Kitchen neighborhood together with professional theater artists to create original theater. DRESS THE PART is a production of our One-on-One program, which is designed to give children the opportunity to go away for one-week stays in the country and enjoy the undivided attention of a professional theater artist who serves as friend, mentor, and collaborator.

### In-Kind Contributions

Abbeville Press; Stephanie Berger Photography; Iris A. Brown Design; City Winery; William Curran & A Curran Affair; Drive 495; HBO; ICI; Paris Chocolates; Pharma Print/Omni Graphics; Sesame Workshop; Wendy Stuhlberg; John A. Vassilaros and Sons; Watkins, Inc.; Ron Fiorina and Boylan's Bottling Co.; Shapiro & Lobel; Hudson Scenic; Prime Films; Paul, Weiss, Rifkind, Wharton & Garrison LLP.; Fat Sal's Pizza; Mitchell London Foods; Wendy Stuhlberg; Steve Olsen and the Westbank Cafe; Mary Pat Walsh; and Yorke Construction.

### Special Thanks

Our Host Families- Kate, Sam and Jane Bird; Susan Bush; Socha Cohen; Katy Homans and Mardette and Patterson Sims; Mimi Leveille; Leslie Parsons; Joya Verde and Virginia Dare; Elliot and Amy Nerenberg; and our headquarters host Dr. Christina Biaggi. Sincere thanks to our chefs Pat Ritter and Martha Velie-Gass; Sue Black; Kate Butcher and everyone at Block Island Realty; McQuade's Marketplace; Robbie Brown; Rita and Steve Draper; Jessie Edwards; Amelia Gallant at the Block Island Grocery; Cindy and Stan Geer at the Depot; Glenn and Annie Hall; Interstate Navigation; Ed McGovern & Winfield's; Josie Merck and Jim Stevenson; Ron and Judy Tierney; and Vanessa Valdes.



## Dress the Part: 10 Tailor-made Plays - ACT 1

All original music composed by Kim D. Sherman.  
*Dress the Part Theme Song* lyrics by John Sheehy

### THE DELI DECATHLON

Written and directed by Molly Anne Coogan for Steven Baez-Padilla, age 13

Ronnie Rotunda..... Steven Baez-Padilla  
Sally.....Molly Anne Coogan  
Tommy Salami.....George Babiak  
Singing Sandwiches.....Megan Cramer and Frank Oleszko  
Announcer.....Ashley Smith

*My Very Own Deli* and *Delicious Epiphany* lyrics by Molly Anne Coogan

### LAW AND SOME ORDER

Written by Jocelyn Bioh and directed by Nancy Noto  
for Tinish Renee Powell, age 11

Detective Fulton..... Tinish Renee Powell  
Gina DeLargo..... Nancy Noto  
Director.....Ashley Smith

*Life Can Be Breezy* lyrics by Jocelyn Bioh

### SMART PASTRAMI

Written and directed by Paul L. Coffey for Faisal Afridi, age 12

Jack..... Faisal Afridi  
Weezer..... Paul L. Coffey  
Offstage Student Voice..... Wiley Gorn  
Offstage Announcer..... Frank Oleszko  
Derrick..... Tim Cain

*Sandwiched* lyrics by Paul L. Coffey

### GET OGRE IT

Written and directed by John Sheehy, for Kate Mendoza, age 11

Cassandra..... Kate Mendoza  
Malcolm..... John Sheehy

*Cassandra's Spell* lyrics by John Sheehy

### I AM THE WALRUS

Written by Nick Platt and directed by Bhavesh Patel  
for Tyleek Mark Powell, age 10

Little W..... Tyleek Mark Powell  
Big W..... Bhavesh Patel

*Ten Fingers and Ten Toes* lyrics by Nick Platt

## Dress the Part: 10 Tailor-made Plays - ACT 2

### THE ASSASSINATOR

Written by Michael Mitnick and directed by Tim Cain, for Chayse Peña, age 11

Atrio..... Chayse Peña  
Calepino..... Tim Cain

*So My Next Kill Is You* lyrics by Michael Mitnick

### THE SINGER & THE SEAMSTRESS

Written by Andrea Ciannavei and directed by Rachel Rusch  
for Imani Lewis, age 11

Kylie..... Imani Lewis  
Mom/Seamstress..... Rachel Rusch

*The Only Thing I Have* lyrics by Andrea Ciannavei

### LIGHTNING

Written and directed by Jedidiah Clarke for Derek Tineo, age 11

Brad..... Derek Tineo  
Patrick..... Jedidiah Clarke  
Marcia..... Ashley Smith

*We're The Lightning Movers* lyrics by Jedidiah Clarke

### COME AS YOU AREN'T

Written by Christopher Oscar Peña and directed by Alexandra Metz  
for Sabrina Caldonga, age 11

Roxie..... Sabrina Caldonga  
Monday..... Alexandra Metz  
Party Guests..... Crew  
Triacorn..... Frank Oleszko

*Superstar* lyrics by Christopher Oscar Peña

### THE UNIVERSE REVEALED

Written by Willie Reale and directed by Julia Lawler for Joseph Cruz, age 11  
Costumes by Crystal Thompson

Gilbert..... Joseph Cruz  
Mia..... Julia Lawler

*Gilbert's Universe* lyrics by Willie Reale

The 52nd Street Project Presents

# DRESS THE PART

## 10 MORE TAILOR-MADE PLAYS

The 52nd Street Project gratefully acknowledges the support of the following foundations and corporations: Bloomberg; Brenner Family Foundation; Cantor Fitzgerald; CBS Corporation; Consolidated Edison; Dawkins Family Foundation; The Neil V. DeSena Foundation; The Dramatists Guild Fund; Dramatists Play Service; The Educational Foundation Of America; Sidney E. Frank Foundation; Fund for the City of New York; Goldman Sachs; The Horace W. Goldsmith Foundation; Heisman Foundation; Hudson Scenic Studio; Lotos Foundation; Ann M. Martin Foundation; Marusi Family Foundation; Monteforte Foundation; The PAR Group; The People's Choice Awards; Quadra Productions; Sesame Workshop; The Shubert Organization; Simon & Eisenberg; Starker Family Foundation; Harold & Mimi Steinberg Charitable Trust; Surdna Foundation; Susquehanna Investment Group; Tax Pro Financial Network, Inc.; TCG; Theater Subdistrict Council; Tiger Baron Foundation; Van Deusen Family Fund; Vervane Foundation; Watkins, Inc.; WMEE Foundation; Yorke Construction Corp. (list current as of 7/20/12)

Robert Abrams & Cynthia Vance	Penelope Collins Judith-Ann Corrente	Sarah Horowitz & David Venarde	Sue Phillips Todd Poisson
George Ackert	Janet Coviello	Andrea Johnson	Suzanne Poulin
Michael Alicastro	William Crudup	Beth Ifcher	Helaine & Michael Pruzan
Elton Andrews	Kyle Czepiel	Carine Joannou	Christopher Randolph
Richard Anthony	Arthur Dantchik	Kristen Johanson	Helen & Peter Randolph
Cecilia Arana	Cathy Dantchik	Andrea Johnson	Jacquelyn Reingold
Emily Armstrong	Leslie Dantchik	Cindy Kaplan & David Froelich	Anita A. Rogerson
James Armstrong	Peter & Judith Dawkins	Valerie Kay & Bruce Graham	David Ross & Laura Ross
Dominick & Ilene Balletta	Carolyn & Neil DeSena	Louise Klebanoff	Dr. Steve Rudin
Becky Ann & Dylan Baker	Rebecca & Richard Dresser	Henry Krieger & Robert Joy	Laura Sametz & Anton Fig
Ken Bantum	Peter Doyle	Jacki Ochs & Jan Kroeze	Karin & Thomas Schall
Carolyn Bechtel	Max Dyksterhouse & David Roady	Judy Kuhn & David Schwab	Maury Schott
Lisa Benavides & Tim Blake Nelson	Doug Eisenberg	Frances & Fred Langbecker	Susan Schroeder & Britt Adams
Louisa Benton	Lynn Ellenberg	Gabrielle Lansner & Dean Taucher	Whitney Scott & Peter Jacobson
Gavin Berger & Craig Berggren	Nora Ephron & Nicholas Pileggi	Brian Lapin	Meg Simon
Stephanie Berger & Paul King	Peter Jay Fernandez & Denise Burse Fernandez	Michael Lawrence & Glen Gillen	Christopher Solomon
Beth & Eric Berman	Liz Flahive & Jeff Cox	Warren Leight & Karen Hauser	Jonathan Soros
David Beth	Wendy Flanagan & Chris O'Malley	Mickey Lemle	& Jennifer Soros
Lewis Black	Karen & Paul Freitas	Jonathan Levine	Jenny & Jon Steingart
Emily Blavatnik	Sally Froelich	Helen Levy	Tracy Straus
Allison Blinks	Alexandra Garrison	Melissa Liebling-Goldberg & John Barrett	Danny Strong
Noah Bogan	Beverly Gasner	Kay M. Lim	Al Styron & Ed Beason
Jane Bolster & Steve Wertimer	Rose Gasner & Larry Chertoff	Adrienne Lobel	Susanna Styron
Buzz Bovshow	Celia Gerard & Mark McGrath	John Lynch	Richard Sweren
Blaise R. Box	Christina Gerber	Grace Lyu-Volckhausen	Lili Taylor
Becky Browder & Ted Neustadt	Freddie & Myrna Gershon	Julie & Alex Margolies	Lisa Tilney & Chris Lawrence
Carlton T. Brown	Jenny Gersten & Willie Reale	Ali Marsh	Merritt Tilney & Douglas Kaden
Iris A. Brown & Joe White	Alexandra Gersten-Vassilaros & John Vassilaros	Lin Manuel Miranda	Lorraine Tobias & Alex Draper
Justin Brownhill	Scott Aaron Gewirtz & Laura Gewirtz	Frances McDormand & Joel Coen	Liz Tuccillo
Brian Byrnes	Elizabeth Giamatti	Emily & John Morgan	Laura Valeroso & David Seidman
Shawn & Laura Byron	Robert Goldberg & Betsy MacIsaac	Amanda & Neal Moszkowski	Wendy vanden Heuvel & Brad Coley
Joseph Capozzi	Stephen & Cathy Graham	Suzen Murakoshi & Mark Temme	Susan J. Vitucci
Leah Carr	Jan Gura & Alan Pickman	Fred Nelson	Mary Pat Walsh
Lawrence Catena	Susan Hanson	Randy & Rona Nelson	Dr. Mildred Walton
Chris Ceraso	Jessica Hecht & Adam Bernstein	Ruth Nelson	Brenda Wehle & John C. Lynch
Rachel Chanoff	Kathy & Jamie Herring	Lori O'Connor	Carol Whitesides
Todd Christie	Peter Herdrich & Karen Trott	Carol Ochs & Bruce MacVittie	Zee Wiener
Damien Clancy	William Holtzman	Jacki Ochs & Jan Kroeze	Ruth Ann Wynter
Matthew Clancy	& S. Sylvia Shepard	Kevin O'Rourke & Edith Thurber	J.P. Xenakis
Katie Clark	Mary Horowitz	Jane Perlmutter & Greg MacPherson	Carole Yass
Elizabeth Clemants		Elizabeth Peters	Yildiz Yuksek & Richard Blackstone
David Cohen & Sandra Novak Cohen			Connie & Marc Zand
Larry Cohen			



PATRICK JONES

## THE 2012 WIENER FAMILY FOUNDATION WAREHAM, MASS. ONE-ON-ONES

FRIDAY, AUGUST 17 AT 7:30  
SATURDAY, AUGUST 18 AT 7:30  
SUNDAY, AUGUST 19 AT 3:00

THE FIVE ANGELS THEATER  
HELL'S KITCHEN, NEW YORK CITY

# Dress the Part: Ten Tailor-Made Plays

The Annual Wareham One-on-Ones - August 17-19, 2012 at the Five Angels Theater

## The 52nd Street Project Staff

Gus Rogerson, Artistic Director  
 Megan Cramer, Associate Artistic Director  
 George Babiak, Production Manager  
 Ray Harold, Technical Director

Carol Ochs, Executive Director  
 Lisa Kerner, General Mgmt. Associate  
 John Sheehy, Dir. of Development & Marketing  
 Josh Moody, Development Associate

Liz Bell, Director of Education  
 Diana Rojas, Community Coordinator

### Consultants:

Iris A. Brown, Graphic Designer; Chris Ceraso, Teen Dean

### Interns:

Justin Cimino, Wiley Gorn, Frank Oleszko

### Teen Employees:

Receptionists: Joyce Cheung, Gabriella DeJesus, Jason Gil  
 Wareham Teen Counselor: Joyce Cheung  
 Ushers: Michael Bannister, Jazmine Mikell, Alizette Zapata

## “Dress the Part” Production Staff

### Composer/Music Director

Patrick Barnes

### Set Designer

Kevin Joseph Roach

### Lighting Designer

Greg MacPherson

### Costume Designer

Sarah Swafford

### Sound Designer

Justin Cimino

### Stage Manager

Colleen Sherry

### Slide Designs

George Babiak, Brandon Leon, Josh Moody, and the Project Slide Archive

### Prop Design Team

George Babiak, Wiley Gorn,  
 Brandon Leon, Josh Moody,  
 Frank Oleszko.

### Backstage Crew

Joyce Cheung, Wiley Gorn, Frank Oleszko, Jamie Yip

### House Managers

Karin Schall, Mary Pat Walsh

### Flyer/Program Art:

Patrick Jones

### Chefs

John Sheehy, Liz Bell, Carol Ochs

### Production Photographer

Winston Rodney



The One-on-One Program is made possible with public funds from The National Endowment for the Arts, The New York State Council on the Arts, a state agency, and the New York City Department of Cultural Affairs. The 52nd Street Project is supported by the Open Society Foundations and the Fund for the City of New York. The 52nd Street Project is a member of Art/NY.

## COOL STUFF ON SALE IN THE LOBBY!

Fabulous Flyer Bars .....\$2.50 and \$2.00  
*and featuring Shel Silverstein's "Fivey and Twoey" logo:*  
 Project Hoodies .....\$30.00  
 Project Caps.....\$20.00  
 Project T-shirts and tanks ..... \$12.00  
 Project Mugs ..... \$5.00  
 Project Notebook..... \$5.00  
 Project Pencil 3-pack ..... \$1.00

Thank you for coming to DRESS THE PART. If you are not on our mailing list (or if your address has changed), please fill out this form and give it to us on your way out or mail it to the address below. We would also like to know if you are interested in becoming a volunteer. We need help in all areas, so be sure to fill out the entire form.

PLEASE ADD ME TO YOUR MAILING LIST:

08/12

NAME \_\_\_\_\_

ADDRESS \_\_\_\_\_

CITY \_\_\_\_\_

STATE \_\_\_\_\_

ZIP \_\_\_\_\_

HOME PHONE \_\_\_\_\_

DAYTIME OR MOBILE PHONE \_\_\_\_\_

E-MAIL ADDRESS \_\_\_\_\_

MY OCCUPATION \_\_\_\_\_

MY HOBBIES \_\_\_\_\_

### YES, I WOULD LIKE TO BE OF HELP. I CAN:

- Draw and/or color props
- Hang lights
- Work on a backstage crew
- Do graphic design
- Other (please specify) \_\_\_\_\_
- Teach kids a skill
- Help with mailings
- Be a chef at an event
- Design sound
- Help kids with homework
- Design and sew costumes

### MY SCHEDULE IS:

- Very flexible. I'm often available during weekdays.
- Somewhat flexible. I can help on the occasional morning or afternoon during the week.
- Not very flexible at all, but I've got some free time on evenings and weekends.

If you would like to mail this (and you're always welcome to enclose a tax-deductible contribution), you can send it to: The 52nd Street Project, 789 10th Avenue, New York, NY 10019. Or fax it to (212) 333-5598.

COMING SOON TO THE PROJECT...

# TRUTH OR DARE THE GAME PLAYS

## The 2012 Playback Plays

The reverse of the One-on-One's!  
Kids write plays for themselves and an  
adult partner to perform together.

October 19-21 right here at  
**THE FIVE ANGELS THEATER**



**BE ON THE LOOKOUT!**

We are always  
searching for interns.

If you know of any college or graduate students who might enjoy working with us, playing with us, and going on trips with us for a semester, please have them contact Lisa Kerner. We are especially looking for interns for the Spring of 2013. Thanks!

### The 52nd Street Project Board of Directors

Lisa Benavides	Carol Ochs
Rachel Chanoff	Willie Reale, founder
Cathy Dantchik	Gus Rogerson
Carolyn DeSena	Shirley Rumierk, alumni member
Wendy Ettinger, chair emeritus	José Soto, Jr., alumni member
Louis P. Friedman	Jenny Steingart
Stephen Graham, chair	Lisa Tilney
James McDaniel	Merritt Tilney
Frances McDormand	Wendy vanden Heuvel
Valerie Kay	John A. Vassilaros
Noël Mihalow	

### What's Going On Here?

The 52nd Street Project is a non-profit organization that brings children from the Hell's Kitchen neighborhood together with professional theater artists to create original theater. DRESS THE PART is a production of our One-on-One program, which is designed to give children the opportunity to go away for one-week stays in the country and enjoy the undivided attention of a professional theater artist who serves as friend, mentor, and collaborator.

### In-Kind Contributions

Abbeville Press; Stephanie Berger Photography; Iris A. Brown Design; City Winery; William Curran & A Curran Affair; Drive 495; HBO; ICI; Paris Chocolates; Pharma Print/Omni Graphics; Sesame Workshop; Wendy Stuhlberg; John A. Vassilaros and Sons; Watkins, Inc.; Ron Fiorina and Boylan's Bottling Co.; Shapiro & Lobel; Hudson Scenic; Prime Films, and Paul, Weiss, Rifkind, Wharton & Garrison LLP. , Fat Sal's Pizza, Mitchell London Foods, Wendy Stuhlberg, Steve Olsen and the Westbank Cafe, Mary Pat Walsh, and Yorke Construction.

### Special Thanks

An extra special helping of gratitude goes to our host families; the people who housed our kids and adult volunteers during our week in Wareham, Mass.: Lucy Aptekar & Gerry Leader; Andrea & Emmanuel Daskalakis; Debbie Herring & Howard Brun; Joe McNay; Alice McNay; Beth Pfeiffer; Gray & Rosemary Watson; Sidney Worthen; Peter, Helen & Christopher Randolph.

Sincere Thanks to Robin Morse, Lucy & Francis Rogerson; Bruce MacVittie; Vanessa Valdes; Bob Krystolfolski; George Hurd

## DRESS THE PART- ACT 1

All original music composed by Patrick Barnes, except where noted.  
“Dress the Part” Theme Song lyrics by John Sheehy

### **SUPER BEACH CAKE PARTY BAKE OFF!**

Written by Crystal Skillman & Directed by Susan McGinnis  
for Edelys Guerrero, age 12

Bella.....Edelys Guerrero  
Ellie.....Susan McGinnis  
Mayor.....Wiley Gorn  
Cake Fairy.....Joyce Cheung

“*The Greatest Cake in the World*” lyrics by Crystal Skillman

### **EXTRAORDINARY TATTOO**

Written & Directed by Dylan Dawson for Ruby Zamora, age 12

Sally.....Ruby Zamora  
Joey “Needles”.....Dylan Dawson  
Tough Customer.....John Sheehy  
Two Biker Dudes.....Josh Moody & Gus Rogerson

“*Please Don’t Chop Off My Hand!*” lyrics by Dylan Dawson

### **THE HACKSAWS & THE MCCRAYS**

Written by Jeff Cox & Directed by Christopher Randolph for Alex Bonnet, age 12

Hacksaw.....Alex Bonnet  
McCray.....Christopher Randolph  
Guy In A Suit.....Wiley Gorn  
Jordan.....Joyce Cheung

“*Dead Spirits of the Dead*” lyrics by Jeff Cox

### **THE HAM(STER)**

Written by Mattie Brickman & Directed by Krystal Lucas  
for Ashley Thomas, age 11

Jennifer.....Ashley Thomas  
Hamster.....Krystal Lucas  
Audition Director.....Joyce Cheung

“*I Can Do It All*” & “*We Can Do It All*” lyrics by Mattie Brickman

### **THE FASHIONABLE PHARAOH**

Written by Robert Askins & Directed by Megan Cramer  
for Lambert Whitney, age 11

King Tut-Tut.....Lambert Whitney  
Gorbo.....Megan Cramer  
Attendants & Aliens.....Crew  
Giri.....Flor De Liz Perez

“*Party for the People*,” “*Why Do Anything For Real?*” and “*Party for the People Reprise*” lyrics by Robert Askins

## DRESS THE PART - ACT 2

### **BAM!**

Written & Directed by George Babiak for Ricardo Currin, age 11

Jacques.....Ricardo Currin  
Gleb.....George Babiak  
The American.....Gus Rogerson  
Announcer.....Wiley Gorn

“*Rivals*” lyrics by George Babiak

### **CHARMIN CHIC**

Written by Deirdre O’Connor & Directed by Flor De Liz Perez  
for Amanda Rosa, age 12

Lucy.....Amanda Rosa  
Henrietta.....Flor De Liz Perez  
Ivan.....Wiley Gorn  
Announcer.....Frank Oleszko

“*I’ve Got What It Takes*” lyrics by Deirdre O’Connor

### **HELL’S KITCHEN HOUSE OF HELLISH HORROR**

Written by Tim J. Lord & Directed by Nick Mills for Makice Pacheco, age 11

Viola.....Makice Pacheco  
Albert.....Nick Mills  
Sphinx.....Nick Mills  
Ghost Voice.....Wiley Gorn  
Mummies.....Joyce Cheung & Frank Oleszko

“*Hunting Ghosts is Totally Cool*” lyrics by Tim J. Lord

### **KID KINCAID: THE TIME TRAVELING DETECTIVE SUPERHERO**

Written by Josh Koenigsberg & Directed by Josh Moody for Bryan Lopez, age 10

Detective Katzenbergstein.....Bryan Lopez  
Detective Dolittle.....Josh Moody  
Walkie-Talkie.....Wiley Gorn

“*You’ll Never Win*” lyrics by Josh Koenigsberg

### **WHEN YOU WERE LITTLE**

Written by Matt Schatz & Directed by Molly Carden for Maria Martinez, age 11

Aunt Annabelle.....Maria Martinez  
Florence.....Molly Carden  
Duncan / Stewart.....Molly Carden  
The President.....Molly Carden

“*When You Were Little*” music & lyrics by Matt Schatz

The 52nd Street Project gratefully acknowledges the support of the following foundations and corporations: Bloomberg; Brenner Family Foundation; Cantor Fitzgerald; CBS Corporation; The Common Sense Fund; Consolidated Edison; Dawkins Family Foundation; The Neil V. DeSena Foundation; The Dramatists Guild Fund; Dramatists Play Service; The Educational Foundation Of America; Sidney E. Frank Foundation; Fund for the City of New York; Goldman Sachs; The Horace W. Goldsmith Foundation; Heisman Foundation; Hudson Scenic Studio; Lotos Foundation; Ann M. Martin Foundation; Marusi Family Foundation; Monteforte Foundation; Newman's Own; The PAR Group; The People's Choice Awards; Quadra Productions; Sesame Workshop; The Shubert Organization; Simon & Eisenberg; Starker Family Foundation; Harold & Mimi Steinberg Charitable Trust; Surdna Foundation; Susquehanna Investment Group; Tax Pro Financial Network, Inc.; TCG; Theater Subdistrict Council; Tiger Baron Foundation; Van Deusen Family Fund; Vervane Foundation; Watkins, Inc.; WMEE Foundation; Yorke Construction Corp. (list current as of 7/20/12)

- |                                      |   |   |                                       |
|--------------------------------------|---|---|---------------------------------------|
| Robert Abrams<br>& Cynthia Vance     | Penelope Collins<br>Judith-Ann Corrente           | Sarah Horowitz<br>& David Venarde           | Sue Phillips<br>Todd Poisson          |
| George Ackert                        | Janet Coviello                                    | Andrea Johnson                              | Suzanne Poulin                        |
| Michael Alicastro                    | William Crudup                                    | Beth Ifcher                                 | Helaine & Michael Pruzan              |
| Elton Andrews                        | Kyle Czepiel                                      | Carine Joannou                              | Christopher Randolph                  |
| Richard Anthony                      | Arthur Dantchik                                   | Kristen Johanson                            | Helen & Peter Randolph                |
| Cecilia Arana                        | Cathy Dantchik                                    | Andrea Johnson                              | Jacquelyn Reingold                    |
| Emily Armstrong                      | Leslie Dantchik                                   | Cindy Kaplan & David Froelich               | Anita A. Rogerson                     |
| James Armstrong                      | Peter & Judith Dawkins                            | Valerie Kay & Bruce Graham                  | David Ross & Laura Ross               |
| Dominick & Ilene Balletta            | Carolyn & Neil DeSena                             | Louise Klebanoff                            | Dr. Steve Rudin                       |
| Becky Ann & Dylan Baker              | Rebecca & Richard Dresser                         | Henry Krieger & Robert Joy                  | Laura Sametz & Anton Fig              |
| Ken Bantum                           | Peter Doyle                                       | Jacki Ochs & Jan Kroeze                     | Karin & Thomas Schall                 |
| Carolyn Bechtel                      | Max Dyksterhouse<br>& David Roady                 | Judy Kuhn & David Schwab                    | Maury Schott                          |
| Lisa Benavides<br>& Tim Blake Nelson | Doug Eisenberg                                    | Frances & Fred Langbecker                   | Susan Schroeder<br>& Britt Adams      |
| Louisa Benton                        | Lynn Ellenberg                                    | Gabrielle Lansner<br>& Dean Taucher         | Whitney Scott<br>& Peter Jacobson     |
| Gavin Berger<br>& Craig Berggren     | Nora Ephron<br>& Nicholas Pileggi                 | Brian Lapin                                 | Meg Simon                             |
| Stephanie Berger & Paul King         | Peter Jay Fernandez<br>& Denise Burse Fernandez   | Michael Lawrence<br>& Glen Gillen           | Christopher Solomon                   |
| Beth & Eric Berman                   | Liz Flahive & Jeff Cox                            | Warren Leight & Karen Hauser                | Jonathan Soros<br>& Jennifer Soros    |
| David Beth                           | Wendy Flanagan<br>& Chris O'Malley                | Mickey Lemle                                | Jenny & Jon Steingart                 |
| Lewis Black                          | Karen & Paul Freitas                              | Jonathan Levine                             | Tracy Straus                          |
| Emily Blavatnik                      | Sally Froelich                                    | Helen Levy                                  | Danny Strong                          |
| Allison Blinksen                     | Alexandra Garrison                                | Melissa Liebling-Goldberg<br>& John Barrett | Al Styron & Ed Beason                 |
| Noah Bogan                           | Beverly Gasner                                    | Kay M. Lim                                  | Susanna Styron                        |
| Jane Bolster<br>& Steve Wertimer     | Rose Gasner & Larry Chertoff                      | Adrienne Lobel                              | Richard Sweren                        |
| Buzz Bovshow                         | Celia Gerard & Mark McGrath                       | John Lynch                                  | Lili Taylor                           |
| Blaise R. Box                        | Christina Gerber                                  | Grace Lyu-Volckhausen                       | Lisa Tilney & Chris Lawrence          |
| Becky Browder<br>& Ted Neustadt      | Freddie & Myrna Gershon                           | Julie & Alex Margolies                      | Merritt Tilney & Douglas Kaden        |
| Carlton T. Brown                     | Jenny Gersten & Willie Reale                      | Ali Marsh                                   | Lorraine Tobias & Alex Draper         |
| Iris A. Brown & Joe White            | Alexandra Gersten-Vassilaros<br>& John Vassilaros | Lin Manuel Miranda                          | Liz Tuccillo                          |
| Justin Brownhill                     | Scott Aaron Gewirtz<br>& Laura Gewirtz            | Frances McDormand<br>& Joel Coen            | Laura Valeroso<br>& David Seidman     |
| Brian Byrnes                         | Elizabeth Giamatti                                | Emily & John Morgan                         | Wendy vanden Heuvel<br>& Brad Coley   |
| Shawn & Laura Byron                  | Robert Goldberg<br>& Betsy MacIsaac               | Amanda & Neal Moszkowski                    | Susan J. Vitucci                      |
| Joseph Capozzi                       | Stephen & Cathy Graham                            | Suzen Murakoshi<br>& Mark Temme             | Mary Pat Walsh                        |
| Leah Carr                            | Jan Gura & Alan Pickman                           | Fred Nelson                                 | Dr. Mildred Walton                    |
| Lawrence Catena                      | Susan Hanson                                      | Randy & Rona Nelson                         | Brenda Whelke & John C. Lynch         |
| Chris Ceraso                         | Jessica Hecht<br>& Adam Bernstein                 | Ruth Nelson                                 | Carol Whitesides                      |
| Rachel Chanoff                       | Kathy & Jamie Herring                             | Lori O'Connor                               | Zee Wiener                            |
| Todd Christie                        | Peter Herdrich & Karen Trott                      | Carol Ochs & Bruce MacVittie                | Ruth Ann Wynter                       |
| Damien Clancy                        | William Holtzman<br>& S. Sylvia Shepard           | Jacki Ochs & Jan Kroeze                     | J.P. Xenakis                          |
| Matthew Clancy                       | Mary Horowitz                                     | Kevin O'Rourke<br>& Edith Thurber           | Carole Yass                           |
| Katie Clark                          |   | Jane Perlmutter<br>& Greg MacPherson        | Yildiz Yuksek<br>& Richard Blackstone |
| Elizabeth Clemants                   |   | Elizabeth Peters                            | Connie & Marc Zand                    |
| David Cohen<br>& Sandra Novak Cohen  |   |   |                                       |
| Larry Cohen                          |   |   |                                       |

# The 52nd Street Project Presents

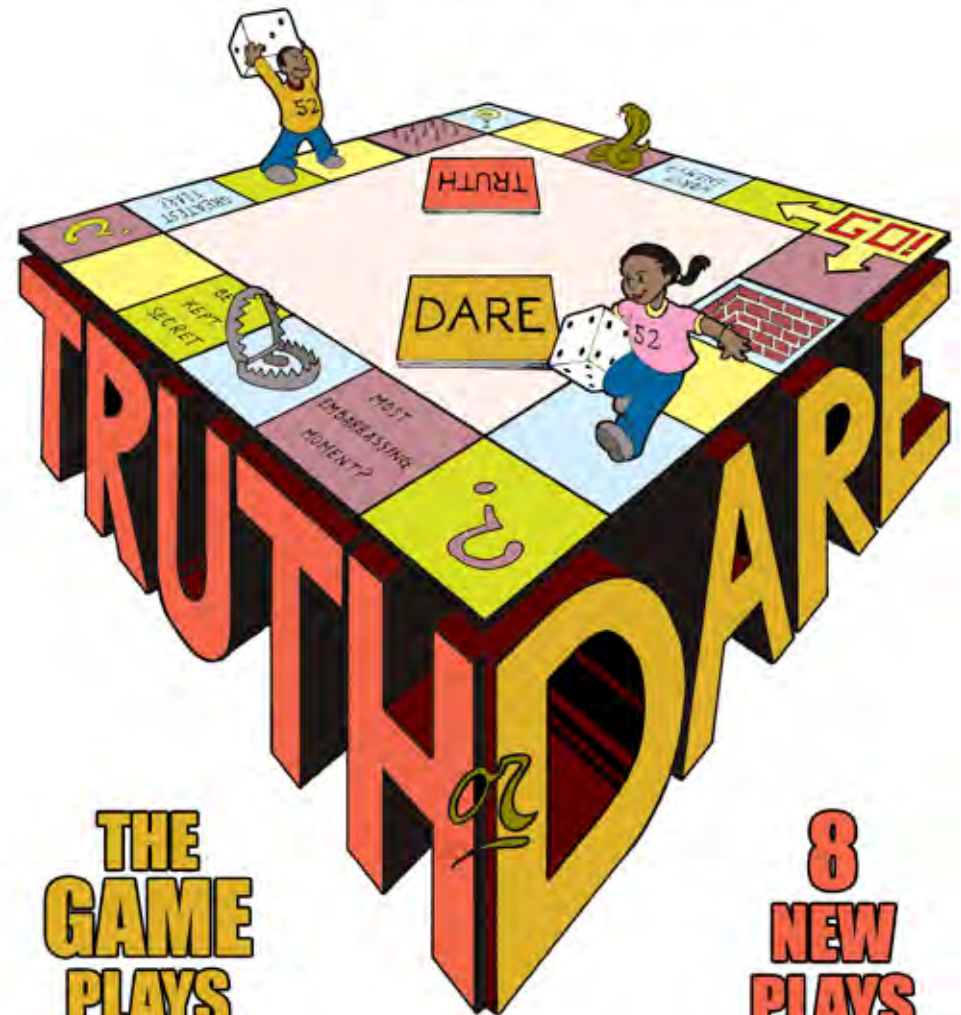

**THE  
GAME  
PLAYS**  
**PLAYBACK, 2012**

**8  
NEW  
PLAYS**

written by kids and  
performed by the playwrights  
with adult partners

## THE FIVE ANGELS THEATER

**Friday, October 19 at 7:30 p.m.**  
**Saturday, October 20 at 7:30 p.m.**  
**Sunday, October 21 at 3:00 p.m.**

# Truth or Dare: The Game Plays

Playback 2012 - Oct. 19-21, The Five Angels Theater

## The 52nd Street Project Staff

Gus Rogerson, Artistic Director  
Megan Cramer, Associate Artistic Director  
George Babiak, Production Manager  
Ray Harold, Technical Director  
Carol Ochs, Executive Director  
Lisa Kerner, General Mgmt. Associate  
John Sheehy, Dir. of Development & Marketing  
Josh Moody, Development Associate  
Liz Bell, Director of Education  
Steven Hajar, Education Assistant

### Consultants:

Iris A. Brown, Graphic Designer; Chris Ceraso, Teen Dean

### Interns:

Charlie O'Rourke, Lillian White

### Teen Employees:

Receptionists: Joyce Cheung, Gabriella DeJesus, Alvin Garcia, Jason Gil  
Ushers: Lincoln Bernard, Ralphie Irizarry III, Eliza Munoz, Tiara Varela

## "Truth or Dare" Production Staff

### Composer/Music Director

Eric March

### Set Designer

Kevin Joseph Roach

### Lighting Designer

Greg McPherson

### Costume Designer

Kathleen Doyle

### Sound Designer

Chris Steele-Nicholson

### Stage Manager

Liz Bell

### Slide Designs

George Babiak, Lillian White & the Project Slide Archive

### Prop Design Team

George Babiak, Sabrina Caldonia,  
Megan Cramer, Charlie O'Rourke,  
Lee Rosen, Lillian White

### Backstage Crew

Tatiana Goode, Alex Malan, Charlie O'Rourke, Lillian White

### House Managers

Liz Bell, Karin Schall,  
Mary Pat Walsh

### Show Photographers

Winston Rodney,  
Chamel Rodney

### Chefs

Liz Bell, John Sheehy

### Bridgehampton Hosts

The Gersten-Vassilaros Family,  
Marie Rubin, Patrice and  
Louis Friedman.



The Playback Program is made possible with public funds from The New York State Council on the Arts, a state agency, and the New York City Department of Cultural Affairs. The 52nd Street Project is supported by the Open Society Foundations and the Fund for the City of New York. The 52nd Street Project is a member of Art/NY.

## COOL STUFF ON SALE IN THE LOBBY!

Fabulous Flyer Bars .....\$2.50 and \$2.00

and featuring Shel Silverstein's  
"Fivey and Twoey" logo:

Project T-shirts ..... \$12.00  
Project Hoodies ..... \$30.00  
Project Caps..... \$20.00  
Project Mugs..... \$5.00  
Project Notebook..... \$5.00

Thank you for coming to TRUTH OR DARE! If you are not on our mailing list (or if your address has changed), please fill out this form and give it to us on your way out or mail it to the address below. We would also like to know if you are interested in becoming a volunteer. We need help in all areas, so be sure to fill out the entire form.

PLEASE ADD ME TO YOUR MAILING LIST:

10/12

NAME \_\_\_\_\_

ADDRESS \_\_\_\_\_

CITY \_\_\_\_\_

STATE \_\_\_\_\_

ZIP \_\_\_\_\_

HOME PHONE \_\_\_\_\_

DAYTIME OR MOBILE PHONE \_\_\_\_\_

E-MAIL ADDRESS \_\_\_\_\_

MY OCCUPATION \_\_\_\_\_

MY HOBBIES \_\_\_\_\_

YES, I WOULD LIKE TO BE OF HELP. I CAN:

- |   |  |
|---|--|
| <input type="checkbox"/> Draw and/or paint            | <input type="checkbox"/> Help kids with homework |
| <input type="checkbox"/> Hang lights                  | <input type="checkbox"/> Help with mailings      |
| <input type="checkbox"/> Work on a backstage crew     | <input type="checkbox"/> Do office work          |
| <input type="checkbox"/> Do graphic design            | <input type="checkbox"/> Design sound            |
| <input type="checkbox"/> Other (please specify) _____ | <input type="checkbox"/> Teach kids a skill      |
|   | <input type="checkbox"/> Be a chef at an event   |
|   | <input type="checkbox"/> Design and sew costumes |

MY SCHEDULE IS:

- Very flexible. I'm often available during weekdays.  
 Somewhat flexible. I can help on the occasional morning or afternoon during the week.  
 Not very flexible at all, but I've got some free time on evenings and weekends.

If you would like to mail this (and you're always welcome to enclose a tax-deductible contribution), you can send it to: The 52nd Street Project, 789 10th Avenue, New York, NY 10019. Or fax it to (212) 333-5598.

## COMING UP SOON AT THE PROJECT!



**December 7-9, 2012 at The Five Angels Theater**

Last month, the youngest Project members began Megan Cramer's class in the fine art of Playmaking.

Come see N.Y.'s best adult actors interpret the work of 10 year old playwrights.



**BE ON THE LOOKOUT!**  
WE ARE ALWAYS  
SEARCHING FOR INTERNS.

If you know of any college or graduate students who might enjoy working with us, playing with us, and going on trips with us for a semester, please have them contact Lisa Kerner. We are especially looking for interns for the Spring and Summer of 2013. Thanks!

### The 52nd Street Project Board of Directors

Lisa Benavides	Carol Ochs
Rachel Chanoff	Willie Reale, founder
Cathy Dantchik	Gus Rogerson
Carolyn DeSena	Shirley Rumierk, alumni member
Wendy Ettinger, chair emeritus	José Soto, Jr., alumni member
Louis P. Friedman	Jenny Steingart
Robert Goldberg	Lisa Tilney
Stephen Graham, chair	Merritt Tilney
Valerie Kay	Wendy vanden Heuvel
James McDaniel	John A. Vassilaros
Frances McDormand	
Noël Mihalow	

---

### What's Going On Here?

The 52nd Street Project is a non-profit organization that brings children from the Hell's Kitchen neighborhood together with professional theater artists to create original theater. TRUTH OR DARE is a production of our Playback program, in which kid actor/playwrights wrote plays for themselves and adult actor/director partners. Everyone ventured to the Hamptons for a rehearsal retreat over the Columbus Day weekend. All of the kids involved are veterans of the Playmaking classes which were adapted for the Project by Daniel Judah Sklar from his book *Playmaking: Children Writing and Performing Their Own Plays*.

---

### In-Kind Contributions

The Murphy Law Office; Abbeville Press; Stephanie Berger Photography; Lewis Black; Richard Blackstone; Iris A. Brown Design; City Winery; William Curran & A Curran Affair; Kate Cusack; EMI Records; ICI; The S.F. Giants; Newman's Own; Macy's; Pharma Print; PineRock; The N; Shapiro Lobel, LLP; Wendy Stuhlberg; The Yankees; John A. Vassilaros; Watkins, Inc.; Mayor's Office of Film & Television; Boylan's Bottling Co.; Hudson Scenic; and Paul, Weiss, Rifkind, Wharton & Garrison LLP.

---

### Special Thanks

We're extremely grateful to John Vassilaros & Alex Gersten-Vassilaros for allowing us to use their home as our headquarters on our rehearsal trip to the Hamptons. Thanks also to the Rubin family, and to Louis and Patrice Friedman, who let some of our kids and volunteers crash at their homes in Bridgehampton.



# TRUTH OR DARE - Act 1

All original music composed by Eric March.

## CURING MR. AND MRS. CARROT

Written by Jocelyn Ochoa, age 13

Director/Dramaturge: Lanna Joffrey

Cindy Carrot ..... Jocelyn Ochoa  
Mandy Carrot..... Lanna Joffrey  
Zander Carrot ..... George Babiak  
Customer ..... Lillian White  
More Customers ..... The Crew  
*I Was Right!!!!* lyrics by Jocelyn Ochoa

## THIEVERY

Written by Brandon Draude, age 13.

Director/Dramaturge: Michael Propster

Elijah Simison ..... Brandon Draude  
Jon Jon Shapino..... Michael Propster  
Security..... Lillian White  
Apple Store staff ..... The Crew  
*The Life of Thievery* lyrics by Brandon Draude

## THE GIRLS NOT NEXT DOOR

Written by Melody Cruz, age 13

Director/Dramaturge: Amirah Vann

Penelope Perez.....Melody Cruz  
Joan Knight..... Amirah Vann  
Gym Teacher ..... George Babiak  
Dodge Ball Players ..... The Crew  
*It's Gonna Break and My Life Story* lyrics by Melody Cruz

## TROUBLE WITH THE BROS

Written by Rene Paul Santiago, age 13

Director/Dramaturge: Raul Castillo

Dr. Orlando Ruiz.....Rene Paul Santiago  
Matthew Ruiz.....Raul Castillo  
Mrs. Hellmer ..... Megan Cramer  
Mugger ..... John Sheehy  
Tappy the Dog ..... Tatiana Goode  
Charles the Rat..... Alex Malan  
*Trying Again* lyrics by Rene Paul Santiago

# TRUTH OR DARE - Act 2

## A STAR FROM THE GALAXY

Written by Siara Feliciano, age 13

Director/Dramaturge: Emily Dorsch

Mega Million ..... Siara Feliciano  
Nancy McNelly..... Emily Dorsch  
Auditioners..... The Crew  
Principal..... Lillian White  
*A Star Comes Once in a Lifetime and Break it Down*  
lyrics by Siara Feliciano

## L.A.U.C.

Written by Miguelangel Vazquez, age 13

Director/Dramaturge: Louis Changchien

Mike Morrison .....Miguelangel Vazquez  
John Warren ..... Louis Changchien  
Chief ..... John Sheehy  
Chris ..... Gus Rogerson  
*We Got to Work Together* lyrics by Miguelangel Vazquez

## APART AND BACK TOGETHER AGAIN

Written by Leah Macuilt, age 13

Director/Dramaturge: Wrenn Schmidt

Melissa ..... Leah Macuilt  
Jennifer..... Wrenn Schmidt  
Friends..... Tatiana Goode and Lillian White  
*What We Both Want* lyrics by Leah Macuilt

## FACE PUNCH

Written by Enrique Caballero, age 12

Director/Dramaturge: Evan Enderle

Mic ..... Enrique Caballero  
Sensei Wu ..... Evan Enderle  
Mom..... Megan Cramer  
Fire Monsters..... Charlie O'Rourke and Lillian White  
The Sensettes ..... Megan Cramer, Emily Dorsch, Amirah Vann  
*Why* lyrics by Enrique Caballero

The 52nd Street Project is a non-profit organization that brings children from the Hell's Kitchen neighborhood together with professional theater artists to create original theater... and many other things! The Poetry In Performance program gives children of the Project a chance to express themselves in verse and then perform their poems before a live audience.

### Special Thanks

The poets wouldn't have made it to the stage without the help of these Poetry In Performance volunteers: Erin Cherry, Nehassaiu DeGannes, John Dixon, Nic Grelli, Ginny Lee, Flor De Liz Perez, Alejandro Rodriguez, and Christina Roussos. We were honored to have guest poet Nick Flynn visit our class to share his work with the young poets. Finally, we'd like to thank the Cohen family and friends for their support of our Poetry in Performance Program.

### The Project Staff

Gus Rogerson ..... Artistic Director  
Carol Ochs..... Executive Director  
John Sheehy..... Director of Development and Marketing  
George Babiak..... Production Manager  
Liz Bell..... Director of Education  
Megan Cramer..... Associate Artistic Director  
Joshua A. Moody..... Development Associate  
Ray Harold..... Technical Director  
Lisa Kerner ..... General Management Associate  
Chris Ceraso..... Teen Dean  
Steven Hajar..... Education Assistant  
Iris A. Brown ..... Graphic Designer  
Haley Martinez..... Poetry Class Teen Assistant  
Interns..... Charlie O'Rourke and Lillian White

### The 52nd Street Project Board of Directors

Lisa Benavides	Carol Ochs
Rachel Chanoff	Willie Reale, founder
Cathy Dantchik	Gus Rogerson
Carolyn DeSena	Shirley Rumierk, alumni member
Wendy Ettinger, chair emeritus	José Soto, Jr., alumni member
Louis P. Friedman	Jenny Steingart
Robert Goldberg	Lisa Tilney
Stephen Graham, chair	Merritt Tilney
Valerie Kay	Wendy vanden Heuvel
James McDaniel	John A. Vassilaros
Frances McDormand	
Noël Mihalow	

The 52nd Street Project Presents  
The 2012 Lorraine Cohen

# Poetry in Performance Program

22 new poems by  
11 young poets

Monday, November 19, 2012  
6:00 p.m.

The Five Angels Theater  
The 52nd Street Project  
789 10th Avenue

# The Poems

(Listed Alphabetically by Poet)

---

## **Talent Show**

### **The Little Wolf**

Justin Bannister, age 11

---

## **The Frosty Pier**

### **The Girl In The Feather Scarf**

Jasmine Nicole Correa, age 12

---

## **2 Happy People In The Garden**

### **Battling Darkness**

Ricardo Currin, age 11

---

## **I Am Different**

### **My Night Light**

Edelys Guerrero, age 12

---

## **Green Freak**

### **Stalker**

Genesis Hires, age 12

## **The Very Annoying Princess**

### **What A Day**

Imani Lewis, age 11

---

## **Hot Ass Car**

### **My Ugly Life**

Bryan Lopez, age 11

---

## **Pizza**

### **Tough Guy**

Alex Malan, age 11

---

## **Ali!**

### **Lola**

Amber Ureña, age 12

---

## **Sergeant Half Moon**

### **My Crush**

Lambert Whitney, age 11

---

## **Hell's Kitchen Poem**

### **Flying**

Ruby Zamora, age 12

## **Lorraine Cohen** **1927-2005**

For more than forty years, Lorraine Cohen dedicated herself to all facets of the theater, including acting, directing and teaching. Her deeply memorable performances as Amanda in *The Glass Menagerie* and as Emily Dickinson in *The Belle of Amherst* were often compared favorably with the very well known actors who had played those roles before her. Those who knew her as a teacher, remember the amazing annual Shakespeare productions of her fifth graders and the many stunning performances of her high school students.

In the 1960's Laurie performed in a series of plays at the Bergen County Players in New Jersey including *Ring Around Elizabeth* (1960), *Fumed Oak* (1961), *Blithe Spirit* (1962), and *The Waltz of the Toreadors* (1961). In 1969 she performed in *No Bed of Roses* at the Showplace Summer Theatre. Laurie also spent many productive years at The New Dimension Theatre Studio in Englewood, New Jersey where Dr. Richard Imundo was the Artistic Director. At The New Dimension she taught acting to children and young adults, and also performed in many productions including *Animal* (1971), *The Glass Menagerie*, and *Uncle Vanya* (1970). She also directed and acted in many evenings of scenes at The New Dimension. One of her early students at The New Dimension was a young man by the name of John Travolta who also performed with her in *Who'll Save the Plowboy?* (1966).

Having obtained her college degree from Fairleigh Dickinson University in Teaneck, New Jersey, she performed in a series of plays produced by the University Players, including *Ghosts*, *The Glass Menagerie*, and *J.B.* While studying for her masters degree at Montclair State College, she performed in several productions there including *The Hostage*, *Plaza Suite*, and *Not Now Darling*. Laurie also performed in *Cinderella* at the William Paterson College Summer Theatre Workshop, and in 1984 she performed in *The Devil's Disciple* at the Williamstown Theatre Festival in Williamstown, Massachusetts.

In 1983 Laurie starred as Emily Dickinson in the one-woman show *The Belle of Amherst*, directed by her friend and colleague, John Brancato. *The Belle of Amherst* had a limited run at The Tyson Studio in New York City to rave reviews in *The New York Times* and *The Daily News*.

Though many encouraged Laurie to pursue a professional acting career, she always made it clear that her true love was teaching and she dedicated much of her life to filling young students' hearts and minds with the love of theatre, both in its literary form and as a performing art. During her tenure in the 1970's as a fifth grade teacher at the Longfellow School in Teaneck, New Jersey, she directed an annual Shakespeare play starring her fifth grade students, performing the likes of *Macbeth*, *Julius Caesar* and *Hamlet*. Laurie's love of theater and teaching reached its pinnacle during her many years teaching English and Drama at Teaneck High School in Teaneck, New Jersey. She truly loved teaching drama to high school students, introducing them to the joys of acting and play-writing, and she directed an enormous number of full length productions, musicals, scenes, and student-written original plays. She directed too many shows to list individually, but they included *Cabaret*, *Diary of Anne Frank*, *A Midsummer Night's Dream*, *The Crucible*, *The Man Who Came To Dinner*, *Don't Drink the Water* and *Waiting for Godot*. In addition to these productions, she directed the students in an annual *Evening of Scenes*. Her students won many awards for their work at the annual Bucks County Playhouse Drama Festivals in Pennsylvania. Even after retirement from teaching, she continued to direct performances at Leonia High School, in Leonia, New Jersey.

In addition to acting and teaching, Laurie also edited three books for the theatre: *Scenes for Young Actors*, *Monologues for Young Actors*, and *Scenes for Mature Actors*, all published by Avon Books. These three books continue to be used today in acting classes and auditions around the country.

Laurie is remembered lovingly by her five children, her three siblings, her eight grandchildren, her companion Dick, her many colleagues and friends, and her innumerable students. It is in her memory that they support the 52nd Street Project. It is what she would have wanted.



## **Lorraine Cohen** **1927-2005**

For more than forty years, Lorraine Cohen dedicated herself to all facets of the theater, including acting, directing and teaching. Her deeply memorable performances as Amanda in *The Glass Menagerie* and as Emily Dickinson in *The Belle of Amherst* were often compared favorably with the very well known actors who had played those roles before her. Those who knew her as a teacher, remember the amazing annual Shakespeare productions of her fifth graders and the many stunning performances of her high school students.

In the 1960's Laurie performed in a series of plays at the Bergen County Players in New Jersey including *Ring Around Elizabeth* (1960), *Fumed Oak* (1961), *Blithe Spirit* (1962), and *The Waltz of the Toreadors* (1961). In 1969 she performed in *No Bed of Roses* at the Showplace Summer Theatre. Laurie also spent many productive years at The New Dimension Theatre Studio in Englewood, New Jersey where Dr. Richard Imundo was the Artistic Director. At The New Dimension she taught acting to children and young adults, and also performed in many productions including *Animal* (1971), *The Glass Menagerie*, and *Uncle Vanya* (1970). She also directed and acted in many evenings of scenes at The New Dimension. One of her early students at The New Dimension was a young man by the name of John Travolta who also performed with her in *Who'll Save the Plowboy?* (1966).

Having obtained her college degree from Fairleigh Dickinson University in Teaneck, New Jersey, she performed in a series of plays produced by the University Players, including *Ghosts*, *The Glass Menagerie*, and *J.B.* While studying for her masters degree at Montclair State College, she performed in several productions there including *The Hostage*, *Plaza Suite*, and *Not Now Darling*. Laurie also performed in *Cinderella* at the William Paterson College Summer Theatre Workshop, and in 1984 she performed in *The Devil's Disciple* at the Williamstown Theatre Festival in Williamstown, Massachusetts.

In 1983 Laurie starred as Emily Dickinson in the one-woman show *The Belle of Amherst*, directed by her friend and colleague, John Brancato. *The Belle of Amherst* had a limited run at The Tyson Studio in New York City to rave reviews in *The New York Times* and *The Daily News*.

Though many encouraged Laurie to pursue a professional acting career, she always made it clear that her true love was teaching and she dedicated much of her life to filling young students' hearts and minds with the love of theatre, both in its literary form and as a performing art. During her tenure in the 1970's as a fifth grade teacher at the Longfellow School in Teaneck, New Jersey, she directed an annual Shakespeare play starring her fifth grade students, performing the likes of *Macbeth*, *Julius Caesar* and *Hamlet*. Laurie's love of theater and teaching reached its pinnacle during her many years teaching English and Drama at Teaneck High School in Teaneck, New Jersey. She truly loved teaching drama to high school students, introducing them to the joys of acting and play-writing, and she directed an enormous number of full length productions, musicals, scenes, and student-written original plays. She directed too many shows to list individually, but they included *Cabaret*, *Diary of Anne Frank*, *A Midsummer Night's Dream*, *The Crucible*, *The Man Who Came To Dinner*, *Don't Drink the Water* and *Waiting for Godot*. In addition to these productions, she directed the students in an annual *Evening of Scenes*. Her students won many awards for their work at the annual Bucks County Playhouse Drama Festivals in Pennsylvania. Even after retirement from teaching, she continued to direct performances at Leonia High School, in Leonia, New Jersey.

In addition to acting and teaching, Laurie also edited three books for the theatre: *Scenes for Young Actors*, *Monologues for Young Actors*, and *Scenes for Mature Actors*, all published by Avon Books. These three books continue to be used today in acting classes and auditions around the country.

Laurie is remembered lovingly by her five children, her three siblings, her eight grandchildren, her companion Dick, her many colleagues and friends, and her innumerable students. It is in her memory that they support the 52nd Street Project. It is what she would have wanted.



The 52nd Street Project gratefully acknowledges the support of the following foundations and corporations: Bloomberg; Brenner Family Foundation; Cantor Fitzgerald; CBS Corporation; The Common Sense Fund; Consolidated Edison; Dawkins Family Foundation; The Neil V. DeSena Foundation; The Dramatists Guild Fund; Dramatists Play Service; The Educational Foundation Of America; Sidney E. Frank Foundation; Fund for the City of New York; Goldman Sachs; The Horace W. Goldsmith Foundation; Heisman Foundation; Hudson Scenic Studio; Lotos Foundation; Ann M. Martin Foundation; Marusi Family Foundation; Monteforte Foundation; Newman's Own; The PAR Group; The People's Choice Awards; Quadra Productions; Sesame Workshop; The Shubert Organization; Simon & Eisenberg; Starker Family Foundation; Harold & Mimi Steinberg Charitable Trust; Surdna Foundation; Susquehanna Investment Group; Tax Pro Financial Network, Inc.; TCG; Theater Subdistrict Council; Tiger Baron Foundation; Van Deusen Family Fund; Vervane Foundation; Watkins, Inc.; WMEE Foundation; Yorke Construction Corp. (list current as of 7/20/12)

- |                                      |   |   |                                       |
|--------------------------------------|---|---|---------------------------------------|
| Robert Abrams<br>& Cynthia Vance     | Penelope Collins<br>Judith-Ann Corrente           | Sarah Horowitz<br>& David Venarde           | Sue Phillips<br>Todd Poisson          |
| George Ackert                        | Janet Coviello                                    | Andrea Johnson                              | Suzanne Poulin                        |
| Michael Alicastro                    | William Crudup                                    | Beth Ifcher                                 | Helaine & Michael Pruzan              |
| Elton Andrews                        | Kyle Czepiel                                      | Carine Joannou                              | Christopher Randolph                  |
| Richard Anthony                      | Arthur Dantchik                                   | Kristen Johanson                            | Helen & Peter Randolph                |
| Cecilia Arana                        | Cathy Dantchik                                    | Andrea Johnson                              | Jacquelyn Reingold                    |
| Emily Armstrong                      | Leslie Dantchik                                   | Cindy Kaplan & David Froelich               | Anita A. Rogerson                     |
| James Armstrong                      | Peter & Judith Dawkins                            | Valerie Kay & Bruce Graham                  | David Ross & Laura Ross               |
| Dominick & Ilene Balletta            | Carolyn & Neil DeSena                             | Louise Klebanoff                            | Dr. Steve Rudin                       |
| Becky Ann & Dylan Baker              | Rebecca & Richard Dresser                         | Henry Krieger & Robert Joy                  | Laura Sametz & Anton Fig              |
| Ken Bantum                           | Peter Doyle                                       | Jacki Ochs & Jan Kroeze                     | Karin & Thomas Schall                 |
| Carolyn Bechtel                      | Max Dyksterhouse<br>& David Roady                 | Judy Kuhn & David Schwab                    | Maury Schott                          |
| Lisa Benavides<br>& Tim Blake Nelson | Doug Eisenberg                                    | Frances & Fred Langbecker                   | Susan Schroeder<br>& Britt Adams      |
| Louisa Benton                        | Lynn Ellenberg                                    | Gabrielle Lansner<br>& Dean Taucher         | Whitney Scott<br>& Peter Jacobson     |
| Gavin Berger<br>& Craig Berggren     | Nora Ephron<br>& Nicholas Pileggi                 | Brian Lapin                                 | Meg Simon                             |
| Stephanie Berger & Paul King         | Peter Jay Fernandez<br>& Denise Burse Fernandez   | Michael Lawrence<br>& Glen Gillen           | Christopher Solomon                   |
| Beth & Eric Berman                   | Liz Flahive & Jeff Cox                            | Warren Leight & Karen Hauser                | Jonathan Soros                        |
| David Beth                           | Wendy Flanagan<br>& Chris O'Malley                | Mickey Lemle                                | & Jennifer Soros                      |
| Lewis Black                          | Karen & Paul Freitas                              | Jonathan Levine                             | Jenny & Jon Steingart                 |
| Emily Blavatnik                      | Sally Froelich                                    | Helen Levy                                  | Tracy Straus                          |
| Allison Blinks                       | Alexandra Garrison                                | Melissa Liebling-Goldberg<br>& John Barrett | Danny Strong                          |
| Noah Bogan                           | Beverly Gasner                                    | Kay M. Lim                                  | Al Styron & Ed Beason                 |
| Jane Bolster<br>& Steve Wertimer     | Rose Gasner & Larry Chertoff                      | Adrienne Lobel                              | Susanna Styron                        |
| Buzz Bovshow                         | Celia Gerard & Mark McGrath                       | John Lynch                                  | Richard Sweren                        |
| Blaise R. Box                        | Christina Gerber                                  | Grace Lyu-Volckhausen                       | Lili Taylor                           |
| Becky Browder<br>& Ted Neustadt      | Freddie & Myrna Gershon                           | Julie & Alex Margolies                      | Lisa Tilney & Chris Lawrence          |
| Carlton T. Brown                     | Jenny Gersten & Willie Reale                      | Ali Marsh                                   | Merritt Tilney & Douglas Kaden        |
| Iris A. Brown & Joe White            | Alexandra Gersten-Vassilaros<br>& John Vassilaros | Lin Manuel Miranda                          | Lorraine Tobias & Alex Draper         |
| Justin Brownhill                     | Scott Aaron Gewirtz<br>& Laura Gewirtz            | Frances McDormand<br>& Joel Coen            | Liz Tuccillo                          |
| Brian Byrnes                         | Elizabeth Giamatti                                | Emily & John Morgan                         | Laura Valeroso<br>& David Seidman     |
| Shawn & Laura Byron                  | Robert Goldberg<br>& Betsy MacIsaac               | Amanda & Neal Moszkowski                    | Wendy vanden Heuvel<br>& Brad Coley   |
| Joseph Capozzi                       | Stephen & Cathy Graham                            | Suzen Murakoshi<br>& Mark Temme             | Susan J. Vitucci                      |
| Leah Carr                            | Jan Gura & Alan Pickman                           | Fred Nelson                                 | Mary Pat Walsh                        |
| Lawrence Catena                      | Susan Hanson                                      | Randy & Rona Nelson                         | Dr. Mildred Walton                    |
| Chris Ceraso                         | Jessica Hecht<br>& Adam Bernstein                 | Ruth Nelson                                 | Brenda Wehle & John C. Lynch          |
| Rachel Chanoff                       | Kathy & Jamie Herring                             | Lori O'Connor                               | Carol Whitesides                      |
| Todd Christie                        | Peter Herdrich & Karen Trott                      | Carol Ochs & Bruce MacVittie                | Zee Wiener                            |
| Damien Clancy                        | William Holtzman<br>& S. Sylvia Shepard           | Jacki Ochs & Jan Kroeze                     | Ruth Ann Wynter                       |
| Matthew Clancy                       | Mary Horowitz                                     | Kevin O'Rourke<br>& Edith Thurber           | J.P. Xenakis                          |
| Katie Clark                          |   | Jane Perlmutter<br>& Greg MacPherson        | Carole Yass                           |
| Elizabeth Clemants                   |   | Elizabeth Peters                            | Yildiz Yuksek<br>& Richard Blackstone |
| David Cohen<br>& Sandra Novak Cohen  |   |   | Connie & Marc Zand                    |
| Larry Cohen                          |   |   |                                       |



10 NEW PLAYS WRITTEN BY KIDS  
AND PERFORMED BY ADULT ACTORS

FRIDAY, DEC. 7 AT 7:30 P.M.  
SATURDAY, DEC. 8 AT 3:00 AND 7:30 P.M.  
SUNDAY, DEC. 9 AT 3:00 P.M.

THE FIVE ANGELS THEATER

# IT'S A JUNGLE OUT THERE: THE WILD PLAYS

The Fall 2012 Playmaking Production - December 7-9, The Five Angels Theater

## The 52nd Street Project Staff

Gus Rogerson, Artistic Director  
 Megan Cramer, Associate Artistic Director  
 George Babiak, Production Manager  
 Ray Harold, Technical Director

Carol Ochs, Executive Director  
 Lisa Kerner, General Mgmt. Associate  
 John Sheehy, Dir. of Development & Marketing  
 Josh Moody, Development Associate

Liz Bell, Director of Education  
 Steven Hajar, Education Assistant

### Consultants:

Iris A. Brown, Graphic Designer; Chris Ceraso, Teen Dean

### Interns:

Charlie O'Rourke, Lillian White

### Teen Employees:

Receptionists: Joyce Cheung, Gabriella DeJesus, Alvin Garcia, Jason Gil  
 Ushers: Nathaly Trinidad, Mari Ulloa, Malik Velazquez

## "It's a Jungle Out There" Production Staff

Composer/Music Director  
 Patrick Barnes

Set Designer  
 Kevin Joseph Roach

Lighting Designer  
 Greg MacPherson

Costume Designers  
 Claire De Liso

Sound Designer  
 Betsy Rhodes

Stage Manager  
 Lisa Iacucci

Projection Design:  
 George Babiak, Julie Sharbutt,  
 Lillian White and  
 the Project Slide Archive

Prop Design Team  
 George Babiak, Ursula Babiak,  
 Lisa Kerner, Charlie O'Rourke,  
 Lee Rosen, Julie Sharbutt,  
 Lillian White

Backstage Crew  
 Michael Bannister, Daquan Nelson,  
 Charlie O'Rourke, Bianca Washington,  
 Lillian White

House Managers  
 Liz Bell, Lisa Kerner, Mary Pat Walsh

Flyer Art  
 Iris A. Brown

Chefs  
 Iris A. Brown, Joe White, Walker White,  
 Liz Bell, Carol Ochs

Playmaking Class Volunteers  
 Farah Bala, Michael Barron,  
 Ka-ling Cheung, Nick Choksi, Michael  
 Feld, Natalie Mitchell, Adrienne Moore,  
 Kira Onodera, Michael Raimondi,  
 Bianca Washington

Playmaking Class Teen Assistant  
 Daquan Nelson

Production Photographer  
 Winston Rodney



This program is supported, in part, by public funds from The New York City Department of Cultural Affairs in partnership with the City Council. The Playmaking Program is also made possible with public funds from The National Endowment for the Arts and The New York State Council on the Arts, a state agency. The 52nd Street Project is supported by the Open Society Foundations and the Fund for the City of New York. The Project is a member of ART/NY.

## COOL STUFF ON SALE IN THE LOBBY!

Fabulous Flyer Bars .....\$2.00 & \$3.00

and featuring Shel Silverstein's  
 "Fivey and Twoey" logo:

Project T-shirts ..... \$12.00  
 Project Hoodies ..... \$30.00  
 Project Caps ..... \$20.00  
 Project Mugs ..... \$5.00  
 Project Pencil 3-pack ..... \$1.00  
 Project Notebook ..... \$5.00

Thank you for coming to **IT'S A JUNGLE OUT THERE**. If you are not on our mailing list (or if your address has changed), please fill out this form and give it to us on your way out or mail it to the address below. We would also like to know if you are interested in becoming a volunteer. We need help in all areas, so be sure to fill out the entire form.

PLEASE ADD ME TO YOUR MAILING LIST:

12/12

NAME \_\_\_\_\_

ADDRESS \_\_\_\_\_

CITY \_\_\_\_\_

STATE \_\_\_\_\_

ZIP \_\_\_\_\_

HOME PHONE \_\_\_\_\_

DAYTIME OR MOBILE PHONE \_\_\_\_\_

E-MAIL ADDRESS \_\_\_\_\_

MY OCCUPATION \_\_\_\_\_

MY HOBBIES \_\_\_\_\_

YES, I WOULD LIKE TO BE OF HELP. I CAN:

- |   |  |
|---|--|
| <input type="checkbox"/> Draw and/or paint            | <input type="checkbox"/> Help kids with homework |
| <input type="checkbox"/> Hang lights                  | <input type="checkbox"/> Help with mailings      |
| <input type="checkbox"/> Work on a backstage crew     | <input type="checkbox"/> Do office work          |
| <input type="checkbox"/> Do graphic design            | <input type="checkbox"/> Design sound            |
| <input type="checkbox"/> Other (please specify) _____ | <input type="checkbox"/> Teach kids a skill      |
|   | <input type="checkbox"/> Be a chef at an event   |
|   | <input type="checkbox"/> Design and sew costumes |

MY SCHEDULE IS:

- Very flexible. I'm often available during weekdays.
- Somewhat flexible. I can help on the occasional morning or afternoon during the week.
- Not very flexible at all, but I've got some free time on evenings and weekends.

If you would like to mail this (and you're always welcome to enclose a tax-deductible contribution), you can send it to: The 52nd Street Project, 789 10th Ave., New York, NY 10019. Or fax it to (212) 333-5598.

## COMING UP NEXT!

GUS ROGERSON, ARTISTIC DIRECTOR CAROL OCHS, EXECUTIVE DIRECTOR  
THE 52ND STREET PROJECT PRESENTS THE 2013 TWO-ON-TWOS

# Nobody's Perfect

## PLAYS WITH TRAGIC FLAWS



6 NEW PLAYS • 6 ADULT WRITERS • 6 ADULT DIRECTORS • 12 KID ACTORS

ALL PERFORMANCES AT THE 52ND STREET PROJECT'S  
**FIVE ANGELS THEATER**  
789 10TH AVENUE,  
BETWEEN 52ND AND 53RD ST.

FRIDAY, FEB. 1 @ 7:30 P.M.  
SATURDAY, FEB. 2 @ 7:30 P.M.  
SUNDAY, FEB. 3 @ 3:00 P.M.

ADMISSION IS FREE, BUT RESERVATIONS ARE HIGHLY RECOMMENDED. RESERVE ONLINE AT WWW.52PROJCT.ORG OR CALL (212) 462.5945



**BE ON THE LOOKOUT!**  
WE ARE ALWAYS  
SEARCHING FOR INTERNS.

If you know of any college or graduate students who might enjoy working with us, playing with us, and going on trips with us for a semester, please have them contact Lisa Kerner. We are currently looking for interns for the Spring and Summer of 2013. Thanks!

## The 52nd Street Project Board of Directors

Lisa Benavides	Carol Ochs
Rachel Chanoff	Willie Reale, founder
Cathy Dantchik	Gus Rogerson
Carolyn DeSena	Shirley Rumierk, alumni member
Wendy Ettinger, chair emeritus	José Soto, Jr., alumni member
Louis P. Friedman	Jenny Steingart
Robert Goldberg	Lisa Tilney
Stephen Graham, chair	Merritt Tilney
James McDaniel	Pamala Tyson
Frances McDormand	Wendy vanden Heuvel
Noël Mihalow	John A. Vassilaros

## What's Going On Here?

The 52nd Street Project is a non-profit organization that brings children from the Hell's Kitchen neighborhood together with professional theater artists to create original theater. *IT'S A JUNGLE OUT THERE* is a production of our Playmaking program. Young people participate in a nine-week playwriting course taught by Megan Cramer and adapted for the Project by Daniel Judah Sklar from his book *Playmaking: Children Writing and Performing Their Own Plays*. At the end of the course, each child is matched with two actors and a dramaturg/director who guides him or her through the writing of a play during a weekend retreat in the country (Stone Ridge, NY, for this show). This performance is the end result.

## In-Kind Contributions

The Murphy Law Office; Abbeville Press; Stephanie Berger Photography; Lewis Black; Richard Blackstone; Iris A. Brown Design; City Winery; William Curran & A Curran Affair; Kate Cusack; EMI Records; ICI; The S.F. Giants; Newman's Own; Macy's; Pharma Print; PineRock; The N; Shapiro Lobel, LLP; Wendy Stuhlberg; The Yankees; John A. Vassilaros; Watkins, Inc.; Boylan's Bottling Co.; Hudson Scenic; and Paul, Weiss, Rifkind, Wharton & Garrison LLP.

## Special Thanks

We're extremely grateful to Steve Gorn & Barbara Bash for the use of their beautiful home in Stone Ridge, NY as our base of operations for the writer's retreat. Also thanks to Joe White & Iris Brown, Nicole & Paul Quinn, Amy Weiss & Michael McClatchy, Nina Shengold, Deborah Freedman & Bill Woods for housing our kids; and Charlie Miles & Naomi Freundlich, Jeff Madalena & Jason Gnewikow, and David Curtis & Ann Morris for housing our adults.

# IT'S A JUNGLE OUT THERE: ACT 1

All original music composed by Patrick Barnes

## MY DREAMS

Written by Kayla Matos, age 10

Director/Dramaturge: Alex Barron

Chicken Wings Jackson ..... Eric Clem  
Jennifer Convertibles ..... Erin Felgar  
Producer ..... Bianca Washington  
*Beautiful World, Me Me Me, and Weather In My Heart* lyrics by Kayla Matos

## THE WORST DAY OF YOUR LIFE

Written by Adrian Luna, age 10

Director/Dramaturge: Angel Desai

Dave ..... Joel Perez  
Christina ..... Maria-Christina Oliveras  
Announcer ..... George Babiak  
Surfers ..... Crew

*The End* lyrics by Adrian Luna

## ADVENTURE DAY

Written by Wilhelmina Ohene Kari Kari, age 10

Director/Dramaturge: Donya Washington

Macy ..... Elvy Yost  
Zack ..... Natalie Mitchell

*Give Me Back My Dog* lyrics by Wilhelmina Ohene Kari Kari

## ZIM VS. GORLOC

Written by Ezekiel Albarron, age 10

Director/Dramaturge: Michael Raimondi

Zim ..... Aaron Costa Ganis  
Gorloc ..... Michael Braun  
Zim's Mother ..... Bianca Washington  
Zim's Brother ..... Daquan Nelson  
People at Airport ..... Crew

*Theme Song and The Next Generation* lyrics by Ezekiel Albarron

## THE BASEMENT

Written by Jafreisy Portes, age 11

Director/Dramaturge: Erin Quinn Purcell

Michael ..... Ezra Knight  
Annabelle ..... Denise Burse  
Kidnappers ..... Charlie O'Rourke, Lillian White  
Cops ..... Michael Bannister, Daquan Nelson

*Forever Brother and Sister* lyrics by Jafreisy Portes

# IT'S A JUNGLE OUT THERE: ACT 2

## THE ADVENTURE

Written by Jonathan Vega, age 10

Dramaturge/Director: Felix Solis

Stronghold ..... Edward O'Brien  
Active Girl ..... Liza Fernandez  
Newscaster ..... Charlie O'Rourke  
Fish ..... Crew

## THE ESCAPE FROM PRISON

Written by Timmy Miller, age 12

Director/Dramaturge: James Yaegashi

Samantha ..... Crystal Dickinson  
Robbert ..... Christopher Randolph

*I Have to Escape* lyrics by Timmy Miller

## THE BIG BASH BETWEEN BASH AND SMASH

Written by Camile Bernard, age 10

Dramaturge: Lisa Kerner; Director: Kira Onodera

Treestump ..... Carra Patterson  
Horsetail ..... Jeanine Serralles  
Guard ..... Bianca Washington  
Gorg ..... Megan Cramer  
Peasant ..... Lillian White

*Clikady Clok and Cling Clash* lyrics by Camile Bernard

## THE TURN OFF

Written by Brooke Fraser, age 11

Director/Dramaturge: Sarna Lapine

Maria ..... Ka-ling Cheung  
Brandon ..... Brian Hastert

*Maria's Wish, Brandon's Devastating Moment and Maria's Invisible Moment* lyrics by Brooke Fraser

## LATE NIGHT WITH ERIC BOND

Written by Amer Mousa, age 12

Director/Dramaturge: John Sheehy

Eric Bond ..... Jonathan Groff  
Alexander Walker ..... Jeremy Rische  
Announcer ..... Patrick Barnes

*Change is for the Better* lyrics by Amer Mousa





# SHOW PROGRAMS 2013

The 52nd Street Project gratefully acknowledges the support of the following foundations and corporations: Bloomberg; Brenner Family Foundation; Cantor Fitzgerald; CBS Corporation; The Common Sense Fund; Consolidated Edison; Dawkins Family Foundation; The Neil V. DeSena Foundation; The Dramatists Guild Fund; Dramatists Play Service; The Educational Foundation Of America; Sidney E. Frank Foundation; Fund for the City of New York; Goldman Sachs; The Horace W. Goldsmith Foundation; Heisman Foundation; Hudson Scenic Studio; Lotos Foundation; Ann M. Martin Foundation; Marusi Family Foundation; Monteforte Foundation; Newman's Own; The PAR Group; The People's Choice Awards; Quadra Productions; Sesame Workshop; The Shubert Organization; Simon & Eisenberg; Starker Family Foundation; Harold & Mimi Steinberg Charitable Trust; Surdna Foundation; Susquehanna Investment Group; Tax Pro Financial Network, Inc.; TCG; Tiger Baron Foundation; Van Deusen Family Fund; Vervane Foundation; Watkins, Inc.; WMEE Foundation; Yorke Construction Corp. (list current as of 7/20/12)

Robert Abrams & Cynthia Vance	Penelope Collins Judith-Ann Corrente	Sarah Horowitz & David Venarde	Sue Phillips Todd Poisson
George Ackert	Janet Coviello	Andrea Johnson	Suzanne Poulin
Michael Alicastro	William Crudup	Beth Ifcher	Helaine & Michael Pruzan
Elton Andrews	Kyle Czepiel	Carine Joannou	Christopher Randolph
Richard Anthony	Arthur Dantchik	Kristen Johanson	Helen & Peter Randolph
Cecilia Arana	Cathy Dantchik	Andrea Johnson	Jacquelyn Reingold
Emily Armstrong	Leslie Dantchik	Cindy Kaplan & David Froelich	Anita A. Rogerson
James Armstrong	Peter & Judith Dawkins	Valerie Kay & Bruce Graham	David Ross & Laura Ross
Dominick & Ilene Balletta	Carolyn & Neil DeSena	Louise Klebanoff	Dr. Steve Rudin
Becky Ann & Dylan Baker	Rebecca & Richard Dresser	Henry Krieger & Robert Joy	Laura Sametz & Anton Fig
Ken Bantum	Peter Doyle	Jacki Ochs & Jan Kroeze	Karin & Thomas Schall
Carolyn Bechtel	Max Dyksterhouse & David Roady	Judy Kuhn & David Schwab	Maury Schott
Lisa Benavides & Tim Blake Nelson	Doug Eisenberg	Frances & Fred Langbecker	Susan Schroeder & Britt Adams
Louisa Benton	Lynn Ellenberg	Gabrielle Lansner & Dean Taucher	Whitney Scott & Peter Jacobson
Gavin Berger & Craig Berggren	Nora Ephron & Nicholas Pileggi	Brian Lapin	Meg Simon
Stephanie Berger & Paul King	Peter Jay Fernandez & Denise Burse Fernandez	Michael Lawrence & Glen Gillen	Christopher Solomon
Beth & Eric Berman	Liz Flahive & Jeff Cox	Warren Leight & Karen Hauser	Jonathan Soros
David Beth	Wendy Flanagan & Chris O'Malley	Mickey Lemle	& Jennifer Soros
Lewis Black	Karen & Paul Freitas	Jonathan Levine	Jenny & Jon Steingart
Emily Blavatnik	Sally Froelich	Helen Levy	Tracy Straus
Allison Blinks	Alexandra Garrison	Melissa Liebling-Goldberg & John Barrett	Danny Strong
Noah Bogan	Beverly Gasner	Kay M. Lim	Al Styron & Ed Beason
Jane Bolster & Steve Wertimer	Rose Gasner & Larry Chertoff	Adrienne Lobel	Susanna Styron
Buzz Bovshow	Celia Gerard & Mark McGrath	John Lynch	Richard Sweren
Blaise R. Box	Christina Gerber	Grace Lyu-Volckhausen	Lili Taylor
Becky Browder & Ted Neustadt	Freddie & Myrna Gershon	Julie & Alex Margolies	Lisa Tilney & Chris Lawrence
Carlton T. Brown	Jenny Gersten & Willie Reale	Ali Marsh	Merritt Tilney & Douglas Kaden
Iris A. Brown & Joe White	Alexandra Gersten-Vassilaros & John Vassilaros	Lin Manuel Miranda	Lorraine Tobias & Alex Draper
Justin Brownhill	Scott Aaron Gewirtz & Laura Gewirtz	Frances McDormand & Joel Coen	Liz Tuccillo
Brian Byrnes	Elizabeth Giamatti	Emily & John Morgan	Laura Valeroso & David Seidman
Shawn & Laura Byron	Robert Goldberg & Betsy MacIsaac	Amanda & Neal Moszkowski	Wendy vanden Heuvel & Brad Coley
Joseph Capozzi	Stephen & Cathy Graham	Suzen Murakoshi & Mark Temme	Susan J. Vitucci
Leah Carr	Jan Gura & Alan Pickman	Fred Nelson	Mary Pat Walsh
Lawrence Catena	Susan Hanson	Randy & Rona Nelson	Dr. Mildred Walton
Chris Ceraso	Jessica Hecht	Ruth Nelson	Brenda Wehle & John C. Lynch
Rachel Chanoff	& Adam Bernstein	Lori O'Connor	Carol Whitesides
Todd Christie	Kathy & Jamie Herring	Carol Ochs & Bruce MacVittie	Zee Wiener
Damien Clancy	Peter Herdrich & Karen Trott	Lori O'Connor	Ruth Ann Wynter
Matthew Clancy	William Holtzman	Jacki Ochs & Jan Kroeze	J.P. Xenakis
Katie Clark	& S. Sylvia Shepard	Kevin O'Rourke & Edith Thurber	Carole Yass
Elizabeth Clemants	Mary Horowitz	Jane Perlmutter & Greg MacPherson	Yildiz Yuksek & Richard Blackstone
David Cohen & Sandra Novak Cohen		Elizabeth Peters	Connie & Marc Zand
Larry Cohen			

THE 52ND STREET PROJECT PRESENTS

# Nobody's Perfect

## PLAYS WITH TRAGIC FLAWS



### The 2013 Two-on-Two's

6 NEW PLAYS • 6 ADULT WRITERS • 6 ADULT DIRECTORS • 12 KID ACTORS

FRIDAY, FEB. 1 @ 7:30 P.M.  
 SATURDAY, FEB. 2 @ 7:30 P.M.  
 SUNDAY, FEB. 3 @ 3:00 P.M.

THE FIVE ANGELS THEATER  
 AT THE 52ND STREET PROJECT

# NOBODY'S PERFECT: PLAYS WITH TRAGIC FLAWS

The 2013 Two-on-Two's - February 1-3, The Five Angels Theater

## The 52nd Street Project Staff

Gus Rogerson, Artistic Director  
Megan Cramer, Associate Artistic Director  
George Babiak, Production Manager  
Ray Harold, Technical Director

Carol Ochs, Executive Director  
Lisa Kerner, General Mgmt. Associate  
John Sheehy, Dir. of Development & Marketing  
Josh Moody, Development Associate

Liz Bell, Director of Education  
Steven Hajar, Education Assistant

### Consultants:

Iris A. Brown, Graphic Designer; Chris Ceraso, Teen Dean

### Interns:

Cody Sullivan, Jaclyn Triebel, Ai Vuong, Maya Zinkow

### Teen Employees:

Receptionists: Joyce Cheung, Gabriella DeJesus, Alvin Garcia, Jason Gil  
Ushers: Natalia Caballero, Alvin Garcia, Jason Gil, Maximo Jimenez, Kara Thiam

## "NOBODY'S PERFECT" Production Staff

### Composer/Music Director

Cody Owen Stine

### Set Designer

Kevin Joseph Roach

### Lighting Designer

Josh Langman

### Costume Designer

Claire DeLiso

### Sound Designer

Justin Cimino

### Stage Manager

Winnie Lok

### Projection Design:

George Babiak,  
Ursula Babiak, Ai Vuong, and the  
Project Slide Archive.

### Prop Fabrication Team

George Babiak, Cody Sullivan,  
Jaclyn Triebel, Ai Vuong,  
and Maya Zinkow.

### Backstage Crew

Cody Sullivan, Jaclyn Triebel,  
Maya Zinkow, Elizabeth Vazquez,  
Derek Tineo

### Chefs

John Sheehy, Liz Bell,  
Carol Ochs

### Main Host in Nyack

Susanna Styron



This program is supported, in part, by public funds from The New York City Department of Cultural Affairs in partnership with the City Council. The Two-on-Two's are also made possible with public funds from The New York State Council on the Arts, a state agency. The Project is a member of ART/NY.

## COOL STUFF ON SALE IN THE LOBBY!

Fabulous Flyer Bars ..... \$2.00 & \$2.50

and featuring Shel Silverstein's  
"Fivey and Twoey" logo:

Project T-shirts ..... \$12.00

Project Hoodies ..... \$30.00

Project Caps ..... \$20.00

Project Mugs ..... \$5.00

Project Notebook ..... \$5.00

Thank you for coming to **NOBODY'S PERFECT**. If you are not on our mailing list (or if your address has changed), please fill out this form and give it to us on your way out or mail it to the address below. We would also like to know if you are interested in becoming a volunteer. We need help in all areas, so be sure to fill out the entire form.

PLEASE ADD ME TO YOUR MAILING LIST:

1/13

NAME \_\_\_\_\_

ADDRESS \_\_\_\_\_

CITY \_\_\_\_\_

STATE \_\_\_\_\_

ZIP \_\_\_\_\_

HOME PHONE \_\_\_\_\_

DAYTIME OR MOBILE PHONE \_\_\_\_\_

E-MAIL ADDRESS \_\_\_\_\_

MY OCCUPATION \_\_\_\_\_

MY HOBBIES \_\_\_\_\_

YES, I WOULD LIKE TO BE OF HELP. I CAN:

- |   |  |  |
|---|--|--|
| <input type="checkbox"/> Draw and/or paint            | <input type="checkbox"/> Help kids with homework |  |
| <input type="checkbox"/> Hang lights                  | <input type="checkbox"/> Help with mailings      | <input type="checkbox"/> Teach kids a skill      |
| <input type="checkbox"/> Work on a backstage crew     | <input type="checkbox"/> Do office work          | <input type="checkbox"/> Be a chef at an event   |
| <input type="checkbox"/> Do graphic design            | <input type="checkbox"/> Design sound            | <input type="checkbox"/> Design and sew costumes |
| <input type="checkbox"/> Other (please specify) _____ |  |  |

MY SCHEDULE IS:

- Very flexible. I'm often available during weekdays.
- Somewhat flexible. I can help on the occasional morning or afternoon during the week.
- Not very flexible at all, but I've got some free time on evenings and weekends.

If you would like to mail this (and you're always welcome to enclose a tax-deductible contribution), you can send it to: The 52nd Street Project, 789 10th Ave., New York, NY 10019. Or fax it to (212) 333-5598.

## DON'T MISS OUR NEXT SHOW...

The Spring 2013 Playmaking Plays  
Thursday-Sunday, April 4-7



ART BY MICHAEL HOEFLE

Last month, 10 brand-new kids began Playmaking classes with Megan Cramer. Come see their final plays performed by professional adult actors

## ...OR THE PROJECT'S ANNUAL BENEFIT!

LEWIS BLACK & KATHLEEN MADIGAN SERIOUSLY INVITE YOU TO...

SAVE THE DATE:

MONDAY, MAY 13, 2013

# JUST KIDDING!

a STAND-UP  
SIT-DOWN  
DINNER

COMEDY WRITTEN BY KIDS &  
PERFORMED BY ADULT COMEDIANS



CONTACT JOHN "THE JESTER" SHEEHY FOR MORE INFORMATION ABOUT  
"JUST KIDDING" AT (212) 333-5252 OR SHEEHY@52PROJECT.ORG

## The 52nd Street Project Board of Directors

Lisa Benavides	Noël Mihalow
Rachel Chanoff	Carol Ochs
Cathy Dantchik	Willie Reale, founder
Carolyn DeSena	Gus Rogerson
Wendy Ettinger, chair emeritus	Shirley Rumierk, alumni member
Louis P. Friedman	José Soto, Jr., alumni member
Robert Goldberg	Jenny Steingart
Stephen Graham, chair	Lisa Tilney
Valerie Kay	Merritt Tilney
James McDaniel	Wendy vanden Heuvel
Frances McDormand	John A. Vassilaros

## What's Going On Here?

The 52nd Street Project is a non-profit organization that brings children from the Hell's Kitchen neighborhood together with professional theater artists to create original theater. **NOBODY'S PERFECT** is a production of our Two-on-Two's program, in which an adult playwright crafts a piece for a pair of Project kids to perform. Another adult directs the kids for a month that includes an intensive three-day weekend in upstate New York. Tonight's performance is the final result.

## In-Kind Contributions

Abbeville Press; Stephanie Berger Photography; Lewis Black; Richard Blackstone; Iris A. Brown Design; William Curran & A Curran Affair; Kate Cusack; FK Partners; ICI; The S.F. Giants; Newman's Own; Pharma Print; PineRock; The N; Wendy Stuhlberg; The Yankees; John A. Vassilaros; Watkins, Inc.; Boylan's Bottling Co.; Hudson Scenic; and Paul, Weiss, Rifkind, Wharton & Garrison LLP.

## Special Thanks

We owe many thanks to Susanna Styron; Wendy vanden Heuvel & Brad Coley; Polly King & John Paul Newport; and Patricia Kahn, all of whom graciously allowed us to use their homes in the Nyack area for three exhilarating and fun-filled days. Thanks also to the Sport-O-Rama skating rink in Monsey and New City Bowling, and to Deb O. and Emily Gabler.

# NOBODY'S PERFECT - ACT 1

All original music composed by Cody Owen Stine

## FORTUNE

Written by Leila Cohan-Miccio

Directed by Nic Grelli

Edgar ..... Jeremy Sanchez  
Zach ..... Lucas Ruedel  
Police Officer ..... Cody Sullivan

*Turn This Back Around* lyrics by Leila Cohan-Miccio

## PET PEEVE

Written by Sean Kenealy

Directed by Julie Sharbutt

Doctor ..... Alizette Zapata  
Jess ..... Jazmine Mikell

*That's Why My Friends Have Fur* lyrics by Cody Owen Stine

## TERROR TIME

Written by Erica Saleh

Directed by Carlo Alban

Johnny ..... Brandon Leon  
Diana ..... Haley Zoe Martinez  
Announcer ..... Cody Sullivan

*I'm Not Scared and I'm Not Scared Reprise* lyrics by Erica Saleh

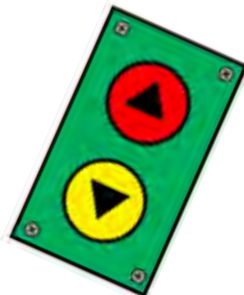

# NOBODY'S PERFECT - ACT 2

# I N T E R M I S S I O N

## TOMMY VOLT AND THE LIGHTNING GIRL

Written by Don Nguyen

Directed by Natalie Martin

Tommy Volt ..... Gerardo Escamilla  
Lightning Girl ..... Stasia Bree Quiñones

*Sweet Sweet Song, No No No, and Sweet Sweet Song Reprise*  
lyrics by Don Nguyen

## WARM HEART COLD FEET

Written by Jess Brickman

Directed by Gayle Gitlitz

Professor Eureka ..... Tiara Varela  
Sabine ..... Nathaly Trinidad  
Doris ..... Jaclyn Triebel

*The Objective Song and The Chemistry Song* lyrics by  
Jess Brickman

## TWO OLDER MEN

Written by Eric Dufault

Directed by Charlie Semine

Edwin ..... Joseph Vasquez  
Felix ..... Zoltan Lucas  
Nurse ..... Cody Sullivan

*Tales of Our Youth* lyrics by Eric Dufault

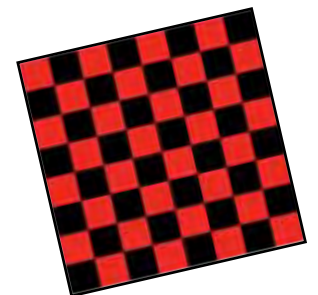

The 52nd Street Project gratefully acknowledges the support of the following foundations and corporations: Bloomberg; Brenner Family Foundation; Cantor Fitzgerald; CBS Corporation; The Common Sense Fund; Consolidated Edison; Dawkins Family Foundation; The Neil V. DeSena Foundation; The Dramatists Guild Fund; Dramatists Play Service; The Educational Foundation Of America; Sidney E. Frank Foundation; Fund for the City of New York; Goldman Sachs; The Horace W. Goldsmith Foundation; Heisman Foundation; Hudson Scenic Studio; Lotos Foundation; Ann M. Martin Foundation; Marusi Family Foundation; Monteforte Foundation; Newman's Own; The PAR Group; The People's Choice Awards; Quadra Productions; Sesame Workshop; The Shubert Organization; Simon & Eisenberg; Starker Family Foundation; Harold & Mimi Steinberg Charitable Trust; Surdna Foundation; Susquehanna Investment Group; Tax Pro Financial Network, Inc.; TCG; Tiger Baron Foundation; Van Deusen Family Fund; Vervane Foundation; Watkins, Inc.; WMEE Foundation; Yorke Construction Corp. (list current as of 7/20/12)

- |                                      |   |   |                                       |
|--------------------------------------|---|---|---------------------------------------|
| Robert Abrams<br>& Cynthia Vance     | Penelope Collins<br>Judith-Ann Corrente           | Sarah Horowitz<br>& David Venarde           | Sue Phillips<br>Todd Poisson          |
| George Ackert                        | Janet Coviello                                    | Andrea Johnson                              | Suzanne Poulin                        |
| Michael Alicastro                    | William Crudup                                    | Beth Ifcher                                 | Helaine & Michael Pruzan              |
| Elton Andrews                        | Kyle Czepiel                                      | Carine Joannou                              | Christopher Randolph                  |
| Richard Anthony                      | Arthur Dantchik                                   | Kristen Johanson                            | Helen & Peter Randolph                |
| Cecilia Arana                        | Cathy Dantchik                                    | Andrea Johnson                              | Jacquelyn Reingold                    |
| Emily Armstrong                      | Leslie Dantchik                                   | Cindy Kaplan & David Froelich               | Anita A. Rogerson                     |
| James Armstrong                      | Peter & Judith Dawkins                            | Valerie Kay & Bruce Graham                  | David Ross & Laura Ross               |
| Dominick & Ilene Balletta            | Carolyn & Neil DeSena                             | Louise Klebanoff                            | Dr. Steve Rudin                       |
| Becky Ann & Dylan Baker              | Rebecca & Richard Dresser                         | Henry Krieger & Robert Joy                  | Laura Sametz & Anton Fig              |
| Ken Bantum                           | Peter Doyle                                       | Jacki Ochs & Jan Kroeze                     | Karin & Thomas Schall                 |
| Carolyn Bechtel                      | Max Dyksterhouse<br>& David Roady                 | Judy Kuhn & David Schwab                    | Maury Schott                          |
| Lisa Benavides<br>& Tim Blake Nelson | Doug Eisenberg                                    | Frances & Fred Langbecker                   | Susan Schroeder<br>& Britt Adams      |
| Louisa Benton                        | Lynn Ellenberg                                    | Gabrielle Lansner<br>& Dean Taucher         | Whitney Scott<br>& Peter Jacobson     |
| Gavin Berger<br>& Craig Berggren     | Nora Ephron<br>& Nicholas Pileggi                 | Brian Lapin                                 | Meg Simon                             |
| Stephanie Berger & Paul King         | Peter Jay Fernandez<br>& Denise Burse Fernandez   | Michael Lawrence<br>& Glen Gillen           | Christopher Solomon                   |
| Beth & Eric Berman                   | Liz Flahive & Jeff Cox                            | Warren Leight & Karen Hauser                | Jonathan Soros<br>& Jennifer Soros    |
| David Beth                           | Wendy Flanagan<br>& Chris O'Malley                | Mickey Lemle                                | Jenny & Jon Steingart                 |
| Lewis Black                          | Karen & Paul Freitas                              | Jonathan Levine                             | Tracy Straus                          |
| Emily Blavatnik                      | Sally Froelich                                    | Helen Levy                                  | Danny Strong                          |
| Allison Blinksen                     | Alexandra Garrison                                | Melissa Liebling-Goldberg<br>& John Barrett | Al Styron & Ed Beason                 |
| Noah Bogan                           | Beverly Gasner                                    | Kay M. Lim                                  | Susanna Styron                        |
| Jane Bolster<br>& Steve Wertimer     | Rose Gasner & Larry Chertoff                      | Adrienne Lobel                              | Richard Sweren                        |
| Buzz Bovshow                         | Celia Gerard & Mark McGrath                       | John Lynch                                  | Lili Taylor                           |
| Blaise R. Box                        | Christina Gerber                                  | Grace Lyu-Volckhausen                       | Lisa Tilney & Chris Lawrence          |
| Becky Browder<br>& Ted Neustadt      | Freddie & Myrna Gershon                           | Julie & Alex Margolies                      | Merritt Tilney & Douglas Kaden        |
| Carlton T. Brown                     | Jenny Gersten & Willie Reale                      | Ali Marsh                                   | Lorraine Tobias & Alex Draper         |
| Iris A. Brown & Joe White            | Alexandra Gersten-Vassilaros<br>& John Vassilaros | Lin Manuel Miranda                          | Liz Tuccillo                          |
| Justin Brownhill                     | Scott Aaron Gewirtz<br>& Laura Gewirtz            | Frances McDormand<br>& Joel Coen            | Laura Valeroso<br>& David Seidman     |
| Brian Byrnes                         | Elizabeth Giamatti                                | Emily & John Morgan                         | Wendy vanden Heuvel<br>& Brad Coley   |
| Shawn & Laura Byron                  | Robert Goldberg<br>& Betsy MacIsaac               | Amanda & Neal Moszkowski                    | Susan J. Vitucci                      |
| Joseph Capozzi                       | Stephen & Cathy Graham                            | Suzen Murakoshi<br>& Mark Temme             | Mary Pat Walsh                        |
| Leah Carr                            | Jan Gura & Alan Pickman                           | Fred Nelson                                 | Dr. Mildred Walton                    |
| Lawrence Catena                      | Susan Hanson                                      | Randy & Rona Nelson                         | Brenda Wehle & John C. Lynch          |
| Chris Ceraso                         | Jessica Hecht<br>& Adam Bernstein                 | Ruth Nelson                                 | Carol Whitesides                      |
| Rachel Chanoff                       | Kathy & Jamie Herring                             | Lori O'Connor                               | Zee Wiener                            |
| Todd Christie                        | Peter Herdrich & Karen Trott                      | Carol Ochs & Bruce MacVittie                | Ruth Ann Wynter                       |
| Damien Clancy                        | William Holtzman<br>& S. Sylvia Shepard           | Jacki Ochs & Jan Kroeze                     | J.P. Xenakis                          |
| Matthew Clancy                       | Mary Horowitz                                     | Kevin O'Rourke<br>& Edith Thurber           | Carole Yass                           |
| Katie Clark                          |   | Jane Perlmutter<br>& Greg MacPherson        | Yildiz Yuksek<br>& Richard Blackstone |
| Elizabeth Clemants                   |   | Elizabeth Peters                            | Connie & Marc Zand                    |
| David Cohen<br>& Sandra Novak Cohen  |   |   |                                       |
| Larry Cohen                          |   |   |                                       |



ARTWORK BY MICHAEL HOEFLER

## the spring 2013 playmaking plays

**10 new plays written by kids  
and performed by adult actors.**

**thursday, april 4 at 7:30 p.m.**

**friday, april 5 at 7:30 p.m.**

**saturday, april 6 at 7:30 p.m.**

**sunday, april 7 at 3:00 p.m.**

**at the 52nd street project's  
five angels theater**

# stand by me: the reliable plays

The Spring 2013 Playmaking Production -April 4-7, The Five Angels Theater

## The 52nd Street Project Staff

Gus Rogerson, Artistic Director  
Megan Cramer, Associate Artistic Director  
George Babiak, Production Manager  
Ray Harold, Technical Director

Carol Ochs, Executive Director  
Lisa Kerner, General Mgmt. Associate  
John Sheehy, Dir. of Development & Marketing  
Josh Moody, Development Associate

Liz Bell, Director of Education  
Steven Hajar, Education Assistant

### Consultants:

Iris A. Brown, Graphic Designer; Chris Ceraso, Teen Dean

### Interns:

Ai Vuong, Maya Zinkow

### Teen Employees:

Receptionists: Joyce Cheung, Gabriella deJesus, Jason Gil, Daquan Nelson  
Ushers: Michael Bannister, Elena Caballero, Maximo Jimenez, Jazmine Mikell, Edison Sibri

## “Stand By Me” Production Staff

Composer/Music Director  
Kim D. Sherman  
Set Designer  
Kevin Joseph Roach  
Lighting Designer  
Greg MacPherson  
Costume Designer  
Sarah Swafford  
Associate Costume Designer  
Jennifer Kirschman  
Sound Designer  
Betsy Rhodes  
Stage Manager  
Annie Lowrie  
Projection Design  
George Babiak, Ursula Babiak,  
Julie Sharbutt, and the  
52nd Street Projection Archive  
Prop Design Team  
George Babiak, Megan Cramer,  
Lisa Kerner, Julie Sharbutt, Ai Vuong

Backstage Crew  
Bryan Lopez, Nick Mills, Tiniah Powell,  
Ai Vuong, Maya Zinkow  
House Managers  
Liz Bell, Lisa Kerner, Karin Schall  
Flyer Art  
Michael Hoefler  
Chefs  
John Sheehy, Liz Bell, Carol Ochs  
Playmaking Class Volunteers  
Rachel Cora, Ariel Estrada,  
Michael Feld, Angela Lewis,  
Lupita Nyong'o, Stephen O'Reilly,  
Kathleen Wise, Chad Hoepfner  
Playmaking Class Teen Assistant  
Mari Ulloa  
Production Photographer  
Winston Rodney



This program is supported, in part, by public funds from The New York City Department of Cultural Affairs in partnership with the City Council. The Two-on-Two's are also made possible with public funds from The New York State Council on the Arts, a state agency. The Project is a member of ART/NY.

## COOL STUFF ON SALE IN THE LOBBY!

Fabulous Flyer Bars .....\$2.00 & \$3.00

and featuring Shel Silverstein's  
"Fivey and Twoey" logo:

Project T-shirts ..... \$12.00  
Project Hoodies ..... \$30.00  
Project Caps ..... \$20.00  
Project Mugs ..... \$5.00  
Project Pencil 3-pack ..... \$1.00  
Project Notebook ..... \$5.00

Thank you for coming to **STAND BY ME!** If you are not on our mailing list (or if your address has changed), please fill out this form and give it to us on your way out or mail it to the address below. We would also like to know if you are interested in becoming a volunteer. We need help in all areas, so be sure to fill out the entire form.

PLEASE ADD ME TO YOUR MAILING LIST:

4/13

NAME \_\_\_\_\_

ADDRESS \_\_\_\_\_

CITY \_\_\_\_\_

STATE \_\_\_\_\_

ZIP \_\_\_\_\_

HOME PHONE \_\_\_\_\_

DAYTIME OR MOBILE PHONE \_\_\_\_\_

E-MAIL ADDRESS \_\_\_\_\_

MY OCCUPATION \_\_\_\_\_

MY HOBBIES \_\_\_\_\_

YES, I WOULD LIKE TO BE OF HELP. I CAN:

- |   |  |
|---|--|
| <input type="checkbox"/> Draw and/or paint            | <input type="checkbox"/> Help kids with homework |
| <input type="checkbox"/> Hang lights                  | <input type="checkbox"/> Help with mailings      |
| <input type="checkbox"/> Work on a backstage crew     | <input type="checkbox"/> Do office work          |
| <input type="checkbox"/> Do graphic design            | <input type="checkbox"/> Design sound            |
| <input type="checkbox"/> Other (please specify) _____ | <input type="checkbox"/> Teach kids a skill      |
|   | <input type="checkbox"/> Be a chef at an event   |
|   | <input type="checkbox"/> Design and sew costumes |

MY SCHEDULE IS:

- Very flexible. I'm often available during weekdays.  
 Somewhat flexible. I can help on the occasional morning or afternoon during the week.  
 Not very flexible at all, but I've got some free time on evenings and weekends.

If you would like to mail this (and you're always welcome to enclose a tax-deductible contribution), you can send it to: The 52nd Street Project, 789 10th Ave., New York, NY 10019. Or fax it to (212) 333-5598.

## COMING UP ON THE PROJECT SCHEDULE...



LEWIS BLACK & KATHLEEN MADIGAN SERIOUSLY INVITE YOU TO  
THE PROJECT'S ANNUAL BENEFIT  
MONDAY, MAY 13, 2013

# JUST KIDDING!

A STAND-UP  
SIT-DOWN DINNER

COMEDY WRITTEN BY KIDS &  
PERFORMED BY ADULT COMEDIANS

CONTACT JOHN "THE JESTER" SHEEHY FOR MORE INFORMATION ABOUT  
"JUST KIDDING" AT (212) 333-5252 OR SHEEHY@52PROJECT.ORG



DON'T MISS OUR TEEN ENSEMBLE'S  
SHAKESPEARE PRODUCTION!

## TWELFTH NIGHT

THE FIRST LEG OF THE 2013  
NORTH AMERICAN TOUR

Five Angels Theater  
Friday, June 21 at 7:30 p.m.  
Saturday, June 22 at 3:00 p.m.

## The 52nd Street Project Board of Directors

Lisa Benavides	Carol Ochs
Rachel Chanoff	Willie Reale, founder
Cathy Dantchik	Gus Rogerson
Carolyn DeSena	Shirley Rumierk, alumni member
Wendy Ettinger, chair emeritus	José Soto, Jr., alumni member
Louis P. Friedman	Jenny Steingart
Robert Goldberg	Lisa Tilney
Stephen Graham, chair	Merritt Tilney
Valerie Kay	Wendy vanden Heuvel
Frances McDormand	John A. Vassilaros
Noël Mihalow	

## What's Going On Here?

The 52nd Street Project is a non-profit organization that brings children from the Hell's Kitchen neighborhood together with professional theater artists to create original theater. *STAND BY ME* is a production of our Playmaking program. Young people participate in a nine-week playwriting course taught by Megan Cramer and adapted for the Project by Daniel Judah Sklar from his book *Playmaking: Children Writing and Performing Their Own Plays*. At the end of the course, each child is matched with two actors and a dramaturg/director who guides him or her through the writing of a play during a weekend retreat in the country (Bridgehampton, NY, for this show). This performance is the end result.

## In-Kind Contributions

Abbeville Press; Stephanie Berger Photography; Lewis Black; Richard Blackstone; Iris A. Brown Design; William Curran & A Curran Affair; Kate Cusack; FK Partners; ICI; The S.F. Giants; Newman's Own; Pharma Print; PineRock; The N; Wendy Stuhlberg; The Yankees; John A. Vassilaros; Watkins, Inc.; Boylan's Bottling Co.; Hudson Scenic; and Paul, Weiss, Rifkind, Wharton & Garrison LLP.

## Special Thanks

We're extremely grateful to John Vassilaros & Alex Gersten-Vassilaros for the use of their beautiful home in Bridgehampton, NY as our base of operations for the writer's retreat. We're also grateful to Laurie Becker, who housed the girls in nearby Sag Harbor.



## stand by me: the reliable plays - act 1

All original music composed by Kim D. Sherman.

### LIARS IN FAMILY

Written by Sasha Davis, age 10

Dramaturge/Director: Tasha Gordon-Solmon

Mom..... Rachel Mewbron  
Cheetah..... Jeanna Phillips  
Tiger..... Rachel Cora

*Wish to be Your Favorite* lyrics by Sasha Davis

### ULTIMATE ENEMIES

Written by Kai Ceniza, age 10

Dramaturge/Director: Paul L. Coffey

Red/Ed..... Michael Crane  
ZigZag..... Stephen O'Reilly  
Rookie..... Bryan Lopez  
Co-Director..... Nick Mills

*Revenge* lyrics by Kai Ceniza

### MY SINGING CAREER

Written by Christin-Delaine Gavriella Tetteh, age 11

Dramaturge/Director: Awoye Timpo

Jasmine..... Julia Lawler  
Diamond..... Liza Colon-Zayas

*Living in NYC, In My Way, and Frenemies* lyrics by Christin-Delaine Gavriella Tetteh

### THE DEATH OF A MILLION

Written by Matthew Orozco, age 12

Dramaturge/Director: Rachel Dart

Sumangi..... Sekou Laidlow  
Little Annabelle..... Annie Purcell

*Do You Think I'm the Only One Without You* lyrics by Matthew Orozco

### THE ROBBERY CASE

Written by Mussa Ahmed, age 10

Dramaturge/Director: Andy Donald

John..... Peter Dinklage  
Pussycat..... Reed Birney  
Clara..... Rachel Cora  
Customers..... The Crew

*I Didn't Get What I Want* lyrics by Mussa Ahmed

## stand by me: the reliable plays - act 2

### JEALOUS SINGER

Written by Jayda Camacho, age 11

Dramaturge/Director: George Babiak

Jessie..... Jackie Chung  
James..... Korey Jackson

*Evil Plan, Jealousy, and How to be a Good Singer* lyrics by Jayda Camacho

### REVENGE OF THE STOLEN

Written by David Ortiz, age 11

Dramaturge/Director: Kerry Whigham

Kate..... Sue Jean Kim  
Hobo Mike..... Scott Parkinson

*I'm Gonna Kill Him* lyrics by David Ortiz

### THE ZOMBIE CHEERLEADER AND THE HUMAN NERD

Written by Stephanie Macias, age 11

Dramaturge/Director: Charise Castro Smith

Rachel..... Molly Carden  
Nicole..... Angela Lewis  
Cheerleaders..... Ai Vuong and Maya Zinkow  
Another Human..... Maya Zinkow

*The Stress Song* lyrics by Stephanie Macias

### THAT ONE WISH

Written by Damian Tineo, age 10

Dramaturge/Director: Chad Hoepfner

Big Bob..... Billy Crudup  
Joe..... Isaiah Johnson  
Challenger..... Ugly Patrick  
Customers..... The Crew  
Civilians..... The Crew

*The Selling Song and I Song* lyrics by Damian Tineo

### RIVER MADNESS

Written by Chyanne Peña, age 11

Dramaturge/Director: Nicole A. Watson

Joanne Marie..... Adrienne C. Moore  
James..... Bhavesh Patel

*Annoying, Be-Trayed, and Fishing Friends* lyrics by Chyanne Peña

The 52nd Street Project is a non-profit arts organization that brings children from the Hell's Kitchen neighborhood together with professional theater artists to create original theater. The Dancemaking program gives children a chance to express themselves creatively through movement. Over the nine weeks of Dancemaking class, led by Megan Cramer, these young choreographers and performers developed their own movement vocabulary, explored shapes, pathways, actions, and choreographic elements to create their own 3-minute duets. The resulting dances are featured in tonight's performance.

### The 52nd Street Project Staff

Gus Rogerson, Artistic Director  
Megan Cramer, Associate Artistic Director  
George Babiak, Production Manager  
Ray Harold, Technical Director  
Carol Ochs, Executive Director  
Lisa Kerner, General Mgmt. Associate  
John Sheehy, Dir. of Development & Marketing  
Josh Moody, Development Associate  
Liz Bell, Director of Education  
Steven Hajar, Education Assistant

**Consultants:** Iris A. Brown, Graphic Designer; Chris Ceraso, Teen Dean

**Interns:** Ai Vuong, Maya Zinkow

**Sound and Light Board Operator:** Ai Vuong

**Costume Coordinator:** Jennifer Jimenez

#### Teen Employees:

Receptionists: Joyce Cheung, Gabriella deJesus, Jason Gil, Daquan Nelson  
Ushers: Maximo Jimenez, Tino Paduani, Alizette Zapata

### The 52nd Street Project Board of Directors

Lisa Benavides	Carol Ochs
Rachel Chanoff	Willie Reale, founder
Cathy Dantchik	Gus Rogerson
Carolyn DeSena	Shirley Rumierk, alumni member
Wendy Ettinger, chair emeritus	José Soto, Jr., alumni member
Louis P. Friedman	Jenny Steingart
Robert Goldberg	Lisa Tilney
Stephen Graham, chair	Merritt Tilney
Valerie Kay	Wendy vanden Heuvel
Frances McDormand	John A. Vassilaros
Noël Mihalow	



The Dancemaking Program is made possible with public funds from The New York State Council on the Arts, a state agency; and the New York City Department of Cultural Affairs. The Project is a member of ART/NY.

The 52nd Street Project Presents



The  
52nd  
Street  
Project's  
Annual  
Dance  
Concert



Featuring 7 short original dances choreographed by kids and performed by kids and adults.

Dancemaking Director: Megan Cramer

Monday, April 22 & Tuesday, April 23, 2013 – 7:00 p.m.

The Five Angels Theater  
The 52nd Street Project  
789 10th Avenue



## Prelude

Choreographed by: Megan Cramer & The Dancemaking Company  
Performed by: The Dancemaking Company  
Music: Dan Romer & Benh Zeitlin, "Once There Was a Hushpuppy"

## Nerdtopia

Choreographed by: Joseph Cruz  
Performed by: Joseph Cruz & Justin Cimino  
Music: Aaron Copland, "The City - Sunday Traffic"

*"I always wanted a theme on geeks, so I put everything a nerd does into one dance. This includes video games, being weak, the walks, goofyness, and loving soda. My nerd name is Gilbert. My partner's nerd name is Ernest, but we call him Ernie. My nickname is Gil." —Joseph Cruz*

## The Blow Out

Choreographed by: Allyssia Feliciano  
Performed by: Allyssia Feliciano & Alessandra Larson  
Music: George Winston, "Cloudburst"

*"This dance is about water and how it can relate to times when you feel sad. Also to my sister Siara, 'Happy B-Day!'" —Allyssia Feliciano*

## The Cowboy and the Coward Cow

Choreographed by: Alex Bonnet  
Performed by: Alex Bonnet & A.Z. Kelsey  
Music: Johann Hummel: "Trumpet Concerto In E Flat, Rondo"

*"My dance is about a cowboy and a cow. I made up this dance from when I was thinking about One-on-One's." —Alex Bonnet*

## Friendship All Around the World

Choreographed by: Jasmine Correa  
Performed by: Jasmine Correa & Ashley Marie Ortiz  
Music: Bela Fleck & Nakisenyi Women's Group, "Tulinesangala"

*"My dance is about friendship and I wanted the characters to be connected. The Story: Two people meet each other and at first are in competition, then they learn stuff from each other, and at the end become friends." —Jasmine Correa*

## The Nightmare

Choreographed by: Tyleek Powell  
Performed by: Tyleek Powell & Ruy Iskandar  
Music: Peter Gabriel, "Disturbed"

*"I love history about war, like the Holocaust and WWII." —Tyleek Powell*

## Jungle

Choreographed by: Makice Pacheco  
Performed by: Makice Pacheco  
Music: Aaron Copland, "Appalachian Spring - 2. Fast"

*"What inspired me to dance was the movie 'The Lion King' for an animal type theme. Also horror movies and soft flowing stuff, like we are in a Jungle-like theme. It was fun." —Makice Pacheco*

## MDG Concertantes

Choreographed by Malik Velazquez & Daquan Nelson  
Performed in 3 Parts by:  
Daquan Nelson, Malik Velazquez, & Gus Rogerson.  
Music: Igor Stravinsky, "Danses Concertantes: Marche Introduction, Pas d'Action, Marche - Conclusion"

*"At first I didn't want to do this program. Not because I was scared to perform but because I don't dance. I guess I do now, though due to a bit of positive peer pressure. Some parts of this dance derive from a martial art called Parkour. It's one of my hobbies and I had to include it in our performance. I hope you like it." —Malik Velazquez*

*"Our dance consists of some different styles of dance that reflect our personality. And it's not so much of a strict forward routine but still has that sense of organization and dance feel to it." —Daquan Nelson*

## Postlude

Choreographed by: Megan Cramer & The Dancemaking Company  
Performed by: The Dancemaking Company  
Music: Dan Romer & Benh Zeitlin, "Once There Was a Hushpuppy"

**Special Thanks: Liliana Amador, Kimiye Corwin, Kevin Dwyer, Annie Purcell**

**Extra-special thanks to the seven adult partners who appear in this performance for their enormous help in Dancemaking.**

### The 52nd Street Project Board of Directors

Lisa Benavides	Noël Mihalow
Rachel Chanoff	Carol Ochs
Cathy Dantchik	Willie Reale, founder
Carolyn DeSena	Gus Rogerson
Wendy Ettinger, chair emeritus	Shirley Rumierk, alumni member
Louis P. Friedman	José Soto, Jr., alumni member
Robert Goldberg	Jenny Steingart
Stephen Graham, chair	Lisa Tilney
Valerie Kay	Merritt Tilney
Frances McDormand	Wendy vanden Heuvel
	John A. Vassilaros

### The 52nd Street Project Staff

Carol Ochs, Executive Director  
Gus Rogerson, Artistic Director  
Megan Cramer, Associate Artistic Director  
Liz Bell, Director of Education  
John Sheehy, Director of Development & Marketing  
Josh Moody, Development Associate  
George Babiak, Production Manager  
Ray Harold, Technical Director  
Lisa Kerner, General Management Associate  
Steven Hajar, Education Assistant

### Benefit Volunteers

Robert Askins, Dylan Dawson, Nic Grelli, Ginny Lee,  
Larry Nathanson, Nancy Noto, Julie Sharbutt,  
Kim D. Sherman, Vanessa Valdes, and Johanna Vidal

### Technical Volunteers

Jess Bauer, Kaleigh Boshart, and Nate McKinney

### Special Thanks

Becky Browder, Terry Fitzpatrick

STEPHANIE BERGER



# \* Just Kidding \*

The 52nd Street Project's Stand-Up Sit-Down Dinner  
Monday, May 13, 2013



## **“Just Kidding” Benefit Co-Chairs**

Lisa Benavides	Karin Schall
Cathy Dantchik	Jenny Steingart
Carolyn DeSena	Merritt Tilney
Louis P. Friedman	Laura Valeroso
Patrice Friedman	Mary Pat Walsh

## **The 52nd Street Project gratefully acknowledges...**

Abbeville Press  
abc kitchen  
Stephanie Berger  
Lewis Black  
Iris A. Brown Design  
Michael Dorf and City Winery  
Joel Coen  
Commonwealth Proper and J. Andrew Stein  
William Curran, A Curran Affair  
Emmett Global  
Paul K. Ziff, Ferragamo Timepieces  
Patrice & Louis Friedman  
JetBlue  
Kathleen Madigan  
Neil Mazzella & Hudson Scenic  
Lauren Friedman, Pharma/Omni Printing  
Sesame Workshop  
Showtime and Liz Flahive  
Wendy Stuhlberg  
Tao Group  
Merritt Tilney & Doug Kaden  
Uber  
John A. Vassilaros & Sons  
Mark Jacobs & Watkins Incorporated  
Healthier Living Since 1868  
Wynn Resorts

## **Giggle Seats**

Beth & Ray Abbott	Anna Li & Frank Sposato
Becky Ann & Dylan Baker	Adrienne Lobel
Eliza Baldi & David Costabile	Jo Anne & Mark Lonow
Tosh & Tom Barron	Lori & Bill Lopez
Beth & Eric Berman	Julie Margolies
Stephen Bernstein	Rebecca Miller
Richard Blackstone	Emily & John Morgan
Becky Browder & Ted Neustadt	Carol Ochs & Bruce MacVittie
Iris A. Brown & Joe White	Jacki Ochs & Jan Kroeze
Denise Burse	Katherine & Craig Phares
& Peter Jay Fernandez	Sue Phillips
Frederick E. A. Bush	Gina & James Pickens
Leah Carr	Judy & Michael Pillinger
Chris Ceraso	Todd Poisson
Rachel Chanoff	Randi Puccio
Ellen Chopay	Christopher Randolph
Katie Clark	Anita Andres Rogerson
Lisa Cohen & David Hillman	David Rosenberg
Bill Connington	Lynne Rosenberg
Liza Demby	Ellen Rudolph
Marilyn Diamond	Carla Sacks & John Morris
Marion Dienstag	Laura Sametz & Anton Fig
Michael Dorf	Whitney Scott & Peter Jacobson
Richard Dresser	Sylvia Shepard & Willy Holtzman
Liz Flahive & Jeff Cox	Meg Simon
Alexandra Garrison	Lois Smith
Alison Fraser Magee	Susanna Styron
Jenny Gersten & Willie Reale	Richard Sweren
Shari Goodstein & Craig Lambert	Edith Thurber & Kevin O'Rourke
Amanda Green & Jeff Kaplan	Karen Trott & Peter Herdrich
Jan Gura & Alan Pickman	Liz Tuccillo
Margo Halle & Richard Manichello	Susan J. Vitucci
Susan Hanson	Susan Wallace
Kathy & Jamie Herring	Dana Watkins
Christa Justus & Mark Linn-Baker	Brenda Wehle & John Carroll Lynch
Kim Katz	Steve Wertimer
Pat Kirby	Mark Whatley
Louise Klebanoff	Margot White
Mary Kong	Rachel & Terence Winter
Alan Krevis & Gary Horowitz	Sidney Worthen
Judy Kuhn & David Schwab	Carole Yass
Frances Langbecker	Janet Zarish & Mark Blum

Donor lists current as of May 8, 2013

## **Hoot Seats**

Anonymous  
Gavin Berger & Craig Berggren  
Allison Blinken  
Buzz Bovshow  
Blaise R. Box, Staging & Design  
Jody & J Durst  
Sally Froelich  
Michael Gross  
Sarah Horowitz & David Venarde  
Lisa & David Issroff  
Andrea Johnson  
Cynthia Kaplan  
Anita Keal & Morton Wolkowitz  
Celia Keenan-Bolger & John Ellison Conlee  
Henry Krieger & Robert Joy  
Howard Laks  
Jonathan Levine  
Josephine Merck & Jim Stevenson  
Amanda & Neal Moszkowski  
Lori O'Connor  
Steve Olsen  
Suzanne Poulin  
Helen & Peter Randolph  
Laura & David Ross  
David Saint  
Karin & Thomas Schall  
Jeremy Smith  
David Swope  
Lisa Tilney  
Laura Valeroso  
Cynthia Vance & Robert Abrams  
Mary Pat Walsh

Carol Ochs,  
Executive Director

Stephen Graham,  
Board Chair

Gus Rogerson,  
Artistic Director

# Just Kidding

**The 52nd Street Project's Stand-Up Sit-Down Dinner  
Monday, May 13, 2013 at Tribeca Rooftop**

## **Your Hosts**

Lewis Black and Kathleen Madigan

## **The Writers**

Michael Bannister, Enrique Caballero, Ricardo Currin,  
Maria Martinez, Kayla Matos

## **The Performers**

Lewis Black, John Bowman, Nancy Giles, Vic Henley,  
Cynthia Kaplan, Kathleen Madigan

## **Director**

Jonathan Bernstein

## **Lighting Designer**

Greg MacPherson

## **Sound Designer**

Scott Lehrer

## **Set and Prop Designer**

George Babiak

## **Stage Manager**

Anne Lowrie

## I'm Awesome

Written by Enrique Caballero, age 13  
Performed by Vic Henley



ALL PROJECT KID PHOTOS BY STEPHANIE BERGER

**Enrique Caballero** first achieved Project notoriety in 2010 with his play *The Revenge of the Psycho Platypus*, a super-hero and villain adventure that featured a full-size hovercraft. As an actor, he has appeared in *Sperlock and Whitsun*, by Robert Askins, and most recently in his own Kung Fu extravaganza, *Face Punch*. Enrique likes baseball, basketball, and Elmo and is, indeed, awesome. He is the only kid at the Project who has his own film production company. It's called Awesome Guy Studios and it is now in the process of shooting Enrique's sixth short film.

**Vic Henley** has achieved zero Project notoriety but hopes this show catapults him to heights he's never before considered. As an actor he's appeared in *Nobody's Dummy: The Horace and Huey Story* by Ted Alexandro and *Bruno* by Sasha Baron Cohen. Vic likes all types of sports, music, books and Oscar the Grouch. Although not awesome, he really thinks he's pretty amazing, so a chance to work with Enrique can only result in amazing awesomeness. He has a comedy special from 2005 that people can download on iTunes for 99 cents. And he is in the process of writing some super hilarious new material that everyone will love.

## Guffaw Tables

The Dantchik Family  
Cathy & Stephen Graham

## Roar Tables

Patrice & Louis Friedman  
Merritt Tilney & Douglas Kaden

## Chuckle Tables

Lisa Benavides Nelson & Tim Blake Nelson  
CBS Corporation

Drew Cohen, Music Theater International  
Dawkins Family Foundation

Carolyn & Neil DeSena

Wendy Ettinger

Bev Gasner

Myrna & Freddie Gershon

Alexandra Gersten-Vassilaros & John Vassilaros  
Robert Goldberg, Yorke Construction Corporation

Kimberly Grigsby

Mrs. Saul Horowitz, Jr.

Valerie Kay & Bruce Graham

Grace Lyu-Volckhausen

Frances McDormand & Joel Coen

Bette Midler

Rona & Randolph Nelson

Steve Sabba, Tax Pro Financial Network, Inc.

Jenny & Jon Steingart

Wendy vanden Heuvel & Brad Coley

Drs. Mildred L. Walton & Borah W. Walton, Jr.

## Movies and Dancing

Written by Michael Bannister, age 16  
Performed by Lewis Black



**Michael Bannister** is super-old, he says, having made his Project debut with his play *Seafoam Beach* in 2008. At the Project, he was a tree-house-living hobo in *The Leap*, a sweet old granny in *Sweet Old Granny*, and a master magician in *Old School*. Michael likes sports, and even though he loves acting, he still wants to be a doctor in his college years. He says, "The 52nd Street Project is a great place and you know where your kid is and that he's doing his homework."

**Lewis Black** is super-duper-old. He made his Project debut in 1947, just after the war. He can't remember the first show he did but he remembers doing something and it seemed like a show. He wrote a musical with Willie and Rob Reale which was performed by Project kids in Provence, France and he considers it the most success he has known as a playwright. He is thrilled to be back at the Project and actually working with Michael Bannister, who will be the world's funniest doctor.

## Chicken Wings, Telepathia, Song Parodies

Written by Kayla Matos, age 11  
Performed by Nancy Giles  
with Cynthia Kaplan on guitar



**Kayla Matos**, the youngest of our writers, is the author of *My Dreams*, a play that premiered in December, 2012 at the Five Angels Theater. In it, two lost souls struggle to find success in the world of music. Kayla likes sports, especially softball, basketball, and gymnastics. She has one sister and she is really short, the second shortest in the whole 6th Grade. Kayla is still waiting to make her acting debut with the Project, but when she gets older, she wants to go to an acting school.

**Nancy Giles** made her writing debut with *What Is the Letter S?*, which she wrote at P.S. 30 in Queens. She made her acting debut as a singing bag of garbage with the Paper Bag Players. Sometimes you can see her on TV talking about stuff and occasionally you can hear her voice in commercials for drugs, disinfectants, and the Food Network. Nancy has often been cast as a tall person in Project plays.

**Cynthia Kaplan** has written a couple of funny books, a pretty funny movie, some funny-ish plays for the Project, and a lot of totally inappropriate songs. She performs her own stuff and other people's. Even though she just met Kayla this year, she feels none of that would ever have happened without her, in a *Twilight Zone* episode sort of way. Cynthia also wrote the song *Tuesday Afternoon* by The Moody Blues. Cynthia has never appeared on *Law & Order*.



## My Perfect School

Written by Ricardo Currin, age 11  
Performed by John Bowman



**Ricardo Currin** has been a member of the Project since 2012, when his insect epic *The Solution Between Bees and Flies* was produced. He made his acting debut in August of 2013 in *Bam!*, in which he played a French Canadian hockey player. He goes to P.S. 191 on West End Avenue and likes to read a lot. His favorite author is R.L.Stine. Ricardo loves comedy, playing football, and eating pizza.

**John Bowman** started his career by performing mangled fairy tales with crudely made sock puppets in a small farm town in Michigan. Some other things happened after that; television, theater, comedy... Mostly, he's gotten by on his good looks. His one man show, *Work Is For Suckers*, remains unwritten. He listens to the stories that Ricardo, his comedy writer, tells him and wonders how he knows so much for a kid. Might have something to do with growing up in New York City. Ricardo has never milked a cow, shot a bow and arrow or climbed a tree to look into an eagle's nest. Neither has John Bowman. Thank you.

## Kids Should Have a Say, Creepy Doll, The Luigi Board, The "C" Word, Managing Money, Waking Up for School

Written by Maria Martinez, age 12  
Performed by Kathleen Madigan



**Maria Martinez** was introduced to Project fans in December of 2011 with her original simian family drama, *The Monkey Adventure*. The following year she played Aunt Annabelle, a heroic bug in *When You Were Little*. Maria does NOT like homework. She loves animals, but not rats, mice, or cockroaches. She plays softball and enjoys fruit because it's healthy for you. Maria likes people. Wine looks nasty, lying is horrible. Never lie! And have a nice day (applause)!

**Kathleen Madigan** found out about The 52nd Street Project through her friend Lewis Black. She's been a stand-up comedian for 25 years and keeps all her notes on bar napkins in her purse. Kathleen likes animals too. Especially the Lunesta neon butterfly that she believes is actually real. She likes wine, her pajamas, the History Channel and conspiracy theories. She, like Maria, does NOT like homework. Even writing this bio was a pain in her ass. She DOES like helping people because she knows someday she will need a lot of help. Lately, she's been practicing to write with both hands in case she has a stroke.

The 52nd Street Project proudly presents  
**THE STAGE COMBAT PROGRAM'S FINAL PERFORMANCE**

Friday, June 14<sup>th</sup> at 6:00 p.m.

*This program was led by Broadway fight choreographer Tom Schall  
with Education Director Liz Bell*

**THE END**

Written by Edelys Guerrero, age 12

Directed by Flor De Liz Perez

Alyssa.....Edelys Guerrero  
Ally .....Flor De Liz Perez  
Teacher..... George Babiak

**THE X-BOX INCIDENT**

Written by Richard Brea, age 13

Directed by Raul Castillo

Drew .....Richard Brea  
Tom.....Raul Castillo

**THICK AIR**

Written by Malik Velazquez, age 17

Directed by Angel Desai

Rebel Leader.....Malik Velazquez  
Mercenary .....Angel Desai  
Voice of soldier .....Alex Tissiere

**THE RUNAWAYS**

Written by Tiniah Powell, age 12

Directed by Nic Grelli

Runaway.....Tiniah Powell  
Tom.....Nic Grelli

**THE BASEBALL FANATICS**

Written by Chayse Peña, age 13

Directed by Justin Blanchard

Bren.....Chayse Peña  
David..... Justin Blanchard  
Coach..... George Babiak



Gus Rogerson, Artistic Director     Carol Ochs, Executive Director  
 The 52nd Street Project Presents

The 52nd Street Project (The Project) is dedicated to the creation and production of new plays for and by kids between the ages of ten and eighteen who reside in the Hell's Kitchen neighborhood in New York City. The Project does this through unique mentoring programs that match kids with professional (and volunteer!) theater artists.

The Project is about making children proud of themselves. The Project is not about teaching children to act, although they will learn to. It is not about teaching them to write plays, although they will learn that as well. What it is about is giving a kid an experience of success. It is about giving a kid an opportunity to prove that he or she has something of value to offer, something that comes from within that he or she alone possesses, something that cannot be taken away.

The Project's Teen Ensemble is the final step in the kids' training: a two-year acting class that culminates in the production of a full-length play by William Shakespeare, the very one you are seeing tonight. This year's show is being done in New York, Calgary, and Banff. We are very grateful to all our American and Canadian friends for enabling this tour.

The following foundations and government agencies have generously supported the Teen Program through their contributions:

- City of New York Department of Cultural Affairs
- Horace W. Goldsmith Foundation
- New York State Council on the Arts
- The Surdna Foundation

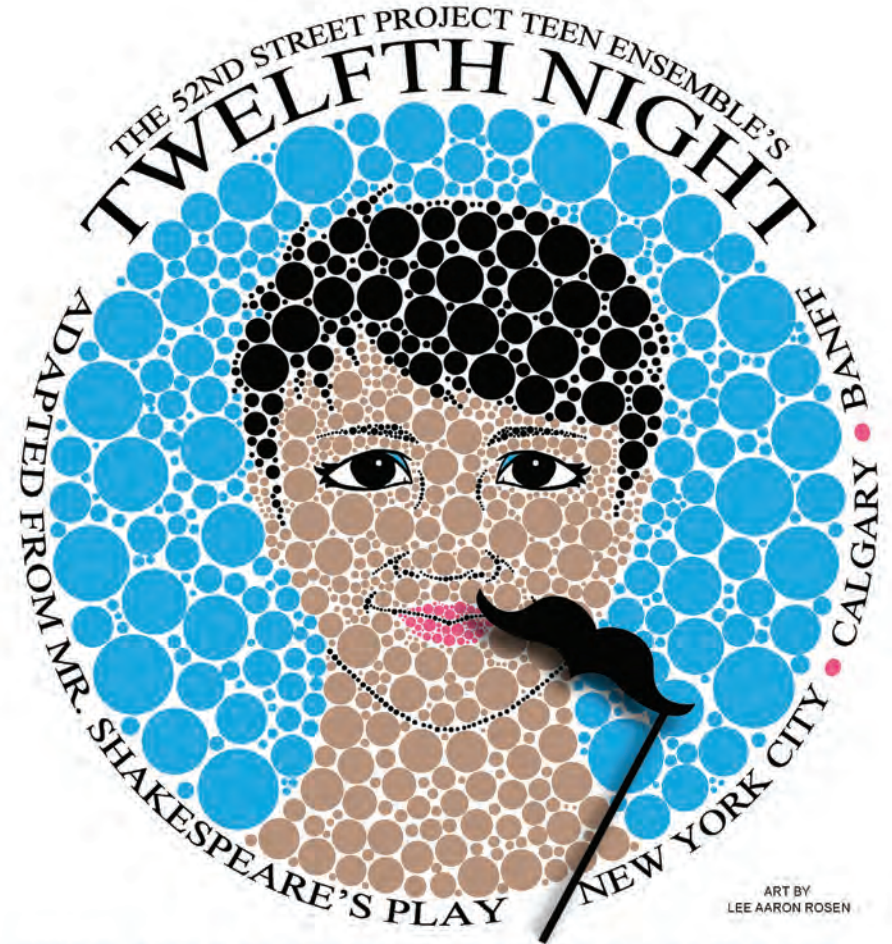

## THE 2013 NORTH AMERICAN TOUR

- Five Angels Theater • New York City, June 21 & 22
- The F. R. Matthews Theater • The University of Calgary, June 29
- The Margaret Greenham Theater • The Banff Centre, July 3

**Produced and Directed by Megan Cramer**  
**Adapted by Chris Ceraso**  
**with The 52nd Street Project Teen Ensemble**

## **The Cast**

**(in order of appearance)**

Orsino .....Alvin Garcia  
 Valentina .....Melissa Rebolledo  
 Viola .....Doris Alcantara  
 Captain ..... Chris Ceraso  
 Lady Tabby Belch ..... Ashley Smith  
 Maria ..... Samantha Caldon  
 Andrew Aguecheek ..... Tino Paduani  
 Feste ..... Lily Capstick  
 Olivia ..... Johanna Vidal  
 Malvolio ..... Armando Cosme  
 Antonia ..... Kiya Jacob  
 Sebastian ..... Jason Gil  
 Fabiana ..... Melissa Rebolledo  
 Priest ..... Chris Ceraso  
 Officer ..... Chris Ceraso

## **Production Staff**

Composer/Music Director .....Eric A. March  
 Lighting Designer ..... Burke Brown  
 Costume Designer .....Lara de Bruijn  
 Sound Designer ..... Vanessa Valdes  
 Stage Manager/Board Operator (NYC) ..... Winnie Lok  
 Tour Manager ..... George Babiak  
 Flyer/Program Art design ..... Lee Aaron Rosen  
 Prop/Set Design .....Ray Harold, Jennifer Jimenez  
 Shipwreck Choreography ..... Liliana Amador

**Shakespeare Coaches:** Justin Blanchard, Dave Dalton, Maxon Davis, Ian Hersey, Maggie Lacey, Jordan Mahome, Jeremy Rische, Lynne Rosenberg, John Sheehy, Brielle Silvestri, Robert Stanton, Nicole A. Watson

**Thanks to our Calgary friends and hosts:** Clem Martini, Kathleen Foreman, Elena Sinitsyna, Michelle Chia, The University of Calgary, Stephen Hunt, Judy Bissell, Deanne Layher, Dan Perry, and Alan and Faylene Valdes.

**Thanks to our Banff friends and hosts:** Kelly Robinson, David Cseke, Robert Rombough, Heloise Veillette, Casey Prescott, The Banff Centre, Connie Brill, and Joni Cooper.

And special thanks to Kimberly Zenteno

## **The 52nd Street Project Staff**

Carol Ochs, Executive Director  
 Gus Rogerson, Artistic Director  
 Megan Cramer, Associate Artistic Director  
 Liz Bell, Director of Education  
 John Sheehy, Director of Development & Marketing  
 George Babiak, Production Manager  
 Ray Harold, Technical Director\*  
 Alyssa Anderson, Manager of Individual Giving  
 Lisa Kerner, Development and Management Associate  
 Johanna Vidal, Community Coordinator\*  
 Steven Hajar, Education Assistant

### **Consultants**

Iris A. Brown, Graphic Designer;  
 Chris Ceraso, Teen Dean

### **Interns**

Isobel McBride, Dan Perry, Jillian Puhalla, Alex Tissiere

### **Teen Receptionists**

Joyce Cheung, Gabriella deJesus, Jason Gil, Daquan Nelson

### **Teen Ushers**

Michael Bannister and Mari Ulloa

## **The 52nd Street Project Board of Directors**

Lisa Benavides	Noël Mihalow
Rachel Chanoff	Carol Ochs
Cathy Dantchik	Willie Reale, founder
Carolyn DeSena	Gus Rogerson
Wendy Ettinger, chair emeritus	Shirley Rumierk, alumni member*
Louis P. Friedman	José Soto, Jr., alumni member*
Robert Goldberg	Jenny Steingart
Stephen Graham, chair	Lisa Tilney
Valerie Kay	Merritt Tilney
Frances McDormand	Wendy vanden Heuvel
	John A. Vassilaros

*\*Alumnus of The 52nd Street Project Teen Ensemble*

## TWELFTH NIGHT - THE SYNOPSIS - ACT 1

Shipwrecked off the coast of Illyria, a young woman, **Viola**, fears that her twin brother, **Sebastian**, has drowned. Lost and alone in a strange land, she decides to hide her identity until she can regain her fortune. She disguises herself as a young man named **Cesario**, and is hired as a servant by the wealthy **Duke Orsino**.

Viola/Cesario quickly becomes a favorite of the lovesick Duke, who decides that the “young man” would make the perfect messenger of his passion to the neighboring Countess **Olivia**. But the Countess wants nothing to do with the Duke’s advances, as she is in mourning for her own dead brother. To make matters worse for poor Viola, she herself has fallen hard for the Duke but can’t reveal her feelings without ruining her disguise.

Tensions are high at Olivia’s court after so much mourning: the Countess’ fool, **Feste**, has been absent a lot, preferring to hang out at the Duke’s palace; Cousin **Tabby Belch** is partying day and night with a rich dupe, **Sir Andrew Aguecheek**, whom Tabby is stringing along with promises of the Countess’ love; the haughty steward, **Malvolio**, thinks he’s too good for anything but the Countess’ hand and a noble title, and Olivia’s serving woman, **Maria**, has her hands full trying to keep everyone decent.

Things take a twist when Countess Olivia has her eyes and heart stolen by the Duke’s cute messenger, Cesario (Viola, of course). Olivia uses Malvolio to trick Viola/Cesario into coming back: she pretends to return a ring that Viola never gave her. Olivia’s obvious crush on the messenger hurts Sir Andrew’s feelings, and he decides to leave. To keep Andrew (and his money) at court, Tabby steps up the carousing and throws a late night house party that awakens Malvolio. Harsh words are spoken on all sides. Even Maria is fed up with Malvolio’s snooty attitude, and she leads Tabby, Andrew, Feste and their old friend **Fabiana** in a plot to humiliate Malvolio. She will make him believe the Countess really is in love with him.

Lo and behold, Sebastian is still alive. He was saved from drowning by a piratical sea-person named **Antonia**, who has developed feelings of love and loyalty for the fine young man. They have made their way to town, but Antonia must lay low. She is a wanted person in Illyria due to a recent sea battle in which she robbed one of the Duke’s ships. She gives the penniless Sebastian a purse full of cash so that he can enjoy the sights of the town, then goes to make accommodations for them at a local inn.

Duke Orsino won’t take Olivia’s “no” for an answer. He insists that Viola return to her despite Viola’s persuasion that broken hearts must be handled carefully. Before Viola leaves, they administer to their sad hearts by listening to old love songs. Everybody’s got it bad.

The first act comes to a close as the madcaps in Olivia’s court drive Malvolio to fall head over heels for their nasty practical joke: he now believes that Countess Olivia is in love with him and that she wants him to wear bright yellow stockings and smile whenever he is near her.

## ACT TWO

Viola/Cesario asks Feste to announce her to the Countess. Feste gives her a hard time for being a mysterious figure, but a little money goes a long way with a Fool. While waiting, Viola is met by Sir Andrew who is intimidated by the well-spoken messenger’s smooth game. He goes off jealously as Olivia arrives to see Viola. Olivia apologizes for the ring trickery, and blurts the truth: “nor wit, nor reason can my passion hide!” Viola, losing patience, beats a hasty retreat.

Tabby and Fabiana, trying harder to keep the forlorn Sir Andrew (and his money) around, egg him on to challenge Viola to a duel. As Andrew goes off to write the challenge, Maria brings Tabby and Fabiana to see the fruits of their plot against Malvolio. When the arrogant manservant appears in yellow stockings, smiling and making romantic overtures, Olivia thinks he has gone mad. Tabby, Maria and Fabiana gleefully lock Malvolio in a lunatic’s prison.

Sir Andrew returns with his fierce (not) challenge, and Tab and Fab split up to have more fun. Fabiana nabs Viola as she is leaving and tells her that Andrew is a rowdy and ready opponent. Likewise, Tabby tells Andrew that Cesario is a beast in battle. Now terrified of each other, Andrew and Viola square off to fight. Just then, Antonia shows up. Thinking that Viola is her twin brother, Antonia fights on the supposed Sebastian’s behalf, but is recognized by the authorities and arrested. Antonia asks Viola for some of the money she lent her. Viola denies knowing her. Destroyed, Antonia is taken off by the cops.

Sebastian, meanwhile, has “ranged about the town,” taking in the sights. He is now near the Countess’ palace, where he meets a still-fuming Sir Andrew. Andrew mistakes Sebastian for Cesario, and attacks. Sebastian knocks Andrew silly. Tabby is about to tangle, too, when Olivia, thinking they are attacking Cesario, chases Tabby and Andrew away. Sebastian is amazed and delighted when Olivia again pronounces her love. Olivia invites Sebastian back into the palace for some private time, and he accepts.

As Malvolio languishes in his dark prison, Feste torments him in the guise of a wacky priest, then agrees to take a letter to Olivia. But Olivia is preoccupied with her newfound happiness... and by her sudden marriage to Sebastian.

Duke Orsino shows up at the Countess’ palace. He is furious to discover that his trusted servant has not only stolen the Countess’ heart, but has secretly married her. Viola is more miserable and confused than ever. Her distress turns to joy when Sebastian appears. The pieces finally fit: the maid (Olivia) is married to a man (Sebastian), not to a maid (Viola), and the maid (Viola) is free to marry the man she loves (Orsino). Orsino is happy with the arrangement too, since he really liked Cesario (Viola) all along.

But what about Malvolio? Feste gives Olivia Malvolio’s letter. Malvolio is summoned and demands to know why he has been so mercilessly gulled. Feste offers a reason: “Thus the whirlygig of Time brings in his revenges.” Malvolio vows his own revenge. And the rain it raineth every day.

We are the wind and the rain.

The 52nd Street Project gratefully acknowledges the support of the following foundations and corporations: Bloomberg; Brenner Family Foundation; Cantor Fitzgerald; CBS Corporation; Consolidated Edison; Dawkins Family Foundation; The Neil V. DeSena Foundation; The Dramatists Guild Fund; Dramatists Play Service; The Educational Foundation Of America; Sidney E. Frank Foundation; Fund for the City of New York; Goldman Sachs; The Horace W. Goldsmith Foundation; Heisman Foundation; Hudson Scenic Studio; Lotos Foundation; Ann M. Martin Foundation; Marusi Family Foundation; Monteforte Foundation; The PAR Group; The People's Choice Awards; Quadra Productions; Sesame Workshop; The Shubert Organization; Simon & Eisenberg; Starker Family Foundation; Harold & Mimi Steinberg Charitable Trust; Surdna Foundation; Susquehanna Investment Group; Tax Pro Financial Network, Inc.; TCG; Theater Subdistrict Council; Tiger Baron Foundation; Van Deusen Family Fund; Vervane Foundation; Watkins, Inc.; WMEE Foundation; Yorke Construction Corp. (list current as of 7/20/12)

Robert Abrams  
& Cynthia Vance  
George Ackert  
Michael Alicastro  
Elton Andrews  
Richard Anthony  
Cecilia Arana  
Emily Armstrong  
James Armstrong  
Dominick & Ilene Balletta  
Becky Ann & Dylan Baker  
Ken Bantum  
Carolyn Bechtel  
Lisa Benavides  
& Tim Blake Nelson  
Louisa Benton  
Gavin Berger  
& Craig Berggren  
Stephanie Berger & Paul King  
Beth & Eric Berman  
David Beth  
Lewis Black  
Emily Blavatnik  
Allison Blinks  
Noah Bogan  
Jane Bolster  
& Steve Wertimer  
Buzz Bovshow  
Blaise R. Box  
Becky Browder  
& Ted Neustadt  
Carlton T. Brown  
Iris A. Brown & Joe White  
Justin Brownhill  
Brian Byrnes  
Shawn & Laura Byron  
Joseph Capozzi  
Leah Carr  
Lawrence Catena  
Chris Ceraso  
Rachel Chanoff  
Todd Christie  
Damien Clancy  
Matthew Clancy  
Katie Clark  
Elizabeth Clemants  
David Cohen  
& Sandra Novak Cohen  
Larry Cohen

Penelope Collins  
Judith-Ann Corrente  
Janet Coviello  
William Crudup  
Kyle Czepiel  
Arthur Dantchik  
Cathy Dantchik  
Leslie Dantchik  
Peter & Judith Dawkins  
Carolyn & Neil DeSena  
Rebecca & Richard Dresser  
Peter Doyle  
Max Dyksterhouse  
& David Roady  
Doug Eisenberg  
Lynn Ellenberg  
Nora Ephron  
& Nicholas Pileggi  
Peter Jay Fernandez  
& Denise Burse Fernandez  
Liz Flahive & Jeff Cox  
Wendy Flanagan  
& Chris O'Malley  
Karen & Paul Freitas  
Sally Froelich  
Alexandra Garrison  
Beverly Gasner  
Rose Gasner & Larry Chertoff  
Celia Gerard & Mark McGrath  
Christina Gerber  
Freddie & Myrna Gershon  
Jenny Gersten & Willie Reale  
Alexandra Gersten-Vassilaros  
& John Vassilaros  
Scott Aaron Gewirtz  
& Laura Gewirtz  
Elizabeth Giamatti  
Robert Goldberg  
& Betsy MacIsaac  
Stephen & Cathy Graham  
Jan Gura & Alan Pickman  
Susan Hanson  
Jessica Hecht  
& Adam Bernstein  
Kathy & Jamie Herring  
Peter Herdrich & Karen Trott  
William Holtzman  
& S. Sylvia Shepard  
Mary Horowitz

Sarah Horowitz  
& David Venarde  
Andrea Johnson  
Beth Ifcher  
Carine Joannou  
Kristen Johanson  
Andrea Johnson  
Cindy Kaplan & David Froelich  
Valerie Kay & Bruce Graham  
Louise Klebanoff  
Henry Krieger & Robert Joy  
Jacki Ochs & Jan Kroeze  
Judy Kuhn & David Schwab  
Frances & Fred Langbecker  
Gabrielle Lansner  
& Dean Taucher  
Brian Lapin  
Michael Lawrence  
& Glen Gillen  
Warren Leight & Karen Hauser  
Mickey Lemle  
Jonathan Levine  
Helen Levy  
Melissa Liebling-Goldberg  
& John Barrett  
Kay M. Lim  
Adrienne Lobel  
John Lynch  
Grace Lyu-Volckhausen  
Julie & Alex Margolies  
Ali Marsh  
Lin Manuel Miranda  
Frances McDormand  
& Joel Coen  
Emily & John Morgan  
Amanda & Neal Moszkowski  
Suzen Murakoshi  
& Mark Temme  
Fred Nelson  
Randy & Rona Nelson  
Ruth Nelson  
Lori O'Connor  
Carol Ochs & Bruce MacVittie  
Jacki Ochs & Jan Kroeze  
Kevin O'Rourke  
& Edith Thurber  
Jane Perlmutter  
& Greg MacPherson  
Elizabeth Peters

Sue Phillips  
Todd Poisson  
Suzanne Poulin  
Helaine & Michael Pruzan  
Christopher Randolph  
Helen & Peter Randolph  
Jacquelyn Reingold  
Anita A. Rogerson  
David Ross & Laura Ross  
Dr. Steve Rudin  
Laura Sametz & Anton Fig  
Karin & Thomas Schall  
Maury Schott  
Susan Schroeder  
& Britt Adams  
Whitney Scott  
& Peter Jacobson  
Meg Simon  
Christopher Solomon  
Jonathan Soros  
& Jennifer Soros  
Jenny & Jon Steingart  
Tracy Straus  
Danny Strong  
Al Styron & Ed Beason  
Susanna Styron  
Richard Sweren  
Lili Taylor  
Lisa Tilney & Chris Lawrence  
Merritt Tilney & Douglas Kaden  
Lorraine Tobias & Alex Draper  
Liz Tuccillo  
Laura Valeroso  
& David Seidman  
Wendy vanden Heuvel  
& Brad Coley  
Susan J. Vitucci  
Mary Pat Walsh  
Dr. Mildred Walton  
Brenda Wehle & John C. Lynch  
Carol Whitesides  
Zee Wiener  
Ruth Ann Wynter  
J.P. Xenakis  
Carole Yass  
Yildiz Yuksek  
& Richard Blackstone  
Connie & Marc Zand

THE 52ND STREET PROJECT PRESENTS

# make it snappy!



PLAYS IN a new YORK minute



THE 2013 HAROLD & MIMI STEINBERG CHARITABLE TRUST  
BLOCK ISLAND one-on-ones



Friday, July 19 at 7:30 🕒 Saturday, July 20 at 7:30 🕒 Sunday, July 21 at 3:00

The 52nd Street Project's  
Five Angels Theater

## Make It Snappy: Plays in a New York Minute

The Annual Block Island One-on-Ones - July 19-21, 2013 at the Five Angels Theater

### The 52nd Street Project Staff

Gus Rogerson, Artistic Director  
Megan Cramer, Associate Artistic Director  
George Babiak, Production Manager  
Ray Harold, Technical Director

Carol Ochs, Executive Director  
Lisa Kerner, Development & Mgmt. Associate  
John Sheehy, Dir. of Development & Marketing  
Alyssa Anderson, Mgr. of Individual Giving

Liz Bell, Director of Education  
Johanna Vidal, Community Coordinator

#### Consultants

Iris A. Brown, Graphic Designer; Chris Ceraso, Teen Dean

#### Interns

Isobel McBride, Dan Perry, Jillian Pulhalla, Alex Tisiere

#### Teen Employees

Receptionists: Gaby DeJesus, Daquan Nelson, Alizette Zapata  
Block Island Teen Counselor: Lauren Robinson  
Ushers: Alvin Garcia, Maximo Jimenez, Chanel Rodney, Nathaly Trinidad

### "MAKE IT SNAPPY" Production Staff

#### Composer/Music Director

Eric A. March

#### Set Designer

Kevin Joseph Roach

#### Lighting Designer

Josh Langman

#### Costume Designer

Jennifer Kirschman

#### Sound Designer

Isobel McBride

#### Stage Manager

Liz Bell

#### Projection Designs

George Babiak, Lee Rosen,  
Joe Osheroff, and The 52nd Street  
Project Slide Archive

#### Prop Design Team

George Babiak, Isobel McBride,  
Dan Perry, Jillian Pulhalla, Alex Tisiere

#### Backstage Crew

Joseph Cruz, Dan Perry,  
Jillian Pulhalla, Lauren Robinson,  
Alex Tisiere

#### House Managers

Carol Ochs, Alyssa Anderson

#### Flyer/Program Art

Patrick Jones

#### Chefs

Martha Velie-Gass  
and Pat Ritter



The One-on-One Program is made possible with public funds from The National Endowment for the Arts, The New York State Council on the Arts, a state agency, and the New York City Department of Cultural Affairs. The 52nd Street Project is a member of Art/NY.

## COOL STUFF ON SALE IN THE LOBBY!

Fabulous Flyer Bars .....\$2.50 and \$2.00  
*and featuring Shel Silverstein's "Fivey and Twoey" logo:*  
Project Hoodies .....\$30.00  
Project Caps .....\$20.00  
Project T-shirts and tanks ..... \$12.00  
Project Mugs ..... \$5.00  
Project Notebook ..... \$5.00  
Project Pencil 3-pack ..... \$1.00

Thank you for coming to MAKE IT SNAPPY. If you are not on our mailing list (or if your address has changed), please fill out this form and give it to us on your way out or mail it to the address below. We would also like to know if you are interested in becoming a volunteer. We need help in all areas, so be sure to fill out the entire form.

PLEASE ADD ME TO YOUR MAILING LIST:

07/13

NAME \_\_\_\_\_

ADDRESS \_\_\_\_\_

CITY \_\_\_\_\_

STATE \_\_\_\_\_

ZIP \_\_\_\_\_

HOME PHONE \_\_\_\_\_

DAYTIME OR MOBILE PHONE \_\_\_\_\_

E-MAIL ADDRESS \_\_\_\_\_

MY OCCUPATION \_\_\_\_\_

MY HOBBIES \_\_\_\_\_

YES, I WOULD LIKE TO BE OF HELP. I CAN:

- |   |   |  |
|---|---|--|
| <input type="checkbox"/> Help load in and out for shows | <input type="checkbox"/> Draw and/or paint  | <input type="checkbox"/> Help kids with homework |
| <input type="checkbox"/> Hang lights                    | <input type="checkbox"/> Help with mailings | <input type="checkbox"/> Teach kids a skill      |
| <input type="checkbox"/> Work on a backstage crew       | <input type="checkbox"/> Do office work     | <input type="checkbox"/> Be a chef at an event   |
| <input type="checkbox"/> Do graphic design              | <input type="checkbox"/> Design sound       | <input type="checkbox"/> Design and sew costumes |
| <input type="checkbox"/> Other (please specify) _____   |   |  |

MY SCHEDULE IS:

- Very flexible. I'm often available during weekdays.  
 Somewhat flexible. I can help on the occasional morning or afternoon during the week.  
 Not very flexible at all, but I've got some free time on evenings and weekends.

If you would like to mail this (and you're always welcome to enclose a tax-deductible contribution), you can send it to: The 52nd Street Project, 789 10th Avenue, New York, NY 10019. Or fax it to (212) 333-5598.

COME BACK NEXT MONTH FOR...

# MAKE IT SNAPPY!

PLAYS IN A NEW YORK MINUTE **DOUBLE TIME!**

GUS ROGERSON, ARTISTIC DIRECTOR

CAROL OCHS, EXECUTIVE DIRECTOR



**10 NEW ADULT-WRITTEN PLAYS  
FEATURING KIDS WITH ADULT PARTNERS**

Friday, August 16 at 7:30

Saturday, August 17 at 7:30

Sunday, August 18 at 3:00

**The 52nd Street Project's Five Angels Theater**  
789 10th Avenue, between 52nd and 53rd Streets



## KEEP AN EYE OUT!

We are always searching for interns.

If you know of any college or graduate students who might enjoy working with us, playing with us, and going on trips with us for a semester, please have them contact Lisa Kerner. We are especially looking for interns for Fall, 2013, and Spring, 2014. Thanks!

## The 52nd Street Project Board of Directors

Lisa Benavides	Carol Ochs
Rachel Chanoff	Willie Reale, founder
Cathy Dantchik, co-chair	Gus Rogerson
Carolyn DeSena	Shirley Rumierk, alumni member
Wendy Ettinger, chair emeritus	José Soto, Jr., alumni member
Louis P. Friedman, co-chair	Jenny Steingart
Robert Goldberg	Lisa Tilney
Stephen Graham, chair emeritus	Merritt Tilney
Valerie Kay	Wendy vanden Heuvel
Frances McDormand	John A. Vassilaros
Noël Mihalow	

## What's Going On Here?

The 52nd Street Project is a non-profit organization that brings children from the Hell's Kitchen neighborhood together with professional theater artists to create original theater. MAKE IT SNAPPY is a production of our One-on-One program, which is designed to give children the opportunity to go away for one-week stays in the country and enjoy the undivided attention of a professional theater artist who serves as friend, mentor, and collaborator.

## In-Kind Contributions

Abbeville Press; ABC Kitchen; Stephanie Berger Photography; Lewis Black; Iris A. Brown Design; William Curran & A Curran Affair; Michael Dorf & City Winery; Commonwealth Proper; Emmett Global; Ferragamo Timepieces; Hudson Scenic; ICI; JetBlue; Paul, Weiss, Rifkind, Wharton & Garrison LLP; Pharma Print; Sesame Workshop; Showtime; Wendy Stuhlberg; Tao Group; Uber; John A. Vassilaros; Watkins, Inc.; and Wynn Resorts.

## Special Thanks

Our Host Families- Susan Bush; Socha Cohen; Katy Homans and Mardette and Patterson Sims; Leslie Parsons; Joya Verde and Virginia Dare; and our headquarters host Dr. Christina Biaggi. Sincere thanks to our chefs Pat Ritter and Martha Velie-Gass; Kate Butcher and everyone at Block Island Realty; McQuade's Marketplace; Robbie Brown; Rita and Steve Draper; Amelia Gallant at the Block Island Grocery; Glenn and Annie Hall; Interstate Navigation; Josie Merck and Jim Stevenson; and Ron and Judy Tierney.



## Make it Snappy: Plays in a New York Minute – ACT 1

All original music composed by Eric A. March (except where noted).  
*Make it Snappy Theme Song* lyrics by John Sheehy

### SPACE CADET

Written by Nick Platt and directed by Joel Perez for Damian Tineo, age 10

Biff .....Damian Tineo  
Big Randy .....Joel Perez  
Nuzzles.....George Babiak

*Big Changes* lyrics by Nick Platt

### FIGHT TEST

Written by Nora Chau and directed by Ka-Ling Cheung  
for Brooke Fraser, age 11

Bethany .....Brooke Fraser  
Narrator/ Principal Jarvis .....Ka-Ling Cheung  
Janitor.....Dan Perry  
Bullies ..... Lauren Robinson and Alex Tisiere

*It's Been a Pleasure* lyrics by Nora Chau

### THE CORN STALKS AT NIGHT

Written by Robert Askins and directed by Michael Propster  
for Matthew Orozco, age 12

Jackie Bialystock .....Matthew Orozco  
Boss Bird's Eye/ Corn Plant/ Farmer.....Michael Propster  
Tentacles .....Dan Perry and Alex Tisiere

*Bigger Better Faster More* lyrics by Robert Askins

### ZERO AND FIVE

Written by Matt Schatz and directed by Jennifer Ikeda  
for Jayda Camacho, age 11

Girl Zero.....Jayda Camacho  
Planet Five.....Jennifer Ikeda

*Talk to My Planet* and *Talk To Each Other* music and lyrics by Matt Schatz

### G.A.

Written by Josh Halloway and directed by Stephen O'Reilly  
for Ezekiel Albarron, age 11

The Creature .....Ezekiel Albarron  
Jeff.....Stephen O'Reilly

*Gabba Blabba Wabba Woo* lyrics by Josh Halloway

## Make it Snappy: Plays in a New York Minute – ACT 2

### V.B.F.

Written by Erica Saleh and directed by Kimiye Corwin  
for Christin Tetteh, age 12

Maya.....Christin Tetteh  
Cabbie, et al. ....Kimiye Corwin

*Old Friends* lyrics by Erica Saleh

### A BRIEF HISTORY OF CRIME

Written and directed by Lee Aaron Rosen for Timmy Miller, age 13

Gordo Rumblemacher .....Timmy Miller  
Dr. Vimmo Lacatuna ..... Lee Aaron Rosen  
Smith and Wollensky ..... Dan Perry and Lauren Robinson

*Lacatunian Standoff* lyrics by Lee Aaron Rosen

### BORN TO RUN

Written by Liz Flahive and directed by Erin Felgar for Stephanie Macias, age 11

Jill ..... Stephanie Macias  
Joanie ..... Erin Felgar  
Marathoners ..... The Crew

*I Know I Can Run* and *26.2* lyrics by Liz Flahive

### I NEVER METAPHYSIC I DIDN'T LIKE

Written and directed by John Sheehy for Kai Ceniza, age 10

Teo.....Kai Ceniza  
Cosmo .....John Sheehy

*Here in the Nexus* lyrics by John Sheehy

### ZOMBIE DANCE PARTY

Written by Graeme Gillis and directed by Daiva Deupree  
for Tyleek Powell, age 11

Marvin Romero/ Cousin Zombie/ Bat Boy ..... Tyleek Powell  
Kimberly/ Frankensushi ..... Daiva Deupree  
Newscaster .....Alex Tisiere  
Various Creatures ..... The Crew

*Zombies Groove* lyrics by Graeme Gillis

The 52nd Street Project gratefully acknowledges the support of the following foundations and corporations: Bloomberg; Brenner Family Foundation; Cantor Fitzgerald; CBS Corporation; Consolidated Edison; Dawkins Family Foundation; The Neil V. DeSena Foundation; The Dramatists Guild Fund; Dramatists Play Service; The Educational Foundation Of America; Sidney E. Frank Foundation; Fund for the City of New York; Goldman Sachs; The Horace W. Goldsmith Foundation; Heisman Foundation; Hudson Scenic Studio; Lotos Foundation; Ann M. Martin Foundation; Marusi Family Foundation; Monteforte Foundation; The PAR Group; The People's Choice Awards; Quadra Productions; Sesame Workshop; The Shubert Organization; Simon & Eisenberg; Starker Family Foundation; Harold & Mimi Steinberg Charitable Trust; Surdna Foundation; Susquehanna Investment Group; Tax Pro Financial Network, Inc.; TCG; Theater Subdistrict Council; Tiger Baron Foundation; Van Deusen Family Fund; Vervane Foundation; Watkins, Inc.; WMEE Foundation; Yorke Construction Corp. (list current as of 7/20/12)

Robert Abrams  
& Cynthia Vance  
George Ackert  
Michael Alicastro  
Elton Andrews  
Richard Anthony  
Cecilia Arana  
Emily Armstrong  
James Armstrong  
Dominick & Ilene Balletta  
Becky Ann & Dylan Baker  
Ken Bantum  
Carolyn Bechtel  
Lisa Benavides  
& Tim Blake Nelson  
Louisa Benton  
Gavin Berger  
& Craig Berggren  
Stephanie Berger & Paul King  
Beth & Eric Berman  
David Beth  
Lewis Black  
Emily Blavatnik  
Allison Blinks  
Noah Bogan  
Jane Bolster  
& Steve Wertimer  
Buzz Bovshow  
Blaise R. Box  
Becky Browder  
& Ted Neustadt  
Carlton T. Brown  
Iris A. Brown & Joe White  
Justin Brownhill  
Brian Byrnes  
Shawn & Laura Byron  
Joseph Capozzi  
Leah Carr  
Lawrence Catena  
Chris Ceraso  
Rachel Chanoff  
Todd Christie  
Damien Clancy  
Matthew Clancy  
Katie Clark  
Elizabeth Clemants  
David Cohen  
& Sandra Novak Cohen  
Larry Cohen

Penelope Collins  
Judith-Ann Corrente  
Janet Coviello  
William Crudup  
Kyle Czepiel  
Arthur Dantchik  
Cathy Dantchik  
Leslie Dantchik  
Peter & Judith Dawkins  
Carolyn & Neil DeSena  
Rebecca & Richard Dresser  
Peter Doyle  
Max Dyksterhouse  
& David Roady  
Doug Eisenberg  
Lynn Ellenberg  
Nora Ephron  
& Nicholas Pileggi  
Peter Jay Fernandez  
& Denise Burse Fernandez  
Liz Flahive & Jeff Cox  
Wendy Flanagan  
& Chris O'Malley  
Karen & Paul Freitas  
Sally Froelich  
Alexandra Garrison  
Beverly Gasner  
Rose Gasner & Larry Chertoff  
Celia Gerard & Mark McGrath  
Christina Gerber  
Freddie & Myrna Gershon  
Jenny Gersten & Willie Reale  
Alexandra Gersten-Vassilaros  
& John Vassilaros  
Scott Aaron Gewirtz  
& Laura Gewirtz  
Elizabeth Giamatti  
Robert Goldberg  
& Betsy MacIsaac  
Stephen & Cathy Graham  
Jan Gura & Alan Pickman  
Susan Hanson  
Jessica Hecht  
& Adam Bernstein  
Kathy & Jamie Herring  
Peter Herdrich & Karen Trott  
William Holtzman  
& S. Sylvia Shepard  
Mary Horowitz

Sarah Horowitz  
& David Venarde  
Andrea Johnson  
Beth Ifcher  
Carine Joannou  
Kristen Johanson  
Andrea Johnson  
Cindy Kaplan & David Froelich  
Valerie Kay & Bruce Graham  
Louise Klebanoff  
Henry Krieger & Robert Joy  
Jacki Ochs & Jan Kroeze  
Judy Kuhn & David Schwab  
Frances & Fred Langbecker  
Gabrielle Lansner  
& Dean Taucher  
Brian Lapin  
Michael Lawrence  
& Glen Gillen  
Warren Leight & Karen Hauser  
Mickey Lemle  
Jonathan Levine  
Helen Levy  
Melissa Liebling-Goldberg  
& John Barrett  
Kay M. Lim  
Adrienne Lobel  
John Lynch  
Grace Lyu-Volckhausen  
Julie & Alex Margolies  
Ali Marsh  
Lin Manuel Miranda  
Frances McDormand  
& Joel Coen  
Emily & John Morgan  
Amanda & Neal Moszkowski  
Suzen Murakoshi  
& Mark Temme  
Fred Nelson  
Randy & Rona Nelson  
Ruth Nelson  
Lori O'Connor  
Carol Ochs & Bruce MacVittie  
Jacki Ochs & Jan Kroeze  
Kevin O'Rourke  
& Edith Thurber  
Jane Perlmutter  
& Greg MacPherson  
Elizabeth Peters

Sue Phillips  
Todd Poisson  
Suzanne Poulin  
Helaine & Michael Pruzan  
Christopher Randolph  
Helen & Peter Randolph  
Jacquelyn Reingold  
Anita A. Rogerson  
David Ross & Laura Ross  
Dr. Steve Rudin  
Laura Sametz & Anton Fig  
Karin & Thomas Schall  
Maury Schott  
Susan Schroeder  
& Britt Adams  
Whitney Scott  
& Peter Jacobson  
Meg Simon  
Christopher Solomon  
Jonathan Soros  
& Jennifer Soros  
Jenny & Jon Steingart  
Tracy Straus  
Danny Strong  
Al Styron & Ed Beason  
Susanna Styron  
Richard Sweren  
Lili Taylor  
Lisa Tilney & Chris Lawrence  
Merritt Tilney & Douglas Kaden  
Lorraine Tobias & Alex Draper  
Liz Tuccillo  
Laura Valeroso  
& David Seidman  
Wendy vanden Heuvel  
& Brad Coley  
Susan J. Vitucci  
Mary Pat Walsh  
Dr. Mildred Walton  
Brenda Wehle & John C. Lynch  
Carol Whitesides  
Zee Wiener  
Ruth Ann Wynter  
J.P. Xenakis  
Carole Yass  
Yildiz Yuksek  
& Richard Blackstone  
Connie & Marc Zand

THE 52ND STREET PROJECT PRESENTS

# make it snappier!

PLAYS IN A NEW YORK MINUTE

DOUBLE TIME!



ARTWORK BY PATRICK JONES

**THE 2013 STEINGART FAMILY  
WAREHAM ONE-ON-ONES**

Friday, August 16 at 7:30

Saturday, August 17 at 7:30

Sunday, August 18 at 3:00

**Five Angels Theater**

## Make it Snappier: Plays in a New York Minute - Double Time!

The Annual Wareham One-on-Ones - August 16-18, 2013 at the Five Angels Theater

### The 52nd Street Project Staff

Gus Rogerson, Artistic Director  
Megan Cramer, Associate Artistic Director  
George Babiak, Production Manager  
Ray Harold, Technical Director

Carol Ochs, Executive Director  
Lisa Kerner, Devpt. & Mgmt. Associate  
John Sheehy, Dir. of Development & Marketing  
Alyssa Anderson, Mgr. of Individual Giving

Liz Bell, Director of Education  
Johanna Vidal, Community Coordinator

#### Consultants:

Iris A. Brown, Graphic Designer; Chris Ceraso, Teen Dean

#### Interns:

Isobel McBride, Dan Perry, Jillian Puhalla, Alex Tisiere

#### Teen Employees:

Receptionists: Joyce Cheung, Gabriella DeJesus, Alvin Garcia  
Wareham Teen Counselor: Daquan Nelson  
Ushers: Alvin Garcia, Maximo Jimenez, Jazmine Mikell, Edison Sibri

### "Make it Snappier" Production Staff

#### Composer/Music Director

Patrick Barnes

#### Set Designer

Kevin Joseph Roach

#### Lighting Designer

Greg MacPherson

#### Costume Designers

Sarah Swafford and Crystal Thompson

#### Sound Designer

Jason Cawley

#### Stage Manager

Jeff Brancato

#### Slide Designs

George Babiak, Isobel McBride, and the Project Slide Archive

#### Prop Design Team

George Babiak, Isobel McBride, Dan Perry, Jillian Puhalla, Alex Tisiere

#### Backstage Crew

Isobel McBride, Daquan Nelson, Dan Perry, Alex Tisiere, Jamie Yip

#### House Manager

Alyssa Anderson

#### Flyer/Program Art:

Patrick Jones

#### Chefs

John Sheehy, Liz Bell, Carol Ochs

#### Production Photographer

Winston Rodney



The One-on-One Program is made possible with public funds from The New York State Council on the Arts, a state agency, and the New York City Department of Cultural Affairs. The 52nd Street Project is a member of Art/NY.

## COOL STUFF ON SALE IN THE LOBBY!

Fabulous Flyer Bars .....\$2.50 and \$2.00  
and featuring Shel Silverstein's "Fivey and Twoey" logo:  
Project Hoodies .....\$30.00  
Project Caps.....\$20.00  
Project T-shirts .....\$12/\$20  
Project Mugs..... \$5.00  
Project Notebook..... \$5.00  
Project Pencil 3-pack .....\$1.00

Thank you for coming to MAKE IT SNAPPIER. If you are not on our mailing list (or if your address has changed), please fill out this form and give it to us on your way out or mail it to the address below. We would also like to know if you are interested in becoming a volunteer. We need help in all areas, so be sure to fill out the entire form.

PLEASE ADD ME TO YOUR MAILING LIST:

08/13

NAME \_\_\_\_\_

ADDRESS \_\_\_\_\_

CITY \_\_\_\_\_

STATE \_\_\_\_\_

ZIP \_\_\_\_\_

HOME PHONE \_\_\_\_\_

DAYTIME OR MOBILE PHONE \_\_\_\_\_

E-MAIL ADDRESS \_\_\_\_\_

MY OCCUPATION \_\_\_\_\_

MY HOBBIES \_\_\_\_\_

YES, I WOULD LIKE TO BE OF HELP. I CAN:

- Draw and/or color props  
 Hang lights  
 Work on a backstage crew  
 Do graphic design  
 Other (please specify) \_\_\_\_\_
- Teach kids a skill  
 Help with mailings  
 Be a chef at an event  
 Design sound
- Help kids with homework  
 Design and sew costumes

MY SCHEDULE IS:

- Very flexible. I'm often available during weekdays.  
 Somewhat flexible. I can help on the occasional morning or afternoon during the week.  
 Not very flexible at all, but I've got some free time on evenings and weekends.

If you would like to mail this (and you're always welcome to enclose a tax-deductible contribution), you can send it to: The 52nd Street Project, 789 10th Avenue, New York, NY 10019. Or fax it to (212) 333-5598.

**COMING SOON TO THE PROJECT...**

////////////////////////////////////  
**IN TRANSIT**  
***PLAYS ON THE MOVE***  
////////////////////////////////////

**The 2013 Playback Plays**

The reverse of the One-on-One's!  
Kids write plays for themselves and an  
adult partner to perform together.

October 25-27 right here at  
**THE FIVE ANGELS THEATER**

 **BE ON THE LOOKOUT!**  
**We are always  
searching for interns.**

If you know of any college or graduate students who might enjoy working with us, playing with us, and going on trips with us for a semester, please have them contact Lisa Kerner. We are especially looking for interns for the Spring of 2014. Thanks!

- The 52nd Street Project Board of Directors**
- |                                |                                |
|--------------------------------|--------------------------------|
| Lisa Benavides                 | Carol Ochs                     |
| Rachel Chanoff                 | Willie Reale, founder          |
| Cathy Dantchik, co-chair       | Gus Rogerson                   |
| Carolyn DeSena                 | Shirley Rumierk, alumni member |
| Wendy Ettinger, chair emeritus | José Soto, Jr., alumni member  |
| Louis P. Friedman, co-chair    | Jenny Steingart                |
| Robert Goldberg                | Lisa Tilney                    |
| Stephen Graham, chair emeritus | Merritt Tilney                 |
| Valerie Kay                    | Wendy vanden Heuvel            |
| Frances McDormand              | John A. Vassilaros             |
| Noël Mihalow                   |                                |

---

**What's Going On Here?**

The 52nd Street Project is a non-profit organization that brings children from the Hell's Kitchen neighborhood together with professional theater artists to create original theater. MAKE IT SNAPPIER is a production of our One-on-One program, which is designed to give children the opportunity to go away for one-week stays in the country and enjoy the undivided attention of a professional theater artist who serves as friend, mentor, and collaborator.

---

**In-Kind Contributions**

Abbeville Press; ABC Kitchen; Stephanie Berger Photography; Lewis Black; Iris A. Brown Design; William Curran & A Curran Affair; Michael Dorf & City Winery; Commonwealth Proper; Emmett Global; Ferragamo Timepieces; Hudson Scenic; ICI; JetBlue; Paul, Weiss, Rifkind, Wharton & Garrison LLP; Pharma Print; Sesame Workshop; Showtime; Wendy Stuhlberg; Tao Group; Uber; John A. Vassilaros; Watkins, Inc.; and Wynn Resorts.

---

**Special Thanks**

An extra special helping of gratitude goes to our host families; the people who housed our kids and adult volunteers during our week in Wareham, Mass.: Andrea & Emmanuel Daskalaskis; Joe McNay; Alice McNay; Anne & Colin McNay; Gray & Rosemary Watson; Bob & Marina Whitman; Sidney Worthen, and above all, our main house hosts Peter, Helen, Christopher & Nicholas Randolph.

Sincere Thanks to Robin Morse, Lucy & Francis Rogerson; Bruce & Sophia MacVittie; Vanessa Valdes; Eric March, Bob Krystofolski; and George Hurd.

## MAKE IT SNAPPIER- ACT 1

### AUGUST THIRTIETH

Written by Sarah Burgess & Directed by Lucy DeVito for Camile Bernard, age 11.  
Costumes by Sarah Swafford.

Caitlin..... Camile Bernard  
Linda..... Lucy DeVito  
Announcement ..... Alex Tisiere

*“The Party Duet”* lyrics by Sarah Burgess

### GHOST DREAMS

Written & Directed by Jed Clarke for Ricardo Currin, age 11.  
Costumes by Sarah Swafford.

Rock ..... Ricardo Currin  
Jack ..... Jed Clarke  
Mr. Coach ..... Christopher Randolph  
Chef Ghoul ..... Isobel McBride

*“The Crazy Situation”* lyrics by Jed Clarke

### TIME TO GO HOME

Written by Cynthia Kaplan & Directed by Jillian Puhalla for Sasha Davis, age 11.  
Costumes by Crystal Thompson

Joan..... Sasha Davis  
Saskia..... Jillian Puhalla  
Voices..... Darcy Fowler, Korey Jackson  
Cicada Chorus..... Megan Cramer, Darcy Fowler, Korey Jackson, Lindsay Torrey

*“The World I Remember I Knew”* music and lyrics by Cynthia Kaplan

### CATCH!

Written by Tasha Gordon-Solmon & Directed by Lindsay Torrey  
for Jasmine Correa, age 13. Costumes by Sarah Swafford.

Tess ..... Jasmine Correa  
Ellie..... Lindsay Torrey  
Announcers ..... Daquan Nelson & Dan Perry  
Annoying Fan ..... Dan Perry  
Hungry Fan..... Daquan Nelson  
Kid ..... Jamie Yip

*“I Need This Ball”* and *“Peanuts”* lyrics by Tasha Gordon-Solmon

### PORTAL POTTY

Written & Directed by Dylan Dawson for Justin Bannister, age 12.  
Costumes by Sarah Swafford.

Ned Neidermeyer ..... Justin Bannister  
Robbie Brown ..... Dylan Dawson  
Bullies ..... Daquan Nelson and Isobel McBride  
Multiple Neds..... Crew

*“Number Two”* and *“Robbie Brown”* lyrics by Dylan Dawson

## MAKE IT SNAPPIER - ACT 2

### FOLLOW YOUR DREAMS

Written & Directed by Megan Cramer for Wilhelmina Ohene Kari Kari, age 11.  
Costumes by Sarah Swafford.

Dr. Remy..... Wilhelmina Ohene Kari Kari  
Mary Knight ..... Megan Cramer

*“Dream Jingle”* and *“All the Way to the End”* lyrics by Megan Cramer

### SLIGHTLY DAMAGED

Written by Eric Dufault & Directed by Korey Jackson for David Ortiz, age 11.  
Costumes by Crystal Thompson

Floyd..... David Ortiz  
Pete ..... Korey Jackson

*“Come on Down”* lyrics by Eric Dufault

### MOUSE ARREST

Written & Directed by George Babiak for Tiniyah Renee Powell, age 11.  
Costumes by Sarah Swafford.

Ramona..... Tiniyah Renee Powell  
Joe..... George Babiak  
Millie ..... Isobel McBride  
The Mouse..... Christopher Randolph  
Ramon Gnawsalot..... Ray Harold

*“Itchin’ for the Kitchen”* lyrics by George Babiak

### ROD ROCK, UNDERCOVER COP

Written by Josh Koenigsberg & Directed by J. Mallory McCree for Mussa Ahmed,  
age 11. Costumes by Sarah Swafford.

Rod Rock/Louie Leibowitz..... Mussa Ahmed  
Chief Callahan/Sammy Shooter ..... J. Mallory McCree  
The Rod Rockettes..... Megan Cramer, Darcy Fowler, Lindsay Torrey  
British Announcer ..... Alex Tisiere

*“Just Retire Now”* lyrics by Josh Koenigsberg

### THE EYES OF THE MELTING BOY

Written & Directed by Darcy Fowler for Chyanne Peña, age 11.  
Costumes by Sarah Swafford.

Larissa ..... Chyanne Peña  
Monica ..... Darcy Fowler  
Dad ..... Christopher Randolph

*“Prepare to be Scared”* lyrics by Darcy Fowler

All original music composed by Patrick Barnes, except where noted.  
“Make it Snappy” Theme Song lyrics by John Sheehy

The 52nd Street Project gratefully acknowledges the support of the following foundations and corporations: Bloomberg; Brenner Family Foundation; Cantor Fitzgerald; CBS Corporation; The Common Sense Fund; Consolidated Edison; Dawkins Family Foundation; The Neil V. DeSena Foundation; The Dramatists Guild Fund; Dramatists Play Service; The Educational Foundation Of America; Sidney E. Frank Foundation; Fund for the City of New York; Goldman Sachs; The Horace W. Goldsmith Foundation; Heisman Foundation; Hudson Scenic Studio; Lotos Foundation; Ann M. Martin Foundation; Marusi Family Foundation; Monteforte Foundation; Newman's Own; The PAR Group; The People's Choice Awards; Quadra Productions; Sesame Workshop; The Shubert Organization; Simon & Eisenberg; Starker Family Foundation; Harold & Mimi Steinberg Charitable Trust; Surdna Foundation; Susquehanna Investment Group; Tax Pro Financial Network, Inc.; TCG; Theater Subdistrict Council; Tiger Baron Foundation; Van Deusen Family Fund; Vervane Foundation; Watkins, Inc.; WMEE Foundation; Yorke Construction Corp. (list current as of 7/20/12)

Robert Abrams & Cynthia Vance	Penelope Collins Judith-Ann Corrente	Sarah Horowitz & David Venarde	Sue Phillips Todd Poisson
George Ackert	Janet Coviello	Andrea Johnson	Suzanne Poulin
Michael Alicastro	William Crudup	Beth Ifcher	Helaine & Michael Pruzan
Elton Andrews	Kyle Czepiel	Carine Joannou	Christopher Randolph
Richard Anthony	Arthur Dantchik	Kristen Johanson	Helen & Peter Randolph
Cecilia Arana	Cathy Dantchik	Andrea Johnson	Jacquelyn Reingold
Emily Armstrong	Leslie Dantchik	Cindy Kaplan & David Froelich	Anita A. Rogerson
James Armstrong	Peter & Judith Dawkins	Valerie Kay & Bruce Graham	David Ross & Laura Ross
Dominick & Ilene Balletta	Carolyn & Neil DeSena	Louise Klebanoff	Dr. Steve Rudin
Becky Ann & Dylan Baker	Rebecca & Richard Dresser	Henry Krieger & Robert Joy	Laura Sametz & Anton Fig
Ken Bantum	Peter Doyle	Jacki Ochs & Jan Kroeze	Karin & Thomas Schall
Carolyn Bechtel	Max Dyksterhouse & David Roady	Judy Kuhn & David Schwab	Maury Schott
Lisa Benavides & Tim Blake Nelson	Doug Eisenberg	Frances & Fred Langbecker	Susan Schroeder & Britt Adams
Louisa Benton	Lynn Ellenberg	Gabrielle Lansner & Dean Taucher	Whitney Scott & Peter Jacobson
Gavin Berger & Craig Berggren	Nora Ephron & Nicholas Pileggi	Brian Lapin	Meg Simon
Stephanie Berger & Paul King	Peter Jay Fernandez & Denise Burse Fernandez	Michael Lawrence & Glen Gillen	Christopher Solomon
Beth & Eric Berman	Liz Flahive & Jeff Cox	Warren Leight & Karen Hauser	Jonathan Soros & Jennifer Soros
David Beth	Wendy Flanagan & Chris O'Malley	Mickey Lemle	Jenny & Jon Steingart
Lewis Black	Karen & Paul Freitas	Jonathan Levine	Tracy Straus
Emily Blavatnik	Sally Froelich	Helen Levy	Danny Strong
Allison Blinks	Alexandra Garrison	Melissa Liebling-Goldberg & John Barrett	Al Styron & Ed Beason
Noah Bogan	Beverly Gasner	Kay M. Lim	Susanna Styron
Jane Bolster & Steve Wertimer	Rose Gasner & Larry Chertoff	Adrienne Lobel	Richard Sweren
Buzz Bovshow	Celia Gerard & Mark McGrath	John Lynch	Lili Taylor
Blaise R. Box	Christina Gerber	Grace Lyu-Volckhausen	Lisa Tilney & Chris Lawrence
Becky Browder & Ted Neustadt	Freddie & Myrna Gershon	Julie & Alex Margolies	Merritt Tilney & Douglas Kaden
Carlton T. Brown	Jenny Gersten & Willie Reale	Ali Marsh	Lorraine Tobias & Alex Draper
Iris A. Brown & Joe White	Alexandra Gersten-Vassilaros & John Vassilaros	Lin Manuel Miranda	Liz Tuccillo
Justin Brownhill	Scott Aaron Gewirtz & Laura Gewirtz	Frances McDormand & Joel Coen	Laura Valeroso & David Seidman
Brian Byrnes	Elizabeth Giamatti	Emily & John Morgan	Wendy vanden Heuvel & Brad Coley
Shawn & Laura Byron	Robert Goldberg & Betsy MacIsaac	Amanda & Neal Moszkowski	Susan J. Vitucci
Joseph Capozzi	Stephen & Cathy Graham	Suzen Murakoshi & Mark Temme	Mary Pat Walsh
Leah Carr	Jan Gura & Alan Pickman	Fred Nelson	Dr. Mildred Walton
Lawrence Catena	Susan Hanson	Randy & Rona Nelson	Brenda Wehle & John C. Lynch
Chris Ceraso	Jessica Hecht & Adam Bernstein	Ruth Nelson	Carol Whitesides
Rachel Chanoff	Kathy & Jamie Herring	Lori O'Connor	Zee Wiener
Todd Christie	Peter Herdrich & Karen Trott	Carol Ochs & Bruce MacVittie	Ruth Ann Wynter
Damien Clancy	William Holtzman & S. Sylvia Shepard	Jacki Ochs & Jan Kroeze	J.P. Xenakis
Matthew Clancy	Mary Horowitz	Kevin O'Rourke & Edith Thurber	Carole Yass
Katie Clark		Jane Perlmutter & Greg MacPherson	Yildiz Yuksek & Richard Blackstone
Elizabeth Clemants		Elizabeth Peters	Connie & Marc Zand
David Cohen & Sandra Novak Cohen			
Larry Cohen			

THE 52ND STREET PROJECT PRESENTS

# IN TRANSIT



## PLAYS ON THE MOVE! THE 2013 PLAYBACK SHOWS

9 NEW PLAYS WRITTEN BY KIDS AND PERFORMED  
BY THE PLAYWRIGHTS WITH ADULT PARTNERS AT THE

### FIVE ANGELS THEATER

789 10th Avenue (between 52nd and 53rd St.)

Friday, October 25 at 7:30 p.m.  
Saturday, October 26 at 7:30 p.m.  
Sunday, October 27 at 3:00 p.m.

# IN TRANSIT: PLAYS ON THE MOVE

Playback 2013 - Oct. 25-27, Five Angels Theater

## The 52nd Street Project Staff

Gus Rogerson, Artistic Director  
Megan Cramer, Associate Artistic Director  
George Babiak, Production Manager  
Ray Harold, Technical Director  
Liz Bell, Director of Education  
Johanna Vidal, Community Coordinator  
Olivia Strauss, Education Apprentice

Carol Ochs, Executive Director  
Lisa Kerner, Devpt. & Mgmt. Associate  
John Sheehy, Dir. of Development & Marketing  
Alyssa Anderson, Mgr. of Individual Giving

### Consultants:

Iris A. Brown, Graphic Designer; Chris Ceraso, Teen Dean

### Interns:

Sarah Lusche, Deenah Shutzer

### Teen Employees:

Receptionists: Gabriella DeJesus, Alvin Garcia, Daquan Nelson, Alizette Zapata  
Playback Teen Counselor: Alvin Garcia  
Ushers: Joyce Cheung, Haley Martinez, Brandon Shaffer, Alizette Zapata

## "In Transit" Production Staff

### Composer/Music Director

Loren Toolajian

### Set Designer

Kevin Joseph Roach

### Lighting Designer

Mitchell Ost

### Costume Designer

Lara DeBruijn

### Costume Associate

Kate Cusack

### Sound Designer

Maury Schott

### Stage Manager

Donald Fried

### Assistant Stage Manager

Brídín Clements

### Projection Designs

George Babiak & the  
Project Projection Preserve

### Prop Design Team

George Babiak, Sarah Lusche,  
Deenah Shutzer, Olivia Strauss

### Backstage Crew

Sarah Lusche, Deenah Shutzer,  
Ricardo Currin, Tyleek Powell

### House Manager

Alyssa Anderson

### Show Photographer

Winston Rodney

### Weekend-Away Chefs

Liz Bell, John Sheehy

### Bridgehampton Hosts

The Gersten-Vassilaros Family,  
Cathy Dantchik



The Playback Program is made possible with public funds from The New York State Council on the Arts, a state agency, and the New York City Department of Cultural Affairs. The 52nd Street Project is a member of Art/NY.

## COOL STUFF ON SALE IN THE LOBBY!

Fabulous Flyer Bars .....\$2.50 and \$2.00  
and featuring Shel Silverstein's "Fivey and Twoey" logo:  
Project Hoodies .....\$30.00  
Project Caps.....\$20.00  
Project T-shirts .....\$12/\$20  
Project Mugs..... \$5.00  
Project Notebook..... \$5.00  
Project Pencil 3-pack ..... \$1.00

Thank you for coming to IN TRANSIT! If you are not on our mailing list (or if your address has changed), please fill out this form and give it to us on your way out or mail it to the address below. We would also like to know if you are interested in becoming a volunteer. We need help in all areas, so be sure to fill out the entire form.

PLEASE ADD ME TO YOUR MAILING LIST:

10/13

NAME

ADDRESS

CITY

STATE

ZIP

HOME PHONE

DAYTIME OR MOBILE PHONE

E-MAIL ADDRESS

MY OCCUPATION

MY HOBBIES

YES, I WOULD LIKE TO BE OF HELP. I CAN:

- Draw and/or paint  Help kids with homework  
 Hang lights  Help with mailings  Teach kids a skill  
 Work on a backstage crew  Do office work  Be a chef at an event  
 Do graphic design  Design sound  Design and sew costumes  
 Other (please specify) \_\_\_\_\_

MY SCHEDULE IS:

- Very flexible. I'm often available during weekdays.  
 Somewhat flexible. I can help on the occasional morning or afternoon during the week.  
 Not very flexible at all, but I've got some free time on evenings and weekends.

If you would like to mail this (and you're always welcome to enclose a tax-deductible contribution), you can send it to: The 52nd Street Project, 789 10th Avenue, New York, NY 10019. Or fax it to (212) 333-5598.

**One Night Only**  
**SUNDAY, NOVEMBER 24**  
 Five Angels Theater  
 789 Tenth Avenue

**GET BACK**

A BENEFIT CONCERT WITH  
**JONATHAN GROFF**  
 For The 52nd Street Project

Tickets start at \$100.  
 Contact Alyssa Anderson  
 (anderson@52project.org)  
 or visit [www.52project.org](http://www.52project.org)



## KEEP YOUR EYES PEELED!

WE ARE ALWAYS SEARCHING FOR INTERNS.

If you know of any college or graduate students who might enjoy working with us, playing with us, and going on trips with us for a semester, please have them contact Lisa Kerner. We are especially looking for interns for the Spring and Summer of 2014. Thanks!

### The 52nd Street Project Board of Directors

Lisa Benavides	Carol Ochs
Rachel Chanoff	Willie Reale, founder
Cathy Dantchik, co-chair	Gus Rogerson
Carolyn DeSena	Shirley Rumierk, alumni member
Wendy Ettinger, chair emeritus	José Soto, Jr., alumni member
Louis P. Friedman, co-chair	Jenny Steingart
Robert Goldberg	Lisa Tilney
Stephen Graham, chair emeritus	Merritt Tilney
Valerie Kay	Wendy vanden Heuvel
Frances McDormand	John A. Vassilaros
Noël Mihalow	

### What's Going On Here?

The 52nd Street Project is a non-profit organization that brings children from the Hell's Kitchen neighborhood together with professional theater artists to create original theater. *IN TRANSIT* is a production of our Playback program, in which kid actor/playwrights wrote plays for themselves and adult actor/director partners. Everyone ventured to the Hamptons for a rehearsal retreat over the Columbus Day weekend. All of the kids involved are veterans of the Playmaking classes which were adapted for the Project by Daniel Judah Sklar from his book *Playmaking: Children Writing and Performing Their Own Plays*.

### In-Kind Contributions

Abbeville Press; ABC Kitchen; Stephanie Berger Photography; Lewis Black; Iris A. Brown Design; William Curran & A Curran Affair; Michael Dorf & City Winery; Commonwealth Proper; Emmett Global; Ferragamo Timepieces; Hudson Scenic; ICI; JetBlue; Paul, Weiss, Rifkind, Wharton & Garrison LLP; Pharma Print; Sesame Workshop; Showtime; Wendy Stuhlberg; Tao Group; Uber; John A. Vassilaros; Watkins, Inc.; and Wynn Resorts.

### Special Thanks

We're extremely grateful to board member John Vassilaros, his wife Alex Gersten-Vassilaros, and their three wonderful boys Tonio, Luka, and Stefano for allowing us to use their home as our headquarters on our rehearsal trip to the Hamptons. Huge thanks also go to Board Co-Chair Cathy Dantchik, who hosted our girls and some adults in her home in Bridgehampton.



## IN TRANSIT - ACT 1

All original music composed by Loren Toolajian.

### THE NOT SO EVIL VAMPIRE

Written by Kaitlin Feliciano, age 13  
Director/Dramaturge: Angela Lewis

Bethany ..... Kaitlin Feliciano  
Eloise ..... Angela Lewis

*I Wanna Be Human* lyrics by Kaitlin Feliciano

### FOOTBALL

Written by Richard Brea, age 13.  
Director/Dramaturge: Nick Mills

Peter Rober ..... Richard Brea  
Kevin Butter ..... Nick Mills

*Peter and Kevin* lyrics by Richard Brea

### SUCCESSFUL

Written by Amber Ureña, age 13  
Director/Dramaturge: Nancy Noto

Veronica ..... Amber Ureña  
Chrysanthemum ..... Nancy Noto  
Customer ..... Sarah Lusche  
Mom ..... Deenah Shutzer  
Designer ..... George Babiak

*Dreams* lyrics by Amber Ureña

### THE HACKER, THE PHOTOGRAPHER, AND THE INSTAGRAMMER

Written by Genesis Hires, age 13  
Director/Dramaturge: Rachel Rusch

Scarlett ..... Genesis Hires  
Zelena ..... Rachel Rusch  
Jacob ..... Armando Riesco  
People ..... The Crew

*One Million Followers* lyrics by Genesis Hires

### THE S.S. SEASHARK, ALSO KNOWN AS THE 4 S'S

Written by Chayse Peña, age 13  
Director/Dramaturge: Grant Harrison

Captain Anchor ..... Chayse Peña  
Co-Captain Blue ..... Grant Harrison

*We Made It* lyrics by Chayse Pena

## IN TRANSIT - ACT 2

### UNDER COVER TYPE AWAYS

Written by Britney Trinidad, age 13  
Director/Dramaturge: Zoey Martinson

Marisela ..... Britney Trinidad  
Zella ..... Zoey Martinson  
Customer 1 ..... Sarah Lusche  
Customer 2 ..... Deenah Shutzer  
Agent Bob ..... George Babiak

*You're My P.I.C.* lyrics by Britney Trinidad

### MIKE AND IKE

Written by Steven Baez-Padilla, age 14  
Director/Dramaturge: Vayu O'Donnell

Mike ..... Steven Baez-Padilla  
Ike ..... Vayu O'Donnell  
Owner ..... John Sheehy

*Is This It?* by Steven Baez-Padilla

### PRINCESS' WANTS

Written by Jade Cuevas, age 13  
Director/Dramaturge: Darcy Fowler

Jewel ..... Jade Cuevas  
Lizbeth ..... Darcy Fowler  
Chef Angilo ..... John Sheehy  
Papparazzi ..... The Crew  
Horse ..... George Babiak

*Princess Dreams, What Did I Do Wrong and We Did It* lyrics by Jade Cuevas

### ANYTHING IS POSSIBLE

Written by Adnan Ahmed, age 13  
Director/Dramaturge: Jeremy Rishe

Adrian Lasner ..... Adnan Ahmed  
Leo ..... Jeremy Rishe  
Donner ..... Gus Rogerson  
Principal ..... George Babiak  
Lunch Lady ..... Deenah Shutzer

*What I Go Through* lyrics by Adnan Ahmed

The 52nd Street Project is a non-profit organization that brings children from the Hell's Kitchen neighborhood together with professional theater artists to create original theater... and many other things! The Poetry In Performance program gives children of the Project a chance to express themselves in verse and then perform their poems before a live audience.

### Special Thanks

The poets wouldn't have made it to the stage without the help of these Poetry In Performance volunteers: Program Leader Nic Grelli and Poetry Performance Coaches Steven Hajar, Ginny Lee, Irene Sofia Lucio, Zoey Martinson, John Evans Reese, Christina Roussos, and Lindsay Torrey. We were honored to have guest poet Nehas-saiu DeGannes visit our class to share her work with the young poets. Finally, we'd like to thank the Cohen family and friends for their support of our Poetry in Performance Program.

### The Project Staff

Gus Rogerson ..... Artistic Director  
Carol Ochs.....Executive Director  
John Sheehy..... Director of Development and Marketing  
George Babiak..... Production Manager  
Liz Bell ..... Director of Education  
Megan Cramer.....Associate Artistic Director  
Ray Harold..... Technical Director  
Lisa Kerner ..... Development and Management Associate  
Johanna Vidal..... Community Coordinator  
Alyssa Anderson..... Manager of Individual Giving  
Chris Ceraso..... Teen Dean  
Olivia Strauss ..... Education Assistant  
Iris A. Brown ..... Graphic Designer  
Samantha Paduani ..... Poetry Class Teen Assistant  
Sarah Lusche and Deenah Shutzer ..... Interns

### The 52nd Street Project Board of Directors

Lisa Benavides	Carol Ochs
Rachel Chanoff	Willie Reale, founder
Cathy Dantchik, co-chair	Gus Rogerson
Carolyn DeSena	Shirley Rumierk, alumni member
Wendy Ettinger, chair emeritus	José Soto, Jr., alumni member
Louis P. Friedman, co-chair	Jenny Steingart
Robert Goldberg	Lisa Tilney
Stephen Graham, chair emeritus	Merritt Tilney
Valerie Kay	Wendy vanden Heuvel
Frances McDormand	John A. Vassilaros
Noël Mihalow	

The 52nd Street Project Presents  
The 2013 Lorraine Cohen

# Poetry in Performance Program

26 new poems by  
8 young poets

Monday, November 18, 2013  
6:00 p.m.

The Five Angels Theater  
The 52nd Street Project  
789 10th Avenue

# The Poems

**Shell Box**  
**Lonely Red**  
**Theatrical Heavens**  
Kayla Matos, age 12

**Wallet**  
**City**  
**Soldier**  
Derek Tineo, age 14

**Geese**  
**Kit Kat**  
**Perfect Turtle**  
**Wolf**  
Wilhelmina Ohene Kari Kari, age 11

**A Card**  
**Nature**  
**Aliens**  
Justin Bannister, age 12

**My Special Picture**  
**Caution**  
**Unicorn**  
**Alien**  
Alyssia Feliciano, age 12

**A Fearful Wolf**  
**A Death in Front of My Face**  
**What a Lovely Turtle**  
Timmy Miller, age 13

**Princess of War**  
**Person**  
**Old Lady**  
Sabrina Caldonia, age 12

**Sock Monkey**  
**Trash**  
**Adventure of a Fish**  
Maria Martinez, age 12

## **Lorraine Cohen** **1927-2005**

For more than forty years, Lorraine Cohen dedicated herself to all facets of the theater, including acting, directing and teaching. Her deeply memorable performances as Amanda in *The Glass Menagerie* and as Emily Dickinson in *The Belle of Amherst* were often compared favorably with the very well known actors who had played those roles before her. Those who knew her as a teacher, remember the amazing annual Shakespeare productions of her fifth graders and the many stunning performances of her high school students.

In the 1960's Laurie performed in a series of plays at the Bergen County Players in New Jersey including *Ring Around Elizabeth* (1960), *Fumed Oak* (1961), *Blithe Spirit* (1962), and *The Waltz of the Toreadors* (1961). In 1969 she performed in *No Bed of Roses* at the Showplace Summer Theatre. Laurie also spent many productive years at The New Dimension Theatre Studio in Englewood, New Jersey where Dr. Richard Imundo was the Artistic Director. At The New Dimension she taught acting to children and young adults, and also performed in many productions including *Animal* (1971), *The Glass Menagerie*, and *Uncle Vanya* (1970). She also directed and acted in many evenings of scenes at The New Dimension. One of her early students at The New Dimension was a young man by the name of John Travolta who also performed with her in *Who'll Save the Plowboy?* (1966).

Having obtained her college degree from Fairleigh Dickinson University in Teaneck, New Jersey, she performed in a series of plays produced by the University Players, including *Ghosts*, *The Glass Menagerie*, and *J.B.* While studying for her masters degree at Montclair State College, she performed in several productions there including *The Hostage*, *Plaza Suite*, and *Not Now Darling*. Laurie also performed in *Cinderella* at the William Paterson College Summer Theatre Workshop, and in 1984 she performed in *The Devil's Disciple* at the Williamstown Theatre Festival in Williamstown, Massachusetts.

In 1983 Laurie starred as Emily Dickinson in the one-woman show *The Belle of Amherst*, directed by her friend and colleague, John Brancato. *The Belle of Amherst* had a limited run at The Tyson Studio in New York City to rave reviews in *The New York Times* and *The Daily News*.

Though many encouraged Laurie to pursue a professional acting career, she always made it clear that her true love was teaching and she dedicated much of her life to filling young students' hearts and minds with the love of theatre, both in its literary form and as a performing art. During her tenure in the 1970's as a fifth grade teacher at the Longfellow School in Teaneck, New Jersey, she directed an annual Shakespeare play starring her fifth grade students, performing the likes of *Macbeth*, *Julius Caesar* and *Hamlet*. Laurie's love of theater and teaching reached its pinnacle during her many years teaching English and Drama at Teaneck High School in Teaneck, New Jersey. She truly loved teaching drama to high school students, introducing them to the joys of acting and play-writing, and she directed an enormous number of full length productions, musicals, scenes, and student-written original plays. She directed too many shows to list individually, but they included *Cabaret*, *Diary of Anne Frank*, *A Midsummer Night's Dream*, *The Crucible*, *The Man Who Came To Dinner*, *Don't Drink the Water* and *Waiting for Godot*. In addition to these productions, she directed the students in an annual Evening of Scenes. Her students won many awards for their work at the annual Bucks County Playhouse Drama Festivals in Pennsylvania. Even after retirement from teaching, she continued to direct performances at Leonia High School, in Leonia, New Jersey.

In addition to acting and teaching, Laurie also edited three books for the theatre: *Scenes for Young Actors*, *Monologues for Young Actors*, and *Scenes for Mature Actors*, all published by Avon Books. These three books continue to be used today in acting classes and auditions around the country.

Laurie is remembered lovingly by her five children, her three siblings, her eight grandchildren, her companion Dick, her many colleagues and friends, and her innumerable students. It is in her memory that they support the 52nd Street Project. It is what she would have wanted.



## **Lorraine Cohen** **1927-2005**

For more than forty years, Lorraine Cohen dedicated herself to all facets of the theater, including acting, directing and teaching. Her deeply memorable performances as Amanda in *The Glass Menagerie* and as Emily Dickinson in *The Belle of Amherst* were often compared favorably with the very well known actors who had played those roles before her. Those who knew her as a teacher, remember the amazing annual Shakespeare productions of her fifth graders and the many stunning performances of her high school students.

In the 1960's Laurie performed in a series of plays at the Bergen County Players in New Jersey including *Ring Around Elizabeth* (1960), *Fumed Oak* (1961), *Blithe Spirit* (1962), and *The Waltz of the Toreadors* (1961). In 1969 she performed in *No Bed of Roses* at the Showplace Summer Theatre. Laurie also spent many productive years at The New Dimension Theatre Studio in Englewood, New Jersey where Dr. Richard Imundo was the Artistic Director. At The New Dimension she taught acting to children and young adults, and also performed in many productions including *Animal* (1971), *The Glass Menagerie*, and *Uncle Vanya* (1970). She also directed and acted in many evenings of scenes at The New Dimension. One of her early students at The New Dimension was a young man by the name of John Travolta who also performed with her in *Who'll Save the Plowboy?* (1966).

Having obtained her college degree from Fairleigh Dickinson University in Teaneck, New Jersey, she performed in a series of plays produced by the University Players, including *Ghosts*, *The Glass Menagerie*, and *J.B.* While studying for her masters degree at Montclair State College, she performed in several productions there including *The Hostage*, *Plaza Suite*, and *Not Now Darling*. Laurie also performed in *Cinderella* at the William Paterson College Summer Theatre Workshop, and in 1984 she performed in *The Devil's Disciple* at the Williamstown Theatre Festival in Williamstown, Massachusetts.

In 1983 Laurie starred as Emily Dickinson in the one-woman show *The Belle of Amherst*, directed by her friend and colleague, John Brancato. *The Belle of Amherst* had a limited run at The Tyson Studio in New York City to rave reviews in *The New York Times* and *The Daily News*.

Though many encouraged Laurie to pursue a professional acting career, she always made it clear that her true love was teaching and she dedicated much of her life to filling young students' hearts and minds with the love of theatre, both in its literary form and as a performing art. During her tenure in the 1970's as a fifth grade teacher at the Longfellow School in Teaneck, New Jersey, she directed an annual Shakespeare play starring her fifth grade students, performing the likes of *Macbeth*, *Julius Caesar* and *Hamlet*. Laurie's love of theater and teaching reached its pinnacle during her many years teaching English and Drama at Teaneck High School in Teaneck, New Jersey. She truly loved teaching drama to high school students, introducing them to the joys of acting and play-writing, and she directed an enormous number of full length productions, musicals, scenes, and student-written original plays. She directed too many shows to list individually, but they included *Cabaret*, *Diary of Anne Frank*, *A Midsummer Night's Dream*, *The Crucible*, *The Man Who Came To Dinner*, *Don't Drink the Water* and *Waiting for Godot*. In addition to these productions, she directed the students in an annual Evening of Scenes. Her students won many awards for their work at the annual Bucks County Playhouse Drama Festivals in Pennsylvania. Even after retirement from teaching, she continued to direct performances at Leonia High School, in Leonia, New Jersey.

In addition to acting and teaching, Laurie also edited three books for the theatre: *Scenes for Young Actors*, *Monologues for Young Actors*, and *Scenes for Mature Actors*, all published by Avon Books. These three books continue to be used today in acting classes and auditions around the country.

Laurie is remembered lovingly by her five children, her three siblings, her eight grandchildren, her companion Dick, her many colleagues and friends, and her innumerable students. It is in her memory that they support the 52nd Street Project. It is what she would have wanted.



DON'T MISS OUR NEXT SHOW:

# APPLES

and

# ORANGES



THE INCOMPARABLE PLAYS

THE 52ND STREET PROJECT'S  
FALL PLAYMAKING PLAYS

DEC. 5-8, 2013

RIGHT HERE AT FIVE ANGELS THEATER

A portrait of Jonathan Groff, a young man with brown hair, wearing a grey suit jacket, a light-colored striped shirt, and a dark tie. He is looking directly at the camera with a neutral expression. Surrounding his head are several colorful, hand-drawn icons: a green number '2', an orange circle with three dots, a red crescent moon, a green lightning bolt, a yellow cassette tape, a blue microphone, a blue television set with red lightning bolts, and a blue musical note. A blue line connects these icons in a circular path around his head.

# GET BACK

A BENEFIT CONCERT WITH  
JONATHAN GROFF

For The 52nd Street Project  
Sunday, November 24, 2013  
Five Angels Theater

## The 52nd Street Project Board of Directors

Lisa Benavides  
Rachel Chanoff  
Cathy Dantchik, co-chair  
Carolyn DeSena  
Wendy Ettinger, chair emeritus  
Louis P. Friedman, co-chair  
Robert Goldberg  
Stephen Graham, chair emeritus  
Valerie Kay  
Frances McDormand  
Noël Mihalow  
Carol Ochs  
Willie Reale, founder  
Gus Rogerson  
Shirley Rumierk, alumni member  
José Soto, Jr., alumni member  
Jenny Steingart  
Lisa Tilney  
Merritt Tilney  
Wendy vanden Heuvel  
John A. Vassilaros

## The 52nd Street Project Staff

Carol Ochs, Executive Director  
Gus Rogerson, Artistic Director  
Megan Cramer, Associate Artistic Director  
John Sheehy, Director of Development & Marketing  
Alyssa Anderson, Manager of Individual Giving  
Lisa Kerner, Development and Management Associate  
Liz Bell, Director of Education  
George Babiak, Production Manager  
Ray Harold, Technical Director  
Johanna Vidal, Community Coordinator  
Olivia Strauss, Education Assistant  
Sarah Lusche, Deenah Shutzer, Interns



**Broadway's  
Supper Club**

254 West 54th St. Cellar  
New York, NY 10019

[www.52below.com](http://www.52below.com)

54 Below, Broadway's Supper Club, offers an unforgettable New York nightlife experience, combining performances by Broadway's best with world class dining in an elegant setting. 54 Below has become Broadway's living room; a home away from home for Broadway professionals and audiences alike. And with pre-theatre dinner offered nightly from 5pm, 54 Below has set a new culinary standard for New York City entertainment venues.

**Wine for tonight's event has been graciously donated by:**



**155 Varick Street • (212) 608-0555 • [www.citywinery.com](http://www.citywinery.com)**

City Winery was created by Michael Dorf, founder of the iconic music venue, The Knitting Factory, to be a comfortable place to experience fine wine, enjoy great food, and see world-class live music in a sit-down, intimate setting. City Winery New York opened in 2008 and quickly established itself as one of the “best places to see live music in New York” (New York Times), as well as a unique, functioning urban winery making high quality wine. Success in New York led to opening a second location in Chicago in 2012, with venues in Napa and Nashville scheduled to open in 2014. City Winery connects a sophisticated audience who loves both music and wine with a memorable experience.

## Get In Seats

George W. Ahl, III  
Dean Beals  
Judy Birnbaum  
Stephania Bortolami  
Robert Burger  
Andrew Carrillo  
Rachel Chanoff  
Ann & Jeff Cramer  
Ruby Chua  
Katie Clark  
Cosmo De Bari  
Ruth Dewey  
Stefanie Febus  
Kara Fischer  
Karen Freitas  
Jaclyn Gerowski  
David Gewirtzman  
Samantha Goldberg  
Celia Keenan-Bolger  
Leah Kim  
Frances Langbecker  
Elmarisa Liz  
Lois & Dr. Jerome Lowenstein  
Anne Marcus  
Kathlene Medina  
Rick Meese  
Carissa Mirra  
Christopher Randolph  
Esperanza Rodriguez  
Joseph Rokacz & Larry Gordon  
Mary Louise Rubin  
Laura Sametz & Anton Fig  
Lindsay Schulz  
Robert Shore  
Ray Smith  
Amelia Spitler  
Victor Syrmis  
Joseph Tassone  
Emily Whyte  
Wayman Wong

Carol Ochs,  
Executive Director

Cathy Dantchik, Louis Friedman,  
Board Co-Chairs

Gus Rogerson,  
Artistic Director

# GET BACK

A Benefit Concert with Jonathan Groff

Sunday, November 24, 2013

7:00 p.m.

Five Angels Theater

## Performers

Jonathan Groff

with

Hunter Bell, Susan Blackwell, Heidi Blickenstaff, & Jeff Bowen

of *Now. Here. This.*,

Imani Lewis (age 13), Laura Osnes

## The Musicians

Mary-Mitchell Campbell, Music Director and Keyboard

Jim Hershman, Guitar

Jay Mack, Drums

Larry Pressgrove, Music Director and Keyboard for *Now. Here. This.*

## Lighting Designer

Josh Langman

## Stage Manager

Anne Lowrie

## Sound Designer

Betsy Rhodes

## Special Thanks

Iris A. Brown

City Winery

## Set and Prop Design

Jay Duckworth

William Curran, A Curran Affair

Noël Mihalow

The Public Theater

Kim D. Sherman

## Projections

George Babiak



The 52nd Street Project is a not-for-profit theater company dedicated to the children living in the Hell's Kitchen (Clinton) neighborhood in Manhattan. Founded in 1981 by actor/playwright and 1994 MacArthur Fellow Willie Reale, the Project is an after-school, arts-in-education program that brings kids together with professional theater artists to create original theater through unique mentoring relationships. The Project's deeper purpose is to improve the literacy, sense of self-worth and appreciation for the arts of New York's inner-city children by tapping into their creativity and powers of imagination. Founded in response to a deepening and persistent need to improve the quality of life for New York's children, the Project has produced more than 1,000 plays involving over 1,500 children and theater artists.

The 52nd Street Project is providing kids with one thing all of them need - individual attention. In all classes and programs, the kids are encouraged to draw upon their own experiences, thus creating avenues for self-expression. By furnishing them with thoughtful assistance, as well as a stage and an audience, the kids flourish in the glow of public validation. What they gain is self-esteem, and addiction to success, increased confidence in their literary skills, and perhaps most importantly, a place to belong.

## JoJo Seats

Wendell (Hob) Bryan

Cathy Dantchik

Leslie Dantchik

Angelina Fiordellisi & Matt Williams

Patrice & Louis Friedman

Freddie Gershon

Bob Goldberg

Vicki Gross & Jonathan Levine

Valerie Kay & Bruce Graham

Michael Lawrence

Nicole Pellicciotto

## Sweet Loretta Seats

Gavin Berger

Ted Chapin

Alexandra Garrison

Jenny Gersten & Willie Reale

Kathryn Henderson

Sarah Horowitz

Louise Klebanoff

James Lisante

Carol Ochs

Phillip Odom

Susan Pourfar

Karin & Tom Schall

Amanda Steckler

Alexandra Vassilaros

I. Weiss, Inc.



The 52nd Street Project gratefully acknowledges the support of the following foundations and corporations: Bloomberg; Brenner Family Foundation; Cantor Fitzgerald; CBS Corporation; The Common Sense Fund; Consolidated Edison; Dawkins Family Foundation; The Neil V. DeSena Foundation; The Dramatists Guild Fund; Dramatists Play Service; The Educational Foundation Of America; Sidney E. Frank Foundation; Goldman Sachs; The Horace W. Goldsmith Foundation; Heisman Foundation; Hudson Scenic Studio; Lotos Foundation; Ann M. Martin Foundation; Marusi Family Foundation; Monteforte Foundation; Newman's Own; The PAR Group; Pinkerton Foundation; Quadra Productions; Sesame Workshop; The Shubert Organization; Simon & Eisenberg; Starker Family Foundation; Harold & Mimi Steinberg Charitable Trust; Surdna Foundation; Susquehanna Investment Group; Tax Pro Financial Network, Inc.; TCG; Theater Subdistrict Council; Tiger Baron Foundation; Van Deusen Family Fund; Vervane Foundation; Watkins, Inc.; WMEE Foundation; Yorke Construction Corp.

Robert Abrams & Cynthia Vance	Penelope Collins Judith-Ann Corrente	Sarah Horowitz & David Venarde	Sue Phillips Todd Poisson
George Ackert	Janet Coviello	Andrea Johnson	Suzanne Poulin
Michael Alicastro	William Crudup	Beth Ifcher	Helaine & Michael Pruzan
Elton Andrews	Kyle Czepiel	Carine Joannou	Christopher Randolph
Richard Anthony	Arthur Dantchik	Kristen Johanson	Helen & Peter Randolph
Cecilia Arana	Cathy Dantchik	Andrea Johnson	Jacquelyn Reingold
Emily Armstrong	Leslie Dantchik	Cindy Kaplan & David Froelich	Anita A. Rogerson
James Armstrong	Peter & Judith Dawkins	Valerie Kay & Bruce Graham	David Ross & Laura Ross
Dominick & Ilene Balletta	Carolyn & Neil DeSena	Louise Klebanoff	Dr. Steve Rudin
Becky Ann & Dylan Baker	Rebecca & Richard Dresser	Henry Krieger & Robert Joy	Laura Sametz & Anton Fig
Ken Bantum	Peter Doyle	Jacki Ochs & Jan Kroeze	Karin & Thomas Schall
Carolyn Bechtel	Max Dyksterhouse & David Roady	Judy Kuhn & David Schwab	Maury Schott
Lisa Benavides & Tim Blake Nelson	Doug Eisenberg	Frances & Fred Langbecker	Susan Schroeder & Britt Adams
Louisa Benton	Lynn Ellenberg	Gabrielle Lansner & Dean Taucher	Whitney Scott & Peter Jacobson
Gavin Berger & Craig Berggren	Nora Ephron & Nicholas Pileggi	Brian Lapin	Meg Simon
Stephanie Berger & Paul King	Peter Jay Fernandez	Michael Lawrence & Glen Gillen	Christopher Solomon
Beth & Eric Berman	& Denise Burse Fernandez	Warren Leight & Karen Hauser	Jonathan Soros & Jennifer Soros
David Beth	Liz Flahive & Jeff Cox	Mickey Lemle	Jenny & Jon Steingart
Lewis Black	Wendy Flanagan & Chris O'Malley	Jonathan Levine	Tracy Straus
Emily Blavatnik	Karen & Paul Freitas	Helen Levy	Danny Strong
Allison Blinken	Sally Froelich	Melissa Liebling-Goldberg & John Barrett	Al Styron & Ed Beason
Noah Bogan	Alexandra Garrison	Kay M. Lim	Susanna Styron
Jane Bolster & Steve Wertimer	Beverly Gasner	Adrienne Lobel	Richard Sweren
Buzz Bovshow	Rose Gasner & Larry Chertoff	John Lynch	Lili Taylor
Blaise R. Box	Celia Gerard & Mark McGrath	Grace Lyu-Volckhausen	Lisa Tilney & Chris Lawrence
Becky Browder & Ted Neustadt	Christina Gerber	Julie & Alex Margolies	Merritt Tilney & Douglas Kaden
Carlton T. Brown	Freddie & Myrna Gershon	Ali Marsh	Lorraine Tobias & Alex Draper
Iris A. Brown & Joe White	Jenny Gersten & Willie Reale	Lin Manuel Miranda	Liz Tuccillo
Justin Brownhill	Alexandra Gersten-Vassilaros & John Vassilaros	Frances McDormand & Joel Coen	Laura Valeroso & David Seidman
Brian Byrnes	Scott Aaron Gewirtz	Emily & John Morgan	Wendy vanden Heuvel & Brad Coley
Shawn & Laura Byron	& Laura Gewirtz	Amanda & Neal Moszkowski	Susan J. Vitucci
Joseph Capozzi	Elizabeth Giamatti	Suzen Murakoshi & Mark Temme	Mary Pat Walsh
Leah Carr	Robert Goldberg & Betsy MacIsaac	Fred Nelson	Dr. Mildred Walton
Lawrence Catena	Stephen & Cathy Graham	Randy & Rona Nelson	Brenda Wehle & John C. Lynch
Chris Ceraso	Jan Gura & Alan Pickman	Ruth Nelson	Carol Whitesides
Rachel Chanoff	Susan Hanson	Lori O'Connor	Zee Wiener
Todd Christie	Jessica Hecht	Carol Ochs & Bruce MacVittie	Ruth Ann Wynter
Damien Clancy	& Adam Bernstein	Jacki Ochs & Jan Kroeze	J.P. Xenakis
Matthew Clancy	Kathy & Jamie Herring	Kevin O'Rourke & Edith Thurber	Carole Yass
Katie Clark	Peter Herdrich & Karen Trott	Jane Perlmutter	Yildiz Yuksek & Richard Blackstone
Elizabeth Clemants	William Holtzman	& Greg MacPherson	Connie & Marc Zand
David Cohen & Sandra Novak Cohen	Mary Horowitz	Elizabeth Peters	
Larry Cohen			



10 new plays written by kids  
and performed by adult actors

Thursday, Dec. 5 at 7:30 p.m.

Friday, Dec. 6 at 7:30 p.m.

Saturday, Dec. 7 at 7:30 p.m.

Sunday, Dec. 8 at 3:00 p.m.

THE FIVE ANGELS THEATER

# APPLES & ORANGES: THE INCOMPARABLE PLAYS

Fall Playmaking 2013 - Dec. 5-8, Five Angels Theater

## The 52nd Street Project Staff

Gus Rogerson, Artistic Director  
 Megan Cramer, Associate Artistic Director  
 George Babiak, Production Manager  
 Ray Harold, Technical Director  
 Carol Ochs, Executive Director  
 Lisa Kerner, Devt. & Mgmt. Associate  
 John Sheehy, Dir. of Development & Marketing  
 Alyssa Anderson, Mgr. of Individual Giving  
 Liz Bell, Director of Education  
 Johanna Vidal, Community Coordinator  
 Olivia Strauss, Education Assistant

### Consultants:

Iris A. Brown, Graphic Designer; Chris Ceraso, Teen Dean

### Interns:

Sarah Lusche, Deenah Shutzer

### Teen Employees:

Receptionists: Joyce Cheung, Gabriella DeJesus, Alvin Garcia, Daquan Nelson, Alizette Zapata  
 Ushers: Mari Ulloa, Britney Trinidad, Chanel Rodney, Maximo Jimenez

## "Apples & Oranges" Production Staff

Composer/Music Director Patrick Barnes	Backstage Crew Lincoln Bernard, Jasmine Correa,
Set Designer Kevin Joseph Roach	Caroline Hadilaksono, Sarah Lusche, Charlie O'Rourke, Deenah Shutzer
Lighting Designer Greg MacPherson	House Managers Liz Bell, Lisa Kerner
Costume Designers Crystal Thompson, Ciera Wells	Flyer Art Iris A. Brown
Costume Assistant Kimberly Goings	Chefs Iris A. Brown, Joe White, Walker White, Liz Bell, Carol Ochs
Sound Designer Betsy Rhodes	Playmaking Class Volunteers Alyssa Anderson, Mick Daily, Mariam Habib, Tim J. Lord, Yusef Miller, Max Posner, David Ross, Diana Stahl
Stage Manager Kaleigh Bernier	Playmaking Class Teen Assistant Michael Bannister
Projection Design: George Babiak, Julie Sharbutt, and the Project Slide Archive	Production Photographer Winston Rodney
Prop Design Team George Babiak, Caroline Hadilaksono, Olivia Strauss, Sarah Lusche, Deenah Shutzer, Johanna Vidal	



The Playback Program is made possible with funds from the Ann Martin Foundation, New- man's Own Foundation, and public funds from The New York State Council on the Arts, a state agency, and the New York City Department of Cultural Affairs. The 52nd Street Project is a member of Art/NY.

## COOL STUFF ON SALE IN THE LOBBY!

Fabulous Flyer Bars ..... \$2.50

and featuring Shel Silverstein's  
 "Fivey and Twoey" logo:

Project T-shirts ..... \$12.00  
 Project Hoodies ..... \$30.00  
 Project Caps ..... \$20.00  
 Project Mugs ..... \$5.00  
 Project Pencil 3-pack ..... \$1.00  
 Project Notebook ..... \$5.00

Thank you for coming to **APPLES & ORANGES**. If you are not on our mailing list (or if your address has changed), please fill out this form and give it to us on your way out or mail it to the address below. We would also like to know if you are interested in becoming a volunteer. We need help in all areas, so be sure to fill out the entire form.

### PLEASE ADD ME TO YOUR MAILING LIST:

12/13

NAME \_\_\_\_\_

ADDRESS \_\_\_\_\_

CITY \_\_\_\_\_

STATE \_\_\_\_\_

ZIP \_\_\_\_\_

HOME PHONE \_\_\_\_\_

DAYTIME OR MOBILE PHONE \_\_\_\_\_

E-MAIL ADDRESS \_\_\_\_\_

MY OCCUPATION \_\_\_\_\_

MY HOBBIES \_\_\_\_\_

### YES, I WOULD LIKE TO BE OF HELP. I CAN:

- |   |  |  |
|---|--|--|
| <input type="checkbox"/> Draw and/or paint            | <input type="checkbox"/> Help kids with homework | <input type="checkbox"/> Design and sew costumes |
| <input type="checkbox"/> Hang lights                  | <input type="checkbox"/> Help with mailings      | <input type="checkbox"/> Teach kids a skill      |
| <input type="checkbox"/> Work on a backstage crew     | <input type="checkbox"/> Do office work          | <input type="checkbox"/> Be a chef at an event   |
| <input type="checkbox"/> Do graphic design            | <input type="checkbox"/> Design sound            |  |
| <input type="checkbox"/> Other (please specify) _____ |  |  |

### MY SCHEDULE IS:

- Very flexible. I'm often available during weekdays.  
 Somewhat flexible. I can help on the occasional morning or afternoon during the week.  
 Not very flexible at all, but I've got some free time on evenings and weekends.

If you would like to mail this (and you're always welcome to enclose a tax-deductible contribution), you can send it to: The 52nd Street Project, 789 10th Ave., New York, NY 10019. Or fax it to (212) 333-5598.

COMING UP NEXT!

# BY DEGREES



# 6 PLAYS OF SEPARATION

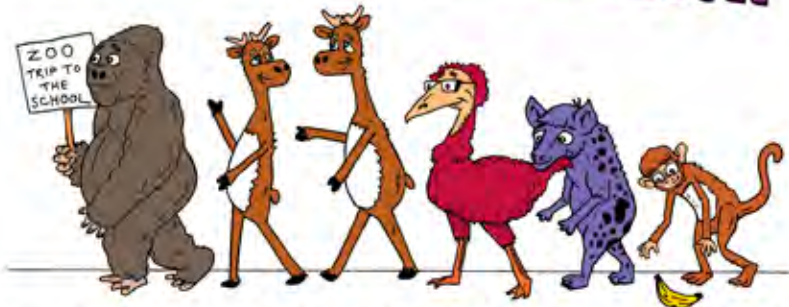

## THE 2014 TWO-ON-TWO'S

6 PLAYS • 6 ADULT PLAYWRIGHTS • 6 ADULT DIRECTORS • 12 KID ACTORS  
FRIDAY, JAN. 31 - SUNDAY, FEB. 2  
RIGHT HERE AT THE FIVE ANGELS THEATER



**BE ON THE LOOKOUT!**  
WE ARE ALWAYS  
SEARCHING FOR INTERNS.

If you know of any college or graduate students who might enjoy working with us, playing with us, and going on trips with us for a semester, please have them contact Lisa Kerner. We are currently looking for interns for the Spring and Summer of 2014. Thanks!

## The 52nd Street Project Board of Directors

Lisa Benavides	Carol Ochs
Rachel Chanoff	Willie Reale, founder
Cathy Dantchik, co-chair	Gus Rogerson
Carolyn DeSena	Shirley Rumierk, alumni member
Wendy Ettinger, chair emeritus	José Soto, Jr., alumni member
Louis P. Friedman, co-chair	Jenny Steingart
Robert Goldberg	Lisa Tilney
Stephen Graham, chair emeritus	Merritt Tilney
Valerie Kay	Wendy vanden Heuvel
Frances McDormand	John A. Vassilaros
Noël Mihalow	

## What's Going On Here?

The 52nd Street Project is a non-profit organization that brings children from the Hell's Kitchen neighborhood together with professional theater artists to create original theater. *APPLES & ORANGES* is a production of our Playmaking program. Young people participate in a nine-week playwriting course taught by Megan Cramer and adapted for the Project by Daniel Judah Sklar from his book *Playmaking: Children Writing and Performing Their Own Plays*. At the end of the course, each child is matched with two actors and a dramaturg/director who guides him or her through the writing of a play during a weekend retreat in the country (Stone Ridge, NY, for this show). This performance is the end result.

## In-Kind Contributions

Abbeville Press; ABC Kitchen; Stephanie Berger Photography; Lewis Black; Iris A. Brown Design; William Curran & A Curran Affair; Michael Dorf & City Winery; Commonwealth Proper; Emmett Global; Ferragamo Timepieces; Fried and Kowgios Partners; Hudson Scenic; ICI; JetBlue; Paul, Weiss, Rifkind, Wharton & Garrison LLP; Pharma Print; Sesame Workshop; Showtime; Wendy Stuhlberg; Tao Group; Uber; John A. Vassilaros; Watkins, Inc.; and Wynn Resorts.

## Special Thanks

We're extremely grateful to Steve Gorn & Barbara Bash for the use of their beautiful home in Stone Ridge, NY as our base of operations for the writer's retreat. Also thanks to Michael & Corinne Cohn, David Curtis & Ann Morris, Sean Cullen & Tess Hartman, Nina Shengold, and Amanda van Doorene & Edward Boria for housing our kids; and Deborah Freedman & Bill Woods, Charlie Miles & Naomi Freundlich, and Jeff Madalena & Jason Gnewikow for housing our adults. Last, but not least, thanks to Iris Brown, Joe White & Walker White for the amazing food!

# APPLES & ORANGES: ACT 1

All original music composed by Patrick Barnes

## ROUGH ICE

Written by Tiffany Miller, age 11

Director/Dramaturge: Kathleen Wise Costume Designer: Ciera Wells

Samantha ..... Lauren Blumenfeld

Chris ..... Ben Mehl

TV Announcer ..... Charlie O'Rourke

*Why* lyrics by Tiffany Miller

## RIVALS REBORN

Written by Joshua Gomez, age 11

Director/Dramaturge: Rick Meese Costume Designer: Ciera Wells

Mittens the Cat ..... Farah Bala

Dudley the Dog ..... Genesis Oliver

Dad ..... Charlie O'Rourke

*Family and Biscuits* lyrics by Joshua Gomez

## THE TWO OPPOSITES

Written by Ahmed Musa, age 11

Director/Dramaturge: Michael Walkup Costume Designer: Ciera Wells

Nicholas ..... Matthew Saldivar

Basketball Head ..... Frank Wood

Coach ..... George Babiak

Some Kids ..... The Crew

*Believe Me* lyrics by Ahmed Musa

## GRANDMAS THESE DAYS

Written by Kayla Ortiz, age 12

Director/Dramaturge: Leslie Kramer Costume Designer: Ciera Wells

Kat ..... Clea Alsip

Grandma ..... Lisa Benavides-Nelson

Staff Members ..... The Crew

*You Ruin Everything* lyrics by Kayla Ortiz

## CLASSY

Written by Adam Alkindi, age 12

Director/Dramaturge: John Sheehy Costume Designer: Ciera Wells

Michele ..... Bree Elrod

James ..... Carson Elrod

Boy ..... Charlie O'Rourke

Driver ..... Lincoln Bernard

*Forgive* lyrics by Adam Alkindi

# APPLES & ORANGES: ACT 2

## HOW TO BE FRIENDS THEN ENEMIES

Written by Dimitri Smallwood, age 10

Dramaturge: Sarah Lusche; Director: Megan Cramer

Costume Designer: Crystal Thompson

Piano ..... Will Rogers

Violin ..... Debargo Sanyal

*Learn How to Not Break My String and Friends that Became Enemies at First Become Friends* lyrics by Dimitri Smallwood

## THE CONTEST

Written by Emily Roman, age 11

Director/Dramaturge: Colette Robert Costume Designer: Ciera Wells

Pamila Greenmen ..... Carra Patterson

Jennifer Arooso ..... Natalie Paul

Customer ..... Jasmine Correa

Announcer ..... Charlie O'Rourke

Judge ..... John Sheehy

Models ..... Deenah Shutzer, Sarah Lusche

## COOKIES N MILK

Written by Dariana Lugo-Vargas, age 11

Director/Dramaturge: Danielle Mindess Costume Designer: Crystal Thompson

Cookie ..... Pun Bandhu

Milk ..... Sarah Nina Hayon

*Best Friends 4 Ever* lyrics by Dariana Lugo-Vargas

## THE COOL AND THE RECKLESS

Written by Raymond Alameda, age 12

Director/Dramaturge: Jordan Mahome Costume Designer: Ciera Wells

Brandon ..... Christopher Randolph

Alex ..... Stephen Tyrone Williams

Actress ..... Sarah Lusche

*Words Hurt the Heart* lyrics by Raymond Alameda

## THE RICH AND THE HUNTER

Written by Kaylee Zambrano, age 10

Director/Dramaturge: Don Nguyen Costume Designer: Ciera Wells

Leslye ..... Emma Galvin

Kady ..... Grace Rex

Siri ..... Megan Cramer

*Friendship* lyrics by Kaylee Zambrano



# SHOW PROGRAMS 2014

The 52nd Street Project gratefully acknowledges the support of the following foundations and corporations: Bloomberg; Brenner Family Foundation; Cantor Fitzgerald; CBS Corporation; The Common Sense Fund; Consolidated Edison; Dawkins Family Foundation; The Neil V. DeSena Foundation; The Dramatists Guild Fund; Dramatists Play Service; The Educational Foundation Of America; Sidney E. Frank Foundation; Goldman Sachs; The Horace W. Goldsmith Foundation; Heisman Foundation; Hudson Scenic Studio; Lotos Foundation; Ann M. Martin Foundation; Marusi Family Foundation; Monteforte Foundation; Newman's Own; The PAR Group; Pinkerton Foundation; Quadra Productions; Sesame Workshop; The Shubert Organization; Simon & Eisenberg; Starker Family Foundation; Harold & Mimi Steinberg Charitable Trust; Surdna Foundation; Susquehanna Investment Group; Tax Pro Financial Network, Inc.; TCG; Theater Subdistrict Council; Tiger Baron Foundation; Van Deusen Family Fund; Vervane Foundation; Watkins, Inc.; WMEE Foundation; Yorke Construction Corp.

Robert Abrams  
& Cynthia Vance  
George Ackert  
Michael Alicastro  
Elton Andrews  
Richard Anthony  
Cecilia Arana  
Emily Armstrong  
James Armstrong  
Dominick & Ilene Balletta  
Becky Ann & Dylan Baker  
Ken Bantum  
Carolyn Bechtel  
Lisa Benavides  
& Tim Blake Nelson  
Louisa Benton  
Gavin Berger  
& Craig Berggren  
Stephanie Berger & Paul King  
Beth & Eric Berman  
David Beth  
Lewis Black  
Emily Blavatnik  
Allison Blinken  
Noah Bogan  
Jane Bolster  
& Steve Wertimer  
Buzz Bovshow  
Blaise R. Box  
Becky Browder  
& Ted Neustadt  
Carlton T. Brown  
Iris A. Brown & Joe White  
Justin Brownhill  
Brian Byrnes  
Shawn & Laura Byron  
Joseph Capozzi  
Leah Carr  
Lawrence Catena  
Chris Ceraso  
Rachel Chanoff  
Todd Christie  
Damien Clancy  
Matthew Clancy  
Katie Clark  
Elizabeth Clemants  
David Cohen  
& Sandra Novak Cohen  
Larry Cohen

Penelope Collins  
Judith-Ann Corrente  
Janet Coviello  
William Crudup  
Kyle Czepiel  
Arthur Dantchik  
Cathy Dantchik  
Leslie Dantchik  
Peter & Judith Dawkins  
Carolyn & Neil DeSena  
Rebecca & Richard Dresser  
Peter Doyle  
Max Dyksterhouse  
& David Roady  
Doug Eisenberg  
Lynn Ellenberg  
Nora Ephron  
& Nicholas Pileggi  
Peter Jay Fernandez  
& Denise Burse Fernandez  
Liz Flahive & Jeff Cox  
Wendy Flanagan  
& Chris O'Malley  
Karen & Paul Freitas  
Sally Froelich  
Alexandra Garrison  
Beverly Gasner  
Rose Gasner & Larry Chertoff  
Celia Gerard & Mark McGrath  
Christina Gerber  
Freddie & Myrna Gershon  
Jenny Gersten & Willie Reale  
Alexandra Gersten-Vassilaros  
& John Vassilaros  
Scott Aaron Gewirtz  
& Laura Gewirtz  
Elizabeth Giamatti  
Robert Goldberg  
& Betsy MacIsaac  
Stephen & Cathy Graham  
Jan Gura & Alan Pickman  
Susan Hanson  
Jessica Hecht  
& Adam Bernstein  
Kathy & Jamie Herring  
Peter Herdrich & Karen Trott  
William Holtzman  
& S. Sylvia Shepard  
Mary Horowitz

Sarah Horowitz  
& David Venarde  
Andrea Johnson  
Beth Ifcher  
Carine Joannou  
Kristen Johanson  
Andrea Johnson  
Cindy Kaplan & David Froelich  
Valerie Kay & Bruce Graham  
Louise Klebanoff  
Henry Krieger & Robert Joy  
Jacki Ochs & Jan Kroeze  
Judy Kuhn & David Schwab  
Frances & Fred Langbecker  
Gabrielle Lansner  
& Dean Taucher  
Brian Lapin  
Michael Lawrence  
& Glen Gillen  
Warren Leight & Karen Hauser  
Mickey Lemle  
Jonathan Levine  
Helen Levy  
Melissa Liebling-Goldberg  
& John Barrett  
Kay M. Lim  
Adrienne Lobel  
John Lynch  
Grace Lyu-Volckhausen  
Julie & Alex Margolies  
Ali Marsh  
Lin Manuel Miranda  
Frances McDormand  
& Joel Coen  
Emily & John Morgan  
Amanda & Neal Moszkowski  
Suzen Murakoshi  
& Mark Temme  
Fred Nelson  
Randy & Rona Nelson  
Ruth Nelson  
Lori O'Connor  
Carol Ochs & Bruce MacVittie  
Jacki Ochs & Jan Kroeze  
Kevin O'Rourke  
& Edith Thurber  
Jane Perlmutter  
& Greg MacPherson  
Elizabeth Peters

Sue Phillips  
Todd Poisson  
Suzanne Poulin  
Helaine & Michael Pruzan  
Christopher Randolph  
Helen & Peter Randolph  
Jacquelyn Reingold  
Anita A. Rogerson  
David Ross & Laura Ross  
Dr. Steve Rudin  
Laura Sametz & Anton Fig  
Karin & Thomas Schall  
Maury Schott  
Susan Schroeder  
& Britt Adams  
Whitney Scott  
& Peter Jacobson  
Meg Simon  
Christopher Solomon  
Jonathan Soros  
& Jennifer Soros  
Jenny & Jon Steingart  
Tracy Straus  
Danny Strong  
Al Styron & Ed Beason  
Susanna Styron  
Richard Sweren  
Lili Taylor  
Lisa Tilney & Chris Lawrence  
Merritt Tilney & Douglas Kaden  
Lorraine Tobias & Alex Draper  
Liz Tuccillo  
Laura Valeroso  
& David Seidman  
Wendy vanden Heuvel  
& Brad Coley  
Susan J. Vitucci  
Mary Pat Walsh  
Dr. Mildred Walton  
Brenda Wehle & John C. Lynch  
Carol Whitesides  
Zee Wiener  
Ruth Ann Wynter  
J.P. Xenakis  
Carole Yass  
Yildiz Yuksek  
& Richard Blackstone  
Connie & Marc Zand

THE 52ND STREET PROJECT PRESENTS

# BY DEGREES

ART BY PATRICK JONES



# 6 PLAYS OF SEPARATION

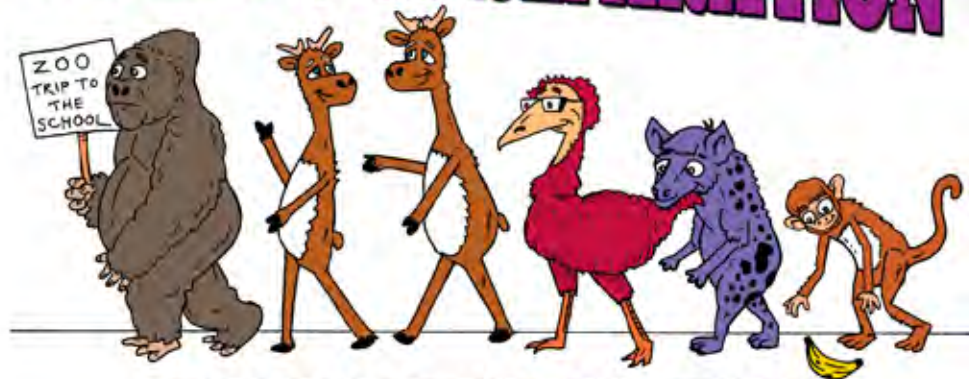

## THE 2014 TWO-ON-TWO'S

**6 NEW PLAYS • 6 ADULT WRITERS  
6 ADULT DIRECTORS • 12 KID ACTORS**

**Friday, Jan. 31 at 7:30 p.m.  
Saturday, Feb. 1 at 7:30 p.m.  
Sunday, Feb. 2 at 3:00 p.m.**

**Five Angels Theater  
at The 52nd Street Project**

# BY DEGREES: SIX PLAYS OF SEPARATION

The 2014 Two-on-Twos - Jan. 31-Feb. 2, Five Angels Theater

## The 52nd Street Project Staff

Gus Rogerson, Artistic Director  
Megan Cramer, Associate Artistic Director  
George Babiak, Production Manager  
Ray Harold, Technical Director

Carol Ochs, Executive Director  
Lisa Kerner, Devt. & Mgmt. Associate  
John Sheehy, Dir. of Development & Marketing  
Alyssa Anderson, Mgr. of Individual Giving

Liz Bell, Director of Education  
Johanna Vidal, Community Coordinator  
Olivia Strauss, Education Assistant

### Consultants:

Iris A. Brown, Graphic Designer; Chris Ceraso, Teen Dean

### Interns:

Hannah Allen, Courtney Kupferschmidt, Michelle Nguyen, Lindsay Olson

### Teen Employees:

Receptionists: Gabriella DeJesus, Haley Martinez, Britney Trinidad, Alizette Zapata  
Ushers: Samantha Caldon, Nick Carrero, Maximo Jimenez, Nathaly Trinidad

## "BY DEGREES" Production Staff

### Composer/Music Director

Robert Cowie

### Set Designer

Kevin Joseph Roach

### Lighting Designer

Greg McPherson

### Costume Designer

Kimberly Goings

### Sound Designer

Jason Cawley

### Soundboard Operator

Michelle Nguyen

### Stage Manager

Lisa Iacucci

### Projection Design:

George Babiak, Max Posner,  
and the Project Slide Archive

### Prop Fabrication Team

George Babiak,  
Courtney Kupferschmidt,  
Michelle Nguyen, Julie Sharbutt

### Backstage Crew

Hannah Allen, A.J. Welsh,  
Courtney Kupferschmidt,  
Lindsay Olson, Edelys Guerrero

### Chefs

John Sheehy, Liz Bell,  
Carol Ochs

### Hosts in Nyack

Deborah Adamy, Polly King and  
John-Paul Newport, Susanna Styron,  
and Wendy vanden Heuvel



The Playmaking Program is made possible with funds from the Ann Martin Foundation, Newman's Own Foundation, and public funds from The New York State Council on the Arts, a state agency, and the New York City Department of Cultural Affairs. The 52nd Street Project is a member of Art/NY.

## COOL STUFF ON SALE IN THE LOBBY!

Fabulous Flyer Bars ..... \$2.50

and featuring Shel Silverstein's  
"Fivey and Twoey" logo:

Project T-shirts ..... \$12.00  
Project Hoodies ..... \$30.00  
Project Caps ..... \$20.00  
Project Mugs ..... \$5.00  
Project Pencil 3-pack ..... \$1.00  
Project Notebook ..... \$5.00

Thank you for coming to **BY DEGREES**. If you are not on our mailing list (or if your address has changed), please fill out this form and give it to us on your way out or mail it to the address below. We would also like to know if you are interested in becoming a volunteer. We need help in all areas, so be sure to fill out the entire form.

### PLEASE ADD ME TO YOUR MAILING LIST:

1/14

NAME \_\_\_\_\_

ADDRESS \_\_\_\_\_

CITY \_\_\_\_\_

STATE \_\_\_\_\_

ZIP \_\_\_\_\_

HOME PHONE \_\_\_\_\_

DAYTIME OR MOBILE PHONE \_\_\_\_\_

E-MAIL ADDRESS \_\_\_\_\_

MY OCCUPATION \_\_\_\_\_

MY HOBBIES \_\_\_\_\_

### YES, I WOULD LIKE TO BE OF HELP. I CAN:

- |   |  |  |
|---|--|--|
| <input type="checkbox"/> Draw and/or paint            | <input type="checkbox"/> Help kids with homework | <input type="checkbox"/> Be a chef at an event   |
| <input type="checkbox"/> Help with mailings           | <input type="checkbox"/> Teach kids a skill      | <input type="checkbox"/> Do graphic design       |
| <input type="checkbox"/> Work on a backstage crew     | <input type="checkbox"/> Design sound            | <input type="checkbox"/> Design and sew costumes |
| <input type="checkbox"/> Other (please specify) _____ |  |  |

### MY SCHEDULE IS:

- Very flexible. I'm often available during weekdays.  
 Somewhat flexible. I can help on the occasional morning or afternoon during the week.  
 Not very flexible at all, but I've got some free time on evenings and weekends.

If you would like to mail this (and you're always welcome to enclose a tax-deductible contribution), you can send it to: The 52nd Street Project, 789 10th Ave., New York, NY 10019. Or fax it to (212) 333-5598.

## DON'T MISS OUR NEXT SHOW...

ART BY CAROLINE HADILAKSONO



The Spring 2014 Playmaking Plays

Friday through Sunday,  
April 4-6, 2014

Right here at  
Five Angels Theater

Last month,  
10 brand-new  
Project kids  
began  
Playmaking  
classes with  
Megan Cramer.  
Come see their  
final plays  
performed by  
professional,  
volunteer  
adult actors.

## The 52nd Street Project Board of Directors

Lisa Benavides  
Rachel Chanoff  
Cathy Dantchik, co-chair  
Carolyn DeSena  
Wendy Ettinger, chair emeritus  
Louis P. Friedman, co-chair  
Robert Goldberg  
Stephen Graham, chair emeritus  
Valerie Kay  
Frances McDormand  
Noël Mihalow

Carol Ochs  
Willie Reale, founder  
Gus Rogerson  
Shirley Rumierk, alumni member  
José Soto, Jr., alumni member  
Jenny Steingart  
Lisa Tilney  
Merritt Tilney  
Wendy vanden Heuvel  
John A. Vassilaros

### What's Going On Here?

The 52nd Street Project is a non-profit organization that brings children from the Hell's Kitchen neighborhood together with professional theater artists to create original theater. **BY DEGREES** is a production of our Two-on-Two's program, in which an adult playwright crafts a piece for a pair of Project kids to perform. Another adult directs the kids for a month that includes an intensive three-day weekend in upstate New York. Tonight's performance is the final result.

### In-Kind Contributions

Abbeville Press; ABC Kitchen; Stephanie Berger Photography; Lewis Black; Iris A. Brown Design; William Curran & A Curran Af-fair; Michael Dorf & City Winery; Commonwealth Proper; Emmett Global; Ferragamo Timepieces; Fried and Kowgios Partners; Hudson Scenic; ICI; JetBlue; Paul, Weiss, Rifkind, Wharton & Garrison LLP; Pharma Print; Sesame Workshop; Showtime; Wendy Stuhlberg; Tao Group; Uber; John A. Vassilaros; Watkins, Inc.; and Wynn Resorts.

### Special Thanks

We owe many thanks to Susanna Styron; Wendy vanden Heuvel & Brian Mertes & Melissa Kievman; Polly King & John Paul Newport; and Deborah Adamy, all of whom graciously allowed us to use their homes in the Nyack area for three exhilarating and fun-filled days. Thanks also to Bear Mountain Skating Rink and New City Bowling.

## ...OR THE PROJECT'S ANNUAL BENEFIT!

Host James Naughton & the Board of Directors of  
The 52nd Street Project invite you to

**SAVE THE DATE FOR**

# ZOOPTOPIA

The (alphabetically) Ultimate Project Benefit

Songs written by a flock of wild Project kids and  
performed by a rampaging herd of special guests.

**Monday, May 12, 2014**  
**The Tribeca Rooftop**

CONTACT JOHN "THE ANIMAL" SHEEHY FOR MORE INFORMATION ABOUT  
"ZOOPTOPIA" AT (212) 333-5252 OR SHEEHY@52PROJECT.ORG



## BY DEGREES - ACT 1

All original music composed by Robert Cowie

### STAKE OUT

Written by Rachel Bonds

Directed by Yusef Miller

Alexander Lupinski ..... Kamil Kuzminski

Aria Christina Allende ..... Leah Macuilt

*Sketchiest Man Alive* lyrics by Rachel Bonds

### GHOST STOPPERS

Written by Jiehae Park

Directed by Eliza Baldi

Clara ..... Venecia Escamilla

Carmen ..... Melody Cruz

Ghost ..... Megan Cramer

*Unexpected* lyrics by Jiehae Park

### THE SHOWDOWN

Written by Sung Rno

Directed by Tim J. Lord

Lucky Seven ..... Derek Tineo

The Kalifornia Kid ..... Miguelangel Vazquez

*Better Than the Rest* lyrics by Sung Rno

# I N T E R M I S S I O N

## BY DEGREES - ACT 2

### THE SPY WHO NEGLECTED ME

Written by Craig Cox

Directed by Matthew Jellison

Q ..... Nathaniel Butler

Bond ..... Carlos Breton

Pippa Middleton ..... Megan Cramer

Villain ..... A.J. Welsh

Voice of Siri ..... Courtney Kupferschmidt

*Business Vacation* lyrics by Craig Cox

### THE BUZZ

Written by Chisa Hutchinson

Directed by January LaVoy

Gabby ..... Asia Rosado

Selena ..... Tatiana Goode

*Don't Be Stupid* lyrics by Chisa Hutchinson

### FORMER WIVES OF REGGIE

Written by Max Posner

Directed by Natalie Martin

Holly ..... Samantha Paduani

Debbie ..... Rene Paul Santiago

*Through* lyrics by Max Posner



The 52nd Street Project is a non-profit arts organization that brings children from the Hell's Kitchen neighborhood together with professional artists to create original art. The Dancemaking program gives children a chance to express themselves creatively through movement. Over the nine weeks of Dancemaking class, led by Megan Cramer, these young choreographers and performers developed their own movement vocabulary, explored shapes, pathways, actions, and choreographic elements to create their own 4-minute duets. The resulting dances are featured in tonight's performance.

### The 52nd Street Project Staff

Gus Rogerson, Artistic Director	Carol Ochs, Executive Director
Megan Cramer, Associate Artistic Director	Lisa Kerner, Devt. & Mgmt. Associate
George Babiak, Production Manager	John Sheehy, Dir. of Development & Marketing
Ray Harold, Technical Director	Alyssa Anderson, Mgr. of Individual Giving
Liz Bell, Director of Education	
Johanna Vidal, Community Coordinator	
Olivia Strauss, Education Assistant	

#### Consultants:

Iris A. Brown, Graphic Designer; Chris Ceraso, Teen Dean

#### Interns:

Hannah Allen, Lindsay Olson

#### Teen Employees:

Receptionists: Gabriella DeJesus, Haley Martinez, Britney Trinidad, Alizette Zapata  
 Ushers: Daquan Nelson, Jocelyn Ochoa, Asia Rosado

### The 52nd Street Project Board of Directors

Lisa Benavides	Carol Ochs
Rachel Chanoff	Willie Reale, founder
Cathy Dantchik, co-chair	Gus Rogerson
Carolyn DeSena	Shirley Rumierk, alumni member
Wendy Ettinger, chair emeritus	José Soto, Jr., alumni member
Louis P. Friedman, co-chair	Jenny Steingart
Robert Goldberg	Lisa Tilney
Stephen Graham, chair emeritus	Merritt Tilney
Valerie Kay	Wendy vanden Heuvel
Frances McDormand	John A. Vassilaros
Noël Mihalow	



The Dancemaking Program is made possible with public funds from The New York State Council on the Arts, a state agency; and the New York City Department of Cultural Affairs. The Project is a member of ART/NY.

The 52nd Street Project Presents



The  
52nd  
Street  
Project's  
Annual  
Dance  
Concert



Featuring 8 short original dances choreographed by kids and performed by kids and adults.

Dancemaking Director: Megan Cramer

Monday, April 28 & Tuesday, April 29, 2014 – 7:00 p.m.

The Five Angels Theater  
The 52nd Street Project  
789 10th Avenue



## Prologue

Choreographed by: Megan Cramer & HannaH Allen  
Performed by: The Dancemaking Company  
Music: Chris Martin, "Postcards From Far Away" &  
Coldplay "Life in Technicolor"

## Meeting and Parting

Choreographed by: Stephanie Macias  
Performed by: Stephanie Macias & Erin Felgar  
Music: The Piano Guys, "Over the Rainbow/ Simple Gifts"

*"We picked 'Somewhere Over the Rainbow' for this dance routine because it connected with the beginning: the toaster dance. The toaster dance was inspired by the Machine dances in one of the classes we took. In the dance we were moving away from each other and tightening back together."* — Stephanie Macias

## Kingdoms

Choreographed by: Damian Tineo  
Performed by: Damian Tineo & Mike James  
Music: Escala, "Palladio"

*"My inspiration was my play in Playmaking. My play in Playmaking was 2 men fighting and at the end they destroy a village so they stop fighting forever. My play is similar to my dance."* — Damian Tineo

## Daily Life

Choreographed by: Valeria Oliva  
Performed by: Valeria Oliva & Erin Roberts  
Music: Capoeira Electronica, "O Canto Do Berimbau"

*"My inspiration was daily life; for example, working is in my dance, and waking up, going to work, cars, drinking, eating. We spin, jump, run, and we make a dance about everyday activities. I picked the music because it was fun. You can dance to it and it was different."* — Valeria Oliva

## At First Sight

Choreographed by: Jasmine Correa  
Performed by: Jasmine Correa & Ruy Iskander  
Music: Andreas Scholl, "With Wand'ring Steps" from "The Merchant of Venice"

*"My inspiration for this dance was love and struggle. I made that my inspiration for the dance because it's something that we can all connect to in some way."*  
—Jasmine Correa

## Dance of Death

Choreographed by: Rene Paul Santiago  
Performed by: Rene Paul Santiago, Jasmine Correa & Ruy Iskander  
Music: Trevor Jones, "Main Title" from "The Last of the Mohicans"

*"A man's journey to a hush sacrifice, his view on life, but evil awaits on the other side. Faced with a crucial decision weighed against him, how will he go about doing this?"*  
-- Rene Paul Santiago

## Men in Black 'n' White

Choreographed by: Ricardo Currin  
Performed by: Ricardo Currin & Grant Harrison  
Music: The Piano Guys, "Code Name Vivaldi"

*"The story of Men in Black 'n' White is about 2 men who are frenemies. At one point they are friends and do their moves together. Then sometimes they go against each other. The point of the story is will they stand together or will they depart and become full time enemies."* — Ricardo Currin

## Bird Pop

Choreographed by: Lambert Whitney  
Performed by: Lambert Whitney and Jeanna Phillips  
Music: Nightwish, "Moondance"

*"Heller! I was inspired by the world around me, such as the music I listen to, such as electronic hip hop/rap pop and alternative. The double arm pump was from my one-on-ones. It was really fun working with Jeanna Phillips and HannaH Allen. Hope u Luv this dance, <3 Lambert."* — Lambert Whitney

## Life Cycle of a Flower

Choreographed by Jayda Camacho  
Performed by: Jayda Camacho and Kira Onodera-Harrow  
Music: The Piano Guys, "Kung Fu Piano: Cello Ascends"

*"Making the dance itself was really hard, also the fact that I had no inspiration made it harder to do the dance. The movement never came to me, I just randomly did them and put them into the dance the order I did it in: slow, fast, slow. The music didn't have any meaning to my dance. I could take another song and do something very random that is different. But it was fun doing this and getting to make the dance the way I want it."*  
— Jayda Camacho

## Epilogue

Choreographed by: Megan Cramer & HannaH Allen  
Performed by: The Dancemaking Company  
Music: Coldplay, "Life in Technicolor"

The 52nd Street Project gratefully acknowledges the support of the following foundations and corporations: Bloomberg; Brenner Family Foundation; Cantor Fitzgerald; CBS Corporation; The Common Sense Fund; Consolidated Edison; Dawkins Family Foundation; The Neil V. DeSena Foundation; The Dramatists Guild Fund; Dramatists Play Service; The Educational Foundation Of America; Sidney E. Frank Foundation; Goldman Sachs; The Horace W. Goldsmith Foundation; Heisman Foundation; Hudson Scenic Studio; Lotos Foundation; Ann M. Martin Foundation; Marusi Family Foundation; Monteforte Foundation; Newman's Own; The PAR Group; Pinkerton Foundation; Quadra Productions; Sesame Workshop; The Shubert Organization; Simon & Eisenberg; Starker Family Foundation; Harold & Mimi Steinberg Charitable Trust; Surdna Foundation; Susquehanna Investment Group; Tax Pro Financial Network, Inc.; TCG; Theater Subdistrict Council; Tiger Baron Foundation; Van Deusen Family Fund; Vervane Foundation; Watkins, Inc.; WMEE Foundation; Yorke Construction Corp.

- |                                      |   |   |                                       |
|--------------------------------------|---|---|---------------------------------------|
| Robert Abrams<br>& Cynthia Vance     | Penelope Collins<br>Judith-Ann Corrente           | Sarah Horowitz<br>& David Venarde           | Sue Phillips<br>Todd Poisson          |
| George Ackert                        | Janet Coviello                                    | Andrea Johnson                              | Suzanne Poulin                        |
| Michael Alicastro                    | William Crudup                                    | Beth Ifcher                                 | Helaine & Michael Pruzan              |
| Elton Andrews                        | Kyle Czepiel                                      | Carine Joannou                              | Christopher Randolph                  |
| Richard Anthony                      | Arthur Dantchik                                   | Kristen Johanson                            | Helen & Peter Randolph                |
| Cecilia Arana                        | Cathy Dantchik                                    | Andrea Johnson                              | Jacquelyn Reingold                    |
| Emily Armstrong                      | Leslie Dantchik                                   | Cindy Kaplan & David Froelich               | Anita A. Rogerson                     |
| James Armstrong                      | Peter & Judith Dawkins                            | Valerie Kay & Bruce Graham                  | David Ross & Laura Ross               |
| Dominick & Ilene Balletta            | Carolyn & Neil DeSena                             | Louise Klebanoff                            | Dr. Steve Rudin                       |
| Becky Ann & Dylan Baker              | Rebecca & Richard Dresser                         | Henry Krieger & Robert Joy                  | Laura Sametz & Anton Fig              |
| Ken Bantum                           | Peter Doyle                                       | Jacki Ochs & Jan Kroeze                     | Karin & Thomas Schall                 |
| Carolyn Bechtel                      | Max Dyksterhouse<br>& David Roady                 | Judy Kuhn & David Schwab                    | Maury Schott                          |
| Lisa Benavides<br>& Tim Blake Nelson | Doug Eisenberg                                    | Frances & Fred Langbecker                   | Susan Schroeder<br>& Britt Adams      |
| Louisa Benton                        | Lynn Ellenberg                                    | Gabrielle Lansner<br>& Dean Taucher         | Whitney Scott<br>& Peter Jacobson     |
| Gavin Berger<br>& Craig Berggren     | Nora Ephron<br>& Nicholas Pileggi                 | Brian Lapin                                 | Meg Simon                             |
| Stephanie Berger & Paul King         | Peter Jay Fernandez                               | Michael Lawrence<br>& Glen Gillen           | Christopher Solomon                   |
| Beth & Eric Berman                   | & Denise Burse Fernandez                          | Warren Leight & Karen Hauser                | Jonathan Soros<br>& Jennifer Soros    |
| David Beth                           | Liz Flahive & Jeff Cox                            | Mickey Lemle                                | Jenny & Jon Steingart                 |
| Lewis Black                          | Wendy Flanagan<br>& Chris O'Malley                | Jonathan Levine                             | Tracy Straus                          |
| Emily Blavatnik                      | Karen & Paul Freitas                              | Helen Levy                                  | Danny Strong                          |
| Allison Blinken                      | Sally Froelich                                    | Melissa Liebling-Goldberg<br>& John Barrett | Al Styron & Ed Beason                 |
| Noah Bogan                           | Alexandra Garrison                                | Kay M. Lim                                  | Susanna Styron                        |
| Jane Bolster<br>& Steve Wertimer     | Beverly Gasner                                    | Adrienne Lobel                              | Richard Sweren                        |
| Buzz Bovshow                         | Rose Gasner & Larry Chertoff                      | John Lynch                                  | Lili Taylor                           |
| Blaise R. Box                        | Celia Gerard & Mark McGrath                       | Grace Lyu-Volckhausen                       | Lisa Tilney & Chris Lawrence          |
| Becky Browder<br>& Ted Neustadt      | Christina Gerber                                  | Julie & Alex Margolies                      | Merritt Tilney & Douglas Kaden        |
| Carlton T. Brown                     | Freddie & Myrna Gershon                           | Ali Marsh                                   | Lorraine Tobias & Alex Draper         |
| Iris A. Brown & Joe White            | Jenny Gersten & Willie Reale                      | Lin Manuel Miranda                          | Liz Tuccillo                          |
| Justin Brownhill                     | Alexandra Gersten-Vassilaros<br>& John Vassilaros | Frances McDormand<br>& Joel Coen            | Laura Valeroso<br>& David Seidman     |
| Brian Byrnes                         | Scott Aaron Gewirtz<br>& Laura Gewirtz            | Emily & John Morgan                         | Wendy vanden Heuvel<br>& Brad Coley   |
| Shawn & Laura Byron                  | Elizabeth Giamatti                                | Amanda & Neal Moszkowski                    | Susan J. Vitucci                      |
| Joseph Capozzi                       | Robert Goldberg<br>& Betsy MacIsaac               | Suzen Murakoshi<br>& Mark Temme             | Mary Pat Walsh                        |
| Leah Carr                            | Stephen & Cathy Graham                            | Fred Nelson                                 | Dr. Mildred Walton                    |
| Lawrence Catena                      | Jan Gura & Alan Pickman                           | Randy & Rona Nelson                         | Brenda Wehle & John C. Lynch          |
| Chris Ceraso                         | Susan Hanson                                      | Ruth Nelson                                 | Carol Whitesides                      |
| Rachel Chanoff                       | Jessica Hecht<br>& Adam Bernstein                 | Lori O'Connor                               | Zee Wiener                            |
| Todd Christie                        | Kathy & Jamie Herring                             | Carol Ochs & Bruce MacVittie                | Ruth Ann Wynter                       |
| Damien Clancy                        | Peter Herdrich & Karen Trott                      | Jacki Ochs & Jan Kroeze                     | J.P. Xenakis                          |
| Matthew Clancy                       | William Holtzman                                  | Kevin O'Rourke<br>& Edith Thurber           | Carole Yass                           |
| Katie Clark                          | & S. Sylvia Shepard                               | Jane Perlmutter<br>& Greg MacPherson        | Yildiz Yuksek<br>& Richard Blackstone |
| Elizabeth Clemants                   | Mary Horowitz                                     | Elizabeth Peters                            | Connie & Marc Zand                    |
| David Cohen<br>& Sandra Novak Cohen  |   |   |                                       |
| Larry Cohen                          |   |   |                                       |

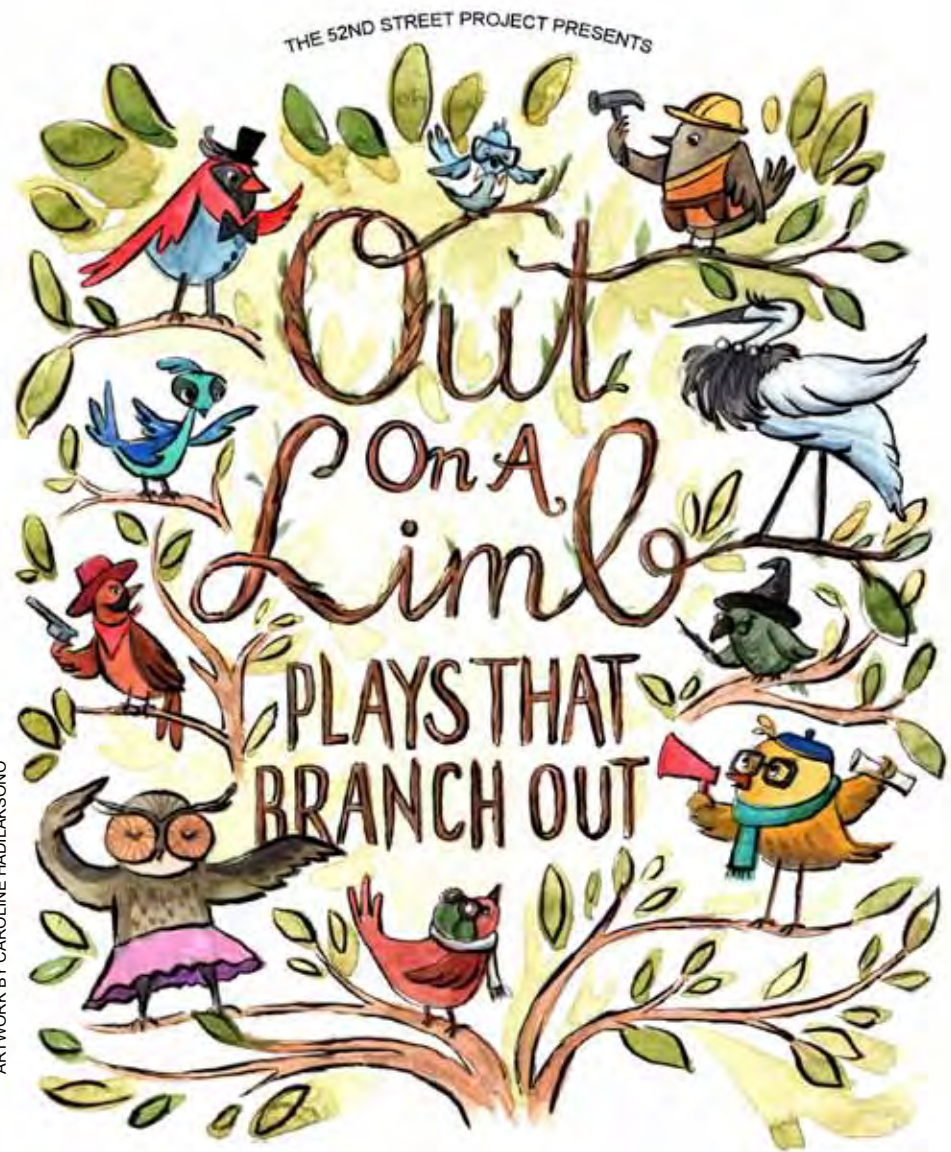

The Spring 2014 Playmaking Plays  
10 new plays written by kids and performed by adult actors.

Five Angels Theater  
Friday, April 4 at 7:30 p.m.  
Saturday, April 5 at 3:00 and 7:30 p.m.  
Sunday, April 6 at 3:00 p.m.

# Out on a Limb: Plays That Branch Out

The Spring 2014 Playmaking Production - April 4-6, The Five Angels Theater

## The 52nd Street Project Staff

Gus Rogerson, Artistic Director	Carol Ochs, Executive Director
Megan Cramer, Associate Artistic Director	Lisa Kerner, Devt. & Mgmt. Associate
George Babiak, Production Manager	John Sheehy, Dir. of Development & Marketing
Ray Harold, Technical Director	Alyssa Anderson, Mgr. of Individual Giving
Liz Bell, Director of Education	
Johanna Vidal, Community Coordinator	
Olivia Strauss, Education Assistant	

**Consultants:**

Iris A. Brown, Graphic Designer; Chris Ceraso, Teen Dean

**Interns:**

HannaH Allen, Lindsay Olson

**Teen Employees:**

Receptionists: Gabriella DeJesus, Haley Martinez, Britney Trinidad, Alizette Zapata  
 Ushers: Michael Bannister, Joyce Cheung, Maximo Jimenez, Brandon Shaffer, Edison Sibri

## “Out on a Limb” Production Staff

Composer/Music Director Andrew Sherman	Prop Design Team George Babiak, HannaH Allen, Lisa Kerner, Lindsay Olson, Johanna Vidal
Set Designer Kevin Joseph Roach	Backstage Crew HannaH Allen, Lindsay Olson, Matthew Orozco, Kayla Matos
Lighting Designer Greg MacPherson	House Managers Alyssa Anderson, Liz Bell, Lisa Kerner
Lighting Assistant Laurel Detkin	“Out On A Limb” Flyer and Program Art Caroline Hadilaksono
Costume Designers Viviane Galloway and Sarah Swafford	Chefs Liz Bell, Carol Ochs
Costume Assistant Leah Benedetti	Playmaking Class Volunteers Marco Formosa, Joshua Joya, Eileen Katz, Erin Roberts, Lee Rosen, Jeremy Stoller, Kevin Urban, Annie Worden
Goddess of Sound Vanessa Valdes	Playmaking Class Teen Assistant Jazmine Mikell
Stage Manager Jenny Peek	Production Photographer Winston Rodney
Projection Design George Babiak and the 52nd Street Projection Archive	



This program is supported, in part, by public funds from The New York City Department of Cultural Affairs in partnership with the City Council. The Playmaking program is also made possible with public funds from The New York State Council on the Arts, a state agency. The Project is a member of ART/NY.

## COOL STUFF ON SALE IN THE LOBBY!

Fabulous Flyer Bars ..... \$2.50

and featuring Shel Silverstein’s “Fivey and Twoey” logo:

Project T-shirts .....\$12.00 and \$20.00  
 Project Hoodies .....\$30.00  
 Project Caps.....\$20.00  
 Project Mugs..... \$5.00  
 Project Pencil 3-pack ..... \$1.00  
 Project Notebook..... \$5.00

Thank you for coming to **OUT ON A LIMB!** If you are not on our mailing list (or if your address has changed), please fill out this form and give it to us on your way out or mail it to the address below. We would also like to know if you are interested in becoming a volunteer. We need help in all areas, so be sure to fill out the entire form.

PLEASE ADD ME TO YOUR MAILING LIST: 4/14

NAME \_\_\_\_\_

ADDRESS \_\_\_\_\_

CITY \_\_\_\_\_ STATE \_\_\_\_\_ ZIP \_\_\_\_\_

HOME PHONE \_\_\_\_\_

DAYTIME OR MOBILE PHONE \_\_\_\_\_ E-MAIL ADDRESS \_\_\_\_\_

MY OCCUPATION \_\_\_\_\_

MY HOBBIES \_\_\_\_\_

**YES, I WOULD LIKE TO BE OF HELP. I CAN:**

- |   |   |
|---|---|
| <input type="checkbox"/> Draw and/or paint            | <input type="checkbox"/> Help kids with homework  |
| <input type="checkbox"/> Hang lights                  | <input type="checkbox"/> Help with mailings <input type="checkbox"/> Teach kids a skill |
| <input type="checkbox"/> Work on a backstage crew     | <input type="checkbox"/> Do office work <input type="checkbox"/> Be a chef at an event  |
| <input type="checkbox"/> Do graphic design            | <input type="checkbox"/> Design sound <input type="checkbox"/> Design and sew costumes  |
| <input type="checkbox"/> Other (please specify) _____ |   |

**MY SCHEDULE IS:**

- Very flexible. I'm often available during weekdays.
- Somewhat flexible. I can help on the occasional morning or afternoon during the week.
- Not very flexible at all, but I've got some free time on evenings and weekends.
- If you would like to mail this (and you're always welcome to enclose a tax-deductible contribution), you can send it to: The 52nd Street Project, 789 10th Ave., New York, NY 10019. Or fax it to (212) 333-5598.

## COMING UP ON THE PROJECT SCHEDULE...



CONTACT JOHN "THE BEAST" SHEEHY FOR MORE INFORMATION ABOUT "ZOOTOPIA" AT (212) 333-5252 OR SHEEHY@52PROJECT.ORG



## The 52nd Street Project Board of Directors

Lisa Benavides	Carol Ochs
Rachel Chanoff	Willie Reale, founder
Cathy Dantchik, co-chair	Gus Rogerson
Carolyn DeSena	Shirley Rumierk, alumni member
Wendy Ettinger, chair emeritus	José Soto, Jr., alumni member
Louis P. Friedman, co-chair	Jenny Steingart
Robert Goldberg	Lisa Tilney
Stephen Graham, chair emeritus	Merritt Tilney
Valerie Kay	Wendy vanden Heuvel
Frances McDormand	John A. Vassilaros
Noël Mihalow	

## What's Going On Here?

The 52nd Street Project is a non-profit organization that brings children from the Hell's Kitchen neighborhood together with professional theater artists to create original theater. *OUT ON A LIMB* is a production of our Playmaking program. Young people participate in a nine-week playwriting course taught by Megan Cramer and adapted for the Project by Daniel Judah Sklar from his book *Playmaking: Children Writing and Performing Their Own Plays*. At the end of the course, each child is matched with two actors and a dramaturg/director who guides him or her through the writing of a play during a weekend retreat in the country (Bridgehampton, NY, for this show). This performance is the end result.

## In-Kind Contributions

Abbeville Press; Stephanie Berger Photography; Lewis Black; Richard Blackstone; Iris A. Brown Design; William Curran & A Curran Affair; Kate Cusack; FK Partners; ICI; The S.F. Giants; Newman's Own; Pharma Print; PineRock; The N; Wendy Stuhlberg; The Yankees; John A. Vassilaros; Watkins, Inc.; Boylan's Bottling Co.; Hudson Scenic; and Paul, Weiss, Rifkind, Wharton & Garrison LLP.

## Special Thanks

We're extremely grateful to John Vassilaros & Alex Gersten-Vassilaros for the use of their beautiful home in Bridgehampton, NY as our base of operations for the writer's retreat. We're also grateful to Laurie Becker, who housed the girls in nearby Sag Harbor.

## Out On a Limb: Plays That Branch Out - Act 1

All original music composed by Andrew Sherman.

### THE WAR AND THE PEACE

Written by Nathaniel Ortiz, age 9. Dramaturge/Director: George Babiak  
Costume Designer: Viviane Galloway

Jimmy ..... Marco Formosa  
Candy ..... Mauricio Salgado  
Jimmy's Friends ..... The Crew  
*The Failure and The Different Lands* lyrics by Nathaniel Ortiz

### ALONE AGAIN

Written by Kiara Figueroa, age 11.  
Dramaturge/Director: Nehassaiu deGannes  
Costume Designer: Sarah Swafford

Alexzander ..... Sekou Laidlow  
Tara ..... Christina Robinson  
*I Don't Know* lyrics by Kiara Figueroa

### THE COMMOTION

Written by Karen Tineo, age 11. Dramaturge/Director: Rebecca Martinez  
Costume Designer: Sarah Swafford  
Old Man Outlet ..... Greg Hildreth  
4132X ..... Wrenn Schmidt  
Old Man ..... John Sheehy  
*Last Desire and I Need Your Help* lyrics by Karen Tineo

### THE DOG AND CAT NEVER ESCAPED

Written by Sebastian Lopez, age 10. Dramaturge/Director: Felix Solis  
Costume Designer: Sarah Swafford  
Samantha ..... Shirley Rumiak  
Jack ..... Carlo Alban  
Shelter Customers ..... Kayla Matos and Lindsay Olson  
Animal Control ..... HannahH Allen and Matthew Orozco  
*The Telling Song* lyrics by Sebastian Lopez

### B&B PERFECTION

Written by Sofia Santoni, age 11. Dramaturge/Director: Christina Roussos  
Costume Designer: Sarah Swafford  
Snaple Buttercup ..... Marinda Anderson (Fri)  
Megan Cramer (Sat, Sun)  
Cherry Tootsie ..... Krystel Lucas  
Teacher ..... Lindsay Olson  
*Beauty vs. Brains and B & B Is Perfection* lyrics by Sofia Santoni

## Out On a Limb: Plays That Branch Out - Act 2

### CHEERLEADING NEVER GOES WITH BASEBALL!

Written by Duaa Alkindi, age 11. Dramaturge/Director: Sarah Krohn  
Costume Designer: Viviane Galloway

Frank ..... Joe Paulik  
Ashley ..... Dahlia Azama  
*I'm Sorry, Ashley* lyrics by Duaa Alkindi

### ZAMBIES!

Written by Sevan Ascencio, age 11. Dramaturge/Director: Jeremy Stoller  
Costume Designer: Viviane Galloway  
Matron ..... Matt Citron  
Mikein ..... Michael Crane  
Zambies ..... The Crew

### THE HONORED NERD

Written by Milen Tokarev, age 11. Dramaturge/Director: Annie Worden  
Costume Designer: Viviane Galloway  
Kevin McDoody Lezakowitz ..... Michael Braun  
Fancy McPantsy ..... Adrienne C. Moore  
Mom ..... Lindsay Olson  
Operator ..... HannahH Allen  
Crowd ..... The Crew  
*The Common Song* lyrics by Milen Tokarev

### ALL DAY EVERYDAY THERAPY TIME!

Written by Jayla Alvarez, age 11. Dramaturge/Director: Kerry Whigham  
Costume Designer: Sarah Swafford  
Brody ..... Eric Clem  
Daisy ..... Laura Woodward  
*The Client* lyrics by Jayla Alvarez

### THE CRISIS

Written by Daniel Tineo, age 10. Dramaturge/Director: James Yaegashi  
Costume Designer: Viviane Galloway  
Daisy ..... Edie Falco  
Max ..... Dan Butler  
*Fears* lyrics by Daniel Tineo

The 52nd Street Project (the Project) is dedicated to the creation and production of new plays for and by kids between the ages of ten and eighteen who reside in the Hell's Kitchen neighborhood in New York City. The Project does this through unique mentoring programs that match kids with professional (and volunteer!) theater artists.

'GET YOURSELF TOGETHER' is a production of our Teen Ensemble Program. The Teen Ensemble is a two year acting conservatory program, which includes several public performances of original material and culminates in a full Shakespeare production. This show is the last stage of their first year.

After a year that included classes in movement, improvisation, mask performance, scene study, poetry and singing, the teens met with six adult playwrights, who were charged to create the plays we are now presenting.

Special thanks to all of our wonderful volunteer guest artists who have worked with the Teen Ensemble this year: **Broken Box Mime Theater, Sarah Petersiel, Julie Sharbutt, Tim Racine, Rory Scholl, Eric A. March, Lynne Rosenberg, Max Davis, Erin Cherry, Mikhaela Mahony, Joanna Gurin, and Sam Stonefield.**

The Project would also like to thank **Wendy vanden Heuvel** and **Brad Coley** for the use of their country home on Lake Lucille for the Teen Weekend trip, where we rehearsed these plays, swam in a cold lake, and ate delicious food. Also, big thanks to **Susanna Styron**, who housed our boys for a night in nearby Nyack, NY.

The following foundations and government agencies have generously supported the Teen Program through their contributions:

City of New York Department of Cultural Affairs  
Horace W. Goldsmith Foundation  
New York State Council on the Arts  
The Surdna Foundation

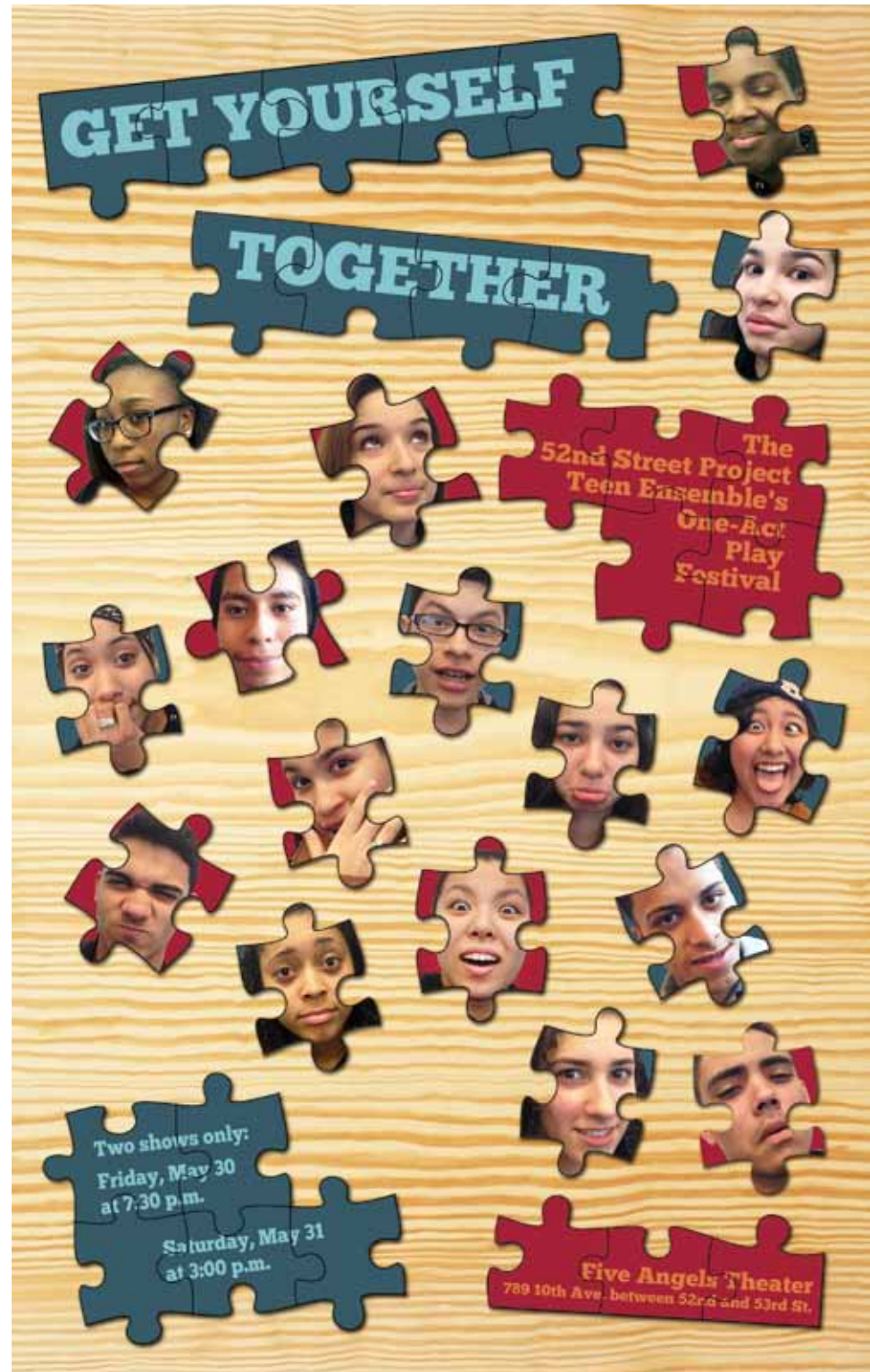





**The 52nd Street Project Staff**

Gus Rogerson, Artistic Director Carol Ochs, Executive Director
Megan Cramer, Associate Artistic Director Lisa Kerner, Devt. & Mgmt. Associate
George Babiak, Production Manager John Sheehy, Dir. of Development & Marketing
Ray Harold, Technical Director Alyssa Anderson, Mgr. of Individual Giving

Liz Bell, Director of Education
Johanna Vidal, Community Coordinator
Olivia Strauss, Education Assistant

**Consultants:**

Iris A. Brown, Graphic Designer; Chris Ceraso, Teen Dean

**Interns:**

HannaH Allen, Lindsay Olson, Garrett Kim

**Teen Employees:**

Receptionists: Gabriella DeJesus, Haley Martinez, Britney Trinidad, Alizette Zapata
Ushers: Maximo Jimenez, Daquan Nelson, Asia Rosado, Joseph Vasquez

**“Get Yourself Together” Team**

Burke Brown...Lighting Designer
Lara deBruijn...Costume Designer
Lindsay Olson...Sound Designer
HannaH Allen...Stage Manager
Garrett Kim, Jasmine Correa, Chanel Rodney...Running crew
George Babiak...Prop Design
Deenah Shutzer...Rehearsal Coach
Benjamin Fichthorn...Asst. Lighting Designer

**The 52nd Street Project Board of Directors**

Lisa Benavides Carol Ochs
Rachel Chanoff Willie Reale, founder
Cathy Dantchik, co-chair Gus Rogerson
Carolyn DeSena Shirley Rumierk, alumni member
Wendy Ettinger, chair emeritus José Soto, Jr., alumni member
Louis P. Friedman, co-chair Jenny Steingart
Robert Goldberg Lisa Tilney
Stephen Graham, chair emeritus Merritt Tilney
Valerie Kay Wendy vanden Heuvel
Frances McDormand John A. Vassilaros
Noël Mihalow Mark Whatley

**SWEET SOUND OF DESTINY**

Written by Patrick Link and directed by Colette Robert

Kimberly...Mari Ulloa
Prudence...Haley Martinez
George...Hashem Ahmed
Jack Williams...Max Rosenak
Factory Workers/ Park People...Michael Bannister, Natalia Caballero, Gabriella DeJesus, Edison Sibri

**THE ROLES OF THE PRINCE AND NIGEL**

Written by Matthew Paul Olmos and directed by Ruy Iskandar

Nigel...Devin Gonzalez
Prince...Ruy Iskandar

**SAVE ME**

Written by Melisa Tien and directed by Nic Grelli

Dr. Ramos...Nathaly Trinidad
Nurse...Brandon Leon
Granddaughter...Elena Caballero
Patient/Alba...Jazmine Mikell

**INTERMISSION**

**ACROSS THE DATAVERSE**

Written by Liz Tuccillo and directed by Erin Mallon

Boy...Dante Quinones
Girl...Tiara Varela
Other Girl...Joyce Cheung
Yellow & White People...Mari Ulloa, Haley Martinez

**THEN WE WENT BACK**

Written by Jihan Crowther and directed by Natalie Paul

Maggie...Gabriella DeJesus
Glynnis...Natalia Caballero

**TIME CRUISE**

Written by Lucas Kavner and directed by Max Rosenak

Randall...Michael Bannister
Edith...Elizabeth Vazquez
Mystery Man...Edison Sibri
Assistants...Brandon Leon & Jazmine Mikell
Disco Dancers...Tiara Varela, Dante Quinones, Nathaly Trinidad, Joyce Cheung, Elena Caballero

## The 52nd Street Project Board of Directors

Lisa Benavides	Carol Ochs
Rachel Chanoff	Willie Reale, founder
Cathy Dantchik, co-chair	Gus Rogerson
Carolyn DeSena	Shirley Rumierk, alumni member
Wendy Ettinger, chair emeritus	José Soto, Jr., alumni member
Louis P. Friedman, co-chair	Jenny Steingart
Robert Goldberg	Lisa Tilney
Stephen Graham, chair emeritus	Merritt Tilney
Valerie Kay	Wendy vanden Heuvel
Frances McDormand	John A. Vassilaros
Noël Mihalow	Mark Whatley

### The 52nd Street Project Staff

Gus Rogerson, Artistic Director	Carol Ochs, Executive Director
Megan Cramer, Associate Artistic Director	Lisa Kerner, Development & Mgmt. Associate
George Babiak, Production Manager	John Sheehy, Dir. of Development & Marketing
Ray Harold, Technical Director	Alyssa Anderson, Manager of Individual Giving

Liz Bell, Director of Education  
Johanna Vidal, Community Coordinator  
Olivia Strauss, Education Assistant

#### Consultants:

Iris A. Brown, Graphic Designer and Chris Ceraso, Teen Dean

#### Interns:

HannaH Allen, Lindsay Olson

#### Teen Employees:

Doris Alcantara, Michael Bannister, Lincoln Bernard, Samantha Caldon, Nick Carrero, Joyce Cheung, Jasmine Correa, Gaby DeJesus, Alvin Garcia, Devin Gonzalez, Maximo Jimenez, Haley Martinez, Jazmine Mikell, Daquan Nelson, Jocelyn Ochoa, Samantha Paduani, Lauren Robinson, Chamel Rodney, Asia Rosado, Rene Paul Santiago, Brandon Shaffer, Edison Sibri, Britney Trinidad, Nathaly Trinidad, Mari Ulloa, Tiara Varela, and Alizette Zapata

### Benefit Volunteers

Daiva Deupree, Kim D. Sherman, J. Andrew Stein,  
Olivia Strauss, Vanessa Valdes

### Technical Volunteers

Adam Smolenski

### Special Thanks

Becky Browder, Cathy Dantchik, Marion Dienstag,  
Terry Fitzpatrick, Valerie Kay, Jennifer Kirschman,  
Frances McDormand, Jason Spire

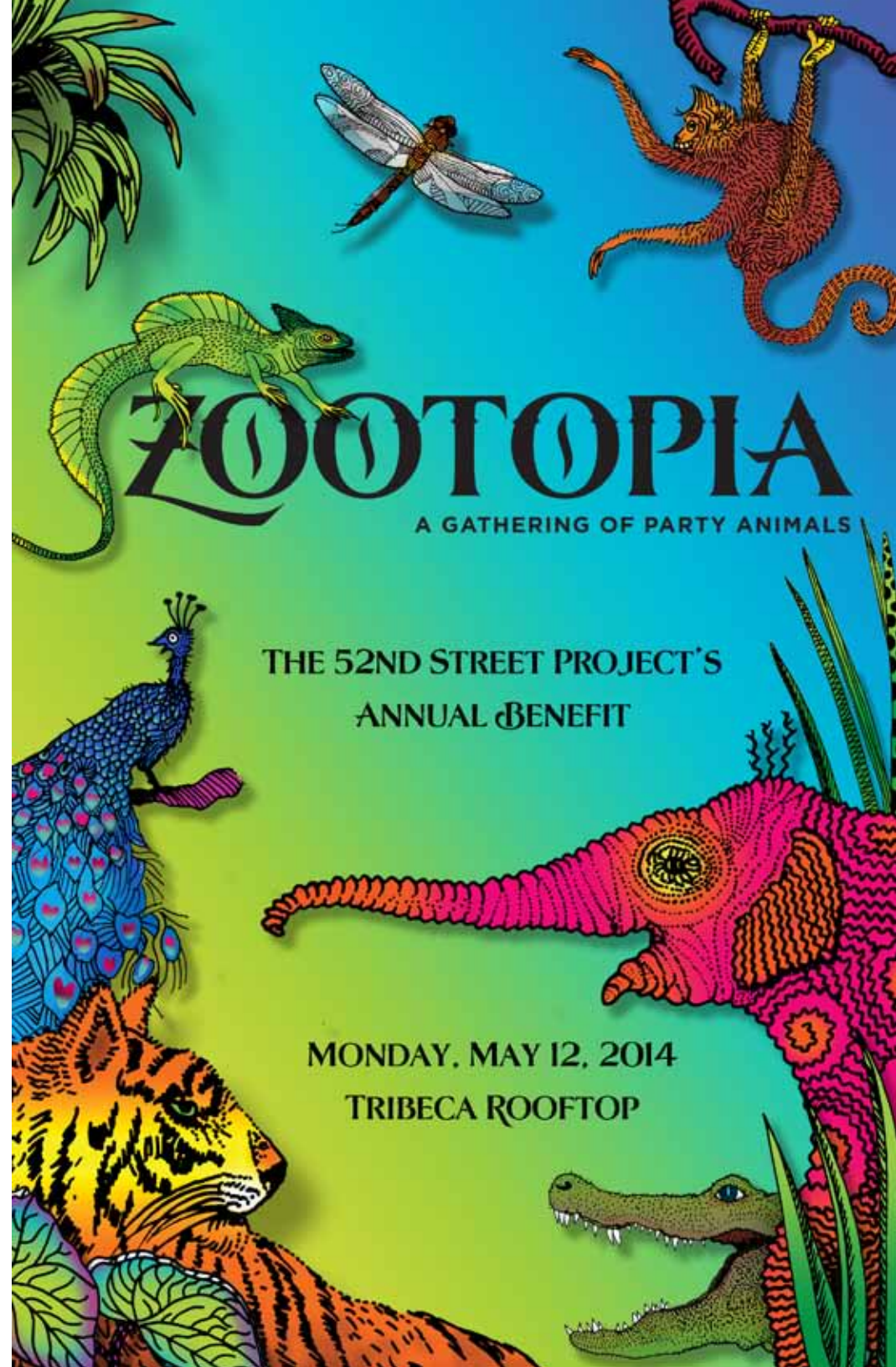

## **“Zootopia” Benefit Co-Chairs**

Lisa Benavides	Karin Schall
Cathy Dantchik	Jenny Steingart
Carolyn DeSena	Merritt Tilney
Louis P. Friedman	Laura Valeroso
Patrice Friedman	Mary Pat Walsh

## **The Chimp Seats**

Beth & Ray Abbott	Alan Krevis & Gary Horowitz
Becky Ann & Dylan Baker	Stephanie Laing
Talia Balsam	Frances & Fred Langbecker
Neena Beber	Adrienne Lobel
Jane Bolster & Steve Wertimer	Bruce MacVittie
Becky Browder & Ted Neustadt	Julie & Alex Margolies
Leah Carr	Ali Marsh & Fred Weller
Chris Ceraso	Emily & John Morgan
Lisa Chanel	Lawrence Nathanson
Rachel Chanoff	Lori O'Connor
Ellen Chopay	Beth Ollwerther
Katie Clark	Mason Pettit
Elizabeth Clemants	Judy & Michael Pillinger
Stacy Cochran	Suzanne Poulin
Lisa Cohen & David Hillman	Christopher Randolph
Noah Cornman	Helen & Peter Randolph
David Costabile	Lynne Rosenberg
Liza Demby	Sallie D. Sanders
Marilyn Diamond	Maury Schott
Marion Dienstag	David Schwab
Rebecca & Richard Dresser	Sylvia Shepard & Willy Holtzman
Joe Finnegan	Susanna Styron
Liz Flahive & Jeff Cox	Richard Sweren
Alexandra Garrison	Edith Thurber & Kevin O'Rourke
Jan Gura	Lisa Tilney
Susan Hanson	Karen Trott & Peter Herdrich
Jessica Hecht & Adam Bernstein	Liz Tuccillo
Kathy & Jamie Herring	Stephen Barker Turner
Sarah Horowitz & David Venarde	Laura Valeroso & David Seidman
Jennifer Iserloh	Susan J. Vitucci
Kristen Johanson & Tom Green	Mary Pat Walsh
Elizabeth & Jeff Kaiden	Sharon Washington
Kim & Elliot Katz	Walker White
Pat Kirby	Carole Yass
Louise Klebanoff	Janet Zarish & Mark Blum
Joyce Krawiecki	

## **The 52nd Street Project gratefully acknowledges...**

Abbeville Press  
abc cocina  
Alvin Ailey American Dance Theater  
Richard Anthony  
Iris A. Brown Design  
William Curran, A Curran Affair  
Emmett Global  
Edie Falco  
Lauren Friedman, Pharma/Omni Printing  
Louis & Patrice Friedman  
Kathy Galotti & Anna Maestrini, Rossano Ferretti Hairspa  
Jenny Gersten, Friends of the High Line  
Google  
Jonathan Groff  
Charlie Marshal, The Marshal Restaurant  
Noël & Joe Mihalow  
Neustar  
Nonesuch Records  
Christopher Poon & Alexander Harrell  
The Public Theater  
Sesame Workshop  
Wendy Stulberg  
TAO Restaurant  
Merritt Tilney & Doug Kaden  
Uber  
John A. Vassilaros & Sons  
Mark Jacobs & J.R. Watkins Company  
Healthier Living Since 1868

Donor lists current as of May 7, 2014

## **Just For Ewe Seats**

Lisa Benavides & Tim Blake Nelson

Gavin Berger

Craig Berggren

Francine Bizar

Allison Blinken

Buzz Bovshow

Blaise R. Box, Staging & Design

Angelina Fiordellisi & Matt Williams

Sally Froelich

Bev Gasner

Rose Gasner & Larry Chertoff

Jenny Gersten & Willie Reale

HBO

Christa Justus & Mark Linn-Baker

Cynthia Kaplan & David Froelich

Anita Keal & Morton Wolkowitz

Mickey Lemle

Martin Levine, The Par Group

Amanda & Neal Moszkowski

Ruth Nelson & Tom Murphy

Anita Andres Rogerson

David Rosenberg

Laura & David Ross

Carla Sacks & John Morris

Laura Sametz & Anton Fig

Karin & Thomas Schall

Jeremy Smith

Joan Solotar

Stephen Sondheim

Cynthia Vance & Robert Abrams

Brenda Wehle & John Carroll Lynch

Vicki & Mark Whatley

Carol Ochs,  
Executive Director

Louis Friedman and Cathy Dantchik,  
Board Co-Chairs

Gus Rogerson,  
Artistic Director

# **ZOOTOPIA**

A Gathering of Party Animals  
The 52nd Street Project's Annual Benefit

Monday, May 12, 2014

Tribeca Rooftop

## **The Show**

### **Host**

James Naughton

### **The Lyricists**

Mussa Ahmed, Adam Alkindi, Chyanne Peña,  
Kaylee Zambrano, Alizette Zapata

### **The Composers**

Amanda Green, Oscar Isaac, Michael Mitnick,  
Greg Naughton, Heather Robb, James Smith

### **The Performers**

Marinda Anderson, Kendal Hartse, Greg Hildreth, Oscar Isaac,  
Catherine Cheng Jones, Nathaly Lopez, Greg Naughton  
James Naughton, Kelli O'Hara, Heather Robb, James Smith

### **The Musicians**

Emily Goldman, Piano  
Thad DeBrock, Guitar and Bass  
John Epcar, Percussion

### **Director**

Jonathan Bernstein

### **Music Director**

Emily Goldman

### **Music Coordinator**

Kim D. Sherman

### **Lighting Designer**

Greg MacPherson

### **Sound Designer**

Drew Levy

### **Set & Props**

George Babiak & Iris Brown

### **Stage Manager**

Lisa Iacucci

### **Written by**

John Sheehy

## Tiger is a Meanie

Lyrics by Mussa Ahmed, age 11

Composed by Greg Naughton

Performed by James Naughton

Back-up vocals sung by Kelli O'Hara & Greg Naughton

MY BLACK IS MY DARKNESS  
MY ORANGE IS MY BLOOD  
I RULE THE FOOD CHAIN  
AND I AM THE KING OF THE WOOD

MY NAME IS TIGER  
BUT YOU CAN CALL ME THE  
TERMINATOR  
YOU KNOW WHY?  
BECAUSE I WILL RUIN ALL YOU  
ALLIGATORS

I AM MEAN  
AND I WILL EAT YOU, I WILL EAT YOU  
AND I WILL EAT YOU, NO QUESTIONS

SO LET ME BE  
AND IF YOU DON'T  
I WILL EAT YOU, I WILL EAT YOU  
AND TURN YOU INTO BONES!

MY CLAWS ARE SO SHARP  
I CAN BE YOUR PROTECTOR  
I DECIDE NOT TO,  
I WILL BE YOUR NIGHTMARE, ROAR!

HEY WAIT A MINUTE,  
LET ME TELL YOU SOMETHING:  
I DIDN'T WANT TO BE A TIGER  
I JUST WANTED TO BE A FIREFIGHTER  
FRIENDS DOESN'T HELP ME  
I JUST GO ALONE  
WHEN I WAS A LITTLE KID,  
I DIDN'T WANT TO BE ALONE  
INSTEAD OF BEING A FRIEND,  
I WAS THE ANIMALS' ENEMY  
I JUST WANT FRIENDS!

STOP THIS NONSENSE. YOU'RE A TI-  
GER! WHAT IS YOUR QUOTE?

I AM MEAN  
I WILL EAT YOU, I WILL EAT YOU  
I WILL EAT YOU, NO QUESTIONS  
LIONS ARE MY FEAR  
BUT OTHER ANIMALS ARE MY TOYS



WHY DO YOU THINK  
I HAVE ANIMALS IN MY TUMMY?

I EAT SO MUCH ANIMALS  
I HAVE A TUMMYACHE  
I DON'T HAVE TO DO THIS ANYMORE  
BECAUSE I AM A THREAT TO THE FOOD  
CHAIN

I JUST REALIZED  
I DON'T HAVE TO BE A TIGER  
LET'S STOP THIS MUSIC  
AND BE A FIREFIGHTER

I WAS MEAN  
TELL YOU THE TRUTH  
ANIMALS WERE NOT TASTY

INSTEAD OF EATING,  
I WILL HELP YOU, I WILL HELP YOU  
I WILL HELP YOU, NO QUESTIONS

BECAUSE I AM THE KING OF THE WOOD

## Just Be Claws Tables

The Dantchik Family  
Cathy & Stephen Graham

## Koala Kids Table

Jenny & Jon Steingart

## What's Gnu Tables

Patrice & Louis Friedman  
Merritt Tilney & Douglas Kaden

## Owl for One Tables

Denise Burse & Peter Jay Fernandez  
Lawrence Catena  
CBS Corporation  
Dawkins Family Foundation  
Carolyn & Neil DeSena  
Myrna & Freddie Gershon  
Alexandra Gersten-Vassilaros & John Vassilaros  
Glen Gillen & Michael Lawrence  
Robert Goldberg, Yorke Construction Corporation  
Felicia & Sy Jacobs  
Valerie Kay & Bruce Graham  
Grace Lyu-Volckhausen, Tiger Baron Foundation  
Frances McDormand  
Music Theater International  
Rona & Randolph Nelson  
Steve Sabba, Tax Pro Financial Network, Inc.  
United Talent Agency  
Wendy vanden Heuvel & Brad Coley



## Inside Appearance

Lyrics by  
Alizette Zapata, age 16

Composed by  
Amanda Green

Performed by  
Marinda Anderson (Person 1)  
& Nathaly Lopez (Person 2)

Back-up vocals sung by  
Kendal Hartse &  
Catherine Cheng Jones

### PERSON 1

PEOPLE ALWAYS JUDGE FROM  
APPEARANCE,  
INSTEAD OF LOOKING AT WHAT'S  
INSIDE  
I DON'T WANT TO LIVE MY LIFE A LIE  
I DON'T WANT TO HIDE

YOU MAYBE BE RIGHT ABOUT A THING  
OR TWO  
BUT I AM MUCH MORE OF A PERSON  
WHO WOULD HAVE KNEW  
YOU CAN'T JUDGE OFF OF WHAT YOU  
SEE  
YOU HAVE TO LISTEN AND GET TO  
KNOW ME

### PERSON 2

IF YOU WANT ME TO GET TO KNOW  
YOU  
YOU HAVE TO SHOW ME HOW  
SHOW ME WHAT IS TRUE  
SHOW ME WHAT IS FOUL

### PERSON 1

EVERYONE IS DIFFERENT, IN THEIR  
OWN WAY  
I AM WHO I AM, WHAT CAN I SAY  
AND LIKE A TIGER I AM TOUGH,  
BUT I AM NOT EVIL NOR AM I ROUGH

I PROTECT THE PERSON WHO I  
CHOOSE TO BE  
WHO ARE YOU TO JUDGE ME  
BUT EVEN THOUGH I AM TOUGH,  
I HAVE A HEART THAT'S HAD ENOUGH

I OPEN UP TO BE HEARD,  
AND I WANT YOU TO HEAR EACH WORD

### PERSON 2

ACTIONS SPEAK LOUDER THAN  
WORDS  
AND YOU HAVE BEEN HEARD  
SHOW ME THE PART OF YOU THAT IS  
REAL  
AND I WILL TELL YOU HOW I FEEL

PEOPLE ALWAYS JUDGE FROM  
APPEARANCE  
INSTEAD OF LOOKING AT WHAT'S  
INSIDE  
SOMETIMES I DON'T WANT TO TRY  
SO I JUST SIT AND CRY

### PERSON 1

YOU SHOULDN'T HAVE TO LIVE A LIE  
YOU SHOULDN'T HAVE TO SIT AND CRY

### PERSON 2

I AM FOOLISH TO JUDGE, SORRY THAT  
I DID  
PROVE ME WRONG, PLEASE FORGIVE

### TOGETHER

PEOPLE NEED TO COME TOGETHER  
AND UNDERSTAND JUDGMENT IS BAD  
WE ALL NEED EACH OTHER  
WE ALL CAN USE A HAND

PEOPLE ALWAYS JUDGE FROM  
APPEARANCE  
INSTEAD OF LOOKING AT WHAT'S  
INSIDE  
LIVE TO BE WHO YOU ARE  
LIVE WITH CONFIDENCE AND PRIDE  
LIVE WITH CONFIDENCE AND PRIDE

## Elephants Are Cool

Lyrics by  
Adam Alkindi, age 12

Composed and performed by  
Oscar Isaac

Back-up vocals sung by  
Kendal Hartse &  
Catherine Cheng Jones

ELEPHANTS ARE KIND TO PEOPLE  
THEY ARE LOVING AND SWEET  
THEY GOT BIG FEET  
THEY CAN CRUSH YOU IN ONE STEP  
BUT DON'T FRET

ELEPHANTS ARE KIND TO PEOPLE  
KIND TO PEOPLE  
KIND TO PEOPLE  
KIND TO PEOPLE

PEOPLE WILL SAY "I DON'T WANT  
TO BE AN ELEPHANT"  
BUT THEY WILL CHANGE THEIR MINDS  
IF YOU LOOK AT THE GOOD TIMES

IF YOU ARE AFRAID OF THEM  
THEY WILL NOT HARM YOU  
BUT THEY WILL ALARM YOU

ELEPHANTS ARE KIND TO PEOPLE  
KIND TO PEOPLE  
KIND TO PEOPLE  
KIND TO PEOPLE

EVERYONE HAS AN ELEPHANT IN THE ROOM  
EVERY ELEPHANT IS SHY OF SOMETHING  
EVERY PERSON IS TOO  
YOU ARE NOT ALONE

EVERYONE IS NOT THE SAME  
YOU SHOULD TALK ABOUT IT  
AND LET IT OUT  
YOUR FEELINGS

ELEPHANTS ARE KIND TO PEOPLE  
KIND TO PEOPLE  
KIND TO PEOPLE  
KIND TO PEOPLE



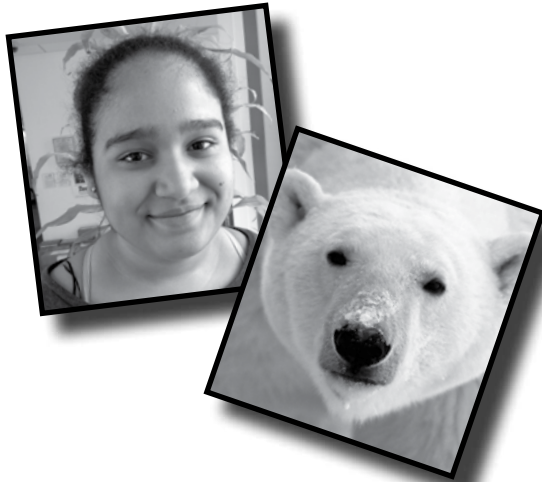

## It's A Blur

Lyrics by  
Chyanne Peña, age 12

Composed and  
Performed by  
Heather Robb &  
James Smith of  
The Spring Standards

I AM NO DIFFERENT FROM YOU  
FEELING OF BEING PITIED ON,  
I'M A BLIND POLAR BEAR  
I AM NOT DIFFERENT FROM YOU.

UNAWARE OF MY SURROUNDINGS.  
CONFUSED AS A NEWBORN CHILD.  
SCENT OF SURROUNDINGS, WINTER  
BREEZE,  
TOUCH OF THE COLD...IT WAS HOME.

HEARING A BEAUTIFUL SOUL BUT  
WANTING TO SEE IT,  
IT'S LIKE AN EYE WITH WATER IN IT,  
DARK AS THE NIGHT,  
YOU CAN ONLY MAKE OUT THE  
SILHOUETTE AND LIGHT.  
IT'S LIKE AN EYE WITH WATER IN IT.  
IT'S A BLUR.

AS A CUB, ALL I REMEMBER:  
ICE BREAKING, ANIMALS DYING,  
THE ZOO--FORCED INTO HIDING,  
NOT THE SAME, WILL NEVER BE.

UNAWARE, AGAIN-- THE ZOO  
TERRIFIED MORE THAN BEFORE,  
THE ZOO-- UNAWARE AGAIN.  
DIFFERENT FEELING, DIFFERENT  
TOUCH.

HEARING A BEAUTIFUL SOUL BUT  
WANTING TO SEE IT,  
IT'S LIKE AN EYE WITH WATER IN IT,  
DARK AS THE NIGHT,

YOU CAN ONLY MAKE OUT THE  
SILHOUETTE AND LIGHT.  
IT'S LIKE AN EYE WITH WATER IN IT.  
IT'S A BLUR.

A PART OF KNOWING IS KNOWING  
YOURSELF,  
IT'S LIKE LOOKING IN THE MIRROR BUT  
NOTHING REFLECTS BACK.  
WAIT—I CAN'T SEE, HOW WOULD I  
KNOW?  
IMAGINATION. IMAGINATION.

ACCEPTING MY BLINDNESS IS ALL THAT  
I CAN DO  
ENJOYING MY SURROUNDINGS, I  
KNOW THESE THINGS ARE TRUE:  
FREE AS A WINTER BREEZE,  
TOUCH OF THE COLD  
COLORS ARE A BEAUTIFUL THING,  
THEY CAN LIGHT UP A ROOM,  
A WORLD.  
IT'S A BEAUTIFUL THING.

HEARING A BEAUTIFUL SOUL BUT  
WANTING TO SEE IT,  
IT'S LIKE AN EYE WITH WATER IN IT,  
DARK AS THE NIGHT,  
YOU CAN ONLY MAKE OUT THE  
SILHOUETTE AND LIGHT.  
IT'S LIKE AN EYE WITH WATER IN IT.  
IT'S A BLUR.  
IT'S A BLUR.  
IT'S A BLUR.

## The Peacock Dance

Lyrics by  
Kaylee Zambrano, age 11  
Composed by Michael Mitnick

Performed by Greg Hildreth  
Back-up vocals sung by  
Kendal Hartse &  
Catherine Cheng Jones



DO DO DO DO

HI MY NAME IS BLUE FEATHERS AND I  
AM ELEVEN  
I LOVE THE RAINFOREST, IT FEELS LIKE  
HEAVEN

I'M DOING THIS DANCE TO SHOW I'M  
STRONG!!  
I JUST HOPE I WON'T DO IT WRONG.  
MY ANCESTORS WERE REALLY  
TOUGH!!  
I WANT TO BE, TOUGH ENOUGH.

I'M GOING TO DO THIS DANCE TO  
SHOW MY FRIENDS WHO'S BOSS  
IF THEY MAKE FUN OF MY DANCE,  
THEY'LL BE TOSSED!!

*CHORUS AND DANCE*  
TO DO THIS DANCE  
FAN OUT YOUR TAIL FEATHERS.  
FTRRRRRRRR!!!  
TO DO THIS STEP  
PUMP OUT YOUR CHEST LIKE YOU'RE  
BOSS: WHOOP!  
TO DO THIS PART OF THE DANCE,  
WALK AROUND IN A BIG CIRCLE LIKE  
YOU DON'T CARE.  
NOW THIS PART OF THE DANCE IS  
CALLED THE 'PEACOCK WIGGLE.'  
THIS DANCE MAKES YOU WANNA  
GIGGLE.

DO DO DO DO

MY FRIENDS ARE THE TOUGHEST IN  
SCHOOL  
I WANT THEM TO THINK I'M COOL

MY FRIENDS THINK I'M "WEAK"  
BUT THEY'LL BE THE ONES WHO WEEP.  
I'M DOING THIS DANCE TO PROVE  
THEY'RE WRONG.  
I PROMISE I'LL BE LOUD AND STRONG!

WHOEVER WANTS TO DO THE DANCE  
WITH ME STAND UP!!

*CHORUS AND DANCE REPEAT*

WHAT IF I DO THIS ALL WRONG  
WOULD IT CHANGE MY WHOLE LIFE?

I WOULD SHOW OFF TO THE GIRLS  
IT WOULD GET CROWDED  
ANOTHER PEACOCK WOULD  
THROW A BALL AT ME  
MY CHEST WOULD PUMP DOWN  
MY FEATHERS WOULD FALL DOWN  
THE GIRLS WOULD STOP GIGGLING  
AND THE BOYS WOULD BE SHOCKED.

I'LL PUSH THOSE THOUGHTS AWAY  
AND BRING OUT THE HOPE.  
I'LL THINK OF HAPPY THOUGHTS,  
'CAUSE SADNESS IS A NOPE!!

ONCE I'M TOUGH, I'LL BE CONGRATU-  
LATED,  
'CAUSE THEY'LL THROW ME A PARTY,  
AND I'LL BE CELEBRATED!  
THEN MY ANCESTORS WOULD BE  
PROUD OF ME  
BECAUSE NOW I'M THE TOUGHEST AS  
YOU CAN SEE...  
DANCE!!!

*CHORUS AND DANCE REPEAT*

The 52nd Street Project proudly presents  
**THE STAGE COMBAT PROGRAM'S FINAL PERFORMANCE**  
Friday, June 13<sup>th</sup> at 6:00 p.m.

*This program was led by fight choreographer Lee Rosen*

**LIFE'S NOT GOING TO BE THE WAY YOU WANT IT**

Written by Sasha Davis, age 12

Directed by Lindsay Torrey

Becky G. ....Sasha Davis

Melody..... Lindsay Torrey

Coach..... Natalie Hirsch

**THE BLUE PAST**

Written by Ashley Thomas, age 13

Directed by Anne Troup

Selena .....Ashley Thomas

Destiny ..... Anne Troup

**DON'T TAZE ME, BRO!**

Written by Ezekiel Albarron, age 11

Directed by Mat Hostetler

Zack .....Ezekiel Albarron

Mr. Security Guard ..... Mat Hostetler

**THE WORST AND THE BEST FRIENDS**

Written by Brooke Fraser, age 12

Dramaturged by Erin Cherry & Directed by Megan Cramer

Bayley ..... Brooke Fraser

Hayley ..... Megan Cramer

**IN THE WAY**

Written by Britney Trinidad, age 14

Directed by Joshua Joya

Britney ..... Britney Trinidad

Josh ..... Joshua Joya

**THE BACON EGG AND CHEESE BREAK OUT**

Written by David Ortiz, age 12

Directed by Bjorn DuPaty

Lui Calibre..... David Ortiz

Chef ..... Bjorn DuPaty

Security System ..... Natalie Hirsch



The 52nd Street Project gratefully acknowledges the support of the following foundations and corporations: Bloomberg; Brenner Family Foundation; Cantor Fitzgerald; CBS Corporation; The Common Sense Fund; Consolidated Edison; Dawkins Family Foundation; The Neil V. DeSena Foundation; The Dramatists Guild Fund; Dramatists Play Service; The Educational Foundation Of America; Sidney E. Frank Foundation; Goldman Sachs; The Horace W. Goldsmith Foundation; Heisman Foundation; Hudson Scenic Studio; Lotos Foundation; Ann M. Martin Foundation; Marusi Family Foundation; Monteforte Foundation; Newman's Own; The PAR Group; Pinkerton Foundation; Quadra Productions; Sesame Workshop; The Shubert Organization; Simon & Eisenberg; Starker Family Foundation; Harold & Mimi Steinberg Charitable Trust; Surdna Foundation; Susquehanna Investment Group; Tax Pro Financial Network, Inc.; TCG; Theater Subdistrict Council; Tiger Baron Foundation; Van Deusen Family Fund; Vervane Foundation; Watkins, Inc.; WMEE Foundation; Yorke Construction Corp.

- |                                      |   |   |                                       |
|--------------------------------------|---|---|---------------------------------------|
| Robert Abrams<br>& Cynthia Vance     | Penelope Collins<br>Judith-Ann Corrente           | Sarah Horowitz<br>& David Venarde           | Sue Phillips<br>Todd Poisson          |
| George Ackert                        | Janet Coviello                                    | Andrea Johnson                              | Suzanne Poulin                        |
| Michael Alicastro                    | William Crudup                                    | Beth Ifcher                                 | Helaine & Michael Pruzan              |
| Elton Andrews                        | Kyle Czepiel                                      | Carine Joannou                              | Christopher Randolph                  |
| Richard Anthony                      | Arthur Dantchik                                   | Kristen Johanson                            | Helen & Peter Randolph                |
| Cecilia Arana                        | Cathy Dantchik                                    | Andrea Johnson                              | Jacquelyn Reingold                    |
| Emily Armstrong                      | Leslie Dantchik                                   | Cindy Kaplan & David Froelich               | Anita A. Rogerson                     |
| James Armstrong                      | Peter & Judith Dawkins                            | Valerie Kay & Bruce Graham                  | David Ross & Laura Ross               |
| Dominick & Ilene Balletta            | Carolyn & Neil DeSena                             | Louise Klebanoff                            | Dr. Steve Rudin                       |
| Becky Ann & Dylan Baker              | Rebecca & Richard Dresser                         | Henry Krieger & Robert Joy                  | Laura Sametz & Anton Fig              |
| Ken Bantum                           | Peter Doyle                                       | Jacki Ochs & Jan Kroeze                     | Karin & Thomas Schall                 |
| Carolyn Bechtel                      | Max Dyksterhouse<br>& David Roady                 | Judy Kuhn & David Schwab                    | Maury Schott                          |
| Lisa Benavides<br>& Tim Blake Nelson | Doug Eisenberg                                    | Frances & Fred Langbecker                   | Susan Schroeder<br>& Britt Adams      |
| Louisa Benton                        | Lynn Ellenberg                                    | Gabrielle Lansner<br>& Dean Taucher         | Whitney Scott<br>& Peter Jacobson     |
| Gavin Berger<br>& Craig Berggren     | Nora Ephron<br>& Nicholas Pileggi                 | Brian Lapin                                 | Meg Simon                             |
| Stephanie Berger & Paul King         | Peter Jay Fernandez                               | Michael Lawrence<br>& Glen Gillen           | Christopher Solomon                   |
| Beth & Eric Berman                   | & Denise Burse Fernandez                          | Warren Leight & Karen Hauser                | Jonathan Soros<br>& Jennifer Soros    |
| David Beth                           | Liz Flahive & Jeff Cox                            | Mickey Lemle                                | Jenny & Jon Steingart                 |
| Lewis Black                          | Wendy Flanagan<br>& Chris O'Malley                | Jonathan Levine                             | Tracy Straus                          |
| Emily Blavatnik                      | Karen & Paul Freitas                              | Helen Levy                                  | Danny Strong                          |
| Allison Blinken                      | Sally Froelich                                    | Melissa Liebling-Goldberg<br>& John Barrett | Al Styron & Ed Beason                 |
| Noah Bogan                           | Alexandra Garrison                                | Kay M. Lim                                  | Susanna Styron                        |
| Jane Bolster<br>& Steve Wertimer     | Beverly Gasner                                    | Adrienne Lobel                              | Richard Sweren                        |
| Buzz Bovshow                         | Rose Gasner & Larry Chertoff                      | John Lynch                                  | Lili Taylor                           |
| Blaise R. Box                        | Celia Gerard & Mark McGrath                       | Grace Lyu-Volckhausen                       | Lisa Tilney & Chris Lawrence          |
| Becky Browder<br>& Ted Neustadt      | Christina Gerber                                  | Julie & Alex Margolies                      | Merritt Tilney & Douglas Kaden        |
| Carlton T. Brown                     | Freddie & Myrna Gershon                           | Ali Marsh                                   | Lorraine Tobias & Alex Draper         |
| Iris A. Brown & Joe White            | Jenny Gersten & Willie Reale                      | Lin Manuel Miranda                          | Liz Tuccillo                          |
| Justin Brownhill                     | Alexandra Gersten-Vassilaros<br>& John Vassilaros | Frances McDormand<br>& Joel Coen            | Laura Valeroso<br>& David Seidman     |
| Brian Byrnes                         | Scott Aaron Gewirtz<br>& Laura Gewirtz            | Emily & John Morgan                         | Wendy vanden Heuvel<br>& Brad Coley   |
| Shawn & Laura Byron                  | Elizabeth Giamatti                                | Amanda & Neal Moszkowski                    | Susan J. Vitucci                      |
| Joseph Capozzi                       | Robert Goldberg<br>& Betsy MacIsaac               | Suzen Murakoshi<br>& Mark Temme             | Mary Pat Walsh                        |
| Leah Carr                            | Stephen & Cathy Graham                            | Fred Nelson                                 | Dr. Mildred Walton                    |
| Lawrence Catena                      | Jan Gura & Alan Pickman                           | Randy & Rona Nelson                         | Brenda Wehle & John C. Lynch          |
| Chris Ceraso                         | Susan Hanson                                      | Ruth Nelson                                 | Carol Whitesides                      |
| Rachel Chanoff                       | Jessica Hecht                                     | Lori O'Connor                               | Zee Wiener                            |
| Todd Christie                        | & Adam Bernstein                                  | Carol Ochs & Bruce MacVittie                | Ruth Ann Wynter                       |
| Damien Clancy                        | Kathy & Jamie Herring                             | Jacki Ochs & Jan Kroeze                     | J.P. Xenakis                          |
| Matthew Clancy                       | Peter Herdrich & Karen Trott                      | Kevin O'Rourke<br>& Edith Thurber           | Carole Yass                           |
| Katie Clark                          | William Holtzman                                  | Jane Perlmutter                             | Yildiz Yuksek<br>& Richard Blackstone |
| Elizabeth Clemants                   | & S. Sylvia Shepard                               | & Greg MacPherson                           | Connie & Marc Zand                    |
| David Cohen<br>& Sandra Novak Cohen  | Mary Horowitz                                     | Elizabeth Peters                            |                                       |
| Larry Cohen                          |   |   |                                       |

THE 52ND STREET PROJECT PRESENTS

# WHAT'S MY LINE?



## THE PROFESSIONAL PLAYS

THE 2014 BLOCK ISLAND ONE-ON-ONES

Friday, July 18 at 7:30 🕒 Saturday, July 19 at 7:30 🕒 Sunday, July 20 at 3:00

The 52nd Street Project's Five Angels Theater

# WHAT'S MY LINE? THE PROFESSIONAL PLAYS

The Annual Block Island One-on-Ones - July 18-20, 2014 at the Five Angels Theater

## The 52nd Street Project Staff

Gus Rogerson, Artistic Director  
 Natalie Hirsch, Associate Artistic Director  
 George Babiak, Production Manager  
 Ray Harold, Technical Director

Carol Ochs, Executive Director  
 Lisa Kerner, Development & Mgmt. Associate  
 John Sheehy, Dir. of Development & Marketing  
 Alyssa Anderson, Mgr. of Individual Giving

Liz Bell, Director of Education  
 Johanna Vidal, Community Coordinator

### Consultants

Iris A. Brown, Graphic Designer; Chris Ceraso, Teen Dean

### Interns

Bronagh Daly, Garrett Kim, Clara Leonard

### Teen Employees

Receptionists: Britney Trinidad, Alizette Zapata  
 Block Island Teen Counselor: Haley Martinez  
 Ushers: Nick Carrero, Chamel Rodney, Nathaly Trinidad, Tiara Varela

## “WHAT'S MY LINE?” Production Staff

### Composer/Music Director

Kim D. Sherman

### Set Designer

Kevin Joseph Roach

### Lighting Designer

Ben Fichthorn

### Costume Designer

Kimberly Goings

### The Goddess of Sound

Vanessa Valdes

### Stage Manager

Liz Bell

### Projection Designs

George Babiak and The 52nd Street  
 Project Projection Archive

### Prop Design Team

George Babiak, Bronagh Daly,  
 Garrett Kim, Clara Leonard

### Backstage Crew

Bronagh Daly, Emily Juliani, Garrett Kim,  
 Clara Leonard, Haley Martinez

### House Managers

Carol Ochs, Alyssa Anderson

### Flyer/Program Art

Patrick Jones

### Chefs

Martha Velie-Gass, Alyssa Anderson,  
 and Vanessa Valdes



The One-on-One Program is made possible with public funds from The New York State Council on the Arts, a state agency, and the New York City Department of Cultural Affairs. The 52nd Street Project is a member of Art/NY and Theatre Communications Group (TCG), the national organization for the American theatre.

## COOL STUFF ON SALE IN THE LOBBY!

Fabulous Flyer Bars .....\$2.50  
*and featuring Shel Silverstein's "Fivey and Twoey" logo:*  
 Project Hoodies .....\$30.00  
 Project Caps .....\$20.00  
 Project T-shirts ..... \$12.00/\$20.00  
 Project Mugs ..... \$5.00  
 Project Notebook ..... \$5.00  
 Project Pencil 3-pack ..... \$1.00

Thank you for coming to WHAT'S MY LINE. If you are not on our mailing list (or if your address has changed), please fill out this form and give it to us on your way out or mail it to the address below. We would also like to know if you are interested in becoming a volunteer. We need help in all areas, so be sure to fill out the entire form.

PLEASE ADD ME TO YOUR MAILING LIST:

07/14

NAME \_\_\_\_\_

ADDRESS \_\_\_\_\_

CITY \_\_\_\_\_

STATE \_\_\_\_\_

ZIP \_\_\_\_\_

HOME PHONE \_\_\_\_\_

DAYTIME OR MOBILE PHONE \_\_\_\_\_

E-MAIL ADDRESS \_\_\_\_\_

MY OCCUPATION \_\_\_\_\_

MY HOBBIES \_\_\_\_\_

YES, I WOULD LIKE TO BE OF HELP. I CAN:

- |   |   |  |
|---|---|--|
| <input type="checkbox"/> Help load in and out for shows | <input type="checkbox"/> Draw and/or paint  | <input type="checkbox"/> Help kids with homework |
| <input type="checkbox"/> Hang lights                    | <input type="checkbox"/> Help with mailings | <input type="checkbox"/> Teach kids a skill      |
| <input type="checkbox"/> Work on a backstage crew       | <input type="checkbox"/> Do office work     | <input type="checkbox"/> Be a chef at an event   |
| <input type="checkbox"/> Do graphic design              | <input type="checkbox"/> Design sound       | <input type="checkbox"/> Design and sew costumes |
| <input type="checkbox"/> Other (please specify) _____   |   |  |

MY SCHEDULE IS:

- Very flexible. I'm often available during weekdays.  
 Somewhat flexible. I can help on the occasional morning or afternoon during the week.  
 Not very flexible at all, but I've got some free time on evenings and weekends.

If you would like to mail this (and you're always welcome to enclose a tax-deductible contribution), you can send it to: The 52nd Street Project, 789 10th Avenue, New York, NY 10019. Or fax it to (212) 333-5598.

COME BACK NEXT MONTH FOR...

WHAT'S MY LINE?



THE PROFESSIONAL PLAYS

THE 2014 WAREHAM, MASS. ONE-ON-ONES



### KEEP AN EYE OUT!

We are always searching for interns.

If you know of any college or graduate students who might enjoy working with us, playing with us, and going on trips with us for a semester, please have them contact Lisa Kerner. We are especially looking for interns for Spring 2015.

### The 52nd Street Project Board of Directors

Lisa Benavides	Carol Ochs
Rachel Chanoff	Willie Reale, founder
Cathy Dantchik, co-chair	Gus Rogerson
Carolyn DeSena	Shirley Rumierk, alumni member
Wendy Ettinger, chair emeritus	José Soto, Jr., alumni member
Louis P. Friedman, co-chair	Jenny Steingart
Robert Goldberg	Lisa Tilney
Stephen Graham, chair emeritus	Merritt Tilney
Valerie Kay	Wendy vanden Heuvel
Frances McDormand	John A. Vassilaros
Noël Mihalow	Mark Whatley

### What's Going On Here?

The 52nd Street Project is a non-profit organization that brings children from the Hell's Kitchen neighborhood together with professional theater artists to create original theater. WHAT'S MY LINE is a production of our One-on-One program, which is designed to give children the opportunity to go away for one-week stays in the country and enjoy the undivided attention of a professional theater artist who serves as friend, mentor, and collaborator.

### In-Kind Contributions

Abbeville Press; abc cocina; Alvin Ailey American Dance Theater; Richard Anthony; Lewis Black; Iris A. Brown Design; William Curran & A Curran Affair; Emmett Global; Evercore Partners; Edie Falco; Jenny Gersten & Friends of The High Line; Google; Jonathan Groff; ICI; Karen Kowgios of Fried & Kowgios; Charlie Marshal & the Marshal Restaurant; Noël & Joe Mihalow; Neustar; Nonesuch Records; Pharma Print; the Public Theater; Sesame Workshop; Wendy Stuhlberg; Tao Restaurant; Uber; John A. Vassilaros; Watkins, Inc.; and Paul, Weiss, Rifkind, Wharton & Garrison LLP.

### Special Thanks

Our Host Families- Allison and Michael Anderson; Susan Bush; Socha Cohen; Katy Homans and Patterson Sims; Cathy Joyce and Nigel Grindley; Susan Matheke and Willie Feuer; Leslie Parsons; Joya Verde and Virginia Dare; and our magnanimous headquarters host Carl Kauffman. Sincere thanks to our chefs Martha Velie-Gass and Sean and Amanda Gass; Kate and Sam Bird; McQuade's Marketplace; Robbie Brown; Rita and Steve Draper; Jessie Edwards; Kim Gaffett; Amelia Gallant at the Block Island Grocery; Cindy and Stan Geer at the Depot; Glenn and Annie Hall; Debbie Hart; Interstate Navigation; Josie Merck and Jim Stevenson; Ron and Judy Tierney.

## WHAT'S MY LINE? THE PROFESSIONAL PLAYS - ACT 1

All original music composed by Kim D. Sherman  
*What's My Line Theme Song* lyrics by John Sheehy

### THE TOWERING TERROR

By Deirdre O'Connor for Duaa Alkindi, age 11

Wendy ..... Duaa Alkindi  
Officer Six ..... Dahlia Azama  
Officer Grumps ..... Haley Martinez

*Bring It On* lyrics by Deirdre O'Connor.

### SASSY SISTERS

By Nicholas Platt, Jr. for Allyssia Feliciano, age 12

So Glam Pam ..... Allyssia Feliciano  
Tomboy Tina ..... Emma Galvin  
Ryan Brian McRyan ..... Garrett Kim

*The Sassy Sisters Song* lyrics by Nicholas Platt, Jr.

### 'FRAIDY CAT

By Sung Rno for Adam Alkindi, age 13

Apollo ..... Adam Alkindi  
Curtis ..... Michael Propster  
Smokey ..... Alyssa Anderson

*Cold Paws* lyrics by Sung Rno.

### THE PRESIDENT... AND HER SISTER

By Daiva Deupree for Kayla Ortiz, age 13

President Arnaz ..... Kayla Ortiz  
Valerie Arnaz ..... Daiva Deupree  
Sam ..... Haley Martinez  
Polvalaitis ..... George Babiak  
Announcer ..... Clara Leonard

*Grow Up/Grow Down* lyrics by Daiva Deupree.

### JESTER THING

By John Sheehy for Milen Tokarev, age 11

Ivor Goodwon ..... Milen Tokarev  
Lord Edgeworth ..... John Sheehy  
Guard ..... Clara Leonard

*Surely You Jest* lyrics by John Sheehy.

## WHAT'S MY LINE? THE PROFESSIONAL PLAYS - ACT 2

### COMPASSIONATE PIRATES

By Willie Reale for Kaylee Zambrano, age 11

Helen ..... Kaylee Zambrano  
Ariadne ..... Amirah Vann  
Military Guy ..... Garrett Kim

*A Dinghy Full of Blues* and *Compassionate Pirates* lyrics by Willie Reale.

### SAVING THE DRAGON

By Jeremy Rishe for David Ortiz, age 12

Vidal ..... David Ortiz  
Merv ..... Jeremy Rishe  
Jeremy The Boss ..... Gus Rogerson  
Game Voice ..... Bronagh Daly  
Angel Guide ..... Clara Leonard  
Dragon ..... Garrett Kim  
Chorus ..... Amirah Vann, Alyssa Anderson and Garrett Kim

*Ones and Zeros* lyrics by Jeremy Rishe.

### ANGEL AND MINNIE IN THE AFTERNOON

By Catherine Yu for Kiara Figueroa, age 11

Angel ..... Kiara Figueroa  
Minnie ..... Carra Paterson

*The Sister Song* lyrics by Catherine Yu.

### PHANTASMO!

By Itamar Moses for Joshua Gomez, age 12

Phantasma ..... Joshua Gomez  
Coach ..... Stephen O'Reilly

*What To Do?* lyrics by Itamar Moses.

### OPEN WIDE

By Madeleine George for Karen Tineo, age 11

Jessie Maldonado ..... Karen Tineo  
Dr. Alan Williams ..... Genesis Oliver  
Denise ..... Alyssa Anderson

*The Phobics' Lament* and *The Phobics' Reprieve* lyrics by Madeleine George.

The 52nd Street Project gratefully acknowledges the support of the following foundations and corporations: Brenner Family Foundation; Cantor Fitzgerald; Bull's Head Foundation; Carnegie Corporation of New York; CBS Foundation; City Winery; Common Sense Fund; Consolidated Edison; Dawkins Family Foundation; The Neil V. DeSena Foundation; Dramatists Guild Fund; Dubin Foundation; Educational Foundation of America; Evercore Partners; Harkness Foundation; HBO; Horace W. Goldsmith Foundation; I. Weiss; Jean & Louis Dreyfus Foundation; Kirkland & Ellis Foundation; Liquid Holdings Group; Ann M. Martin Foundation; Marusi Family Foundation; Newman's Own; Ninth Avenue Association; PAR Group; Parsons Family Foundation; Pinkerton Foundation; Rockefeller Foundation; The Shubert Organization; Slate Path Capital; Harold & Mimi Steinberg Charitable Trust; Surdna Foundation; Susquehanna Foundation; Tax Pro Financial Network; Tiger Baron Foundation; United Talent Agency; Yorke Construction Corp; ZenithOptimedia. (List current as of 7/1/13)

- |                                      |   |   |                                       |
|--------------------------------------|---|---|---------------------------------------|
| Robert Abrams<br>& Cynthia Vance     | Penelope Collins<br>Judith-Ann Corrente           | Sarah Horowitz<br>& David Venarde           | Sue Phillips<br>Todd Poisson          |
| George Ackert                        | Janet Coviello                                    | Andrea Johnson                              | Suzanne Poulin                        |
| Michael Alicastro                    | William Crudup                                    | Beth Ifcher                                 | Helaine & Michael Pruzan              |
| Elton Andrews                        | Kyle Czepiel                                      | Carine Joannou                              | Christopher Randolph                  |
| Richard Anthony                      | Arthur Dantchik                                   | Kristen Johanson                            | Helen & Peter Randolph                |
| Cecilia Arana                        | Cathy Dantchik                                    | Andrea Johnson                              | Jacquelyn Reingold                    |
| Emily Armstrong                      | Leslie Dantchik                                   | Cindy Kaplan & David Froelich               | Anita A. Rogerson                     |
| James Armstrong                      | Peter & Judith Dawkins                            | Valerie Kay & Bruce Graham                  | David Ross & Laura Ross               |
| Dominick & Ilene Balletta            | Carolyn & Neil DeSena                             | Louise Klebanoff                            | Dr. Steve Rudin                       |
| Becky Ann & Dylan Baker              | Rebecca & Richard Dresser                         | Henry Krieger & Robert Joy                  | Laura Sametz & Anton Fig              |
| Ken Bantum                           | Peter Doyle                                       | Jacki Ochs & Jan Kroeze                     | Karin & Thomas Schall                 |
| Carolyn Bechtel                      | Max Dyksterhouse<br>& David Roady                 | Judy Kuhn & David Schwab                    | Maury Schott                          |
| Lisa Benavides<br>& Tim Blake Nelson | Doug Eisenberg                                    | Frances & Fred Langbecker                   | Susan Schroeder<br>& Britt Adams      |
| Louisa Benton                        | Lynn Ellenberg                                    | Gabrielle Lansner<br>& Dean Taucher         | Whitney Scott<br>& Peter Jacobson     |
| Gavin Berger<br>& Craig Berggren     | Nora Ephron                                       | Brian Lapin                                 | Meg Simon                             |
| Stephanie Berger & Paul King         | & Nicholas Pileggi                                | Michael Lawrence<br>& Glen Gillen           | Christopher Solomon                   |
| Beth & Eric Berman                   | Peter Jay Fernandez<br>& Denise Burse Fernandez   | Warren Leight & Karen Hauser                | Jonathan Soros<br>& Jennifer Soros    |
| David Beth                           | Liz Flahive & Jeff Cox                            | Mickey Lemle                                | Jenny & Jon Steingart                 |
| Lewis Black                          | Wendy Flanagan                                    | Jonathan Levine                             | Tracy Straus                          |
| Emily Blavatnik                      | & Chris O'Malley                                  | Helen Levy                                  | Danny Strong                          |
| Allison Blinken                      | Karen & Paul Freitas                              | Melissa Liebling-Goldberg<br>& John Barrett | Al Styron & Ed Beason                 |
| Noah Bogdan                          | Sally Froelich                                    | Kay M. Lim                                  | Susanna Styron                        |
| Jane Bolster<br>& Steve Wertimer     | Alexandra Garrison                                | Beverly Gasner                              | Richard Sweren                        |
| Buzz Bovshow                         | Rose Gasner & Larry Chertoff                      | John Lynch                                  | Lili Taylor                           |
| Blaise R. Box                        | Celia Gerard & Mark McGrath                       | Grace Lyu-Volckhausen                       | Lisa Tilney & Chris Lawrence          |
| Becky Browder<br>& Ted Neustadt      | Christina Gerber                                  | Julie & Alex Margolies                      | Merritt Tilney & Douglas Kaden        |
| Carlton T. Brown                     | Freddie & Myrna Gershon                           | Ali Marsh                                   | Lorraine Tobias & Alex Draper         |
| Iris A. Brown & Joe White            | Jenny Gersten & Willie Reale                      | Lin Manuel Miranda                          | Liz Tuccillo                          |
| Justin Brownhill                     | Alexandra Gersten-Vassilaros<br>& John Vassilaros | Frances McDormand<br>& Joel Coen            | Laura Valeroso<br>& David Seidman     |
| Brian Byrnes                         | Scott Aaron Gewirtz<br>& Laura Gewirtz            | Emily & John Morgan                         | Wendy vanden Heuvel<br>& Brad Coley   |
| Shawn & Laura Byron                  | Elizabeth Giamatti                                | Amanda & Neal Moszkowski                    | Susan J. Vitucci                      |
| Joseph Capozzi                       | Robert Goldberg                                   | Suzen Murakoshi<br>& Mark Temme             | Mary Pat Walsh                        |
| Leah Carr                            | & Betsy MacIsaac                                  | Fred Nelson                                 | Dr. Mildred Walton                    |
| Lawrence Catena                      | Stephen & Cathy Graham                            | Randy & Rona Nelson                         | Brenda Wehle & John C. Lynch          |
| Chris Ceraso                         | Jan Gura & Alan Pickman                           | Ruth Nelson                                 | Carol Whitesides                      |
| Rachel Chanoff                       | Susan Hanson                                      | Lori O'Connor                               | Zee Wiener                            |
| Todd Christie                        | Jessica Hecht<br>& Adam Bernstein                 | Carol Ochs & Bruce MacVittie                | Ruth Ann Wynter                       |
| Damien Clancy                        | Kathy & Jamie Herring                             | Jacki Ochs & Jan Kroeze                     | J.P. Xenakis                          |
| Matthew Clancy                       | Peter Herdrich & Karen Trott                      | Kevin O'Rourke<br>& Edith Thurber           | Carole Yass                           |
| Katie Clark                          | William Holtzman<br>& S. Sylvia Shepard           | Jane Perlmutter<br>& Greg MacPherson        | Yildiz Yuksek<br>& Richard Blackstone |
| Elizabeth Clemants                   | Mary Horowitz                                     | Elizabeth Peters                            | Connie & Marc Zand                    |
| David Cohen<br>& Sandra Novak Cohen  |   |   |                                       |
| Larry Cohen                          |   |   |                                       |

THE 52ND STREET PROJECT PRESENTS

# WHAT'S MY LINE?



## THE PROFESSIONAL PLAYS

THE 2014 WAREHAM, MASS. ONE-ON-ONES

Friday, Aug. 15 at 7:30 ♦ Saturday, Aug. 16 at 7:30 ♦ Sunday, Aug. 17 at 3:00

The 52nd Street Project's Five Angels Theater

# WHAT'S MY LINE? THE PROFESSIONAL PLAYS

The Annual Wareham One-on-Ones - Aug. 15-17, 2014 at the Five Angels Theater

## The 52nd Street Project Staff

Gus Rogerson, Artistic Director  
 Natalie Hirsch, Associate Artistic Director  
 George Babiak, Production Manager  
 Ray Harold, Outgoing Technical Dir.  
 Davey Rogulich, Incoming Technical Dir.

Carol Ochs, Executive Director  
 Lisa Kerner, Development & Mgmt. Associate  
 John Sheehy, Dir. of Development & Marketing  
 Alyssa Anderson, Mgr. of Individual Giving

Liz Bell, Director of Education  
 Johanna Vidal, Community Coordinator

### Consultants

Iris A. Brown, Graphic Designer; Chris Ceraso, Teen Dean

### Interns

Bronagh Daly, Garrett Kim, Clara Leonard

### Teen Employees

Receptionists: Britney Trinidad, Alizette Zapata  
 Wareham Teen Counselor: Dante Quiñones  
 Ushers: Michael Bannister, Jazmine Mikell, Chayse Peña  
 Concessions: Jasmine Correa

## “WHAT'S MY LINE?” Production Staff

### Composer/Music Director

Eric March

### Set Designer

Kevin Joseph Roach

### Lighting Designer

Greg MacPherson

### Costume Designer

Sarah Swafford

### Sound Designer

Garrett Kim

### Stage Manager

Colleen Sherry

### Projection Designs

George Babiak and The 52nd Street  
 Project Projection Archive

### Prop Design Team

George Babiak, Bronagh Daly,  
 Garrett Kim, Clara Leonard

### Backstage Crew

Bronagh Daly, Clara Leonard,  
 Dante Quiñones, Jamie Yip

### House Managers

Carol Ochs, Alyssa Anderson

### Flyer/Program Art

Patrick Jones

### Chefs

John Sheehy, Liz Bell, Carol Ochs,  
 Christopher Randolph



The One-on-One Program is made possible with public funds from The New York State Council on the Arts, a state agency, and the New York City Department of Cultural Affairs. The 52nd Street Project is a member of Art/NY and Theatre Communications Group (TCG), the national organization for the American theatre.

## COOL STUFF ON SALE IN THE LOBBY!

Fabulous Flyer Bars.....\$2.50  
*and featuring Shel Silverstein's "Fivey and Twoey" logo:*  
 Project Hoodies..... \$30.00  
 Project Caps ..... \$20.00  
 Project T-shirts..... \$12.00/\$20.00  
 Project Mugs ..... \$5.00  
 Project Notebook ..... \$5.00  
 Project Pencil 3-pack..... \$1.00  
 Project Tote Bags ..... \$5.00

Thank you for coming to WHAT'S MY LINE. If you are not on our mailing list (or if your address has changed), please fill out this form and give it to us on your way out or mail it to the address below. We would also like to know if you are interested in becoming a volunteer. We need help in all areas, so be sure to fill out the entire form.

PLEASE ADD ME TO YOUR MAILING LIST:

08/14

NAME \_\_\_\_\_

ADDRESS \_\_\_\_\_

CITY \_\_\_\_\_

STATE \_\_\_\_\_

ZIP \_\_\_\_\_

HOME PHONE \_\_\_\_\_

DAYTIME OR MOBILE PHONE \_\_\_\_\_

E-MAIL ADDRESS \_\_\_\_\_

MY OCCUPATION \_\_\_\_\_

MY HOBBIES \_\_\_\_\_

YES, I WOULD LIKE TO BE OF HELP. I CAN:

- |   |   |  |
|---|---|--|
| <input type="checkbox"/> Help load in and out for shows | <input type="checkbox"/> Draw and/or paint  | <input type="checkbox"/> Help kids with homework |
| <input type="checkbox"/> Hang lights                    | <input type="checkbox"/> Help with mailings | <input type="checkbox"/> Teach kids a skill      |
| <input type="checkbox"/> Work on a backstage crew       | <input type="checkbox"/> Do office work     | <input type="checkbox"/> Be a chef at an event   |
| <input type="checkbox"/> Do graphic design              | <input type="checkbox"/> Design sound       | <input type="checkbox"/> Design and sew costumes |
| <input type="checkbox"/> Other (please specify) _____   |   |  |

MY SCHEDULE IS:

- Very flexible. I'm often available during weekdays.  
 Somewhat flexible. I can help on the occasional morning or afternoon during the week.  
 Not very flexible at all, but I've got some free time on evenings and weekends.

If you would like to mail this (and you're always welcome to enclose a tax-deductible contribution), you can send it to: The 52nd Street Project, 789 10th Avenue, New York, NY 10019. Or fax it to (212) 333-5598.

COMING TO OUR STAGE...



# JUST DESSERTS

PLAYS WITH CONSEQUENCES

## THE 2014 PLAYBACK PLAYS

The reverse of the One-on-One's!  
Kids write plays for themselves and an  
adult partner to perform together.

October 24-26 right here at  
**THE FIVE ANGELS THEATER**

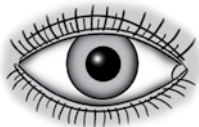

### KEEP AN EYE OUT!

We are always searching for interns.

If you know of any college or graduate students who might enjoy working with us, playing with us, and going on trips with us for a semester, please have them contact Lisa Kerner. We are especially looking for interns for Spring 2015.

### The 52nd Street Project Board of Directors

Lisa Benavides	Carol Ochs
Rachel Chanoff	Willie Reale, founder
Cathy Dantchik, co-chair	Gus Rogerson
Carolyn DeSena	Shirley Rumierk, alumni member
Wendy Ettinger, chair emeritus	José Soto, Jr., alumni member
Louis P. Friedman, co-chair	Jenny Steingart
Robert Goldberg	Lisa Tilney
Stephen Graham, chair emeritus	Merritt Tilney
Valerie Kay	Wendy vanden Heuvel
Frances McDormand	John A. Vassilaros
Noël Mihalow	Mark Whatley

### What's Going On Here?

The 52nd Street Project is a non-profit organization that brings children from the Hell's Kitchen neighborhood together with professional theater artists to create original theater. WHAT'S MY LINE is a production of our One-on-One program, which is designed to give children the opportunity to go away for one-week stays in the country and enjoy the undivided attention of a professional theater artist who serves as friend, mentor, and collaborator.

### In-Kind Contributions

Abbeville Press; abc cocina; Alvin Ailey American Dance Theater; Richard Anthony; Lewis Black; Iris A. Brown Design; William Curran & A Curran Affair; Emmett Global; Evercore Partners; Edie Falco; Jenny Gersten & Friends of The High Line; Google; Jonathan Groff; ICI; Karen Kowgios of Fried & Kowgios; Charlie Marshal & the Marshal Restaurant; Noël & Joe Mihalow; Neustar; Nonesuch Records; Pharma Print; the Public Theater; Sesame Workshop; Wendy Stuhlberg; Tao Restaurant; Uber; John A. Vassilaros; Watkins, Inc.; and Paul, Weiss, Rifkind, Wharton & Garrison LLP.

### Special Thanks

Our Host Families- Peter, Helen & Christopher Randolph; Pam & Don Foster; Sam & Gerry Gray; Anne & Colin McNay, Joe McNay, Gray & Rosemary Watson, Marina & Bob Whitman. Thank you also to Robin Morse; Lucy & Francis Rogerson; Vanessa Valdes; Bruce & Sophia MacVittie; & Bob Krystolfolski.

## WHAT'S MY LINE? THE PROFESSIONAL PLAYS - ACT 1

All original music composed by Eric March  
*What's My Line Theme Song* lyrics by John Sheehy

### DUEL MEANING

Written and Directed by George Babiak for Sebastian Lopez, age 10

Cunningham ..... Sebastian Lopez  
Robertson ..... George Babiak  
Piccadilly ..... John Sheehy  
Farquhar ..... Dante Quiñones

*"10 Paces of Destiny"* lyrics by George Babiak

### ZOMBIE ZONE

Written by Cindy Kaplan for Tiffany Miller, age 12. Directed by Anne Troup.

K.C. .... Tiffany Miller  
Barb ..... Anne Troup  
Joanne ..... Natalie Hirsch  
Roger ..... John Sheehy

*"Just Like You"* lyrics by Cindy Kaplan

### LIFE IS ONCE

Written and Directed by Jedidiah Clarke for Matthew Orozco, age 13

Troy ..... Matthew Orozco  
Carl ..... Jedidiah Clarke  
Bear ..... Dante Quiñones  
Raccoons ..... Dante Quiñones, Bronagh Daly, Jamie Yip

*"We Made It"* lyrics by Jedidiah Clarke

### MIDNIGHT IN THE WOODS

Written by Erica Saleh for Sofia Santoni, age 12

Directed by Grace Rex

Sarah ..... Sofia Santoni  
Kristie ..... Grace Rex

*"If You Got Your Way"* lyrics by Erica Saleh

### JINX, I WIN

Written and Directed by Carlo Albán for Nathaniel Ortiz, age 10

Charlie ..... Nathaniel Ortiz  
Austin ..... Carlo Albán  
Commuter ..... Natalie Hirsch  
Bus Driver ..... Clara Leonard

*"I Laugh When"* lyrics by Carlo Albán

## WHAT'S MY LINE? THE PROFESSIONAL PLAYS - ACT 2

### THE AMAZING BULLSEYE CARNIVAL SKYDIVING SHARKTANK APPRENTICE MAKES A DEAL

Written by Jiehae Park for Sevan Asencio, age 11. Directed by Korey Jackson.

A ..... Sevan Asencio  
B ..... Korey Jackson  
Donald Trump ..... Christopher Randolph

*"Need to Know"* lyrics by Jiehae Park

### THE INCIDENT INVOLVING SOUP AND TEA

Written by Sarah Burgess for Kayla Matos, age 12. Directed by Ariana Seigel.

Lacey ..... Kayla Matos  
Sloane ..... Ariana Seigel

*"For Real"* lyrics by Sarah Burgess

### THE HELL'S KITCHEN BOMB SQUAD: COUNTDOWN TO WORLD DESTRUCTION

Written by Darcy Fowler for Kai Ceniza, age 11

Directed by Lucy DeVito

Jenkins ..... Kai Ceniza  
McMullan ..... Lucy DeVito  
Sally ..... Bronagh Daly (Saturday: Natalie Hirsch)  
Bomb Cruise ..... Dante Quiñones  
Woman's Computer Voice ..... Natalie Hirsch (Sat: Clara Leonard)

*"My Way"* lyrics by Darcy Fowler

### OH SNAP

Written by Robert Askins for Ezekiel Albarron, age 12

Directed by Aaron Costa Ganis

Kyle ..... Ezekiel Albarron  
Jerome ..... Aaron Costa Ganis  
Mom ..... Bronagh Daly (Saturday: Natalie Hirsch)

*"Wish I Was Cool"* and *"Fight Song"* lyrics by Robert Askins

### TODAY'S FORECAST

Written by Eric Dufault for Jayla Alvarez, age 11

Directed by Marinda Anderson

Jahna St. Cloud ..... Jayla Alvarez  
Mallory Lancaster ..... Marinda Anderson  
TV Producer ..... Christopher Randolph  
3 Random People ..... Dante Quiñones, Bronagh Daly, Jamie Yip

*"I Know the Weather"* lyrics by Eric Dufault



The 52nd Street Project gratefully acknowledges the support of the following foundations and corporations: Brenner Family Foundation; Cantor Fitzgerald; Bull's Head Foundation; Carnegie Corporation of New York; CBS Foundation; City Winery; Common Sense Fund; Consolidated Edison; Dawkins Family Foundation; The Neil V. DeSena Foundation; Dramatists Guild Fund; Dubin Foundation; Educational Foundation of America; Evercore Partners; Harkness Foundation; HBO; Horace W. Goldsmith Foundation; I. Weiss; Jean & Louis Dreyfus Foundation; Kirkland & Ellis Foundation; Liquid Holdings Group; Ann M. Martin Foundation; Marusi Family Foundation; Newman's Own; Ninth Avenue Association; PAR Group; Parsons Family Foundation; Pinkerton Foundation; Rockefeller Foundation; The Shubert Organization; Slate Path Capital; Harold & Mimi Steinberg Charitable Trust; Surdna Foundation; Susquehanna Foundation; Tax Pro Financial Network; Tiger Baron Foundation; United Talent Agency; Yorke Construction Corp; ZenithOptimedia. (List current as of 7/1/14)

Robert Abrams & Cynthia Vance	Penelope Collins Judith-Ann Corrente	Sarah Horowitz & David Venarde	Sue Phillips Todd Poisson
George Ackert	Janet Coviello	Andrea Johnson	Suzanne Poulin
Michael Alicastro	William Crudup	Beth Ifcher	Helaine & Michael Pruzan
Elton Andrews	Kyle Czepiel	Carine Joannou	Christopher Randolph
Richard Anthony	Arthur Dantchik	Kristen Johanson	Helen & Peter Randolph
Cecilia Arana	Cathy Dantchik	Andrea Johnson	Jacquelyn Reingold
Emily Armstrong	Leslie Dantchik	Cindy Kaplan & David Froelich	Anita A. Rogerson
James Armstrong	Peter & Judith Dawkins	Valerie Kay & Bruce Graham	David Ross & Laura Ross
Dominick & Ilene Balletta	Carolyn & Neil DeSena	Louise Klebanoff	Dr. Steve Rudin
Becky Ann & Dylan Baker	Rebecca & Richard Dresser	Henry Krieger & Robert Joy	Laura Sametz & Anton Fig
Ken Bantum	Peter Doyle	Jacki Ochs & Jan Kroeze	Karin & Thomas Schall
Carolyn Bechtel	Max Dyksterhouse & David Roady	Judy Kuhn & David Schwab	Maury Schott
Lisa Benavides & Tim Blake Nelson	Doug Eisenberg	Frances & Fred Langbecker	Susan Schroeder & Britt Adams
Louisa Benton	Lynn Ellenberg	Gabrielle Lansner & Dean Taucher	Whitney Scott & Peter Jacobson
Gavin Berger & Craig Berggren	Nora Ephron	Brian Lapin	Meg Simon
Stephanie Berger & Paul King	& Nicholas Pileggi	Michael Lawrence & Glen Gillen	Christopher Solomon
Beth & Eric Berman	Peter Jay Fernandez & Denise Burse Fernandez	Warren Leight & Karen Hauser	Jonathan Soros & Jennifer Soros
David Beth	Liz Flahive & Jeff Cox	Mickey Lemle	Jenny & Jon Steingart
Lewis Black	Wendy Flanagan & Chris O'Malley	Jonathan Levine	Tracy Straus
Emily Blavatnik	Karen & Paul Freitas	Helen Levy	Danny Strong
Allison Blinken	Sally Froelich	Melissa Liebling-Goldberg & John Barrett	Al Styron & Ed Beason
Noah Bogan	Alexandra Garrison	Kay M. Lim	Susanna Styron
Jane Bolster & Steve Wertimer	Beverly Gasner	Adrianne Lobel	Richard Sweren
Buzz Bovshow	Rose Gasner & Larry Chertoff	John Lynch	Lili Taylor
Blaise R. Box	Celia Gerard & Mark McGrath	Grace Lyu-Volckhausen	Lisa Tilney & Chris Lawrence
Becky Browder & Ted Neustadt	Christina Gerber	Julie & Alex Margolies	Merritt Tilney & Douglas Kaden
Carlton T. Brown	Freddie & Myrna Gershon	Ali Marsh	Lorraine Tobias & Alex Draper
Iris A. Brown & Joe White	Jenny Gersten & Willie Reale	Lin Manuel Miranda	Liz Tuccillo
Justin Brownhill	Alexandra Gersten-Vassilaros & John Vassilaros	Frances McDormand & Joel Coen	Laura Valeroso & David Seidman
Brian Byrnes	Scott Aaron Gewirtz & Laura Gewirtz	Emily & John Morgan	Wendy vanden Heuvel & Brad Coley
Shawn & Laura Byron	Elizabeth Giamatti	Amanda & Neal Moszkowski	Susan J. Vitucci
Joseph Capozzi	Robert Goldberg & Betsy MacIsaac	Suzen Murakoshi & Mark Temme	Mary Pat Walsh
Leah Carr	Stephen & Cathy Graham	Fred Nelson	Dr. Mildred Walton
Lawrence Catena	Jan Gura & Alan Pickman	Randy & Rona Nelson	Brenda Wehle & John C. Lynch
Chris Ceraso	Susan Hanson	Ruth Nelson	Carol Whitesides
Rachel Chanoff	Jessica Hecht & Adam Bernstein	Lori O'Connor	Zee Wiener
Todd Christie	Kathy & Jamie Herring	Carol Ochs & Bruce MacVittie	Ruth Ann Wynter
Damien Clancy	Peter Herdrich & Karen Trott	Jacki Ochs & Jan Kroeze	J.P. Xenakis
Matthew Clancy	William Holtzman & S. Sylvia Shepard	Kevin O'Rourke & Edith Thurber	Carole Yass
Katie Clark	Mary Horowitz	Jane Perlmutter & Greg MacPherson	Yildiz Yuksek & Richard Blackstone
Elizabeth Clemants		Elizabeth Peters	Connie & Marc Zand
David Cohen & Sandra Novak Cohen			
Larry Cohen			

THE 52ND STREET PROJECT PRESENTS

# JUST DESSERTS

## PLAYS WITH CONSEQUENCES

### THE 2014 PLAYBACK PLAYS

8 NEW PLAYS WRITTEN BY KIDS AND  
PERFORMED BY THE PLAYWRIGHTS  
WITH ADULT PARTNERS AT THE

### FIVE ANGELS THEATER

789 10TH AVENUE  
(BETWEEN 52ND AND 53RD ST.)



Friday, October 24 at 7:30 p.m.  
Saturday, October 25 at 7:30 p.m.  
Sunday, October 26 at 3:00 p.m.

# JUST DESSERTS: PLAYS WITH CONSEQUENCES

Playback 2014 - Oct. 24-26, Five Angels Theater

## The 52nd Street Project Staff

Gus Rogerson, Artistic Director  
Natalie Hirsch, Associate Artistic Director  
George Babiak, Production Manager  
Tim J. Lord, Technical Director

Carol Ochs, Executive Director  
Lisa Kerner, Development & Mgmt. Associate  
John Sheehy, Dir. of Development & Marketing

Liz Bell, Director of Education  
Johanna Vidal, Community Coordinator  
Jennifer Jimenez, Day Receptionist

### Consultants:

Iris A. Brown, Graphic Designer; Chris Ceraso, Teen Dean

### Interns:

Meghan Cooper, Sarah Johnsrude, Ashil Lee

### Teen Employees:

Receptionists: Haley Martinez, Chayse Peña, Britney Trinidad  
Playback Teen Counselor: Nathaly Trinidad  
Ushers: Lincoln Bernard, Richard Brea, Melody Cruz, Britney Trinidad

## "Just Desserts" Production Staff

### Composer/Music Director

Patrick Barnes

### Set Designer

Kevin Joseph Roach

### Lighting Designer

Greg MacPherson

### Costume Designer

Jennifer Kirschman

### Sound Designer

Meghan Cooper

### Stage Manager

Emily Juliani

### Projection Designs

George Babiak, Walker White & the  
Project Projection Archive

### Prop Design Team

George Babiak, Meghan Cooper,  
Sarah Johnsrude, Ashil Lee

### Backstage Crew

Sarah Johnsrude, Ashil Lee,  
Chyanne Peña,  
Rene Paul Santiago,  
Nathaly Trinidad

### Show Photographer

Winston Rodney

### Weekend-Away Chefs

Liz Bell, John Sheehy

### Bridgehampton Hosts

The Gersten-Vassilaros Family,  
Louis and Patrice Friedman,  
Susan Bruce and Peter Hedges

### Flyer Art

James Stevenson



The One-on-One Program is made possible with public funds from The New York State Council on the Arts, a state agency, and the New York City Department of Cultural Affairs. The 52nd Street Project is a member of Art/NY and Theatre Communications Group (TCG), the national organization for the American theatre.

## COOL STUFF ON SALE IN THE LOBBY!

Fabulous Flyer Bars.....\$2.50  
*and featuring Shel Silverstein's "Fivey and Twoey" logo:*

Project Hoodies..... \$30.00  
Project Caps ..... \$20.00  
Project T-shirts..... \$12.00/\$20.00  
Project Mugs ..... \$5.00  
Project Notebook ..... \$5.00  
Project Pencil 3-pack..... \$1.00  
Project Tote Bags ..... \$5.00

Thank you for coming to JUST DESSERTS! If you are not on our mailing list (or if your address has changed), please fill out this form and give it to us on your way out or mail it to the address below. We would also like to know if you are interested in becoming a volunteer. We need help in all areas, so be sure to fill out the entire form.

PLEASE ADD ME TO YOUR MAILING LIST:

10/14

NAME

ADDRESS

CITY

STATE

ZIP

HOME PHONE

DAYTIME OR MOBILE PHONE

E-MAIL ADDRESS

MY OCCUPATION

MY HOBBIES

YES, I WOULD LIKE TO BE OF HELP. I CAN:

- |   |  |  |
|---|--|--|
| <input type="checkbox"/> Draw and/or paint            | <input type="checkbox"/> Help kids with homework |  |
| <input type="checkbox"/> Hang lights                  | <input type="checkbox"/> Help with mailings      | <input type="checkbox"/> Teach kids a skill      |
| <input type="checkbox"/> Work on a backstage crew     | <input type="checkbox"/> Do office work          | <input type="checkbox"/> Be a chef at an event   |
| <input type="checkbox"/> Do graphic design            | <input type="checkbox"/> Design sound            | <input type="checkbox"/> Design and sew costumes |
| <input type="checkbox"/> Other (please specify) _____ |  |  |

MY SCHEDULE IS:

- Very flexible. I'm often available during weekdays.  
 Somewhat flexible. I can help on the occasional morning or afternoon during the week.  
 Not very flexible at all, but I've got some free time on evenings and weekends.

If you would like to mail this (and you're always welcome to enclose a tax-deductible contribution), you can send it to: The 52nd Street Project, 789 10th Avenue, New York, NY 10019. Or fax it to (212) 333-5598.

## COMING UP SOON AT THE PROJECT!

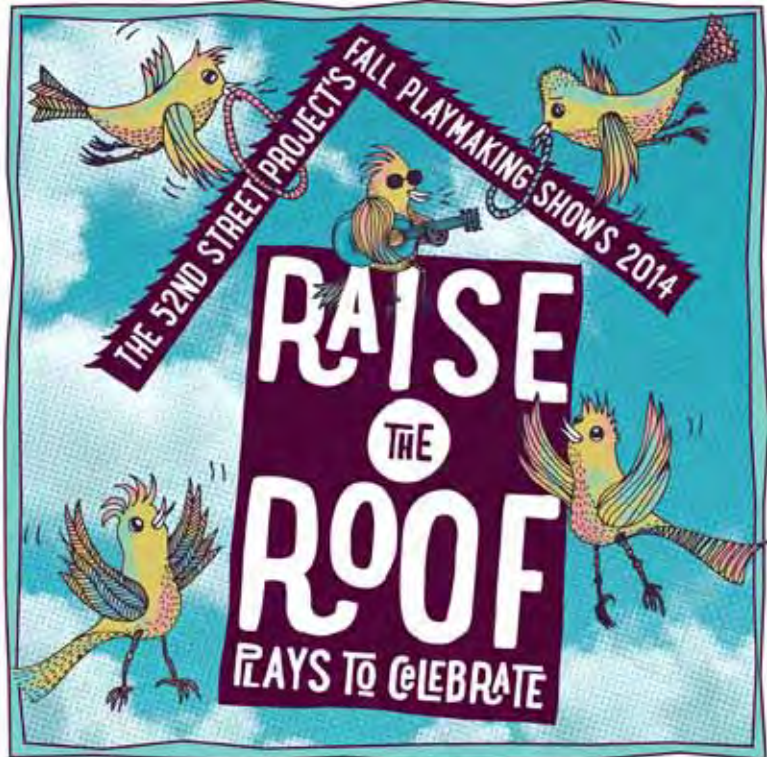

10 NEW PLAYS WRITTEN BY KIDS AND PERFORMED BY ADULT ACTORS

FRIDAY, DECEMBER 5 AT 7:30 P.M.

SATURDAY, DECEMBER 6 AT 3:00 & 7:30 P.M.

SUNDAY, DECEMBER 7 AT 3:00 P.M.



## KEEP YOUR EYES PEELED!

WE ARE ALWAYS SEARCHING FOR INTERNS.

If you know of any college or graduate students who might enjoy working with us, playing with us, and going on trips with us for a semester, please have them contact Lisa Kerner. We are especially looking for interns for the Spring and Summer of 2015. Thanks!

## The 52nd Street Project Board of Directors

Lisa Benavides	Carol Ochs
Rachel Chanoff	Willie Reale, founder
Cathy Dantchik, co-chair	Gus Rogerson
Carolyn DeSena	Shirley Rumierk, alumni member
Wendy Ettinger, chair emeritus	José Soto, Jr., alumni member
Louis P. Friedman, co-chair	Jenny Steingart
Robert Goldberg	Lisa Tilney
Stephen Graham, chair emeritus	Merritt Tilney
Valerie Kay	Wendy vanden Heuvel
Frances McDormand	John A. Vassilaros
Noël Mihalow	Mark Whatley

### What's Going On Here?

The 52nd Street Project is a non-profit organization that brings children from the Hell's Kitchen neighborhood together with professional theater artists to create original theater. JUST DESSERTS is a production of our Playback program, in which kid actor/playwrights write plays for themselves and adult actor/director partners. Everyone ventured to the Hamptons for a rehearsal retreat over the Columbus Day weekend. All of the kids involved are veterans of the Playmaking classes which were adapted for the Project by Daniel Judah Sklar from his book *Playmaking: Children Writing and Performing Their Own Plays*.

### In-Kind Contributions

Abbeville Press; abc cocina; Alvin Ailey American Dance Theater; Richard Anthony; Lewis Black; Iris A. Brown Design; William Curran & A Curran Affair; Emmett Global; Evercore Partners; Edie Falco; Jenny Gersten & Friends of The High Line; Google; Jonathan Groff; ICI; Karen Kowgios of Fried & Kowgios; Charlie Marshal & the Marshal Restaurant; Noël & Joe Mihalow; Neustar; Nonesuch Records; Pharma Print; the Public Theater; Sesame Workshop; Wendy Stuhlberg; Tao Restaurant; Uber; John A. Vassilaros; Watkins, Inc.; and Paul, Weiss, Rifkind, Wharton & Garrison LLP.

### Special Thanks

We're extremely grateful to board member John Vassilaros and his wife Alex Gersten-Vassilaros for allowing us to use their home as our headquarters on our rehearsal trip to the Hamptons. Huge thanks also go to Board Co-Chair Louis Friedman and his wife Patrice Friedman for hosting some adults, and to Susan Bruce and Peter Hedges, who hosted our girls and even more adults at their home in Montauk.

# JUST DESSERTS - ACT 1

All original music composed by Patrick Barnes

## THE RED-CARDED PRANKER

Written by Joseph Cruz, age 13  
Director/Dramaturge: Justin Cimino

Ricardo Cruz.....Joseph Cruz  
Justino Pedro..... Justin Cimino  
Coach.....George Babiak  
Doctor.....Ashil Lee  
10th Graders..... The Crew

*I Will Be Me* lyrics by Joseph Cruz

## JOURNEY TO SATISFACTION

Written by Christin-Delaine Gavriella Tetteh, age 13.  
Director/Dramaturge: Angel Desai

Rebecca.....Christin Tetteh  
Jessica..... Angel Desai  
Voice.....Rene Paul Santiago

*Where's Home?* lyrics by Christin Tetteh

## THE STORY OF A DRUNK AND A MISTAKEN TROUBLE-MAKER

Written by Bamba Thiam, age 13  
Director/Dramaturge: A.Z. Kelsey

Danny..... Bamba Thiam  
Angel..... A.Z. Kelsey  
Person Who Fights.....George Babiak  
Pub Spectators..... The Crew  
Cops.....Ashil Lee, Nathaly Trinidad

*I Just Wanna Be Somebody and My Future is Over* lyrics by Bamba Thiam

## THE ADVENTURE OF THE JUNGLE OF JAGUARS

Written by Maria Martinez, age 13  
Director/Dramaturge: Annie Worden

Casey..... Maria Martinez  
Johanna..... Annie Worden  
Pilot.....Nathaly Trinidad  
Tiger.....Ashil Lee  
Mom..... Natalie Hirsch  
Dad.....John Sheehy  
Luau guests..... The Crew

*Why You Gotta Be Such a Kid* lyrics by Maria Martinez

# JUST DESSERTS - ACT 2

## THE QUEST TO FIND THE GEM

Written by Bryan Lopez, age 13  
Director/Dramaturge: Charlie O'Rourke

John.....Bryan Lopez  
Rob..... Charlie O'Rourke  
Boss.....John Sheehy  
Statue.....Nathaly Trinidad  
Zard.....Himself

*Our Adventures* lyrics by Bryan Lopez

## A SPACESHIP COMES TO MARS

Written by Ruby Zamora, age 14  
Director/Dramaturge: Molly Coogan

Ruby.....Ruby Zamora  
Molly.....Molly Coogan  
Paparazzi..... Rene Paul Santiago and Sarah Johnsrude

*Sad Song In Space* lyrics by Ruby Zamora

## ANGEL VS. HUMAN

Written by Alex Malan, age 13  
Director/Dramaturge: Kyle Cameron

Angel..... Alex Malan  
Richard Dixon..... Kyle Cameron  
Boss.....Nathaly Trinidad  
Pizza Lady.....Ashil Lee

*Powers Flx Everything* lyrics by Alex Malan

## WANNA BE

Written by Imani Lewis, age 13  
Director/Dramaturge: Molly Carden

Faith.....Imani Lewis  
Miss C.....Molly Carden

*Different* lyrics by Imani Lewis



The 52nd Street Project gratefully acknowledges the support of the following foundations and corporations: Brenner Family Foundation; Cantor Fitzgerald; Bull's Head Foundation; Carnegie Corporation of New York; CBS Foundation; City Winery; Common Sense Fund; Consolidated Edison; Dawkins Family Foundation; The Neil V. DeSena Foundation; Dramatists Guild Fund; Dubin Foundation; Educational Foundation of America; Evercore Partners; Harkness Foundation; HBO; Horace W. Goldsmith Foundation; I. Weiss; Jean & Louis Dreyfus Foundation; Kirkland & Ellis Foundation; Liquid Holdings Group; Ann M. Martin Foundation; Marusi Family Foundation; Newman's Own; Ninth Avenue Association; PAR Group; Parsons Family Foundation; Pinkerton Foundation; Rockefeller Foundation; The Shubert Organization; Slate Path Capital; Harold & Mimi Steinberg Charitable Trust; Surdna Foundation; Susquehanna Foundation; Tax Pro Financial Network; Tiger Baron Foundation; United Talent Agency; Yorke Construction Corp; ZenithOptimedia. (List current as of 7/1/14)

Robert Abrams	Penelope Collins	Sarah Horowitz	Sue Phillips
& Cynthia Vance	Judith-Ann Corrente	& David Venarde	Todd Poisson
George Ackert	Janet Coviello	Andrea Johnson	Suzanne Poulin
Michael Alicastro	William Crudup	Beth Ifcher	Helaine & Michael Pruzan
Elton Andrews	Kyle Czepiel	Carine Joannou	Christopher Randolph
Richard Anthony	Arthur Dantchik	Kristen Johanson	Helen & Peter Randolph
Cecilia Arana	Cathy Dantchik	Andrea Johnson	Jacquelyn Reingold
Emily Armstrong	Leslie Dantchik	Cindy Kaplan & David Froelich	Anita A. Rogerson
James Armstrong	Peter & Judith Dawkins	Valerie Kay & Bruce Graham	David Ross & Laura Ross
Dominick & Ilene Balletta	Carolyn & Neil DeSena	Louise Klebanoff	Dr. Steve Rudin
Becky Ann & Dylan Baker	Rebecca & Richard Dresser	Henry Krieger & Robert Joy	Laura Sametz & Anton Fig
Ken Bantum	Peter Doyle	Jacki Ochs & Jan Kroeze	Karin & Thomas Schall
Carolyn Bechtel	Max Dyksterhouse	Judy Kuhn & David Schwab	Maury Schott
Lisa Benavides	& David Roady	Frances & Fred Langbecker	Susan Schroeder
& Tim Blake Nelson	Doug Eisenberg	Gabrielle Lansner	& Britt Adams
Louisa Benton	Lynn Ellenberg	& Dean Taucher	Whitney Scott
Gavin Berger	Nora Ephron	Brian Lapin	& Peter Jacobson
& Craig Berggren	& Nicholas Pileggi	Michael Lawrence	Meg Simon
Stephanie Berger & Paul King	Peter Jay Fernandez	& Glen Gillen	Christopher Solomon
Beth & Eric Berman	& Denise Burse Fernandez	Warren Leight & Karen Hauser	Jonathan Soros
David Beth	Liz Flahive & Jeff Cox	Mickey Lemle	& Jennifer Soros
Lewis Black	Wendy Flanagan	Jonathan Levine	Jenny & Jon Steingart
Emily Blavatnik	& Chris O'Malley	Helen Levy	Tracy Straus
Allison Blinken	Karen & Paul Freitas	Melissa Liebling-Goldberg	Danny Strong
Noah Bogan	Sally Froelich	& John Barrett	Al Styron & Ed Beason
Jane Bolster	Alexandra Garrison	Kay M. Lim	Susanna Styron
& Steve Wertimer	Beverly Gasner	Adrienne Lobel	Richard Sweren
Buzz Bovshow	Rose Gasner & Larry Chertoff	John Lynch	Lili Taylor
Blaise R. Box	Celia Gerard & Mark McGrath	Grace Lyu-Volckhausen	Lisa Tilney & Chris Lawrence
Becky Browder	Christina Gerber	Julie & Alex Margolies	Merritt Tilney & Douglas Kaden
& Ted Neustadt	Freddie & Myra Gershon	Ali Marsh	Lorraine Tobias & Alex Draper
Carlton T. Brown	Jenny Gersten & Willie Reale	Lin Manuel Miranda	Liz Tuccillo
Iris A. Brown & Joe White	Alexandra Gersten-Vassilaros	Frances McDormand	Laura Valeroso
Justin Brownhill	& John Vassilaros	& Joel Coen	& David Seidman
Brian Byrnes	Scott Aaron Gewirtz	Emily & John Morgan	Wendy vanden Heuvel
Shawn & Laura Byron	& Laura Gewirtz	Amanda & Neal Moszkowski	& Brad Coley
Joseph Capozzi	Elizabeth Giamatti	Suzen Murakoshi	Susan J. Vitucci
Leah Carr	Robert Goldberg	& Mark Temme	Mary Pat Walsh
Lawrence Catena	& Betsy MacIsaac	Fred Nelson	Dr. Mildred Walton
Chris Ceraso	Stephen & Cathy Graham	Randy & Rona Nelson	Brenda Wehle & John C. Lynch
Rachel Chanoff	Jan Gura & Alan Pickman	Ruth Nelson	Carol Whitesides
Todd Christie	Susan Hanson	Lori O'Connor	Zee Wiener
Damien Clancy	Jessica Hecht	Carol Ochs & Bruce MacVittie	Ruth Ann Wynter
Matthew Clancy	& Adam Bernstein	Jacki Ochs & Jan Kroeze	J.P. Xenakis
Katie Clark	Kathy & Jamie Herring	Kevin O'Rourke	Carole Yass
Elizabeth Clemants	Peter Herdrich & Karen Trott	& Edith Thurber	Yildiz Yuksek
David Cohen	William Holtzman	Jane Perlmutter	& Richard Blackstone
& Sandra Novak Cohen	& S. Sylvia Shepard	& Greg MacPherson	Connie & Marc Zand
Larry Cohen	Mary Horowitz	Elizabeth Peters	

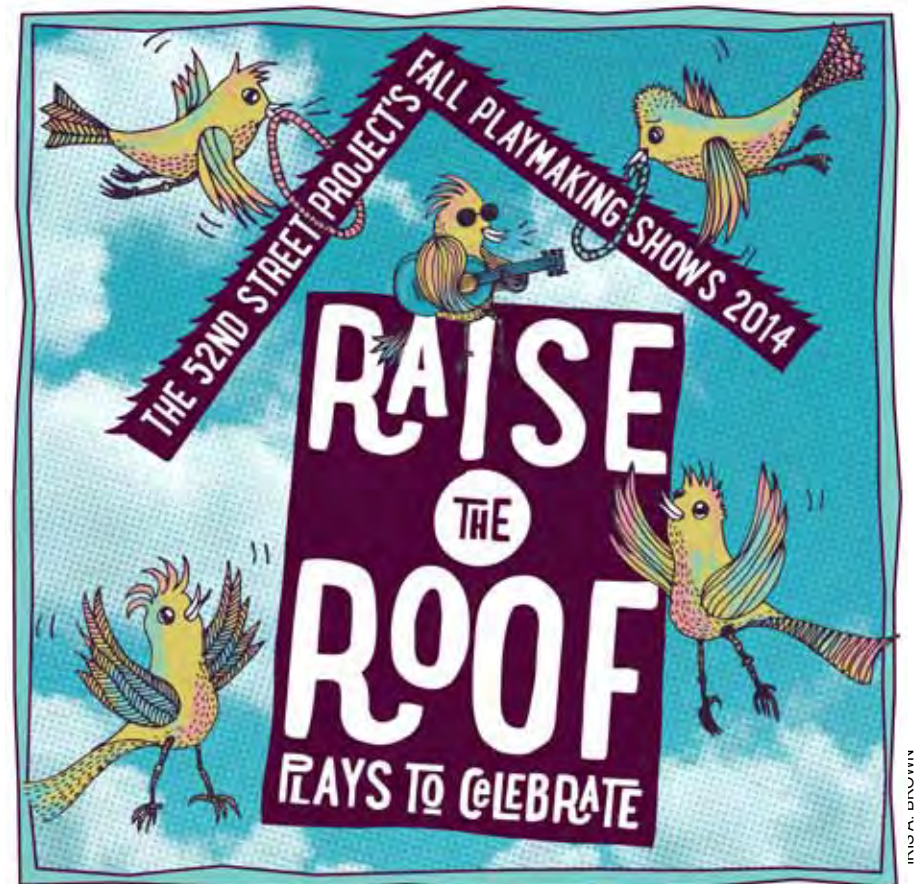

**9 NEW PLAYS WRITTEN BY KIDS AND PERFORMED BY ADULT ACTORS**

Friday, Dec. 5 at 7:30 p.m.

Saturday, Dec. 6 at 3:00 & 7:30 p.m.

Sunday, Dec. 7 at 3:00 p.m.

**THE FIVE ANGELS THEATER**

# RAISE THE ROOF: PLAYS TO CELEBRATE

Fall Playmaking 2014 - Dec. 5-7, Five Angels Theater

## The 52nd Street Project Staff

Gus Rogerson, Artistic Director  
 Carol Ochs, Executive Director  
 Natalie Hirsch, Associate Artistic Director  
 Lisa Kerner, Development & Mgmt. Associate  
 George Babiak, Production Manager  
 John Sheehy, Dir. of Development & Marketing  
 Tim J. Lord, Technical Director  
 Laura Lane, Mgr. of Individual Giving

Liz Bell, Director of Education  
 Johanna Vidal, Community Coordinator  
 Daiva Deupree, Education Assistant  
 Jennifer Jimenez, Day Receptionist

### Consultants:

Iris A. Brown, Graphic Designer; Chris Ceraso, Teen Dean

### Interns:

Meghan Cooper, Sarah Johnsrude, Ashil Lee

### Teen Employees:

Receptionists: Haley Martinez, Chayse Peña, Britney Trinidad  
 Ushers: Faisal Afridi, Jasmine Correa, Rene Paul Santiago, Alizette Zapata  
 Doormen: Anthony Mejia, Jorge Zapata

## “RAISE THE ROOF” Production Staff

Composer/Music Director Kim D. Sherman	Prop Design Team George Babiak, Meghan Cooper, Ashil Lee, Sarah Johnsrude,
Set Designer Kevin Joseph Roach	Backstage Crew Meghan Cooper, Sarah Johnsrude, Ashil Lee, Karen Tineo, Kai Geniza
Lighting Designer Josh Langman	Flyer Art Iris A. Brown
Lighting Assistant Laurel Detkin	Chefs Iris A. Brown, Joe White, Walker White, Liz Bell, Carol Ochs
Costume Designers Chris Rumery, Sarah Cogan	Playmaking Class Volunteers Mirirai Sithole, Nick Mills, Arielle Goldman, Austin Regan, Erica Saleh, Garrett Kim
Goddess of Sound Vanessa Valdes	Playmaking Class Teen Assistant Tiara Varela
Stage Manager Jenny Peek	Production Photographer Winston Rodney
Projection Design: George Babiak, Sarah Johnsrude, and the Project Slide Archive	



The Playmaking Program is made possible with funds from the Ann Martin Foundation, New- man’s Own Foundation, and public funds from The New York State Council on the Arts, a state agency, and the New York City Department of Cultural Affairs. The 52nd Street Project is a member of Art/NY.

## COOL STUFF ON SALE IN THE LOBBY!

Fabulous Flyer Bars.....\$2.50  
*and featuring Shel Silverstein’s “Fivey and Twoey” logo:*  
 Project Hoodies..... \$30.00  
 Project Caps ..... \$20.00  
 Project T-shirts..... \$12.00/\$20.00  
 Project Mugs ..... \$5.00  
 Project Notebook ..... \$5.00  
 Project Pencil 3-pack..... \$1.00  
 Project Tote Bags..... \$5.00

Thank you for coming to **RAISE THE ROOF**. If you are not on our mailing list (or if your address has changed), please fill out this form and give it to us on your way out or mail it to the address below. We would also like to know if you are interested in becoming a volunteer. We need help in all areas, so be sure to fill out the entire form.

### PLEASE ADD ME TO YOUR MAILING LIST:

12/14

NAME \_\_\_\_\_

ADDRESS \_\_\_\_\_

CITY \_\_\_\_\_ STATE \_\_\_\_\_ ZIP \_\_\_\_\_

HOME PHONE \_\_\_\_\_

DAYTIME OR MOBILE PHONE \_\_\_\_\_ E-MAIL ADDRESS \_\_\_\_\_

MY OCCUPATION \_\_\_\_\_

MY HOBBIES \_\_\_\_\_

### YES, I WOULD LIKE TO BE OF HELP. I CAN:

- |   |  |  |
|---|--|--|
| <input type="checkbox"/> Draw and/or paint            | <input type="checkbox"/> Help kids with homework | <input type="checkbox"/> Design and sew costumes |
| <input type="checkbox"/> Hang lights                  | <input type="checkbox"/> Help with mailings      | <input type="checkbox"/> Teach kids a skill      |
| <input type="checkbox"/> Work on a backstage crew     | <input type="checkbox"/> Do office work          | <input type="checkbox"/> Be a chef at an event   |
| <input type="checkbox"/> Do graphic design            | <input type="checkbox"/> Design sound            |  |
| <input type="checkbox"/> Other (please specify) _____ |  |  |

### MY SCHEDULE IS:

- Very flexible. I'm often available during weekdays.  
 Somewhat flexible. I can help on the occasional morning or afternoon during the week.  
 Not very flexible at all, but I've got some free time on evenings and weekends.

If you would like to mail this (and you're always welcome to enclose a tax-deductible contribution), you can send it to: The 52nd Street Project, 789 10th Ave., New York, NY 10019. Or fax it to (212) 333-5598.

COMING UP NEXT!

# COUNT ON IT!

PLAYS YOU CAN TRUST

6 NEW PLAYS • 6 ADULT WRITERS • 6 ADULT DIRECTORS • 12 KID ACTORS



FRIDAY, JAN. 30 - SUNDAY, FEB. 1  
RIGHT HERE AT THE FIVE ANGELS THEATER



## BE ON THE LOOKOUT!

WE ARE ALWAYS SEARCHING FOR INTERNS.

If you know of any college or graduate students who might enjoy working with us, and going on trips with us for a semester, please have them contact Lisa Kerner. We are currently looking for interns for the Spring and Summer of 2015. Thanks!

## The 52nd Street Project Board of Directors

Lisa Benavides	Carol Ochs
Rachel Chanoff	Willie Reale, founder
Cathy Dantchik, co-chair	Gus Rogerson
Carolyn DeSena	Shirley Rumierk, alumni member
Wendy Ettinger, chair emeritus	José Soto, Jr., alumni member
Louis P. Friedman, co-chair	Jenny Steingart
Robert Goldberg	Lisa Tilney
Stephen Graham, chair emeritus	Merritt Tilney
Valerie Kay	Wendy vanden Heuvel
Frances McDormand	John A. Vassilaros
Noël Mihalow	Mark Whatley

## What's Going On Here?

The 52nd Street Project is a non-profit organization that brings children from the Hell's Kitchen neighborhood together with professional theater artists to create original theater. *RAISE THE ROOF* is a production of our Playmaking program. Young people participate in a nine-week playwriting course taught by Natalie Hirsch and adapted for the Project by Daniel Judah Sklar from his book *Playmaking: Children Writing and Performing Their Own Plays*. At the end of the course, each child is matched with two actors and a dramaturg/director who guides him or her through the writing of a play during a weekend retreat in the country (Stone Ridge, NY, for this show). This performance is the end result.

## In-Kind Contributions

Abbeville Press; abc cocina; Alvin Ailey American Dance Theater; Richard Anthony; Lewis Black; Iris A. Brown Design; William Curran & A Curran Affair; Emmett Global; Evercore Partners; Edie Falco; Jenny Gersten & Friends of The High Line; Google; Jonathan Groff; ICI; Karen Kowgios of Fried & Kowgios; Charlie Marshal & the Marshal Restaurant; Noël & Joe Mihalow; Neustar; Nonesuch Records; Pharma Print; the Public Theater; Sesame Workshop; Wendy Stuhlberg; Tao Restaurant; Uber; John A. Vassilaros; Watkins, Inc.; and Paul, Weiss, Rifkind, Wharton & Garrison LLP.

## Special Thanks

We're extremely grateful to Steve Gorn & Barbara Bash for the use of their beautiful home in Stone Ridge, NY as our base of operations for the writer's retreat. Also thanks to Nina Shengold, Zach Sklar & Sarah Plant, and Debbie Wierum and Steve Ramsey for housing our kids; and Deborah Freedman & Bill Woods, Elaine Musselman, Laura Shaine Cunningham, and Jeff Madalena & Jason Gnewikow for housing our adults. Last, but not least, thanks to Iris Brown, Joe White & Walker White for housing kids AND making the amazing food!

# RAISE THE ROOF: ACT 1

All original music composed by Kim D. Sherman

## WHAT WE WANT

Written by Lescot Ortiz, age 10  
Director/Dramaturge: John Sheehy Costume Designer: Chris Rumery  
Miles .....Nick Mills  
Scarlet ..... Jessica Hecht  
Chief .....George Babiak  
*Finally* lyrics by Lescot Ortiz

## TWO LOVERS AND A CURSE

Written by Ginaija Hires, age 10  
Director/Dramaturge: Tasha Gordon-Solmon Costume Designer: Sarah Cogan  
Crystal Wood .....Lauren Blumenfeld  
Nash .....Dylan Dawson  
Bear Cub ..... Sarah Johnsrude  
Doctor ..... Meghan Cooper  
Cops ..... Ashil Lee & Sarah Johnsrude  
*Wish for A Better Day* lyrics by Ginaija Hires

## FRIENDS ARE FAMILY

Written by Jayleen Velez, age 10  
Director/Dramaturge: Gretchen Hall Costume Designer: Chris Rumery  
Teenie, a mouse ..... Christina Pumariega  
Marvin, an elephant ..... Maren Bush  
Pizza chef ..... Meghan Cooper  
*We're Family* lyrics by Jayleen Velez

## THE POORPHANAGE: FOOD FIGHT

Written by Emmanuel Goicurua, age 11  
Director/Dramaturge: Tim J. Lord Costume Designer: Sarah Cogan  
Eh Guy .....Kareem Lucas  
Jerkface ..... David Shih  
Orphans ..... The Crew

## BEGINNING OF THE END

Written by Natasha Davis, age 11  
Director/Dramaturge: Kel Haney Costume Designer: Chris Rumery  
Tezzerack .....Michael Braun  
Tezza ..... Sofiya Akilova  
Manager ..... Ashil Lee  
*What If This, What If That* lyrics by Natasha Davis

# RAISE THE ROOF: ACT 2

## 1 FOOT OVER

Written by Ethan Zenteno, age 10  
Dramaturge/Director: Alex Barron Costume Designer: Sarah Cogan  
Tiny Box Tim ..... Bill Camp  
Ponja, a pig ..... Jennifer Ikeda  
Customers ..... The Crew  
Burrito Gal ..... Sarah Johnsrude  
Height Guy ..... Ashil Lee  
*Who We Are* and *We Got It* lyrics by Ethan Zenteno

## THE PLANE PROBLEM

Written by Rebecca Gomez, age 10  
Director/Dramaturge: Ka-Ling Cheung Costume Designer: Sarah Cogan  
Vanessa, an ostrich ..... Mirirai Sithole  
Seth, a polar bear ..... Joshua David Robinson  
Loudspeaker ..... Meghan Cooper

## SUPERHEROES AND VILLAINS

Written by Ethan Perez, age 10  
Director/Dramaturge: Don Nguyen Costume Designer: Chris Rumery  
Flamo ..... Bjorn Dupaty  
Watszo ..... Sathya Sridharan  
*The I Feel Song* lyrics by Ethan Perez

## THE PROBLEM SOLVING

Written by Charde Harvey, age 10  
Director/Dramaturge: Alexandra O'Daly Costume Designer: Chris Rumery  
Ina, a chicken ..... Arielle Goldman  
Elle, a bird ..... Tina Chilip  
The Imaginary Friend ..... Sarah Johnsrude  
*Emotions* lyrics by Charde Harvey







# SHOW PROGRAMS 2015

The 52nd Street Project gratefully acknowledges the support of the following foundations and corporations: Brenner Family Foundation; Cantor Fitzgerald; Bull's Head Foundation; Carnegie Corporation of New York; CBS Foundation; City Winery; Common Sense Fund; Consolidated Edison; Dawkins Family Foundation; The Neil V. DeSena Foundation; Dramatists Guild Fund; Dubin Foundation; Educational Foundation of America; Evercore Partners; Harkness Foundation; HBO; Horace W. Goldsmith Foundation; I. Weiss; Jean & Louis Dreyfus Foundation; Kirkland & Ellis Foundation; Liquid Holdings Group; Ann M. Martin Foundation; Marusi Family Foundation; Newman's Own; Ninth Avenue Association; PAR Group; Parsons Family Foundation; Pinkerton Foundation; Rockefeller Foundation; The Shubert Organization; Slate Path Capital; Harold & Mimi Steinberg Charitable Trust; Surdna Foundation; Susquehanna Foundation; Tax Pro Financial Network; Tiger Baron Foundation; United Talent Agency; Yorke Construction Corp; ZenithOptimedia. (List current as of 7/1/14)

- |                                      |   |   |                                       |
|--------------------------------------|---|---|---------------------------------------|
| Robert Abrams<br>& Cynthia Vance     | Penelope Collins<br>Judith-Ann Corrente           | Sarah Horowitz<br>& David Venarde           | Sue Phillips<br>Todd Poisson          |
| George Ackert                        | Janet Coviello                                    | Andrea Johnson                              | Suzanne Poulin                        |
| Michael Alicastro                    | William Crudup                                    | Beth Ifcher                                 | Helaine & Michael Pruzan              |
| Elton Andrews                        | Kyle Czepiel                                      | Carine Joannou                              | Christopher Randolph                  |
| Richard Anthony                      | Arthur Dantchik                                   | Kristen Johanson                            | Helen & Peter Randolph                |
| Cecilia Arana                        | Cathy Dantchik                                    | Andrea Johnson                              | Jacquelyn Reingold                    |
| Emily Armstrong                      | Leslie Dantchik                                   | Cindy Kaplan & David Froelich               | Anita A. Rogerson                     |
| James Armstrong                      | Peter & Judith Dawkins                            | Valerie Kay & Bruce Graham                  | David Ross & Laura Ross               |
| Dominick & Ilene Balletta            | Carolyn & Neil DeSena                             | Louise Klebanoff                            | Dr. Steve Rudin                       |
| Becky Ann & Dylan Baker              | Rebecca & Richard Dresser                         | Henry Krieger & Robert Joy                  | Laura Sametz & Anton Fig              |
| Ken Bantum                           | Peter Doyle                                       | Jacki Ochs & Jan Kroeze                     | Karin & Thomas Schall                 |
| Carolyn Bechtel                      | Max Dyksterhouse<br>& David Roady                 | Judy Kuhn & David Schwab                    | Maurly Schott                         |
| Lisa Benavides<br>& Tim Blake Nelson | Doug Eisenberg                                    | Frances & Fred Langbecker                   | Susan Schroeder<br>& Britt Adams      |
| Louisa Benton                        | Lynn Ellenberg                                    | Gabrielle Lansner<br>& Dean Taucher         | Whitney Scott<br>& Peter Jacobson     |
| Gavin Berger<br>& Craig Berggren     | Nora Ephron                                       | Brian Lapin                                 | Meg Simon                             |
| Stephanie Berger & Paul King         | Peter Jay Fernandez<br>& Denise Burse Fernandez   | Michael Lawrence<br>& Glen Gillen           | Christopher Solomon                   |
| Beth & Eric Berman                   | Liz Flahive & Jeff Cox                            | Warren Leight & Karen Hauser                | Jonathan Soros<br>& Jennifer Soros    |
| David Beth                           | Wendy Flanagan<br>& Chris O'Malley                | Mickey Lemle                                | Jenny & Jon Steingart                 |
| Lewis Black                          | Karen & Paul Freitas                              | Jonathan Levine                             | Tracy Straus                          |
| Emily Blavatnik                      | Sally Froelich                                    | Helen Levy                                  | Danny Strong                          |
| Allison Blinks                       | Alexandra Garrison                                | Melissa Lieblich-Goldberg<br>& John Barrett | Al Styron & Ed Beason                 |
| Noah Bogan                           | Beverly Gasner                                    | Kay M. Lim                                  | Susanna Styron                        |
| Jane Bolster<br>& Steve Wertimer     | Rose Gasner & Larry Chertoff                      | Adrienne Lobel                              | Richard Sweren                        |
| Buzz Bovshow                         | Celia Gerard & Mark McGrath                       | John Lynch                                  | Lili Taylor                           |
| Blaise R. Box                        | Christina Gerber                                  | Grace Lyu-Volkhausen                        | Lisa Tilney & Chris Lawrence          |
| Becky Browder<br>& Ted Neustadt      | Freddie & Myra Gershon                            | Julie & Alex Margolies                      | Merritt Tilney & Douglas Kaden        |
| Carlton T. Brown                     | Jenny Gersten & Willie Reale                      | Ali Marsh                                   | Lorraine Tobias & Alex Draper         |
| Iris A. Brown & Joe White            | Alexandra Gersten-Vassilaros<br>& John Vassilaros | Lin Manuel Miranda                          | Liz Tuccillo                          |
| Justin Brownhill                     | Scott Aaron Gewirtz<br>& Laura Gewirtz            | Frances McDormand<br>& Joel Coen            | Laura Valeroso<br>& David Seidman     |
| Brian Byrnes                         | Elizabeth Giamatti                                | Emily & John Morgan                         | Wendy vanden Heuvel<br>& Brad Coley   |
| Shawn & Laura Byron                  | Robert Goldberg<br>& Betsy MacIsaac               | Amanda & Neal Moszkowski                    | Susan J. Vitucci                      |
| Joseph Capozzi                       | Stephen & Cathy Graham                            | Suzen Murakoshi<br>& Mark Temme             | Mary Pat Walsh                        |
| Leah Carr                            | Jan Gura & Alan Pickman                           | Fred Nelson                                 | Dr. Mildred Walton                    |
| Lawrence Catena                      | Susan Hanson                                      | Randy & Rona Nelson                         | Brenda Wehle & John C. Lynch          |
| Chris Ceraso                         | Jessica Hecht<br>& Adam Bernstein                 | Ruth Nelson                                 | Carol Whitesides                      |
| Rachel Chanoff                       | Kathy & Jamie Herring                             | Lori O'Connor                               | Zee Wiener                            |
| Todd Christie                        | Peter Herdrich & Karen Trott                      | Carol Ochs & Bruce MacVittie                | Ruth Ann Wynter                       |
| Damien Clancy                        | William Holtzman                                  | Jacki Ochs & Jan Kroeze                     | J.P. Xenakis                          |
| Matthew Clancy                       | & S. Sylvia Shepard                               | Kevin O'Rourke                              | Carole Yass                           |
| Katie Clark                          | Mary Horowitz                                     | Edith Thurber                               | Yildiz Yuksek<br>& Richard Blackstone |
| Elizabeth Clemants                   |   | Jane Perlmutter<br>& Greg MacPherson        | Connie & Marc Zand                    |
| David Cohen<br>& Sandra Novak Cohen  |   | Elizabeth Peters                            |                                       |
| Larry Cohen                          |   |   |                                       |

THE 52ND STREET PROJECT PRESENTS

# COUNT ON IT!

PLAYS YOU CAN TRUST

THE  
2015  
TWO  
-ON-  
TWOs



ARTWORK BY PATRICK JONES

FIVE  
ANGELS  
THEATER

6 NEW PLAYS • 6 ADULT WRITERS • 6 ADULT DIRECTORS • 12 KID ACTORS

**FRIDAY, JAN. 30 AT 7:30 P.M.**  
**SATURDAY, JAN. 31 AT 7:30 P.M.**  
**SUNDAY, FEB. 1 AT 3:00 P.M.**

# COUNT ON IT: PLAYS YOU CAN TRUST

The 2015 Two-on-Twos - Jan. 30-Feb. 1, Five Angels Theater

## The 52nd Street Project Staff

Gus Rogerson, Artistic Director	Carol Ochs, Executive Director
Natalie Hirsch, Associate Artistic Director	Lisa Kerner, Development & Mgmt. Associate
Garrett Kim, Program Director	John Sheehy, Dir. of Development & Marketing
Liz Bell, Director of Education	Laura Lane, Mgr. of Individual Giving
Johanna Vidal*, Community Coordinator	George Babiak, Production Manager
Daiva Deupree, Education Assistant	Tim J. Lord, Technical Director

Jennifer Jimenez\*, Day Receptionist  
 Anthony Mejia\*, Jorge Zapata\*, Front Door Receptionists

*\*Alumnus of The 52nd Street Project*

### Consultants:

Iris A. Brown, Graphic Designer; Chris Ceraso, Teen Dean

### Interns:

Hannah Beacham, Rebecca Inderhees, Brigette Lundy-Paine

### Teen Employees:

Receptionists: Haley Martinez, Chayse Peña, Britney Trinidad  
 Ushers: Michael Bannister, Melody Cruz, Tatiana Goode, Tiara Varela

## “COUNT ON IT” Production Staff

### Composer/Music Director

Avi Amon

### Set Designer

Kevin Joseph Roach

### Lighting Designer

Greg McPherson

### Costume Designers

Viviane Galloway and  
 Michael Piatkowski

### Sound Designer

John Sheehy

### Stage Manager

Fran Rubenstein

### Projection Design:

George Babiak and  
 The Project Slide Archive

### Prop Fabrication Team

George Babiak, Hannah Beacham,  
 Rebecca Inderhees,  
 Brigette Lundy-Paine

### Backstage Crew

Sabastian Lopez, Ruby Zamora,  
 Hannah Beacham,  
 Rebecca Inderhees,  
 Brigette Lundy-Paine

### Chefs

John Sheehy, Liz Bell,  
 Carol Ochs

### Hosts in Dutchess County

Obie Benz, Lili Taylor, and Maria Tucci

## COOL STUFF ON SALE IN THE LOBBY!

Fabulous Flyer Bars..... \$2.50

and featuring Shel Silverstein’s  
 “Fivey and Twoey” logo:

Project T-shirts..... \$12.00  
 Project Hoodies..... \$30.00  
 Project Caps ..... \$20.00  
 Project Mugs ..... \$5.00  
 Project Pencil 3-pack..... \$1.00  
 Project Notebook ..... \$5.00

Thank you for coming to **COUNT ON IT**. If you are not on our mailing list (or if your address has changed), please fill out this form and give it to us on your way out or mail it to the address below. We would also like to know if you are interested in becoming a volunteer. We need help in all areas, so be sure to fill out the entire form.

### PLEASE ADD ME TO YOUR MAILING LIST:

1/15

NAME \_\_\_\_\_

ADDRESS \_\_\_\_\_

CITY \_\_\_\_\_

STATE \_\_\_\_\_

ZIP \_\_\_\_\_

HOME PHONE \_\_\_\_\_

DAYTIME OR MOBILE PHONE \_\_\_\_\_

E-MAIL ADDRESS \_\_\_\_\_

MY OCCUPATION \_\_\_\_\_

MY HOBBIES \_\_\_\_\_

### YES, I WOULD LIKE TO BE OF HELP. I CAN:

- |   |  |  |
|---|--|--|
| <input type="checkbox"/> Draw and/or paint            | <input type="checkbox"/> Help kids with homework | <input type="checkbox"/> Be a chef at an event   |
| <input type="checkbox"/> Help with mailings           | <input type="checkbox"/> Teach kids a skill      | <input type="checkbox"/> Do graphic design       |
| <input type="checkbox"/> Work on a backstage crew     | <input type="checkbox"/> Design sound            | <input type="checkbox"/> Design and sew costumes |
| <input type="checkbox"/> Other (please specify) _____ |  |  |

### MY SCHEDULE IS:

- Very flexible. I'm often available during weekdays.  
 Somewhat flexible. I can help on the occasional morning or afternoon during the week.  
 Not very flexible at all, but I've got some free time on evenings and weekends.

If you would like to mail this (and you're always welcome to enclose a tax-deductible contribution), you can send it to: The 52nd Street Project, 789 10th Ave., New York, NY 10019. Or fax it to (212) 333-5598.



The Two-on-Two Program is made possible with funds from the Ann Martin Foundation, Newman's Own Foundation, and public funds from The New York State Council on the Arts, a state agency, and the New York City Department of Cultural Affairs. The 52nd Street Project is a member of Art/NY.

**DON'T MISS OUR NEXT SHOW...**

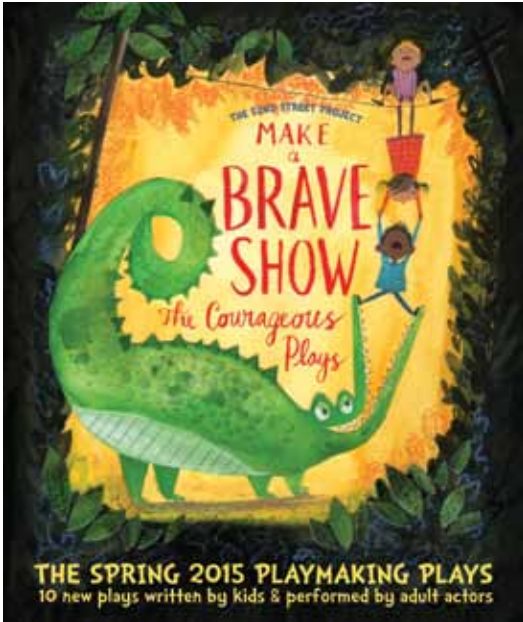

Friday through Sunday,  
March 27-29, 2015

Right here at  
Five Angels Theater

Last month, 10 brand-new  
Project kids began  
Playmaking classes with  
Natalie Hirsch.

Come see their  
final plays performed by  
professional, volunteer  
adult actors.

### The 52nd Street Project Board of Directors

Lisa Benavides	Carol Ochs
Rachel Chanoff	Willie Reale, founder
Cathy Dantchik, co-chair	Gus Rogerson
Carolyn DeSena	Shirley Rumierk, alumni member
Wendy Ettinger, chair emeritus	José Soto, Jr., alumni member
Louis P. Friedman, co-chair	Jenny Steingart
Robert Goldberg	Lisa Tilney
Stephen Graham, chair emeritus	Merritt Tilney
Valerie Kay	Wendy vanden Heuvel
Frances McDormand	John A. Vassilaros
Noël Mihalow	Mark Whatley

---

### What's Going On Here?

The 52nd Street Project is a non-profit organization that brings children from the Hell's Kitchen neighborhood together with professional theater artists to create original theater. **COUNT ON IT** is a production of our Two-on-Two's program, in which an adult playwright crafts a piece for a pair of Project kids to perform. Another adult directs the kids for a month that includes an intensive three-day weekend in upstate New York. Tonight's performance is the final result.

---

### In-Kind Contributions

Abbeville Press; abc cocina; Alvin Ailey American Dance Theater; Richard Anthony; Lewis Black; Iris A. Brown Design; William Curran & A Curran Affair; Emmett Global; Evercore Partners; Edie Falco; Jenny Gersten & Friends of The High Line; Google; Jonathan Groff; ICI; Karen Kowgios of Fried & Kowgios; Charlie Marshal & the Marshal Restaurant; Noël & Joe Mihalow; Neustar; Nonesuch Records; Pharma Print; the Public Theater; Sesame Workshop; Wendy Stuhlberg; Tao Restaurant; Uber; John A. Vassilaros; Watkins, Inc.; and Paul, Weiss, Rifkind, Wharton & Garrison LLP.

---

### Special Thanks

We owe many thanks to Maria Tucci, Lili Taylor and Obie Benz, all of whom graciously allowed us to use their homes in Dutchess County for three exhilarating and fun-filled days. Thanks also to the Roller Magic skating rink of Hyde Park and Ro-Lin Bowling Lanes in Red Hook.

### ...OR THE PROJECT'S ANNUAL BENEFIT!

The Board of Directors of The 52nd Street Project invite you to save the date for...

**FANCY  
THAT**

Songs written by a posh pack of Project kids and  
performed by spiffy special guests.

7:00 p.m., Monday, May 4, 2015 at the Edison Ballroom

CONTACT JOHN "THE GUV'NOR" SHEEHY FOR MORE INFORMATION ABOUT  
"FANCY THAT" AT (212) 333-5252 OR SHEEHY@52PROJECT.ORG

## COUNT ON IT: PLAYS YOU CAN TRUST - ACT 1

All original music composed by Avi Amon

### THEY DON'T DO THAT ANYMORE

Written by Jeff Cox

Directed by Michael Feld

Hendershot.....Brandon Shaffer

Jonesmith.....Richard Brea

*The Pig Tale* lyrics by Jeff Cox

### FROZEN FISH

Written by Sarah Hammond

Directed by Mikhaela Mahony

Jessie.....Edelys Guerrero

Marella.....Ashley Thomas

*Opposite* lyrics by Sarah Hammond

### BOOM GOES THE DYNAMITE

Written by Colleen Werthmann

Directed by Kimiye Corwin

Slick.....Jasmine Correa

Ice-Cold.....Chayse Peña

*Something Is Wrong* lyrics by Colleen Werthmann



## COUNT ON IT: PLAYS YOU CAN TRUST - ACT 2

### THE BATTLE OF TWO MEN OVER MARIELLA

Written by Matthew Paul Olmos

Directed by Sean Kenealy

A.....Faisal Afridi

B.....Amer Musa

*Running of the Horses* lyrics by Matthew Paul Olmos

### THE OLD NEIGHBOR

Written by Max Posner

Directed by Natalie Martin

Verna.....Valeria Oliva

Marjorie.....Makice Pacheco

Nurse.....Natalie Hirsch

*Unexpected* lyrics by Jiehae Park

### SPIT THICK

Written by Chisa Hutchinson

Directed by Jude Sandy

Bianca.....Britney Trinidad

Ignacio.....Enrique Caballero

*Practice Kid* lyrics by Chisa Hutchinson

I  
N  
T  
E  
R  
M  
I  
S  
S  
I  
O  
N



The 52nd Street Project gratefully acknowledges the support of the following foundations and corporations: Brenner Family Foundation; Cantor Fitzgerald; Bull's Head Foundation; Carnegie Corporation of New York; CBS Foundation; City Winery; Common Sense Fund; Consolidated Edison; Dawkins Family Foundation; The Neil V. DeSena Foundation; Dramatists Guild Fund; Dubin Foundation; Educational Foundation of America; Evercore Partners; Harkness Foundation; HBO; Horace W. Goldsmith Foundation; I. Weiss; Jean & Louis Dreyfus Foundation; Kirkland & Ellis Foundation; Liquid Holdings Group; Ann M. Martin Foundation; Marusi Family Foundation; Newman's Own; Ninth Avenue Association; PAR Group; Parsons Family Foundation; Pinkerton Foundation; Rockefeller Foundation; The Shubert Organization; Slate Path Capital; Harold & Mimi Steinberg Charitable Trust; Surdna Foundation; Susquehanna Foundation; Tax Pro Financial Network; Tiger Baron Foundation; United Talent Agency; Yorke Construction Corp; ZenithOptimedia. (List current as of 7/1/14)

Robert Abrams	Penelope Collins	Sarah Horowitz	Sue Phillips
& Cynthia Vance	Judith-Ann Corrente	& David Venarde	Todd Poisson
George Ackert	Janet Coviello	Andrea Johnson	Suzanne Poulin
Michael Alicastro	William Crudup	Beth Ifcher	Helaine & Michael Pruzan
Elton Andrews	Kyle Czepiel	Carine Joannou	Christopher Randolph
Richard Anthony	Arthur Dantchik	Kristen Johanson	Helen & Peter Randolph
Cecilia Arana	Cathy Dantchik	Andrea Johnson	Jacquelyn Reingold
Emily Armstrong	Leslie Dantchik	Cindy Kaplan & David Froelich	Anita A. Rogerson
James Armstrong	Peter & Judith Dawkins	Valerie Kay & Bruce Graham	David Ross & Laura Ross
Dominick & Ilene Balletta	Carolyn & Neil DeSena	Louise Klebanoff	Dr. Steve Rudin
Becky Ann & Dylan Baker	Rebecca & Richard Dresser	Henry Krieger & Robert Joy	Laura Sametz & Anton Fig
Ken Bantum	Peter Doyle	Jacki Ochs & Jan Kroeze	Karin & Thomas Schall
Carolyn Bechtel	Max Dyksterhouse	Judy Kuhn & David Schwab	Maury Schott
Lisa Benavides	& David Roady	Frances & Fred Langbecker	Susan Schroeder
& Tim Blake Nelson	Doug Eisenberg	Gabrielle Lansner	& Britt Adams
Louisa Benton	Lynn Ellenberg	& Dean Taucher	Whitney Scott
Gavin Berger	Nora Ephron	Brian Lapin	& Peter Jacobson
& Craig Berggren	& Nicholas Pileggi	Michael Lawrence	Meg Simon
Stephanie Berger & Paul King	Peter Jay Fernandez	& Glen Gillen	Christopher Solomon
Beth & Eric Berman	& Denise Burse Fernandez	Warren Leight & Karen Hauser	Jonathan Soros
David Beth	Liz Flahive & Jeff Cox	Mickey Lemle	& Jennifer Soros
Lewis Black	Wendy Flanagan	Jonathan Levine	Jenny & Jon Steingart
Emily Blavatnik	& Chris O'Malley	Helen Levy	Tracy Straus
Allison Blinken	Karen & Paul Freitas	Melissa Lieblich-Goldberg	Danny Strong
Noah Bogan	Sally Froelich	& John Barrett	Al Styron & Ed Beason
Jane Bolster	Alexandra Garrison	Kay M. Lim	Susanna Styron
& Steve Wertimer	Beverly Gasner	Adrienne Lobel	Richard Sweren
Buzz Bovshow	Rose Gasner & Larry Chertoff	John Lynch	Lili Taylor
Blaise R. Box	Celia Gerard & Mark McGrath	Grace Lyu-Volckhausen	Lisa Tilney & Chris Lawrence
Becky Browder	Christina Gerber	Julie & Alex Margolies	Merritt Tilney & Douglas Kaden
& Ted Neustadt	Freddie & Myra Gershon	Ali Marsh	Lorraine Tobias & Alex Draper
Carlton T. Brown	Jenny Gersten & Willie Reale	Lin Manuel Miranda	Liz Tuccillo
Iris A. Brown & Joe White	Alexandra Gersten-Vassilaros	Frances McDormand	Laura Valeroso
Justin Brownhill	& John Vassilaros	& Joel Coen	& David Seidman
Brian Byrnes	Scott Aaron Gewirtz	Emily & John Morgan	Wendy vanden Heuvel
Shawn & Laura Byron	& Laura Gewirtz	Amanda & Neal Moszkowski	& Brad Coley
Joseph Capozzi	Elizabeth Giamatti	Suzen Murakoshi	Susan J. Vitucci
Leah Carr	Robert Goldberg	& Mark Temme	Mary Pat Walsh
Lawrence Catena	& Betsy MacIsaac	Fred Nelson	Dr. Mildred Walton
Chris Ceraso	Stephen & Cathy Graham	Randy & Rona Nelson	Brenda Wehle & John C. Lynch
Rachel Chanoff	Jan Gura & Alan Pickman	Ruth Nelson	Carol Whitesides
Todd Christie	Susan Hanson	Lori O'Connor	Zee Wiener
Damien Clancy	Jessica Hecht	Carol Ochs & Bruce MacVittie	Ruth Ann Wynter
Matthew Clancy	& Adam Bernstein	Jacki Ochs & Jan Kroeze	J.P. Xenakis
Katie Clark	Kathy & Jamie Herring	Kevin O'Rourke	Carole Yass
Elizabeth Clemants	Peter Herdrich & Karen Trott	& Edith Thurber	Yildiz Yuksek
David Cohen	William Holtzman	Jane Perlmutter	& Richard Blackstone
& Sandra Novak Cohen	& S. Sylvia Shepard	& Greg MacPherson	Connie & Marc Zand
Larry Cohen	Mary Horowitz	Elizabeth Peters	

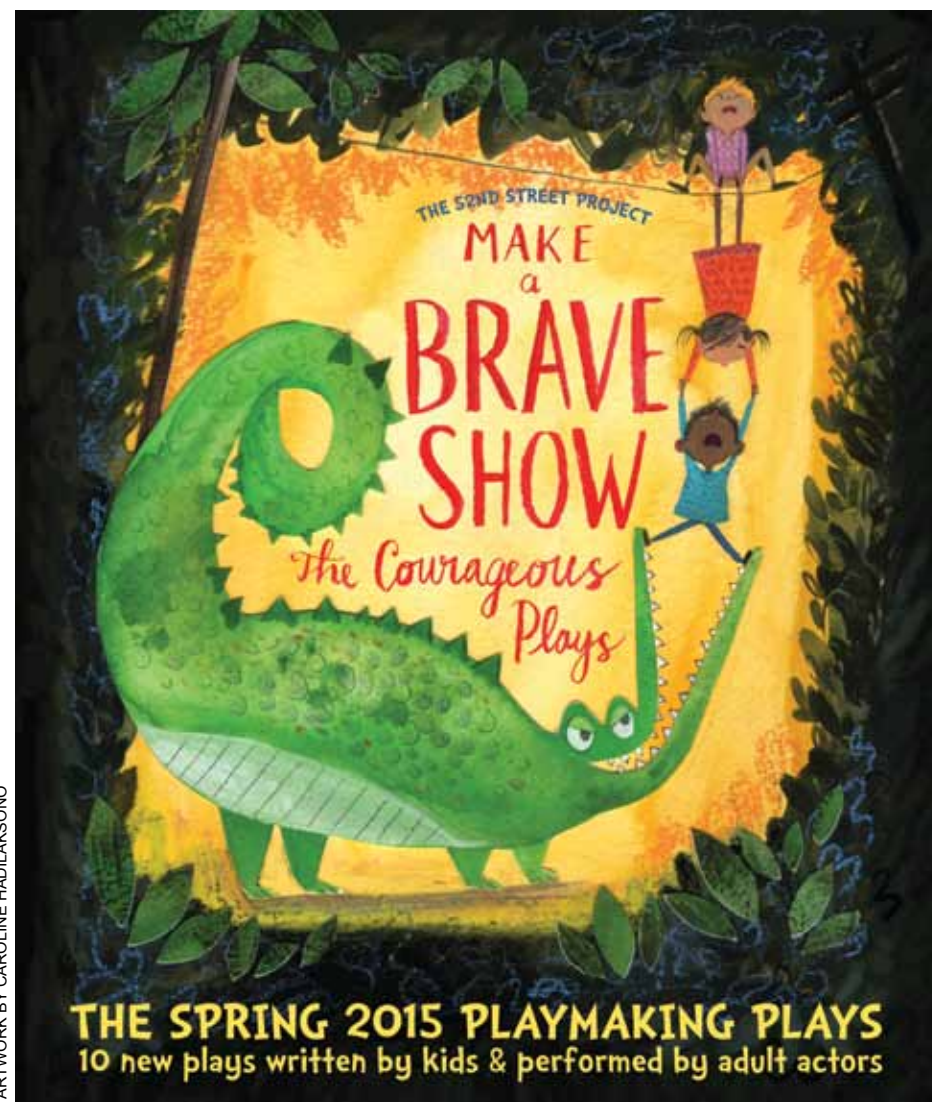

## Five Angels Theater

Friday, March 27 at 7:30 p.m.

Saturday, March 28 at 3:00 and 7:30 p.m.

Sunday, March 29 at 3:00 p.m.

# MAKE A BRAVE SHOW: THE COURAGEOUS PLAYS

The Spring 2015 Playmaking Production - March 27-29, The Five Angels Theater

## The 52nd Street Project Staff

Gus Rogerson, Artistic Director	Carol Ochs, Executive Director
Natalie Hirsch, Associate Artistic Director	Lisa Kerner, Development & Mgmt. Associate
Garrett Kim, Program Director	John Sheehy, Dir. of Development & Marketing
Liz Bell, Director of Education	Laura Lane, Mgr. of Individual Giving
Johanna Vidal*, Community Coordinator	George Babiak, Production Manager
Daiva Deupree, Education Assistant	Tim J. Lord, Technical Director

Jennifer Jimenez\*, Day Receptionist  
 Anthony Mejia\*, Jorge Zapata\*, Front Door Receptionists

*\*Alumnus of The 52nd Street Project*

### Consultants:

Iris A. Brown, Graphic Designer; Chris Ceraso, Teen Dean

### Interns:

Rebecca Inderhees, Brigette Lundy-Paine, A'shanti Tyree

### Teen Employees:

Receptionists: Haley Martinez, Chayse Peña, Britney Trinidad  
 Concessions/Ushers: Michael Bannister, Jasmine Correa, Ashley Thomas, Rene-Paul Santiago

## "MAKE A BRAVE SHOW" Production Staff

Composer/Music Director	Backstage Crew
Patrick Barnes	Doris Alcantara, Richard Brea,
Set Designer	Rebecca Inderhees, Brigette Lundy-Paine,
Kevin Joseph Roach	Maria Martinez
Lighting Designer	House Managers
Ben Fichthorne	Carol Ochs
Costume Designers	"Make A Brave Show" Flyer and Program Art
Kim Goings and Crystal Thompson	Caroline Hadilaksono
Sound Designer	Weekend-in-Bridgehampton Chefs
Toby Algya	Liz Bell, Carol Ochs, John Sheehy
Soundboard Operator	Playmaking Class Volunteers
A'shanti Tyree	Rachel Bonds, Juan Castano,
Stage Manager	Katie Firth, Nancy Giles,
Anne Lowrie	Sarah Johnsrude, Arielle Siegel,
Projection Design	Christina Quintana
George Babiak, Max Posner, and the	Playmaking Class Teen Assistant
52nd Street Projection Archive	Britney Trinidad
Prop Design Team	Production Photographer
George Babiak, Rebecca Inderhees,	Winston Rodney
Brigette Lundy-Paine, Johanna Vidal	



The Playmaking Program is made possible with funds from Pinkerton Foundation and the Harold & Mimi Steinberg Charitable Trust and public funds from The New York State Council on the Arts, a state agency, and the New York City Department of Cultural Affairs. The 52nd Street Project is a member of Art/NY.

## COOL STUFF ON SALE IN THE LOBBY!

Fabulous Flyer Bars..... \$2.50

and featuring Shel Silverstein's "Fivey and Twoey" logo:

Project T-shirts..... \$12.00/20.00

Project Hoodies.....\$30.00

Project Caps .....\$20.00

Project Mugs ..... \$5.00

Project Pencil 3-pack..... \$1.00

Project Notebook ..... \$5.00

Project Tote Bags..... \$5.00

Thank you for coming to **MAKE A BRAVE SHOW!** If you are not on our mailing list (or if your address has changed), please fill out this form and give it to us on your way out or mail it to the address below. We would also like to know if you are interested in becoming a volunteer. We need help in all areas, so be sure to fill out the entire form.

### PLEASE ADD ME TO YOUR MAILING LIST:

3/15

NAME \_\_\_\_\_

ADDRESS \_\_\_\_\_

CITY \_\_\_\_\_

STATE \_\_\_\_\_

ZIP \_\_\_\_\_

HOME PHONE \_\_\_\_\_

DAYTIME OR MOBILE PHONE \_\_\_\_\_

E-MAIL ADDRESS \_\_\_\_\_

MY OCCUPATION \_\_\_\_\_

MY HOBBIES \_\_\_\_\_

### YES, I WOULD LIKE TO BE OF HELP. I CAN:

- |   |  |  |
|---|--|--|
| <input type="checkbox"/> Draw and/or paint            | <input type="checkbox"/> Help kids with homework | <input type="checkbox"/> Be a chef at an event   |
| <input type="checkbox"/> Help with mailings           | <input type="checkbox"/> Teach kids a skill      | <input type="checkbox"/> Do graphic design       |
| <input type="checkbox"/> Work on a backstage crew     | <input type="checkbox"/> Design sound            | <input type="checkbox"/> Design and sew costumes |
| <input type="checkbox"/> Other (please specify) _____ |  |  |

### MY SCHEDULE IS:

- Very flexible. I'm often available during weekdays.
- Somewhat flexible. I can help on the occasional morning or afternoon during the week.
- Not very flexible at all, but I've got some free time on evenings and weekends.

If you would like to mail this (and you're always welcome to enclose a tax-deductible contribution), you can send it to: The 52nd Street Project, 789 10th Ave., New York, NY 10019. Or fax it to (212) 333-5598.

## COMING UP ON THE PROJECT SCHEDULE...



3 budding auteurs script, shoot, and edit original films with adult partners and pro actors.

Thursday  
and Friday,  
April 23 & 24, 2015  
7:00 p.m.

Friday,  
April 17, 2015  
5:00 p.m.

6 kids choreograph and perform original dances with adult partners and some teen guest stars.



## AND DON'T FORGET THE PROJECT'S ANNUAL BENEFIT!

The Board of Directors of The 52nd Street Project invite you to save the date for...

# FANCY THAT

A PROJECT EXTRAVAGANZA

Songs written by a posh pack of Project kids and performed by spiffy special guests.

7:00 p.m., Monday, May 4, 2015 at the Edison Ballroom

CONTACT JOHN "VISCOUNT VON FOO FARAW" SHEEHY FOR MORE INFORMATION ABOUT "FANCY THAT" AT (212) 333-5252 OR SHEEHY@52PROJECT.ORG

## The 52nd Street Project Board of Directors

Lisa Benavides	Carol Ochs
Rachel Chanoff	Willie Reale, founder
Cathy Dantchik, co-chair	Gus Rogerson
Carolyn DeSena	Shirley Rumierk, alumni member
Wendy Ettinger, chair emeritus	José Soto, Jr., alumni member
Louis P. Friedman, co-chair	Jenny Steingart
Robert Goldberg	Lisa Tilney
Stephen Graham, chair emeritus	Merritt Tilney
Valerie Kay	Wendy vanden Heuvel
Frances McDormand	John A. Vassilaros
Noël Mihalow	Mark Whatley

## What's Going On Here?

The 52nd Street Project is a non-profit organization that brings children from the Hell's Kitchen neighborhood together with professional theater artists to create original theater. *MAKE A BRAVE SHOW* is a production of our Playmaking program. Young people participate in a nine-week playwriting course taught by Natalie Hirsch and adapted for the Project by Daniel Judah Sklar from his book *Playmaking: Children Writing and Performing Their Own Plays*. At the end of the course, each child is matched with two actors and a dramaturg/director who guides him or her through the writing of a play during a weekend retreat in the country (Bridgehampton, NY, for this show). This performance is the end result.

## In-Kind Contributions

Abbeville Press; abc cocina; Alvin Ailey American Dance Theater; Richard Anthony; Lewis Black; Iris A. Brown Design; William Curran & A Curran Affair; Emmett Global; Evercore Partners; Edie Falco; Jenny Gersten & Friends of The High Line; Google; Jonathan Groff; ICI; Karen Kowgios of Fried & Kowgios; Charlie Marshal & the Marshal Restaurant; Noël & Joe Mihalow; Neustar; Nonesuch Records; Pharma Print; the Public Theater; Sesame Workshop; Wendy Stuhlberg; Tao Restaurant; Uber; John A. Vassilaros; Watkins, Inc.; and Paul, Weiss, Rifkind, Wharton & Garrison LLP.

## Special Thanks

We're extremely grateful to John Vassilaros & Alex Gersten-Vassilaros for the use of their beautiful home in Bridgehampton, NY as our base of operations for the writer's retreat. We're also grateful to Laurie Becker, who housed the girls in nearby Sag Harbor.



## MAKE A BRAVE SHOW: THE COURAGEOUS PLAYS - ACT 1

All original music composed by Patrick Barnes.

### THE TURTLE DAYS

Written by Rodery Rosario, age 10.

Dramaturge/Director: George Babiak. Costume Designer: Kim Goings  
Jack ..... Emma Galvin  
Led..... Genesis Oliver  
Mom.....Rebecca Inderhees  
Teacher..... Natalie Hirsch  
Students ..... Doris Alcantara and Richard Brea

*The Blues* lyrics by Rodery Rosario

### MERMAID WORLD

Written by Magalis Fabian, age 10.

Dramaturge/Director: Chelsea Hackett  
Costume Designer: Crystal Thompson

Makalay ..... Clea Alsip  
Lauren ..... Ashley Marie Ortiz  
Meranda .....Rebecca Inderhees

### FIGHTS ALWAYS END

Written by Darby O'Donnell, age 10.

Dramaturge: Sarah Johnsrude, Director: Flor De Liz Perez  
Costume Designer: Kim Goings

Ivy .....Alia Attalah  
Abby ..... Brigitte Lundy-Paine

*Friends Again* lyrics by Darby O'Donnell

### THE HAUNTED HOUSE

Written by Lakshmi DeJesus, age 10.

Dramaturge/Director: January LaVoy, Costume Designer: Kim Goings  
Riely..... Rebecca Henderson  
Knock Knock..... Ray Fisher  
Kiosk Bob ..... Maria Martinez

*I Feel Frustrated* and *I'm So Happy* lyrics by Lakshmi DeJesus

### GUMMY ENGLAND

Written by Coleman Williams, age 10.

Dramaturge: Garrett Kim, Director: James Yaegashi  
Costume Designer: Kim Goings

Chuloo ..... Billy Crudup  
Looper .....Ben Mehl  
Harry.....John Sheehy  
Looper's Family ..... The Crew

*You a Hoodlum* and *B & B Is Perfection* lyrics by Coleman Williams

## MAKE A BRAVE SHOW: THE COURAGEOUS PLAYS - ACT 2

### FRED AND COLETTE

Written by Rosneyri Rosario, age 10.

Dramaturge/Director: Colette Robert, Costume Designer: Kim Goings  
Colette ..... Sue Jean Kim  
Fred ..... Will Rogers

*I'm Mad* and *We're Happy* lyrics by Rosneyri Rosario

### THE SPEED

Written by Aramis Jimenez, age 10.

Dramaturge/Director: Austin Regan. Costume Designer: Kim Goings  
Bob the Banana..... Korey Jackson  
King Coconut..... Greg Hildreth  
Announcer .....Richard Brea

*Trophy* lyrics by Aramis Jimenez

### BE CAREFUL WHAT YOU WISH FOR

Written by Nicole Quiles, age 10.

Dramaturge/Director: Eliza Baldi, Costume Designer: Kim Goings  
Isabelle ..... Irene Sofia Lucio  
Annie ..... Kristen Sieh  
Staff ..... The Crew

### SATAN VS. GOD

Written by Andry Moreno, age 10.

Dramaturge/Director: Max Posner, Costume Designer: Kim Goings  
Boss..... Felix Solis  
Hery Lery .....Christopher Randolph

### THE KID THAT SUFFERS

Written by Stevens Velasquez, age 10.

Dramaturge/Director: Michael Walkup, Costume Designer: Kim Goings  
Jeff..... Michael Potts  
Ms. Fancy ..... Nancy Giles

*Mean Teacher* and *Annoying Kid* lyrics by Stevens Velasquez

The 52nd Street Project is a non-profit arts organization that brings children from the Hell's Kitchen neighborhood together with professional artists to create original art. The Dancemaking program gives 8 Project kids a chance to express themselves creatively through movement. Over the nine weeks of Dancemaking class, led by HannaH Allen with support from Program Director Garrett Kim, these young choreographers and performers developed their own movement vocabulary. With their adult Choreographers, they explored shapes, pathways, actions, and choreographic elements to create their own short original piece. The resulting dances are featured in tonight's performance.

### The 52nd Street Project Staff

Gus Rogerson, Artistic Director  
 Natalie Hirsch, Associate Artistic Director  
 Garrett Kim, Program Director

Carol Ochs, Executive Director  
 Lisa Kerner, Development & Mgmt. Associate

John Sheehy, Dir. of Development & Marketing  
 Laura Lane, Mgr. of Individual Giving

Liz Bell, Director of Education  
 Johanna Vidal\*, Community Coordinator  
 Daiva Deupree, Education Assistant

George Babiak, Production Manager  
 Tim J. Lord, Technical Director

Jennifer Jimenez\*, Day Receptionist  
 Anthony Mejia\*, Kyle Fargardo\*, Front Door Receptionists

*\*Alumnus of The 52nd Street Project*

#### Consultants:

Iris A. Brown, Graphic Designer; Chris Ceraso, Teen Dean

#### Interns:

Rebecca Inderhees, Brigette Lundy-Paine, A'shanti Tyree

#### Teen Employees:

Receptionists: Chayse Peña, Britney Trinidad

Concessions/Ushers: Michael Bannister, Jasmine Correa, Rene-Paul Santiago, Ashley Thomas

### The 52nd Street Project Board of Directors

Lisa Benavides  
 Rachel Chanoff  
 Cathy Dantchik, co-chair  
 Carolyn DeSena  
 Wendy Ettinger, chair emeritus  
 Louis P. Friedman, co-chair  
 Alexandra Garrison  
 Robert Goldberg  
 Stephen Graham, chair emeritus  
 Valerie Kay  
 Frances McDormand  
 Noël Mihalow

Carol Ochs  
 Willie Reale, founder  
 Gus Rogerson  
 Shirley Rumierk, alumni member  
 José Soto, Jr., alumni member  
 Jenny Steingart  
 Lisa Tilney  
 Merritt Tilney  
 Wendy vanden Heuvel  
 John A. Vassilaros  
 Mark Whatley



The Dancemaking Program is made possible with public funds from The New York State Council on the Arts, a state agency; and the New York City Department of Cultural Affairs. The Project is a member of ART/NY.

The 52nd Street Project Presents



Featuring 8 short original dances choreographed by kids and performed by kids and adults.

Dancemaking Director: HannaH Allen

Thursday, April 23 & Friday, April 24, 2015 – 7:00 p.m.

The Five Angels Theater  
 The 52nd Street Project  
 789 10th Avenue

## **Opening Number**

Choreographed by: HannaH Allen  
Performed by: The 2015 Dancemaking Company  
Music: “111 Archer Avenue” by Mark Mothersbaugh &  
“Transcendence” by Lindsey Sterling  
Theme: Discovery

## **Black and White, White and Black**

Choreographed by: Milen Tokarev  
Performed by: Milen Tokarev & Natalie Hirsch  
Music: “Billy and the Kid—Gun Battle” by Copland  
Theme: Civility & Violence

*About the Dance: “Fun but scary! Scary but fun! Mean but friendly, it’s all here right now at the 2015 52nd Street Project Dancemaking.”—Milen*

## **The Love Garden**

Choreographed by: Jasmine Correa & Samantha Paduani  
Performed by: Jasmine Correa, Samantha Paduani,  
& Rebecca Inderhees  
Music: “Use Somebody” by 2 Cellos  
Theme: Love & Growth

*About the Dance: “The piece is about nature and the love and friendship that goes into life. It follows the journey of a flower.”—Jasmine & Samantha*

## **The Struggle is Real!**

Choreographed by: Jayla Alvarez  
Performed by: Jayla Alvarez & Channie Waites  
Music: “Get Out of the Wee” by Groove Camp &  
“Stars Align” by Lindsay Sterling  
Theme: Gumi-stickiness & Creative

*About the Dance: “It was hard choreographing the dance to fit the theme and music.”—Jayla*

## **The Anxious Man and the...Man**

Choreographed by: Kai Ceniza  
Performed by: Kai Ceniza & Derek Long  
Music: “A Knife in the Dark” from The Lord of the Rings  
Theme: Emotionless & Anxious

*About the Dance: “You will be amazed by this thrill!”—Kai*

## **I Love It**

Choreographed by: Duaa Alkindi  
Performed by: Duaa Alkindi & Nehassaiu deGannes  
Music: “Tres Minutos Con La Realidad” by Yo Yo Ma  
Theme: Food

*About the Dance: “Just know you will be hungry ;)”—Duaa*

## **Happy Happy Joy Joy**

Choreographed by: Joshua Gomez  
Performed by: Joshua Gomez & Max Rosenak  
Music: “Woods” by George Winston  
Theme: Water

*About the Dance: “First sad, then happy.”—Joshua*

## **Anticipation**

Choreographed by: Kiara Figueroa  
Performed by: Kiara Figueroa & Daiva Deupree  
Music: “Where the Streets Have No Name” by 2 Cellos  
Theme: Waiting & Searching & Connection

*About the Dance: “Dance takes place in the woods.”—Kiara*

MONDAY, MAY 4, 2015

THE EDISON BALLROOM

## ***THE 52ND STREET PROJECT BOARD OF DIRECTORS***

Lisa Benavides	Carol Ochs
Rachel Chanoff	Willie Reale, founder
Cathy Dantchik, co-chair	Gus Rogerson
Carolyn DeSena	Shirley Rumierk, alumni member
Wendy Ettinger, chair emeritus	José Soto, Jr., alumni member
Louis P. Friedman, co-chair	Jenny Steingart
Alexandra Garrison	Lisa Tilney
Robert Goldberg	Merritt Tilney
Stephen Graham, chair emeritus	Wendy vanden Heuvel
Valerie Kay	John A. Vassilaros
Frances McDormand	Mark Whatley
Noël Mihalow	

## ***THE 52ND STREET PROJECT STAFF***

Gus Rogerson, Artistic Director	Carol Ochs, Executive Director
Natalie Hirsch, Associate Artistic Director	Lisa Kerner, Development & Mgmt. Associate
Garrett Kim, Program Director	John Sheehy, Dir. of Development & Marketing
Liz Bell, Director of Education	Laura Lane, Mgr. of Individual Giving
Johanna Vidal*, Community Coordinator	George Babiak, Production Manager
Daiva Deupree, Education Assistant	Tim J. Lord, Technical Director

Jennifer Jimenez\*, Day Receptionist  
Anthony Mejia\*, Mark Gamero\*, Front Door Receptionists

*\*Alumnus of The 52nd Street Project*

### ***CONSULTANTS:***

Iris A. Brown, Graphic Designer; Chris Ceraso, Teen Dean

### ***INTERNS:***

Rebecca Inderhees, Brigitte Lundy-Paine, A'shanti Tyree

### ***TEEN EMPLOYEES:***

Receptionists: Chayse Peña, Britney Trinidad

## ***SPECIAL THANKS***

Farah Bala, Stephanie Berger, Becky Browder,  
Noël Mihalow, Ray Harold, Rob Jakubik,  
Cynthia Kaplan, Kareem Lucas, Flor de Liz Perez,  
Kim Sherman, J. Andrew Stein, Crystal Thompson,  
Peter Trilling, Vanessa Valdes, Cynthia Vance



## **52ND STREET PROJECT BOARD CO-CHAIRS**

Louis Friedman and Cathy Dantchik

## **“FANCY THAT” BENEFIT CO-CHAIRS**

Lisa Benavides	Karin Schall
Carolyn DeSena	Merritt Tilney
Patrice Friedman	Mary Pat Walsh

## **THE 52ND STREET PROJECT GRATEFULLY ACKNOWLEDGES...**

Abbeville Press  
ABC Television  
Richard Anthony  
Bodega Negro Restaurant  
Iris A. Brown Design  
Comedy Central  
Cookshop Restaurant  
William Curran, A Curran Affair  
Edie Falco  
Louis & Patrice Friedman  
Tony Goldwyn  
The Mercedes Club  
Noël & Joe Mihalow  
Noho Hospitality  
PHYTO Haircare  
The Public Theater  
Winston Rodney  
TAO Restaurant  
Merritt Tilney & Doug Kaden  
Uber  
John A. Vassilaros & Sons  
Mark Jacobs & J.R. Watkins Company  
Healthier Living Since 1868

## **CLASSY SEATS**

Cecilia Arana-Grant & Kevin Grant	Steven Kaplan
Becky & Dylan Baker	Sandra & Jack Kaplan
Neena Beber & Marc Turkel	Kim & Elliot Katz
Beth & Eric Berman	Pat Kirby
Stephen Bernstein	Mary Kong
Jane Bolster & Steve Wertimer	Alan Krevis & Gary Horowitz
Becky Browder & Ted Neustadt	Henry Krieger & Robert Joy
Iris A. Brown	Judy Kuhn & David Schwab
Chris Ceraso	Stephanie Laing
Lisa Chanel	Frances & Fred Langbecker
Rachel Chanoff	Carla & Yohan Minaya
Ellen Chopay	Beth Ollwerther
Katie & Kelly Clark	Jane Perlmutter & Greg MacPherson
Elizabeth Clemants	Judy & Michael Pillinger
Lisa Cohen & David Hillman	Todd Poisson, BKSK Architects
Suzanne Cohen	Randi Puccio
Liza Demby	Christopher Randolph
Marion Dienstag	Anita Andres Rogerson
Rebecca & Richard Dresser	Maury Schott
Liz Flahive	Robert Schwartz
Lindsay Fram & Mason Pettit	Sylvia Shepard & Willy Holtzman
Sally Froelich	Meg Simon
Mark Grinnell	Stephen Sondheim
Susan Hanson	Jenni Swan
Ann & David Hausmann	Richard Sweren
Jessica Hecht	Edith Thurber & Kevin O'Rourke
Kathy & Jamie Herring	Lisa Tilney
Kristen Johanson & Tom Green	Karen Trott & Peter Herdrich
Christa Justus & Mark Linn-Baker	Liz Tuccillo
	Laura Valeroso

## *ALL THAT SEATS*

Beth & Ray Abbott

Lisa Benavides Nelson & Tim Blake Nelson

Craig Berggren

Lewis Black

Allison Blinken

Buzz Bovshow

Alison Fraser Magee & Nat Magee

Jenny Gersten & Willie Reale

Nancy Giles

Sarah Horowitz & David Venarde

Andrea Johnson

Cynthia Kaplan & David Froelich

Anita Keal & Morty Wolkowitz

Erik Larsen

Kate Lear & Jon LaPook

Cindy & Richard Leibovitch

Mickey Lemle

Josephine Merck & Jim Stevenson

Rona & Randolph Nelson

Ruth Nelson

Lori O'Connor

The Par Group

Suzanne Poulin

Lynne Marie Rosenberg

Laura & David Ross

Steve Sabba, Tax Pro Financial Network, Inc.

Laura Sametz & Anton Fig

Karin & Tom Schall

Jeremy Smith

Adriana Trigiani & Tim Stephenson

# *FANCY THAT*

A PROJECT EXTRAVAGANZA

THE 52ND STREET PROJECT'S ANNUAL BENEFIT

MONDAY, MAY 4, 2015

THE EDISON BALLROOM

## *THE SHOW*

### *Host*

Edie Falco

### *THE LYRICISTS*

Justin Bannister, Jayda Camacho, Stasia Quiñones,  
Chamel Rodney, Ethan Zenteno

### *THE COMPOSERS*

Nick Blaemire, Peter Lerman, Stephanie McKay,  
David Yazbek, Elizabeth Ziman

### *THE PERFORMERS*

Nick Blaemire, Lena Hall, Kendal Hartse, Stephanie McKay,  
Jacob Ming-Trent, Bryce Pinkham, Matthew Saldivar,  
Emily Skeggs, Akron Watson, Betsy Wolfe

### *THE MUSICIANS*

Kimberly Grigsby, Piano  
Freddy Hall, Guitar  
John Epcar, Percussion

### *DIRECTOR*

Jonathan Bernstein

### *MUSIC DIRECTOR*

Kimberly Grigsby

### *MUSIC COORDINATOR*

Kim D. Sherman

### *LIGHTING DESIGNER*

Greg MacPherson

### *SOUND DESIGNER*

Drew Levy

### *SET & PROP DESIGNS*

George Babiak,  
Stephanie Berger,  
and Iris Brown

### *STAGE MANAGER*

Colleen Sherry

### *WRITTEN BY*

John Sheehy

# THE NOT SO FANCY BULLDOG

LYRICS BY ETHAN ZENTENO, AGE 10

COMPOSED BY PETER LERMAN

PERFORMED BY BRYCE PINKHAM

BACK-UP VOCALS SUNG BY KENDAL HARTSE  
AND AKRON WATSON



DON GUAPO  
PANTALONES DE LUJO  
(A.K.A. ETHAN ZENTENO)

## VERSE 1

I'M A BRITISH BULLDOG AND I'M SO VERY RICH  
AND I WOULD REALLY LOVE TO BE FANCY  
BUT SADLY I CAN'T

I'M AN ADOPTED BULLDOG  
AND MY PARENTS GAVE ME MONEY  
AND LIKE I SAID  
I CAN'T BE FANCY LIKE IGGY AZALEA

AND I WAS UP ALL NIGHT DRINKIN' EXPRESSO  
ON THE COMPUTER SINCE 5 AM  
TRYING TO GET ON A REALLY FANCY CRUISE!

## PRE-CHORUS

SO THAT I COULD BE AS FANCY AS MY FRIENDS  
(3X)

## CHORUS

I'M GONNA PROVE MYSELF  
I'M GONNA PROVE MYSELF  
I'M GONNA PROVE MYSELF TO THE WORLD  
I CAN BE ACCOMPLISHED (HE'LL PROVE HIMSELF)  
I CAN BE ACCOMPLISHED (HE'LL PROVE HIMSELF)  
I'M GONNA PROVE MYSELF TO THE WORLD

## VERSE 2

THE CRUISE WILL HELP ME BECOME FANCY  
BECAUSE IT TAKES US TO A SUPER SECRET  
ISLAND

THAT ONLY FANCY PEOPLE KNOW ABOUT

ALSO IF I GO MY FRIENDS WILL ALSO THINK  
I'M FANCY 'CAUSE NONE OF THEM KNOW  
ABOUT THE ISLAND  
PLUS I'LL BE THE FIRST BULLDOG TO GO

WHEN MY FRIENDS SEE ME I WILL SAY  
"I CAN BE FANCY TOO"  
"I CAN BE FANCY TOO"

## PRE-CHORUS

I CAN BE BE AS FANCY AS MY FRIENDS WHOO (3X)

## CHORUS

### BRIDGE

WHEN I GO TO THE FANCY ISLAND  
THEY'LL HAVE GOLDEN TOILETS  
WITH BACON FLAVORED WATER

AND THEY'LL HAVE KIBBLE/BACON SMOOTHIES  
EVERY TWENTY STEPS  
AND LOTS OF SQUEAKY TOYS

THE BEST PART IS AT THE END  
IGGY AZALEA WILL PERFORM "FANCY"  
WHILE WE DRINK BACON TEA

## VERSE 3

BUT WHAT IF I DON'T FEEL DIFFERENT?  
WHAT IF I DON'T FEEL FANCY?  
WELL THAT WON'T MATTER TO ME  
'CAUSE THEN I WILL BE UNIQUE  
BECAUSE I LOVE TO BE ME  
A RICH BUT NOT FANCY BULLDOG

THERE IS A KNOCK AT MY DOOR  
IT'S MY FRIEND, HE SAYS  
"WOW YOUR HOUSE IS STILL MESSY"  
I SAY "YEAH I'M NOT FANCY, I LIKE IT THAT WAY"

## PRE-CHORUS

I WON'T BE BE AS FANCY AS MY FRIENDS WHOO

## CHORUS

## VERSE 4

I'M NOT A FANCY PERSON  
AND THAT'S WHY MY HOUSE IS A MESS  
JUST 'CAUSE MY FAMILY IS RICH  
(PAUSE, THINKING ABOUT HIS FAMILY A LITTLE)  
DOESN'T MEAN I HAVE TO BE FANCY  
AND NOOOOO MATTER WHAT YOU SAY  
I WILL NEVER BE FANCY  
(STRETCHES OUT THE WORD FANCY)

## PRE-CHORUS

I WON'T BE BE AS FANCY AS MY FRIENDS WHOO  
I WON'T BE BE AS FAN-

## FRIENDS INTERRUPTING SONG, SPOKEN

YOU DON'T HAVE TO KEEP SINGING, WE GET YOU,  
LIKE WHO YOU ARE!

## SCHMANCY TABLE

The Dantchik Family  
Cathy & Stephen Graham

## LAH-DI-DA TABLES

Patrice & Louis Friedman  
Alexandra Garrison  
Merritt Tilney & Douglas Kaden

## LOUIS XIV TABLES

Denise Burse Fernandez & Peter Jay Fernandez  
CBS Corporation

Dawkins Family Foundation  
Carolyn & Neil DeSena

Alexandra Gersten-Vassilaros & John Vassilaros  
Robert Goldberg, Yorke Construction Corporation  
Felicia & Sy Jacobs

Valerie Kay & Bruce Graham  
Grace Lyu-Volckhausen, Tiger Baron Foundation  
Music Theater International

Wendy vanden Heuvel & Brad Coley  
Vicki & Mark Whatley



**LORD HIERONYMOUS  
"HARRY" STANKEYE**

(A.K.A. CHAMEL RODNEY)

WARDELL: (SPOKEN.) OH MY GOD! WHAT'S IT LIKE TO BE YOU?!

**VERSE 1**

WYCLEF: IT'S ALL ABOUT DIAMONDS SHINING  
BLINDING  
SO MUCH CHAINS IT'S GIVING ME NECK PAINS  
I SIT ON THE FINEST HANDCRAFTED DESIGNS  
ONLY ROCK BALMAIN WHEN I DRINK  
D'USSE IN MAY  
EVERYBODY AROUND ME WISHING THEY COULD  
STAY  
ON MY YACHT JUST RELAXING MUSIC BLASTIN'  
FERRAGAMO ON MY FEET

WARDELL: FANCY THAT!

WYCLEF: GIVENCHY ON MY SLEEVE

WARDELL: FANCY THAT!

WYCLEF: JOHNNY DANG ON MY NECK

WARDELL: FANCY THAT!

**CHORUS**

WARDELL: WOW! THAT WAS AMAZING MY EYES  
ARE BLAZING!  
HOW CAN I BE LIKE YOU?

WYCLEF: HERE'S HOW YOU DO  
JUST SIT BACK AND EMBRACE AND  
TRY TO ACQUIRE MY GOOD TASTE

WARDELL: YOU GOT SOME TIME TO WASTE?  
FANCY THAT!

**VERSE 2**

WYCLEF: CRUISING IN THE CLASSIC CAMARO  
SO MUCH GOLD STARTING TO FEEL LIKE A  
PHARAOH  
SO WEALTHY MY TEETH GOLD PLATED

## LIFESTYLE

LYRICS BY CHAMEL RODNEY, AGE 17

COMPOSED BY NICK BLAEMIRE

PERFORMED BY MATTHEW SALDIVAR AS

"WARDELL," JACOB MING-TRENT AS "WYCLEF,"  
AND NICK BLAEMIRE AS "GEOFFREY."

MY STYLE SO DESIRABLE CAN'T BE HATED  
GOT SELITA EBANKS AS MY PASSENGER  
SHINING SO BRIGHT IT MIGHT DAMAGE YA  
NOW WE SITTING COURTSIDE AT THE ALL STAR  
GAME  
CATCH ME AT HALFTIME WITH LEBRON JAMES

WARDELL: FANCY THAT!

WYCLEF: JAY-Z AND BEYONCE

WARDELL: FANCY THAT!

WYCLEF: KEVIN HART

WARDELL: FANCY THAT!

**CHORUS**

**VERSE 3**

WYCLEF: CHILLIN' ON MY PRIVATE ISLAND  
SOMEWHERE IN THE CARIBBEAN  
ENJOYING THE COOL BREEZE RIGHT NEXT TO  
THESE PALM TREES  
GEOFFREY CATERS TO ME WITH ANOTHER ICE  
TEA

WARDELL: HOLD UP! I WANNA BE RICH TOO!  
DO YOU MIND IF I PITCH AN IDEA TO YOU?

WYCLEF: SURE MAKE IT QUICK TIME IS MONEY  
BUT DON'T TRY ANYTHING FUNNY

WARDELL: I'LL MAKE YOU MORE MONEY

WYCLEF: FANCY THAT!

WARDELL: IT'LL KEEP THE PEOPLE HAPPY

WYCLEF: FANCY THAT!

WARDELL: IT WILL BRING YOU MORE GIRLS

WYCLEF: FANCY THAT!

WARDELL: WE OPEN UP A SHOE STORE WITH  
ALL THE LATEST KICKS  
NEW AND OLD STARTING FROM 1986  
SELL IT FOR THE LOW  
WATCH PEOPLE SPEND THEIR DOUGH

WYCLEF: WOW THAT WAS AMAZING  
MY PEOPLE WILL BE RAVING  
YOU'RE GONNA BE LIKE ME

WARDELL: I NEVER THOUGHT THIS WOULD  
COME TO BE  
MY DREAM FINALLY BEING SEEN  
I SEIZED A ONCE IN A LIFETIME OPPORTUNITY  
I WENT FROM MAKING SANDWICHES TO MAKIN'  
MILLIONS  
WARDELL & WYCLEF 'BOUT TO MAKE BILLIONS  
EVEN TRILLIONS

WYCLEF & WARDELL: FANCY THAT!

## WHAT YOU HAD TO

LYRICS BY STASIA BREE QUIÑONES, AGE 17

COMPOSED AND PERFORMED BY STEPHANIE MCKAY

BACK-UP VOCALS SUNG BY KENDAL HARTSE AND AKRON WATSON

GOING BACK REDOING IT ALL

WITH YOU BY MY SIDE  
WE WERE DOWN TO RIDE  
GIVE ME BACK THAT SUMMER SHINE  
THAT WARMTH  
IF ONLY IT WASN'T CUT SO SHORT  
YOU AND ME WE CAN BE  
WITHOUT YOU I WASN'T FULLY ME  
LEAVING ME EMPTY WITH NOTHING TO SAY  
LOST WITH NO FEEL  
HOW COULD I POSSIBLY HEAL?  
LETTING YOU GO NEVER CROSSED MY  
MIND  
WASN'T SURE IF WE WERE READY  
YOU COULDN'T MAKE THE TIME

"YOU'RE WORTH SO MUCH MORE"  
"YOU CAN DO SO MUCH BETTER"

COULDN'T SAY I WASN'T WARNED  
SUDDENLY UNREQUITED  
I COULDN'T STAY QUIET  
NOW YOU'RE GONE LEFT QUESTIONING  
WHAT I DID WRONG  
ALL THIS DOUBT, DIDN'T KNOW HOW TO GO  
ABOUT  
SUDDENLY IN TWO  
THE LOVE WAS THERE, THE FEELINGS  
WERE TRUE  
BUT YOU DID WHAT YOU HAD TO DO

"THERE'S A REASON FOR EVERYTHING"  
"IT'S NOT THE END OF THE WORLD"

IT'S STILL SPINNING, THERE'S STILL THAT  
TWIRL  
I CAN GO ON, BE FREE, BE ME  
I'VE BEEN HERE BEFORE SO I'M MORE  
THAN SURE  
I'LL BE ALRIGHT  
FUTURE'S LOOKIN' BRIGHT  
I'M NOT GONNA STOP YOU  
JUST GONNA KEEP GOING  
GONNA BE FLY  
YOU DID WHAT YOU HAD TO AND SO WILL I



**LADY CRYSTAL  
VON DAZZLESTONE**

(A.K.A. STASIA BREE QUIÑONES)



# SUPER REGULAR HARMLESS TURTLE SQUAD



**BARON ENGLEHART  
DE RUMPLEDIMPLE**

(A.K.A. JUSTIN BANNISTER)

LYRICS BY JUSTIN BANNISTER, AGE 13  
COMPOSED BY DAVID YAZBEK  
PERFORMED BY EMILY SKEGGS,  
BETSY WOLFE, AND  
ONE OR MORE SPECIAL GUESTS

## CHORUS

THE PEOPLE USED TO LOVE THE TURTLES,  
NOW THE LOVE HAS TURNED INTO HATRED  
THOSE GUYS WERE KNOWN AS  
SUPER NOT SO FUN HARMLESS TURTLES  
SUPER BORING HARMLESS TURTLES  
SUPER BORING HARMLESS TURTLES  
THEY WERE COOL AND NOW THEY'RE NOT  
THEY'RE READY TO WIN THE FIGHT  
FORMER SUPER REGULAR HARMLESS TURTLES  
NICE SHELL MEET YOU, MAN.

## VERSE 3

THEY BECAME ROGUE IN ORDER TO STOP  
LIVING THE DANGEROUS LIFE  
BUT THEY DID SOMETHING  
THAT CHANGED EVERYONE'S MIND  
THEY ACTUALLY WON THEIR FIRST FIGHT  
EVERYONE THOUGHT, "WHAT MAKES THEM DIFFERENT  
THAN ALL THE OTHER LOSER TURTLE SQUADS?"  
AFTER THAT THEY RAN AWAY  
BEING SEPARATED IN THE PROCESS

## CHORUS

EVERYONE SHOULD KNOW THE GREAT STORY OF THIS TURTLE SQUAD  
PEASANTS TO KINGS AND QUEENS TO MAIDS  
EVERYONE SHOULD PAY THEIR RESPECTS  
TO SUPER REGULAR HARMLESS TURTLES  
SUPER REGULAR HARMLESS TURTLES  
THEY WERE STRONG  
TURTLE POWER

## VERSE 1

A FAMOUS TURTLE SQUAD  
THAT EVERYONE ADMIRES  
PEOPLE THINK OF THEM AS HEROES,  
CONSIDER THEM AMERICA'S GREATEST ALLY  
YOU GUYS PROBABLY ALL KNOW THEM

## CHORUS

YOU GUYS ALL KNOW THE FAMOUS TURTLE SQUAD WITH WEAPONS  
THOSE GUYS ARE KNOWN AS  
SUPER REGULAR HARMLESS TURTLES  
SUPER REGULAR HARMLESS TURTLES  
THEY'RE READY TO LOSE THE FIGHT  
SUPER REGULAR HARMLESS TURTLES  
COME ON LOSE THE FIGHT

## VERSE 2

YOU GUYS PROBABLY DIDN'T NOTICE  
BUT THOSE TURTLES ARE  
THE SUPER REGULAR HARMLESS TURTLES SQUAD  
BUT THEY BECAME ROGUE  
THEY MADE THEIR SEPARATE WAYS AND LEFT  
SUPER REGULAR HARMLESS TURTLES SQUAD

# WHAT IS SPACE?

LYRICS BY JAYDA CAMACHO, AGE 13  
COMPOSED BY ELIZABETH ZIMAN  
PERFORMED BY LENA HALL  
BACK-UP VOCALS SUNG BY  
KENDAL HARTSE AND AKRON WATSON

THE SPACE, SPACE TAKES UP  
IT NEVER ENDS BUT IT NEVER STARTS  
EXTRAORDINARY OR "FANCY" PLANETS  
ARE OUT THERE  
LIFE FORMS TOO  
A PLANET OF DIAMONDS OR ANOTHER DIMENSION  
WHAT WE KNOW ABOUT SPACE IS SO LITTLE  
FROM WHAT IT REALLY IS

## CHORUS

ARE OUR LIVES A COMPUTER PROGRAM?  
ARE WE PUPPETS,  
OR THOUGHTS THOUGHT UP BY OTHER THOUGHTS,  
OR OTHER HUMANS PERHAPS?  
WE WATCH AS DAYS GO BY  
EVERY 100 YEARS VENUS PASSES OUR SUN  
BUT THAT HAPPENED LIGHT YEARS AGO  
IN SPACE!  
SO MANY THEORIES, BUT WHAT IS TRUE?

IS TIME EVEN RELEVANT?  
ARE STARS WORLDS OR OTHER UNIVERSES?  
THE BLACK HOLE  
KNOWN TO SUCK UP ALL LIGHT  
AND KILL EVERYTHING IN SIGHT  
BUT THE WHITE HOLE  
SHOOTS OUT LIGHT ON THE OTHER SIDE  
OUR MILKY WAY CONTAINS A BLACK HOLE  
LARGER THAN WE CAN IMAGINE...  
EXTRAORDINARY LIGHTS, OR DARK VOIDS

## CHORUS

ARE OUR LIVES A COMPUTER PROGRAM?  
ARE WE PUPPETS,  
OR THOUGHTS THOUGHT UP BY OTHER THOUGHTS,  
OR OTHER HUMANS PERHAPS?  
WE WATCH AS DAYS GO BY  
EVERY 100 YEARS VENUS PASSES OUR SUN  
BUT THAT HAPPENED LIGHT YEARS AGO  
IN SPACE!  
SO MANY THEORIES, BUT WHAT IS TRUE?



**ARCHDUKE  
HAUT E. NOSEINTHEAIR**  
(A.K.A. JAYDA CAMACHO)

## BRIDGE

THE GREAT OCEAN DOESN'T COMPARE TO  
OUR NEVER ENDING SPACE  
101% MORE LOVELY THAN SPACE,  
BUT CAN THE OCEAN CONTAIN  
A FLOOR OF LIFE FORCE OR A FLOOR OF DIAMONDS?  
SPACE MAY BE THE ANSWER TO ALL THEORIES  
BUT THE OCEAN IS THE ANSWER TO LAND AND LIFE  
BOTH STILL DEADLY  
BUT BOTH STILL BEAUTIFUL  
NEIL ARMSTRONG SAW THE BEAUTY  
SO DID 546 OTHER SPACE MEN  
THESE TWO PLACES ARE SCARY  
BUT CONTAIN BEAUTY WE WISH WE COULD CLEARLY SEE

## CHORUS

WHAT IS SPACE?  
SPACE IS LIFE

The 52nd Street Project proudly presents  
**THE LORRAINE COHEN  
STAGE COMBAT PROGRAM  
FINAL PERFORMANCE**

Friday, June 12<sup>th</sup> at 6:00 p.m.

*This program was led by fight choreographer **Lee Aaron Rosen** and  
stuntwoman/actor **Rin Allen**.*

**THE CAR DEALERSHOP**

Written by Adam Alkindi, age 13

Directed by Gardiner Comfort

Ben ..... Adam Alkindi  
Imax ..... Gardiner Comfort  
Shanequa..... Priscilla Diaz

**DISTRESS ON CAKE (AND FOR THE FIRST TIME EVER!)**

Written by Kaylee Zambrano, age 12

Directed by Alyssa Cartwright

Angel Sheep (Eep) Peep..... Kaylee Zambrano  
Devil Hard Bubblegum Peep ..... Alyssa Cartwright

**THE LAST BATTLE**

Written by Nathaniel Ortiz, age 12

Directed by Marco Formosa

Moonkla..... Nathaniel Ortiz  
Nugget.....Marco Formosa

**IT'S TIME TO DIE**

Written by Sevan Asencio, age 12

Directed by Michael Propster

Freddy Fazbear..... Sevan Asencio  
Springtrap ..... Michael Propster

**IMMORTAL FRIENDS**

Written by Wilhelmina Ohene Kari Kari, age 14

Directed by Lindsay Torrey

Kagura ..... Wilhelmina Ohene Kari Kari  
Sarah Mayworth ..... Lindsay Torrey

## STORY OF THE BAD AGENT

Written by Richard Brea, age 15

Directed by Rin Allen

Agent Phill .....Richard Brea  
Dom ..... Rin Allen  
President ..... Mitchell Harrison

## THE TEST OF FRIENDSHIP

Written by Imani Lewis, age 14

Directed by Mirirai Sithole

Mayleen ..... Imani Lewis  
Aaliyah.....Mirirai Sithole

## Lorraine Cohen 1927-2005

For more than forty years, Lorraine Cohen dedicated herself to all facets of the theater, including acting, directing and teaching. Her deeply memorable performances as Amanda in *The Glass Menagerie* and as Emily Dickinson in *The Belle of Amherst* were often compared favorably with the very well known actors who had played those roles before her. Those who knew her as a teacher, remember the amazing annual Shakespeare productions of her fifth graders and the many stunning performances of her high school students.

In the 1960's Laurie performed in a series of plays at the Bergen County Players in New Jersey including *Ring Around Elizabeth* (1960), *Fumed Oak* (1961), *Blithe Spirit* (1962), and *The Waltz of the Toreadors* (1961). In 1969 she performed in *No Bed of Roses* at the Showplace Summer Theatre. Laurie also spent many productive years at The New Dimension Theatre Studio in Englewood, New Jersey where Dr. Richard Imundo was the Artistic Director. At The New Dimension she taught acting to children and young adults, and also performed in many productions including *Animal* (1971), *The Glass Menagerie*, and *Uncle Vanya* (1970). She also directed and acted in many evenings of scenes at The New Dimension. One of her early students at The New Dimension was a young man by the name of John Travolta who also performed with her in *Who'll Save the Plowboy?* (1966).

Having obtained her college degree from Fairleigh Dickinson University in Teaneck, New Jersey, she performed in a series of plays produced by the University Players, including *Ghosts*, *The Glass Menagerie*, and *J.B.* While studying for her masters degree at Montclair State College, she performed in several productions there including *The Hostage*, *Plaza Suite*, and *Not Now Darling*. Laurie also performed in *Cinderella* at the William Paterson College Summer Theatre Workshop, and in 1984 she performed in *The Devil's Disciple* at the Williamstown Theatre Festival in Williamstown, Massachusetts.

In 1983 Laurie starred as Emily Dickinson in the one-woman show *The Belle of Amherst*, directed by her friend and colleague, John Brancato. *The Belle of Amherst* had a limited run at The Tyson Studio in New York City to rave reviews in *The New York Times* and *The Daily News*.

Though many encouraged Laurie to pursue a professional acting career, she always made it clear that her true love was teaching and she dedicated much of her life to filling young students' hearts and minds with the love of theatre, both in its literary form and as a performing art. During her tenure in the 1970's as a fifth grade teacher at the Longfellow School in Teaneck, New Jersey, she directed an annual Shakespeare play starring her fifth grade students, performing the likes of *Macbeth*, *Julius Caesar* and *Hamlet*. Laurie's love of theater and teaching reached its pinnacle during her many years teaching English and Drama at Teaneck High School in Teaneck, New Jersey. She truly loved teaching drama to high school students, introducing them to the joys of acting and playwriting, and she directed an enormous number of full length productions, musicals, scenes, and student-written original plays. She directed too many shows to list individually, but they included *Cabaret*, *Diary of Anne Frank*, *A Midsummer Night's Dream*, *The Crucible*, *The Man Who Came To Dinner*, *Don't Drink the Water* and *Waiting for Godot*. In addition to these productions, she directed the students in an annual Evening of Scenes. Her students won many awards for their work at the annual Bucks County Playhouse Drama Festivals in Pennsylvania. Even after retirement from teaching, she continued to direct performances at Leonia High School, in Leonia, New Jersey.

In addition to acting and teaching, Laurie also edited three books for the theatre: *Scenes for Young Actors*, *Monologues for Young Actors*, and *Scenes for Mature Actors*, all published by Avon Books. These three books continue to be used today in acting classes and auditions around the country.

Laurie is remembered lovingly by her five children, her three siblings, her eight grandchildren, her companion Dick, her many colleagues and friends, and her innumerable students. It is in her memory that they support the 52nd Street Project. It is what she would have wanted.



Gus Rogerson, Artistic Director

Carol Ochs, Executive Director

Natalie Hirsch, Associate Artistic Director

The  
52nd Street Project  
Teen Ensemble  
Presents

WILLIAM  
SHAKESPEARE'S

# A MIDSUMMER NIGHT'S DREAM

THE  
NORTH  
AMERICAN  
TOUR

Directed by  
Nicole A. Watson  
and  
Emma Weinstein

Adapted by  
Chris Ceraso

ART BY LEE AARON ROSEN

# The Cast, In Order of Appearance

Theseus, Duke of Athens .....	Michael Bannister
Egea, older sister and guardian to Hermia .....	Jazmine Mikell
Lysander, in love with Hermia.....	Devin Gonzalez
Demetrius, also in love with Hermia .....	Dante Quiñones
Peter Quince, a carpenter .....	Brandon Leon
Snuggles, a joiner.....	Jazmine Mikell
Nikki Bottom, a hair weaver.....	Elizabeth Vazquez
Francis Flute, a bellows-mender .....	Martin Sanchez
Snooty Starveling, a tinker/tailor.....	Elena Caballero
Hippolyta, queen of the Amazons, betrothed to Theseus.....	Natalia Caballero
Hermia, younger sister to Egea .....	Nathaly Trinidad
Helena, in love with Demetrius .....	Mari Ulloa
Oberon, King of the Fairies.....	Edison Sibri
Titania, Queen of the Fairies .....	Gabriella DeJesus
Puck or Robin Goodfellow .....	Joyce Cheung
Peaseblossom, a fairy .....	Natalia & Elena Caballero
Cobweb, a fairy.....	Jazmine Mikell
Moth, a fairy.....	Martin Sanchez
Mustardseed, a fairy.....	Brandon Leon

## Production Staff

Composer/Music Director.....	Avi Amon
Lighting Designer.....	Burke Brown
Costume Designers .....	Michael Piatkowski and Viviane Galloway
Goddess of Sound.....	Vanessa Valdes
Stage Manager/Board Operator (NYC) .....	Charles W. Turner III
Tour Manager .....	George Babiak
Flyer/Program Art design.....	Lee Aaron Rosen
Prop/Set Design .....	George Babiak
Choreography.....	Kevin Isola
Direction .....	Nicole A. Watson & Emma Weinstein

**Shakespeare Coaches:** Jeremy Beck, Dan Butler, Molly Camp, Maxon Davis, Carson Elrod, Jeremy Fisher, Greg Hildreth, Kevin Isola, Sue Jean Kim, Joanna Parson, Annie Purcell, Jeremy Rishe, Lynne Rosenberg, Deenah Shutzer, Lindsay Torrey, Anne Troup, and Kerry Whigham.

**Thanks to our Calgary friends and hosts:** Clem Martini, Elena Sinitsyna, Michelle Chia and The University of Calgary; Aaron Braham and the Airdrie Pro Rodeo; Stephen Hunt; Dan Perry; and Alan and Faylene Valdes.

**Thanks to our Golden, B.C. friends and hosts:** Bill Usher, Tammy Persson, Mike Pecora, Mike Garner, and Kicking Horse Culture; the Kicking Horse Mountain Resort; Petra Nott and the Island Restaurant; and the Rondo Motel.

And special thanks to Haley Martinez and Tiara Varela.

## A MIDSUMMER NIGHT'S DREAM - THE SYNOPSIS - ACT 1

**Theseus**, the Duke of Athens, is planning a grand festival for his marriage to **Hippolyta**. **Egea** interrupts with a complaint that her younger sister **Hermia**, her ward (in our version), is refusing to obey their father's dying wish that Hermia marry a young Athenian named **Demetrius**. The headstrong Hermia is in love with **Lysander**. Egea asks for the right to punish Hermia with death if she refuses to obey.

Theseus agrees that Hermia's duty is to obey her sister and father and threatens her with either entering a nunnery or being put to death if she refuses. Lysander protests but is overruled by the law. He and Hermia decide to flee by night into the woods surrounding Athens, where they can escape the law and get married. They tell their plan to **Helena**, a girl who is madly in love with Demetrius. Hoping to gain favor with Demetrius, Helena decides to tell him about the plan.

Some local artisans have decided to perform a play for Theseus as part of his wedding celebration. They choose the tale of Pyramus and Thisbe for their play, and meet to have their roles assigned. **Bottom** the Weaver gets the main role of Pyramus, and **Flute** the Bellows Mender takes the role of Thisbe. They agree to meet the next night in the woods, where they can rehearse their play without being disturbed.

**Robin Goodfellow**, a.k.a., **Puck**, meets a fairy who serves **Titania**, the Fairy Queen. Puck tells Titania's servant that **Oberon**, the Fairy King, is in the woods and that Titania should avoid Oberon because they will quarrel. That is just what happens when the King and Queen meet; they argue over a young human boy that Titania has stolen and for whom she is caring. Oberon wants the boy for himself, but Titania refuses to give him up.

Oberon decides to play a trick on Titania and to put the juice of a magical flower in her sleeping eyes. The magic juice will make her fall in love with the "first love creature that she sees" when she awakens. Soon after Oberon sends Puck to fetch the flower, he overhears Demetrius and Helena in the woods.

When Oberon sees that Demetrius has deserted Helena in the dark forest, he decides to change the situation. He commands Robin/Puck to put some juice in Demetrius' eyes that will make him fall for Helena. He then finds Titania and drops the juice into her eyelids. When Robin goes to find Demetrius, he instead comes across Lysander, and mistakenly uses the magic juice on him.

By accident, Helena comes across Lysander and wakes him up, whereupon he immediately falls in love with her and starts to chase her through the woods. Together they arrive where Oberon is watching, and he realizes the mistake. He then puts some of the flower juice in Demetrius' eyes, who upon waking and seeing Helena, also falls in love with her. Helena thinks the two

men are trying to torment her for being so hopelessly stuck on Demetrius, and becomes furious at their mutual protestations of love.

The artisans are in the woods, and start to rehearse their play, but they constantly ruin the lines and mispronounce the words. Out of fear that the play is too scary, they decide to make it less realistic: the lion should announce that she isn't really a lion, but an actor playing a lion, and Bottom should tell the audience that she really is not going to die, but only pretend to do so. Puck, watching the silly scene, decides to have some fun of her own. She catches Bottom alone and puts an ass-head on the unwary amateur thespian. When Bottom returns to the troupe, they all run away in horror. But when Bottom's singing awakens Titania, she has an entirely different reaction. The love juice makes her fall in love with the strangely beautiful creature and she decides to take Bottom to her fairy lair.

## ACT TWO

Lysander and Demetrius prepare to fight one another for Helena. Puck intervenes and leads them through the woods in circles until they collapse with exhaustion. Puck then brings the two women to the same place, and puts them to sleep as well.

Oberon finds Titania and releases her from the spell. He tells Puck that Titania, in her delirious love-state, gave him the boy that he wanted all along. He has Puck remove the ass-head from Bottom and says that Bottom will think that it was all a dream. He further releases Lysander from the spell, but he and Robin leave Demetrius with eyes of love for Helena.

Theseus arrives with a hunting party and finds the lovers stretched out on the ground. He awakens them with hunting horns, and they explain why they are in the woods. Egea demands that she be allowed to exercise the law on Hermia, but Demetrius intervenes. He says he is no longer in love with Hermia, but now mysteriously feels love only for Helena. Theseus decides to overbear Egea and let the lovers get married alongside him and his bride, Hippolyta. Together they return to Athens.

Bottom wakes up and remembers the whole episode with Titania as a wondrous dream. The rustic players are reunited in Athens, and together they head over to Theseus' palace where they are invited to perform their play of Pyramus and Thisbe. After the play and a dance, everyone retires to bed, for "'tis almost fairy time."

Oberon and Titania bless the couples, their future children, and the theatre audience. Puck asks the audience to forgive the actors if they gave offense, and says that if the audience disliked the play, they should imagine that it was only a dream.

## **The 52nd Street Project Staff**

Carol Ochs, Executive Director

Gus Rogerson, Artistic Director

Natalie Hirsch, Associate Artistic Director

Liz Bell, Director of Education

John Sheehy, Director of Development & Marketing

George Babiak, Production Manager

Tim J. Lord, Technical Director

Laura Lane, Manager of Individual Giving

Johanna Vidal, Community Coordinator\*

Garrett Kim, Program Director

### **Consultants**

Iris A. Brown, Graphic Designer;

Chris Ceraso, Teen Dean

### **Interns**

Priscilla Diaz, Mitchell Harrison, Kira Newmark,

### **Teen Receptionists**

Britney Trinidad, Chayse Peña, and Maria Martinez

### **Concessions**

Jasmine Correa

## **The 52nd Street Project Board of Directors**

Lisa Benavides

Rachel Chanoff

Cathy Dantchik, co-chair

Carolyn DeSena

Wendy Ettinger,

chair emeritus

Louis P. Friedman, co-chair

Alexandra Garrison

Alex Gersten-Vassilaros

Robert Goldberg

Stephen Graham,

chair emeritus

Valerie Kay

Frances McDormand

Noël Mihalow

Carol Ochs

Willie Reale, founder

Gus Rogerson

Shirley Rumierk,

alumni member\*

José Soto, Jr.,

alumni member\*

Lisa Tilney

Merritt Tilney

Wendy vanden Heuvel

Mark Whatley

*\*Alumnus of The 52nd Street Project Teen Ensemble*





**Kicking Horse Culture**  
ENGAGE, ENERGIZE AND ENRICH THE CULTURAL LIFE OF KICKING HORSE COUNTRY



The 52nd Street Project (The Project) is dedicated to the creation and production of new plays for and by kids between the ages of ten and eighteen who reside in the Hell's Kitchen neighborhood in New York City. The Project does this through unique mentoring programs that match kids with professional (and volunteer!) theater artists.

The Project is about making children proud of themselves. The Project is not about teaching children to act, although they will learn to. It is not about teaching them to write plays, although they will learn that as well. What it is about is giving a kid an experience of success. It is about giving a kid an opportunity to prove that he or she has something of value to offer, something that comes from within that he or she alone possesses, something that cannot be taken away.

The Project's Teen Ensemble is the final step in the kids' training: a two-year acting class that culminates in the production of a full-length play by William Shakespeare, the very one you are seeing tonight. This year's show is being done in New York; Calgary, Alberta; and Golden, British Columbia. We are very grateful to all our American and Canadian friends for enabling this tour.

The following foundations and government agencies have generously supported the Teen Program through their contributions:

Dramatists Guild Fund  
Howard Gilman Foundation  
New York State Council on the Arts  
City of New York Department of Cultural Affairs  
Theatre Communications Group

The 52nd Street Project is a member of Art New York



The 52nd Street Project gratefully acknowledges the support of the following foundations and corporations: Brenner Family Foundation; Cantor Fitzgerald; Bull's Head Foundation; Carnegie Corporation of New York; CBS Foundation; City Winery; Common Sense Fund; Consolidated Edison; Dawkins Family Foundation; The Neil V. DeSena Foundation; Dramatists Guild Fund; Dubin Foundation; Educational Foundation of America; Evercore Partners; Harkness Foundation; HBO; Horace W. Goldsmith Foundation; I. Weiss; Jean & Louis Dreyfus Foundation; Kirkland & Ellis Foundation; Liquid Holdings Group; Ann M. Martin Foundation; Marusi Family Foundation; Newman's Own; Ninth Avenue Association; PAR Group; Parsons Family Foundation; Pinkerton Foundation; Rockefeller Foundation; The Shubert Organization; Slate Path Capital; Harold & Mimi Steinberg Charitable Trust; Surdna Foundation; Susquehanna Foundation; Tax Pro Financial Network; Tiger Baron Foundation; United Talent Agency; Yorke Construction Corp; ZenithOptimedia. (List current as of 7/1/14)

Robert Abrams	Penelope Collins	Sarah Horowitz	Sue Phillips
& Cynthia Vance	Judith-Ann Corrente	& David Venarde	Todd Poisson
George Ackert	Janet Coviello	Andrea Johnson	Suzanne Poulin
Michael Alicastro	William Crudup	Beth Ifcher	Helaine & Michael Pruzan
Elton Andrews	Kyle Czepiel	Carine Joannou	Christopher Randolph
Richard Anthony	Arthur Dantchik	Kristen Johanson	Helen & Peter Randolph
Cecilia Arana	Cathy Dantchik	Andrea Johnson	Jacquelyn Reingold
Emily Armstrong	Leslie Dantchik	Cindy Kaplan & David Froelich	Anita A. Rogerson
James Armstrong	Peter & Judith Dawkins	Valerie Kay & Bruce Graham	David Ross & Laura Ross
Dominick & Ilene Balletta	Carolyn & Neil DeSena	Louise Klebanoff	Dr. Steve Rudin
Becky Ann & Dylan Baker	Rebecca & Richard Dresser	Henry Krieger & Robert Joy	Laura Sametz & Anton Fig
Ken Bantum	Peter Doyle	Jacki Ochs & Jan Kroeze	Karin & Thomas Schall
Carolyn Bechtel	Max Dyksterhouse	Judy Kuhn & David Schwab	Maury Schott
Lisa Benavides	& David Roady	Frances & Fred Langbecker	Susan Schroeder
& Tim Blake Nelson	Doug Eisenberg	Gabrielle Lansner	& Britt Adams
Louisa Benton	Lynn Ellenberg	& Dean Taucher	Whitney Scott
Gavin Berger	Nora Ephron	Brian Lapin	& Peter Jacobson
& Craig Berggren	& Nicholas Pileggi	Michael Lawrence	Meg Simon
Stephanie Berger & Paul King	Peter Jay Fernandez	& Glen Gillen	Christopher Solomon
Beth & Eric Berman	& Denise Burse Fernandez	Warren Leight & Karen Hauser	Jonathan Soros
David Beth	Liz Flahive & Jeff Cox	Mickey Lemle	& Jennifer Soros
Lewis Black	Wendy Flanagan	Jonathan Levine	Jenny & Jon Steingart
Emily Blavatnik	& Chris O'Malley	Helen Levy	Tracy Straus
Allison Blinken	Karen & Paul Freitas	Melissa Liebling-Goldberg	Danny Strong
Noah Bogan	Sally Froelich	& John Barrett	Al Styron & Ed Beason
Jane Bolster	Alexandra Garrison	Kay M. Lim	Susanna Styron
& Steve Wertimer	Beverly Gasner	Adrianne Lobel	Richard Sweren
Buzz Bovshow	Rose Gasner & Larry Chertoff	John Lynch	Lili Taylor
Blaise R. Box	Celia Gerard & Mark McGrath	Grace Lyu-Volckhausen	Lisa Tilney & Chris Lawrence
Becky Browder	Christina Gerber	Julie & Alex Margolies	Merritt Tilney & Douglas Kaden
& Ted Neustadt	Freddie & Myrna Gershon	Ali Marsh	Lorraine Tobias & Alex Draper
Carlton T. Brown	Jenny Gersten & Willie Reale	Lin Manuel Miranda	Liz Tuccillo
Iris A. Brown & Joe White	Alexandra Gersten-Vassilaros	Frances McDormand	Laura Valeroso
Justin Brownhill	& John Vassilaros	& Joel Coen	& David Seidman
Brian Byrnes	Scott Aaron Gewirtz	Emily & John Morgan	Wendy vanden Heuvel
Shawn & Laura Byron	& Laura Gewirtz	Amanda & Neal Moszkowski	& Brad Coley
Joseph Capozzi	Elizabeth Giamatti	Suzen Murakoshi	Susan J. Vitucci
Leah Carr	Robert Goldberg	& Mark Temme	Mary Pat Walsh
Lawrence Catena	& Betsy MacIsaac	Fred Nelson	Dr. Mildred Walton
Chris Ceraso	Stephen & Cathy Graham	Randy & Rona Nelson	Brenda Wehle & John C. Lynch
Rachel Chanoff	Jan Gura & Alan Pickman	Ruth Nelson	Carol Whitesides
Todd Christie	Susan Hanson	Lori O'Connor	Zee Wiener
Damien Clancy	Jessica Hecht	Carol Ochs & Bruce MacVittie	Ruth Ann Wynter
Matthew Clancy	& Adam Bernstein	Jacki Ochs & Jan Kroeze	J.P. Xenakis
Katie Clark	Kathy & Jamie Herring	Kevin O'Rourke	Carole Yass
Elizabeth Clemants	Peter Herdrich & Karen Trott	& Edith Thurber	Yildiz Yuksek
David Cohen	William Holtzman	Jane Perlmutter	& Richard Blackstone
& Sandra Novak Cohen	& S. Sylvia Shepard	& Greg MacPherson	Connie & Marc Zand
Larry Cohen	Mary Horowitz	Elizabeth Peters	



Friday, July 24 at 7:30  
 Saturday, July 25 at 7:30  
 Sunday, July 26 at 3:00

**THE 52ND STREET PROJECT'S  
 FIVE ANGELS THEATER**

# HERE. ME. NOW. THE PRESENT PLAYS

The Annual Block Island One-on-Ones - July 124-26, 2015 at the Five Angels Theater

## The 52nd Street Project Staff

Gus Rogerson, Artistic Director	Carol Ochs, Executive Director
Natalie Hirsch, Associate Artistic Director	John Sheehy, Dir. of Development & Marketing
Garrett Kim, Program Director	Laura Lane, Mgr. of Individual Giving
Liz Bell, Director of Education	George Babiak, Production Manager
Johanna Vidal*, Community Coordinator	Tim J. Lord, Technical Director

Jennifer Jimenez\*, Day Receptionist  
 Anthony Mejia\*, Jorge Zapata\*, Front Door Receptionists

*\*Alumnus of The 52nd Street Project*

### Consultants

Iris A. Brown, Graphic Designer; Chris Ceraso, Teen Dean

### Interns

Priscilla Diaz, Mitchell Harrison, Kira Newmark

### Teen Employees

Receptionists: Britney Trinidad, Chayse Peña, and Maria Martinez

Block Island Teen Counselor: Jasmine Correa

Ushers: ?

## “HERE. ME. NOW.” Production Staff

### Composer/Music Director

Kim D. Sherman

### Set Designer

Kevin Joseph Roach

### Lighting Designer

Ben Fichthorn

### Costume Designers

Michael Piatkowski and

Crystal Thompson

### Sound Designer

Johanna Vidal

### Stage Manager

Liz Bell

### Projection Designs

George Babiak and The 52nd Street

Project Projection Archive

### Prop Design Team

George Babiak

### Backstage Crew

Priscilla Diaz, Mitchell Harrison,

Kira Newmark, Maria Martinez,

Karen Tineo

### Box Office Manager

Carol Ochs

### Flyer/Program Art

Patrick Jones

### Chefs

Martha Velie-Gass and Pat Ritter

## COOL STUFF ON SALE IN THE LOBBY!

Fabulous Flyer Bars..... \$2.50  
*and featuring Shel Silverstein's "Fivey and Twoey" logo:*  
 Project Hoodies..... \$30.00  
 Project Caps ..... \$20.00  
 Project T-shirts.....\$12.00/\$20.00  
 Project Mugs..... \$5.00  
 Project Notebook ..... \$5.00  
 Project Pencil 3-pack.....\$1.00

Thank you for coming to HERE. ME. NOW. If you are not on our mailing list, you can join on-line at [www.52project.org](http://www.52project.org). If you're interested in being a volunteer, fill out the form below and hand it to one of our staffers in the lobby.

### PLEASE PUT ME ON YOUR LIST:

07/15

NAME \_\_\_\_\_

ADDRESS \_\_\_\_\_

CITY \_\_\_\_\_

STATE \_\_\_\_\_

ZIP \_\_\_\_\_

HOME PHONE \_\_\_\_\_

DAYTIME OR MOBILE PHONE \_\_\_\_\_

E-MAIL ADDRESS \_\_\_\_\_

MY OCCUPATION \_\_\_\_\_

MY HOBBIES \_\_\_\_\_

WANT TO BE GREEN AND SAVE THE PROJECT MONEY ON POSTAGE?  
 CHECK THIS BOX TO RECEIVE OUR NOTICES EXCLUSIVELY VIA E-MAIL.

### YES, I WOULD LIKE TO BE OF HELP. I CAN:

- |   |   |  |
|---|---|--|
| <input type="checkbox"/> Help load in and out for shows | <input type="checkbox"/> Draw and/or paint  | <input type="checkbox"/> Help kids with homework |
| <input type="checkbox"/> Hang lights                    | <input type="checkbox"/> Help with mailings | <input type="checkbox"/> Teach kids a skill      |
| <input type="checkbox"/> Work on a backstage crew       | <input type="checkbox"/> Do office work     | <input type="checkbox"/> Be a chef at an event   |
| <input type="checkbox"/> Do graphic design              | <input type="checkbox"/> Design sound       | <input type="checkbox"/> Design and sew costumes |
| <input type="checkbox"/> Other (please specify) _____   |   |  |

### MY SCHEDULE IS:

- Very flexible. I'm often available during weekdays.  
 Somewhat flexible. I can help on the occasional morning or afternoon during the week.  
 Not very flexible at all, but I've got some free time on evenings and weekends.

If you would like to mail this (and you're always welcome to enclose a tax-deductible contribution), you can send it to: The 52nd Street Project, 789 10th Avenue, New York, NY 10019. Or fax it to (212) 333-5598.



The One-on-One Program is made possible with public funds from The New York State Council on the Arts, a state agency, and the New York City Department of Cultural Affairs. The 52nd Street Project is a member of Art/NY and Theatre Communications Group (TCG), the national organization for the American theatre.

COME BACK NEXT MONTH FOR...

GAIS RODERSON, ARTISTIC DIRECTOR    NATALIE HIRSH, ASSOCIATE ARTISTIC DIRECTOR    CAROL OCHS, EXECUTIVE DIRECTOR

THE 52ND STREET PROJECT PRESENTS:

# HERE. ME. NOW.

## THE PRESENT PLAYS

THE 2015 WAREHAM, MASS. ONE-ON-ONES



10  
NEW ADULT-WRITTEN  
PLAYS FEATURING KIDS  
WITH ADULT PARTNERS

Friday, Aug. 21 at 7:30 p.m.  
Saturday, Aug. 22 at 7:30 p.m.  
Sunday, Aug. 23 at 3:00 p.m.

**The 52nd Street Project's Five Angels Theater**  
789 10th Avenue, between 52nd and 53rd Streets  
Admission is free, but reservations are strongly encouraged! To reserve, visit [www.52project.org](http://www.52project.org).



### KEEP AN EYE OUT FOR INTERNS!

If you know of any college or graduate students who might enjoy working with us, playing with us, and going on trips with us for a semester, please have them contact Lisa Kerner. We are especially looking for interns for Spring 2016.

### The 52nd Street Project Board of Directors

Lisa Benavides	Frances McDormand
Rachel Chanoff	Noël Mihalow
Cathy Dantchik, co-chair	Carol Ochs
Carolyn DeSena	Willie Reale, founder
Wendy Ettinger, chair emeritus	Gus Rogerson
Louis P. Friedman, co-chair	Shirley Rumierk, alumni member*
Alexandra Garrison	José Soto, Jr., alumni member*
Alex Gersten-Vassilaros	Lisa Tilney
Robert Goldberg	Merritt Tilney
Stephen Graham, chair emeritus	Wendy vanden Heuvel
Valerie Kay	Mark Whatley

### What's Going On Here?

The 52nd Street Project is a non-profit organization that brings children from the Hell's Kitchen neighborhood together with professional theater artists to create original theater. HERE. ME. NOW. is a production of our One-on-One program, which is designed to give children the opportunity to go away for one-week stays in the country and enjoy the undivided attention of a professional theater artist who serves as friend, mentor, and collaborator.

### In-Kind Contributions

Abbeville Press; abc cocina; Alvin Ailey American Dance Theater; Richard Anthony; Lewis Black; Iris A. Brown Design; William Curran & A Curran Affair; Emmett Global; Evercore Partners; Edie Falco; Empanada Mama; Jenny Gersten & Friends of The High Line; Google; Jonathan Groff; ICI; Kahve; Karen Kowgios of Fried & Kowgios; Charlie Marshal & the Marshal Restaurant; Noël & Joe Mihalow; Neustar; Nonesuch Records; Pharma Print; the Public Theater; Sesame Workshop; Wendy Stuhlberg; Tao Restaurant; Uber; John A. Vassilaros; Watkins, Inc.; and Paul, Weiss, Rifkind, Wharton & Garrison LLP.

### Special Thanks

Our Host Families- Allison and Michael Anderson; Susan Bush; Socha Cohen; Katy Homans and Patterson Sims; Cathy Joyce and Nigel Grindley; Virginia Dare; and our magnanimous headquarters host Carl Kauffman. Sincere thanks to our chefs Martha Velie-Gass and Pat Ritter, Amanda Gass; McQuade's Marketplace; Robbie Brown; Rita and Steve Draper; Jessie Edwards; Amelia Gallant at the Block Island Grocery; Cindy and Stan Geer at the Depot; Glenn and Annie Hall; Debbie Hart; Interstate Navigation; Josie Merck and Jim Stevenson; Ron and Judy Tierney.

*\*Alumnus of The 52nd Street Project*

## HERE. ME. NOW. THE PRESENT PLAYS - ACT 1

All original music composed by Kim D. Sherman  
*Here. Me. Now. Theme Song* lyrics by John Sheehy

### SIGNS

By Jiehae Park for Lakshmi De Jesus, age 10  
Costume Designer: Michael Piatkowski

Seven ..... Lakshmi De Jesus  
Glinda ..... Marinda Anderson

*I'll Be Like* lyrics by Jiehae Park.

### MEN OF SCIENCE!!

By Tim J. Lord for Emmanuel Goicuria, age 11  
Costume Designer: Michael Piatkowski

The Mad Scientist Rex ..... Emmanuel Goicuria  
His Lab Assistant, Harold ..... Michael Propster  
Turtle ..... George Babiak  
Sea Slugs ..... Jasmine Correa, Mitchell Harrison and Kira Newmark

*Maaaaaad Scientist* lyrics by Tim J. Lord and Men Of Science lyrics by Emmanuel Goicuria and Tim J. Lord.

### A-GHOST-A-PHOBIA

By Adaire Kamen for Kiara Figueroa, age 12  
Costume Designer: Michael Piatkowski

Sabrina ..... Kiara Figueroa  
Alice The Ghost ..... Tina Chilip

*Be Brave* lyrics by Adaire Kamen.

### CLOWN TIME IS OVER

By John Sheehy for Stevens Velasquez, age 11  
Costume Designer: Crystal Thompson

Bazingo..... Stevens Velasquez  
Zorpblat ..... John Sheehy

*Back* lyrics by John Sheehy.

### THE WORLD MIND-READING CHAMPIONSHIP

By Michael Mitnick for Ethan Perez, age 11  
Costume Designer: Michael Piatkowski

Dr. B'Geniusion ..... Ethan Perez  
Frank ..... Sathya Sridharan  
Announcer ..... Mitchell Harrison

*The Prediction Song* lyrics by Michael Mitnick.

## HERE. ME. NOW. THE PRESENT PLAYS - ACT 2

### AMERICA'S NEXT TOP MYSTICAL CREATURE

By Vella Lovell for Rosneyri Rosario, age 11  
Costume Designer: Crystal Thompson

Yolanda The Unicorn ..... Rosneyri Rosario  
Tammy The Troll ..... Vella Lovell  
Darnell The Dragon ..... Mitchell Harrison  
Announcer ..... Jasmine Correa  
Mermaid Girl ..... Priscilla Diaz

*Cousins!* lyrics by Vella Lovell.

### UNDERCOVER COFFEE CART

By Sean Kenealy for Andry Moreno, age 12  
Costume Designer: Michael Piatkowski

Frank ..... Andry Moreno  
Milo ..... KeiLyn Durrel Jones

*Coffee Guy Or Tough Guy* lyrics by Sean Kenealy.

### FIELD WORK

By Lucy Boyle for Jayleen Velez, age 12  
Costume Designer: Michael Piatkowski

Dr. Eleanor Shamoan ..... Jayleen Velez  
Carla Higgins ..... Jessica Savage  
Paula ..... Kira Newmark

*The Past Isn't Dead, It Isn't Even Past* lyrics by Lucy Boyle.

### THE TIME MACHINE

By Itamar Moses for Rodery Rosario, age 11  
Costume Designer: Michael Piatkowski

Sam ..... Rodery Rosario  
Old Sam..... Michael Braun

*To Use Or To Smash* lyrics by Itamar Moses.

### LIGHT UP THE PARK

By Christina Quintana for Natasha Davis, age 11  
Costume Designer: Michael Piatkowski

Fiona ..... Natasha Davis  
Monique ..... Arielle Goldman

*Do The Firefly* lyrics by Christina Quintana.

The 52nd Street Project gratefully acknowledges the support of the following foundations and corporations: Brenner Family Foundation; Cantor Fitzgerald; Bull's Head Foundation; Carnegie Corporation of New York; CBS Foundation; City Winery; Common Sense Fund; Consolidated Edison; Dawkins Family Foundation; The Neil V. DeSena Foundation; Dramatists Guild Fund; Dubin Foundation; Educational Foundation of America; Evercore Partners; Harkness Foundation; HBO; Horace W. Goldsmith Foundation; Howard Gilman Foundation; I. Weiss; Jean & Louis Dreyfus Foundation; Kirkland & Ellis Foundation; Liquid Holdings Group; Ann M. Martin Foundation; Marusi Family Foundation; Newman's Own; Ninth Avenue Association; PAR Group; Parsons Family Foundation; Pinkerton Foundation; Rockefeller Foundation; The Shubert Organization; Slate Path Capital; Harold & Mimi Steinberg Charitable Trust; Surdna Foundation; Susquehanna Foundation; Tax Pro Financial Network; Tiger Baron Foundation; United Talent Agency; Yorke Construction Corp; ZenithOptimedia. (List current as of 7/11/14)

Robert Abrams & Cynthia Vance	Penelope Collins Judith-Ann Corrente	Sarah Horowitz & David Venarde	Sue Phillips Todd Poisson
George Ackert	Janet Coviello	Andrea Johnson	Suzanne Poulin
Michael Alicastro	William Crudup	Beth Ifcher	Helaine & Michael Pruzan
Elton Andrews	Kyle Czepiel	Carine Joannou	Christopher Randolph
Richard Anthony	Arthur Dantchik	Kristen Johanson	Helen & Peter Randolph
Cecilia Arana	Cathy Dantchik	Andrea Johnson	Jacquelyn Reingold
Emily Armstrong	Leslie Dantchik	Cindy Kaplan & David Froelich	Anita A. Rogerson
James Armstrong	Peter & Judith Dawkins	Valerie Kay & Bruce Graham	David Ross & Laura Ross
Dominick & Ilene Balletta	Carolyn & Neil DeSena	Louise Klebanoff	Dr. Steve Rudin
Becky Ann & Dylan Baker	Rebecca & Richard Dresser	Henry Krieger & Robert Joy	Laura Sametz & Anton Fig
Ken Bantum	Peter Doyle	Jacki Ochs & Jan Kroeze	Karin & Thomas Schall
Carolyn Bechtel	Max Dyksterhouse & David Roady	Judy Kuhn & David Schwab	Maury Schott
Lisa Benavides & Tim Blake Nelson	Doug Eisenberg	Frances & Fred Langbecker	Susan Schroeder & Britt Adams
Louisa Benton	Lynn Ellenberg	Gabrielle Lansner & Dean Taucher	Whitney Scott & Peter Jacobson
Gavin Berger & Craig Berggren	Nora Ephron	Brian Lapin	Meg Simon
Stephanie Berger & Paul King	& Nicholas Pileggi	Michael Lawrence & Glen Gillen	Christopher Solomon
Beth & Eric Berman	Peter Jay Fernandez & Denise Burse Fernandez	Warren Leight & Karen Hauser	Jonathan Soros & Jennifer Soros
David Beth	Liz Flahive & Jeff Cox	Mickey Lemle	Jenny & Jon Steingart
Lewis Black	Wendy Flanagan & Chris O'Malley	Jonathan Levine	Tracy Straus
Emily Blavatnik	Karen & Paul Freitas	Helen Levy	Danny Strong
Allison Blinksen	Sally Froelich	Melissa Lieblich-Goldberg & John Barrett	Al Styron & Ed Beason
Noah Bogan	Alexandra Garrison	Kay M. Lim	Susanna Styron
Jane Bolster & Steve Wertimer	Beverly Gasner	Adrienne Lobel	Richard Sweren
Buzz Bovshow	Rose Gasner & Larry Chertoff	John Lynch	Lili Taylor
Blaise R. Box	Celia Gerard & Mark McGrath	Grace Lyu-Volckhausen	Lisa Tilney & Chris Lawrence
Becky Browder & Ted Neustadt	Christina Gerber	Julie & Alex Margolies	Merritt Tilney & Douglas Kaden
Carlton T. Brown	Freddie & Myrna Gershon	Ali Marsh	Lorraine Tobias & Alex Draper
Iris A. Brown & Joe White	Jenny Gersten & Willie Reale	Lin Manuel Miranda	Liz Tuccillo
Justin Brownhill	Alexandra Gersten-Vassilaros & John Vassilaros	Frances McDormand & Joel Coen	Laura Valeroso & David Seidman
Brian Byrnes	Scott Aaron Gewirtz & Laura Gewirtz	Emily & John Morgan	Wendy vanden Heuvel & Brad Coley
Shawn & Laura Byron	Elizabeth Giamatti	Amanda & Neal Moszkowski	Susan J. Vitucci
Joseph Capozzi	Robert Goldberg & Betsy MacIsaac	Suzen Murakoshi & Mark Temme	Mary Pat Walsh
Leah Carr	Stephen & Cathy Graham	Fred Nelson	Dr. Mildred Walton
Lawrence Catena	Jan Gura & Alan Pickman	Randy & Rona Nelson	Brenda Wehle & John C. Lynch
Chris Ceraso	Susan Hanson	Ruth Nelson	Carol Whitesides
Rachel Chanoff	Jessica Hecht & Adam Bernstein	Lori O'Connor	Zee Wiener
Todd Christie	Kathy & Jamie Herring	Carol Ochs & Bruce MacVittie	Ruth Ann Wynter
Damien Clancy	Peter Herdrich & Karen Trott	Jacki Ochs & Jan Kroeze	J.P. Xenakis
Matthew Clancy	William Holtzman & S. Sylvia Shepard	Kevin O'Rourke & Edith Thurber	Carole Yass
Katie Clark	Mary Horowitz	Jane Perlmutter & Greg MacPherson	Yildiz Yuksek & Richard Blackstone
Elizabeth Clemants		Elizabeth Peters	Connie & Marc Zand
David Cohen & Sandra Novak Cohen			
Larry Cohen			

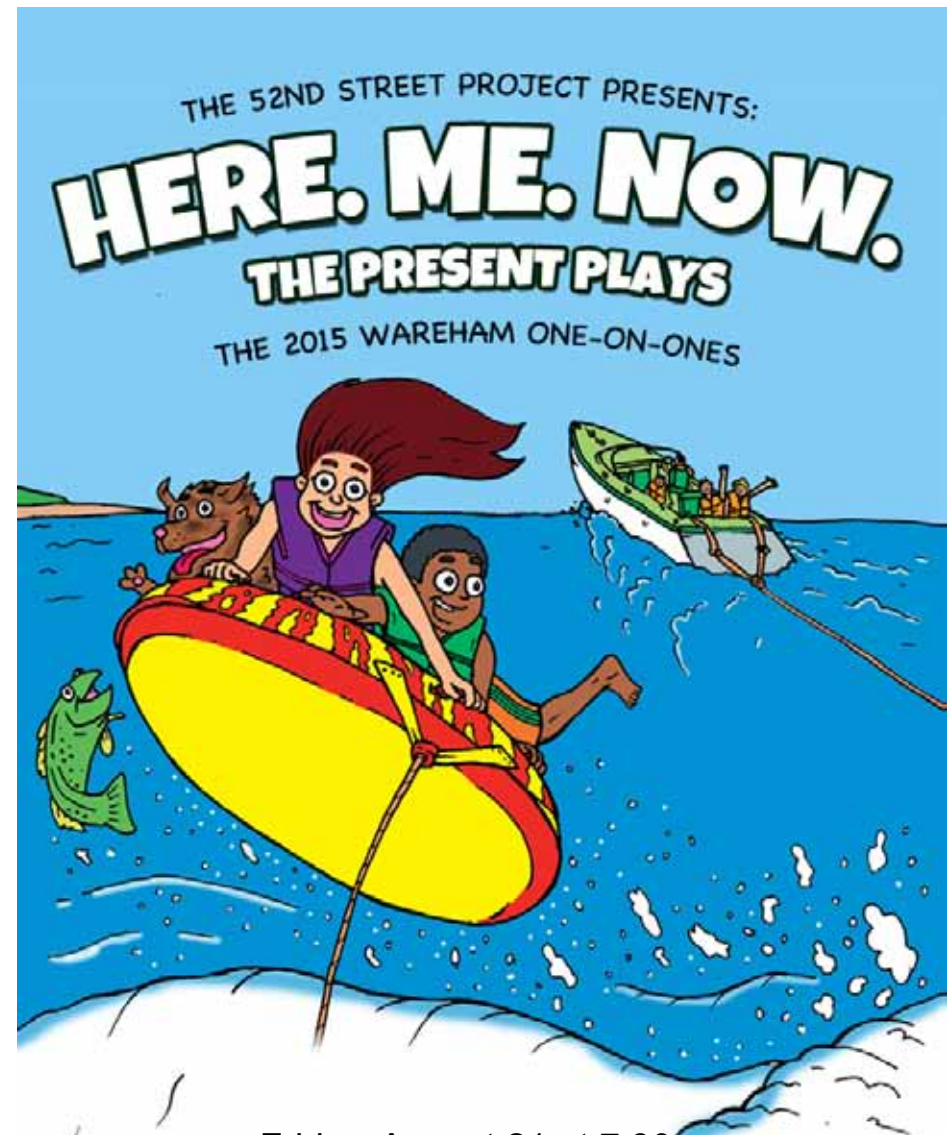

Friday, August 21 at 7:30  
 Saturday, August 22 at 7:30  
 Sunday, August 23 at 3:00

**THE 52ND STREET PROJECT'S  
 FIVE ANGELS THEATER**

# HERE. ME. NOW. THE PRESENT PLAYS

The 2015 Wareham, Mass. One-on-Ones - August 21-23 at the Five Angels Theater

## The 52nd Street Project Staff

Gus Rogerson, Artistic Director	Carol Ochs, Executive Director
Natalie Hirsch, Associate Artistic Director	John Sheehy, Dir. of Development & Marketing
Garrett Kim, Program Director	Laura Lane, Mgr. of Individual Giving
Liz Bell, Director of Education	George Babiak, Production Manager
Johanna Vidal*, Community Coordinator	Tim J. Lord, Technical Director
Jennifer Jimenez*, Day Receptionist	

*\*Alumnus of The 52nd Street Project*

### Consultants

Iris A. Brown, Graphic Designer; Chris Ceraso, Teen Dean

### Interns

Priscilla Diaz, Mitchell Harrison, Kira Newmark

### Teen Employees

Receptionists: Britney Trinidad, Chayse Peña, and Maria Martinez

Wareham Teen Counselor: Chamel Rodney

Ushers: Nick Carrero, Asia Rosado, Edison Sibri, Ashley Thomas, Mari Ulloa

## “HERE. ME. NOW.” Production Staff

### Composer/Music Director

Eric March

### Set Designer

Kevin Joseph Roach

### Lighting Designers

Chelsie McPhilimy and

Greg MacPherson

### Costume Designer

Sarah Swafford

### Sound Designer

Kira Newmark

### Stage Manager

Sam Barickman

### Projection Designs

George Babiak and The

52nd Street Project Projection Archive

### Prop Designs

George Babiak

### Backstage Crew

Michael Bannister,  
Wilhelmina Ohene Kari Kari,  
Chamel Rodney, Priscilla Diaz,  
Mitchell Harrison

### House Management

Carol Ochs, John Sheehy, Laura Lane

### Flyer/Program Art

Patrick Jones

### Chefs

John Sheehy and Liz Bell

## COOL STUFF ON SALE IN THE LOBBY!

Fabulous Flyer Bars..... \$2.50  
*and featuring Shel Silverstein's "Fivey and Twoey" logo:*  
 Project Hoodies..... \$30.00  
 Project Caps ..... \$20.00  
 Project T-shirts.....\$12.00/\$20.00  
 Project Mugs..... \$5.00  
 Project Notebook ..... \$5.00  
 Project Pencil 3-pack.....\$1.00

Thank you for coming to **HERE. ME. NOW.** If you are not on our mailing list, you can join on-line at [www.52project.org](http://www.52project.org). If you're interested in being a volunteer, fill out the form below and hand it to one of our staffers in the lobby.

### PLEASE PUT ME ON YOUR LIST:

08/15

NAME \_\_\_\_\_

ADDRESS \_\_\_\_\_

CITY \_\_\_\_\_

STATE \_\_\_\_\_

ZIP \_\_\_\_\_

HOME PHONE \_\_\_\_\_

DAYTIME OR MOBILE PHONE \_\_\_\_\_

E-MAIL ADDRESS \_\_\_\_\_

MY OCCUPATION \_\_\_\_\_

MY HOBBIES \_\_\_\_\_

WANT TO BE GREEN AND SAVE THE PROJECT MONEY ON POSTAGE?  
CHECK THIS BOX TO RECEIVE OUR NOTICES EXCLUSIVELY VIA E-MAIL.

### YES, I WOULD LIKE TO BE OF HELP. I CAN:

- |   |   |  |
|---|---|--|
| <input type="checkbox"/> Help load in and out for shows | <input type="checkbox"/> Draw and/or paint  | <input type="checkbox"/> Help kids with homework |
| <input type="checkbox"/> Hang lights                    | <input type="checkbox"/> Help with mailings | <input type="checkbox"/> Teach kids a skill      |
| <input type="checkbox"/> Work on a backstage crew       | <input type="checkbox"/> Do office work     | <input type="checkbox"/> Be a chef at an event   |
| <input type="checkbox"/> Do graphic design              | <input type="checkbox"/> Design sound       | <input type="checkbox"/> Design and sew costumes |
| <input type="checkbox"/> Other (please specify) _____   |   |  |

### MY SCHEDULE IS:

- Very flexible. I'm often available during weekdays.  
 Somewhat flexible. I can help on the occasional morning or afternoon during the week.  
 Not very flexible at all, but I've got some free time on evenings and weekends.

If you would like to mail this (and you're always welcome to enclose a tax-deductible contribution), you can send it to: The 52nd Street Project, 789 10th Avenue, New York, NY 10019. Or fax it to (212) 333-5598.



The One-on-One Program is made possible with public funds from The New York State Council on the Arts, a state agency, and the New York City Department of Cultural Affairs. The 52nd Street Project is a member of Art/NY and Theatre Communications Group (TCG), the national organization for the American theatre.

COMING TO OUR STAGE...



## THE COMPETITIVE PLAYS

### The 2015 Playback Show

The reverse of the One-on-One's!  
Kids write plays for themselves and an  
adult partner to perform together.

October 23-25 right here at  
**THE FIVE ANGELS THEATER**



### KEEP AN EYE OUT FOR INTERNS!

If you know of any college or graduate students who might enjoy working with us, playing with us, and going on trips with us for a semester, please have them contact Johanna Vidal. We are especially looking for interns for Spring 2016.

### The 52nd Street Project Board of Directors

Lisa Benavides	Frances McDormand
Rachel Chanoff	Noël Mihalow
Cathy Dantchik, co-chair	Carol Ochs
Carolyn DeSena	Willie Reale, founder
Wendy Ettinger, chair emeritus	Gus Rogerson
Louis P. Friedman, co-chair	Shirley Rumierk, alumni member
Alexandra Garrison	José Soto, Jr., alumni member
Alex Gersten-Vassilaros	Lisa Tilney
Robert Goldberg	Merritt Tilney
Stephen Graham, chair emeritus	Wendy vanden Heuvel
Valerie Kay	Mark Whatley

---

### What's Going On Here?

The 52nd Street Project is a non-profit organization that brings children from the Hell's Kitchen neighborhood together with professional theater artists to create original theater. **HERE. ME. NOW.** is a production of our One-on-One program, which is designed to give children the opportunity to go away for one-week stays in the country and enjoy the undivided attention of a professional theater artist who serves as friend, mentor, and collaborator.

---

### In-Kind Contributions

Abbeville Press; abc cocina; Alvin Ailey American Dance Theater; Richard Anthony; Lewis Black; Iris A. Brown Design; William Curran & A Curran Affair; Emmett Global; Evercore Partners; Edie Falco; Empanada Mama; Jenny Gersten & Friends of The High Line; Google; Jonathan Groff; ICI; John A. Vassilaros & Sons; Kahve; Karen Kowgios of Fried & Kowgios; Charlie Marshal & the Marshal Restaurant; Noël & Joe Mihalow; Neustar; Nonesuch Records; the Public Theater; Sesame Workshop; Wendy Stuhlberg; Tao Restaurant; Uber; Watkins, Inc.; and Paul, Weiss, Rifkind, Wharton & Garrison LLP.

---

### Special Thanks

Our Host Families- Peter, Helen & Christopher Randolph; Andrea & Emmanuel Daskalakis; Sam & Gerry Gray; Anne & Colin McNay, Joe McNay, Gray & Rosemary Watson, Ritu & Andrew Watson, Marina & Bob Whitman. Thank you also to Robin Morse; Lucy & Francis Rogerson; Kim D. Sherman; Vanessa Valdes; & Bob Krystofolski.



## HERE. ME. NOW. THE PRESENT PLAYS - ACT 1

All original music composed by Eric March, except where otherwise noted  
“Here, Me, Now” Theme Song lyrics by John Sheehy

### THE FIRST TO GO

Written by Cynthia Kaplan for Rebecca Gomez, age 11  
Directed by Alyssa Cartwright

Tanya ..... Rebecca Gomez  
Cathy ..... Alyssa Cartwright  
Stella ..... Priscilla Diaz  
Joachim ..... John Sheehy

“Dear Salad Bar” lyrics and music by Cynthia Kaplan

### DUENDE OR DEATH

Written by Kendell Pinkney for Ethan Zenteno, age 11  
Directed by Frankie J. Alvarez

Isandro “The Growler Bear” Garcia ..... Ethan Zenteno  
Jamie P. (Jorge Castillo) ..... Frankie J. Alvarez

“Duende or Death” lyrics by Kendell Pinkney

### MIDNIGHT TRAIN TO JERSEY

Written by Rachel Bonds for Darby O’Donnell, age 11  
Directed by Rachel Rusch

Martha Martina ..... Darby O’Donnell  
Liliana ..... Rachel Rusch

“What’s So Important in New Jersey?” lyrics by Rachel Bonds

### THE NEXT YOU CUBE STAR

Written and Directed by Charly Evon Simpson for Ginaija Hires Lauritzen, age 11

Lola ..... Ginaija Hires Lauritzen  
Carrie ..... Charly Evon Simpson  
Sarah ..... Johanna Vidal

“You’re YouCube Stars” lyrics by Charly Evon Simpson

### FAMILY GATHERING

Written and Directed by George Babiak for Daniel Tineo, age 11

Don Pasquale Badami ..... Daniel Tineo  
Jimmy “Two Cookies” Castelli ..... George Babiak  
Luigi ..... Chanel Rodney  
Angelina ..... Priscilla Diaz

“Family Comes First” lyrics by George Babiak

## HERE. ME. NOW. THE PRESENT PLAYS - ACT 2

### BROADCAST AWAYS

Written and Directed by Dylan Dawson for Sevan Ascencio, age 12

Chuck Starling ..... Sevan Ascencio  
Jim Flintoff ..... Dylan Dawson  
Island Monster/Announcer ..... John Sheehy

“Try a Flare” lyrics by Dylan Dawson

### THE BIGGEST FAN

Written by Erica Saleh for Nicole Quiles, age 11  
Directed by Emma Ramos

Cassie ..... Nicole Quiles  
Megan ..... Emma Ramos

“Shame On You/Sunshine” lyrics by Erica Saleh

### SUPERTIME!

Written and Directed by Garrett Kim for Aramis Jimenez, age 11

Clockstar ..... Aramis Jimenez  
Extremely Persuasive Man ..... Garrett Kim  
Mediocre Birthday Party DJ Guy ..... Chanel Rodney  
Mom ..... Priscilla Diaz

“Save the Day” lyrics by Garrett Kim

### THIS IS NOT A TEST

Written by Jedidiah Clarke\* for Sebastian Lopez, age 11  
Directed by Jude Sandy

Mike ..... Sebastian Lopez  
ACE ..... Jude Sandy  
Milkman ..... Chanel Rodney

“Food Prep” and “Quad Rainbow” lyrics by Jedidiah Clarke

### WONDERS OF THE WORLD

Written and Directed by Molly Coogan for Magalis Fabian, age 11

Tina ..... Magalis Fabian  
Gina ..... Molly Coogan  
Museum President ..... Mitchell Harrison  
Painting ..... Priscilla Diaz

“On the Inside” and “Free Guac” lyrics by Molly Coogan

The 52nd Street Project gratefully acknowledges the support of the following foundations and corporations: Brenner Family Foundation; Cantor Fitzgerald; Bull's Head Foundation; Carnegie Corporation of New York; CBS Foundation; City Winery; Common Sense Fund; Consolidated Edison; Dawkins Family Foundation; The Neil V. DeSena Foundation; Dramatists Guild Fund; Dubin Foundation; Educational Foundation of America; Evercore Partners; Harkness Foundation; HBO; Horace W. Goldsmith Foundation; Howard Gilman Foundation; I. Weiss; Jean & Louis Dreyfus Foundation; Kirkland & Ellis Foundation; Liquid Holdings Group; Ann M. Martin Foundation; Marusi Family Foundation; Newman's Own; Ninth Avenue Association; PAR Group; Parsons Family Foundation; Pinkerton Foundation; Rockefeller Foundation; The Shubert Organization; Slate Path Capital; Harold & Mimi Steinberg Charitable Trust; Surdna Foundation; Susquehanna Foundation; Tax Pro Financial Network; Tiger Baron Foundation; United Talent Agency; Yorke Construction Corp; ZenithOptimedia. (List current as of 7/11/14)

Robert Abrams	Penelope Collins	Sarah Horowitz	Sue Phillips
& Cynthia Vance	Judith-Ann Corrente	& David Venarde	Todd Poisson
George Ackert	Janet Coviello	Andrea Johnson	Suzanne Poulin
Michael Alicastro	William Crudup	Beth Ifcher	Helaine & Michael Pruzan
Elton Andrews	Kyle Czepiel	Carine Joannou	Christopher Randolph
Richard Anthony	Arthur Dantchik	Kristen Johanson	Helen & Peter Randolph
Cecilia Arana	Cathy Dantchik	Andrea Johnson	Jacquelyn Reingold
Emily Armstrong	Leslie Dantchik	Cindy Kaplan & David Froelich	Anita A. Rogerson
James Armstrong	Peter & Judith Dawkins	Valerie Kay & Bruce Graham	David Ross & Laura Ross
Dominick & Ilene Balletta	Carolyn & Neil DeSena	Louise Klebanoff	Dr. Steve Rudin
Becky Ann & Dylan Baker	Rebecca & Richard Dresser	Henry Krieger & Robert Joy	Laura Sametz & Anton Fig
Ken Bantum	Peter Doyle	Jacki Ochs & Jan Kroeze	Karin & Thomas Schall
Carolyn Bechtel	Max Dyksterhouse	Judy Kuhn & David Schwab	Maurly Schott
Lisa Benavides	& David Roady	Frances & Fred Langbecker	Susan Schroeder
& Tim Blake Nelson	Doug Eisenberg	Gabrielle Lansner	& Britt Adams
Louisa Benton	Lynn Ellenberg	& Dean Taucher	Whitney Scott
Gavin Berger	Nora Ephron	Brian Lapin	& Peter Jacobson
& Craig Berggren	& Nicholas Pileggi	Michael Lawrence	Meg Simon
Stephanie Berger & Paul King	Peter Jay Fernandez	& Glen Gillen	Christopher Solomon
Beth & Eric Berman	& Denise Burse Fernandez	Warren Leight & Karen Hauser	Jonathan Soros
David Beth	Liz Flahive & Jeff Cox	Mickey Lemle	& Jennifer Soros
Lewis Black	Wendy Flanagan	Jonathan Levine	Jenny & Jon Steingart
Emily Blavatnik	& Chris O'Malley	Helen Levy	Tracy Straus
Allison Blinken	Karen & Paul Freitas	Melissa Liebling-Goldberg	Danny Strong
Noah Bogan	Sally Froelich	& John Barrett	Al Styron & Ed Beason
Jane Bolster	Alexandra Garrison	Kay M. Lim	Susanna Styron
& Steve Wertimer	Beverly Gasner	Adrienne Lobel	Richard Sweren
Buzz Bovshow	Rose Gasner & Larry Chertoff	John Lynch	Lili Taylor
Blaise R. Box	Celia Gerard & Mark McGrath	Grace Lyu-Volckhausen	Lisa Tilney & Chris Lawrence
Becky Browder	Christina Gerber	Julie & Alex Margolies	Merritt Tilney & Douglas Kaden
& Ted Neustadt	Freddie & Myrna Gershon	Ali Marsh	Lorraine Tobias & Alex Draper
Carlton T. Brown	Jenny Gersten & Willie Reale	Lin Manuel Miranda	Liz Tuccillo
Iris A. Brown & Joe White	Alexandra Gersten-Vassilaros	Frances McDormand	Laura Valeroso
Justin Brownhill	& John Vassilaros	& Joel Coen	& David Seidman
Brian Byrnes	Scott Aaron Gewirtz	Emily & John Morgan	Wendy vanden Heuvel
Shawn & Laura Byron	& Laura Gewirtz	Amanda & Neal Moszkowski	& Brad Coley
Joseph Capozzi	Elizabeth Giamatti	Suzen Murakoshi	Susan J. Vitucci
Leah Carr	Robert Goldberg	& Mark Temme	Mary Pat Walsh
Lawrence Catena	& Betsy MacIsaac	Fred Nelson	Dr. Mildred Walton
Chris Ceraso	Stephen & Cathy Graham	Randy & Rona Nelson	Brenda Wehle & John C. Lynch
Rachel Chanoff	Jan Gura & Alan Pickman	Ruth Nelson	Carol Whitesides
Todd Christie	Susan Hanson	Lori O'Connor	Zee Wiener
Damien Clancy	Jessica Hecht	Carol Ochs & Bruce MacVittie	Ruth Ann Wynter
Matthew Clancy	& Adam Bernstein	Jacki Ochs & Jan Kroeze	J.P. Xenakis
Katie Clark	Kathy & Jamie Herring	Kevin O'Rourke	Carole Yass
Elizabeth Clemants	Peter Herdrich & Karen Trott	& Edith Thurber	Yildiz Yuksek
David Cohen	William Holtzman	Jane Perlmutter	& Richard Blackstone
& Sandra Novak Cohen	& S. Sylvia Shepard	& Greg MacPherson	Connie & Marc Zand
Larry Cohen	Mary Horowitz	Elizabeth Peters	

THE 52ND STREET PROJECT PRESENTS

# BE AGGRESSIVE!

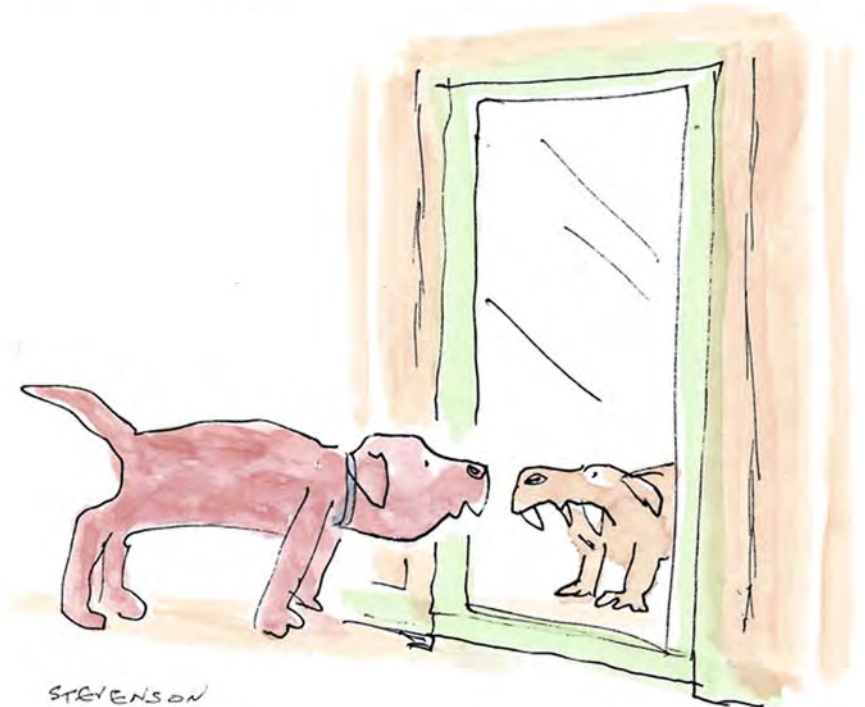

## THE COMPETITIVE PLAYS

THE 2015 PLAYBACK SHOWS

Friday, October 23 at 7:30 p.m.

Saturday, October 24 at 7:30 p.m.

Sunday, October 25 at 3:00 p.m.

# BE AGGRESSIVE: THE COMPETITIVE PLAYS

Playback 2015 - Oct. 23-25, Five Angels Theater

## The 52nd Street Project Staff

Gus Rogerson, Artistic Director  
Natalie Hirsch, Associate Artistic Director  
Garrett Kim, Program Director  
George Babiak, Production Manager  
Tim J. Lord, Technical Director

Carol Ochs, Executive Director  
Melissa Gundling, Dev. & Mgmt. Associate  
John Sheehy, Dir. of Development & Marketing  
Laura Lane, Mgr. of Individual Giving

Liz Bell, Director of Education  
Johanna Vidal\*, Community Coordinator  
Jennifer Jimenez\*, Day Receptionist

*\*Alumnae of The 52nd Street Project*

### Consultants:

Iris A. Brown, Graphic Designer; Chris Ceraso, Teen Dean

### Interns:

Jose Gamon, Corey Ruzicano, Tory Delahunt

### Teen Employees:

Receptionists: Maria Martinez, Chayse Peña, Britney Trinidad

Playback Teen Counselor: Martin Sanchez

Ushers: Lincoln Bernard, Richard Brea, Melody Cruz, Britney Trinidad

## "Be Aggressive" Production Staff

### Composer/Music Director

Freddy Hall

### Set Designer

Kevin Joseph Roach

### Lighting Designer

Greg MacPherson

### Costume Designer

Lara De Bruijn

### Sound Designer

Tory Delahunt

### Stage Manager

Kaleigh Bernier

### Projection Designs

George Babiak & the  
Project Projection Archive

### Prop Designs

George Babiak

### Backstage Crew

Jose Gamon, Corey Ruzicano,  
Martin Sanchez, Christin Tetteh

### Show Photographer

Winston Rodney

### Weekend-Away Chefs

Liz Bell, John Sheehy

### Bridgehampton Hosts

The Gersten-Vassilaros Family,  
Cathy Dantchik,

Louis and Patrice Friedman

### Flyer and Program Art

James Stevenson



The Playback Program is made possible with public funds from The New York State Council on the Arts, a state agency, and the New York City Department of Cultural Affairs. The 52nd Street Project is a member of Art/NY and Theatre Communications Group (TCG), the national organization for the American theatre.

## COOL STUFF ON SALE IN THE LOBBY!

Fabulous Flyer Bars..... \$2.50  
*and featuring Shel Silverstein's "Fivey and Twoey" logo:*  
Project Hoodies..... \$30.00  
Project Caps..... \$20.00  
Project T-shirts..... \$12.00/\$20.00  
Project Mugs..... \$5.00  
Project Notebook..... \$5.00  
Project Pencil 3-pack..... \$1.00

Thank you for coming to **BE AGGRESSIVE**. If you are not on our mailing list, you can join on-line at [www.52project.org](http://www.52project.org). If you're interested in being a volunteer, fill out the form below and hand it to one of our staffers in the lobby.

### PLEASE PUT ME ON YOUR LIST:

10/15

NAME \_\_\_\_\_

ADDRESS \_\_\_\_\_

CITY \_\_\_\_\_

STATE \_\_\_\_\_

ZIP \_\_\_\_\_

HOME PHONE \_\_\_\_\_

DAYTIME OR MOBILE PHONE \_\_\_\_\_

E-MAIL ADDRESS \_\_\_\_\_

MY OCCUPATION \_\_\_\_\_

MY HOBBIES \_\_\_\_\_

WANT TO BE GREEN AND SAVE THE PROJECT MONEY ON POSTAGE?  
CHECK THIS BOX TO RECEIVE OUR NOTICES EXCLUSIVELY VIA E-MAIL.

### YES, I WOULD LIKE TO BE OF HELP. I CAN:

- |   |   |  |
|---|---|--|
| <input type="checkbox"/> Help load in and out for shows | <input type="checkbox"/> Draw and/or paint  | <input type="checkbox"/> Help kids with homework |
| <input type="checkbox"/> Hang lights                    | <input type="checkbox"/> Help with mailings | <input type="checkbox"/> Teach kids a skill      |
| <input type="checkbox"/> Work on a backstage crew       | <input type="checkbox"/> Do office work     | <input type="checkbox"/> Be a chef at an event   |
| <input type="checkbox"/> Do graphic design              | <input type="checkbox"/> Design sound       | <input type="checkbox"/> Design and sew costumes |
| <input type="checkbox"/> Other (please specify) _____   |   |  |

### MY SCHEDULE IS:

- Very flexible. I'm often available during weekdays.  
 Somewhat flexible. I can help on the occasional morning or afternoon during the week.  
 Not very flexible at all, but I've got some free time on evenings and weekends.

If you would like to mail this (and you're always welcome to enclose a tax-deductible contribution), you can send it to: The 52nd Street Project, 789 10th Avenue, New York, NY 10019. Or fax it to (212) 333-5598.

COMING UP SOON AT THE PROJECT!

THE 3RD ANNUAL  
**BIG KIDS BASH**

A HALLOWEEN CELEBRATION  
TUESDAY, OCTOBER 27, 2015  
7:00-10:00 P.M.



**THE ELECTRIC ROOM AT DREAM DOWNTOWN**  
**355 WEST 16TH ST. BETWEEN 8TH AND 9TH AVE.**

Drink, snack, and socialize for a great cause.  
\$125 until Oct. 26, \$150 on Oct. 27.

**LARGER THAN**



**THE SUPERSIZED PLAYS**

THE FALL 2015 PLAYMAKING PROGRAM

10 brand-new kids write plays for adult actors to perform.

December 11-13 at the Five Angels

**The 52nd Street Project  
Board of Directors**

Lisa Benavides	Frances McDormand
Rachel Chanoff	Noël Mihalow
Cathy Dantchik, co-chair	Carol Ochs
Carolyn DeSena	Willie Reale, founder
Wendy Ettinger, chair emeritus	Gus Rogerson
Louis P. Friedman, co-chair	Shirley Rumierk, alumni member
Alexandra Garrison	José Soto, Jr., alumni member
Alex Gersten-Vassilaros	Merritt Tilney
Robert Goldberg	Wendy vanden Heuvel
Stephen Graham, chair emeritus	Mark Whatley
Valerie Kay	

---

**What's Going On Here?**

The 52nd Street Project is a non-profit organization that brings children from the Hell's Kitchen neighborhood together with professional theater artists to create original theater. *BE AGGRESSIVE* is a production of our Playback program, in which kid actor/playwrights write plays for themselves and adult actor/director partners. Everyone ventured to the Hamptons for a rehearsal retreat over the Columbus Day weekend. All of the kids involved are veterans of the Playmaking classes which were adapted for the Project by Daniel Judah Sklar from his book *Playmaking: Children Writing and Performing Their Own Plays*.

---

**In-Kind Contributions**

Abbeville Press; abc cocina; Alvin Ailey American Dance Theater; Richard Anthony; Lewis Black; Iris A. Brown Design; William Curran & A Curran Affair; Emmett Global; Evercore Partners; Edie Falco; Empanada Mama; Jenny Gersten & Friends of The High Line; Google; Jonathan Groff; ICI; John A. Vassilaros & Sons; Kahve; Karen Kowgios of Fried & Kowgios; Charlie Marshal & the Marshal Restaurant; Noël & Joe Mihalow; Neustar; Nonesuch Records; the Public Theater; Sesame Workshop; Wendy Stuhlberg; Tao Restaurant; Uber; Watkins, Inc.; and Paul, Weiss, Rifkind, Wharton & Garrison LLP.

---

**Special Thanks**

We're extremely grateful to board member Alex Gersten-Vassilaros for allowing us to use her family's home as our headquarters on our rehearsal trip to the Hamptons. Huge thanks also go to Board Co-Chair Louis Friedman and his wife Patrice Friedman for hosting some adults, and to our other Co-Chair, Cathy Dantchik, who hosted our girls and even more adults at her beautiful new house in Bridgehampton.

# BE AGGRESSIVE - ACT 1

All original music composed by Freddy Hall

## WRISTWATCHES AND FAMILY TRAGEDIES

Written by Karen Tineo, age 13

Director/Dramaturge: Ka-Ling Cheung

Tia the Turtle.....Karen Tineo

Jim the Jaguar.....Ka-Ling Cheung

Announcer.....Jose Gamo

Watch Salesman.....Martin Sanchez

*What Have I Done?* lyrics by Karen Tineo

## BLOODSHED AND TEARS

Written by David Ortiz, age 13

Director/Dramaturge: Charlie O'Rourke

Pen.....David Ortiz

Bill.....Charlie O'Rourke

Bill's Friends and Family.....The Crew

*That Man/Boy is Crazy* lyrics by David Ortiz

## ARDEN AND TABATHA

Written by Chyanne Peña, age 13

Director/Dramaturge: Ashley Marie Ortiz

Tabatha.....Chyanne Peña

Arden.....Ashley Marie Ortiz

Divemaster.....Jose Gamo

*Home* lyrics by Chyanne Peña

## PAID OFF

Written by Ezekiel Albarron, age 13

Director/Dramaturge: Jeremy Rishe

Huskey.....Ezekiel Albarron

San Antonio.....Jeremy Rishe

Teller.....Corey Ruzicano

Disgruntled Customer.....George Babiak

Customer #2.....Jose Gamo

SWAT Team.....Christin Tetteh, Martin Sanchez, Jose Gamo

*Get Money* lyrics by Ezekiel Albarron

# BE AGGRESSIVE - ACT 2

## OBLIVIOUS FRENEMIES

Written by Ricardo Currin, age 13

Director/Dramaturge: Stephen O'Reilly

James/Detecto.....Ricardo Currin

Ivon/Metal Man.....Stephen O'Reilly

News Reporter/John Reet.....Jose Gamo

*No Heroes in This World* and *The Birth of Detecto* lyrics by Ricardo Currin

## MONKEY DISASTER

Written by Tiffany Miller, age 14

Director/Dramaturge: Corey Ruzicano

Bri.....Tiffany Miller

Coco.....Corey Ruzicano

Monkeys.....The Crew

*I Hate You* lyrics by Tiffany Miller

## WHAT MAKES THE TWO OF US

Written by Joshua Gomez, age 13

Director/Dramaturge: Rodney Richardson

John.....Joshua Gomez

Scott.....Rodney Richardson

*Paychecks and Medicine* lyrics by Joshua Gomez



The 52nd Street Project gratefully acknowledges the support of the following foundations and corporations: Brenner Family Foundation; Cantor Fitzgerald; Bull's Head Foundation; Carnegie Corporation of New York; CBS Foundation; City Winery; Common Sense Fund; Consolidated Edison; Dawkins Family Foundation; The Neil V. DeSena Foundation; Dramatists Guild Fund; Dubin Foundation; Educational Foundation of America; Evercore Partners; Harkness Foundation; HBO; Horace W. Goldsmith Foundation; Howard Gilman Foundation; I. Weiss; Jean & Louis Dreyfus Foundation; Kirkland & Ellis Foundation; Liquid Holdings Group; Ann M. Martin Foundation; Marusi Family Foundation; Newman's Own; Ninth Avenue Association; PAR Group; Parsons Family Foundation; Pinkerton Foundation; Rockefeller Foundation; The Shubert Organization; Slate Path Capital; Harold & Mimi Steinberg Charitable Trust; Surdna Foundation; Susquehanna Foundation; Tax Pro Financial Network; Tiger Baron Foundation; United Talent Agency; Yorke Construction Corp; ZenithOptimedia. (List current as of 7/1/14)

Robert Abrams & Cynthia Vance	Penelope Collins Judith-Ann Corrente	Sarah Horowitz & David Venarde	Sue Phillips Todd Poisson
George Ackert	Janet Coviello	Andrea Johnson	Suzanne Poulin
Michael Alicastro	William Crudup	Beth Ifcher	Helaine & Michael Pruzan
Elton Andrews	Kyle Czepiel	Carine Joannou	Christopher Randolph
Richard Anthony	Arthur Dantchik	Kristen Johanson	Helen & Peter Randolph
Cecilia Arana	Cathy Dantchik	Andrea Johnson	Jacquelyn Reingold
Emily Armstrong	Leslie Dantchik	Cindy Kaplan & David Froelich	Anita A. Rogerson
James Armstrong	Peter & Judith Dawkins	Valerie Kay & Bruce Graham	David Ross & Laura Ross
Dominick & Ilene Balletta	Carolyn & Neil DeSena	Louise Klebanoff	Dr. Steve Rudin
Becky Ann & Dylan Baker	Rebecca & Richard Dresser	Henry Krieger & Robert Joy	Laura Sametz & Anton Fig
Ken Bantum	Peter Doyle	Jacki Ochs & Jan Kroeze	Karin & Thomas Schall
Carolyn Bechtel	Max Dyksterhouse	Judy Kuhn & David Schwab	Maury Schott
Lisa Benavides	& David Roady	Frances & Fred Langbecker	Susan Schroeder
& Tim Blake Nelson	Doug Eisenberg	Gabrielle Lansner	& Britt Adams
Louisa Benton	Lynn Ellenberg	& Dean Taucher	Whitney Scott
Gavin Berger	Nora Ephron	Brian Lapin	& Peter Jacobson
& Craig Berggren	& Nicholas Pileggi	Michael Lawrence	Meg Simon
Stephanie Berger & Paul King	Peter Jay Fernandez	& Glen Gillen	Christopher Solomon
Beth & Eric Berman	& Denise Burse Fernandez	Warren Leight & Karen Hauser	Jonathan Soros
David Beth	Liz Flahive & Jeff Cox	Mickey Lemle	& Jennifer Soros
Lewis Black	Wendy Flanagan	Jonathan Levine	Jenny & Jon Steingart
Emily Blavatnik	& Chris O'Malley	Helen Levy	Tracy Straus
Allison Blinken	Karen & Paul Freitas	Melissa Liebling-Goldberg	Danny Strong
Noah Bogan	Sally Froelich	& John Barrett	Al Styron & Ed Beason
Jane Bolster	Alexandra Garrison	Kay M. Lim	Susanna Styrone
& Steve Wertimer	Beverly Gasner	Adrienne Lobel	Richard Sweren
Buzz Bovshow	Rose Gasner & Larry Chertoff	John Lynch	Lili Taylor
Blaise R. Box	Celia Gerard & Mark McGrath	Grace Lyu-Volckhausen	Lisa Tilney & Chris Lawrence
Becky Browder	Christina Gerber	Julie & Alex Margolies	Merritt Tilney & Douglas Kaden
& Ted Neustadt	Freddie & Myrna Gershon	Ali Marsh	Lorraine Tobias & Alex Draper
Carlton T. Brown	Jenny Gersten & Willie Reale	Lin Manuel Miranda	Liz Tuccillo
Iris A. Brown & Joe White	Alexandra Gersten-Vassilaros	Frances McDormand	Laura Valeroso
Justin Brownhill	& John Vassilaros	& Joel Coen	& David Seidman
Brian Byrnes	Scott Aaron Gewirtz	Emily & John Morgan	Wendy vanden Heuvel
Shawn & Laura Byron	& Laura Gewirtz	Amanda & Neal Moszkowski	& Brad Coley
Joseph Capozzi	Elizabeth Giamatti	Suzen Murakoshi	Susan J. Vitucci
Leah Carr	Robert Goldberg	& Mark Temme	Mary Pat Walsh
Lawrence Catena	& Betsy MacIsaac	Fred Nelson	Dr. Mildred Walton
Chris Ceraso	Stephen & Cathy Graham	Randy & Rona Nelson	Brenda Wehle & John C. Lynch
Rachel Chanoff	Jan Gura & Alan Pickman	Ruth Nelson	Carol Whitesides
Todd Christie	Susan Hanson	Lori O'Connor	Zee Wiener
Damien Clancy	Jessica Hecht	Carol Ochs & Bruce MacVittie	Ruth Ann Wynter
Matthew Clancy	& Adam Bernstein	Jacki Ochs & Jan Kroeze	J.P. Xenakis
Katie Clark	Kathy & Jamie Herring	Kevin O'Rourke	Carole Yass
Elizabeth Clemants	Peter Herdrich & Karen Trott	& Edith Thurber	Yildiz Yuksek
David Cohen	William Holtzman	Jane Perlmutter	& Richard Blackstone
& Sandra Novak Cohen	& S. Sylvia Shepard	& Greg MacPherson	Connie & Marc Zand
Larry Cohen	Mary Horowitz	Elizabeth Peters	



IRIS A. BROWN

9 NEW PLAYS WRITTEN BY KIDS AND PERFORMED BY ADULT ACTORS

FRIDAY, DEC. 11 AT 7:30 P.M.

SATURDAY, DEC. 12 AT 3:00 & 7:30 P.M.

SUNDAY, DEC. 13 AT 3:00 P.M.

THE FIVE ANGELS THEATER

# LARGER THAN LIFE: THE SUPERSIZED PLAYS

Fall Playmaking 2015 - Dec. 11-13, Five Angels Theater

## The 52nd Street Project Staff

Gus Rogerson, Artistic Director	Carol Ochs, Executive Director
Natalie Hirsch, Associate Artistic Director	Melissa Gundling, Dev. & Mgmt. Associate
Garrett Kim, Program Director	John Sheehy, Dir. of Development & Marketing
George Babiak, Production Manager	Laura Lane, Mgr. of Individual Giving
Tim J. Lord, Technical Director	
Liz Bell, Director of Education	
Johanna Vidal*, Community Coordinator	
Jennifer Jimenez*, Day Receptionist	

*\*Alumnae of The 52nd Street Project*

### Consultants:

Iris A. Brown, Graphic Designer; Chris Ceraso, Teen Dean

### Interns:

Jose Gamo, Corey Ruzicano, Tory Delahunt

### Teen Employees:

Receptionists: Maria Martinez, Chayse Peña, Britney Trinidad

Playmaking Teen Counselor: Maria Martinez

Ushers: Eric Carrero, Christin Tetteh, Martin Sanchez, and Daniel Martinez

## "Larger Than Life" Production Staff

### Composer/Music Director

Avi Amon

### Set Designer

Kevin Joseph Roach

### Lighting Designer

Collin Bradley

### Costume Designer

Carisa Kelly

### Sound Designers

Toby Algya and Sam Barickman

### Stage Manager

Kaleigh Bernier

### Projection Designs

George Babiak and the Project's Projection Archive

### Prop Designs

George Babiak

### Backstage Crew

Jose Gamo, Corey Ruzicano,  
Tory Delahunt, Jasmine Correa,  
Ashley Thomas

### Show Photographer

Winston Rodney

### Weekend-Away Chefs

Iris A. Brown, Joe White,  
Walker White, Liz Bell, Carol Ochs

### Playmaking Class Volunteers

Jose-Maria Aguila, Jonathan Bock,  
Jeremy Fisher, Nancy Giles,  
Arielle Goldman, Susan Goodwillie,  
Eliza Huberth, Kiersten Zimmerman

### Playmaking Class Teen Assistant

Maria Martinez

### Flyer and Program Art

Iris A. Brown

## COOL STUFF ON SALE IN THE LOBBY!

Fabulous Flyer Bars..... \$2.50

*and featuring Shel Silverstein's "Fivey and Twoey" logo:*

Project Hoodies..... \$30.00

Project Caps..... \$20.00

Project T-shirts..... \$12.00/\$20.00

Project Mugs..... \$5.00

Project Notebook..... \$5.00

Project Pencil 3-pack..... \$1.00

Thank you for coming to **LARGER THAN LIFE**. If you are not on our mailing list, you can join on-line at [www.52project.org](http://www.52project.org). If you're interested in being a volunteer, fill out the form below and hand it to one of our staffers in the lobby.

### PLEASE PUT ME ON YOUR LIST:

12/15

NAME \_\_\_\_\_

ADDRESS \_\_\_\_\_

CITY \_\_\_\_\_

STATE \_\_\_\_\_

ZIP \_\_\_\_\_

HOME PHONE \_\_\_\_\_

DAYTIME OR MOBILE PHONE \_\_\_\_\_

E-MAIL ADDRESS \_\_\_\_\_

MY OCCUPATION \_\_\_\_\_

MY HOBBIES \_\_\_\_\_

WANT TO BE GREEN AND SAVE THE PROJECT MONEY ON POSTAGE?  
CHECK THIS BOX TO RECEIVE OUR NOTICES EXCLUSIVELY VIA E-MAIL.

### YES, I WOULD LIKE TO BE OF HELP. I CAN:

- |   |   |  |
|---|---|--|
| <input type="checkbox"/> Help load in and out for shows | <input type="checkbox"/> Draw and/or paint  | <input type="checkbox"/> Help kids with homework |
| <input type="checkbox"/> Hang lights                    | <input type="checkbox"/> Help with mailings | <input type="checkbox"/> Teach kids a skill      |
| <input type="checkbox"/> Work on a backstage crew       | <input type="checkbox"/> Do office work     | <input type="checkbox"/> Be a chef at an event   |
| <input type="checkbox"/> Do graphic design              | <input type="checkbox"/> Design sound       | <input type="checkbox"/> Design and sew costumes |
| <input type="checkbox"/> Other (please specify) _____   |   |  |

### MY SCHEDULE IS:

- Very flexible. I'm often available during weekdays.
- Somewhat flexible. I can help on the occasional morning or afternoon during the week.
- Not very flexible at all, but I've got some free time on evenings and weekends.

If you would like to mail this (and you're always welcome to enclose a tax-deductible contribution), you can send it to: The 52nd Street Project, 789 10th Avenue, New York, NY 10019. Or fax it to (212) 333-5598.



The Playmaking Program is made possible with public funds from The New York State Council on the Arts, a state agency, and the New York City Department of Cultural Affairs. The 52nd Street Project is a member of Art/NY and Theatre Communications Group (TCG), the national organization for the American theatre.

COMING UP NEXT!

GUS ROGERSON, ARTISTIC DIRECTOR CAROL OCHS, EXECUTIVE DIRECTOR

THE 52ND STREET PROJECT PRESENTS

# THE NICK OF TIME

## THE PUNCTUAL PLAYS

THE 2016 TWO-ON-TWOS

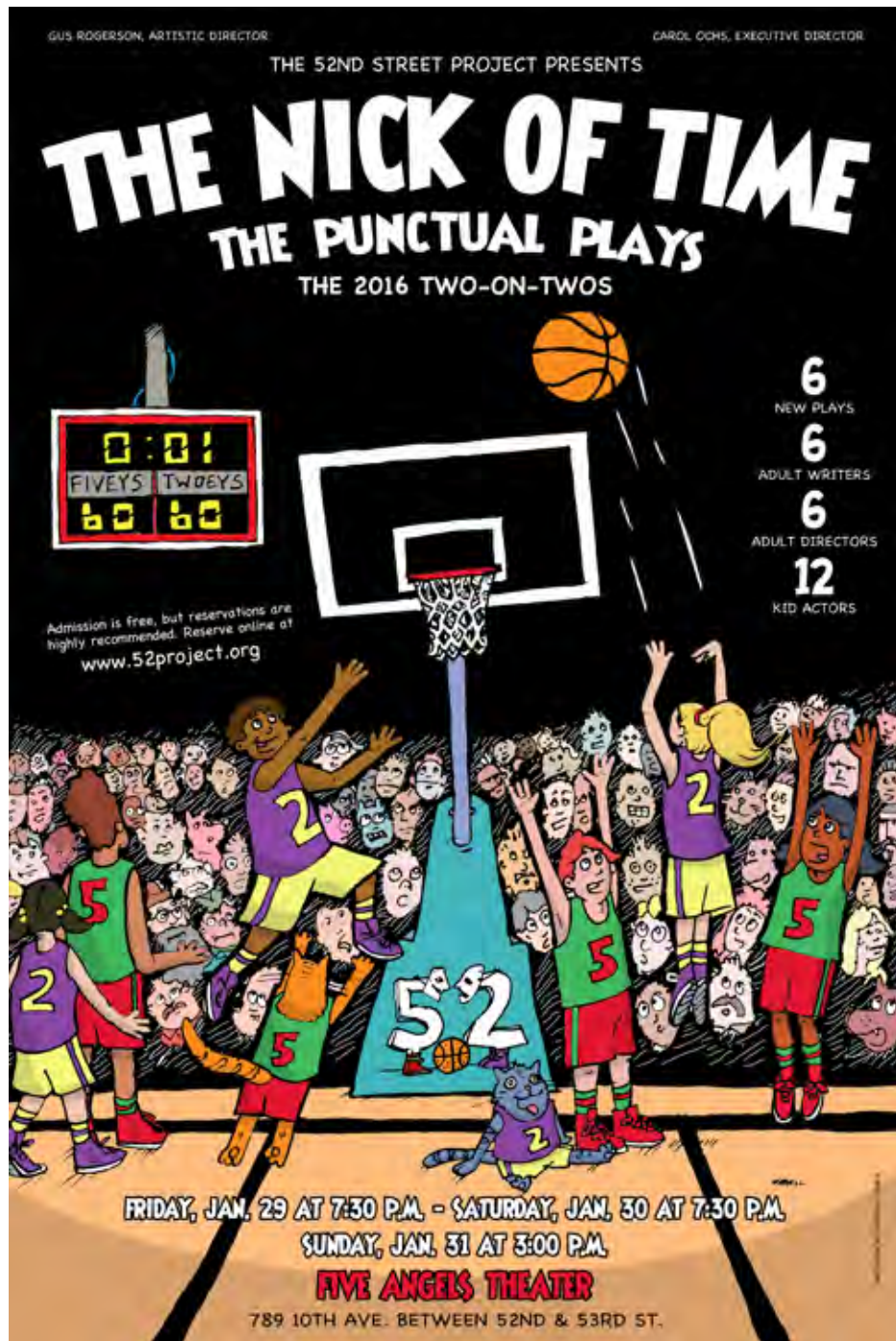

Admission is free, but reservations are highly recommended. Reserve online at [www.52project.org](http://www.52project.org)

6  
NEW PLAYS

6  
ADULT WRITERS

6  
ADULT DIRECTORS

12  
KID ACTORS

FRIDAY, JAN. 29 AT 7:30 P.M. - SATURDAY, JAN. 30 AT 7:30 P.M.  
SUNDAY, JAN. 31 AT 3:00 P.M.

**FIVE ANGELS THEATER**  
789 10TH AVE. BETWEEN 52ND & 53RD ST.

### The 52nd Street Project Board of Directors

Lisa Benavides	Frances McDormand
Rachel Chanoff	Noël Mihalow
Cathy Dantchik, co-chair	Carol Ochs
Carolyn DeSena	Willie Reale, founder
Wendy Ettinger, chair emeritus	Gus Rogerson
Louis P. Friedman, co-chair	Shirley Rumierk, alumni member
Alexandra Garrison	José Soto, Jr., alumni member
Alex Gersten-Vassilaros	Merritt Tilney
Robert Goldberg	Wendy vanden Heuvel
Stephen Graham, chair emeritus	Mark Whatley
Valerie Kay	

### What's Going On Here?

The 52nd Street Project is a non-profit organization that brings children from the Hell's Kitchen neighborhood together with professional theater artists to create original theater. *LARGER THAN LIFE* is a production of our Playmaking program. Young people participate in a nine-week playwriting course taught by Natalie Hirsch and adapted for the Project by Daniel Judah Sklar from his book *Playmaking: Children Writing and Performing Their Own Plays*. At the end of the course, each child is matched with two actors and a dramaturg/director who guides him or her through the writing of a play during a weekend retreat in the country (Stone Ridge, NY, for this show). This performance is the end result.

### In-Kind Contributions

Abbeville Press; abc cocina; Alvin Ailey American Dance Theater; Richard Anthony; Lewis Black; Iris A. Brown Design; William Curran & A Curran Affair; Emmett Global; Evercore Partners; Edie Falco; Empanada Mama; Jenny Gersten & Friends of The High Line; Google; Jonathan Groff; ICI; John A. Vassilaros & Sons; Kahve; Karen Kowgios of Fried & Kowgios; Charlie Marshal & the Marshal Restaurant; Noël & Joe Mihalow; Neustar; Nonesuch Records; the Public Theater; Sesame Workshop; Wendy Stuhlberg; Tao Restaurant; Uber; Watkins, Inc.; and Paul, Weiss, Rifkind, Wharton & Garrison LLP.

### Special Thanks

We're extremely thankful to Steve Gorn & Barbara Bash for the use of their beautiful home in Stone Ridge, NY as our base of operations for the writer's retreat weekend. We must also express thanks to Anita Flanagan, Deborah Freedman & Bill Woods, David Curtis & Ann Morris, Debbie Wierum & Steve Ramsey, and Nicole & Paul Quinn for housing our kids. We are equally grateful to Charlie and Naomi Miles, Jeff Madalena & Jason Gnewikow, and Lethe & Jaques Black for housing our adults. Last, but not least, thanks to Iris Brown, Joe White & Walker White for being our Stone Ridge liaisons and making the amazing food!



# LARGER THAN LIFE: ACT 1

All original music composed by Avi Amon

## GENNY AND MARK

Written by Bryanna Ohene Kari Kari, age 11

Director/Dramaturge: Alexandra O'Daly

Genny ..... Edie Falco

Mark ..... Frank Wood

Maids ..... Corey Ruzicano & Tory Delahunt

Chloe ..... John Sheehy

Zoey ..... Johanna Vidal

*My Stupid Work* lyrics by Bryanna Ohene Kari Kari.

## THE BAD AND THE GOOD

Written by Leonel Perez, age 11

Director/Dramaturge: Korey Jackson

Eble ..... Carl Hendrick Louis

Moonlight ..... Jonathan Bock

Bob ..... Jose Gamo

*Oh, Why* lyrics by Leonel Perez.

## THE WINGS AND THE D.J.?

Written by Beyonce Thomas, age 11

Director/Dramaturge: Chelsea Hackett

Jenny ..... Arielle Goldman

Bob ..... Bhavesh Patel

Fairies ..... Corey Ruzicano & Tory Delahunt

Mom ..... Natalie Hirsch

*Yes!* lyrics by Beyonce Thomas

Special thanks and best wishes to Jeannine Serralles.

## PEANUT BUTTER AND PHONES

Written by Gage Simmons, age 10

Director/Dramaturge: Kareem Lucas

Peanut Butter ..... Bjorn DuPaty

Virus Free 3000 ..... Joe Tapper

## THE UNFOUND BLANKY

Written by Lauren Amador-Cruz, age 11

Director: Sarah Krohn Dramaturge: Garrett Kim

Roary ..... Lisa Benavides-Nelson

Foxy ..... Sofiya Akilova

Birds ..... Jose Gamo, Tory Delahunt, Ashley Thomas

Mother of Snakes ..... George Babiak

*Our Goal* and *Ending* lyrics by Lauren Amador-Cruz.

# LARGER THAN LIFE: ACT 2

## THE INTERNET IS IN YOUR MIND

Written by Lily Kuzminski, age 11

Dramaturge/Director: Rebecca Martinez

Felicia ..... Nehassaiu DeGannes

Sharisa ..... Mallory Portnoy

*No Doubt, No Trouble* lyrics by Lily Kuzminski.

## WEIRD FRIENDS

Written by Ayman Musa, age 11

Director/Dramaturge: Jeremy Stoller

Sus ..... Ceci Fernandez

Joe ..... Jose-Maria Aguila

Fans ..... The Crew

Monkey ..... Corey Ruzicano

*How Stupid Can I Be* lyrics by Ayman Musa.

## LIFE'S COMPLICATED

Written by Selena Sanchez, age 11

Director/Dramaturge: Emma Weinstein

Sara Johnson ..... Carra Patterson

Henry Knole ..... Joe Paulik

Dad ..... John Sheehy

Nurse ..... Jose Gamo

*It's a Hard Life* and *Sleep Tight* lyrics by Selena Sanchez. Guitar accompaniment by Jose-Maria Aguila.

## TWO PEOPLE IN A DIFFERENT FAMILY

Written by Derek Rey, age 11

Director/Dramaturge: John Sheehy

Shadow ..... Bobby Cannavale

Bayah ..... Mozhan Marnò

*Rule Song* lyrics by Derek Rey.





# SHOW PROGRAMS 2016

The 52nd Street Project gratefully acknowledges the support of the following foundations and corporations: Brenner Family Foundation; Cantor Fitzgerald; Bull's Head Foundation; Carnegie Corporation of New York; CBS Foundation; City Winery; Common Sense Fund; Consolidated Edison; Dawkins Family Foundation; The Neil V. DeSena Foundation; Dramatists Guild Fund; Dubin Foundation; Educational Foundation of America; Evercore Partners; Harkness Foundation; HBO; Horace W. Goldsmith Foundation; I. Weiss; Jean & Louis Dreyfus Foundation; Kirkland & Ellis Foundation; Liquid Holdings Group; Ann M. Martin Foundation; Marusi Family Foundation; Newman's Own; Ninth Avenue Association; PAR Group; Parsons Family Foundation; Pinkerton Foundation; Rockefeller Foundation; The Shubert Organization; Slate Path Capital; Harold & Mimi Steinberg Charitable Trust; Surdna Foundation; Susquehanna Foundation; Tax Pro Financial Network; Tiger Baron Foundation; United Talent Agency; Yorke Construction Corp; ZenithOptimedia. (List current as of 7/1/14)

Robert Abrams & Cynthia Vance George Ackert Michael Alicastro Elton Andrews Richard Anthony Cecilia Arana Emily Armstrong James Armstrong Dominick & Ilene Balletta Becky Ann & Dylan Baker Ken Bantum Carolyn Bechtel Lisa Benavides & Tim Blake Nelson Louisa Benton Gavin Berger & Craig Berggren Stephanie Berger & Paul King Beth & Eric Berman David Beth Lewis Black Emily Blavatnik Allison Blinken Noah Bogdan Jane Bolster & Steve Wertimer Buzz Bovshow Blaise R. Box Becky Browder & Ted Neustadt Carlton T. Brown Iris A. Brown & Joe White Justin Brownhill Brian Byrnes Shawn & Laura Byron Joseph Capozzi Leah Carr Lawrence Catena Chris Ceraso Rachel Chanoff Todd Christie Damien Clancy Matthew Clancy Katie Clark Elizabeth Clemants David Cohen & Sandra Novak Cohen Larry Cohen	Penelope Collins Judith-Ann Corrente Janet Coviello William Crudup Kyle Czepiel Arthur Dantchik Cathy Dantchik Leslie Dantchik Peter & Judith Dawkins Carolyn & Neil DeSena Rebecca & Richard Dresser Peter Doyle Max Dyksterhouse & David Roady Doug Eisenberg Lynn Ellenberg Nora Ephron & Nicholas Pileggi Peter Jay Fernandez & Denise Burse Fernandez Liz Flahive & Jeff Cox Wendy Flanagan & Chris O'Malley Karen & Paul Freitas Sally Froelich Alexandra Garrison Beverly Gasner Rose Gasner & Larry Chertoff Celia Gerard & Mark McGrath Christina Gerber Freddie & Myrna Gershon Jenny Gersten & Willie Reale Alexandra Gersten-Vassilaros & John Vassilaros Scott Aaron Gewirtz & Laura Gewirtz Elizabeth Giamatti Robert Goldberg & Betsy MacIsaac Stephen & Cathy Graham Jan Gura & Alan Pickman Susan Hanson Jessica Hecht & Adam Bernstein Kathy & Jamie Herring Peter Herdrich & Karen Trott William Holtzman & S. Sylvia Shepard Mary Horowitz	Sarah Horowitz & David Venarde Andrea Johnson Beth Ifcher Carine Joannou Kristen Johanson Andrea Johnson Cindy Kaplan & David Froelich Valerie Kay & Bruce Graham Louise Klebanoff Henry Krieger & Robert Joy Jacki Ochs & Jan Kroeze Judy Kuhn & David Schwab Frances & Fred Langbecker Gabrielle Lansner & Dean Taucher Brian Lapin Michael Lawrence & Glen Gillen Warren Leight & Karen Hauser Mickey Lemle Jonathan Levine Helen Levy Melissa Lieblich-Goldberg & John Barrett Kay M. Lim Adrienne Lobel John Lynch Grace Lyu-Volkhausen Julie & Alex Margolies Ali Marsh Lin Manuel Miranda Frances McDormand & Joel Coen Emily & John Morgan Amanda & Neal Moszkowski Suzen Murakoshi & Mark Temme Fred Nelson Randy & Rona Nelson Ruth Nelson Lori O'Connor Carol Ochs & Bruce MacVittie Jacki Ochs & Jan Kroeze Kevin O'Rourke & Edith Thurber Jane Perlmutter & Greg MacPherson Elizabeth Peters	Sue Phillips Todd Poisson Suzanne Poulin Helaine & Michael Pruzan Christopher Randolph Helen & Peter Randolph Jacquelyn Reingold Anita A. Rogerson David Ross & Laura Ross Dr. Steve Rudin Laura Sametz & Anton Fig Karin & Thomas Schall Maury Schott Susan Schroeder & Britt Adams Whitney Scott Brian Jacobson Meg Simon Christopher Solomon Jonathan Soros & Jennifer Soros Jenny & Jon Steingart Tracy Straus Danny Strong Al Styron & Ed Beason Susanna Styron Richard Sweren Lili Taylor Lisa Tilney & Chris Lawrence Merritt Tilney & Douglas Kaden Lorraine Tobias & Alex Draper Liz Tuccillo Laura Valeroso & David Seidman Wendy vanden Heuvel & Brad Coley Susan J. Vitucci Mary Pat Walsh Dr. Mildred Walton Brenda Wehle & John C. Lynch Carol Whitesides Zee Wiener Ruth Ann Wynter J.P. Xenakis Carole Yass Yildiz Yuksek & Richard Blackstone Connie & Marc Zand
--	--	---	--

THE 52ND STREET PROJECT PRESENTS

# THE NICK OF TIME

## THE PUNCTUAL PLAYS

THE 2016 TWO-ON-TWOS

6 NEW PLAYS  
6 ADULT WRITERS  
6 ADULT DIRECTORS  
12 KID ACTORS

THE FIVE ANGELS THEATER

FRI, JAN. 29 @ 7:30 P.M. - SAT, JAN. 30 @ 7:30 P.M. - SUN, JAN. 31 @ 3:00 P.M.

ARTWORK BY PATRICK JAMES

# THE NICK OF TIME: THE PUNCTUAL PLAYS

The 2016 Two-on-Twos - Jan. 29-31, Five Angels Theater

## The 52nd Street Project Staff

Gus Rogerson, Artistic Director	Carol Ochs, Executive Director
Natalie Hirsch, Associate Artistic Director	John Sheehy, Director of Development & Marketing
Garrett Kim, Program Director	Molly Coogan, Development Associate
George Babiak, Production Manager	Liz Bell, Director of Education
Tim J. Lord, Technical Director	Johanna Vidal*, Community Coordinator
	Jennifer Jimenez*, Day Receptionist

*\*Alumnae of The 52nd Street Project*

### Consultants:

Iris A. Brown, Graphic Designer; Chris Ceraso, Teen Dean

### Interns:

Valerie Maybaum, Charles Pisano, Amanda Tralle

### Teen Employees:

Receptionists: Maria Martinez, Chayse Peña, Britney Trinidad

Ushers: Britney Trinidad, Maria Martinez, Chayse Peña, and Richard Brea

## “THE NICK OF TIME” Production Staff

### Composer/Music Director

Patrick Barnes

### Set Designer

Kevin Joseph Roach

### Lighting Designer

Greg McPherson

### Costume Designer

Jennifer Kirschman

### Sound Designer

Sam Barickman

### Stage Manager

Preeti Nath

### Projection Design:

George Babiak and  
The Project Slide Archive

### Props

George Babiak

### Backstage Crew

Valerie Maybaum,  
Charles Pisano,  
Karen Tineo,  
Amanda Tralle

### Chefs

John Sheehy and Liz Bell

### Nyack Weekend-away Hosts

Susanna Styron,  
Wendy vanden Heuvel,  
John-Paul Newport and Polly King,  
and Patricia Kahn



The Two-on-Two Program is made possible with public funds from The New York State Council on the Arts, a state agency, and the New York City Department of Cultural Affairs. The 52nd Street Project is a member of Art/NY and Theatre Communications Group (TCG), the national organization for the American theatre.

## COOL STUFF ON SALE IN THE LOBBY!

Fabulous Flyer Bars..... \$2.50  
and featuring Shel Silverstein's "Fivey and Twoey" logo:  
Project Hoodies..... \$30.00  
Project Caps ..... \$20.00  
Project T-shirts.....\$12.00/\$20.00  
Project Mugs..... \$5.00  
Project Notebook ..... \$5.00  
Project Pencil 3-pack.....\$1.00

Thank you for coming to **THE NICK OF TIME**. If you are not on our mailing list, you can join on-line at [www.52project.org](http://www.52project.org). If you're interested in being a volunteer, fill out the form below and hand it to one of our staffers in the lobby.

### PLEASE PUT ME ON YOUR LIST:

1/16

NAME \_\_\_\_\_

ADDRESS \_\_\_\_\_

CITY \_\_\_\_\_

STATE \_\_\_\_\_

ZIP \_\_\_\_\_

HOME PHONE \_\_\_\_\_

DAYTIME OR MOBILE PHONE \_\_\_\_\_

E-MAIL ADDRESS \_\_\_\_\_

MY OCCUPATION \_\_\_\_\_

MY HOBBIES \_\_\_\_\_

WANT TO BE GREEN AND SAVE THE PROJECT MONEY ON POSTAGE?  
CHECK THIS BOX TO RECEIVE OUR NOTICES EXCLUSIVELY VIA E-MAIL.

### YES, I WOULD LIKE TO BE OF HELP. I CAN:

- |   |   |  |
|---|---|--|
| <input type="checkbox"/> Help load in and out for shows | <input type="checkbox"/> Draw and/or paint  | <input type="checkbox"/> Help kids with homework |
| <input type="checkbox"/> Hang lights                    | <input type="checkbox"/> Help with mailings | <input type="checkbox"/> Teach kids a skill      |
| <input type="checkbox"/> Work on a backstage crew       | <input type="checkbox"/> Do office work     | <input type="checkbox"/> Be a chef at an event   |
| <input type="checkbox"/> Do graphic design              | <input type="checkbox"/> Design sound       | <input type="checkbox"/> Design and sew costumes |
| <input type="checkbox"/> Other (please specify) _____   |   |  |

### MY SCHEDULE IS:

- Very flexible. I'm often available during weekdays.  
 Somewhat flexible. I can help on the occasional morning or afternoon during the week.  
 Not very flexible at all, but I've got some free time on evenings and weekends.

If you would like to mail this (and you're always welcome to enclose a tax-deductible contribution), you can send it to: The 52nd Street Project, 789 10th Avenue, New York, NY 10019. Or fax it to (212) 333-5598.

## THE ANNUAL BENEFIT IS COMING!

LEWIS BLACK, JOHN BOWMAN, JIM GAFFIGAN,  
KATHLEEN MADIGAN, AND JESSICA WILLIAMS  
SERIOUSLY INVITE YOU TO SAVE THE DATE...

MONDAY, MAY 2, 2016

# LAUGHING MATTERS

KIDS' STAND-UP, ADULTS DELIVER  
THE ANNUAL 52ND STREET PROJECT GALA



CONTACT JOHN "KNEESLAPPER" SHEEHY FOR MORE INFORMATION ABOUT  
"LAUGHING MATTERS" AT (212) 333-5252 OR SHEEHY@52PROJECT.ORG

### The 52nd Street Project Board of Directors

Lisa Benavides	Frances McDormand
Rachel Chanoff	Noël Mihalow
Cathy Dantchik, co-chair	Carol Ochs
Carolyn DeSena	Willie Reale, founder
Wendy Ettinger, chair emeritus	Gus Rogerson
Louis P. Friedman, co-chair	Shirley Rumierk, alumni member
Alexandra Garrison	José Soto, Jr., alumni member
Alex Gersten-Vassilaros	Merritt Tilney
Robert Goldberg	Wendy vanden Heuvel
Stephen Graham, chair emeritus	Mark Whatley
Valerie Kay	

### What's Going On Here?

The 52nd Street Project is a non-profit organization that brings children from the Hell's Kitchen neighborhood together with professional theater artists to create original theater. **THE NICK OF TIME** is a production of our Two-on-Two's program, in which an adult playwright crafts a piece for a pair of 52nd Street Project kids to perform. Another adult directs the kids for a month that includes an intensive three-day weekend in upstate New York. Tonight's performance is the final result.

### In-Kind Contributions

Abbeville Press; abc cocina; Alvin Ailey American Dance Theater; Richard Anthony; Lewis Black; Iris A. Brown Design; William Curran & A Curran Affair; Emmett Global; Evercore Partners; Edie Falco; Empanada Mama; Jenny Gersten & Friends of The High Line; Google; Jonathan Groff; ICI; John A. Vassilaros & Sons; Kahve; Karen Kowgios of Fried & Kowgios; Charlie Marshal & the Marshal Restaurant; Noël & Joe Mihalow; Neustar; Nonesuch Records; the Public Theater; Sesame Workshop; Wendy Stuhlberg; Tao Restaurant; Uber; Watkins, Inc.; and Paul, Weiss, Rifkind, Wharton & Garrison LLP.

### Special Thanks

We owe many thanks to Susanna Styron; Wendy vanden Heuvel & Brian Mertes & Melissa Kievman; Polly King & John Paul Newport; and Patricia Kahn, all of whom graciously allowed us to use their homes in the Nyack area for three exhilarating and fun-filled days. Thanks also to Bear Mountain Skating Rink and New City Bowling for extra dollops of fun.



### BE ON THE LOOKOUT FOR INTERNS!

If you know of any college or graduate students who might enjoy working with us, playing with us, and going on trips with us for a semester, please have them contact . We are currently looking for interns for the Summer of 2016. Thanks!

# THE NICK OF TIME:THE PUNCTUAL PLAYS - ACT 1

All original music composed by Patrick Barnes

## POLAR BEAR SERVICE AND REPAIR

Written by Tim J. Lord

Directed by Sean Kenealy

Jason Banner ..... Justin Bannister  
Ajax Adams..... Adam Alkindi  
Bears ..... Charles Pisano, Karen Tineo, Amanda Tralle

*Where the Road Takes Us* lyrics by Tim J. Lord

## THE BEST/WORST DAY

Written by Lynn Rosen

Directed by Arielle Goldman

Trish..... Kayla Ortiz  
Jessi ..... Allyssia Feliciano  
Announcer ..... Valerie Maybaum

*A Nightmare of a Day* lyrics by Lynn Rosen

## FLOWER CHILDREN

Written by Melisa Tien

Directed by Kerry Whigham

Lamb..... Lambert Whitney  
Rina ..... Sabrina Caldonia

*Lamb and Rina* lyrics by Melisa Tien



# THE NICK OF TIME:THE PUNCTUAL PLAYS - ACT 2

INTERMISSION

## STRANGERS ON A TRAIN

Written by Cate Yu

Directed by Colette Robert

Sila..... Christin Tetteh  
Cheese ..... Wilhelmina Ohene Kari Kari  
Mr. Snore ..... Charles Pisano

*Living for the Chase: A Friendship* lyrics by Cate Yu

## THE POWER DANCE WALKER'S GOLD

Written by Lucas Kavner

Directed by Tina Chilip

Melinda Magnifico..... Kayla Matos  
Rizzle 500..... Joseph Cruz  
Super Fantastic ..... George Babiak  
Crappy Chris..... John Sheehy  
Dance walk competitor ..... Natalie Hirsch  
Announcer ..... Charles Pisano

*Dreams of Gold and The Moment of Truth* lyrics by Lucas Kavner

## WHAT WE DO, WE DO FOR TRUE

Written by Beto O'Byrne

Directed by Sathya Sridharan

Wade ..... Bryan Lopez  
James ..... Bamba Thiam

*We're Flying* lyrics by Beto O'Byrne





The 52nd Street Project is a not-for-profit theater company dedicated to the children living in the Hell's Kitchen (Clinton) neighborhood in Manhattan. Founded in 1981 by actor/playwright and 1994 MacArthur Fellow Willie Reale, the Project is an after-school, arts-in-education program that brings kids together with professional theater artists to create original theater through unique mentoring relationships. The Project's deeper purpose is to improve the literacy, sense of self-worth and appreciation for the arts of New York's inner-city children by tapping into their creativity and powers of imagination. Founded in response to a deepening and persistent need to improve the quality of life for New York's children, the Project has produced more than 1,000 plays involving over 1,500 children and theater artists.

The 52nd Street Project is providing kids with one thing all of them need - individual attention. In all classes and programs, the kids are encouraged to draw upon their own experiences, thus creating avenues for self-expression. By furnishing them with thoughtful assistance, as well as a stage and an audience, the kids flourish in the glow of public validation. What they gain is self-esteem, and addiction to success, increased confidence in their literary skills, and perhaps most importantly, a place to belong.

# Finding Home

A Benefit Concert for  
The 52nd  
Street Project  
with

**Judy Kuhn**  
and  
special guests

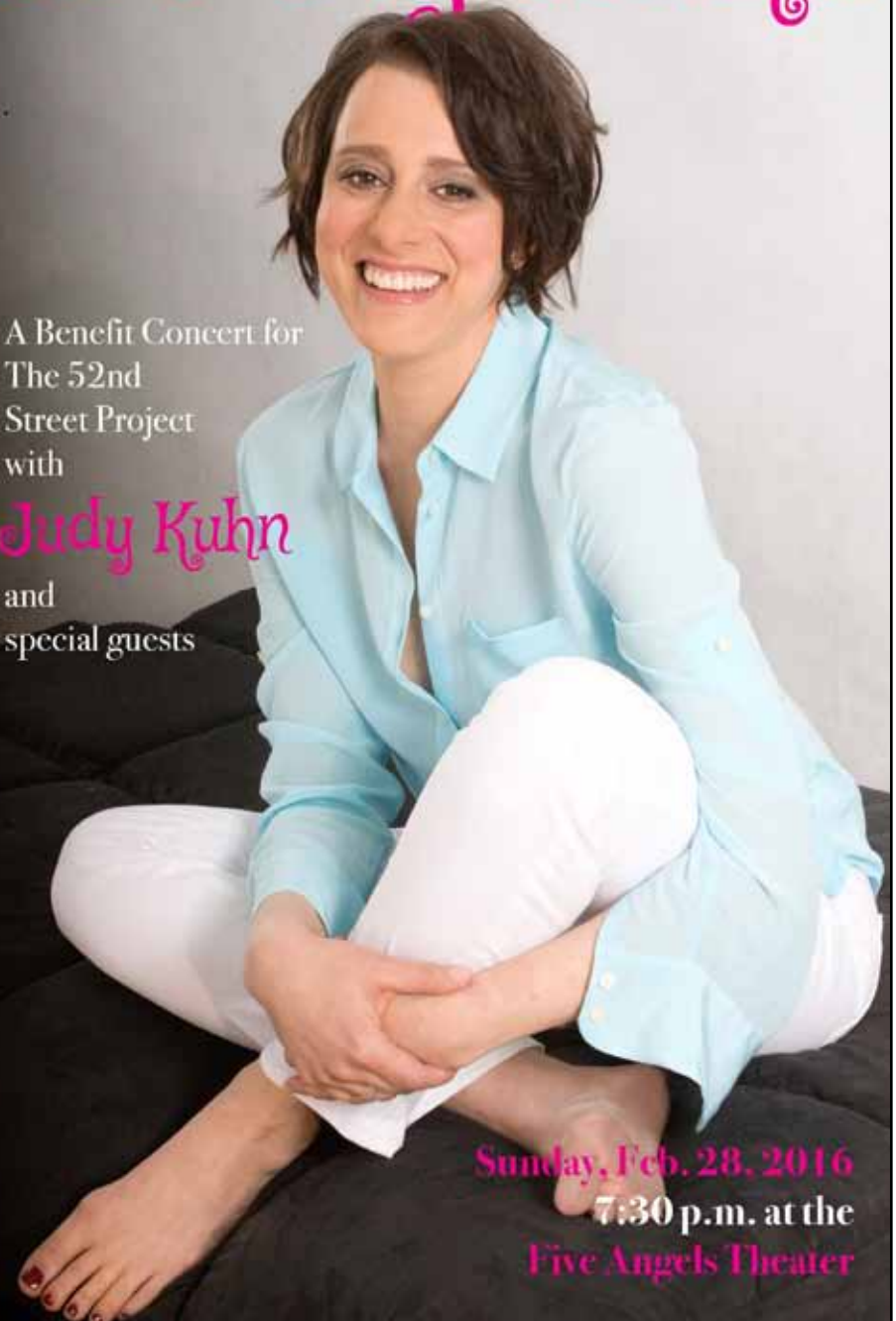

Sunday, Feb. 28, 2016  
7:30 p.m. at the  
Five Angels Theater

## The 52nd Street Project Board of Directors

Lisa Benavides  
Rachel Chanoff  
Cathy Dantchik, co-chair  
Carolyn DeSena  
Wendy Ettinger, chair emeritus  
Louis P. Friedman, co-chair  
Alexandra Garrison  
Alex Gersten-Vassilaros  
Robert Goldberg  
Stephen Graham, chair emeritus  
Valerie Kay  
Frances McDormand  
Noël Mihalow  
Carol Ochs  
Willie Reale, founder  
Gus Rogerson  
Shirley Rumierk, alumni member  
José Soto, Jr., alumni member  
Merritt Tilney  
Wendy vanden Heuvel  
Mark Whatley

## The 52nd Street Project Staff

Carol Ochs, Executive Director  
Gus Rogerson, Artistic Director  
Natalie Hirsch, Associate Artistic Director  
John Sheehy, Director of Development & Marketing  
Shaunice Jordan, Manager of Individual Giving and Special Events  
Liz Bell, Director of Education  
George Babiak, Production Manager  
Tim J. Lord, Technical Director  
Johanna Vidal, Community Coordinator  
Jennifer Jimenez, Receptionist  
Valerie Maybaum, Amanda Tralle, Interns

Carol Ochs,  
Executive Director

Cathy Dantchik and Louis P. Friedman,  
Board Co-Chairs

Gus Rogerson,  
Artistic Director

# Finding Home

A Benefit Concert with

## Judy Kuhn

Sunday, February 28, 2016 at 7:30 p.m.  
Five Angels Theater

### The Adult Performers

Judy Kuhn, John Ellison Conlee, Kally Duling,  
Beth Malone, Lauren Patten, Joel Perez  
Perry Sherman, Jim Stanek

### The Kid Performers

Lakshmi DeJesus, Joshua Gomez, Edelys Guerrero,  
Stephanie Macias, Ethan Perez

### The Musicians

Chris Fenwick, Music Director and Keyboard  
Damien Bassman, Drums

### Lighting Designer

Miriam Crowe

### Stage Manager

Charles M. Turner III

### Sound Designer

John Kemp

### Assistant Stage Manager

Kaleigh Bernier

### Special Thanks

William Curran  
Patrice Del Casino  
A Curran Affair  
Kim D. Sherman  
Cellar 53 Wines and Liquors



# Judy's Song List

I Don't Wanna Grow Up

Tom Waits

Night Ride Home

Joni Mitchell

Nobody's Heart

Music: Richard Rodgers. Lyrics: Lorenz Hart.

Hey, Love

Music: Mary Rodgers. Lyrics: Martin Charnin.

Love To Me

Adam Guettel

If You Asked Me

Mary Rodgers

Hero and Leander

Adam Guettel

Goodbye Joe

Laura Nyro

Money

Music: Rusty Magee. Lyrics: Solangee Acosta.

Home

Karla Bonoff

Welcome Home

Todd Almond

Finding Home

Music: Ricky Ian Gordon. Lyrics: Tina Landau.

The 52nd Street Project gratefully acknowledges the support of the following foundations and corporations: Brenner Family Foundation; Cantor Fitzgerald; Bull's Head Foundation; Carnegie Corporation of New York; CBS Foundation; City Winery; Common Sense Fund; Consolidated Edison; Dawkins Family Foundation; The Neil V. DeSena Foundation; Dramatists Guild Fund; Dubin Foundation; Educational Foundation of America; Evercore Partners; Harkness Foundation; HBO; Horace W. Goldsmith Foundation; I. Weiss; Jean & Louis Dreyfus Foundation; Kirkland & Ellis Foundation; Liquid Holdings Group; Ann M. Martin Foundation; Marusi Family Foundation; Newman's Own; Ninth Avenue Association; PAR Group; Parsons Family Foundation; Pinkerton Foundation; Rockefeller Foundation; The Shubert Organization; Slate Path Capital; Harold & Mimi Steinberg Charitable Trust; Surdna Foundation; Susquehanna Foundation; Tax Pro Financial Network; Tiger Baron Foundation; United Talent Agency; Yorke Construction Corp; ZenithOptimedia. (List current as of 7/1/14)

Robert Abrams & Cynthia Vance	Penelope Collins Judith-Ann Corrente	Sarah Horowitz & David Venarde	Sue Phillips Todd Poisson
George Ackert	Janet Coviello	Andrea Johnson	Suzanne Poulin
Michael Alicastro	William Crudup	Beth Ifcher	Helaine & Michael Pruzan
Elton Andrews	Kyle Czepiel	Carine Joannou	Christopher Randolph
Richard Anthony	Arthur Dantchik	Kristen Johanson	Helen & Peter Randolph
Cecilia Arana	Cathy Dantchik	Andrea Johnson	Jacquelyn Reingold
Emily Armstrong	Leslie Dantchik	Cindy Kaplan & David Froelich	Anita A. Rogerson
James Armstrong	Peter & Judith Dawkins	Valerie Kay & Bruce Graham	David Ross & Laura Ross
Dominick & Ilene Balletta	Carolyn & Neil DeSena	Louise Klebanoff	Dr. Steve Rudin
Becky Ann & Dylan Baker	Rebecca & Richard Dresser	Henry Krieger & Robert Joy	Laura Sametz & Anton Fig
Ken Bantum	Peter Doyle	Jacki Ochs & Jan Kroeze	Karin & Thomas Schall
Carolyn Bechtel	Max Dyksterhouse & David Roady	Judy Kuhn & David Schwab	Maury Schott
Lisa Benavides & Tim Blake Nelson	Doug Eisenberg	Frances & Fred Langbecker	Susan Schroeder & Britt Adams
Louisa Benton	Lynn Ellenberg	Gabrielle Lansner & Dean Taucher	Whitney Scott
Gavin Berger & Craig Berggren	Nora Ephron	Brian Lapin	& Peter Jacobson
Stephanie Berger & Paul King	Peter Jay Fernandez & Denise Burse Fernandez	Michael Lawrence & Glen Gillen	Meg Simon
Beth & Eric Berman	Liz Flahive & Jeff Cox	Warren Leight & Karen Hauser	Christopher Solomon
David Beth	Wendy Flanagan & Chris O'Malley	Mickey Lemle	Jonathan Soros & Jennifer Soros
Lewis Black	Karen & Paul Freitas	Jonathan Levine	Jenny & Jon Steingart
Emily Blavatnik	Sally Froelich	Helen Levy	Tracy Straus
Allison Blinken	Alexandra Garrison	Melissa Liebling-Goldberg & John Barrett	Danny Strong
Noah Bogan	Beverly Gasner	Kay M. Lim	Al Styron & Ed Beason
Jane Bolster & Steve Wertimer	Rose Gasner & Larry Chertoff	Adrienne Lobel	Susanna Styron
Buzz Bovshow	Celia Gerard & Mark McGrath	John Lynch	Richard Sweren
Blaise R. Box	Christina Gerber	Grace Lyu-Volckhausen	Lili Taylor
Becky Browder & Ted Neustadt	Freddie & Myrna Gershon	Julie & Alex Margolies	Lisa Tilney & Chris Lawrence
Carlton T. Brown	Jenny Gersten & Willie Reale	Ali Marsh	Merritt Tilney & Douglas Kaden
Iris A. Brown & Joe White	Alexandra Gersten-Vassilaros & John Vassilaros	Lin Manuel Miranda	Lorraine Tobias & Alex Draper
Justin Brownhill	Scott Aaron Gewirtz & Laura Gewirtz	Frances McDormand & Joel Coen	Liz Tuccillo
Brian Byrnes	Elizabeth Giamatti	Emily & John Morgan	Laura Valeroso & David Seidman
Shawn & Laura Byron	Robert Goldberg & Betsy MacIsaac	Amanda & Neal Moszkowski	Wendy vanden Heuvel & Brad Coley
Joseph Capozzi	Stephen & Cathy Graham	Suzen Murakoshi & Mark Temme	Susan J. Vitucci
Leah Carr	Jan Gura & Alan Pickman	Fred Nelson	Mary Pat Walsh
Lawrence Catena	Susan Hanson	Randy & Rona Nelson	Dr. Mildred Walton
Chris Ceraso	Jessica Hecht & Adam Bernstein	Ruth Nelson	Brenda Wehle & John C. Lynch
Rachel Chanoff	Kathy & Jamie Herring	Lori O'Connor	Carol Whitesides
Todd Christie	Peter Herdrich & Karen Trott	Carol Ochs & Bruce MacVittie	Zee Wiener
Damien Clancy	William Holtzman & S. Sylvia Shepard	Jacki Ochs & Jan Kroeze	Ruth Ann Wynter
Matthew Clancy	William Horowitz	Kevin O'Rourke	J.P. Xenakis
Katie Clark		Jacki Ochs & Jan Kroeze	Carole Yass
Elizabeth Clemants		Jane Perlmutter & Greg MacPherson	Yildiz Yuksek & Richard Blackstone
David Cohen & Sandra Novak Cohen		Elizabeth Peters	Connie & Marc Zand
Larry Cohen			

The 52nd Street Project Presents



THE SPRING 2016 PLAYMAKING PLAYS  
10 new plays written by kids & performed by adult actors

Friday, April 1 at 7:30 p.m.  
Saturday, April 2 at 3:00 and 7:30 p.m.  
Sunday, April 3 at 3:00 p.m.

at The 52nd Street Project's

FIVE ANGELS THEATER

# FRESH START: THE REJUVENATING PLAYS

Spring Playmaking 2016 - April 1-3, Five Angels Theater

## The 52nd Street Project Staff

Gus Rogerson, Artistic Director  
 Natalie Hirsch, Associate Artistic Director  
 Garrett Kim, Program Director

Carol Ochs, Executive Director  
 Tahnee Cadrez, Dev. & Mgmt. Associate  
 John Sheehy, Dir. of Development & Marketing  
 Shaunice Jordan, Mgr. of Individual Giving

George Babiak, Production Manager  
 Tim J. Lord, Technical Director

Liz Bell, Director of Education  
 Johanna Vidal\*, Community Coordinator  
 Jennifer Jimenez\*, Day Receptionist

*\*Alumnae of The 52nd Street Project*

### Consultants:

Iris A. Brown, Graphic Designer; Chris Ceraso, Teen Dean

### Interns:

Valerie Maybaum, Amanda Tralle

### Teen Employees:

Receptionists: Maria Martinez, Chayse Peña, Britney Trinidad  
 Playmaking Teen Counselor: Michael Bannister  
 Ushers: Richard Brea, Edelys Guerrero, Wilhelmina Ohene-Kari Kari, Kayla Ortiz, Britney Trinidad

## "FRESH START" Production Staff

### Composer/Music Director

Teresa Lotz

### Set Designer

Kevin Joseph Roach

### Lighting Designer

Greg MacPherson

### Costume Designer

Kim Goings

### Sound Designer

Amanda Tralle

### Stage Manager

Jenny Peek

### Projection Designs

George Babiak and the  
 Project's Projection Archive

### Prop Designs

George Babiak

### Backstage Crew

Michael Bannister, Mina Daniel,  
 Tatiana Goode, Valerie Maybaum,  
 Karen Tineo

### Show Photographer

Winston Rodney

### Weekend-Away Chefs

John Sheehy and Kim Sherman

### Playmaking Class Volunteers

Saheem Ali, Amber Avant, Lucy Boyle,  
 Hampton Fluker, Jose Gamo,  
 Brianna Pozner, Kim Sherman,  
 Joe Tippet

### Playmaking Class Teen Assistant

Martin Sanchez

### Flyer and Program Art

Jay Owen Eisenberg



The Playmaking Program is made possible with public funds from The New York State Council on the Arts, a state agency, and the New York City Department of Cultural Affairs. This project is supported in part by an award from the National Endowment for the Arts. The 52nd Street Project is a member of Art/NY and Theatre Communications Group (TCG), the national organization for the American theatre.

## COOL STUFF ON SALE IN THE LOBBY!

Fabulous Flyer Bars..... \$2.50  
*and featuring Shel Silverstein's "Fivey and Twoey" logo:*  
 Project Hoodies..... \$30.00  
 Project Caps..... \$20.00  
 Project T-shirts..... \$12.00/\$20.00  
 Project Mugs..... \$5.00  
 Project Notebook..... \$5.00  
 Project Pencil 3-pack..... \$1.00

Thank you for coming to **FRESH START**. If you are not on our mailing list, you can join on-line at [www.52project.org](http://www.52project.org). If you're interested in being a volunteer, fill out the form below and hand it to one of our staffers in the lobby.

### PLEASE PUT ME ON YOUR LIST:

04/16

NAME \_\_\_\_\_

ADDRESS \_\_\_\_\_

CITY \_\_\_\_\_

STATE \_\_\_\_\_

ZIP \_\_\_\_\_

HOME PHONE \_\_\_\_\_

DAYTIME OR MOBILE PHONE \_\_\_\_\_

E-MAIL ADDRESS \_\_\_\_\_

MY OCCUPATION \_\_\_\_\_

MY HOBBIES \_\_\_\_\_

WANT TO BE GREEN AND SAVE THE PROJECT MONEY ON POSTAGE?  
 CHECK THIS BOX TO RECEIVE OUR NOTICES EXCLUSIVELY VIA E-MAIL.

### YES, I WOULD LIKE TO BE OF HELP. I CAN:

- Help load in and out for shows
- Draw and/or paint
- Help kids with homework
- Hang lights
- Help with mailings
- Teach kids a skill
- Work on a backstage crew
- Do office work
- Be a chef at an event
- Do graphic design
- Design sound
- Design and sew costumes
- Other (please specify) \_\_\_\_\_

### MY SCHEDULE IS:

- Very flexible. I'm often available during weekdays.
- Somewhat flexible. I can help on the occasional morning or afternoon during the week.
- Not very flexible at all, but I've got some free time on evenings and weekends.

If you would like to mail this (and you're always welcome to enclose a tax-deductible contribution), you can send it to: The 52nd Street Project, 789 10th Avenue, New York, NY 10019. Or fax it to (212) 333-5598.

# THE ANNUAL BENEFIT IS COMING!

LEWIS BLACK, JOHN BOWMAN, JIM GAFFIGAN,  
KATHLEEN MADIGAN, AND JESSICA WILLIAMS  
SERIOUSLY INVITE YOU TO SAVE THE DATE...

MONDAY, MAY 2, 2016

## LAUGHING MATTERS

KIDS' STAND-UP, ADULTS DELIVER  
THE ANNUAL 52ND STREET PROJECT GALA



CONTACT JOHN "KNEESLAPPER" SHEEHY FOR MORE INFORMATION ABOUT  
"LAUGHING MATTERS" AT (212) 333-5252 OR SHEEHY@52PROJECT.ORG

### The 52nd Street Project Board of Directors

Lisa Benavides	Frances McDormand
Rachel Chanoff	Noël Mihalow
Cathy Dantchik, co-chair	Carol Ochs
Carolyn DeSena	Willie Reale, founder
Wendy Ettinger, chair emeritus	Gus Rogerson
Louis P. Friedman, co-chair	Shirley Rumierk, alumni member
Alexandra Garrison	José Soto, Jr., alumni member
Alex Gersten-Vassilaros	Merritt Tilney
Robert Goldberg	Wendy vanden Heuvel
Stephen Graham, chair emeritus	Mark Whatley
Valerie Kay	

### What's Going On Here?

The 52nd Street Project is a non-profit organization that brings children from the Hell's Kitchen neighborhood together with professional theater artists to create original theater. **FRESH START** is a production of our Playmaking program. Young people participate in a nine-week playwriting course taught by Natalie Hirsch and adapted for the Project by Daniel Judah Sklar from his book *Playmaking: Children Writing and Performing Their Own Plays*. At the end of the course, each child is matched with two actors and a dramaturg/director who guides him or her through the writing of a play during a weekend retreat in the country (Bridgehampton, Long Island, for this show). This performance is the end result.

### In-Kind Contributions

Abbeville Press; abc cocina; Alvin Ailey American Dance Theater; Richard Anthony; Lewis Black; Iris A. Brown Design; William Curran & A Curran Affair; Emmett Global; Evercore Partners; Edie Falco; Empanada Mama; Jenny Gersten & Friends of The High Line; Google; Jonathan Groff; ICI; John A. Vassilaros & Sons; Kahve; Karen Kowgios of Fried & Kowgios; Charlie Marshal & the Marshal Restaurant; Noël & Joe Mihalow; Neustar; Nonesuch Records; the Public Theater; Sesame Workshop; Wendy Stuhlberg; Tao Restaurant; Uber; Watkins, Inc.; and Paul, Weiss, Rifkind, Wharton & Garrison LLP.

### Special Thanks

We're extremely grateful to Alexandra Gersten-Vassilaros for the use of her beautiful home in Bridgehampton, NY as our base of operations for the writer's retreat. We're also grateful to Leslie & Cathy Dantchik for being the girls' host, and to Laurie Becker for housing adults in Sag Harbor.



### BE ON THE LOOKOUT FOR INTERNS!

If you know of any college or graduate students who might enjoy working with us, playing with us, and going on trips with us for a semester, please have them contact Garrett Kim (gkim@52project.org). We are currently looking for interns for the Fall of 2016. Thanks!

# FRESH START: ACT 1

All original music composed by Teresa Lotz

## LANA HELPS MEL

Written by Yovely Ramirez, age 9  
Director/Dramaturge: Lucy DeVito

Mel..... Amber Avant  
Lana..... Rebecca S'Manga Frank

*Mel Song Alone and Lana Song Spy* lyrics by Yovely Ramirez.

## THE LESSON OF FRIENDSHIP

Written by Rebecca Jimenez, age 9  
Director/Dramaturge: Mikaela Mahony

Strawberry ..... Christina Pumariega  
Raspberry ..... KeiLyn Durrel Jones  
Players ..... The Crew

*BFF Game* lyrics by Rebecca Jimenez.

## BROTHERS LEARN NEW THINGS

Written by Ahmed Abdelmegeed, age 10  
Director/Dramaturge: Tim Lord

Gilbert ..... Christopher Randolph  
Jason ..... Sam Lilja  
Coach ..... George Babiak  
Dad ..... John Sheehy  
Nurse ..... Valerie Maybaum

*Best Kids Ever* lyrics by Ahmed Abdelmegeed.

## PLANET FRENCHY

Written by Shadel Gil, age 9  
Director/Dramaturge: Grace Rex

Le Puff Puff ..... Kate Abbruzzese  
Frenchy ..... Kerry Warren

*I'm Sorry For The Past* lyrics by Shadel Gil.

## WHATEVER COMES AROUND, GOES AROUND

Written by Andres Mendoza, age 10  
Director/Dramaturge: Michael Walkup

Yes The Van ..... Dan Butler  
No The Van ..... Daniel Jenkins  
Delivery people ..... Tatiana Goode and Valerie Maybaum

*We All Belong, We All Get Along* lyrics by Andres Mendoza.



# FRESH START: ACT 2

## THE ALIEN'S SECRET

Written by Thiana Goode, age 11  
Dramaturge: Shaunice Jordan, Director: Natalie Hirsch

Destiny ..... Molly Carden  
Stephine ..... Eliza Huberth

*I Have To Go* lyrics by Thiana Goode.

## BROTHERSHIP

Written by Angel Mendoza, age 10  
Director/Dramaturge: Brandon Dirden

Jake ..... Armando Riesco  
Joey ..... Stephen Tyrone Williams

*My Point of View* lyrics by Angel Mendoza.

## SUPER SLIME MAGIC

Written by Carlos Manuel Jimenez II, age 10  
Director/Dramaturge: Garrett Kim

Slimey Slime Boy ..... Brandon Hall  
Gila Girl ..... Therese Barbato  
Gila Monsters and Slimers ..... The Crew  
Policeman ..... George Babiak

*Super Hero Feelings* lyrics by Carlos Manuel Jimenez II.

## FRIENDSHIP NEVER ENDS

Written by Lovely Ramirez, age 9  
Director/Dramaturge: Flor De Liz Perez

Maryse ..... Danaya Esperanza  
Maria ..... Marisol Miranda  
Teacher ..... Natalie Hirsch  
The Bullies ..... Crew

*Suprised Present and Sunny Days* lyrics by Lovely Ramirez.

## REDUCING THE FEAR OF MONSTERS

Written by Gabriel Acevedo, age 10  
Director/Dramaturge: George Babiak

Zack ..... Matt Saldivar  
Mayhem ..... Carson Elrod

*Friends Forever Together* lyrics by Gabriel Acevedo.





The 52nd Street Project Presents

# Dancemaking 2016

The 52nd Street Project is a non-profit arts organization that brings children from the Hell's Kitchen neighborhood together with professional artists to create original art. The Dancemaking program gives 7 Project kids a chance to express themselves creatively through movement. Over the nine weeks of Dancemaking class, led by HannaH Allen with support from Program Director Garrett Kim, these young choreographers and performers developed their own movement vocabulary. With their adult Choreoturges, they explored shapes, pathways, actions, and choreographic elements to create their own original piece. The resulting dances are featured in tonight's performance.

## The 52nd Street Project Staff

Gus Rogerson, Artistic Director

Natalie Hirsch, Associate Artistic Director  
Garrett Kim, Program Director

Liz Bell, Director of Education

Johanna Vidal\*, Community Coordinator  
Corey Ruzicano, Education Apprentice

Jennifer Jimenez\*, Day Receptionist

Anthony Mejia\*, Chanel Rodney\*, Front Door Receptionists

Carol Ochs, Executive Director

Tahnee Cadrez,  
Development & Mgmt. Associate

John Sheehy, Dir. of Development & Marketing

Shaunice Jordan, Mgr. of Individual Giving

George Babiak, Production Manager

Tim J. Lord, Technical Director

*\*Alumnus of The 52nd Street Project*

## Consultants:

Iris A. Brown, Graphic Designer; Chris Ceraso, Teen Dean

## Interns:

Valerie Maybaum, Amanda Tralle

## Teen Employees:

Receptionists: Maria Martinez, Chayse Peña, Britney Trinidad

Ushers: Jasmine Correa, Ashley Thomas

## The 52nd Street Project Board of Directors

Lisa Benavides

Rachel Chanoff

Cathy Dantchik, co-chair

Carolyn DeSena

Wendy Ettinger, chair emeritus

Louis P. Friedman, co-chair

Alexandra Garrison

Alexandra Gersten-Vassilaros

Robert Goldberg

Stephen Graham, chair emeritus

Valerie Kay

Frances McDormand

Noël Mihalow

Carol Ochs

Willie Reale, founder

Gus Rogerson

Shirley Rumierk, alumni member

José Soto, Jr., alumni member

Merritt Tilney

Wendy vanden Heuvel

Mark Whatley

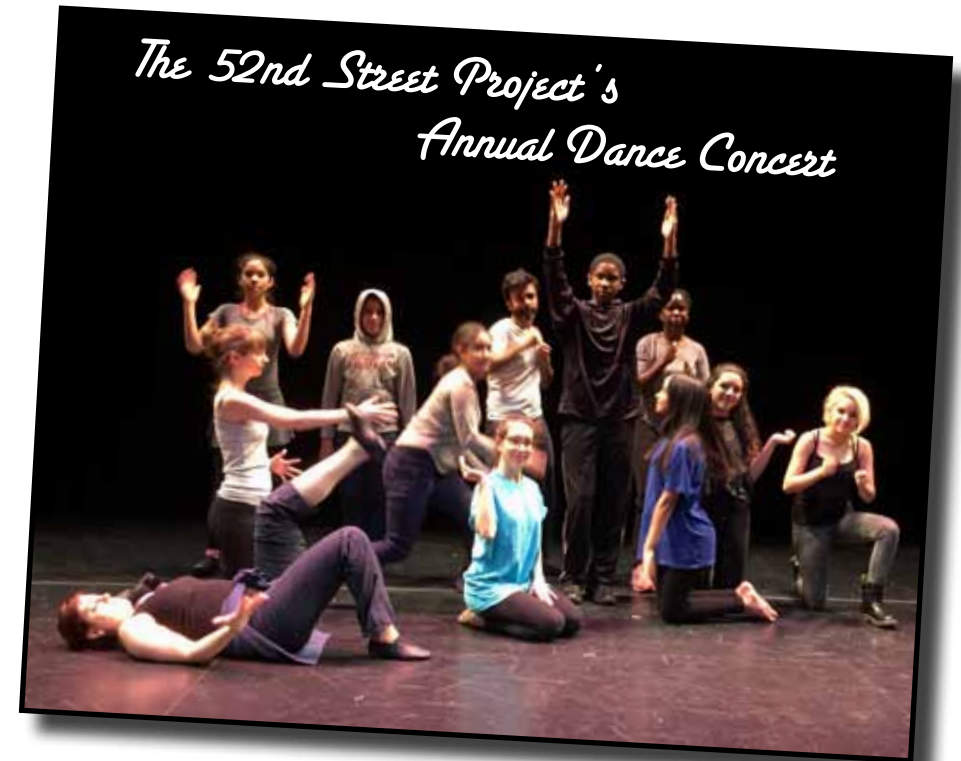

Featuring 6 original dances choreographed by kids and performed by kids and adults.

Dancemaking Director: HannaH Allen

Friday, April 15, 2016 – 7:30 p.m.

The Five Angels Theater  
The 52nd Street Project  
789 10th Avenue

## Striving

Choreographed by: HannaH Allen  
Performed by: The 2016 Dancemaking Company  
Music: “Bolero” by Steven Sharples from *Moulin Rouge*  
Theme: Ambition

## Welcome People

Choreographed by Lakshmi DeJesus  
Adult Partner: Tatiana Baccari  
Music: “Bongos with Sticks” by Groovecamp  
Theme: Happy and Exciting

*ABOUT THE DANCE: “Our dance is very jumpy and exciting. I came up with these dance moves because of the rhythm of the song and it’s really African-like. I think that our song and dance moves are like welcoming people.” -Lakshmi*

## Bad Memories

Choreographed by: Jayda Camacho & Valeria Oliva  
Adult Partner: Channie Waites  
Music: “Clamor” by Balmorhea  
Theme: Medieval

*ABOUT THE DANCE: “The music reminded me of a fight in a medieval time line, which caused my dance to become real. A fight and bad memories” –Jayda*

*“It reminds me of a cat when its owner leaves the house and what it does for fun” -Valeria*

## Ninjas Till Death

Choreographed by: Daniel Tineo  
Adult Partner: Nick Choksi  
Music: “Just Another Dead Rat in a Garbage Can”  
from *Fantastic Mr. Fox*  
by Alexandre Desplat  
Theme: Destiny

*ABOUT THE DANCE: “Our fathers were enemies and were the best ninjas around town. We were meant to fight.” -Daniel*

## Pink Ballerina

Choreographed by: Sofia Santoni  
Adult Partner: Lacey Tucker  
Music: “Crystallize” by Lindsay Sterling  
Theme: Coming and Going

*ABOUT THE DANCE: “It [the dance] is diametrically opposed.” -Sofia*

## Broken-Hearted Friendship

Choreographed by: Kaylee Zambrano  
Adult Partner: Molly Camp  
Music: “Your Hand in Mine” by Explosions In The Sky  
Theme: Memories are Always in the Past

*ABOUT THE DANCE: “It is about 2 girls who have lost what used to bring them together. And they looked back in time to find and share happy memories. And some sad ones too. ☺” –Kaylee*

## When There’s Despair, There’s Always Hope

Choreographed by: Justin Bannister  
Adult Partner: Gardiner Comfort  
Music: “Dig the Say” by Vijay Iyer and  
“Spirit of Adventure” by Michael Giacchino from the Pixar film *Up*  
Theme: Hope and Despair

*ABOUT THE DANCE: “Outrageous music with no tempo. The reason why we chose this...I don’t remember—just kidding—April Fool’s. We chose it because it relates to our explosive quick movements.” -Justin*



The Dancemaking Program is made possible with public funds from The New York State Council on the Arts, a state agency, and the New York City Department of Cultural Affairs. This project is supported in part by an award from the National Endowment for the Arts. The 52nd Street Project is a member of Art/NY and Theatre Communications Group (TCG), the national organization for the American theatre.

## **THE 52ND STREET PROJECT BOARD OF DIRECTORS**

Lisa Benavides	Frances McDormand
Rachel Chanoff	Noël Mihalow
Cathy Dantchik, co-chair	Carol Ochs
Carolyn DeSena	Willie Reale, founder
Wendy Ettinger, chair emeritus	Gus Rogerson
Louis P. Friedman, co-chair	Shirley Rumierk, alumni member
Alexandra Garrison	José Soto, Jr., alumni member
Alex Gersten-Vassilaros	Merritt Tilney
Robert Goldberg	Wendy vanden Heuvel
Stephen Graham, chair emeritus	Mark Whatley
Valerie Kay	

## **THE 52ND STREET PROJECT STAFF**

Carol Ochs, Executive Director  
Gus Rogerson, Artistic Director  
Natalie Hirsch, Associate Artistic Director  
Liz Bell, Director of Education  
John Sheehy, Director of Development & Marketing  
George Babiak, Production Manager  
Tim J. Lord, Technical Director  
Garrett Kim, Program Director  
Johanna Vidal, Community Coordinator  
Shaunice Jordan, Manager of Individual Giving  
Tahnee Cadrez, Development & Management Associate  
Jennifer Jimenez, Day Receptionist

## **BENEFIT VOLUNTEERS**

Laura Hamilton, KeiLyn Durrel Jones,  
Valerie Maybaum, Corey Ruzicano, Kim D. Sherman,  
Amanda Tralle, Vanessa Valdes

## **COMEDYTURGES**

Marinda Anderson, Lauren Blumenfeld, Molly Coogan,  
Chelsea Hackett, Cynthia Kaplan, Max Posner

**WELCOME TO...**

# **LAUGHING MATTERS**

**KID'S STAND-UP • ADULTS DELIVER**  
**THE 52ND STREET PROJECT'S ANNUAL BENEFIT**

**MONDAY, MAY 2, 2016**  
**THE EDISON BALLROOM**



## “LAUGHING MATTERS” BENEFIT CO-CHAIRS

Lisa Benavides  
Becky Browder  
Rachel Chanoff  
Carolyn DeSena

Patrice Friedman  
Karin Schall  
Laura Valeroso  
Mary Pat Walsh

### THE 52ND STREET PROJECT GRATEFULLY ACKNOWLEDGES...

Abbeville Press  
Richard Anthony  
Ars Nova  
Lewis Black  
Iris A. Brown Design  
William Curran, A Curran Affair  
Edie Falco  
Jim and Jeannie Gaffigan  
Erik Larson  
Kathleen Madigan  
The Marshal  
Noël Mihalow and Prime Films  
Natasha, Pierre, and the Great Comet of 1812  
Noho Hospitality Group  
Lauren Friedman, Pharma/Omni Printing  
The Public Theater  
Willie Reale  
Showtime  
Jenny Steingart  
TARA 4779  
Merritt Tilney & Doug Kaden  
Robin Treadway  
TV Land/Viacom Kids & Family  
John A. Vassilaros & Sons  
Mark Jacobs & Watkins Incorporated  
Healthier Living Since 1868  
Steve Olsen and the WestBank Cafe

## BEMUSED SEATS

Beth & Ray Abbott  
Becky Ann & Dylan Baker  
Eliza Baldi & David Costabile  
Beth Barry & Daniel Sussman  
Neena Beber  
Nancy & Robert Becker  
Craig Berggren & Gavin Berger  
Beth & Eric Berman  
Allison Blinken  
Jane Bolster & Steve Wertimer  
Buzz Bovshow  
Becky Browder  
Denise Burse Fernandez &  
Peter Jay Fernandez  
Leah Carr  
Navin & Preeti Choksi  
Ellen Chopay  
Lisa Cohen  
Marion & Alan Dienstag  
Michaelene Durst  
Lindsay Fram & Mason Pettit  
Sally Froelich  
Bev Gasner  
Rose Gasner & Larry Chertoff  
Jenny Gersten & Willie Reale  
Laura & Scott Gewirtz  
Susan Hanson  
Karen Hauser & Warren Leight  
Jessica Hecht  
Kristen Johanson & Tom Green  
Cynthia Kaplan & David Froelich  
Kim & Elliot Katz  
Anita Keal & Morty Wolkowitz  
Mary Kong

Alan Krevis & Gary Horowitz  
Henry Krieger & Robert Joy  
Judy Kuhn  
Frances Langbecker  
Martin Levine, The PAR Group  
Yohan Minaya  
Michael Moss  
Suzen Murakoshi  
Lori O'Connor  
Jacki Ochs & Jan Kroeze  
Beth & Bob Ollwerther  
Jane Perlmutter &  
Greg MacPherson  
Suzanne Poulin  
Randi Puccio  
Anita Andres Rogerson  
Lynne Marie Rosenberg  
Steve Sabba,  
Tax Pro Financial Network, Inc.  
Sawyer | Berson Architects &  
Landscape Architects  
Amy Seifer  
Sylvia Shepard & Willy Holtzman  
Laura & Brian Shortt  
Bob Shwartz  
Stephen Sondheim  
Jenni Swan  
Richard Sweren  
Edith Thurber & Kevin O'Rourke  
Adriana Trigiani & Tim Stephenson  
Cynthia Vance & Robert Abrams  
Simona & Ted Vassilev  
Shelley & Gary Vogel  
Mary Pat Walsh

**Hoo  
Hoo**

## **TITTERING SEATS**

Jennifer & Jonathan Allan Soros

Stephen Bernstein

Katie Clark

Sarah Horowitz & David Venarde

Tara Elwin

Mickey Lemle

Josephine Merck & Jim Stevenson

Rona & Randolph Nelson

Steve Olsen

Nicole Pellicciotto

Laura Sametz

Karin & Thomas Schall

Jeremy Smith

Avi Taussig & Richard Anthony

Laura Valeroso

Carole Yass

**HEE  
HEE**

**HEH  
HEH**

Carol Ochs,  
Executive Director

Cathy Dantchik & Louis P. Friedman,  
Board Co-Chairs

Gus Rogerson,  
Artistic Director

# **LAUGHING MATTERS**

**KID'S STAND-UP • ADULTS DELIVER**  
**Monday, May 2, 2016 at The Edison Ballroom**

### **Your Hosts**

Lewis Black and Kathleen Madigan

### **The Writers**

Jayla Alvarez

Magalis Fabián Viñas

Karen Tineo

Milen Tokarev

Coleman Williams

### **The Performers**

Lewis Black

John Bowman

Jim Gaffigan

Kathleen Madigan

Jessica Williams

### **Director**

Gus Rogerson

### **Lighting Designer**

Greg MacPherson

### **Sound Designer**

Scott Lehrer

### **Set and Prop Designer**

George Babiak

### **Stage Manager**

Anne Lowrie

### **Auctioneer**

Robin Treadway

## DONALD TRUMP IS A REGULAR PERSON

Written by Coleman Williams, age 11

Performed by Lewis Black

*"Hello my name is Coleman Williams and I am eleven years old. I was inspired by stuff that is mean but also funny, and people saying and doing stupid things. The things I find funny are random jokes, people falling or messing up in some way, and people not knowing obvious things."*



*"In elevator with me and Donald Trump. I say, 'You know how to make America great again, to act like a normal person.'*

*He says, 'I act like a normal person, I have people put on my pants one leg at a time, I have people drive me to work and I watch TV on my movie theatre screen while people wash my toes and feed me popcorn.'*

*'Yeah because all people can buy a movie screen.'*

*'Yeah, it's only 50,000 dollars, that's nothing.'"*

— Coleman Williams

## FALLING-OUT TABLES

The Dantchik Family

Stephen Graham

## CAACKLING TABLES

Comedy Central

Patrice & Louis Friedman

Elaine Musselman

Dr. Borah W. Walton, Jr.

## CHORTLING TABLES

APA, Talent & Literary Agency

Lisa Benavides Nelson & Tim Blake Nelson

CBS Corporation

Dawkins Family Foundation

Carolyn & Neil DeSena

Alexandra Garrison

Robert Goldberg, Yorke Construction Corporation

Valerie Kay & Bruce Graham

Live Nation Comedy

Grace Lyu-Volckhausen, Tiger Baron Foundation

Laura & David Ross

Merritt Tilney & Douglas Kaden

TV Land/Viacom Kids & Family

United Talent Agency

Wendy vanden Heuvel

Alexandra Vassilaros

Vicki & Mark Whatley

## CHRISTMAS STORY

Written by Magalis Fabián Viñas, age 11

Performed by Jessica Williams

*'My name is Magalis Fabián Viñas. I am 11 years old. Chelsea Hackett inspired me because she asked me what happened at Christmas. The other stuff was funny... because it happened. Except one part I made up because I couldn't remember everything that happened.*

*Some things I find funny are: Weird faces and made-up voices, sometimes. Sometimes they are boring."*



*"I woke up on Christmas morning this year ... You know, it bugs me when I can't find my clothes. I mean it's in my drawer but I can't match them, you know, put them together, doesn't match, like if your shirt is too short for your leggings. I hate that. Anyway, I'm feeling excited, but tired. I stayed up until 1 in the morning trying to see if Santa was real, but I didn't make it. And I was waiting to get a phone. I didn't want just any type of phone. I wanted an iPhone like my friend Lakshmi. She has Siri, in her iPhone. And if I ask Siri a question, she gives me the answer. Like Lakshmi asked Siri a math question and Siri answered, or maybe it was a map question..."*

— Magalis Fabián Viñas

## PASSING THE PENCIL

Written by Milen Tokarev, age 13

Performed by John Bowman

*"Hello everyone! My name is Milen Tokarev and I am 13 years old. When I started writing comedy I didn't really know what to write about, but then I remembered what happened at school the other day. I find it funny when people with anger issues scream at seagulls in German! Enjoy my personal experience!"*

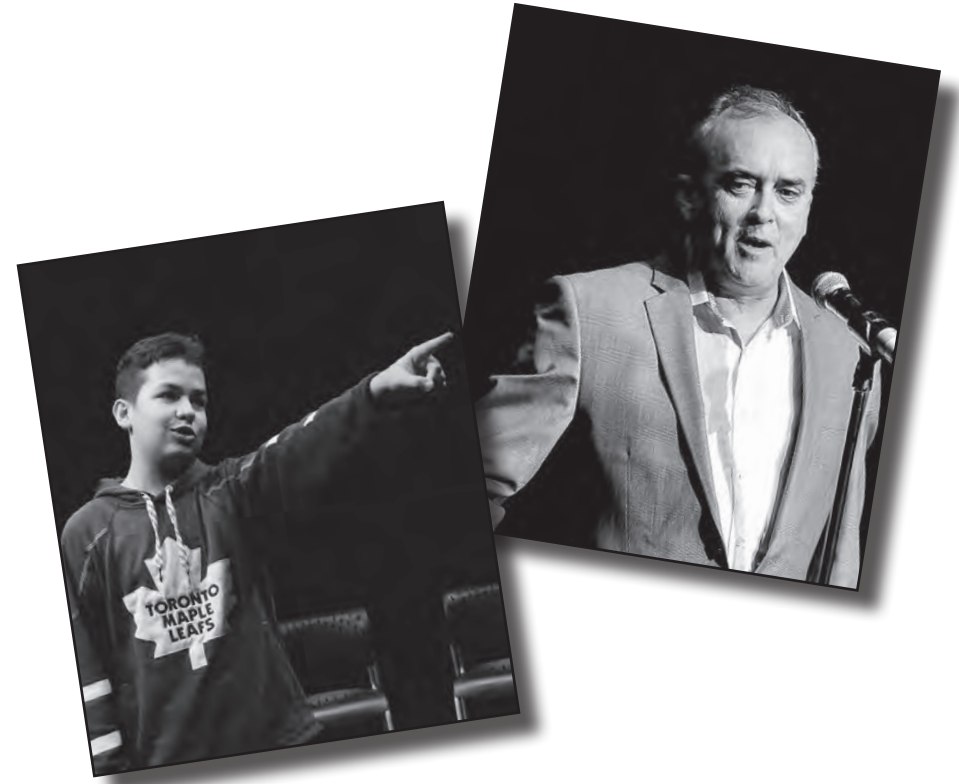

*"It was 2:39. I went through the day with no trouble. I usually don't get into trouble. I was in the last class of the day in art with Ms. Fass. If she was an animal, she'd be a fox or blob fish, but in a good way. My Bengali friend Shimon was sitting across the room. The best thing about him being Bengali is that he can't eat my lunch if it has beef. I saw that he was trying to lip sync "PASS!!!" to me. I thought for a second, What does he want me to pass him? I looked around me and there was nothing but a pencil. I looked around if anyone was looking and thought how to throw it. Should I tomahawk it, should I throw it lead first or across the floor? I decided to tomahawk it. The second I threw that thing, it was the biggest regret of my life."*

— Milen Tokarev

## BEING A 13-YEAR OLD GIRL IS HARD

Written by Karen Tineo, age 13

Performed by Jim Gaffigan

*"I'm Karen Tineo and I am 13 years old. What inspired me to write the comedy were my experiences. I took some funny stories that I had and I decided to share them with everyone. There were things that happened to me that at the time I thought was awful, but now when I look back on it, I find it funny. Some things that I laugh at are: 1. Other people laughing; 2. Random things; 3. Really anything."*



*"Being a 13-year-old girl is hard. I have to deal with schoolwork, drama and relationships all at once. All the girls in my school want to have "boyfriends" and I don't understand why. When an 8th grade girl has a "boyfriend", it's really just an 8th grade girl saying she has a boyfriend."*

— Karen Tineo

## POTATOES AND YOUTUBE

Written by Jayla Alvarez, age 13

Performed by Kathleen Madigan

*"Greetings, I'm Jayla. Just Jayla. I'm 13. Something that has inspired me to write this comedy was that I don't like being like everyone else. I like being the one person that doesn't hold back on my ideas when I share them. I like to share them with others and give them another point of view. I basically find anything funny, except for fake people. They ain't funny or interesting at all. Well, I guess that's it for now. Sit back, relax and enjoy."*



*"I love potatoes so much, I dream about them. I am Queen Potato of Potatoland and all of the Idaho potatoes are my potato citizens. And of course my celebrity husbands/kings are Troye, Tyler, and Justin. Troye Sivan would sing me to sleep and pick out my outfits, he knows how to dress; Tyler Oakley rocks any hair color and could make my color look good too, right-hand, go-to guy; and of course, Justin Bieber, arm candy!"*

— Jayla Alvarez

The 52nd Street Project (The Project) is dedicated to the creation and production of new plays for and by kids between the ages of ten and eighteen who reside in the Hell's Kitchen neighborhood in New York City. The Project does this through unique mentoring programs that match kids with professional (and volunteer) theater artists.

THIS IS HOW WE ROLL is a production of our Teen Ensemble Program. The Teen Ensemble is a two year acting conservatory program, which includes several public performances of original material and culminates in a full Shakespeare production. This show is the last stage of their first year.

After a year that included classes in movement, improvisation, mask performance, scene study, poetry and singing, the teens met with six adult playwrights. After their meetings, the adult playwrights scurried off to their garrets to write the plays we are now presenting.

Special thanks to all of our wonderful volunteer guest artists who have worked with the Teen Ensemble this year: **Anne Troup, Danyon Davis, Lynne Rosenberg, Daiva Deupree, Michael Propster, Rory Scholl, Eric March, Jose Gamo, Marinda Anderson, Jonathan Bock, Nick Mills, Alyssa Cartwright, and Jeremy Stoller.**

Thanks also to the **Public Theater** for comps to several great shows the teens got to see this year.

We also want to express our gratitude to **Drew University** for the use of their terrific campus for the Teen Weekend trip, where the teens rehearsed these plays and got a sneak peek at college life.

The following foundations and government agencies have generously supported the Teen Program through their contributions:

City of New York Department of Cultural Affairs  
Horace W. Goldsmith Foundation  
New York State Council on the Arts





## The 52nd Street Project Staff

Gus Rogerson, Artistic Director  
Natalie Hirsch, Associate Artistic Director  
Garrett Kim, Program Director  
George Babiak, Production Manager  
Tim J. Lord, Technical Director

Carol Ochs, Executive Director  
Tahnee Cadrez, Dev. & Mgmt. Associate  
John Sheehy, Dir. of Development & Marketing  
Shaunice Jordan, Mgr. of Individual Giving

Liz Bell, Director of Education  
Johanna Vidal\*, Community Coordinator  
Jennifer Jimenez\*, Day Receptionist

### Consultants:

*\*Alumnae of The 52nd Street Project*

Iris A. Brown, Graphic Designer; Chris Ceraso, Teen Dean

### Interns:

Haviland Atha-Simonton, Ian Edlund, Emma Steiger

### Teen Employees:

Receptionists: Maria Martinez, Chayse Peña, Britney Trinidad  
Ushers: Wilhelmina Ohene Kari Kari, Maria Martinez, Kayla Ortiz

### “This Is How We Roll” Team

Tim J. Lord.....Lighting Designer  
Jennifer Jimenez.....Costume Designer  
Emma Steiger.....Sound Designer  
Ian Edlund.....Projectorist  
Haviland Atha-Simonton.....Stage Boss  
Christin Tetteh.....Stagehand  
George Babiak.....Prop and Projection Design

### The 52nd Street Project Board of Directors

Lisa Benavides	Frances McDormand
Rachel Chanoff	Noël Mihalow
Cathy Dantchik, co-chair	Carol Ochs
Carolyn DeSena	Willie Reale, founder
Wendy Ettinger, chair emeritus	Gus Rogerson
Louis P. Friedman, co-chair	Shirley Rumierk, alumni member
Alex Gersten-Vassilaros	José Soto, Jr., alumni member
Robert Goldberg	Merritt Tilney
Stephen Graham, chair emeritus	Wendy vanden Heuvel
Valerie Kay	Mark Whatley

## THE CONSPIRATORIUM

Written by Dylan Dawson and directed by Lynne Rosenberg

Doug..... Enrique Caballero  
Stacy..... Tatiana Goode  
Piper..... Ruby Zamora  
Justin..... George Babiak  
Mr. Donner..... John Sheehy  
The Janitor..... Haviland Atha-Simonton

## BARRY AND MARY

Written by Melisa Tien and directed by Austin Regan

Barry..... Chayse Peña  
Mary..... Edelys Guerrero  
The Bear..... Christin Tetteh  
Zombies..... Daniel Martinez, Imani Lewis-Ashley,  
and Haviland Atha-Simonton

## SENIOR PRANKS

Written by Erica Saleh and directed by Ka-Ling Cheung

Principal Veley.....Asia Rosado  
Sam..... Daniel Martinez  
Gabby..... Leah Macuilt

## INTERMISSION

## UPROOTED

Written by Tim J. Lord and directed by Max Rosenak

Lo..... Richard Brea  
Daphne..... Britney Trinidad  
Sam..... Faisal Afridi

## BEFORE THE BELL

Written by Christina Quintana and directed by Rachel Dart

Lara..... Ashley Thomas  
Alejandra..... Jasmine Correa  
Tia..... Imani Lewis-Ashley



The 52nd Street Project is a non-profit arts organization that brings children from the Hell's Kitchen neighborhood together with professional artists to create original art.

In Stage Combat, a ruff-n-rowdy group of Project kids and their scrappy adult partners have learned the art of safe, choreographed fighting. Led by Project volunteer Jose-Maria Aguila, they've learned to tell stories of high-stakes conflicts through punches, kicks, slaps, and so much more! Each play is centered around a staged fight that they have created with the guidance of their adult partners.

### The 52nd Street Project Staff

Gus Rogerson, Artistic Director

Natalie Hirsch, Associate Artistic Director  
Garrett Kim, Program Director

Liz Bell, Director of Education

Johanna Vidal\*, Community Coordinator

Jennifer Jimenez\*, Day Receptionist

Carol Ochs, Executive Director

Tahnee Cadrez,  
Development & Mgmt. Associate

John Sheehy, Dir. of Development & Marketing

Shaunice Jordan, Mgr. of Individual Giving

George Babiak, Production Manager

Tim J. Lord, Technical Director

*\*Alumnus of The 52nd Street Project*

### Consultants:

Iris A. Brown, Graphic Designer; Chris Ceraso, Teen Dean

### Interns:

Haviland Atha-Simonton, Ian Edlund, Holly Gibbs, Emma Steiger

### Teen Employees:

Receptionists: Maria Martinez, Chayse Peña, Britney Trinidad, Wilhelmina Ohene Kari Kari

Ushers: Jasmine Correa, Nick Carrero

### The 52nd Street Project Board of Directors

Lisa Benavides

Rachel Chanoff

Cathy Dantchik, co-chair

Carolyn DeSena

Wendy Ettinger, chair emeritus

Louis P. Friedman, co-chair

Alexandra Gersten-Vassilaros

Robert Goldberg

Stephen Graham,

chair emeritus

Valerie Kay

Frances McDormand

Noël Mihalow

Carol Ochs

Willie Reale, founder

Gus Rogerson

Shirley Rumierk, alumni member

José Soto, Jr., alumni member

Merritt Tilney

Wendy vanden Heuvel

Mark Whatley

# THE 52ND STREET PROJECT PRESENTS THE LORRAINE COHEN STAGE COMBAT SHOWS



1. FIGHTING DISTANCE



2. EYE CONTACT

SWEET DREAMS, BROTHER!



3. WIND-UP

UH-OH!



4. LOOK AT THE TARGET

AAHH!!!



5. THE EVENT

OWWOOO!! THAT'LL TEACH YA!



6. FOLLOW-THROUGH

**Friday, June 17, 2016 at 7:30 p.m.**

The Five Angels Theater at The 52nd Street Project



# THE 2016 LORRAINE COHEN STAGE COMBAT SHOWS

## THE EXTERMINATOR

Written by Rebecca Gomez, age 12

Directed by Olivia Gilliatt

Scarlet ..... Rebecca Gomez  
Racoondude...ish..... Olivia Gilliatt

## SECRET RECIPE

Written by Rodery Rosario, age 11

Directed by Stan Demidoff

Bob ..... Rodery Rosario  
Kev ..... Stan Demidoff

## WHAT REALLY HAPPENS IN THE SKY

Written by Darby O'Donnell, age 12

Directed by Leah Walsh

Jessica..... Darby O'Donnell  
Mia..... Leah Walsh

## LONG LOST SISTERS

Written by Wilhelmina Ohene Kari Kari & Ashley Thomas,  
ages 14 and 15

Directed by Molly Carden

Azeala..... Ashley Thomas  
Whitney..... Wilhelmina Ohene Kari Kari  
Amelia..... Molly Carden



## YOUTUBE STARZ

Written by Kiara Figueroa, age 13

Directed by Kerry Warren

Brooke ..... Kiara Figueroa  
Mitchee ..... Kerry Warren

## TWO BOLTS

Written by Bryan Lopez, age 14

Directed by Michael Salinas

John ..... Bryan Lopez  
Future John ..... Michael Salinas

## BROTHERS REUNITE

Written by Ethan Zenteno, age 11

Directed by Charlie O'Rourke

Jerry ..... Ethan Zenteno  
Oslo ..... Charlie O'Rourke

## THE PRODUCTION TEAM

Fight Director and Instructor ..... Jose Maria Aguila  
Lighting Designer ..... Tim J. Lord  
Lightboard Operator ..... Emma Steiger  
Sound Designer ..... Ian Edlund  
Stage Boss ..... Haviland Atha-Simonton  
Animal Wrangler ..... Holly Gibbs  
Props ..... George Babiak



The Stage Combat Program is made possible with public funds from The New York State Council on the Arts, a state agency, and the New York City Department of Cultural Affairs. This project is supported in part by an award from the National Endowment for the Arts. The 52nd Street Project is a member of Art/NY and Theatre Communications Group (TCG), the national organization for the American theatre.

## **Lorraine Cohen** **1927-2005**

For more than forty years, Lorraine Cohen dedicated herself to all facets of the theater, including acting, directing and teaching. Her deeply memorable performances as Amanda in *The Glass Menagerie* and as Emily Dickinson in *The Belle of Amherst* were often compared favorably with the very well known actors who had played those roles before her. Those who knew her as a teacher, remember the amazing annual Shakespeare productions of her fifth graders and the many stunning performances of her high school students.

In the 1960's Laurie performed in a series of plays at the Bergen County Players in New Jersey including *Ring Around Elizabeth* (1960), *Fumed Oak* (1961), *Blithe Spirit* (1962), and *The Waltz of the Toreadors* (1961). In 1969 she performed in *No Bed of Roses* at the Showplace Summer Theatre. Laurie also spent many productive years at The New Dimension Theatre Studio in Englewood, New Jersey where Dr. Richard Imundo was the Artistic Director. At The New Dimension she taught acting to children and young adults, and also performed in many productions including *Animal* (1971), *The Glass Menagerie*, and *Uncle Vanya* (1970). She also directed and acted in many evenings of scenes at The New Dimension. One of her early students at The New Dimension was a young man by the name of John Travolta who also performed with her in *Who'll Save the Plowboy?* (1966).

Having obtained her college degree from Fairleigh Dickinson University in Teaneck, New Jersey, she performed in a series of plays produced by the University Players, including *Ghosts*, *The Glass Menagerie*, and *J.B.* While studying for her masters degree at Montclair State College, she performed in several productions there including *The Hostage*, *Plaza Suite*, and *Not Now Darling*. Laurie also performed in *Cinderella* at the William Paterson College Summer Theatre Workshop, and in 1984 she performed in *The Devil's Disciple* at the Williamstown Theatre Festival in Williamstown, Massachusetts.

In 1983 Laurie starred as Emily Dickinson in the one-woman show *The Belle of Amherst*, directed by her friend and colleague, John Brancato. *The Belle of Amherst* had a limited run at The Tyson Studio in New York City to rave reviews in *The New York Times* and *The Daily News*.

Though many encouraged Laurie to pursue a professional acting career, she always made it clear that her true love was teaching and she dedicated much of her life to filling young students' hearts and minds with the love of theatre, both in its literary form and as a performing art. During her tenure in the 1970's as a fifth grade teacher at the Longfellow School in Teaneck, New Jersey, she directed an annual Shakespeare play starring her fifth grade students, performing the likes of *Macbeth*, *Julius Caesar* and *Hamlet*. Laurie's love of theater and teaching reached its pinnacle during her many years teaching English and Drama at Teaneck High School in Teaneck, New Jersey. She truly loved teaching drama to high school students, introducing them to the joys of acting and play-writing, and she directed an enormous number of full length productions, musicals, scenes, and student-written original plays. She directed too many shows to list individually, but they included *Cabaret*, *Diary of Anne Frank*, *A Midsummer Night's Dream*, *The Crucible*, *The Man Who Came To Dinner*, *Don't Drink the Water* and *Waiting for Godot*. In addition to these productions, she directed the students in an annual *Evening of Scenes*. Her students won many awards for their work at the annual Bucks County Playhouse Drama Festivals in Pennsylvania. Even after retirement from teaching, she continued to direct performances at Leonia High School, in Leonia, New Jersey.

In addition to acting and teaching, Laurie also edited three books for the theatre: *Scenes for Young Actors*, *Monologues for Young Actors*, and *Scenes for Mature Actors*, all published by Avon Books. These three books continue to be used today in acting classes and auditions around the country.

Laurie is remembered lovingly by her five children, her three siblings, her eight grandchildren, her companion Dick, her many colleagues and friends, and her innumerable students. It is in her memory that they support the 52nd Street Project. It is what she would have wanted.



## **Lorraine Cohen** **1927-2005**

For more than forty years, Lorraine Cohen dedicated herself to all facets of the theater, including acting, directing and teaching. Her deeply memorable performances as Amanda in *The Glass Menagerie* and as Emily Dickinson in *The Belle of Amherst* were often compared favorably with the very well known actors who had played those roles before her. Those who knew her as a teacher, remember the amazing annual Shakespeare productions of her fifth graders and the many stunning performances of her high school students.

In the 1960's Laurie performed in a series of plays at the Bergen County Players in New Jersey including *Ring Around Elizabeth* (1960), *Fumed Oak* (1961), *Blithe Spirit* (1962), and *The Waltz of the Toreadors* (1961). In 1969 she performed in *No Bed of Roses* at the Showplace Summer Theatre. Laurie also spent many productive years at The New Dimension Theatre Studio in Englewood, New Jersey where Dr. Richard Imundo was the Artistic Director. At The New Dimension she taught acting to children and young adults, and also performed in many productions including *Animal* (1971), *The Glass Menagerie*, and *Uncle Vanya* (1970). She also directed and acted in many evenings of scenes at The New Dimension. One of her early students at The New Dimension was a young man by the name of John Travolta who also performed with her in *Who'll Save the Plowboy?* (1966).

Having obtained her college degree from Fairleigh Dickinson University in Teaneck, New Jersey, she performed in a series of plays produced by the University Players, including *Ghosts*, *The Glass Menagerie*, and *J.B.* While studying for her masters degree at Montclair State College, she performed in several productions there including *The Hostage*, *Plaza Suite*, and *Not Now Darling*. Laurie also performed in *Cinderella* at the William Paterson College Summer Theatre Workshop, and in 1984 she performed in *The Devil's Disciple* at the Williamstown Theatre Festival in Williamstown, Massachusetts.

In 1983 Laurie starred as Emily Dickinson in the one-woman show *The Belle of Amherst*, directed by her friend and colleague, John Brancato. *The Belle of Amherst* had a limited run at The Tyson Studio in New York City to rave reviews in *The New York Times* and *The Daily News*.

Though many encouraged Laurie to pursue a professional acting career, she always made it clear that her true love was teaching and she dedicated much of her life to filling young students' hearts and minds with the love of theatre, both in its literary form and as a performing art. During her tenure in the 1970's as a fifth grade teacher at the Longfellow School in Teaneck, New Jersey, she directed an annual Shakespeare play starring her fifth grade students, performing the likes of *Macbeth*, *Julius Caesar* and *Hamlet*. Laurie's love of theater and teaching reached its pinnacle during her many years teaching English and Drama at Teaneck High School in Teaneck, New Jersey. She truly loved teaching drama to high school students, introducing them to the joys of acting and play-writing, and she directed an enormous number of full length productions, musicals, scenes, and student-written original plays. She directed too many shows to list individually, but they included *Cabaret*, *Diary of Anne Frank*, *A Midsummer Night's Dream*, *The Crucible*, *The Man Who Came To Dinner*, *Don't Drink the Water* and *Waiting for Godot*. In addition to these productions, she directed the students in an annual *Evening of Scenes*. Her students won many awards for their work at the annual Bucks County Playhouse Drama Festivals in Pennsylvania. Even after retirement from teaching, she continued to direct performances at Leonia High School, in Leonia, New Jersey.

In addition to acting and teaching, Laurie also edited three books for the theatre: *Scenes for Young Actors*, *Monologues for Young Actors*, and *Scenes for Mature Actors*, all published by Avon Books. These three books continue to be used today in acting classes and auditions around the country.

Laurie is remembered lovingly by her five children, her three siblings, her eight grandchildren, her companion Dick, her many colleagues and friends, and her innumerable students. It is in her memory that they support the 52nd Street Project. It is what she would have wanted.



The 52nd Street Project gratefully acknowledges the support of the following foundations and corporations: Brenner Family Foundation; Cantor Fitzgerald; Bull's Head Foundation; Carnegie Corporation of New York; CBS Foundation; City Winery; Common Sense Fund; Consolidated Edison; Dawkins Family Foundation; The Neil V. DeSena Foundation; Dramatists Guild Fund; Dubin Foundation; Educational Foundation of America; Evercore Partners; Harkness Foundation; HBO; Horace W. Goldsmith Foundation; Howard Gilman Foundation; I. Weiss; Jean & Louis Dreyfus Foundation; Kirkland & Ellis Foundation; Liquid Holdings Group; Ann M. Martin Foundation; Marusi Family Foundation; Newman's Own; Ninth Avenue Association; PAR Group; Parsons Family Foundation; Pinkerton Foundation; Rockefeller Foundation; The Shubert Organization; Slate Path Capital; Harold & Mimi Steinberg Charitable Trust; Surdna Foundation; Susquehanna Foundation; Tax Pro Financial Network; Tiger Baron Foundation; United Talent Agency; Yorke Construction Corp; ZenithOptimedia. (List current as of 7/1/14)

- |                              |                              |                               |                                |
|------------------------------|------------------------------|-------------------------------|--------------------------------|
| Robert Abrams                | Penelope Collins             | Sarah Horowitz                | Sue Phillips                   |
| & Cynthia Vance              | Judith-Ann Corrente          | & David Venarde               | Todd Poisson                   |
| George Ackert                | Janet Coviello               | Andrea Johnson                | Suzanne Poulin                 |
| Michael Alicastro            | William Crudup               | Beth Ifcher                   | Helaine & Michael Pruzan       |
| Elton Andrews                | Kyle Czepiel                 | Carine Joannou                | Christopher Randolph           |
| Richard Anthony              | Arthur Dantchik              | Kristen Johanson              | Helen & Peter Randolph         |
| Cecilia Arana                | Cathy Dantchik               | Andrea Johnson                | Jacquelyn Reingold             |
| Emily Armstrong              | Leslie Dantchik              | Cindy Kaplan & David Froelich | Anita A. Rogerson              |
| James Armstrong              | Peter & Judith Dawkins       | Valerie Kay & Bruce Graham    | David Ross & Laura Ross        |
| Dominick & Ilene Balletta    | Carolyn & Neil DeSena        | Louise Klebanoff              | Dr. Steve Rudin                |
| Becky Ann & Dylan Baker      | Rebecca & Richard Dresser    | Henry Krieger & Robert Joy    | Laura Sametz & Anton Fig       |
| Ken Bantum                   | Peter Doyle                  | Jacki Ochs & Jan Kroeze       | Karin & Thomas Schall          |
| Carolyn Bechtel              | Max Dyksterhouse             | Judy Kuhn & David Schwab      | Maury Schott                   |
| Lisa Benavides               | & David Roady                | Frances & Fred Langbecker     | Susan Schroeder                |
| & Tim Blake Nelson           | Doug Eisenberg               | Gabrielle Lansner             | & Britt Adams                  |
| Louisa Benton                | Lynn Ellenberg               | & Dean Taucher                | Whitney Scott                  |
| Gavin Berger                 | Nora Ephron                  | Brian Lapin                   | & Peter Jacobson               |
| & Craig Berggren             | & Nicholas Pileggi           | Michael Lawrence              | Meg Simon                      |
| Stephanie Berger & Paul King | Peter Jay Fernandez          | & Glen Gillen                 | Christopher Solomon            |
| Beth & Eric Berman           | & Denise Burse Fernandez     | Warren Leight & Karen Hauser  | Jonathan Soros                 |
| David Beth                   | Liz Flahive & Jeff Cox       | Mickey Lemle                  | & Jennifer Soros               |
| Lewis Black                  | Wendy Flanagan               | Jonathan Levine               | Jenny & Jon Steingart          |
| Emily Blavatnik              | & Chris O'Malley             | Helen Levy                    | Tracy Straus                   |
| Allison Blinken              | Karen & Paul Freitas         | Melissa Liebling-Goldberg     | Danny Strong                   |
| Noah Bogan                   | Sally Froelich               | & John Barrett                | Al Styron & Ed Beason          |
| Jane Bolster                 | Alexandra Garrison           | Kay M. Lim                    | Susanna Styron                 |
| & Steve Wertimer             | Beverly Gasner               | Adrienne Lobel                | Richard Sweren                 |
| Buzz Bovshow                 | Rose Gasner & Larry Chertoff | John Lynch                    | Lili Taylor                    |
| Blaise R. Box                | Celia Gerard & Mark McGrath  | Grace Lyu-Volkhausen          | Lisa Tilney & Chris Lawrence   |
| Becky Browder                | Christina Gerber             | Julie & Alex Margolies        | Merritt Tilney & Douglas Kaden |
| & Ted Neustadt               | Freddie & Myrna Gershon      | Ali Marsh                     | Lorraine Tobias & Alex Draper  |
| Carlton T. Brown             | Jenny Gersten & Willie Reale | Lin Manuel Miranda            | Liz Tuccillo                   |
| Iris A. Brown & Joe White    | Alexandra Gersten-Vassilaros | Frances McDormand             | Laura Valeroso                 |
| Justin Brownhill             | & John Vassilaros            | & Joel Coen                   | & David Seidman                |
| Brian Byrnes                 | Scott Aaron Gewirtz          | Emily & John Morgan           | Wendy vanden Heuvel            |
| Shawn & Laura Byron          | & Laura Gewirtz              | Amanda & Neal Moszkowski      | & Brad Coley                   |
| Joseph Capozzi               | Elizabeth Giamatti           | Suzen Murakoshi               | Susan J. Vitucci               |
| Leah Carr                    | Robert Goldberg              | & Mark Temme                  | Mary Pat Walsh                 |
| Lawrence Catena              | & Betsy MacIsaac             | Fred Nelson                   | Dr. Mildred Walton             |
| Chris Ceraso                 | Stephen & Cathy Graham       | Randy & Rona Nelson           | Brenda Wehle & John C. Lynch   |
| Rachel Chanoff               | Jan Gura & Alan Pickman      | Ruth Nelson                   | Carol Whitesides               |
| Todd Christie                | Susan Hanson                 | Lori O'Connor                 | Zee Wiener                     |
| Damien Clancy                | Jessica Hecht                | Carol Ochs & Bruce MacVittie  | Ruth Ann Wynter                |
| Matthew Clancy               | & Adam Bernstein             | Jacki Ochs & Jan Kroeze       | J.P. Xenakis                   |
| Katie Clark                  | Kathy & Jamie Herring        | Kevin O'Rourke                | Carole Yass                    |
| Elizabeth Clemants           | Peter Herdrich & Karen Trott | & Edith Thurber               | Yildiz Yuksek                  |
| David Cohen                  | William Holtzman             | Jane Perlmutter               | & Richard Blackstone           |
| & Sandra Novak Cohen         | & S. Sylvia Shepard          | & Greg MacPherson             | Connie & Marc Zand             |
| Larry Cohen                  | Mary Horowitz                | Elizabeth Peters              |                                |

THE 52ND STREET PROJECT PRESENTS

PLAYS FROM THE COSTUME TRUNK

ARTWORK BY PATRICK JONES

**THE 2016 BLOCK ISLAND ONE-ON-ONES**

10 ADULT-WRITTEN PLAYS FEATURING  
KIDS AND ADULTS ON STAGE TOGETHER

Friday, July 22 @ 7:30 p.m.  
Saturday, July 23 @ 7:30 p.m.  
Sunday, July 24 @ 3:00 p.m.

**THE 52ND STREET PROJECT'S FIVE ANGELS THEATER**  
789 10th Avenue, between 52nd & 53rd Streets

# CLOTHES LINES: PLAYS FROM THE COSTUME TRUNK

The Annual Block Island One-on-Ones - July 22-24, 2016 at the Five Angels Theater

## The 52nd Street Project Staff

Gus Rogerson, Artistic Director  
 Natalie Hirsch, Associate Artistic Director  
 Garrett Kim, Program Director  
 George Babiak, Production Manager  
 Tim J. Lord, Technical Director

Carol Ochs, Executive Director  
 Tahnee Cadrez, Dev. & Mgmt. Associate  
 John Sheehy, Dir. of Development & Marketing  
 Shaunice Jordan, Mgr. of Individual Giving

Liz Bell, Director of Education  
 Johanna Vidal\*, Community Coordinator  
 Jennifer Jimenez\*, Day Receptionist

*\*Alumnae of The 52nd Street Project*

### Consultants

Iris A. Brown, Graphic Designer; Chris Ceraso, Teen Dean

### Interns

Haviland Atha-Simonton, Ian Edlund, Holly Gibbs, Emma Steiger

### Teen Employees

Receptionists: Britney Trinidad, Maria Martinez, and Makice Pacheco

Block Island Teen Counselor: Faisal Afridi

Ushers: Tatiana Goode, Wilhelmina Ohene Kari Kari, Ashley Thomas, Kristin Tetteh

## “CLOTHES LINES” Production Staff

### Composer/Music Director

Avi A. Amon

### Set Designer

Kevin Joseph Roach

### Lighting Designer

Josh Langman

### Lighting Programmer

Thomas Miller

### Costume Designer

Lara De Bruijn

### Goddess of Sound

Vanessa Valdes

### Stage Manager

Charles M. Turner III

### Projection Designs

George Babiak and The

52nd Street Project Projection Archive

### Prop Designs

George Babiak,  
 Haviland Atha-Simonton,  
 Holly Gibbs, and Emma Steiger

### Backstage Crew

Faisal Afridi, Haviland Atha-Simonton,  
 Ian Edlund, Holly Gibbs,  
 and Emma Steiger

### House Management

Carol Ochs, John Sheehy

### Flyer/Program Art

Patrick Jones

### Chefs

Martha Velie-Gass  
 and Pat Ritter

## COOL STUFF ON SALE IN THE LOBBY!

Fabulous Flyer Bars..... \$2.50  
*and featuring Shel Silverstein's "Fivey and Twoey" logo:*  
 Project Hoodies..... \$30.00  
 Project Caps ..... \$20.00  
 Project T-shirts.....\$12.00/\$20.00  
 Project Mugs..... \$5.00  
 Project Notebook ..... \$5.00  
 Project Pencil 3-pack.....\$1.00

Thank you for coming to CLOTHES LINES. If you are not on our mailing list, you can join on-line at [www.52project.org](http://www.52project.org). If you're interested in being a volunteer, fill out the form below and hand it to one of our staffers in the lobby.

### PLEASE PUT ME ON YOUR LIST:

07/16

NAME \_\_\_\_\_

ADDRESS \_\_\_\_\_

CITY \_\_\_\_\_

STATE \_\_\_\_\_

ZIP \_\_\_\_\_

HOME PHONE \_\_\_\_\_

DAYTIME OR MOBILE PHONE \_\_\_\_\_

E-MAIL ADDRESS \_\_\_\_\_

MY OCCUPATION \_\_\_\_\_

MY HOBBIES \_\_\_\_\_

WANT TO BE GREEN AND SAVE THE PROJECT MONEY ON POSTAGE?  
 CHECK THIS BOX TO RECEIVE OUR NOTICES EXCLUSIVELY VIA E-MAIL.

### YES, I WOULD LIKE TO BE OF HELP. I CAN:

- Help load in and out for shows
- Draw and/or paint
- Help kids with homework
- Hang lights
- Help with mailings
- Teach kids a skill
- Work on a backstage crew
- Do office work
- Be a chef at an event
- Do graphic design
- Design sound
- Design and sew costumes
- Other (please specify) \_\_\_\_\_

### MY SCHEDULE IS:

- Very flexible. I'm often available during weekdays.
- Somewhat flexible. I can help on the occasional morning or afternoon during the week.
- Not very flexible at all, but I've got some free time on evenings and weekends.

If you would like to mail this (and you're always welcome to enclose a tax-deductible contribution), you can send it to: The 52nd Street Project, 789 10th Avenue, New York, NY 10019. Or fax it to (212) 333-5598.



The One-on-One Program is made possible with public funds from The New York State Council on the Arts, a state agency, and the New York City Department of Cultural Affairs. This project is supported in part by an award from the National Endowment for the Arts. The 52nd Street Project is a member of Art/NY and Theatre Communications Group (TCG), the national organization for the American theatre.

## COME BACK NEXT MONTH FOR...

THE 52ND STREET PROJECT PRESENTS



ARTWORK BY PATRICK JONES

### THE 2016 WAREHAM, MASS. ONE-ON-ONES

10 ADULT-WRITTEN PLAYS FEATURING KIDS AND ADULTS ON STAGE TOGETHER

Friday, August 19 @ 7:30 p.m.

Saturday, August 20 @ 7:30 p.m.

Sunday, August 21 @ 3:00 p.m.

### THE 52ND STREET PROJECT'S FIVE ANGELS THEATER

789 10th Avenue, between 52nd & 53rd Streets

Admission is free, but reservations are encouraged! To reserve, visit [www.52project.org](http://www.52project.org)

## The 52nd Street Project Board of Directors

Lisa Benavides

Rachel Chanoff

Cathy Dantchik, co-chair

Carolyn DeSena

Wendy Ettinger, chair emeritus

Louis P. Friedman, co-chair

Alex Gersten-Vassilaros

Robert Goldberg

Stephen Graham, chair emeritus

Valerie Kay

Frances McDormand

Noël Mihalow

Carol Ochs

Willie Reale, founder

Gus Rogerson

Shirley Rumierk, alumni member

José Soto, Jr., alumni member

Merritt Tilney

Wendy vanden Heuvel

Mark Whatley

### What's Going On Here?

The 52nd Street Project is a non-profit organization that brings children from the Hell's Kitchen neighborhood together with professional theater artists to create original theater. CLOTHES LINES is a production of our One-on-One program, which is designed to give children the opportunity to go away for one-week stays in the country and enjoy the undivided attention of a professional theater artist who serves as friend, mentor, and collaborator.

### In-Kind Contributions

Abbeville Press; Alvin Ailey; American Dance Theater; Richard Anthony; Ars Nova; Lewis Black; Iris A. Brown Design; William Curran & A Curran Affair; Evercore Partners; Edie Falco; Jim & Jeannie Gaffigan; Google; ICI; Karen Kowgios of Fried & Kowgios; Erik Larson; Kathleen Madigan; The Marshal Restaurant; Noël Mihalow & Prime Films; Natasha, Pierre, and the Great Comet of 1812; Noho Hospitality Group; Lauren Friedman, Pharma/Omni Printing; The Public Theater; Winston Rodney Photography; Showtime; Jenny Steingart; TARA 4779; Robin Treadway; TV Land/Viacom Kids & Family; John A. Vassilaros & Sons; Watkins Inc.; Steve Olsen and the WestBank Cafe; and Paul, Rifkind, Wharton, & Garrison LLP.

### Special Thanks

Our Host Families- Allison and Michael Anderson; Kate and Sam Bird; Katy Homans and Patterson Sims; Susan Matheke and Willie Feuer; Amy and Elliot Nerenberg; Gladys and Bill Phillips; Susan and Ray Torrey; Virginia Dare; and our magnanimous headquarters host Carl Kaufmann. Sincere thanks to our chefs Martha Velie-Gass, Pat & Wayne Ritter; McQuade's Marketplace; Robbie Brown; Rita and Steve Draper; Kim Gaffett; Glenn and Annie Hall; The Yellow Kittens; Mark Helterline & Mary Jane Balsler and the Block Island Grocery; Susan, Peter and Mary MacGill; Block Island Realty, Littlefield & Sons Ltd, Bill Padien and the Old Post Office Bagel Shop.



### KEEP AN EYE OUT FOR INTERNS!

If you know of any college or graduate students who might enjoy working with us, playing with us, and going on trips with us for a semester, please have them contact Garrett Kim. We are especially looking for interns for Spring 2017.

## CLOTHES LINES: PLAYS FROM THE COSTUME TRUNK - ACT 1

All original music composed by Avi A. Amon  
*Clothes Lines Theme Song* lyrics by John Sheehy

### WALKING THE PLANK

By Jose Gamo for Gabriel Acevedo, age 10  
From the Costume Trunk: Classic Pirate

Matt..... Gabriel Acevedo  
Dylan ..... Jose Gamo  
Announcer ..... Holly Gibbs  
Swashbucklers ..... Faisal Alfridi, Ian Edlund, and Emma Steiger

*Sink Or Swim* lyrics by Jose Gamo.

### MOLAR OPPOSITES

By Tahnee Cadrez for Darby O'Donnell, age 12  
From the Costume Trunk: Leopard faux-fur coat

Tooth Fairy..... Darby O'Donnell  
Dental Pixie ..... Ka-Ling Cheung  
Sleeper ..... Ian Edlund

*A Toothsome Friendship* lyrics by Tahnee Cadrez.

### WARRIOR CODE

By Anne Troup for Angel Mendoza, age 10  
From the Costume Trunk: Medieval Knight

Dragon..... Angel Mendoza  
Vendor/Viking/Knight ..... Anne Troup  
Golden State Warrior ..... Ian Edlund

*What Could Be Better* lyrics by Anne Troup.

### TO BE AN ALIEN BODY BUILDER

By Charly Evon Simpson for Jayleen Velez, age 12  
From the Costume Trunk: Alien Body Builder

Nitra ..... Jayleen Velez  
Clover ..... Charly Evon Simpson  
Barkmani ..... Faisal Alfridi

*Don't Give Up* lyrics by Charly Evon Simpson.

### KRAKEN WISE

By John Sheehy for Andres Mendoza, age 10  
From the Costume Trunk: You will know it when you see it

Wayne ..... Andres Mendoza  
Chaz ..... John Sheehy

*The Superhero Inside* lyrics by John Sheehy.

## CLOTHES LINES: PLAYS FROM THE COSTUME TRUNK - ACT 2

### RETIREMENT

By Max Posner for Emmanuel Goicuria, age 12  
From the Costume Trunk: A purple graduation gown

Principal Dickens ..... Emmanuel Goicuria  
Timmy ..... Max Posner  
Dalton ..... George Babiak

*This Is Me On Mars* lyrics by Max Posner.

### TO MINE AND MINE NOT

By Tim J. Lord for Ahmed Abdelmeged, age 10  
From the Costume Trunk: A long ball gown with sequined shoulders.

Lefty ..... Ahmed Abdelmeged  
Pickens ..... Michael Propster  
Lauren ..... Emma Steiger

*What's Lost From Your Heart* lyrics by Tim J. Lord.

### REVENGE OF THE MONSTER HANDS

By Holly Hepp-Galvan for Beyonce Thomas, age 12  
From the Costume Trunk: Rubber monster hands

Pepper ..... Beyonce Thomas  
Marcy ..... Lucy DeVito  
Monsters ..... The Crew

*Sunrise Morning* lyrics by Holly Hepp-Galvan.

### EXTREME SURFING, SKYDIVING, ROCK STARS

#### WHO ARE ALSO ART THIEVES

By Jeff Cox for Gage Simmons, age 10  
From the Costume Trunk: Giraffe

Bobby Arizona ..... Gage Simmons  
Captain Reynolds/Toofar Mann ..... Sebastian Arroyo  
The Great Giraffe of Cameroon ..... Ian Edlund

*I'm Extreme* lyrics by Jeff Cox.

### KEEP CALM AND SNAPCHAT ME

By Stephanie Jean Lane for Selena Sanchez, age 11  
From the Costume Trunk: Combat fatigues

Mariah ..... Selena Sanchez  
Alex ..... Stephanie Jean Lane  
Soldiers/Volleyball Players ..... Ian Edlund and Emma Steiger

*Best Way* lyrics by Stephanie Jean Lane.

The 52nd Street Project gratefully acknowledges the support of the following foundations & corporations: The Altman Foundation; APA Talent & Literary Agency; BGC; Bull's Head Foundation, Inc.; Cantor Fitzgerald; Carnegie Corporation of New York; Maxine & Irving Castle Foundation; CBS Foundation, Inc.; City Winery; Consolidated Edison; Credit Suisse Securities (USA) LLC; Dawkins Family Foundation; Dramatists Guild Fund; Dramatists Play Service, Inc.; DTR Modern Galleries; Flexis Capital LLC; Friars National Foundation; Goldman Sachs; The Horace W. Goldsmith Foundation; Google; The Stephen P. Hanson Foundation; Heisman Trophy Trust; Lemle Pictures, Inc.; Live Nation Comedy; Frederick Loewe Foundation; LRS Designs, Inc.; Markel Corporation; Marusi Family Foundation; Newman's Own; Nickelodeon; Omnicom Group Inc.; Par Plumbing Co., Inc.; Pixar; Sawyer | Berson Architecture & Landscape Architecture; Morris & Alma Schapiro Fund; The Shubert Organization; The Stifler Family Foundation; Susquehanna Foundation, Corp.; Tax Pro Financial Network, Inc.; United Talent Agency; John A. Vassilaros & Sons, Inc.; The Vervone Foundation; West Bank Cafe; Yorke Construction Corp.; Zubatkin Owner Representation, LLC. (List current as of 8/18/2016)

Beth & Ray Abbott	Ingrid Ellen	Kim & Elliot Katz	Anita Rogerson
Robert Abrams	Gary Esayan	Mary Kong	Lynne Rosenberg
& Cynthia Vance	Peter Jay Fernandez	Henry Krieger	Laura & David Ross
George & Pam Ackert	& Denise Burse	Jan Kroeze & Jacki Ochs	Tatiana Rutkowski
Jeffrey Andreski	Anton Fig & Laura Sametz	Frances & Fred Langbecker	& Andrew Blackman
Richard Anthony & Avi Taussig	Lindsay Fram & Mason Pettit	William Lauch	Susan Sampliner
Dylan & Becky Baker	Karen & Paul Freitas	Maggie Lear	& Emily Grishman
Vishal Bakshi	Jon Friedland & Shaiza Rizavi	Justin Leavy	Brent Sarver
Eliza Baldi & David Costabile	Louis & Patrice Friedman	Cindy & Richard Leibovitch	Karin & Tom Schall
Jeff Bauml	Mark & Terri Friedman	David Long	Justin Schantz
Neena Beber	David Froelich	Edie Lutnick	David Schwab & Judy Kuhn
Richard Benn	& Cynthia Kaplan	Bruce MacVittie & Carol Ochs	Matthew & Curran Scoble
Craig Berggren	Sally Froelich	Julie & Alex Margolies	David Seidman
& Gavin Berger	Jennifer & Romolo Gabrielli	Elizabeth Marvel & Bill Camp	& Laura Valeroso
Elizabeth & Eric Berman	Jim & Jeannie Gaffigan	Stephen McDonnell	Amy & Alan Seifer
Philip Berney & Jane Pollock	Alexandra Garrison	& Jill Kearney McDonnell	Sylvia Shepard
Stephen Bernstein	Wayne & Pamela Garrison	Andre Meade & Tara Elwin	& Willy Holtzman
Lewis Black	Beverly Gasner	Victoria Melcher	Brian Shortt
Allison Blinken	Rose Gasner	Greg & Nyire Melconian	& Laura Konsin Shortt
Jane Bolster & Steve Wertimer	Scott Aaron & Laura Gewirtz	Yohan Minaya	William Shraga
Buzz Bovshow	Glen Gillen	Robert & Charlotte Morse	Robert Shwartz
Richard & Samantha Brand	& Michael Lawrence	Daryl & Michael Moss	Patterson Sims & Katy Homans
Iris Brown & Joe White	Kilty Gilmour	Suzen Murakoshi	Jeremy Smith
Carl Capotorto	Randy Ginsburg & Carole Yass	Elaine Musselman	John Smollen
Leah Carr	Christine Gleason	John & Kimberly Mustin	Stephen Sondheim
Lawrence Catena	& Erik Larson	Rachel & Paul Nadjarian	Jenny & Jon Steingart
Rachel Chanoff	Bruce Graham & Valerie Kay	Tim Blake Nelson	Tim Stephenson
Navin & Preeti Choksi	Tom Green	& Lisa Benavides	& Adriana Trigiani
Ellen Chopay	& Kristen Johanson	Randy & Rona Nelson	Bob Stockel
Katie & Kelly Clark	Susan Hanson	Ted Neustadt	Patty & David Straus
Joel Coen	Karen Hauser	& Becky Browder	Daniel Sussman & Beth Barry
& Frances McDormand	& Warren Leight	Evan Newmark & Ellen West	Jenni Swann
Robert Cohen	Ann & David Hausmann	Rachel & Larry Norton	Richard Sweren
& Danielle Mindess	Helen Hausmann	Lori O'Connor	Michael Tarnow
Brad Coley	Jessica Hecht	Beth & Bob Ollwerther	Mary Lou Teel
& Wendy vanden Heuvel	Peter & Eleni Henkel	Ty & Susan Olson	David Tewksbury
Penny Collins	Amy Herzig	F. Richard Pappas	Edith Thurber
Kevin Confoy	David Hillman & Lisa Cohen	Nicole Pellicciotto	& Kevin O'Rourke
Megan Cramer	Gary Horowitz & Alan Krevis	Jane Perlmutter	Fred Turpin
Billy Crudup	Alan Howard	& Greg Macpherson	Jan-Willem van den Dorpel
Cathy Dantchik	Ian Jackman	Elizabeth Peters	Tony Varni
Carolyn & Neil DeSena	Kristin Jaeger	Ben Posel & Jessica Bauman	Anna & Adam Vella
Marion & Alan Dienstag	Andrea Johnson	Sue Poulin	Gary Vogel
Andrew Douglass	Christa Justus	Steve Purtell	Mary Pat Walsh
Rick & Rebecca Dresser	& Mark Linn-Baker	Christopher Randolph	Mark & Vicki Whatley
Laurel Durst	Douglas M. Kaden	Willie Reale	Geof & Hilary Wills
Michaelene Durst	& Merritt Tilney	Nicholas Reiser	Morton Wolkowitz & Anita Keal
David & Chrysti Eigenberg	Patsy Kahn	Laura Rodgers	Jeffrey & Janine Yass

THE 52ND STREET PROJECT PRESENTS

ARTWORK BY PATRICK JONES

**PLAYS FROM THE COSTUME TRUNK 2**

**THE 2016 WAREHAM, MASS. ONE-ON-ONES**

10 ADULT-WRITTEN PLAYS FEATURING  
KIDS AND ADULTS ON STAGE TOGETHER

Friday, August 19 @ 7:30 p.m.  
Saturday, August 20 @ 7:30 p.m.  
Sunday, August 21 @ 3:00 p.m.

**THE 52ND STREET PROJECT'S FIVE ANGELS THEATER**

# CLOTHES LINES: PLAYS FROM THE COSTUME TRUNK 2

The Annual Wareham, Mass. One-on-Ones - Aug. 19-21, 2016 at the Five Angels Theater

## The 52nd Street Project Staff

Gus Rogerson, Artistic Director  
 Natalie Hirsch, Associate Artistic Director  
 Garrett Kim, Program Director  
 George Babiak, Production Manager  
 Tim J. Lord, Technical Director

Carol Ochs, Executive Director  
 Tahnee Cadrez, Dev. & Mgmt. Associate  
 John Sheehy, Dir. of Development & Marketing  
 Shaunice Jordan, Mgr. of Individual Giving

Liz Bell, Director of Education  
 Johanna Vidal\*, Community Coordinator  
 Tiara Varela\*, Day Receptionist

*\*Alumnae of The 52nd Street Project*

### Consultants

Iris A. Brown, Graphic Designer; Chris Ceraso, Teen Dean

### Interns

Haviland Atha-Simonton, Ian Edlund, Holly Gibbs, Emma Steiger

### Teen Employees

Receptionists: Britney Trinidad, Maria Martinez, and Makice Pacheco  
 Block Island Teen Counselor: Britney Trinidad  
 Ushers: Jasmine Correa, Kayla Ortiz, Makice Pacheco, Chayse Peña, Kristin Tetteh

## “CLOTHES LINES” Production Staff

### Composer/Music Director

Kim D. Sherman

### Set Designer

Kevin Joseph Roach

### Lighting Designer

Greg MacPherson

### Lighting Programmer

Thomas Miller

### Costume Designer

Lily Prentice

### Siren of Sound

Johanna Vidal

### Stage Manager

Amanda Tralle

### Projection Designs

George Babiak and The  
 52nd Street Project Projection Archive

### Prop Designs

George Babiak,  
 Haviland Atha-Simonton,  
 Holly Gibbs, and Emma Steiger

### Backstage Crew

Haviland Atha-Simonton,  
 Ian Edlund, Holly Gibbs,  
 Emma Steiger, and Britney Trinidad

### House Management

Carol Ochs, John Sheehy

### Flyer/Program Art

Patrick Jones

### Chefs

John Sheehy, Liz Bell,  
 and Carol Ochs

## COOL STUFF ON SALE IN THE LOBBY!

Fabulous Flyer Bars..... \$2.50  
*and featuring Shel Silverstein's "Fivey and Twoey" logo:*  
 Project Hoodies..... \$30.00  
 Project Caps ..... \$20.00  
 Project T-shirts.....\$12.00/\$20.00  
 Project Mugs..... \$5.00  
 Project Notebook ..... \$5.00  
 Project Pencil 3-pack.....\$1.00

Thank you for coming to CLOTHES LINES. If you are not on our mailing list, you can join on-line at [www.52project.org](http://www.52project.org). If you're interested in being a volunteer, fill out the form below and hand it to one of our staffers in the lobby.

### PLEASE PUT ME ON YOUR LIST:

08/16

NAME \_\_\_\_\_

ADDRESS \_\_\_\_\_

CITY \_\_\_\_\_

STATE \_\_\_\_\_

ZIP \_\_\_\_\_

HOME PHONE \_\_\_\_\_

DAYTIME OR MOBILE PHONE \_\_\_\_\_

E-MAIL ADDRESS \_\_\_\_\_

MY OCCUPATION \_\_\_\_\_

MY HOBBIES \_\_\_\_\_

WANT TO BE GREEN AND SAVE THE PROJECT MONEY ON POSTAGE?  
 CHECK THIS BOX TO RECEIVE OUR NOTICES EXCLUSIVELY VIA E-MAIL.

### YES, I WOULD LIKE TO BE OF HELP. I CAN:

- Help load in and out for shows
- Draw and/or paint
- Help kids with homework
- Hang lights
- Help with mailings
- Teach kids a skill
- Work on a backstage crew
- Do office work
- Be a chef at an event
- Do graphic design
- Design sound
- Design and sew costumes
- Other (please specify) \_\_\_\_\_

### MY SCHEDULE IS:

- Very flexible. I'm often available during weekdays.
- Somewhat flexible. I can help on the occasional morning or afternoon during the week.
- Not very flexible at all, but I've got some free time on evenings and weekends.

If you would like to mail this (and you're always welcome to enclose a tax-deductible contribution), you can send it to: The 52nd Street Project, 789 10th Avenue, New York, NY 10019. Or fax it to (212) 333-5598.



The One-on-One Program is made possible with public funds from The New York State Council on the Arts, a state agency, and the New York City Department of Cultural Affairs. This project is supported in part by an award from the National Endowment for the Arts. The 52nd Street Project is a member of Art/NY and Theatre Communications Group (TCG), the national organization for the American theatre.



COMING UP AT THE PROJECT...

# PLAYBACK THROWBACK

## THE 2016 PLAYBACK PLAYS

The reverse of the One-on-Ones!  
Kids write plays for themselves and an  
adult partner to perform together.

This year's theme asks each kid to take a  
character, theme, or memory from his or her  
Project past and expand it into a play.

October 21-23 right here at  
**THE FIVE ANGELS THEATER**



### KEEP AN EYE OUT FOR INTERNS!

If you know of any college or graduate students who might enjoy working with us, playing with us, and going on trips with us for a semester, please have them contact Garrett Kim. We are especially looking for interns for Spring 2017.

### The 52nd Street Project Board of Directors

Lisa Benavides	Frances McDormand
Rachel Chanoff	Noël Mihalow
Cathy Dantchik, co-chair	Carol Ochs
Carolyn DeSena	Willie Reale, founder
Wendy Ettinger, chair emeritus	Gus Rogerson
Louis P. Friedman, co-chair	Shirley Rumierk, alumni member
Alex Gersten-Vassilaros	José Soto, Jr., alumni member
Robert Goldberg	Merritt Tilney
Stephen Graham, chair emeritus	Wendy vanden Heuvel
Valerie Kay	Mark Whatley

### What's Going On Here?

The 52nd Street Project is a non-profit organization that brings children from the Hell's Kitchen neighborhood together with professional theater artists to create original theater. **CLOTHES LINES** is a production of our One-on-One program, which is designed to give children the opportunity to go away for one-week stays in the country and enjoy the undivided attention of a professional theater artist who serves as friend, mentor, and collaborator.

### In-Kind Contributions

Abbeville Press; Alvin Ailey; American Dance Theater; Richard Anthony; Ars Nova; Lewis Black; Iris A. Brown Design; William Curran & A Curran Affair; Evercore Partners; Edie Falco; Jim & Jeannie Gaffigan; Google; ICI; Karen Kowgios of Fried & Kowgios; Erik Larson; Kathleen Madigan; The Marshal Restaurant; Noel Mihalow & Prime Films; Natasha, Pierre, and the Great Comet of 1812; Noho Hospitality Group; Lauren Friedman, Pharma/Omni Printing; The Public Theater; Winston Rodney Photography; Showtime; Jenny Steingart; TARA 4779; Robin Treadway; TV Land/Viacom Kids & Family; John A. Vassilaros & Sons; Watkins Inc.; Steve Olsen and the WestBank Cafe; and Paul, Rifkind, Wharton, & Garrison LLP.

### Special Thanks

Our Host Families- Peter, Helen & Christopher Randolph; Lucy Aptekar & Gerry Leader; Andrea & Emmanuel Daskalakis; Kathy & Jamie Herring; Sam & Gerry Gray; Joe McNay; Gray & Rosemary Watson. Thank you also to Robin Morse; Lucy & Francis Rogerson; Vanessa Valdes; & Bob Krystolfolski.

## CLOTHES LINES: PLAYS FROM THE COSTUME TRUNK 2 - ACT 1

All original music composed by Kim D. Sherman, except where noted\*  
*Clothes Lines 2 Theme Song* lyrics by John Sheehy

### THE STAR SPANGLED JOKESTER

Written by Lynn Rosen for Rebecca Jimenez, age 10. Directed by Tina Chilip  
From the Costume Trunk: A red-white-and-blue superhero uniform.

Rosie ..... Rebecca Jimenez  
Pat ..... Tina Chilip  
MC Cupcake ..... Holly Gibbs

*A Not So Funny Feeling* lyrics by Lynn Rosen

### THE BILLIONAIRE BIRTHDAY

Written by Patrick Link for Nathaniel Ortiz, age 12. Directed by Gardiner Comfort  
From the Costume Trunk: A pink, sequined ball gown.

TJ ..... Nathaniel Ortiz  
The Voice/Stevens ..... Gardiner Comfort

*Something Real* lyrics by Patrick Link

### MAGICIANATION

Written and Directed by Marisol Miranda for Yovely Ramirez, age 10  
From the Costume Trunk: A light blue embroidered pantsuit.

Willa ..... Yovely Ramirez  
Anna ..... Marisol Miranda

*Wouldn't Have To* and *Sorry Song* lyrics by Marisol Miranda

### THE DR. MARK SHOW

Written and Directed by Jedidiah Clarke for Coleman Williams, age 11  
From the Costume Trunk: Old-time prison stripes.

Dr. Mark ..... Coleman Williams  
Ken ..... Jedidiah Clarke  
Stage Manager ..... Holly Gibbs  
The Dr. Mark Dancers ..... Ian Edlund and Emma Steiger  
Bluebird Bandit ..... Tim J. Lord

*The Dr. Mark Theme Song* and *What Have We Learned/End Theme* lyrics by  
Jedidiah Clarke

### A THRILLING TALE OF THE SEA

Written and Directed by George Babiak for Bryanna Ohene Kari Kari, age 11  
From the Costume Trunk: Silver platform disco boots.

Captain Amy ..... Bryanna Ohene Kari Kari  
Fred ..... George Babiak  
Crew ..... Haviland Atha-Simonton, Ian Edlund,  
Emma Steiger, Britney Trinidad,

Pinky Peg ..... Holly Gibbs

*Sweet Revenge* lyrics by George Babiak

## CLOTHES LINES: PLAYS FROM THE COSTUME TRUNK 2 - ACT 2

### TWO BRAVE FRIENDS

Written and Directed by Arielle Goldman for Magalis Fábian Vinas, age 12  
From the Costume Trunk: An Australian bushranger's topcoat.

Roo ..... Magalis Fábian Vinas  
Le Tigre ..... Arielle Goldman  
Bounty Jack ..... George Babiak  
Roo's Mom ..... Britney Trinidad

*Use Your Voice* lyrics by Arielle Goldman

### THE BEAT

Written and Directed by José-Maria Aguila for Ethan Perez, age 12  
From the Costume Trunk: A cheerleader's uniform.

Barry Steel ..... Ethan Perez  
Action Jones ..... José-Maria Aguila  
Police Chief (Sarge) ..... Britney Trinidad  
Zebra-Ninja ..... Holly Gibbs

*So Different, So Strange* lyrics by José-Maria Aguila

### AT HEAVEN'S GATE

Written by Tahnee Cadrez for Thiana Goode, age 11.  
Directed by Haviland Atha-Simonton

From the Costume Trunk: An enormous green-and-black wildly patterned cloak.

Beth ..... Thiana Goode  
Fiona ..... Haviland Atha-Simonton  
Lara ..... Holly Gibbs  
Angels 1, 2, & 3 ..... Britney Trinidad, Emma Steiger, Ian Edlund  
Human ..... Ian Edlund

*This Is My Story* lyrics by Tahnee Cadrez

### MOVE ON, TIGER

Written by Cynthia Kaplan for Derek Rey, age 12. Directed by Sam Lilja  
From the Costume Trunk: An orange-and-black peasant dress.

Roger ..... Derek Rey  
Paul ..... Sam Lilja  
Madame Lefreedge ..... John Sheehy  
Audience Members/Elephants ..... Britney Trinidad  
Two Elephants ..... Britney Trinidad, Ian Edlund

*Ballad of Lefreedge*\* music & lyrics by Cynthia Kaplan

### SWEET AND SLOW

Written by Madeleine George for Lovely Ramirez, age 10. Directed by Erin Felgar  
From the Costume Trunk: A giant chocolate chip cookie.

Dr. Yadira Garcia ..... Lovely Ramirez  
Dr. Cassie Bemelman/Cookie Crunch ..... Erin Felgar

*From Scratch* lyrics by Madeleine George

The 52nd Street Project gratefully acknowledges the support of the following foundations & corporations: The Altman Foundation; APA Talent & Literary Agency; BGC; Bull's Head Foundation, Inc.; Cantor Fitzgerald; Carnegie Corporation of New York; Maxine & Irving Castle Foundation; CBS Foundation, Inc.; City Winery; Consolidated Edison; Credit Suisse Securities (USA) LLC; Dawkins Family Foundation; Dramatists Guild Fund; Dramatists Play Service, Inc.; DTR Modern Galleries; Flexis Capital LLC; Friars National Foundation; Goldman Sachs; The Horace W. Goldsmith Foundation; Google; The Stephen P. Hanson Foundation; Heisman Trophy Trust; Lemle Pictures, Inc.; Live Nation Comedy; Frederick Loewe Foundation; LRS Designs, Inc.; Markel Corporation; Marusi Family Foundation; Newman's Own; Nickelodeon; Omnicom Group Inc.; Par Plumbing Co., Inc.; Pixar; Sawyer | Berson Architecture & Landscape Architecture; Morris & Alma Schapiro Fund; The Shubert Organization; The Stiffer Family Foundation; Susquehanna Foundation, Corp.; Tax Pro Financial Network, Inc.; United Talent Agency; John A. Vassilaros & Sons, Inc.; The Vervane Foundation; West Bank Cafe; Yorke Construction Corp.; Zubatkin Owner Representation, LLC. (List current as of 8/18/2016)

Beth & Ray Abbott	Ingrid Ellen	Kim & Elliot Katz	Anita Rogerson
Robert Abrams	Gary Esayian	Mary Kong	Lynne Rosenberg
& Cynthia Vance	Peter Jay Fernandez	Henry Krieger	Laura & David Ross
George & Pam Ackert	& Denise Burse	Jan Kroeze & Jacki Ochs	Tatiana Rutkowski
Jeffrey Andreski	Anton Fig & Laura Sametz	Frances & Fred Langbecker	& Andrew Blackman
Richard Anthony & Avi Taussig	Lindsay Fram & Mason Pettit	William Lauch	Susan Sampliner
Dylan & Becky Baker	Karen & Paul Freitas	Maggie Lear	& Emily Grishman
Vishal Bakshi	Jon Friedland & Shaiza Rizavi	Justin Leavy	Brent Sarver
Eliza Baldi & David Costabile	Louis & Patrice Friedman	Cindy & Richard Leibovitch	Karin & Tom Schall
Jeff Bauml	Mark & Terri Friedman	David Long	Justin Schantz
Neena Beber	David Froelich	Edie Lutnick	David Schwab & Judy Kuhn
Richard Benn	& Cynthia Kaplan	Bruce MacVittie & Carol Ochs	Matthew & Curran Scoble
Craig Berggren	Sally Froelich	Julie & Alex Margolies	David Seidman
& Gavin Berger	Jennifer & Romolo Gabrielli	Elizabeth Marvel & Bill Camp	& Laura Valeroso
Elizabeth & Eric Berman	Jim & Jeannie Gaffigan	Stephen McDonnell	Amy & Alan Seifer
Philip Berney & Jane Pollock	Alexandra Garrison	& Jill Kearney McDonnell	Sylvia Shepard
Stephen Bernstein	Wayne & Pamela Garrison	Andre Meade & Tara Elwin	& Willy Holtzman
Lewis Black	Beverly Gasner	Victoria Melcher	Brian Shortt
Allison Blinken	Rose Gasner	Greg & Nyire Melconian	& Laura Konsin Shortt
Jane Bolster & Steve Wertimer	Scott Aaron & Laura Gewirtz	Yohan Minaya	William Shraga
Buzz Bovshow	Glen Gillen	Robert & Charlotte Morse	Robert Shwartz
Richard & Samantha Brand	& Michael Lawrence	Daryl & Michael Moss	Patterson Sims & Katy Homans
Iris Brown & Joe White	Kilty Gilmour	Suzen Murakoshi	Jeremy Smith
Carl Capotorto	Randy Ginsburg & Carole Yass	Elaine Musselman	John Smollen
Leah Carr	Christine Gleason	John & Kimberly Mustin	Stephen Sondheim
Lawrence Catena	& Erik Larson	Rachel & Paul Nadjarian	Jenny & Jon Steingart
Rachel Chanoff	Bruce Graham & Valerie Kay	Tim Blake Nelson	Tim Stephenson
Navin & Preeti Choksi	Tom Green	& Lisa Benavides	& Adriana Trigiani
Ellen Chopay	& Kristen Johanson	Randy & Rona Nelson	Bob Stockel
Katie & Kelly Clark	Susan Hanson	Ted Neustadt	Patty & David Straus
Joel Coen	Karen Hauser	& Becky Browder	Daniel Sussman & Beth Barry
& Frances McDormand	& Warren Leight	Evan Newmark & Ellen West	Jenni Swan
Robert Cohen	Ann & David Hausmann	Rachel & Larry Norton	Richard Sweren
& Danielle Mindess	Helen Hausmann	Lori O'Connor	Michael Tarnow
Brad Coley	Jessica Hecht	Beth & Bob Ollwerther	Mary Lou Teel
& Wendy vanden Heuvel	Peter & Eleni Henkel	Ty & Susan Olson	David Tewksbury
Penny Collins	Amy Herzig	F. Richard Pappas	Edith Thurber
Kevin Confoy	David Hillman & Lisa Cohen	Nicole Pellicciotto	& Kevin O'Rourke
Megan Cramer	Gary Horowitz & Alan Krevis	Jane Perlmutter	Fred Turpin
Billy Crudup	Alan Howard	& Greg Macpherson	Jan-Willem van den Dorpel
Cathy Dantchik	Ian Jackman	Elizabeth Peters	Tony Varni
Carolyn & Neil DeSena	Kristin Jaeger	Ben Posel & Jessica Bauman	Anna & Adam Vella
Marion & Alan Dienstag	Andrea Johnson	Sue Poulin	Gary Vogel
Andrew Douglass	Christa Justus	Steve Purtell	Mary Pat Walsh
Rick & Rebecca Dresser	& Mark Linn-Baker	Christopher Randolph	Mark & Vicki Whatley
Laurel Durst	Douglas M. Kaden	Willie Reale	Geof & Hilary Wills
Michaelene Durst	& Merritt Tilney	Nicholas Reiser	Morton Wolkowitz & Anita Keal
David & Chrysti Eigenberg	Patsy Kahn	Laura Rodgers	Jeffrey & Janine Yass

THE 52ND STREET PROJECT PRESENTS

# REPRISE AND SHINE



THE THROWBACK PLAYS  
The 2016 Playback Shows

# Reprise and Shine: The Throwback Plays

Playback 2016 - Oct. 21-23, Five Angels Theater

## The 52nd Street Project Staff

Gus Rogerson, Artistic Director	Carol Ochs, Executive Director
Natalie Hirsch, Associate Artistic Director	John Sheehy, Director of Institutional Advancement
Garrett Kim, Program Director	
George Babiak, Production Manager	Liz Bell, Director of Education
Tim J. Lord, Technical Director	Johanna Vidal*, Community Coordinator
	Yazzy Wilder*, Office Manager

*\*Alumnae of The 52nd Street Project*

### Consultants

Iris A. Brown, Graphic Designer; Chris Ceraso, Teen Dean

### Interns

Julio Chavez, Allison Fifield, Michelle Taliento, James Wade

### Teen Employees

Receptionists: Britney Trinidad, Maria Martinez, Chayse Peña, and Makice Pacheco  
Ushers: Britney Trinidad, Jasmine Correa, Daniel Martinez, Eric Carrero

## “REPRIS AND SHINE” Production Staff

### Composer/Music Director

Ben Moss

### Set Designer

Kevin Joseph Roach

### Lighting Designer

Greg MacPherson

### Costume Designer

Siena Zoë Allen

### Sound Designer/Operator

Aiden Dreskin

### Stage Manager

John Sheehy

### Projection Designs

George Babiak and The  
52nd Street Project Projection Archive

### Prop Designs

George Babiak,  
Julio Chavez, James Wade

### Backstage Crew

Julio Chavez, Allison Fifield,  
Valeria Oliva, Michelle Taliento,  
James Wade

### House Management

Carol Ochs, John Sheehy

### Flyer/Program Art

Deborah Gaffaney

### Weekend-Away Chefs

John Sheehy, Liz Bell,  
and Carol Ochs

## COOL STUFF ON SALE IN THE LOBBY!

Fabulous Flyer Bars..... \$2.50  
*and featuring Shel Silverstein's "Fivey and Twoey" logo:*  
Project Hoodies..... \$30.00  
Project Caps ..... \$20.00  
Project T-shirts.....\$12.00/\$20.00  
Project Mugs..... \$5.00  
Project Notebook ..... \$5.00  
Project Pencil 3-pack.....\$1.00

Thank you for coming to **REPRIS AND SHINE**. If you are not on our mailing list, you can join on-line at [www.52project.org](http://www.52project.org). If you're interested in being a volunteer, fill out the form below and hand it to one of our staffers in the lobby.

### PLEASE PUT ME ON YOUR LIST:

10/16

NAME \_\_\_\_\_

ADDRESS \_\_\_\_\_

CITY \_\_\_\_\_

STATE \_\_\_\_\_

ZIP \_\_\_\_\_

HOME PHONE \_\_\_\_\_

DAYTIME OR MOBILE PHONE \_\_\_\_\_

E-MAIL ADDRESS \_\_\_\_\_

MY OCCUPATION \_\_\_\_\_

MY HOBBIES \_\_\_\_\_

WANT TO BE GREEN AND SAVE THE PROJECT MONEY ON POSTAGE?  
CHECK THIS BOX TO RECEIVE OUR NOTICES EXCLUSIVELY VIA E-MAIL.

### YES, I WOULD LIKE TO BE OF HELP. I CAN:

- |   |   |  |
|---|---|--|
| <input type="checkbox"/> Help load in and out for shows | <input type="checkbox"/> Draw and/or paint  | <input type="checkbox"/> Help kids with homework |
| <input type="checkbox"/> Hang lights                    | <input type="checkbox"/> Help with mailings | <input type="checkbox"/> Teach kids a skill      |
| <input type="checkbox"/> Work on a backstage crew       | <input type="checkbox"/> Do office work     | <input type="checkbox"/> Be a chef at an event   |
| <input type="checkbox"/> Do graphic design              | <input type="checkbox"/> Design sound       | <input type="checkbox"/> Design and sew costumes |
| <input type="checkbox"/> Other (please specify) _____   |   |  |

### MY SCHEDULE IS:

- Very flexible. I'm often available during weekdays.  
 Somewhat flexible. I can help on the occasional morning or afternoon during the week.  
 Not very flexible at all, but I've got some free time on evenings and weekends.

If you would like to mail this (and you're always welcome to enclose a tax-deductible contribution), you can send it to: The 52nd Street Project, 789 10th Avenue, New York, NY 10019. Or fax it to (212) 333-5598.



The Playback Program is made possible with public funds from the New York State Council on the Arts with the support of Governor Andrew M. Cuomo and the New York State Legislature, and the New York City Department of Cultural Affairs. This project is supported in part by an award from the National Endowment for the Arts. The 52nd Street Project is a member of Art/NY and Theatre Communications Group (TCG), the national organization for the American theatre.

**COMING UP SOON AT THE PROJECT!**

**THE 52ND STREET PROJECT**



Come see what kids can do when they team up with adult professional performers!

Friday, Oct. 28  
at 7:30 p.m.

COME TO THE 4TH ANNUAL  
**BIG KIDS BASH**

AN EVENING OF

**FUN & GAMES**

AT THE WINERY AT CITY WINERY

A BENEFIT SUPPORTING  
THE KIDS OF  
THE 52ND STREET PROJECT

WEDNESDAY, NOV. 9TH  
AT 7:00 P.M.  
155 VARICK ST.

FOR INFORMATION CONTACT JOHN SHEEHY AT  
(212) 333-5252 OR SHEEHY@52PROJECT.ORG

**INFINITY  
AND BEYOND  
THE ULTIMATE PLAYS**

**THE FALL 2016 PLAYMAKING SHOW**

10 all-new ten-year old kids write plays  
for adult professional actors to perform.

December 2-4 right here at the Five Angels Theater.

**The 52nd Street Project Board of Directors**

Lisa Benavides	Frances McDormand
Rachel Chanoff	Noël Mihalow
Cathy Dantchik, co-chair	Carol Ochs
Carolyn DeSena	Willie Reale, founder
Wendy Ettinger, chair emeritus	Gus Rogerson
Louis P. Friedman, co-chair	Shirley Rumierk, alumni member
Alex Gersten-Vassilaros	José Soto, Jr., alumni member
Robert Goldberg	Merritt Tilney
Stephen Graham, chair emeritus	Wendy vanden Heuvel
Valerie Kay	Mark Whately

**What's Going On Here?**

The 52nd Street Project is a non-profit organization that brings children from the Hell's Kitchen neighborhood together with professional theater artists to create original theater. REPRISE AND SHINE is a production of our Playback program, in which kid actor/playwrights write plays for themselves and adult actor/director partners. Everyone ventured to the Hamptons for a rehearsal retreat over the Columbus Day weekend. All of the kids involved are veterans of the Playmaking classes which were adapted for the Project by Daniel Judah Sklar from his book *Playmaking: Children Writing and Performing Their Own Plays*.

**In-Kind Contributions**

Abbeville Press; Alvin Ailey; American Dance Theater; Richard Anthony; Ars Nova; Lewis Black; Iris A. Brown Design; William Curran & A Curran Affair; Evercore Partners; Edie Falco; Jim & Jeannie Gaffigan; Google; ICI; Karen Kowgios of Fried & Kowgios; Erik Larson; Kathleen Madigan; The Marshal Restaurant; Noel Mihalow & Prime Films; Natasha, Pierre, and the Great Comet of 1812; Noho Hospitality Group; Lauren Friedman, Pharma/Omni Printing; The Public Theater; Winston Rodney Photography; Showtime; Jenny Steingart; TARA 4779; Robin Treadway; TV Land/Viacom Kids & Family; John A. Vassilaros & Sons; Watkins Inc.; Steve Olsen and the WestBank Cafe; and Paul, Rifkind, Wharton, & Garrison LLP.

**Special Thanks**

We're extremely grateful to board member Alex Gersten-Vassilaros for allowing us to use her family's home as our headquarters on our rehearsal trip to the Hamptons. Huge thanks also go to Board Co-Chair Louis Friedman and his wife Patrice Friedman for hosting some adults, and to our other Co-Chair, Cathy Dantchik, who hosted our girls and even more adults at her beautiful new house in Bridgehampton.

# Reprise and Shine - Act 1

All original music composed by Ben Moss

## WAR, INC.

Written by Aramis Jimenez, age 12

Director/Dramaturge: Garrett Kim

Agent of the Universe ..... Aramis Jimenez  
 War Keeper ..... Garrett Kim  
 Jessica ..... Michelle Taliento  
 Agent 23 ..... George Babiak

*It's Been a Long Time* lyrics by Aramis Jimenez

## TEMPLE OF YOUTH AND BEAUTY

Written by Kiara Figueroa, age 13

Director/Dramaturge: Kerry Warren

George ..... Kiara Figueroa  
 Blobina ..... Kerry Warren  
 Mermaids ..... Valeria Oliva and Allison Fifield  
 Guards ..... James Wade and Michelle Taliento

*Youth and Beautiful* lyrics by Kiara Figueroa

## CRAZY MIRACLES

Written by Sebastian Lopez, age 13

Director/Dramaturge: Vichet Chum

J. Loud ..... Sebastian Lopez  
 Dan ..... Vichet Chum  
 Jack ..... James Wade

*The Conflict* lyrics by Sebastian Lopez

## THE SECRET BOX

Written by Kaylee Zambrano, age 13

Director/Dramaturge: Grace Rex

Ani ..... Kaylee Zambrano  
 Mary ..... Grace Rex  
 Teacher ..... Michelle Taliento  
 Dance Students ..... Allison Fifield, Julio Chavez  
 Casting Person ..... James Wade

*I Am Brave* lyrics by Kaylee Zambrano



# Reprise and Shine - Act 2

## CONNECT THE DOTS

Written by Jayla Alvarez, age 13

Director/Dramaturge: Danaya Esperanza

Megan ..... Jayla Alvarez  
 Zulu ..... Danaya Esperanza  
 Brian the Rat ..... James Wade  
 Taylor the Snake/Cash Register ..... Valeria Oliva

*I'm Not Her Mother* lyrics by Jayla Alvarez

## FIN

Written by Milen Tokarev, age 13

Director/Dramaturge: Stephen Stocking

Pierre "Maple" Poutine ..... Milen Tokarev  
 Jean Luc ..... Stephen Stocking  
 Voice of Fake ..... George Babiak

*Sante Fe ft. Dr. Dre* lyrics by Milen Tokarev

## BACKPACKING THROUGH SOSTCO

Written by Rebecca Gomez, age 13

Director/Dramaturge: Amber Avant

Jackie the Jacket ..... Rebecca Gomez  
 Benny the Backpack ..... Amber Avant

*Alone in New Spaces* lyrics by Rebecca Gomez

## THE COLD CATASTROPHE

Written by Ethan Zenteno, age 12

Director/Dramaturge: Marchant Davis

Charlie ..... Ethan Zenteno  
 Francis ..... Marchant Davis

*The Decision* lyrics by Ethan Zenteno





The 52nd Street Project is a non-profit community-based arts organization that brings children from the Hell's Kitchen neighborhood together with professional artists to create original art. The Songmaking program partners three 52nd Street Project kids with adult composers to create original songs. Over the six weeks of Songmaking, led by Avi Amon and Program Director Garrett Kim, these young lyricists explore how their own words and ideas fit together with their composer's music to create songs. Near the end of the program, we bring in a company of singers to perform the completed songs, and share them with an audience.

**The 52nd Street Project Staff**

Gus Rogerson, Artistic Director	Carol Ochs, Executive Director
Natalie Hirsch, Associate Artistic Director	John Sheehy, Director of Institutional Advancement
Garrett Kim, Program Director	Liz Bell, Director of Education
George Babiak, Production Manager	Johanna Vidal*, Community Coordinator
Tim J. Lord, Technical Director	Yazzy Wilder*, Office Manager

*\*Alumnae of The 52nd Street Project*

**Consultants**

Iris A. Brown, Graphic Designer; Chris Ceraso, Teen Dean

**Interns**

Julio Chavez, Allison Fifield, Michelle Taliento, James Wade

**Teen Employees**

Receptionists: Britney Trinidad, Maria Martinez, Chayse Peña, and Makice Pacheco

**The 52nd Street Project Board of Directors**

Lisa Benavides	Frances McDormand
Rachel Chanoff	Noël Mihalow
Cathy Dantchik, co-chair	Carol Ochs
Carolyn DeSena	Willie Reale, founder
Wendy Ettinger, chair emeritus	Gus Rogerson
Louis P. Friedman, co-chair	Shirley Rumierk, alumni member
Alex Gersten-Vassilaros	José Soto, Jr., alumni member
Robert Goldberg	Merritt Tilney
Stephen Graham, chair emeritus	Wendy vanden Heuvel
Valerie Kay	Mark Whatley



PRESENTS



Featuring 9 original songs written by kids and composed and performed by adult musicians and singers.

Songmaking Directors:  
Avi Amon and Garrett Kim

Friday, October 28, 2016  
7:30 p.m.

The Five Angels Theater  
The 52nd Street Project  
789 10th Avenue

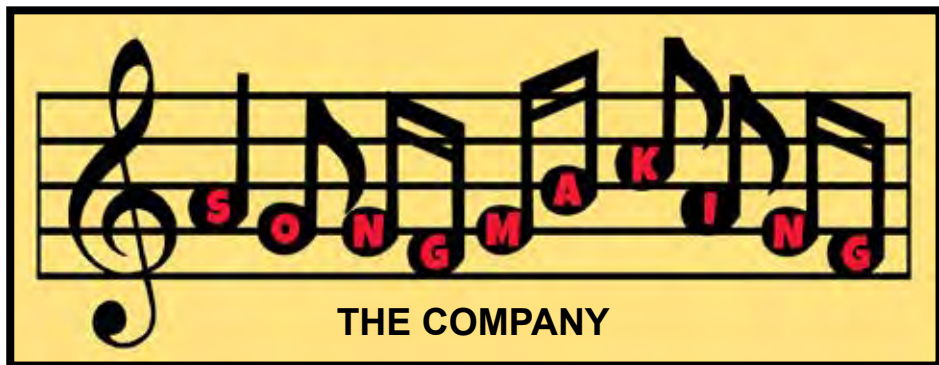

**The Lyricists**  
 Sabrina Caldonia  
 Ricardo Currin  
 Rosneyri Rosario

**The Composers and Musicians**  
 Wesley Brandt  
 Rachel Dean  
 Danny Ursetti

**The Singers**  
 Lilli Cooper  
 Andy Danh  
 Kendal Hartse  
 Korey Jackson  
 Tim Jerome  
 Stephanie McKay  
 Lauren Patten

**Lighting**  
 Tim Lord

**Sound**  
 Matt Hubbs

**Special Thanks**

The Songmaking Program has been established in collaboration with Sarah Schlesinger, Fred Carl, and Julianne Wick Davis and the NYU Tisch School of the Arts Music Theater Writing Program.



The Songmaking Program is made possible with public funds from the New York State Council on the Arts with the support of Governor Andrew M. Cuomo and the New York State Legislature, and the New York City Department of Cultural Affairs. This project is supported in part by an award from the National Endowment for the Arts. The 52nd Street Project is a member of Art/NY and Theatre Communications Group (TCG), the national organization for the American theatre.

So he decided that he was going to win.

**KING**  
 I won!

**PEASANT**  
 That's not fair!  
 I had the better dance moves.  
 I deserve it all!

**KING**  
 Well, too bad!  
 I'm the King  
 So you can't do anything about it.

**NARRATOR**  
 But the King notices that it wasn't fair  
 He didn't want to be the bad guy  
 So he decided to share.  
 He shared the ice cream & money with the peasant

The peasant felt happy!  
 Because everything was alright,  
 And they both won

They both ended up winning  
 And the King wasn't a bad guy  
 He was a leader



**"No Name"**  
 Lyrics by Rosneyri Rosario  
 Music by Rachel Dean  
 Sung by Lauren Patten

It was just five minutes ago,  
 And I wish I could be a frog  
 It looks so happy just hopping on my leaves  
 Able to go through the fog.

I wish I could be a frog  
 Going to different places  
 Looking at different faces.

But my family I will miss them  
 If I go they'll be so lonely  
 And the frogs, I wish I could be them  
 But I could be a frog

I get so cold in the winter  
 I get sad when my leaves start to fall,  
 When the temperature changes

When Autumn comes,  
 All of my true colors start to fall,  
 Is what I hate the most

I wish I could be a frog  
 Going to different places  
 Looking at different faces

I wish I could be a frog  
 Going to different places  
 Looking at different faces

I want to be a frog  
 Because it looks so happy  
 It gets to travel anywhere it wants

I want to be a frog  
 Because it hops around  
 It gets to travel anywhere it wants

I wish I could be a frog  
 Going to different places  
 Looking at different faces

I wish I could be a frog  
 Going to different places  
 Looking at different faces

Going to different places  
 Looking at different faces





The Legend is true  
 The Dancing Ice Ballerina isn't on the island  
 But her soul is.  
 I look at Macky again  
 And for a split second  
 Its eyes glow  
 It's the Dancing Ice Ballerina  
 I just know it  
 Her soul is in Macky  
 Her soul is in Macky



**“Will Things Change?”**

Lyrics by Rosneyri Rosario  
 Music by Rachel Dean  
 Sung by Stephanie McKay

How will everything be?  
 What will everyone think of me?  
 I wish everything would be just fine!  
 But as long as I'm happy, everything will be  
 alright!

I got so used to my school, but things can change  
 My friends, oh I'll miss them, but things will  
 change  
 I wonder what type of people there will be

I remember being with my friends  
 We use to tell each other secrets!  
 Or hang out afterschool until 8  
 Or going to the movies and having sleepovers  
 I'm gonna miss this life but everything will be  
 alright

I got so used to my school, but things can  
 change  
 My friends, oh I'll miss them, but things will  
 change  
 I wonder what type of people there will be

And I will miss all my teachers,  
 So thank you for teaching me!  
 And all the pizza that we ate  
 And my friends we could start all over  
 I'm gonna miss this life but everything will be  
 alright

I got so used to my school, but things can  
 change  
 My friends, oh I'll miss them, but things will  
 change  
 I wonder what type of people there will be  
 I'm gonna miss this life but everything will be  
 all right



**“The Battle/Siblings Song”**

Lyrics by Rosneyri Rosario  
 Music by Rachel Dean  
 Sung by Kendal Hartse,  
 Korey Jackson, Lilli Cooper

NARRATOR  
 Once not long ago in an ancient kingdom,  
 There were two siblings fighting  
 They were just walking into the town  
 When all of a sudden,

KING & PEASANT  
 There's no more ice cream!!!

NARRATOR  
 The siblings were King & Peasant  
 They wanted to dance for money & ice cream.

KING  
 I want to win, I need to win!  
 I am the King & I deserve it!!  
 And you're just a sick old peasant!  
 I deserve all the money & all of the ice cream!

PEASANT  
 I deserve it all! You win everything.  
 You are the King & you have everything.  
 I don't.

KING  
 Then let's dance it off!  
 And whoever wins,  
 Wins all of the money & all of the ice cream.

NARRATOR  
 So then the peasant & the king  
 Battled it off.  
 The peasant was a way better dancer,  
 but the King didn't want anything in his way.

BOTH  
 I want to win, I need to win!  
 I deserve all of the money & all of the ice  
 cream.  
 I want to win, I need to win!  
 I deserve all of the money & all of the ice  
 cream.

KING  
 I'm the King!

PEASANT  
 And I'm the Peasant!

NARRATOR  
 The Peasant was winning,  
 But the King just got mad.

**“Seasons”**

Lyrics by Sabrina Caldoni  
 Music by Danny Ursetti  
 Sung by Stephanie McKay,  
 Lauren Patten, Kendal Hartse, Andy Danh

SEASONS  
 Seasons they change  
 From Summer to Spring to Fall  
 Seasons they change  
 They never stay after all

Seasons they change

SUMMER  
 From Summer

SPRING  
 to Spring

FALL  
 to Fall

SEASONS  
 Seasons they change

WINTER  
 They never stay after all

SUMMER  
 Summer  
 Summer  
 Summer, an extroverted person  
 that likes to go outside to play  
 and do everything and nothing at all at once.

I like to hang out with my friends  
 And laugh (and talk?) all day  
 But I hate staying in 'cause that's boring  
 So yeah, that's me!  
 Summer!

SEASONS  
 Seasons they change  
 From Summer to Spring to Fall  
 Seasons they change  
 They never stay after all

WINTER & FALL  
 Meanwhile...  
 We are introverted and like to stay inside.  
 We like to stay in and be closed in.  
 We like to sleep in and stay quiet.

FALL  
 I, Fall, like to change in many ways  
 I let people know a colder time is coming their  
 way

WINTER  
 Um, hi? Are we done here?  
 I really gotta go.  
 I don't need anybody to tell  
 Me what my job is, so...  
 Can you like please go?  
 I need to freeze stuff.

SEASONS  
 Seasons they change  
 From Summer to Spring to Fall  
 Seasons they change  
 They never stay after all

SPRING  
 Then there's me, Spring  
 I like to intervene  
 I'm always caught waking up late by Summer  
 It's still fun though  
 Never a fuss to get caught up  
 In the noise and the sound  
 So yeah, bye bye!

SEASONS  
 Seasons they change  
 From Summer to Spring to Fall  
 Seasons they change  
 They never stay after all



**“The Big Fight”**

Lyrics by Sabrina Caldoni  
 Music by Danny Ursetti  
 Sung by Stephanie McKay,  
 Lauren Patten, Andy Danh

WINTER  
 Hey Summer, don't you think you're overstaying  
 your stay?  
 Maybe you should take a little time off to chill...

SUMMER  
 Uh hi? How 'bout no  
 People like it better with me don't you know?

WINTER  
 But still, people only like you for so long  
 They'll get tired and want you out for good

SUMMER  
 No! I want to stay here!  
 People like me much better than you!

WINTER  
 Oh really? Is that what you hear?  
 You must be delusional, irresponsible and--

SUMMER  
Don't you say the word

WINTER  
Stupid.

SUMMER  
Geeze why do you do this?  
You always gotta start things with me?  
Nobody likes you, you little Snow King

SPRING  
Hey, uh, please stop for a moment and think,  
Don't you do this every year?  
Can there be a way to find a--

WINTER  
Not now. I'm busy!

SPRING  
But please can't you rethink?

SUMMER  
No! Shut up what do you know

SPRING  
Fine! Just stop!  
Just listen to me for once!  
You guys sound like a bunch of kids!  
Just take a moment to reason and see  
There can be a win here?

WINTER  
Hey you're right, we do sound like kids  
Maybe we should stop

SUMMER  
Yeah you're right  
I'm sorry for all that I said.

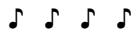

**"Leaves"**

Lyrics by Sabrina Caldana  
Music by Danny Ursetti  
Sung by Kendal Hartse

FALL  
My leaves are falling  
Because I'm hungry  
And I don't know what to do  
Maybe if I had some money, I'd buy some  
food?  
Oh what I'd do if I had some money.  
Food would be nice but I'm kinda broke.  
What I would do if I had some money  
A shoe would be nice or maybe some food?

Some spicy Doritos? I don't think so.  
Maybe I'm not hungry anymore.

My leaves are falling  
Because I'm hungry  
And I don't know what to do  
Maybe if I had some money, I'd buy some food?  
Oh what I'd do if I had some money.  
Food would be nice but I'm kinda broke.  
But food tastes really good  
And it's kinda weird 'cause I don't need it--  
So what I would do if I had some money  
A shoe would be nice or maybe some food?  
Some spicy Doritos? I don't think so.  
Maybe I'm not hungry anymore.  
Hey guys! Wanna get some food?  
I don't really understand the concept of food



**"My First Year of High School"**

Lyrics by Ricardo Currin  
Music by Wesley Brandt  
Sung by Korey Jackson

When I first started high school, I was super  
nervous, I didn't know anybody at all  
I had just finished middle school and I thought  
I was pretty tall,  
but compared to the other students I wasn't  
tall at all.  
I was just a little fish in a big pond full of  
whales and megalodons.  
The year was slow and very depressing and  
yes I'm certainly confessing  
That was my first year of high school.

Soon June finally came and summer had  
begun  
I was excited, summer is always fun  
A few weeks passed and I found myself bored  
I couldn't find anything to do.  
I was shocked, all my summers were sup-  
posed to be fun.  
I had to find something to do before summer  
was done.

I went to Barnes and Noble's, tried to read a  
book,  
Sadly that's not all it took.  
I called some of my friends which lifted my  
spirits up,  
But unfortunately that wasn't enough.  
I tried so many things

But I couldn't find anything, I wasn't sure why!  
So then I figured, Why even try?

But then soon came 4th Of July  
and I finally found something to do!!  
I spent my time with my family and we went to  
see the fireworks!

August was hot and I mean a lot,  
Went by pretty fast if you ask me  
And very soon I was down to summer's last  
week  
I stayed home on my phone  
Probably getting dumber  
But no longer bored  
In fact it was the second best part of summer.

September 8th I started school again  
Not much I can say yet except I'm definitely not  
a big fan  
...of school.  
Not a big fan of school.  
Not a big fan of school.



**"Zane Jeff"**

Lyrics by Ricardo Currin  
Music by Wesley Brandt  
Sung by Tim Jerome

My name is Zane Jeff.  
I'm forty-two years old.  
I've got four brothers.  
One in particular I envy.  
I live in an apartment building.  
Every week I pay rent  
to my brother,  
yes my brother  
because he is my landlord.

But one day, I tell you one day,  
I will win the lottery,  
Then I will be rich.  
Once I'm rich I will become the new Landlord.

My mother Margaret, she will be so proud of me.  
She is a wise woman, I'd say definitely.  
When I was just a boy, she told me a story,  
About those terrible grates.  
She fell once, into those grates.  
From that day, I never walked on those grates.

But one day, I tell you one day,  
I will win the lottery,  
Then I will be rich.  
Once I'm rich I will become the new Landlord.  
When I'm the landlord, I'll finally be able  
to get rid of those grates.  
When I'm the landlord!



**"The Dancing Ice Ballerina"**

Lyrics by Ricardo Currin  
Music by Wesley Brandt  
Sung by Andy Danh

Spoken: There is a legend. A Legend of the  
Dancing Ice Ballerina. She once was seen on  
an island dancing. Not much is known of her  
except, she had magical ice powers that only  
appeared when she danced.

Sung:  
My great-grandma who I call Mama  
Is now with me here on this island  
She has her favorite stuffed animal named  
Macky  
We are stranded on this island  
Just Mama and I  
I know of the Legend of the Dancing Ice  
Ballerina  
But could it be true, I wonder  
What would be the odds  
Of her being here now

Mama grabs me and points to Macky,  
Who's no longer in her hand  
Macky is dancing,  
My eyes have to be playing tricks,  
But there the doll is dancing  
The doll is dancing  
Just as the Legend explained

Ice begins to form around the island  
Macky begins gracefully dancing towards the  
ocean  
Mama tries to follow but I stop her  
Macky dances on the ocean  
And as the doll does this the water becomes  
ice  
Macky dances till dusk  
And Mama and I watch  
The doll's movement shifts  
From fast to slow  
Then the sun begins to set  
Tears form in Mama's eyes  
And as soon as the first tear drops  
The doll stops  
For a moment  
Everything else stops too  
Including Mama and I

The ice begins to melt  
Everything returns to normal  
Macky is lying lifeless in front of Mama  
I pick it up and give it back to Mama  
Who quickly takes it back  
After all it's her favorite doll...  
She smiles and hugs Macky

The 52nd Street Project gratefully acknowledges the support of the following foundations & corporations: The Altman Foundation; APA Talent & Literary Agency; BGC; Bull's Head Foundation, Inc.; Cantor Fitzgerald; Carnegie Corporation of New York; Maxine & Irving Castle Foundation; CBS Foundation, Inc.; City Winery; Consolidated Edison; Credit Suisse Securities (USA) LLC; Dawkins Family Foundation; Dramatists Guild Fund; Dramatists Play Service, Inc.; DTR Modern Galleries; Flexis Capital LLC; Friars National Foundation; Goldman Sachs; The Horace W. Goldsmith Foundation; Google; The Stephen P. Hanson Foundation; Heisman Trophy Trust; Lemle Pictures, Inc.; Live Nation Comedy; Frederick Loewe Foundation; LRS Designs, Inc.; Markel Corporation; Marusi Family Foundation; Newman's Own; Nickelodeon; Omnicom Group Inc.; Par Plumbing Co., Inc.; Pixar; Sawyer | Berson Architecture & Landscape Architecture; Morris & Alma Schapiro Fund; The Shubert Organization; The Stifler Family Foundation; Susquehanna Foundation, Corp.; Tax Pro Financial Network, Inc.; United Talent Agency; John A. Vassilaros & Sons, Inc.; The Vervane Foundation; West Bank Cafe; Yorke Construction Corp.; Zubatkin Owner Representation, LLC. (List current as of 8/18/2016)

Beth & Ray Abbott	Ingrid Ellen	Kim & Elliot Katz	Anita Rogerson
Robert Abrams	Gary Esayan	Mary Kong	Lynne Rosenberg
& Cynthia Vance	Peter Jay Fernandez	Henry Krieger	Laura & David Ross
George & Pam Ackert	& Denise Burse	Jan Kroeze & Jacki Ochs	Tatiana Rutkowski
Jeffrey Andreski	Anton Fig & Laura Sametz	Frances & Fred Langbecker	& Andrew Blackman
Richard Anthony & Avi Taussig	Lindsay Fram & Mason Pettit	William Lauch	Susan Sampliner
Dylan & Becky Baker	Karen & Paul Freitas	Maggie Lear	& Emily Grishman
Vishal Bakshi	Jon Friedland & Shaiza Rizavi	Justin Leavy	Brent Sarver
Eliza Baldi & David Costabile	Louis & Patrice Friedman	Cindy & Richard Leibovitch	Karin & Tom Schall
Jeff Bauml	Mark & Terri Friedman	David Long	Justin Schantz
Neena Beber	David Froelich	Edie Lutnick	David Schwab & Judy Kuhn
Richard Benn	& Cynthia Kaplan	Bruce MacVittie & Carol Ochs	Matthew & Curran Scoble
Craig Berggren	Sally Froelich	Julie & Alex Margolies	David Seidman
& Gavin Berger	Jennifer & Romolo Gabrielli	Elizabeth Marvel & Bill Camp	& Laura Valeroso
Elizabeth & Eric Berman	Jim & Jeannie Gaffigan	Stephen McDonnell	Amy & Alan Seifer
Philip Berney & Jane Pollock	Alexandra Garrison	& Jill Kearney McDonnell	Sylvia Shepard
Stephen Bernstein	Wayne & Pamela Garrison	Andre Meade & Tara Elwin	& Willy Holtzman
Lewis Black	Beverly Gasner	Victoria Melcher	Brian Shortt
Allison Blinken	Rose Gasner	Greg & Nyire Melconian	& Laura Konsin Shortt
Jane Bolster & Steve Wertimer	Scott Aaron & Laura Gewirtz	Yohan Minaya	William Shraga
Buzz Bovshow	Glen Gillen	Robert & Charlotte Morse	Robert Shwartz
Richard & Samantha Brand	& Michael Lawrence	Daryl & Michael Moss	Patterson Sims & Katy Homans
Iris Brown & Joe White	Kilty Gilmour	Suzen Murakoshi	Jeremy Smith
Carl Capotorto	Randy Ginsburg & Carole Yass	Elaine Musselman	John Smollen
Leah Carr	Christine Gleason	John & Kimberly Mustin	Stephen Sondheim
Lawrence Catena	& Erik Larson	Rachel & Paul Nadjarian	Jenny & Jon Steingart
Rachel Chanoff	Bruce Graham & Valerie Kay	Tim Blake Nelson	Tim Stephenson
Navin & Preeti Choksi	Tom Green	& Lisa Benavides	& Adriana Trigiani
Ellen Chopay	& Kristen Johanson	Randy & Rona Nelson	Bob Stockel
Katie & Kelly Clark	Susan Hanson	Ted Neustadt	Patty & David Straus
Joel Coen	Karen Hauser	& Becky Browder	Daniel Sussman & Beth Barry
& Frances McDormand	& Warren Leight	Evan Newmark & Ellen West	Jenni Swan
Robert Cohen	Ann & David Hausmann	Rachel & Larry Norton	Richard Sweren
& Danielle Mindess	Helen Hausmann	Lori O'Connor	Michael Tarnow
Brad Coley	Jessica Hecht	Beth & Bob Ollwerther	Mary Lou Teel
& Wendy vanden Heuvel	Peter & Eleni Henkel	Ty & Susan Olson	David Tewksbury
Penny Collins	Amy Herzig	F. Richard Pappas	Edith Thurber
Kevin Confoy	David Hillman & Lisa Cohen	Nicole Pellicciotto	& Kevin O'Rourke
Megan Cramer	Gary Horowitz & Alan Krevis	Jane Perlmutter	Fred Turpin
Billy Crudup	Alan Howard	& Greg Macpherson	Jan-Willem van den Dorpel
Cathy Dantchik	Ian Jackman	Elizabeth Peters	Tony Varni
Carolyn & Neil DeSena	Kristin Jaeger	Ben Posel & Jessica Bauman	Anna & Adam Vella
Marion & Alan Dienstag	Andrea Johnson	Sue Poulin	Gary Vogel
Andrew Douglass	Christa Justus	Steve Purtell	Mary Pat Walsh
Rick & Rebecca Dresser	& Mark Linn-Baker	Christopher Randolph	Mark & Vicki Whatley
Laurel Durst	Douglas M. Kaden	Willie Reale	Geof & Hilary Wills
Michaelene Durst	& Merritt Tilney	Nicholas Reiser	Morton Wolkowitz & Anita Keal
David & Chrysti Eigenberg	Patsy Kahn	Laura Rodgers	Jeffrey & Janine Yass

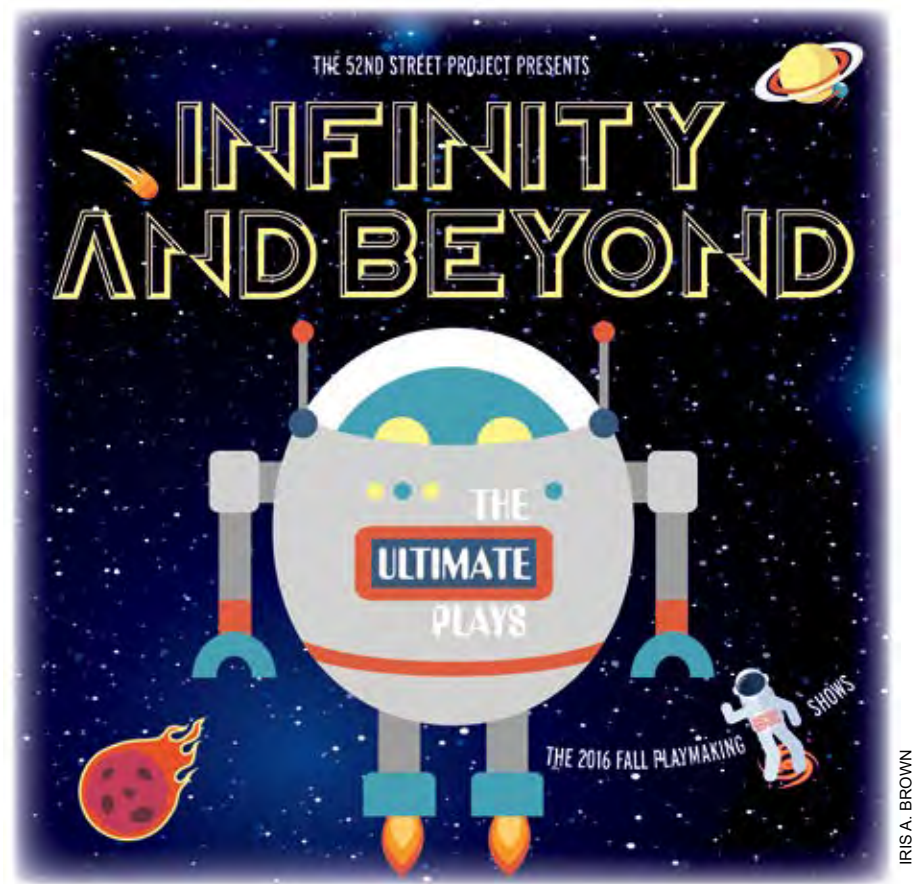

**10 NEW PLAYS WRITTEN BY KIDS AND PERFORMED BY ADULT ACTORS**

**Friday, Dec. 2 at 7:30 p.m.**

**Saturday, Dec. 3 at 3:00 & 7:30 p.m.**

**Sunday, Dec. 4 at 3:00 p.m.**

**THE FIVE ANGELS THEATER**

# INFINITY AND BEYOND: THE ULTIMATE PLAYS

Fall Playmaking 2015 - Dec. 2-4, Five Angels Theater

## The 52nd Street Project Staff

Gus Rogerson, Artistic Director	Carol Ochs, Executive Director
Natalie Hirsch, Associate Artistic Director	John Sheehy, Director of Institutional Advancement
Garrett Kim, Program Director	
George Babiak, Production Manager	Liz Bell, Director of Education
Tim J. Lord, Technical Director	Johanna Vidal*, Community Coordinator
	Yazzy Wilder*, Office Manager

*\*Alumnae of The 52nd Street Project*

### Consultants

Iris A. Brown, Graphic Designer; Chris Ceraso, Teen Dean

### Interns

Julio Chavez, Allison Fifield, Michelle Taliento, James Wade

### Teen Employees

Receptionists: Britney Trinidad, Maria Martinez, Chayse Peña, Makice Pacheco, and Karen Tineo.

Ushers: Leah Macuilt, Joseph Cruz, Karen Tineo, and Britney Trinidad.

## "Infinity and Beyond" Production Staff

### Composer/Music Director

Avi Amon

### Set Designer

Kevin Joseph Roach

### Lighting Designer

Greg MacPherson

### Costume Designers

Carisa Kelly and Michael Piatkowski

### Sound Designer

MuTTT L. Dogg

### Stage Manager

Jenny Peek

### Projection Designs

George Babiak and the Project's Projection Archive

### Prop Designs

George Babiak

### Backstage Crew

Julio Chavez, Allison Fifield, Michelle Taliento, Jayleen Velez, James Wade

### Show Photographer

Winston Rodney

### Weekend-Away Chefs

Liz Bell, Carol Ochs

### Playmaking Class Volunteers

Jen Anaya, Jody Flader, Micah Stock, Dov Delano, Ruffin Prentiss III, Tina Chilip, Monica Trausch, Arielle Goldman

### Playmaking Class Teen Assistant

Tatiana Goode

### Flyer and Program Art

Iris A. Brown



The Playmaking Program is made possible with public funds from the New York State Council on the Arts with the support of Governor Andrew M. Cuomo and the New York State Legislature, and the New York City Department of Cultural Affairs. This project is supported in part by an award from the National Endowment for the Arts. The 52nd Street Project is a member of Art/NY and Theatre Communications Group (TCG), the national organization for the American theatre.

## COOL STUFF ON SALE IN THE LOBBY!

Fabulous Flyer Bars..... \$2.50  
*and featuring Shel Silverstein's "Fivey and Twoey" logo:*  
 Project Hoodies..... \$30.00  
 Project Caps ..... \$20.00  
 Project T-shirts.....\$12.00/\$20.00  
 Project Mugs..... \$5.00  
 Project Notebook ..... \$5.00  
 Project Pencil 3-pack.....\$1.00

Thank you for coming to **INFINITY AND BEYOND**. If you are not on our mailing list, you can join on-line at [www.52project.org](http://www.52project.org). If you're interested in being a volunteer, fill out the form below and hand it to one of our staffers in the lobby.

### PLEASE PUT ME ON YOUR LIST:

12/16

NAME \_\_\_\_\_

ADDRESS \_\_\_\_\_

CITY \_\_\_\_\_

STATE \_\_\_\_\_

ZIP \_\_\_\_\_

HOME PHONE \_\_\_\_\_

DAYTIME OR MOBILE PHONE \_\_\_\_\_

E-MAIL ADDRESS \_\_\_\_\_

MY OCCUPATION \_\_\_\_\_

MY HOBBIES \_\_\_\_\_

WANT TO BE GREEN AND SAVE THE PROJECT MONEY ON POSTAGE?  
 CHECK THIS BOX TO RECEIVE OUR NOTICES EXCLUSIVELY VIA E-MAIL.

### YES, I WOULD LIKE TO BE OF HELP. I CAN:

- |   |   |  |
|---|---|--|
| <input type="checkbox"/> Help load in and out for shows | <input type="checkbox"/> Draw and/or paint  | <input type="checkbox"/> Help kids with homework |
| <input type="checkbox"/> Hang lights                    | <input type="checkbox"/> Help with mailings | <input type="checkbox"/> Teach kids a skill      |
| <input type="checkbox"/> Work on a backstage crew       | <input type="checkbox"/> Do office work     | <input type="checkbox"/> Be a chef at an event   |
| <input type="checkbox"/> Do graphic design              | <input type="checkbox"/> Design sound       | <input type="checkbox"/> Design and sew costumes |
| <input type="checkbox"/> Other (please specify) _____   |   |  |

### MY SCHEDULE IS:

- Very flexible. I'm often available during weekdays.  
 Somewhat flexible. I can help on the occasional morning or afternoon during the week.  
 Not very flexible at all, but I've got some free time on evenings and weekends.

If you would like to mail this (and you're always welcome to enclose a tax-deductible contribution), you can send it to: The 52nd Street Project, 789 10th Avenue, New York, NY 10019. Or fax it to (212) 333-5598.

## COMING UP NEXT!

THE 52ND STREET PROJECT PRESENTS  
**SHINE A LIGHT!**  
THE HOPEFUL PLAYS  
12 KIDS IN 6 PLAYS WRITTEN AND DIRECTED BY ADULTS  
THE 2017 TWO-ON-TWOS

GUS ROGERSON,  
ARTISTIC  
DIRECTOR  
CAROL OCHS,  
EXECUTIVE  
DIRECTOR  
NATALIE HIRSCH,  
ASSOCIATE  
ARTISTIC DIRECTOR

Friday, Jan. 27 at 7:30 p.m.  
Saturday, Jan. 28 at 7:30 p.m.  
Sunday, Jan. 29 at 3:00 p.m.

The Five Angels Theater  
789 10th Ave., between 52nd and 53rd Street  
Admission Free, but reservations are recommended.  
Reserve your seats today at [www.52project.org](http://www.52project.org)

ARTWORK BY  
PATRICK JONES



## BE ON THE LOOKOUT! WE ARE ALWAYS SEARCHING FOR INTERNS.

If you know of any college or graduate students who might enjoy working with us, playing with us, and going on trips with us for a semester, please have them contact Garrett Kim. We are currently looking for interns for the Summer of 2017. Thanks!

## The 52nd Street Project Board of Directors

Lisa Benavides	Frances McDormand
Rachel Chanoff	Noël Mihalow
Cathy Dantchik, co-chair	Carol Ochs
Carolyn DeSena	Willie Reale, founder
Wendy Ettinger, chair emeritus	Gus Rogerson
Louis P. Friedman, co-chair	Shirley Rumierk, alumni member
Alex Gersten-Vassilaros	José Soto, Jr., alumni member
Robert Goldberg	Merritt Tilney
Stephen Graham, chair emeritus	Wendy vanden Heuvel
Valerie Kay	Mark Whatley

## What's Going On Here?

The 52nd Street Project is a non-profit organization that brings children from the Hell's Kitchen neighborhood together with professional theater artists to create original theater. *INFINITY AND BEYOND* is a production of our Playmaking program. Young people participate in a nine-week playwriting course taught by Natalie Hirsch and adapted for the Project by Daniel Judah Sklar from his book *Playmaking: Children Writing and Performing Their Own Plays*. At the end of the course, each child is matched with two actors and a dramaturg/director who guides him or her through the writing of a play during a weekend retreat in the country (Stone Ridge, NY, for this show). This performance is the end result.

## In-Kind Contributions

Abbeville Press; Alvin Ailey; American Dance Theater; Richard Anthony; Ars Nova; Lewis Black; Iris A. Brown Design; William Curran & A Curran Affair; Evercore Partners; Edie Falco; Jim & Jeannie Gaffigan; Google; ICI; Karen Kowgios of Fried & Kowgios; Erik Larson; Kathleen Madigan; The Marshal Restaurant; Noel Mihalow & Prime Films; Natasha, Pierre, and the Great Comet of 1812; Noho Hospitality Group; Lauren Friedman, Pharma/Omni Printing; The Public Theater; Winston Rodney Photography; Showtime; Jenny Steingart; TARA 4779; Robin Treadway; TV Land/Viacom Kids & Family; John A. Vassilaros & Sons; Watkins Inc.; Steve Olsen and the WestBank Cafe; and Paul, Rifkind, Wharton, & Garrison LLP.

## Special Thanks

We're extremely thankful to Steve Gorn & Barbara Bash for the use of their beautiful home in Stone Ridge, NY as our base of operations for the writer's retreat weekend. We must also express thanks to Deborah Freedman & Bill Woods, Nicole & Paul Quinn, Jeff Madalena & Jason Gnewikow, Elaine Musselman, Tracey Dewart & Michel Eckersley, Amanda Van Doorene, Zorian & Alla Pinsky, and Natalie Merchant & John Bowermaster for housing our adults and kids. Last, but not least, thanks to Iris Brown, Joe White & Walker White for being our Stone Ridge liaisons!

# INFINITY AND BEYOND: ACT 1

All original music composed by Avi Amon

## THE HIKE

Written by Jade Johnson, age 10

Director: Arielle Goldman. Dramaturge: Johanna Vidal

Costume designer: Carisa Kelly

Yogi, a teacup ..... Kaaron Briscoe

Fire, a candle ..... Naomi Lorrain

Sun Woman ..... Wilhelmina Ohene Kari Kari

*Together* lyrics by Jade Johnson.

## THE JOB CONFLICT

Written by Ryan Billah, age 10

Director/Dramaturge: Kareem M. Lucas. Costume designer: Michael Piatkowski

Yolo the Frog ..... Jeremy Rishe

SnakeJake ..... David Shih

Youshi ..... Julio Chavez

Contestants and Judges ..... The Crew

*Always Being On Your Side* lyrics by Ryan Billah.

## THE SWAP

Written by Love Jones, age 9

Director/Dramaturge: Nicole A. Watson. Costume designer: Michael Piatkowski

Sarah, a teenage vampire ..... Annie Purcell

Elizabeth, another teenage vampire ..... Kate Abbruzzese

Dad ..... George Babiak

*I Rather Be, Looking for Humans, and Happy Dance World* lyrics by Love Jones.

## THE ADVENTURE OF SNOWBALL AND PINE

Written by Aengus O'Donnell, age 10

Director/Dramaturge: Tim J. Lord. Costume designer: Carisa Kelly

Snowball, a harp seal ..... Michael Propster

Pine, a deer ..... Jose Joaquin Perez

Brothers & Sisters ..... The Crew

Mom ..... Michelle Taliento

Hunters ..... James Wade, Jayleen Velez

*The Song of Truth* lyrics by Aengus O'Donnell

## BECOMING A MANAGER

Written by Arden Wolfe, age 11

Director/Dramaturge: Rachel Dart. Costume Designer: Carisa Kelly

Jolina, a taco ..... Jenelle Chu

Beana, a burrito ..... Morgan Everitt

Boss ..... Julio Chavez

Customer ..... Michelle Taliento

*Trust Me and Trust Me Reprise* lyrics by Arden Wolfe

# INFINITY AND BEYOND: ACT 2

## BROTHERS IN DISGUISE?

Written by Messiah Green, age 10

Dramaturge/Director: Jonathan Bock. Costume designer: Michael Piatkowski

Stephen ..... Stephen O'Reilly

Bubba ..... Ben Mehl

Garbage man ..... James Wade

*Money Longer and I'm an Undercover Agent* lyrics by Messiah Green.

## FRIENDS FOREVER

Written by Hannah Leon, age 9

Director: Natalie Hirsch. Dramaturge: Michelle Taliento.

Costume designer: Michael Piatkowski

Leon ..... Taylor Trench

Jessica ..... Helen Cespedes

Teacher and Students ..... The Crew

*BBFF* lyrics by Hannah Leon.

## SILLY AND BOA

Written by Ahmed Shabana, age 10

Director/Dramaturge: Jose Gamo. Costume Designer: Carisa Kelly

Silly C. Snake ..... Ruffin Prentiss III

Boa C. Snake ..... Michael Salinas

*Leave* lyrics by Ahmed Shabana.

## LAYCAYON THE WEREWOLF AND HADI THE DEER

Written by Aaron Ordinola, age 9

Director/Dramaturge: John Sheehy. Costume designer: Michael Piatkowski

Laycayon, a werewolf ..... Omar Metwally

Hadi, a deer ..... Sue Jean Kim

*Minor Violent Friendship Song* lyrics by Aaron Ordinola.

## THE 2 AND 3 MUSKETEERS

Written by Morgan Smalls, age 10

Director/Dramaturge: Alexandra O'Daly. Costume designer: Carisa Kelly

May ..... Mozhan Marnò

Katlen ..... Jennifer Van Dyck

Friends ..... Allison Fifield, Jayleen Velez

*Pain and The Best Friend Song* lyrics by Morgan Smalls.





# SHOW PROGRAMS 2017

The 52nd Street Project gratefully acknowledges the support of the following foundations & corporations: The Altman Foundation; APA Talent & Literary Agency; BGC; Bull's Head Foundation, Inc.; Cantor Fitzgerald; Carnegie Corporation of New York; Maxine & Irving Castle Foundation; CBS Foundation, Inc.; City Winery; Consolidated Edison; Credit Suisse Securities (USA) LLC; Dawkins Family Foundation; Dramatists Guild Fund; Dramatists Play Service, Inc.; DTR Modern Galleries; Flexis Capital LLC; Friars National Foundation; Goldman Sachs; The Horace W. Goldsmith Foundation; Google; The Stephen P. Hanson Foundation; Heisman Trophy Trust; Lemle Pictures, Inc.; Live Nation Comedy; Frederick Loewe Foundation; LRS Designs, Inc.; Markel Corporation; Marusi Family Foundation; Newman's Own; Nickelodeon; Omnicom Group Inc.; Par Plumbing Co., Inc.; Pixar; Sawyer | Berson Architecture & Landscape Architecture; Morris & Alma Schapiro Fund; The Shubert Organization; The Stifler Family Foundation; Susquehanna Foundation, Corp.; Tax Pro Financial Network, Inc.; United Talent Agency; John A. Vassilaros & Sons, Inc.; The Vervane Foundation; West Bank Cafe; Yorke Construction Corp.; Zubatkin Owner Representation, LLC. (List current as of 8/18/2016)

Beth & Ray Abbott	Ingrid Ellen	Kim & Elliot Katz	Anita Rogerson
Robert Abrams	Gary Essayian	Mary Kong	Lynne Rosenberg
& Cynthia Vance	Peter Jay Fernandez	Henry Krieger	Laura & David Koch
George & Pam Ackert	& Denise Burse	Jan Kroeze & Jacki Ochs	Tatiana Rutkowski
Jeffrey Andreski	Anton Fig & Laura Sametz	Frances & Fred Langbecker	& Andrew Blackman
Richard Anthony & Avi Taussig	Lindsay Fram & Mason Pettit	William Lauch	Susan Sampliner
Dylan & Becky Baker	Karen & Paul Freitas	Maggie Lear	& Emily Grishman
Vishal Bakshi	Jon Friedland & Shaiza Rizavi	Justin Leavy	Brent Sarver
Eliza Baldi & David Costabile	Louis & Patrice Friedman	Cindy & Richard Leibovitch	Karin & Tom Schall
Jeff Bauml	Mark & Terri Friedman	David Long	Justin Schantz
Neena Beber	David Froelich	Edie Lutnick	David Schwab & Judy Kuhn
Richard Benn	& Cynthia Kaplan	Bruce MacVittie & Carol Ochs	Matthew & Curran Scoble
Craig Berggren	Sally Froelich	Julie & Alex Margolies	David Seidman
& Gavin Berger	Jennifer & Romolo Gabrielli	Elizabeth Marvel & Bill Camp	& Laura Valeroso
Elizabeth & Eric Berman	Jim & Jeannie Gaffigan	Stephen McDonnell	Amy & Alan Seifer
Philip Berney & Jane Pollock	Alexandra Garrison	& Jill Kearney McDonnell	Sylvia Shepard
Stephen Bernstein	Wayne & Pamela Garrison	Andre Meade & Tara Elwin	& Willy Holtzman
Lewis Black	Beverly Gasner	Victoria Melcher	Brian Shortt
Allison Blinken	Rose Gasner	Greg & Nyire Melconian	& Laura Konsin Shortt
Jane Bolster & Steve Wertimer	Scott Aaron & Laura Gewirtz	Yohan Minaya	William Shraga
Buzz Bovshow	Glen Gillen	Robert & Charlotte Morse	Robert Shwartz
Richard & Samantha Brand	& Michael Lawrence	Daryl & Michael Moss	Patterson Sims & Katy Homans
Iris Brown & Joe White	Kilty Gilmour	Suzen Murakoshi	Jeremy Smith
Carl Capotorto	Randy Ginsburg & Carole Yass	Elaine Musselman	John Smollen
Leah Carr	Christine Gleason	John & Kimberly Mustin	Stephen Sondheim
Lawrence Catena	& Erik Larson	Rachel & Paul Nadjarian	Jenny & Jon Steingart
Rachel Chanoff	Bruce Graham & Valerie Kay	Tim Blake Nelson	Tim Stephenson
Navin & Preeti Choksi	Tom Green	& Lisa Benavides	& Adriana Trigiani
Ellen Chopay	& Kristen Johanson	Randy & Rona Nelson	Bob Stockel
Katie & Kelly Clark	Susan Hanson	Ted Neustadt	Patty & David Straus
Joel Coen	Karen Hauser	& Becky Browder	Daniel Sussman & Beth Barry
& Frances McDormand	& Warren Leight	Evan Newmark & Ellen West	Evan Swan
Robert Cohen	Ann & David Hausmann	Rachel & Larry Norton	Richard Sweren
& Danielle Mindess	Helen Hausmann	Lori O'Connor	Michael Tarnow
Brad Coley	Jessica Hecht	Beth & Bob Ollwerther	Mary Lou Teel
& Wendy vanden Heuvel	Peter & Eleni Henkel	Ty & Susan Olson	David Tewksbury
Penny Collins	Amy Herzig	F. Richard Pappas	Edith Thurber
Kevin Confoy	David Hillman & Lisa Cohen	Nicole Pellicciotto	& Kevin O'Rourke
Megan Cramer	Gary Horowitz & Alan Krevis	Jane Perlmutter	Fred Turpin
Billy Crudup	Alan Howard	& Greg Macpherson	Jan-Willem van den Dorpel
Cathy Dantchik	Ian Jackman	Elizabeth Peters	Tony Varni
Carolyn & Neil DeSena	Kristin Jaeger	Ben Posel & Jessica Bauman	Anna & Adam Vella
Marion & Alan Dienstag	Andrea Johnson	Sue Poulin	Gary Vogel
Andrew Douglass	Christa Justus	Steve Purtell	Mary Pat Walsh
Rick & Rebecca Dresser	& Mark Linn-Baker	Christopher Randolph	Mark & Vicki Whatley
Laurel Durst	Douglas M. Kaden	Willie Reale	Geof & Hilary Wills
Michaelene Durst	& Merritt Tilney	Nicholas Reiser	Morton Wolkowitz & Anita Keal
David & Chrysti Eigenberg	Patsy Kahn	Laura Rodgers	Jeffrey & Janine Yass

THE 52ND STREET PROJECT PRESENTS

# SHINE A LIGHT!

## THE HOPEFUL PLAYS

12 KIDS IN 6 PLAYS WRITTEN AND DIRECTED BY ADULTS

THE 2017 TWO-ON-TWOS

Friday, Jan. 27 at 7:30 p.m.  
 Saturday, Jan. 28 at 7:30 p.m.  
 Sunday, Jan. 29 at 3:00 p.m.

ARTWORK BY PATRICK JONES



# SHINE A LIGHT: THE HOPEFUL PLAYS

The 2017 Two-on-Twos - Jan. 27-29, Five Angels Theater

## The 52nd Street Project Staff

Gus Rogerson, Artistic Director  
Natalie Hirsch, Associate Artistic Director  
Garrett Kim, Program Director

Carol Ochs, Executive Director  
John Sheehy, Director of Institutional Advancement  
Kali Crandall, Director of Development

George Babiak, Production Manager  
Tim J. Lord, Technical Director

Liz Bell, Director of Education  
Johanna Vidal\*, Community Coordinator  
Yazzy Wilder\*, Office Manager

\*Alumnae of The 52nd Street Project

### Consultants

Iris A. Brown, Graphic Designer  
Chris Ceraso, Teen Dean

### Interns

Gillian Curry, Dara Solina Homer, Andrew Plimpton, and Margaret Fortuna Yassky

### Teen Employees

Receptionists: Britney Trinidad, Chayse Peña, and Karen Tineo  
Ushers: Jasmine Correa, Wilhelmina Ohene Kari Kari, Leah Macuil,  
Daniel Martinez, and Kayla Ortiz

## “SHINE A LIGHT” Production Staff

### Composer/Music Director

Rona Siddiqui

### Set Designer

Kevin Joseph Roach

### Lighting Designer

Josh Langman

### Costume Designer

Ntokozo Fuzunina Kunene

### Sound Designer

Margaret Fortuna Yassky

### Stage Manager

Valerie Insardi

### Projection Design:

George Babiak and  
The Project Slide Archive

### Props

George Babiak

### Backstage Crew

Andrew Plimpton,  
Dara Solina Homer,  
Gillian Curry,  
and Wren Neustadt

### Flyer Art

Patrick Jones

### Chefs

John Sheehy and Liz Bell

### Hamptons Weekend-away Hosts

Alex Gersten-Vassilaros,  
Laurie Becker,  
Cheri and Michael Friedman

## COOL STUFF ON SALE IN THE LOBBY!

Fabulous Flyer Bars..... \$2.50

and featuring Shel Silverstein's "Fivey and Twoey" logo:

Two-tone Project Hoodie..... \$40.00

Monotone Project Hoodie..... \$30.00

Project Caps..... \$20.00

Project T-shirts..... \$12.00/\$20.00

Project Mugs..... \$5.00

Project Notebook..... \$5.00

Project Pencil 3-pack..... \$1.00

Thank you for coming to **SHINE A LIGHT**. If you are not on our mailing list, you can join on-line at [www.52project.org](http://www.52project.org). If you're interested in being a volunteer, fill out the form below and hand it to one of our staffers in the lobby.

### PLEASE PUT ME ON YOUR LIST:

1/17

NAME

ADDRESS

CITY

STATE

ZIP

HOME PHONE

DAYTIME OR MOBILE PHONE

E-MAIL ADDRESS

MY OCCUPATION

MY HOBBIES

WANT TO BE GREEN AND SAVE THE PROJECT MONEY ON POSTAGE?  
CHECK THIS BOX TO RECEIVE OUR NOTICES EXCLUSIVELY VIA E-MAIL.

### YES, I WOULD LIKE TO BE OF HELP. I CAN:

- |   |   |  |
|---|---|--|
| <input type="checkbox"/> Help load in and out for shows | <input type="checkbox"/> Draw and/or paint  | <input type="checkbox"/> Help kids with homework |
| <input type="checkbox"/> Hang lights                    | <input type="checkbox"/> Help with mailings | <input type="checkbox"/> Teach kids a skill      |
| <input type="checkbox"/> Work on a backstage crew       | <input type="checkbox"/> Do office work     | <input type="checkbox"/> Be a chef at an event   |
| <input type="checkbox"/> Do graphic design              | <input type="checkbox"/> Design sound       | <input type="checkbox"/> Design and sew costumes |
| <input type="checkbox"/> Other (please specify) _____   |   |  |

### MY SCHEDULE IS:

- Very flexible. I'm often available during weekdays.
- Somewhat flexible. I can help on the occasional morning or afternoon during the week.
- Not very flexible at all, but I've got some free time on evenings and weekends.

If you would like to mail this (and you're always welcome to enclose a tax-deductible contribution), you can send it to: The 52nd Street Project, 789 10th Avenue, New York, NY 10019. Or fax it to (212) 333-5598.



The Two-on-Two Program is made possible with public funds from the New York State Council on the Arts with the support of Governor Andrew M. Cuomo and the New York State Legislature, and the New York City Department of Cultural Affairs. This project is supported in part by an award from the National Endowment for the Arts. The 52nd Street Project is a member of Art/NY and Theatre Communications Group (TCG), the national organization for the American theatre.

COMING UP SOON...

THE BOARD OF DIRECTORS OF THE 52ND STREET PROJECT INVITES YOU TO SAVE THE DATE

MONDAY, FEB. 13, 2017 - 7:00 P.M.

# CAROLOKE

SHE WORKS HARD FOR THE MONEY

A KARAOKE PARTY  
CELEBRATING  
CAROL OCHS'  
25TH ANNIVERSARY  
AT THE 52ND  
STREET PROJECT

CONTACT JOHN SHEEHY  
sheehy@52project.org  
or (212)333-5252



THE BOARD OF DIRECTORS OF THE 52ND STREET PROJECT  
INVITE YOU TO ALTER YOUR PLANS IF NEED BE TO...

SAVE THE DATE!

# CHANGES

A FLUXURIOUS BENEFIT  
FOR THE 52ND STREET PROJECT

MONDAY, MAY 8, 2017

AT THE EDISON BALLROOM

CONTACT JOHN "TRANSFORMER" SHEEHY AT SHEEHY@52PROJECT.ORG

### The 52nd Street Project Board of Directors

Lisa Benavides	Frances McDormand
Rachel Chanoff	Noël Mihalow
Cathy Dantchik, co-chair	Carol Ochs
Carolyn DeSena	Willie Reale, founder
Wendy Ettinger, chair emeritus	Gus Rogerson
Louis P. Friedman, co-chair	Shirley Rumierk, alumni member
Alex Gersten-Vassilaros	José Soto, Jr., alumni member
Robert Goldberg	Merritt Tilney
Stephen Graham, chair emeritus	Wendy vanden Heuvel
Valerie Kay	Mark Whatley

### What's Going On Here?

The 52nd Street Project is a non-profit organization that brings children from the Hell's Kitchen neighborhood together with professional theater artists to create original theater. **SHINE A LIGHT** is a production of our Two-on-Two's program, in which an adult playwright crafts a piece for a pair of 52nd Street Project kids to perform. Another adult directs the kids for a month that includes an intensive three-day weekend in Bridgehampton, Long Island. Tonight's performance is the final result.

### In-Kind Contributions

Abbeville Press; Alvin Ailey; American Dance Theater; Richard Anthony; Ars Nova; Lewis Black; Iris A. Brown Design; William Curran & A Curran Affair; Evercore Partners; Edie Falco; Jim & Jeannie Gaffigan; Google; ICI; Karen Kowgios of Fried & Kowgios; Erik Larson; Kathleen Madigan; The Marshal Restaurant; Noel Mihalow & Prime Films; Natasha, Pierre, and the Great Comet of 1812; Noho Hospitality Group; Lauren Friedman, Pharma/Omni Printing; The Public Theater; Winston Rodney Photography; Showtime; Jenny Steingart; TARA 4779; Robin Treadway; TV Land/Viacom Kids & Family; John A. Vassilaros & Sons; Watkins Inc.; Steve Olsen and the WestBank Cafe; and Paul, Rifkind, Wharton, & Garrison LLP.

### Special Thanks

We owe many thanks to Alex Gersten-Vassilaros and her family for graciously being our main house host on our rehearsal trip to Bridgehampton. We're also grateful to Laurie Becker of Sag Harbor and Cheri and Michael Friedman of Bridgehampton for providing additional housing for kids and adults. Thanks also to Wildwood Bowling Lanes in Riverhead for rolling out the welcome mat.



### BE ON THE LOOKOUT FOR INTERNS!

If you know of any college or graduate students who might enjoy working with us, playing with us, and going on trips with us for a semester, please have them contact . We are currently looking for interns for the Summer of 2017. Thanks!

# SHINE A LIGHT: THE HOPEFUL PLAYS - ACT 1

All original music composed by Rona Siddiqui

## BUNKER BROTHERS

Written by Jesse Liebman

Directed by KeiLyn Durrel Jones

Tomas ..... Joshua Gomez

Simon ..... Ezekiel Albarron

*We Can't Let It Rule and I Don't Want to Get Eaten Today* lyrics by

Jesse Liebman

## USED-TO-BE-HUMAN UNIVERSITY

Written by Nick Mills

Directed by George Babiak

Lynette Larkin ..... Karen Tineo

Eyema Zombee ..... Matthew Orozco

*Make Your Own Path and Trying to Be Human* lyrics by Nick Mills

## DESDEMONA'S DISCOVERY

Written by Charise Castro Smith

Directed by Emma Ramos

Desdemona ..... Sofia Santoni

Crateson ..... Jayda Camacho

Captain ..... Andrew Plimpton

*The Light of Knowledge and Let the Stars Be Your Guide* lyrics by

Charise Castro Smith



I  
N  
T  
E  
R  
M  
I  
S  
S  
I  
O  
N

# SHINE A LIGHT: THE HOPEFUL PLAYS - ACT 2

## TUESDAYS ON MARS

Written by Sarah Hammond

Directed by Kimiye Corwin

Marsha ..... Sasha Davis

Marcy ..... Tiffany Miller

Voice of Bob ..... George Babiak

Person ..... Andrew Plimpton

*The Marcy and Marsha Show Theme* lyrics by Sarah Hammond

## THERE WOLF

Written by Michael Bernard

Directed by Mat Hostetler

Upstart ..... Ricardo Currin

Roberta ..... Emily Roman

Chief/Homeless Person ..... Andrew Plimpton

*Feelings Feelings* lyrics by Michael Bernard

## THROUGH THE WALL

Written by Chisa Hutchinson

Directed by Sathya Sridharan

Vanessa ..... Maria Martinez

Edgardo ..... Kai Ceniza

*You're With Me* lyrics by Chisa Hutchinson



The 52nd Street Project gratefully acknowledges the support of the following foundations & corporations: The Altman Foundation; APA Talent & Literary Agency; BGC; Bull's Head Foundation, Inc.; Cantor Fitzgerald; Carnegie Corporation of New York; Maxine & Irving Castle Foundation; CBS Foundation, Inc.; City Winery; Consolidated Edison; Credit Suisse Securities (USA) LLC; Dawkins Family Foundation; Dramatists Guild Fund; Dramatists Play Service, Inc.; DTR Modern Galleries; Flexis Capital LLC; Friars National Foundation; Goldman Sachs; The Horace W. Goldsmith Foundation; Google; The Stephen P. Hanson Foundation; Heisman Trophy Trust; Lemle Pictures, Inc.; Live Nation Comedy; Frederick Loewe Foundation; LRS Designs, Inc.; Markel Corporation; Marusi Family Foundation; Newman's Own; Nickelodeon; Omnicom Group Inc.; Par Plumbing Co., Inc.; Pixar; Sawyer | Berson Architecture & Landscape Architecture; Morris & Alma Schapiro Fund; The Shubert Organization; The Stiffler Family Foundation; Susquehanna Foundation, Corp.; Tax Pro Financial Network, Inc.; United Talent Agency; John A. Vassilaros & Sons, Inc.; The Vervone Foundation; West Bank Cafe; Yorke Construction Corp.; Zubatkin Owner Representation, LLC. (List current as of 8/18/2016)

Beth & Ray Abbott	Ingrid Ellen	Kim & Elliot Katz	Anita Rogerson
Robert Abrams	Gary Esayian	Mary Kong	Lynne Rosenberg
& Cynthia Vance	Peter Jay Fernandez	Henry Krieger	Laura & David Ross
George & Pam Ackert	& Denise Burse	Jan Kroeze & Jacki Ochs	Tatiana Rutkowski
Jeffrey Andreski	Anton Fig & Laura Sametz	Frances & Fred Langbecker	& Andrew Blackman
Richard Anthony & Avi Taussig	Lindsay Fram & Mason Pettit	William Lauch	Susan Sampliner
Dylan & Becky Baker	Karen & Paul Freitas	Maggie Lear	& Emily Grishman
Vishal Bakshi	Jon Friedland & Shaiza Rizavi	Justin Leavy	Brent Sarver
Eliza Baldi & David Costabile	Louis & Patrice Friedman	Cindy & Richard Leibovitch	Karin & Tom Schall
Jeff Bauml	Mark & Terri Friedman	David Long	Justin Schantz
Neena Beber	David Froelich	Edie Lutnick	David Schwab & Judy Kuhn
Richard Benn	& Cynthia Kaplan	Bruce MacVittie & Carol Ochs	Matthew & Curran Scoble
Craig Berggren	Sally Froelich	Julie & Alex Margolies	David Seidman
& Gavin Berger	Jennifer & Romolo Gabrielli	Elizabeth Marvel & Bill Camp	& Laura Valeroso
Elizabeth & Eric Berman	Jim & Jeannie Gaffigan	Stephen McDonnell	Amy & Alan Seifer
Philip Berney & Jane Pollock	Alexandra Garrison	& Jill Kearney McDonnell	Sylvia Shepard
Stephen Bernstein	Wayne & Pamela Garrison	Andre Meade & Tara Elwin	& Willy Holtzman
Lewis Black	Beverly Gasner	Victoria Melcher	Brian Shortt
Allison Blinken	Rose Gasner	Greg & Nyire Melconian	& Laura Konsin Shortt
Jane Bolster & Steve Wertimer	Scott Aaron & Laura Gewirtz	Yohan Minaya	William Shraga
Buzz Bovshow	Glen Gillen	Robert & Charlotte Morse	Robert Shwartz
Richard & Samantha Brand	& Michael Lawrence	Daryl & Michael Moss	Patterson Sims & Katy Homans
Iris Brown & Joe White	Kilty Gilmour	Suzen Murakoshi	Jeremy Smith
Carl Capotorto	Randy Ginsburg & Carole Yass	Elaine Musselman	John Smollen
Leah Carr	Christine Gleason	John & Kimberly Mustin	Stephen Sondheim
Lawrence Catena	& Erik Larson	Rachel & Paul Nadjarian	Jenny & Jon Steingart
Rachel Chanoff	Bruce Graham & Valerie Kay	Tim Blake Nelson	Tim Stephenson
Navin & Preeti Choksi	Tom Green	& Lisa Benavides	& Adriana Trigiani
Ellen Chopay	& Kristen Johanson	Randy & Rona Nelson	Bob Stockel
Katie & Kelly Clark	Susan Hanson	Ted Neustadt	Patty & David Straus
Joel Coen	Karen Hauser	& Becky Browder	Daniel Sussman & Beth Barry
& Frances McDormand	& Warren Leight	Evan Newmark & Ellen West	Jenni Swan
Robert Cohen	Ann & David Hausmann	Rachel & Larry Norton	Richard Sweren
& Danielle Mindess	Helen Hausmann	Lori O'Connor	Michael Tarnow
Brad Coley	Jessica Hecht	Beth & Bob Ollwerther	Mary Lou Teel
& Wendy vanden Heuvel	Peter & Eleni Henkel	Ty & Susan Olson	David Tewksbury
Penny Collins	Amy Herzig	F. Richard Pappas	Edith Thurber
Kevin Confoy	David Hillman & Lisa Cohen	Nicole Pellicciotto	& Kevin O'Rourke
Megan Cramer	Gary Horowitz & Alan Krevis	Jane Perlmutter	Fred Turpin
Billy Crudup	Alan Howard	& Greg Macpherson	Jan-Willem van den Dorpel
Cathy Dantchik	Ian Jackman	Elizabeth Peters	Tony Varni
Carolyn & Neil DeSena	Kristin Jaeger	Ben Posel & Jessica Bauman	Anna & Adam Vella
Marion & Alan Dienstag	Andrea Johnson	Sue Poulin	Gary Vogel
Andrew Douglass	Christa Justus	Steve Purtell	Mary Pat Walsh
Rick & Rebecca Dresser	& Mark Linn-Baker	Christopher Randolph	Mark & Vicki Whatley
Laurel Durst	Douglas M. Kaden	Willie Reale	Geof & Hilary Wills
Michaelene Durst	& Merritt Tilney	Nicholas Reiser	Morton Wolkowitz & Anita Keal
David & Chrysti Eigenberg	Patsy Kahn	Laura Rodgers	Jeffrey & Janine Yass

THE 52ND STREET PROJECT PRESENTS

THE SPRING 2017 PLAYMAKING PLAYS

10 new plays written by kids and performed by adult actors

THE UNITED PLAYS

Friday, March 31 at 7:30 p.m.  
 Saturday, April 1 at 3:00 and 7:30 p.m.  
 Sunday, April 2 at 3:00 p.m.

THE FIVE ANGELS THEATER.

Artwork by Phil Oakes

**The 52nd Street Project Staff**

Natalie Hirsch, Artistic Director  
 Carol Ochs, Executive Director  
 Gus Rogerson, Producing Director  
 John Sheehy, Director of Institutional Advancement  
 George Babiak, Production Manager  
 Liz Bell, Director of Education  
 Kali Crandall, Development Director  
 Tim J. Lord, Technical Director  
 Johanna Vidal, Community Coordinator  
 Garrett Kim, Program Director  
 Yazzy Wilder, Office Manager

**Interns**

Gillian Curry, Dara Solina Homer, Andrew Plimpton

**Teen Receptionists**

Britney Trinidad, Chayse Peña, and Karen Tineo

**Teen Ushers**

Faisal Afridi, Eric Carrero, Tiniyah Powell,  
 Karen Tineo, Britney Trinidad

**“ALL TOGETHER NOW” Production Staff**

**Composer/Music Director**

Patrick Barnes

**Set Designer**

Kevin Joseph Roach

**Lighting Designer**

Greg MacPherson

**Costume Designers**

Amy Cain, Chris Rumery,  
 Crystal Thompson

**Sound Designer**

Tim J. Lord

**Stage Manager**

Kaleigh Bernier

**Projection Designs**

George Babiak and the  
 Project’s Projection Archive

**Prop Designs**

George Babiak

**Backstage Crew**

Sevan Asencio, Gillian Curry,  
 Natasha Davis, Dara Solina Homer,  
 Andrew Plimpton

**Show Photographer**

Winston Rodney

**Weekend-Away Chefs**

John Sheehy and Liz Bell

**Playmaking Class Volunteers**

Ben Beckley, Lauren Capkanis,  
 Annabelle Cousins, Neil D’Astolfo,  
 Aiden Dreskin, Talia Heller,  
 Rachel Levens, Geoffrey Murphy,  
 Micah Stock

**Playmaking Class Teen Assistant**

Jasmine Correa

**Flyer and Program Art**

Nick Choksi

**COOL STUFF ON SALE IN THE LOBBY!**

Fabulous Flyer Bars..... \$2.50  
*and featuring Shel Silverstein’s “Fivey and Twoey” logo:*  
 Two-tone Project Hoodie..... \$40.00  
 Monotone Project Hoodie ..... \$30.00  
 Project Caps ..... \$20.00  
 Project T-shirts.....\$12.00/\$20.00  
 Project Mugs..... \$5.00  
 Project Notebook ..... \$5.00  
 Project Pencil 3-pack.....\$1.00

Thank you for coming to **ALL TOGETHER NOW**. If you are not on our mailing list, you can join on-line at [www.52project.org](http://www.52project.org). If you’re interested in being a volunteer, fill out the form below and hand it to one of our staffers in the lobby.

**PLEASE PUT ME ON YOUR LIST:**

04/17

NAME \_\_\_\_\_

ADDRESS \_\_\_\_\_

CITY \_\_\_\_\_ STATE \_\_\_\_\_ ZIP \_\_\_\_\_

HOME PHONE \_\_\_\_\_

DAYTIME OR MOBILE PHONE \_\_\_\_\_ E-MAIL ADDRESS \_\_\_\_\_

MY OCCUPATION \_\_\_\_\_ MY HOBBIES \_\_\_\_\_

WANT TO BE GREEN AND SAVE THE PROJECT MONEY ON POSTAGE?  
 CHECK THIS BOX TO RECEIVE OUR NOTICES EXCLUSIVELY VIA E-MAIL.

**YES, I WOULD LIKE TO BE OF HELP. I CAN:**

- Help load in and out for shows
- Draw and/or paint
- Help kids with homework
- Hang lights
- Help with mailings
- Teach kids a skill
- Work on a backstage crew
- Do office work
- Be a chef at an event
- Do graphic design
- Design sound
- Design and sew costumes
- Other (please specify) \_\_\_\_\_

**MY SCHEDULE IS:**

- Very flexible. I’m often available during weekdays.
- Somewhat flexible. I can help on the occasional morning or afternoon during the week.
- Not very flexible at all, but I’ve got some free time on evenings and weekends.

If you would like to mail this (and you’re always welcome to enclose a tax-deductible contribution), you can send it to: The 52nd Street Project, 789 10th Avenue, New York, NY 10019. Or fax it to (212) 333-5598.



The Playmaking Program is made possible with public funds from the New York State Council on the Arts with the support of Governor Andrew M. Cuomo and the New York State Legislature, and the New York City Department of Cultural Affairs. This project is supported in part by an award from the National Endowment for the Arts. The 52nd Street Project is a member of Art/NY and Theatre Communications Group (TCG), the national organization for the American theatre.

# THE ANNUAL BENEFIT IS COMING!

To honor board co-chairs Cathy Dantchik and Louis P. Friedman and former board chairs Wendy Ettinger, Stephen Graham, and Frances McDormand we ask you to take a seat and save the date for...

# MUSICAL CHAIRS

Monday, May 8, 2017  
at the Edison Ballroom



A benefit celebrating  
The 52nd Street Project's 35th Anniversary.  
Featuring songs written by kids of the Project  
and performed by special guest artists.

CONTACT JOHN "LA-Z-BOY" SHEEHY FOR MORE INFORMATION ABOUT  
"MUSICAL CHAIRS" AT (212) 333-5252 OR SHEEHY@52PROJECT.ORG

## The 52nd Street Project Board of Directors

Lisa Benavides	Frances McDormand
Rachel Chanoff	Noël Mihalow
Cathy Dantchik, co-chair	Carol Ochs
Carolyn DeSena	Willie Reale, founder
Wendy Ettinger, chair emeritus	Gus Rogerson
Louis P. Friedman, co-chair	Shirley Rumierk, alumni member
Alex Gersten-Vassilaros	José Soto, Jr., alumni member
Robert Goldberg	Merritt Tilney
Stephen Graham, chair emeritus	Wendy vanden Heuvel
Valerie Kay	Mark Whatley

## What's Going On Here?

The 52nd Street Project is a non-profit organization that brings children from the Hell's Kitchen neighborhood together with professional theater artists to create original theater. **ALL TOGETHER NOW** is a production of our Playmaking program. Young people participate in a nine-week playwriting course taught by Natalie Hirsch and adapted for the Project by Daniel Judah Sklar from his book *Playmaking: Children Writing and Performing Their Own Plays*. At the end of the course, each child is matched with two actors and a dramaturg/director who guides him or her through the writing of a play during a week-end retreat in the country (Bridgehampton, Long Island, for this show). This performance is the end result.

## In-Kind Contributions

Abbeville Press; Alvin Ailey; American Dance Theater; Richard Anthony; Ars Nova; Lewis Black; Iris A. Brown Design; William Curran & A Curran Affair; Evercore Partners; Edie Falco; Jim & Jeannie Gaffigan; Google; Haru Restaurant of Hell's Kitchen; ICI; Karen Kowgios of Fried & Kowgios; Erik Larson; Kathleen Madigan; The Marshal Restaurant; Noel Mihalow & Prime Films; Natasha, Pierre, and the Great Comet of 1812; Noho Hospitality Group; Lauren Friedman, Pharma/Omni Printing; The Public Theater; Winston Rodney Photography; Showtime; Jenny Steingart; TARA 4779; Robin Treadway; TV Land/Viacom Kids & Family; John A. Vassilaros & Sons; Watkins Inc.; Steve Olsen and the WestBank Cafe; and Paul, Rifkind, Wharton, & Garrison LLP.

## Special Thanks

We're extremely grateful to Alexandra Gersten-Vassilaros for the use of her beautiful home in Bridgehampton, NY as our base of operations for the writer's retreat. We're also grateful to Leslie & Cathy Dantchik for being the girls' host, and to Laurie Becker for housing adults in Sag Harbor.



## BE ON THE LOOKOUT FOR INTERNS!

If you know of any college or graduate students who might enjoy working with us, playing with us, and going on trips with us for a semester, please have them contact Garrett Kim (gkim@52project.org). We are currently looking for interns for the Fall of 2017. Thanks!

# ALL TOGETHER NOW: ACT I

All original music composed by Patrick Barnes

## YOU HAVE REACHED 866

Written by Nyla Blake Soden, age 10

Director/Dramaturge: Stephanie Jean Lane, Costumes: Amy Cain

Ashley..... Crystal Dickinson  
 Arnold..... Brandon Dirden  
 Boss..... Dara Solina Homer

## TWO-FACED

Written by Joel Gokalp, age 9

Director/Dramaturge: Austin Regan, Costumes: Chris Rumery

Avacado, a hammer..... Michael Braun  
 Gabby Dreidle, a nail..... Carson Elrod  
 God..... John Sheehy

*The Sound of Life* lyrics by Joel Gokalp.

## BEST FRIENDS FOREVER

Written by Gianna Hires, age 10

Dramaturge: Sarah Johnsrude, Director: Sarah Krohn, Costumes: Amy Cain

Emily..... Mirirai Sithole  
 Ally, a disco lamp..... Nikki Massoud  
 Dog News Reporter..... Garrett Kim  
 Toby..... Andrew Plimpton  
 Party guests..... The Crew

## HOME RUN

Written by Amari DuBose, age 10

Dramaturge: Rachel Levens, Director: Gus Rogerson, Costumes: Chris Rumery

Samuel..... Aaron Costa Ganis  
 Coach Selesia..... Danielle Davenport  
 Referee..... Andrew Plimpton  
 Players..... The Crew

*Chant Our Name and Don't Chant It* lyrics by Amari DuBose.

## THE ADVENTURE OF THE CAPPUCCINO

Written by Jayden Alvarado, age 10

Director/Dramaturge: Korey Jackson, Costumes: Amy Cain

Sticker..... Raul Castillo  
 Pencil..... Billy Crudup

*The Power of Together* lyrics by Jayden Alvarado.



# ALL TOGETHER NOW: ACT I

## IT'S NOT TRUE

Written by Kailey Canton, age 9

Dramaturge/Director: Anne Troup, Costumes: Crystal Thompson

Maxcie..... Zoe Chao  
 Emma..... Lily Balatincz  
 Rainbow God..... Andrew Plimpton  
 Humans in the street/New Family..... Dara Solina Homer & Gillian Curry  
*Useful, Sorry and Away* lyrics by Kailey Canton.

## THE LIE OF THE STATEMENT

Written by Kimora Moore, age 9

Dramaturge: Natalie Hirsch, Director: Rachel Levens, Costumes: Crystal Thompson

Isabella, a snowman..... Leslie Fray  
 Shanel, another snowman..... Rosa Gilmore  
 Manager..... Gillian Curry  
 Friends..... The Crew

## THE TOURNAMENT

Written by Yousef Altareb, age 9

Director/Dramaturge: George Babiak, Costumes: Amy Cain

Jeff..... Kyle Cameron  
 Basement..... Bjorn DuPaty  
 The Ball..... Gillian Curry  
 Mailman..... Sevan Asencio  
 Tournament Boss..... John Sheehy

*Having Fun* lyrics by Yousef Altareb.

## LOST TWINS

Written by Faith Villanueva, age 9

Director/Dramaturge: Chelsea Hackett, Costumes: Chris Rumery

Alkeee, a lollipop..... Nancy Giles  
 Fried Steak and Chicken, another lollipop..... Michael Potts  
 Boss..... Gillian Curry  
 French Fry Bar Owner..... George Babiak  
 Customers..... The Crew

*The Big Trick* lyrics by Faith Villanueva.

## BOTH TOGETHER

Written by Gilbert Rosario, age 10

Director/Dramaturge: Martin Moran, Costumes: Chris Rumery

Elizabeth..... Eliza Huberth  
 Albert..... Micah Stock

*It's OK* lyrics by Gilbert Rosario.





The 52nd Street Project is a non-profit arts organization that brings children from the Hell's Kitchen neighborhood together with professional artists to create original art. The Dancemaking program gives 7 Project kids a chance to express themselves creatively through movement. Over the nine weeks of Dancemaking class, led by HannaH Allen with support from Program Director Garrett Kim, these young choreographers and performers developed their own movement vocabulary. With their adult Choreoturges, they explored shapes, pathways, actions, and choreographic elements to create their own original piece. The resulting dances are featured in tonight's performance.

### **The 52nd Street Project Staff**

Natalie Hirsch, Artistic Director  
Carol Ochs, Executive Director  
Gus Rogerson, Producing Director  
John Sheehy, Director of Institutional Advancement  
George Babiak, Production Manager  
Liz Bell, Director of Education  
Kali Crandall, Development Director  
Tim J. Lord, Technical Director  
Johanna Vidal, Community Coordinator  
Garrett Kim, Program Director  
Yazzy Wilder, Office Manager

### **Interns**

Gillian Curry, Dara Solina Homer, Andrew Plimpton

### **Teen Receptionists**

Britney Trinidad, Chayse Peña, and Karen Tineo

### **Teen Ushers**

Faisal Afridi, Eric Carrero, Tiniyah Powell,  
Karen Tineo, Britney Trinidad

### **The 52nd Street Project Board of Directors**

Lisa Benavides	Frances McDormand
Rachel Chanoff	Noël Mihalow
Cathy Dantchik, co-chair	Carol Ochs
Carolyn DeSena	Willie Reale, founder
Wendy Ettinger, chair emeritus	Gus Rogerson
Louis P. Friedman, co-chair	Shirley Rumierk, alumni member
Alex Gersten-Vassilaros	José Soto, Jr., alumni member
Robert Goldberg	Merritt Tilney
Stephen Graham, chair emeritus	Wendy vanden Heuvel
Valerie Kay	Mark Whatley

The 52nd Street Project Presents



## **The 52nd Street Project's Annual Dance Concert**

Featuring 8 original dances choreographed by  
kids and performed by kids and adults.

Dancemaking Director: HannaH Allen

Friday, April 7, 2017 – 7:30 p.m.

The Five Angels Theater  
The 52nd Street Project  
789 10th Avenue



## GROUP DANCE

Choreographer: Hannah Allen  
MUSIC: "Dived" by Balmorhea  
THEME: Resistance

## Girl's Night Out

CHOREOGRAPHER: Thiana Goode with Courtney Williams  
MUSIC: "Glam - Electro-swing Remix" by Dimie Cat  
THEME: Girls Just Wanna Have Fun

*CHOREOGRAPHER'S NOTE: "When I first met Courtney, I knew she was a funny, strong, determined girl who like to have a fun like me! We had crazy dance moves that was so much fun and tiring."*

## Friendemay

CHOREOGRAPHER: Ahmed Abdelmeged with Derek Long  
MUSIC: "The Enemy God And The Dance Of The Spirits Of Darkness"  
from Sergei Prokofiev's Scythian Suite, Op. 20  
THEME: Friends

*CHOREOGRAPHER'S NOTE: "This song was about that even if you have an enemy you can still be friends."*

## I Was Born Ready

CHOREOGRAPHER: Andres Mendoza with Marchánt Davis  
MUSIC: "Battlefield 2: Theme" performed by Joel Eriksson  
THEME: Battle Warrior  
INSPIRATIONAL QUOTE: "I have a dream."

*CHOREOGRAPHER'S NOTE: "Enjoyed the beat, enjoyed the name of the song."*

## Patriarchy, Family, and War

CHOREOGRAPHERS: Sofia Santoni & Joseph Cruz  
with Nehassaiu deGannes  
MUSIC: "Momma's Song" and "I Think I Broke Something" composed  
by Dan Romer for Beasts of the Southern Wild  
THEME: Puppetry & Manipulation  
SOFIA'S INSPIRATIONAL QUOTE: "It could be worse."  
JOSEPH'S INSPIR. QUOTE: "Dreams are just an untold future."

*CHOREOGRAPHERS' NOTES, SOPHIA: "Weird doing process w/ another person." JOSEPH: "Song choices weren't as good, partners are hard working."*

## Vegetarian Zombie Apocalypse

CHOREOGRAPHER: Darby O'Donnell with Elli Brown  
MUSIC: "Paint It Black" composed by Ramin Djawadi for Westworld  
THEME: Vegetarian Zombie Apocalypse

*CHOREOGRAPHER'S NOTE: We came up with a move that looked like a zombie and we are both vegetarian.*

## The Butterfly and the Bee

Angel Mendoza with Gardiner Comfort  
MUSIC: "Nautilus (Hijacked)" by Breakdown Brass  
THEME: It's easy to achieve something.

INSPIRATIONAL QUOTE: "Float like a butterfly, sting like a bee."

*CHOREOGRAPHER'S NOTE: About what a butterfly and a bee would do if they meet. They would introduce themselves and what they do in nature.*

## Thrisha the Pearl's in Love <3

CHOREOGRAPHER: Lovely Ramirez with Therese Barbato  
MUSIC: "The Winner Is" by DeVotchKa from Little Miss Sunshine  
THEME: Love & Time

INSPIRATIONAL QUOTE: "I love you."

*CHOREOGRAPHER'S NOTE: The dance came out what we really love and what we feel when it comes to love. I chose the quote "I love you" because I really love the people that I know and it makes me happy when people say I love you.*



The Dancemaking Program is made possible with public funds from the New York State Council on the Arts with the support of Governor Andrew M. Cuomo and the New York State Legislature, and the New York City Department of Cultural Affairs. This project is supported in part by an award from the National Endowment for the Arts. The 52nd Street Project is a member of Art/NY and Theatre Communications Group (TCG), the national organization for the American theatre.

## The 52nd Street Project Board of Directors

Lisa Benavides	Frances McDormand
Rachel Chanoff	Noël Mihalow
Cathy Dantchik, co-chair	Carol Ochs
Carolyn DeSena	Willie Reale, founder
Wendy Ettinger, chair emeritus	Gus Rogerson
Louis P. Friedman, co-chair	Shirley Rumierk, alumni member
Alex Gersten-Vassilaros	José Soto, Jr., alumni member
Robert Goldberg	Merritt Tilney
Stephen Graham, chair emeritus	Wendy vanden Heuvel
Valerie Kay	Mark Whatley

## The 52nd Street Project Staff

Natalie Hirsch, Artistic Director  
Carol Ochs, Executive Director  
Gus Rogerson, Producing Director  
John Sheehy, Director of Institutional Advancement  
George Babiak, Production Manager  
Liz Bell, Director of Education  
Kali Crandall, Development Director  
Tim J. Lord, Technical Director  
Johanna Vidal, Community Coordinator  
Garrett Kim, Program Director  
Yazzy Wilder, Office Manager



## Benefit Volunteers

Vanessa Valdes

## Singing Coaches



The programs of The 52nd Street Project are made possible with public funds from the New York State Council on the Arts with the support of Governor Andrew M. Cuomo and the New York State Legislature, and the New York City Department of Cultural Affairs. This project is supported in part by an award from the National Endowment for the Arts. The 52nd Street Project is a member of Art/NY and Theatre Communications Group (TCG), the national organization for the American theatre.

The Board of Directors of The 52nd Street Project  
and the CLAWS Foundation welcome you to

# MUSICAL CHAIRS

*The 52nd Street Project's 35th Anniversary Benefit*



**Monday, May 8, 2017**  
**The Edison Ballroom**

## “Musical Chairs” Benefit Co-Chairs

Lisa Benavides  
Rachel Chanoff  
Cathy Dantchik  
Carolyn DeSena

Louis & Patrice Friedman  
Karin Schall  
Merritt Tilney  
Mary Pat Walsh

### **The 52nd Street Project gratefully acknowledges...**

Abbeville Press  
Richard Anthony  
Ars Nova  
Lewis Black  
Iris A. Brown Design  
William Curran, A Curran Affair  
Edie Falco  
Jim and Jeannie Gaffigan  
Erik Larson  
Kathleen Madigan  
The Marshal  
Noël Mihalow and Prime Films  
Natasha, Pierre, and the Great Comet of 1812  
Noho Hospitality Group  
Lauren Friedman, Pharma/Omni Printing  
The Public Theater  
Willie Reale  
Showtime  
Jenny Steingart  
TARA 4779  
Merritt Tilney & Doug Kaden  
Robin Treadway  
TV Land/Viacom Kids & Family  
John A. Vassilaros & Sons  
Mark Jacobs & Watkins Incorporated  
Healthier Living Since 1868  
Steve Olsen and the WestBank Cafe



## Wing Back Seats

Beth & Ray Abbott  
Becky Ann & Dylan Baker  
Eliza Baldi & David Costabile  
Beth Barry & Daniel Sussman  
Neena Beber  
Nancy & Robert Becker  
Craig Berggren & Gavin Berger  
Beth & Eric Berman  
Allison Blinken  
Jane Bolster & Steve Wertimer  
Buzz Bovshow  
Becky Browder  
Denise Burse Fernandez &  
Peter Jay Fernandez  
Leah Carr  
Navin & Preeti Choksi  
Ellen Chopay  
Lisa Cohen  
Marion & Alan Dienstag  
Michaelene Durst  
Lindsay Fram & Mason Pettit  
Sally Froelich  
Bev Gasner  
Rose Gasner & Larry Chertoff  
Jenny Gersten & Willie Reale  
Laura & Scott Gewirtz  
Susan Hanson  
Karen Hauser & Warren Leight  
Jessica Hecht  
Kristen Johanson & Tom Green  
Cynthia Kaplan & David Froelich  
Kim & Elliot Katz  
Anita Keal & Morty Wolkowitz  
Mary Kong

Alan Krevis & Gary Horowitz  
Henry Krieger & Robert Joy  
Judy Kuhn  
Frances Langbecker  
Martin Levine, The PAR Group  
Yohan Minaya  
Michael Moss  
Suzen Murakoshi  
Lori O'Connor  
Jacki Ochs & Jan Kroeze  
Beth & Bob Ollwerther  
Jane Perlmutter &  
Greg MacPherson  
Suzanne Poulin  
Randi Puccio  
Anita Andres Rogerson  
Lynne Marie Rosenberg  
Steve Sabba,  
Tax Pro Financial Network, Inc.  
Sawyer | Berson Architects &  
Landscape Architects  
Amy Seifer  
Sylvia Shepard & Willy Holtzman  
Laura & Brian Shortt  
Bob Shwartz  
Stephen Sondheim  
Jenni Swan  
Richard Sweren  
Edith Thurber & Kevin O'Rourke  
Adriana Trigiani & Tim Stephenson  
Cynthia Vance & Robert Abrams  
Simona & Ted Vassilev  
Shelley & Gary Vogel  
Mary Pat Walsh

Carol Ochs,  
Executive Director

Cathy Dantchik & Louis P. Friedman,  
Board Co-Chairs

Natalie Hirsch,  
Artistic Director



# MUSICAL CHAIRS

*The 52nd Street Project's 35th Anniversary Benefit*

**Monday, May 8, 2017 at The Edison Ballroom**

## **Seat-at-the-Table Tables**

Jennifer & Jonathan Allan Soros

Stephen Bernstein

Katie Clark

Sarah Horowitz & David Venarde

Tara Elwin

Mickey Lemle

Josephine Merck & Jim Stevenson

Rona & Randolph Nelson

Steve Olsen

Nicole Pellicciotto

Laura Sametz

Karin & Thomas Schall

Jeremy Smith

Avi Taussig & Richard Anthony

Laura Valeroso

Carole Yass

## **Booster Seats**

Somebody Somebody



### **Your Host**

Raul Castillo

### **The Lyricists**

Sabrina Caldonga

Ricardo Currin

Ayman Musa

Rosneyri Rosario

### **The Performers**

The Bengsons

Wesley Brandt

Rachel Dean

Henry Krieger

Willie Reale

Danny Ursetti



### **Director**

Gus Rogerson

### **Music Director**

Kimberly Grigsby

### **Lighting Designer**

Greg MacPherson

### **Sound Designer**

John Kemp

### **Set and Prop Designer**

George Babiak

### **Stage Manager**

Charles M. Turner III

### **Percussionist**

John Epcar



## **CHANGE**

Lyrics by Ayman Musa, age ?  
Music by The Bengsons  
Performed by The Bengsons  
Back-up vocals sung by ?

TIME IS LIKE A LIME  
IT CAN BE SOUR  
BUT YOU CAN FIGHT THROUGH WITH POWER BY EACH HOUR  
IT MAKES ME CRY OF TEARS OF JOY  
IT MAKES ME REGRET OF ALL THE FEELINGS I HAD  
GROWING UP WITH ALL THESE DECISIONS I HAD  
IT MAKES ME CRY OF ALL THE FUN I HAD

AGE CAN CHANGE  
WHEN YOUR STORY IS GOING THROUGH CONFLICT  
AND ADJUSTING TO A NEW BODY  
HAVING HAIR EVERYWHERE TO MAKE YOU TEAR YOUR HAIR  
ANOTHER THING  
YOU CAN FEEL SAD, MAD, BAD,  
IT CAN MAKE YOU HAPPY  
IT CAN MAKE YOU ANXIOUS AND A MESS

LIFE CAN JUST BE FINE  
IF IT IS GOING IN A STRAIGHT LINE  
BUT IT TAKES TIME  
AND I FEEL LIKE I WON'T BE FINE,  
BUT IS IT A REAL CRIME  
TO BELIEVE FOR WHAT YOU STAND FOR?  
BUT THAT IS WHY WE CAN CHANGE  
INTO A BETTER PERSON  
WE CAN COME OUT OF OUR SHELL  
BUT EVERYONE HAS TO TELL.

## **Throne Room Table**

The Dantchik Family  
Stephen Graham

## **Catbird Tables**

Comedy Central  
Patrice & Louis Friedman  
Elaine Musselman  
Dr. Borah W. Walton, Jr.



## **Sitting Pretty Tables**

APA, Talent & Literary Agency  
Lisa Benavides Nelson & Tim Blake Nelson  
Bloomberg Philanthropies  
CBS Corporation  
Dawkins Family Foundation  
Carolyn & Neil DeSena  
Alexandra Garrison  
Robert Goldberg, Yorke Construction Corporation  
Valerie Kay & Bruce Graham  
Live Nation Comedy  
Grace Lyu-Volckhausen, Tiger Baron Foundation  
Laura & David Ross  
Merritt Tilney & Douglas Kaden  
TV Land/Viacom Kids & Family  
United Talent Agency  
Wendy vanden Heuvel  
Alexandra Vassilaros  
Vicki & Mark Whatley



## SONG BY WILLIE AND HENRY

Lyrics by Willie Reale, age ?  
Music by Henry Krieger  
Performed by ?  
Back-up vocals sung by ?



LYRICS  
LYRICS  
LYRICS  
LYRICS  
LYRICS  
LYRICS  
LYRICS  
LYRICS  
LYRICS  
LYRICS  
LYRICS  
LYRICS  
LYRICS  
LYRICS  
LYRICS  
LYRICS  
LYRICS  
LYRICS  
LYRICS  
LYRICS

## THE DANCING ICE BALLERINA

Lyrics by Ricardo Currin, age ?  
Music by Wesley Brandt  
Performed by Andy Danh  
Back-up vocals sung by ?



MY GREAT-GRANDMA WHO I CALL MAMA  
IS NOW WITH ME HERE ON THIS ISLAND  
SHE HAS HER FAVORITE STUFFED ANIMAL  
NAMED MACKY  
WE ARE STRANDED ON THIS ISLAND  
JUST MAMA AND I  
I KNOW OF THE LEGEND OF THE DANCING  
ICE BALLERINA  
BUT COULD IT BE TRUE, I WONDER  
WHAT WOULD BE THE ODDS  
OF HER BEING HERE NOW

MAMA GRABS ME AND POINTS TO MACKY,  
WHO'S NO LONGER IN HER HAND  
MACKY IS DANCING,  
MY EYES HAVE TO BE PLAYING TRICKS,  
BUT THERE THE DOLL IS DANCING  
THE DOLL IS DANCING  
JUST AS THE LEGEND EXPLAINED

ICE BEGINS TO FORM AROUND THE  
ISLAND  
MACKY BEGINS GRACEFULLY DANCING  
TOWARDS THE OCEAN  
MAMA TRIES TO FOLLOW BUT I STOP HER  
MACKY DANCES ON THE OCEAN  
AND AS THE DOLL DOES THIS THE WATER  
BECOMES ICE  
MACKY DANCES TILL DUSK  
AND MAMA AND I WATCH  
THE DOLL'S MOVEMENT SHIFTS  
FROM FAST TO SLOW  
THEN THE SUN BEGINS TO SET  
TEARS FORM IN MAMA'S EYES  
AND AS SOON AS THE FIRST TEAR DROPS  
THE DOLL STOPS  
FOR A MOMENT  
EVERYTHING ELSE STOPS TOO  
INCLUDING MAMA AND I

THE ICE BEGINS TO MELT  
EVERYTHING RETURNS TO NORMAL  
MACKY IS LYING LIFELESS IN FRONT OF  
MAMA  
I PICK IT UP AND GIVE IT BACK TO MAMA  
WHO QUICKLY TAKES IT BACK  
AFTER ALL IT'S HER FAVORITE DOLL...  
SHE SMILES AND HUGS MACKY

THE LEGEND IS TRUE  
THE DANCING ICE BALLERINA ISN'T ON  
THE ISLAND  
BUT HER SOUL IS.  
I LOOK AT MACKY AGAIN  
AND FOR A SPLIT SECOND  
IT'S EYES GLOW  
IT'S THE DANCING ICE BALLERINA  
I JUST KNOW IT  
HER SOUL IS IN MACKY  
HER SOUL IS IN MACKY



## LEAVES

Lyrics by Sabrina Caldon, age ?

Music by Danny Ursetti

Performed by Bobby Cannavale

Back-up vocals sung by ?

FALL  
MY LEAVES ARE FALLING  
BECAUSE I'M HUNGRY  
AND I DON'T KNOW WHAT TO DO  
MAYBE IF I HAD SOME MONEY, I'D BUY SOME FOOD?  
OH WHAT I'D DO IF I HAD SOME MONEY.  
FOOD WOULD BE NICE BUT I'M KINDA BROKE.  
WHAT I WOULD DO IF I HAD SOME MONEY  
A SHOE WOULD BE NICE OR MAYBE SOME FOOD?  
SOME SPICY DORITOS? I DON'T THINK SO.  
MAYBE I'M NOT HUNGRY ANYMORE.

MY LEAVES ARE FALLING  
BECAUSE I'M HUNGRY  
AND I DON'T KNOW WHAT TO DO  
MAYBE IF I HAD SOME MONEY, I'D BUY SOME FOOD?  
OH WHAT I'D DO IF I HAD SOME MONEY.  
FOOD WOULD BE NICE BUT I'M KINDA BROKE.  
BUT FOOD TASTES REALLY GOOD  
AND IT'S KINDA WEIRD 'CAUSE I DON'T NEED IT--  
SO WHAT I WOULD DO IF I HAD SOME MONEY  
A SHOE WOULD BE NICE OR MAYBE SOME FOOD?  
SOME SPICY DORITOS? I DON'T THINK SO.  
MAYBE I'M NOT HUNGRY ANYMORE.

HEY GUYS! WANNA GET SOME FOOD?  
I DON'T REALLY UNDERSTAND THE CONCEPT OF FOOD

## WILL THINGS CHANGE?

Lyrics by Rosneyri Rosario, age ?

Music by Rachel Dean

Performed by Celia Keenan-Bolger

Back-up vocals sung by ?



HOW WILL EVERYTHING BE?  
WHAT WILL EVERYONE THINK OF ME?  
I WISH EVERYTHING WOULD BE JUST FINE!  
BUT AS LONG AS I'M HAPPY, EVERYTHING WILL BE ALRIGHT!

I GOT SO USED TO MY SCHOOL, BUT THINGS CAN CHANGE  
MY FRIENDS, OH I'LL MISS THEM, BUT THINGS WILL CHANGE  
I WONDER WHAT TYPE OF PEOPLE THERE WILL BE

I REMEMBER BEING WITH MY FRIENDS  
WE USE TO TELL EACH OTHER SECRETS!  
OR HANG OUT AFTERSCHOOL UNTIL 8  
OR GOING TO THE MOVIES AND HAVING SLEEPOVERS  
I'M GONNA MISS THIS LIFE BUT EVERYTHING WILL BE ALRIGHT

I GOT SO USED TO MY SCHOOL, BUT THINGS CAN CHANGE  
MY FRIENDS, OH I'LL MISS THEM, BUT THINGS WILL CHANGE  
I WONDER WHAT TYPE OF PEOPLE THERE WILL BE

AND I WILL MISS ALL MY TEACHERS,  
SO THANK YOU FOR TEACHING ME!  
AND ALL THE PIZZA THAT WE ATE  
AND MY FRIENDS WE COULD START ALL OVER  
I'M GONNA MISS THIS LIFE BUT EVERYTHING WILL BE ALRIGHT

I GOT SO USED TO MY SCHOOL, BUT THINGS CAN CHANGE  
MY FRIENDS, OH I'LL MISS THEM, BUT THINGS WILL CHANGE  
I WONDER WHAT TYPE OF PEOPLE THERE WILL BE  
I'M GONNA MISS THIS LIFE BUT EVERYTHING WILL BE ALL RIGHT



The 52nd Street Project (The Project) is dedicated to the creation and production of new plays for and by kids between the ages of ten and eighteen who reside in the Hell's Kitchen neighborhood in New York City. The Project does this through unique mentoring programs that match kids with professional (and volunteer!) theater artists.

The Project is about making children proud of themselves. The Project is not about teaching children to act, although they will learn to. It is not about teaching them to write plays, although they will learn that as well. What it is about is giving a kid an experience of success. It is about giving a kid an opportunity to prove that he or she has something of value to offer, something that comes from within that he or she alone possesses, something that cannot be taken away.

The Project's Teen Ensemble is the final step in the kids' training: a two-year acting class that culminates in the production of a full-length play by William Shakespeare, the very one you are seeing tonight. This year's show is being done in New York, NY; Bolinas, CA, and San Francisco, CA. We are very grateful to all our friends on both coasts for enabling this tour.

The following foundations and government agencies have generously supported the Teen Program through their contributions:

City of New York Department of Cultural Affairs  
Dramatists Guild Fund  
The Horace Goldsmith Foundation  
The National Endowment for the Arts  
New York State Council on the Arts  
Harold and Mimi Steinberg Charitable Trust  
The 52nd Street Project is a member of Art New York



THE 52ND STREET PROJECT PRESENTS

MR. WILLIAM SHAKESPEARE'S

# THE COMEDY OF ERRORS

Featuring  
The 52nd Street Project Teen Ensemble

Directed by  
Jose-Maria Aguila

**THE FIVE ANGELS THEATER**  
New York City, NY  
789 10th Ave.  
Friday, June 23 @ 7:30 p.m.  
& Sat., June 24 @ 3:00 p.m.

**THE STAGE**  
@ 45 Nymph Road  
Bolinas, California  
Tuesday, June 27  
@ 5:00 p.m.

**Z BELOW @ Z SPACE**  
470 Florida St.  
San Francisco, California  
Thursday, June 29  
@ 7:00 p.m.



## The Cast, In Order of Appearance

Egeon ..... Jose-Maria Aguila  
Duchess Solinus..... Ashley Thomas  
Antipholus of Syracuse..... Chayse Peña  
Dromio of Syracuse ..... Faisal Afridi  
Antipholus of Ephesus..... Daniel Martinez  
Dromio of Ephesus ..... Jasmine Correa  
Adriana ..... Britney Trinidad  
Luciana ..... Edelys Guerrero  
Angelo the Goldsmith ..... Enrique Caballero  
Merchant..... Tatiana Goode  
Balthazar ..... Tatiana Goode  
Courtesan ..... Edelys Guerrero  
Dr. Pinch ..... Ashley Thomas  
Officer ..... Jose-Maria Aguila  
Emilia ..... Tatiana Goode

## Production Staff

Direction ..... Jose-Maria Aquila  
Lighting Designer..... Ben Fichthorn  
Costume Designer..... Lara DeBruijn  
Sound Designers ..... Garrett Kim and Faisal Afridi  
Prop and Set Design ..... George Babiak

**Shakespeare Coaches:** Kate Abbruzzese, Arielle Goldman, Greg Hildreth, Kevin Isola, KeillLyn Durrel Jones, Flor De Liz Perez, Lynne Rosenberg, Sathya Sridharan, Jennifer Van Dyck

**Thanks to our California friends and hosts:** Lisa Chanoff, Commonweal, Paull & Amity Hejinian, Eric Karpeles & Mike Sell, Shau-na Marshall & Bob Hirsch, Frances McDormand, Aenor Sawyer & Melinda Griffith, Wendy vanden Heuvel & Brad Coley, Z-Space

## The 52nd Street Project Staff

Ahmed Attia, Development Associate\*  
George Babiak, Director of Design and Production  
Liz Bell, Director of Education  
Molly Coogan, Acting Development Associate  
Kali Crandall, Development Director  
Natalie Hirsch, Artistic Director  
Garrett Kim, Program Director  
Tim J. Lord and Brian Freeland, Production Managers  
Carol Ochs, Executive Director  
Gus Rogerson, Producing Director  
John Sheehy, Director of Institutional Advancement  
Johanna Vidal, Community Coordinator\*  
Yazzy Wilder, Office Manager\*

## Consultants

Iris A. Brown, Graphic Designer;  
Chris Ceraso, Teen Dean

## Interns

Tony Macht, Jackie McKenna, Alicia Moeller

## Teen Receptionists

Jade Cuevas, Karen Tineo, Britney Trinidad, Chayse Peña

## Concessions

Karen Tineo

## Ushers

Wilhelmina Ohene Kari Kari and Matthew Orozco

## The 52nd Street Project Board of Directors

Lisa Benavides	Frances McDormand
Rachel Chanoff	Noël Mihalow
Cathy Dantchik, co-chair	Carol Ochs
Carolyn DeSena	Willie Reale, founder
Wendy Ettinger, chair emeritus	Gus Rogerson
Louis P. Friedman, co-chair	Shirley Rumierk, alumni member
Alex Gersten-Vassilaros	José Soto, Jr., alumni member
Robert Goldberg	Merritt Tilney
Stephen Graham, chair emeritus	Wendy vanden Heuvel
Valerie Kay	Mark Whatley

*\*Alumnus of The 52nd Street Project Teen Ensemble*

## A COMEDY OF ERRORS - THE SYNOPSIS

Egeon, a merchant of Syracuse, is condemned to death in Ephesus for violating the ban against travel between the two rival cities. As he is led to his execution, he tells the Ephesian Duchess, Solinus, that he has come to Syracuse in search of his wife and one of his twin sons, who were separated from him 25 years ago in a shipwreck. The other twin, who grew up with Egeon, is also traveling the world in search of the missing half of their family. (The twins, we learn, are identical, and each has an identical twin slave named Dromio.) The Duke is so moved by this story that he grants Egeon a day to raise the ransom that would be necessary to save his life.

Meanwhile, unknown to Egeon, his son Antipholus of Syracuse (and Antipholus' slave Dromio) is also visiting Ephesus--where Antipholus' missing twin, known as Antipholus of Ephesus, is a prosperous citizen of the city. Adriana, Antipholus of Ephesus' wife, mistakes Antipholus of Syracuse for her husband and drags him home for dinner, leaving Dromio of Syracuse to stand guard at the door and admit no one. Shortly thereafter, Antipholus of Ephesus (with his slave Dromio of Ephesus) returns home and is refused entry to his own house. Meanwhile, Antipholus of Syracuse has fallen in love with Luciana, Adriana's sister, who is appalled at the behavior of the man she thinks is her brother-in-law.

The confusion increases when a gold chain ordered by the Ephesian Antipholus is given to Antipholus of Syracuse. Antipholus of Ephesus refuses to pay for the chain and is arrested for debt. His wife, seeing his strange behavior, decides he has gone mad and orders him bound and held. Meanwhile, Antipholus of Syracuse and his slave decide to flee the city, which they believe to be enchanted, as soon as possible--only to be menaced by Adriana and the debt officer. They seek refuge in a nearby abbey.

Adriana now begs the Duchess to intervene and remove her "husband" from the abbey into her custody. Her real husband, meanwhile, has broken loose and now comes to the Duchess and levels charges against his wife. The situation is finally resolved by the Abbess, Emilia, who brings out the set of twins and reveals herself to be Egeon's long-lost wife. Antipholus of Ephesus reconciles with Adriana; Egeon is pardoned by the Duchess and reunited with his spouse; Antipholus of Syracuse resumes his romantic pursuit of Luciana, and all ends happily with the two Dromios embracing.

## A COMEDY OF ERRORS - THE SYNOPSIS

Egeon, a merchant of Syracuse, is condemned to death in Ephesus for violating the ban against travel between the two rival cities. As he is led to his execution, he tells the Ephesian Duchess, Solinus, that he has come to Syracuse in search of his wife and one of his twin sons, who were separated from him 25 years ago in a shipwreck. The other twin, who grew up with Egeon, is also traveling the world in search of the missing half of their family. (The twins, we learn, are identical, and each has an identical twin slave named Dromio.) The Duke is so moved by this story that he grants Egeon a day to raise the ransom that would be necessary to save his life.

Meanwhile, unknown to Egeon, his son Antipholus of Syracuse (and Antipholus' slave Dromio) is also visiting Ephesus--where Antipholus' missing twin, known as Antipholus of Ephesus, is a prosperous citizen of the city. Adriana, Antipholus of Ephesus' wife, mistakes Antipholus of Syracuse for her husband and drags him home for dinner, leaving Dromio of Syracuse to stand guard at the door and admit no one. Shortly thereafter, Antipholus of Ephesus (with his slave Dromio of Ephesus) returns home and is refused entry to his own house. Meanwhile, Antipholus of Syracuse has fallen in love with Luciana, Adriana's sister, who is appalled at the behavior of the man she thinks is her brother-in-law.

The confusion increases when a gold chain ordered by the Ephesian Antipholus is given to Antipholus of Syracuse. Antipholus of Ephesus refuses to pay for the chain and is arrested for debt. His wife, seeing his strange behavior, decides he has gone mad and orders him bound and held. Meanwhile, Antipholus of Syracuse and his slave decide to flee the city, which they believe to be enchanted, as soon as possible--only to be menaced by Adriana and the debt officer. They seek refuge in a nearby abbey.

Adriana now begs the Duchess to intervene and remove her "husband" from the abbey into her custody. Her real husband, meanwhile, has broken loose and now comes to the Duchess and levels charges against his wife. The situation is finally resolved by the Abbess, Emilia, who brings out the set of twins and reveals herself to be Egeon's long-lost wife. Antipholus of Ephesus reconciles with Adriana; Egeon is pardoned by the Duchess and reunited with his spouse; Antipholus of Syracuse resumes his romantic pursuit of Luciana, and all ends happily with the two Dromios embracing.

The 52nd Street Project is a non-profit arts organization that brings children from the Hell's Kitchen neighborhood together with professional artists to create original art.

In Stage Combat, a ruff-n-rowdy group of Project kids and their scrappy adult partners have learned the art of safe, choreographed fighting. Led by Project volunteer Joe Isenberg, they've learned to tell stories of high-stakes conflicts through punches, kicks, slaps, and so much more! Each play is centered around a staged fight that they have created with the guidance of their adult partners.

### The 52nd Street Project Staff

Natalie Hirsch, Artistic Director  
 Carol Ochs, Executive Director  
 Gus Rogerson, Producing Director  
 John Sheehy, Director of Institutional Advancement  
 George Babiak, Director of Design and Production  
 Liz Bell, Director of Education  
 Kali Crandall, Development Director  
 Molly Coogan, Acting Development Associate  
 Ahmed Attia, Development Associate  
 Tim J. Lord, Production Manager  
 Johanna Vidal, Community Coordinator  
 Garrett Kim, Program Director  
 Yazzy Wilder, Office Manager

### Consultants:

Iris A. Brown, Graphic Designer; Chris Ceraso, Teen Dean

### Interns:

Jackie McKenna, Alicia Moeller, Tony Macht

### Teen Employees:

Receptionists: Jade Cueva, Chayse Peña, Karen Tlneo, Britney Trinidad,  
 Ushers: Chayse Peña

### The 52nd Street Project Board of Directors

Lisa Benavides  
 Rachel Chanoff  
 Cathy Dantchik, co-chair  
 Carolyn DeSena  
 Wendy Ettinger, chair emeritus  
 Louis P. Friedman, co-chair  
 Alexandra Gersten-Vassilaros  
 Robert Goldberg  
 Stephen Graham,  
 chair emeritus  
 Valerie Kay

Frances McDormand  
 Noël Mihalow  
 Carol Ochs  
 Willie Reale, founder  
 Gus Rogerson  
 Shirley Rumierk, alumni member  
 José Soto, Jr., alumni member  
 Merritt Tilney  
 Wendy vanden Heuvel  
 Mark Whatley

# THE 52ND STREET PROJECT PRESENTS THE LORRAINE COHEN STAGE COMBAT SHOWS



1. FIGHTING DISTANCE

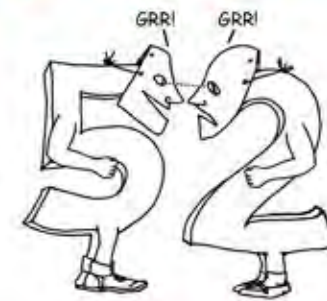

2. EYE CONTACT



3. WIND-UP

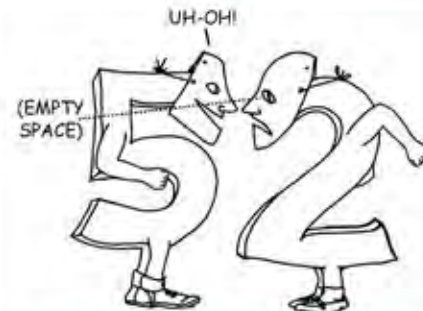

4. LOOK AT THE TARGET



5. THE EVENT

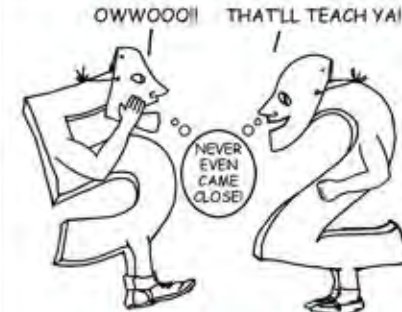

6. FOLLOW-THROUGH

**Friday, June 9, 2017 at 7:30 p.m.**  
 The Five Angels Theater at The 52nd Street Project

# THE 2017 LORRAINE COHEN STAGE COMBAT SHOWS

## WITCHES, PIES, POWER, FRIENDSHIP

Written by Magalis Viñas, age 12

Directed by Leta Renée-Alan

A witch .....Magalis Viñas

Another witch.....Leta Renée-Alan

## THE ADVENTURE OF REAL OR FAKE FRIENDS

Written by Gabriel Acevedo, age 11

Directed by Jose Gamo

Richie..... Gabriel Acevedo

Edwin..... Jose Gamo

## THE JOB

Written by Karen Tineo, age 14

Directed by Briana Pozner

One Shot ..... Karen Tineo

Sniper ..... Briana Pozner

## THE AGUACATE SPECIAL

Written by Stevens Velasquez, age 12

Directed by Jose Duran

Aguacate ..... Stevens Velasquez

Referee..... Jose Duran

## THE BOILING FIGHT

Written by Beyonce Thomas, age 13

Directed by Stephanie Linas

Maria Peña de los Santos .....Beyonce Thomas

Delilah Ortiz..... Stephanie Linas

## EVERYBODY'S WORST DAY

Written by Adam Alkindi, age 15

Directed by Ian Edlund

Crazy Mike..... Adam Alkindi

Dave Jakson..... Ian Edlund

Security Guard/Mailman ..... Tony Macht

## NEVER MAKE THE FENCE TOO HIGH

Written by Lakshmi DeJesus, age 12

Directed by Channie Waites

Sally ..... Lakshmi DeJesus

Stacey.....Channie Waites

## BROTHERS IN BONES

Written by Coleman Williams, age 12

Directed by Neil D'Astolfo

Mitchell ..... Coleman Williams

Pitchell..... Neil D'Astolfo

## THE PRODUCTION TEAM

Fight Director and Instructor ..... Joe Isenberg

Lighting Designer..... Tim J. Lord

Lightboard Operator ..... Alicia Moeller

Sound Operator ..... Jackie McKenna

Props ..... George Babiak

Stage Crew..... Tony Macht



The Stage Combat Program is made possible with public funds from The New York State Council on the Arts, a state agency, and the New York City Department of Cultural Affairs. This project is supported in part by an award from the National Endowment for the Arts. The 52nd Street Project is a member of Art/NY and Theatre Communications Group (TCG), the national organization for the American theatre.

## **Lorraine Cohen** **1927-2005**

For more than forty years, Lorraine Cohen dedicated herself to all facets of the theater, including acting, directing and teaching. Her deeply memorable performances as Amanda in *The Glass Menagerie* and as Emily Dickinson in *The Belle of Amherst* were often compared favorably with the very well known actors who had played those roles before her. Those who knew her as a teacher, remember the amazing annual Shakespeare productions of her fifth graders and the many stunning performances of her high school students.

In the 1960's Laurie performed in a series of plays at the Bergen County Players in New Jersey including *Ring Around Elizabeth* (1960), *Fumed Oak* (1961), *Blithe Spirit* (1962), and *The Waltz of the Toreadors* (1961). In 1969 she performed in *No Bed of Roses* at the Showplace Summer Theatre. Laurie also spent many productive years at The New Dimension Theatre Studio in Englewood, New Jersey where Dr. Richard Imundo was the Artistic Director. At The New Dimension she taught acting to children and young adults, and also performed in many productions including *Animal* (1971), *The Glass Menagerie*, and *Uncle Vanya* (1970). She also directed and acted in many evenings of scenes at The New Dimension. One of her early students at The New Dimension was a young man by the name of John Travolta who also performed with her in *Who'll Save the Plowboy?* (1966).

Having obtained her college degree from Fairleigh Dickinson University in Teaneck, New Jersey, she performed in a series of plays produced by the University Players, including *Ghosts*, *The Glass Menagerie*, and *J.B.* While studying for her masters degree at Montclair State College, she performed in several productions there including *The Hostage*, *Plaza Suite*, and *Not Now Darling*. Laurie also performed in *Cinderella* at the William Paterson College Summer Theatre Workshop, and in 1984 she performed in *The Devil's Disciple* at the Williamstown Theatre Festival in Williamstown, Massachusetts.

In 1983 Laurie starred as Emily Dickinson in the one-woman show *The Belle of Amherst*, directed by her friend and colleague, John Brancato. *The Belle of Amherst* had a limited run at The Tyson Studio in New York City to rave reviews in *The New York Times* and *The Daily News*.

Though many encouraged Laurie to pursue a professional acting career, she always made it clear that her true love was teaching and she dedicated much of her life to filling young students' hearts and minds with the love of theatre, both in its literary form and as a performing art. During her tenure in the 1970's as a fifth grade teacher at the Longfellow School in Teaneck, New Jersey, she directed an annual Shakespeare play starring her fifth grade students, performing the likes of *Macbeth*, *Julius Caesar* and *Hamlet*. Laurie's love of theater and teaching reached its pinnacle during her many years teaching English and Drama at Teaneck High School in Teaneck, New Jersey. She truly loved teaching drama to high school students, introducing them to the joys of acting and play-writing, and she directed an enormous number of full length productions, musicals, scenes, and student-written original plays. She directed too many shows to list individually, but they included *Cabaret*, *Diary of Anne Frank*, *A Midsummer Night's Dream*, *The Crucible*, *The Man Who Came To Dinner*, *Don't Drink the Water* and *Waiting for Godot*. In addition to these productions, she directed the students in an annual Evening of Scenes. Her students won many awards for their work at the annual Bucks County Playhouse Drama Festivals in Pennsylvania. Even after retirement from teaching, she continued to direct performances at Leonia High School, in Leonia, New Jersey.

In addition to acting and teaching, Laurie also edited three books for the theatre: *Scenes for Young Actors*, *Monologues for Young Actors*, and *Scenes for Mature Actors*, all published by Avon Books. These three books continue to be used today in acting classes and auditions around the country.

Laurie is remembered lovingly by her five children, her three siblings, her eight grandchildren, her companion Dick, her many colleagues and friends, and her innumerable students. It is in her memory that they support the 52nd Street Project. It is what she would have wanted.



## **Lorraine Cohen** **1927-2005**

For more than forty years, Lorraine Cohen dedicated herself to all facets of the theater, including acting, directing and teaching. Her deeply memorable performances as Amanda in *The Glass Menagerie* and as Emily Dickinson in *The Belle of Amherst* were often compared favorably with the very well known actors who had played those roles before her. Those who knew her as a teacher, remember the amazing annual Shakespeare productions of her fifth graders and the many stunning performances of her high school students.

In the 1960's Laurie performed in a series of plays at the Bergen County Players in New Jersey including *Ring Around Elizabeth* (1960), *Fumed Oak* (1961), *Blithe Spirit* (1962), and *The Waltz of the Toreadors* (1961). In 1969 she performed in *No Bed of Roses* at the Showplace Summer Theatre. Laurie also spent many productive years at The New Dimension Theatre Studio in Englewood, New Jersey where Dr. Richard Imundo was the Artistic Director. At The New Dimension she taught acting to children and young adults, and also performed in many productions including *Animal* (1971), *The Glass Menagerie*, and *Uncle Vanya* (1970). She also directed and acted in many evenings of scenes at The New Dimension. One of her early students at The New Dimension was a young man by the name of John Travolta who also performed with her in *Who'll Save the Plowboy?* (1966).

Having obtained her college degree from Fairleigh Dickinson University in Teaneck, New Jersey, she performed in a series of plays produced by the University Players, including *Ghosts*, *The Glass Menagerie*, and *J.B.* While studying for her masters degree at Montclair State College, she performed in several productions there including *The Hostage*, *Plaza Suite*, and *Not Now Darling*. Laurie also performed in *Cinderella* at the William Paterson College Summer Theatre Workshop, and in 1984 she performed in *The Devil's Disciple* at the Williamstown Theatre Festival in Williamstown, Massachusetts.

In 1983 Laurie starred as Emily Dickinson in the one-woman show *The Belle of Amherst*, directed by her friend and colleague, John Brancato. *The Belle of Amherst* had a limited run at The Tyson Studio in New York City to rave reviews in *The New York Times* and *The Daily News*.

Though many encouraged Laurie to pursue a professional acting career, she always made it clear that her true love was teaching and she dedicated much of her life to filling young students' hearts and minds with the love of theatre, both in its literary form and as a performing art. During her tenure in the 1970's as a fifth grade teacher at the Longfellow School in Teaneck, New Jersey, she directed an annual Shakespeare play starring her fifth grade students, performing the likes of *Macbeth*, *Julius Caesar* and *Hamlet*. Laurie's love of theater and teaching reached its pinnacle during her many years teaching English and Drama at Teaneck High School in Teaneck, New Jersey. She truly loved teaching drama to high school students, introducing them to the joys of acting and play-writing, and she directed an enormous number of full length productions, musicals, scenes, and student-written original plays. She directed too many shows to list individually, but they included *Cabaret*, *Diary of Anne Frank*, *A Midsummer Night's Dream*, *The Crucible*, *The Man Who Came To Dinner*, *Don't Drink the Water* and *Waiting for Godot*. In addition to these productions, she directed the students in an annual Evening of Scenes. Her students won many awards for their work at the annual Bucks County Playhouse Drama Festivals in Pennsylvania. Even after retirement from teaching, she continued to direct performances at Leonia High School, in Leonia, New Jersey.

In addition to acting and teaching, Laurie also edited three books for the theatre: *Scenes for Young Actors*, *Monologues for Young Actors*, and *Scenes for Mature Actors*, all published by Avon Books. These three books continue to be used today in acting classes and auditions around the country.

Laurie is remembered lovingly by her five children, her three siblings, her eight grandchildren, her companion Dick, her many colleagues and friends, and her innumerable students. It is in her memory that they support the 52nd Street Project. It is what she would have wanted.



The 52nd Street Project gratefully acknowledges the support of the following foundations & corporations: The Altman Foundation; BC Partners; BGC; Benihana/HARU; Bloomberg Philanthropies; The Brenner Family Foundation; Bull's Head Foundation, Inc.; Cantor Fitzgerald; Carnegie Corporation of New York; Maxine and Irving Castle Foundation; CBS Foundation, Inc.; The CLAWS Foundation; Comedy Central; Consolidated Edison; Dawkins Family Foundation; Dramatists Play Service, Inc.; Eleanor, Adam & Mel Dubin Foundation; Eileen Fisher, Inc.; Flexis Capital, LLC; Pamela and Wayne Garrison Family Foundation; The Horace W. Goldsmith Foundation; The Stephen P. Hanson Foundation; Heisman Trophy Trust; Hudson Scenic Studio; Lambert Family Foundation; Lemle Pictures, Inc.; Frederick Loewe Foundation; LRS Designs, Inc.; MTI; Newman's Own; The Stavros Niarchos Foundation; Ninth Avenue Association; Par Plumbing Co., Inc.; Sawyer | Berson Architecture & Landscape Architecture; The Morris and Alma Schapiro Fund; Schuss Realty Associates, LLC; The Shubert Organization; The Harold & Mimi Steinberg Charitable Trust; Sterling Foundation; Susquehanna Foundation; Tax Pro Financial Network, Inc.; Tiger Baron Foundation; TZP Group LLC; John A. Vassilaros & Sons, Inc.; Yorke Construction Corp.; Zubatkin Owner Representation, LLC. We also acknowledge the following individual donors to The 52nd Street Project:

Beth & Ray Abbott	Carolyn DeSena	Alan Howard	Courtney & Lowell Pettit
Robert Abrams & Cynthia Vance	Jordan Dickenstein	Linda LeRoy Janklow	Alice Phillips Swistel
George & Pam Ackert	Alan & Marion Dienstag	Andrea Johnson	& Daniel G. Swistel
Allison & Michael Anderson	Adam & Rebecca Dixon	Melissa Jones Briggs	Michael Popper
Richard Anthony & Avi Taussig	Aurora & Daniel Donofrio	Laura Jones	Elizabeth & Ryan Porter
Becky & Dylan Baker	Billy & Ellen Dreskin	Robert Joy & Henry Krieger	Sue Poulin
Eliza Baldi & David Costabile	Rebecca & Rick Dresser	Rebecca & Rick Kaden	Douglas M. Kaden
Beth Barry & Daniel Sussman	Peter Dufault	& Merritt Tilney	& Merritt Tilney
Jessica Bauman & Ben Posel	Laurel Durst	Eric Karpeles & Mike Sell	Eric Karpeles & Mike Sell
Lisa Benavides	Chrysti & David Eigenberg	Elliot & Kim Katz	Armando Riesco
& Tim Blake Nelson	Jeremy Erdreich	Anita Keal & Morton Wolkowitz	& Shirley Rumierk
Judy & Sam Berger	Wendy Ettinger	Beth & Clarke Keough	Annasophia Robb
Stephanie Berger & Paul King	Eddie Falco	Alicia Kershaw	Anita Rogerson
Gavin Berger & Craig Berggren	Anton Fig & Laura Sametz	Mary Kong	Daniel Rosen
Elizabeth & Eric Berman	Mark Fisher	Susannah Koteen	Lynne Rosenberg
Adam Bernstein	Katherine Fleming	& Mark Sweeney	Debra & Russell Rosenthal
& Jessica Hecht	Lindsay Fram & Mason Pettit	Joyce Krawiecki	Patricia Rosenthal
Stephen Bernstein	William Frank	Jan Kroeze & Jacki Ochs	David & Laura Ross
Francine Bizar	Karen & Paul Freitas	Ellen Kroll	Meg Rushton
Lewis Black	Gene Friedman	Richard Langan	Jim & Kim Russen
Allison Blinken	Louis & Patrice Friedman	Frances & Fred Langbecker	Lyle Saunders
Jane Bolster & Steve Wertimer	David Froelich & Cynthia Kaplan	Ruth & Sid Lapidus	Karin & Tom Schall
Byron Boston	Sally Froelich	Jené LeBlanc	David Seidman & Laura Valeroso
Buzz Bovshow	Janice Gabrilove	Cindy & Richard Leibovitch	Robert Shwartz
Richard & Samantha Brand	Jeannie & Jim Gaffigan	Adrienne Lobel	Jacqueline Simon
Becky Browder & Ted Neustadt	Pamela & Wayne Garrison	Edie Lutnick	Jeremy Smith
Leah Carr	Freddie & Myrna Gershon	John C. Lynch & Brenda Wehle	Stephen Sondheim
Gil Cass	Cathe Giffuni	Marsue & Peter MacNicol	Tim Stephenson
Chris Ceraso & Carla Meadows	Glen Gillen & Michael Lawrence	Greg MacPherson	& Adriana Trigiani
Lisa Chanel	Emily Giske & Annie Washburn	& Jane Perlmutter	Bob Stockel
Lisa & Matt Chanoff	Robert Goldberg	Bruce MacVittie & Carol Ochs	Abbie Strassler
Rachel Chanoff	Shari Goodstein	Dennis Manalo	David & Patty Straus
Navin & Preeti Choksi	Bruce Graham & Valerie Kay	Frank & Linda Mavronicolas	Jenni Swan
Ellen Chopay	Jill Graham and Jon Klein	Marjorie Mayrock	Richard Sweren
Katie & Kelly Clark	Stephen Graham	Pierce McCormack	Erica & Warren Thaler
Joel Coen	Susannah Gray & John Lyons	& Bruce Whitacre	Judy & Ron Tierney
& Frances McDormand	Melinda Griffith	Josie Merck	Lisa Tilney
Lisa Cohen & David Hillman	Kimberly Grigsby	Joe & Noël Mihalow	Suzanne Tobak
Robert Cohen	Emily Grishman	Drew Milstein	Craig & Madonna Turner
& Danielle Mindess	& Susan Sampliner	Carla & Yohan Minaya	Fred & Sarah Turpin
Ruth Cohen & Bob Usdin	Jan Gura & Alan Pickman	Donald Monti	Jan-Willem van den Dorpel
Sherry Cohen	Warren E. Hannas	Daryl & Michael Moss	Alexandra Vassilaros
Brad Coley	Susan Hanson	Amanda & Neal Moszkowski	Maria Vassilaros
& Wendy vanden Heuvel	Barnaby Harris & Suzie Kondi	& William Zucearia	& William Zucearia
Penny Collins	Karen Hauser & Warren Leight	Suzen Murakoshi	Mary Pat Walsh
Dan Colussy	Ann & David Hausmann	Randy & Rona Nelson	Sharon Washington
Megan Cramer	Amy Herzig	Ruth Nelson	Norbert Weissberg
Billy Crudup	Barbara & Eric Hippeau	Evan Newmark & Ellen West	David Weller
Michaela Culver	Josie Holtzman	Larry & Rachel Norton	Mark & Vicki Whatley
William Curran	& Isaac Kestenbaum	Debra Occhino	Susan Whitehead
& Patrice Delcasino	Willy Holtzman & Sylvia Shepard	Lori O'Connor	Carole Yass
Cathy Dantchik	Katy Homans & Patterson Sims	Beth & Bob Ollwether	Janine & Jeffrey Yass
Leslie Dantchik & Mitch Horowitz	Gary Horowitz & Alan Krevis	Kevin O'Rourke & Edith Thurber	Brett Young-Fountain
Robert Denenberg	Sarah Horowitz & David Venarde	F. Richard Pappas	Abby Zeichner
		George Petrides	

Donor List current as of 7/21/2017

THE 52ND STREET PROJECT PRESENTS

# STUFF & NONSENSE

PLAYS FROM THE PROP CLOSET

THE 2017 BLOCK ISLAND ONE-ON-ONES

THE 52ND STREET PROJECT'S  
FIVE ANGELS THEATER

FRIDAY, JULY 21 @ 7:30 P.M.  
SATURDAY, JULY 22 @ 7:30 P.M.  
SUNDAY, JULY 23 @ 3:00 P.M.

SMILE: ILLUSTRATION BY ROSALIND

## STUFF AND NONSENSE: PLAYS FROM THE PROP CLOSET

The Annual Block Island One-on-Ones - July 21-23, 2017 at the Five Angels Theater

### The 52nd Street Project Staff

Ahmed Attia, Development Associate\*  
 George Babiak, Director of Design and Production  
 Liz Bell, Director of Education  
 Molly Coogan, Acting Development Associate  
 Kali Crandall, Development Director  
 Brian Freeland, Production Manager  
 Natalie Hirsch, Artistic Director  
 Garrett Kim, Program Director  
 Carol Ochs, Executive Director  
 Gus Rogerson, Producing Director  
 John Sheehy, Director of Institutional Advancement  
 Johanna Vidal, Community Coordinator\*  
 Yazyzy Wilder, Office Manager\*

\*Project Alumnae

### Consultants:

Iris A. Brown, Graphic Designer; Chris Ceraso, Teen Dean

### Interns:

Eve Gertzman, Tony Macht, Jackie McKenna, Alicia Moeller

### Teen Employees:

Receptionists: Jade CuevaS, Chayse Peña, Karen Tineo, Britney Trinidad,  
 Ushers: Wilhelmina Ohene Kari Kari, Matthew Orozco, Karen Tineo, Britney Trinidad

## “STUFF AND NONSENSE” Production Staff

### Composer/Music Director

Avi A. Amon

### Set Designer

Kevin Joseph Roach

### Lighting Designer

Ry Burke

### Costume Designer

Lily Prentice

### Sound Designer

Jackie McKenna

### Stage Manager

Jenny Peek

### Projection Designs

George Babiak and The  
 52nd Street Project Projection Archive

### Prop Designs

George Babiak, Eve Gertzman,  
 and Alicia Moeller

### Backstage Crew

Eve Gertzman, Tony Macht,  
 Daniel Martinez, Alicia Moeller,  
 and Tiniyah Powell

### House Management

Carol Ochs, John Sheehy

### Flyer/Program Art

Patrick Jones

### Chefs

Martha Velie-Gass and Pat Ritter

### Teen Counselor

Tiniyah Powell

## COOL STUFF ON SALE IN THE LOBBY!

Fabulous Flyer Bars .....	\$2.50
<i>and featuring Shel Silverstein's "Fivey and Twoey" logo:</i>	
Project Hoodies .....	\$30.00
Project Caps .....	\$20.00
Project T-shirts .....	\$12.00/\$20.00
Project Water Bottle.....	\$12.00
Project Key Chain .....	\$7.00
Project Mugs .....	\$5.00
Project Notebook .....	\$5.00
Project Pencil 3-pack .....	\$1.00

Thank you for coming to STUFF AND NONSENSE. If you are not on our mailing list, you can join on-line at [www.52project.org](http://www.52project.org). If you're interested in being a volunteer, fill out the form below and hand it to one of our staffers in the lobby.

### PLEASE PUT ME ON YOUR LIST:

07/17

NAME \_\_\_\_\_

ADDRESS \_\_\_\_\_

CITY \_\_\_\_\_

STATE \_\_\_\_\_

ZIP \_\_\_\_\_

HOME PHONE \_\_\_\_\_

DAYTIME OR MOBILE PHONE \_\_\_\_\_

E-MAIL ADDRESS \_\_\_\_\_

MY OCCUPATION \_\_\_\_\_

MY HOBBIES \_\_\_\_\_

WANT TO BE GREEN AND SAVE THE PROJECT MONEY ON POSTAGE?  
 CHECK THIS BOX TO RECEIVE OUR NOTICES EXCLUSIVELY VIA E-MAIL.

### YES, I WOULD LIKE TO BE OF HELP. I CAN:

- |   |   |  |
|---|---|--|
| <input type="checkbox"/> Help load in and out for shows | <input type="checkbox"/> Draw and/or paint  | <input type="checkbox"/> Help kids with homework |
| <input type="checkbox"/> Hang lights                    | <input type="checkbox"/> Help with mailings | <input type="checkbox"/> Teach kids a skill      |
| <input type="checkbox"/> Work on a backstage crew       | <input type="checkbox"/> Do office work     | <input type="checkbox"/> Be a chef at an event   |
| <input type="checkbox"/> Do graphic design              | <input type="checkbox"/> Design sound       | <input type="checkbox"/> Design and sew costumes |
| <input type="checkbox"/> Other (please specify) _____   |   |  |

### MY SCHEDULE IS:

- Very flexible. I'm often available during weekdays.  
 Somewhat flexible. I can help on the occasional morning or afternoon during the week.  
 Not very flexible at all, but I've got some free time on evenings and weekends.

If you would like to mail this (and you're always welcome to enclose a tax-deductible contribution), you can send it to: The 52nd Street Project, 789 10th Avenue, New York, NY 10019. Or fax it to (212) 333-5598.



The One-on-One Program is made possible with public funds from The New York State Council on the Arts, a state agency, and the New York City Department of Cultural Affairs. This project is supported in part by an award from the National Endowment for the Arts. The 52nd Street Project is a member of Art/NY and Theatre Communications Group (TCG), the national organization for the American theatre.

COME BACK NEXT MONTH FOR...

THE 52ND STREET PROJECT PRESENTS

# STUFF & NONSENSE

PLAYS FROM THE PROP CLOSET

THE 2ND SHIPMENT

NETALE FRISK  
ARTISTIC DIRECTOR

CAROL OCHS  
EXECUTIVE DIRECTOR

GUS ROGERSON  
PRODUCTION DIRECTOR

THE 2017 WAREHAM, MASS. ONE-ON-ONES

IN ADULT-WRITTEN PLAYS  
FEATURING KIDS AND ADULTS  
ON STAGE TOGETHER!  
EACH TEAMS PLAY MUST  
INCORPORATE A RANDOMLY  
DRAWN PROP FROM  
THE PROJECT'S COLLECTION

FRIDAY, AUGUST 18 @ 7:30 P.M.  
SATURDAY, AUGUST 19 @ 7:30 P.M.  
SUNDAY, AUGUST 20 @ 3:00 P.M.

**THE 52ND STREET PROJECT'S FIVE ANGELS THEATER**

789 10TH AVENUE, BETWEEN 52ND & 53RD STREETS  
ADMISSION FREE! RESERVE YOUR SEATS AT [WWW.52PROJECT.ORG](http://WWW.52PROJECT.ORG)

## The 52nd Street Project Board of Directors

Lisa Benavides  
Rachel Chanoff  
Cathy Dantchik, co-chair  
Carolyn DeSena  
Wendy Ettinger, chair emeritus  
Louis P. Friedman, co-chair  
Alexandra Gersten-Vassilaros  
Robert Goldberg  
Stephen Graham,  
chair emeritus  
Valerie Kay

Frances McDormand  
Noël Mihalow  
Carol Ochs  
Willie Reale, founder  
Gus Rogerson  
Shirley Rumierk, alumni member  
José Soto, Jr., alumni member  
Merritt Tilney  
Wendy vanden Heuvel  
Mark Whatley

### What's Going On Here?

The 52nd Street Project is a non-profit organization that brings children from the Hell's Kitchen neighborhood together with professional theater artists to create original theater. STUFF AND NONSENSE is a production of our One-on-One program, which is designed to give children the opportunity to go away for one-week stays in the country and enjoy the undivided attention of a professional theater artist who serves as friend, mentor, and collaborator.

### In-Kind Contributions

Abbeville Press; Best Barber; Lewis Black; Brooklyn Brewery; Iris A. Brown Design; Navin Choksi; City Winery; William Curran & A Curran Affair; The Daily Show's Trevor Noah; Jenny Gersten; Haru Restaurant of Hell's Kitchen; ICI; Karen Kowgios of Fried & Kowgios; The Late Show with Stephen Colbert; Make My Cake; Charlie Marshal; Noël Mihalow & Prime Films; Natasha, Pierre, and the Great Comet of 1812; Lauren Friedman, Pharma/Omni Printing; Winston Rodney Photography; Stephen Sondheim; Jenny Steingart; Merritt Tilney & Doug Kaden; Tito's Vodka; Robin Treadway; John A. Vassilaros & Sons; The Vassilaros Family; Watkins Inc.; Steve Olsen and the WestBank Cafe; and Paul, Rifkind, Wharton, & Garrison LLP.

### Special Thanks

Our Host Families- Kate and Sam Bird; Socha Cohen, Virginia Dare; Cathy Joyce & Nigel Grindley; Katy Homans and Patterson Sims; Susan Matheke and Willie Feuer; Josie Merck; Susan and Ray Torrey; and our magnanimous headquarters host Carl Kaufmann. Sincere thanks to our chefs Martha Velie-Gass, Pat & Wayne Ritter; Interstate Navigation; McQuade's Marketplace; Robbie Brown; Rita and Steve Draper; Kim Gaffett; Glenn and Annie Hall; The Yellow Kittens; Mark Helterline & Mary Jane Balser and the Block Island Grocery; .



### KEEP AN EYE OUT FOR INTERNS!

If you know of any college or graduate students who might enjoy working with us, playing with us, and going on trips with us for a semester, please have them contact Yazyzy Wilder at [ywilder@52project.org](mailto:ywilder@52project.org). We are especially looking for interns for Fall, 2018.



## STUFF AND NONSENSE: PLAYS FROM THE PROP CLOSET - ACT 1

All original music composed by Avi A. Amon  
*Stuff and Nonsense Theme Song* lyrics by John Sheehy

### A CUSTOMER

By Sarah Hammond for Nyla Blake Soden, age 10  
*From the Prop Closet: An old-fashioned rotary desk phone*

Laynie ..... Nyla Blake Soden  
Gladiola ..... Erin Felgar

*Dream Travel* lyrics by Sarah Hammond

### HEADWINDS ON THE HUDSON

By Tim J. Lord for Aaron Ordinola, age 10  
*From the Prop Closet: A wing-flapping pigeon*

Agent Mark Rollins ..... Aaron Ordinola  
John Jacob Astor ..... Jose Joaquin Perez  
Shorty ..... Tony Macht  
Dale ..... Tiniyah Powell  
Janine ..... Alicia Moeller  
Rivera ..... Daniel Martinez

*Headwinds on the Hudson* lyrics by Tim J. Lord

### LITTLE FISH, BIG BEEF

By Stephanie Jean Lane for Faith Villanueva, age 9  
*From the Prop Closet: A treasure chest*

Little Fish ..... Faith Villanueva  
Big Fish ..... Tony Macht  
Mermonster ..... Stephanie Jean Lane

*Fish Mission* lyrics by Stephanie Jean Lane

### THE DUMMY

By Itamar Moses for Ahmed Shabana, age 11  
*From the Prop Closet: A "We're #1" foam finger*

Doctor Jenkins ..... Ahmed Shabana  
Bruce ..... Sebastian Roy  
Billy ..... Himself

*Bruce and I* lyrics by Itamar Moses

### TWO SISTERS

By Elizabeth Irwin for Morgan Smalls, age 10  
*From the Prop Closet: A nest with four eggs*

Star ..... Morgan Smalls  
Maxine ..... Naomi Lorrain  
Mrs. Claus ..... Tiniyah Powell

*Chicken* lyrics by Elizabeth Irwin

## STUFF AND NONSENSE: PLAYS FROM THE PROP CLOSET - ACT 2

### CAREER CRIMINALS

By KeiLyn Durrel Jones for Gilbert Rosario, age 11  
*From the Prop Closet: A fancy gold purse*

Winston ..... Gilbert Rosario  
Timothy ..... KeiLyn Durrel Jones

*Re-Tired of You* lyrics by KeiLyn Durrel Jones

### HOVER AND OUT

By John Sheehy for Lovely Ramirez, age 11  
*From the Prop Closet: A big, yellow hovercraft*

Aliz ..... Lovely Ramirez  
Matt ..... John Sheehy

*The Riddle* lyrics by John Sheehy

### NEW DOG IN TOWN

By Cynthia Kaplan for Love Jones, age 11  
*From the Prop Closet: A BlastMaster Rocket Launcher*

Millie ..... Love Jones  
Clover ..... Molly Carden  
Farmer Bob ..... George Babiak  
Suzy ..... Tiniyah Powell  
Toby ..... Alicia Moeller

*What's a Goat Got?* lyrics by Cynthia Kaplan

### THE DIPLOMAT AND SCHLUB

By Grant Harrison for Gage Simmons, age 11  
*From the Prop Closet: An attaché case*

The Diplomat ..... Gage Simmons  
Schlub ..... Hannes Otto  
Airport Voice ..... Alicia Moeller  
Ticket Taker ..... Tiniyah Powell  
George ..... George Babiak

*Can't Believe I'm Doing This/Traveling the World* lyrics by Grant Harrison

### ONE BEEF TACO

By Lynn Rosen for Hannah Leon, age 9  
*From the Prop Closet: One beef taco*

Amy ..... Hannah Leon  
Flibburg ..... Eliza Huberth

*Head in the Sky/Beeper Bikzing Blains* lyrics by Lynn Rosen

The 52nd Street Project gratefully acknowledges the support of the following foundations & corporations: The Altman Foundation; BC Partners; BGC; Benihana/HARU; Bloomberg Philanthropies; The Brenner Family Foundation; Bull's Head Foundation, Inc.; Cantor Fitzgerald; Carnegie Corporation of New York; Maxine and Irving Castle Foundation; CBS Foundation, Inc.; The CLAWS Foundation; Comedy Central; Consolidated Edison; Dawkins Family Foundation; Dramatists Play Service, Inc.; Eleanor, Adam & Mel Dubin Foundation; Eileen Fisher, Inc.; Flexis Capital, LLC; Pamela and Wayne Garrison Family Foundation; The Horace W. Goldsmith Foundation; The Stephen P. Hanson Foundation; Heisman Trophy Trust; Hudson Scenic Studio; Lambert Family Foundation; Lemle Pictures, Inc.; Frederick Loewe Foundation; LRS Designs, Inc.; MTI; Newman's Own; The Stavros Niarchos Foundation; Ninth Avenue Association; Par Plumbing Co., Inc.; Sawyer | Berson Architecture & Landscape Architecture; The Morris and Alma Schapiro Fund; Schuss Realty Associates, LLC; The Shubert Organization; The Harold & Mimi Steinberg Charitable Trust; Sterling Foundation; Susquehanna Foundation; Tax Pro Financial Network, Inc.; Tiger Baron Foundation; TZP Group LLC; John A. Vassilaros & Sons, Inc.; Yorke Construction Corp.; Zubatkin Owner Representation, LLC. We also acknowledge the following individual donors to The 52nd Street Project:

Beth & Ray Abbott  
Robert Abrams & Cynthia Vance  
George & Pam Ackert  
Allison & Michael Anderson  
Richard Anthony & Avi Taussig  
Becky & Dylan Baker  
Eliza Baldi & David Costabile  
Beth Barry & Daniel Sussman  
Jessica Bauman & Ben Posel  
Lisa Benavides  
& Tim Blake Nelson  
Judy & Sam Berger  
Stephanie Berger & Paul King  
Gavin Berger & Craig Berggren  
Elizabeth & Eric Berman  
Adam Bernstein  
& Jessica Hecht  
Stephen Bernstein  
Francine Bizar  
Lewis Black  
Allison Blinken  
Jane Bolster & Steve Wertimer  
Byron Boston  
Buzz Bovshow  
Richard & Samantha Brand  
Becky Browder & Ted Neustadt  
Leah Carr  
Gil Cass  
Chris Ceraso & Carla Meadows  
Lisa Chanel  
Lisa & Matt Chanoff  
Rachel Chanoff  
Navin & Preeti Choksi  
Ellen Chopay  
Katie & Kelly Clark  
Joel Coen  
& Frances McDormand  
Lisa Cohen & David Hillman  
Robert Cohen  
& Danielle Mindess  
Ruth Cohen & Bob Usdin  
Sherry Cohen  
Brad Coley  
& Wendy vanden Heuvel  
Penny Collins  
Dan Colussy  
Megan Cramer  
Billy Crudup  
Michaela Culver  
William Curran  
& Patrice Delcasino  
Cathy Dantchik  
Leslie Dantchik & Mitch Horowitz  
Robert Denenberg

Carolyn DeSena  
Jordan Dickenstein  
Alan & Marion Dienstag  
Adam & Rebecca Dixon  
Aurora & Daniel Donofrio  
Billy & Ellen Dreskin  
Rebecca & Rick Dresser  
Peter Dufault  
Laurel Durst  
Chrysti & David Eigenberg  
Jeremy Erdreich  
Wendy Ettinger  
Edie Falco  
Anton Fig & Laura Sametz  
Mark Fisher  
Katherine Fleming  
Lindsay Fram & Mason Pettit  
William Frank  
Karen & Paul Freitas  
Gene Friedman  
Louis & Patrice Friedman  
David Froelich & Cynthia Kaplan  
Sally Froelich  
Janice Gabrilove  
Jeannie & Jim Gaffigan  
Pamela & Wayne Garrison  
Freddie & Myrna Gershon  
Cathe Giffuni  
Glen Gillen & Michael Lawrence  
Emily Giske & Annie Washburn  
Robert Goldberg  
Shari Goodstein  
Bruce Graham & Valerie Kay  
Jill Graham and Jon Klein  
Stephen Graham  
Susannah Gray & John Lyons  
Melinda Griffith  
Kimberly Grigsby  
Emily Grishman  
& Susan Sampliner  
Jan Gura & Alan Pickman  
Warren E. Hannas  
Susan Hanson  
Barnaby Harris & Suzie Kondi  
Karen Hauser & Warren Leight  
Ann & David Hausmann  
Amy Herzig  
Barbara & Eric Hippiau  
Josie Holtzman  
& Isaac Kestenbaum  
Willy Holtzman & Sylvia Shepard  
Katy Homans & Patterson Sims  
Gary Horowitz & Alan Kreis  
Sarah Horowitz & David Venarde

Alan Howard  
Linda LeRoy Janklow  
Andrea Johnson  
Melissa Jones Briggs  
Laura Jones  
Robert Joy & Henry Krieger  
Douglas M. Kaden  
& Merritt Tilney  
Eric Karpeles & Mike Sell  
Elliot & Kim Katz  
Anita Keal & Morton Wolkowitz  
Beth & Clarke Keough  
Alicia Kershaw  
Mary Kong  
Susannah Koteen  
& Mark Sweeney  
Joyce Krawiecki  
Jan Kroeze & Jacki Ochs  
Ellen Kroll  
Richard Langan  
Frances & Fred Langbecker  
Ruth & Sid Lapidus  
Jené LeBlanc  
Cindy & Richard Leibovitch  
Adrienne Lobel  
Edie Lutnick  
John C. Lynch & Brenda Wehle  
Marsue & Peter MacNicol  
Greg MacPherson  
& Jane Perlmutter  
Bruce MacVittie & Carol Ochs  
Dennis Manalo  
Frank & Linda Mavronicolas  
Marjorie Mayrock  
Pierce McCormack  
& Bruce Whitacre  
Josie Merck  
Joe & Noël Mihalow  
Drew Milstein  
Carla & Yohan Minaya  
Donald Monti  
Daryl & Michael Moss  
Amanda & Neal Moszkowski  
Suzen Murakoshi  
Randy & Rona Nelson  
Ruth Nelson  
Evan Newmark & Ellen West  
Larry & Rachel Norton  
Debra Oochino  
Lori O'Connor  
Beth & Bob Ollwerther  
Kevin O'Rourke & Edith Thurber  
F. Richard Pappas  
George Petrides

Courtney & Lowell Pettit  
Alice Phillips Swistel  
& Daniel G. Swistel  
Michael Popper  
Elizabeth & Ryan Porter  
Sue Poulin  
Ivy & Michael Rachlin  
Helen & Peter Randolph  
Willie Reale  
Armando Riesco  
& Shirley Rumieck  
Annasophia Robb  
Anita Rogerson  
Daniel Rosen  
Lynne Rosenberg  
Debra & Russell Rosenthal  
Patricia Rosenthal  
David & Laura Ross  
Meg Rushton  
Jim & Kim Russen  
Lyle Saunders  
Karin & Tom Schall  
David Seidman & Laura Valeroso  
Robert Shwartz  
Jacqueline Simon  
Jeremy Smith  
Stephen Sondheim  
Tim Stephenson  
& Adriana Trigiani  
Bob Stockel  
Abbie Strassler  
David & Patty Straus  
Jenni Swan  
Richard Sweren  
Erica & Warren Thaler  
Judy & Ron Tierney  
Lisa Tilney  
Suzanne Tobak  
Craig & Madonna Turner  
Fred & Sarah Turpin  
Jan-Willem van den Dorpel  
Alexandra Vassilaros  
Maria Vassilaros  
& William Zucearia  
Mary Pat Walsh  
Sharon Washington  
Norbert Weissberg  
David Weller  
Mark & Vicki Whatley  
Susan Whitehead  
Carole Yass  
Janine & Jeffrey Yass  
Brett Young-Fountain  
Abby Zeichner

THE 52ND STREET PROJECT PRESENTS

# STUFF & NONSENSE

PLAYS FROM THE PROP CLOSET

THE 2017 WAREHAM, MASSACHUSETTS ONE-ON-ONES

THE 52ND STREET PROJECT'S  
FIVE ANGELS THEATER

FRIDAY, AUG. 18 @ 7:30 P.M.  
SATURDAY, AUG. 19 @ 7:30 P.M.  
SUNDAY, AUG. 20 @ 3:00 P.M.

NETWORK BY PATRICK JONES

## STUFF AND NONSENSE: PLAYS FROM THE PROP CLOSET

The Annual Wareham, Mass. One-on-Ones - Aug. 18-20, 2017 at the Five Angels Theater

### The 52nd Street Project Staff

Ahmed Attia, Development Associate\*  
 George Babiak, Director of Design and Production  
 Liz Bell, Director of Education  
 Molly Coogan, Acting Development Associate  
 Kali Crandall, Development Director  
 Brian Freeland, Production Manager  
 Natalie Hirsch, Artistic Director  
 Garrett Kim, Program Director  
 Carol Ochs, Executive Director  
 Gus Rogerson, Producing Director  
 John Sheehy, Director of Institutional Advancement  
 Johanna Vidal, Community Coordinator\*  
 Yazyzy Wilder, Office Manager\*

\*Project Alumnae

### Consultants:

Iris A. Brown, Graphic Designer; Chris Ceraso, Teen Dean

### Interns:

Eve Gertzman, Tony Macht, Jackie McKenna, Alicia Moeller

### Teen Employees:

Receptionists: Jade CuevaS, Chayse Peña, Karen Tineo, Britney Trinidad,  
 Ushers: Wilhelmina Ohene Kari Kari, Matthew Orozco, Karen Tineo, Britney Trinidad

### “CLOTHES LINES” Production Staff

#### Composer/Music Director

Wes Braver

#### Set Designer

Kevin Joseph Roach

#### Lighting Designer

Josh Langman

#### Costume Designer

Susanne Houstle

#### Sound Designer

Alicia Moeller

#### Stage Manager

Emma Steiger

#### Projection Designs

George Babiak and The  
 52nd Street Project Projection Archive

#### Prop Designs

George Babiak

#### Backstage Crew

Eve Gertzman, Tatiana Goode,  
 Tony Macht, Jackie McKenna,  
 Wilhelmina Ohene Kari Kari

#### House Management

Carol Ochs, John Sheehy

#### Flyer/Program Art

Patrick Jones

#### Chefs

John Sheehy & Liz Bell

#### Teen Counselor

Tatiana Goode

## COOL STUFF ON SALE IN THE LOBBY!

Fabulous Flyer Bars .....	\$2.50
<i>and featuring Shel Silverstein's "Fivey and Twoey" logo:</i>	
Project Hoodies .....	\$30.00
Project Caps .....	\$20.00
Project T-shirts .....	\$12.00/\$20.00
Project Water Bottle.....	\$12.00
Project Key Chain .....	\$7.00
Project Mugs .....	\$5.00
Project Notebook .....	\$5.00
Project Pencil 3-pack .....	\$1.00

Thank you for coming to STUFF AND NONSENSE. If you are not on our mailing list, you can join on-line at [www.52project.org](http://www.52project.org). If you're interested in being a volunteer, fill out the form below and hand it to one of our staffers in the lobby.

### PLEASE PUT ME ON YOUR LIST:

08/17

NAME \_\_\_\_\_

ADDRESS \_\_\_\_\_

CITY \_\_\_\_\_

STATE \_\_\_\_\_

ZIP \_\_\_\_\_

HOME PHONE \_\_\_\_\_

DAYTIME OR MOBILE PHONE \_\_\_\_\_

E-MAIL ADDRESS \_\_\_\_\_

MY OCCUPATION \_\_\_\_\_

MY HOBBIES \_\_\_\_\_

WANT TO BE GREEN AND SAVE THE PROJECT MONEY ON POSTAGE?  
 CHECK THIS BOX TO RECEIVE OUR NOTICES EXCLUSIVELY VIA E-MAIL.

### YES, I WOULD LIKE TO BE OF HELP. I CAN:

- |   |   |  |
|---|---|--|
| <input type="checkbox"/> Help load in and out for shows | <input type="checkbox"/> Draw and/or paint  | <input type="checkbox"/> Help kids with homework |
| <input type="checkbox"/> Hang lights                    | <input type="checkbox"/> Help with mailings | <input type="checkbox"/> Teach kids a skill      |
| <input type="checkbox"/> Work on a backstage crew       | <input type="checkbox"/> Do office work     | <input type="checkbox"/> Be a chef at an event   |
| <input type="checkbox"/> Do graphic design              | <input type="checkbox"/> Design sound       | <input type="checkbox"/> Design and sew costumes |
| <input type="checkbox"/> Other (please specify) _____   |   |  |

### MY SCHEDULE IS:

- Very flexible. I'm often available during weekdays.  
 Somewhat flexible. I can help on the occasional morning or afternoon during the week.  
 Not very flexible at all, but I've got some free time on evenings and weekends.

If you would like to mail this (and you're always welcome to enclose a tax-deductible contribution), you can send it to: The 52nd Street Project, 789 10th Avenue, New York, NY 10019. Or fax it to (212) 333-5598.



The One-on-One Program is made possible with public funds from The New York State Council on the Arts, a state agency, and the New York City Department of Cultural Affairs. This project is supported in part by an award from the National Endowment for the Arts. The 52nd Street Project is a member of Art/NY and Theatre Communications Group (TCG), the national organization for the American theatre.

## COMING UP AT THE PROJECT...

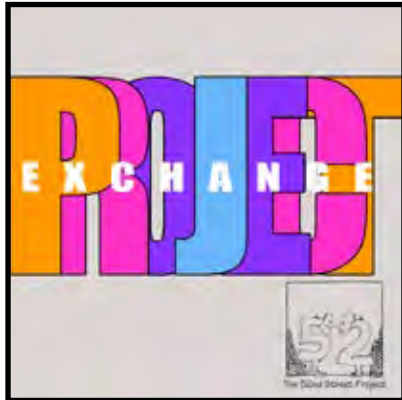

### PROJECT EXCHANGE: WIN PLAYMAKING

A Special Show  
at a Special Time

TUESDAY,  
AUGUST 22, 6PM

A staged reading of our latest program. Over the past month, The 52nd Street Project has been piloting a Playmaking expansion with WIN (Women In Need), bringing our Playmaking programming to the children in their organization. Come see the results of the kids' work presented in semi-staged readings on Tuesday, August 22, 6 p.m., here at our Five Angels Theater, admission is free, as always. Reservations can be made at [www.52project.org](http://www.52project.org)

## THE 2017 PLAYBACK PLAYS

The reverse of the One-on-Ones! Kids write plays for themselves and an adult partner to perform together.

October 27-29 right here at

**THE FIVE ANGELS THEATER**



### KEEP AN EYE OUT FOR INTERNS!

If you know of any college or graduate students who might enjoy working with us, playing with us, and going on trips with us for a semester, please have them contact Garrett Kim. We are especially looking for interns for Spring 2018.

### The 52nd Street Project Board of Directors

Lisa Benavides  
Rachel Chanoff  
Cathy Dantchik, co-chair  
Carolyn DeSena  
Wendy Ettinger, chair emeritus  
Louis P. Friedman, co-chair  
Alexandra Gersten-Vassilaros  
Robert Goldberg  
Stephen Graham,  
chair emeritus  
Valerie Kay

Frances McDormand  
Noël Mihalow  
Carol Ochs  
Willie Reale, founder  
Gus Rogerson  
Shirley Rumierk, alumni member  
José Soto, Jr., alumni member  
Merritt Tilney  
Wendy vanden Heuvel  
Mark Whatley

---

### What's Going On Here?

The 52nd Street Project is a non-profit organization that brings children from the Hell's Kitchen neighborhood together with professional theater artists to create original theater. **STUFF AND NONSENSE** is a production of our One-on-One program, which is designed to give children the opportunity to go away for one-week stays in the country and enjoy the undivided attention of a professional theater artist who serves as friend, mentor, and collaborator.

---

### In-Kind Contributions

Abbeville Press; Best Barber; Lewis Black; Brooklyn Brewery; Iris A. Brown Design; Navin Choksi; City Winery; William Curran & A Curran Affair; The Daily Show's Trevor Noah; Jenny Gersten; Haru Restaurant of Hell's Kitchen; ICI; Karen Kowgios of Fried & Kowgios; The Late Show with Stephen Colbert; Make My Cake; Charlie Marshal; Noël Mihalow & Prime Films; Natasha, Pierre, and the Great Comet of 1812; Lauren Friedman, Pharma/Omni Printing; Winston Rodney Photography; Stephen Sondheim; Jenny Steingart; Merritt Tilney & Doug Kaden; Tito's Vodka; Robin Treadway; John A. Vassilaros & Sons; The Vassilaros Family; Watkins Inc.; Steve Olsen and the WestBank Cafe; and Paul, Rifkind, Wharton, & Garrison LLP.

---

### Special Thanks

Our Host Families- Peter, Helen & Christopher Randolph; Joe McNay; Lucy Aptekar & Gerry Leader; Andrea & Emmanuel Daskalakis; Anne & Colin McNay; Gray & Rosemary Watson; Sherbie & Tom Worthen.

## STUFF AND NONSENSE: PLAYS FROM THE PROP CLOSET II - ACT 1

All original music composed by Wes Braver  
*Stuff and Nonsense Theme Song* lyrics by John Sheehy

### SWEET TOOTH GOES TO CANDYWORLD

Written by Christina Quintana for Thiana Goode, age 12.

Directed by Jenelle Chu.

*From the Prop Closet: A sad, black cat*

Ambrosia ..... Thiana Goode  
Love Lee ..... Jenelle Chu  
Candy Worldian ..... John Sheehy

*Gotta Let That Go* lyrics by Christina Quintana

### A RECKONING

Written and Directed by Carlo Alban for Derek Rey, age 13.

*From the Prop Closet: A chainsaw*

Red ..... Derek Rey  
Ken ..... Carlo Alban  
Customer ..... Eve Gertzman  
Meow Meow ..... Jackie McKenna

*A Reckoning* lyrics by Carlo Alban

### WORLDS ON A STRING

Written by Melissa Gawlowski for Kailey Canton, age 10.

Directed by Margaret Odette.

*From the Prop Closet: A brass trumpet*

Louise ..... Kailey Canton  
Rita ..... Margaret Odette  
Velociraptor ..... Tony Macht  
Lab Lady ..... Tatiana Goode

*Sometimes You Gotta* lyrics by Melissa Gawlowski

### ALPHA BETTA ZETA

Written and Directed by Michael Propster for Carlos Jimenez, age 11.

*From the Prop Closet: A goldfish*

Krem, A Red Betta Fighting Fish ..... Carlos Jimenez  
Trey, A Blue Betta Fighting Fish ..... Michael Propster

*Instinct or History* lyrics by Michael Propster

### LIZARDBELLY LIVES!

Written and Directed by George Babiak for Joel Gokalp, age 10.

*From the Prop Closet: A black cauldron*

Rip Current ..... Joel Gokalp  
Crush Dice ..... George Babiak  
Sticks McGee ..... Jackie McKenna  
Les Ismore ..... Wes Braver

*Troublemaker* lyrics by George Babiak

## STUFF AND NONSENSE: PLAYS FROM THE PROP CLOSET II - ACT 2

### HOW TO COOK LIKE A PRO

Written By Melisa Tien for Jade Johnson, age 10.

Directed by Flor De Liz Perez.

*From the Prop Closet: A human skull*

Janice ..... Jade Johnson  
Florence ..... Flor De Liz Perez  
The Lobster ..... Jackie McKenna  
Voice of the Producer ..... Tony Macht

*Give Me A Reason* lyrics by Melisa Tien

### MOTOR WORLD GALORE

Written by Tahnee Cadrez for Ethan Zenteno, age 13.

Directed by Helen Cespedes.

*From the Prop Closet: A sporty red convertible*

Eugene ..... Ethan Zenteno  
Kenny ..... Helen Cespedes  
Marty ..... Eve Gertzman

*I'm Gonna* lyrics by Tahnee Cadrez

### SAKI'S LESSON

Written and Directed by Danielle Davenport for Bryanna Ohene Kari Kari, age 12.

*From the Prop Closet: A microscope*

Saki, a stylish 13-Year-Old ..... Bryanna Ohene Kari Kari  
Principal Abassi/ Woman/ Liz, Saki's Mother ..... Danielle Davenport

*A Strange Thing* lyrics by Danielle Davenport

### JOURNEY TO GOLD MOUNTAIN

Written and Directed by Jed Clarke for Jayden Alvarado, age 10.

*From the Prop Closet: A campfire*

Sir Russell of the Hillside ..... Jayden Alvarado  
Lord Chauncey of the Bay ..... Jed Clarke  
Queen ..... Tatiana Goode  
Dragon ..... George Babiak  
Mountain Lion ..... Jackie McKenna

*To The Top Of Gold Mountain* lyrics by Jed Clarke

### THANKSGIVING

Written and Directed by Corey Jackson for Amari DuBose, age 11.

*From the Prop Closet: A jetpack*

Holloway ..... Amari DuBose  
Beezer ..... Corey Jackson  
Turkey ..... John Sheehy

*This Turkey Can Fly* lyrics by Corey Jackson

### **The 52nd Street Project Staff**

Ahmed Attia, Development Associate\*  
George Babiak, Director of Design and Production  
Liz Bell, Director of Education  
Kali Crandall, Development Director  
Brian Freeland, Production Manager  
Natalie Hirsch, Artistic Director  
Garrett Kim, Program Director  
Carol Ochs, Executive Director  
Gus Rogerson, Producing Director  
John Sheehy, Director of Institutional Advancement  
Johanna Vidal, Community Coordinator\*  
Yazzy Wilder, Office Manager\*

*\*Project Alumni*

### **Consultants**

Iris A. Brown, Graphic Designer  
Chris Ceraso, Teen Dean

### **Interns**

Eve Gertzman, Tony Macht, Jackie McKenna, Alicia Moeller

### **Teen Employees**

Receptionists: Chayse Peña, Karen Tineo, Britney Trinidad  
Ushers: Daniel Martinez, Kayla Ortiz, Tinish Powell, Britney Trinidad

### **The 52nd Street Project Board of Directors**

Lisa Benavides	Frances McDormand
Rachel Chanoff	Noël Mihalow
Cathy Dantchik, co-chair	Carol Ochs
Carolyn DeSena	Willie Reale, founder
Wendy Ettinger, chair emeritus	Gus Rogerson
Louis P. Friedman, co-chair	Shirley Rumierk, alumni member
Alexandra Gersten-Vassilaros	José Soto, Jr., alumni member
Robert Goldberg	Merritt Tilney
Stephen Graham, chair emeritus	Wendy vanden Heuvel
Valerie Kay	Mark Whatley

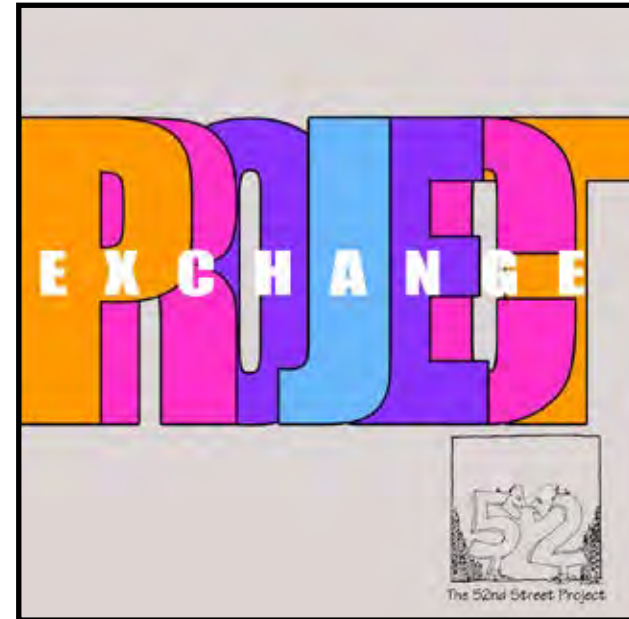

# **THE 52ND STREET PROJECT EXCHANGE: WIN PLAYMAKING READINGS SUMMER 2017**

**TUESDAY, AUGUST 22**

**6:00 PM**

**THE FIVE ANGELS THEATER  
789 10th Avenue**



The 52nd Street Project (aka, The Project) is a non-profit arts organization that brings children from the Hell's Kitchen neighborhood together with professional artists to create original art.

Project Exchange is a brand new initiative of the Project that reaches out into the city beyond our established target community in Hell's Kitchen. With the help of partner service organizations and our volunteer artists, we hope to bring Playmaking and other Project programs to many other parts of the greater New York area. The plays you will see read tonight are the fruit of our pilot Playmaking class with Win. We hope you enjoy our presentation.

### THE PROJECT EXCHANGE TEAM

- Playmaking Director ..... Joanna Gurin
- Jose Gamo ..... Associate Playmaking Director
- Britney Trinidad..... Teen Employee
- Lighting Designer..... Brian Freeland
- Light board Operator ..... ?
- Sound board Operator..... ?
- Props ..... George Babiak

### Playmaking Mentors

Paco Lozano, Tracy Sayre, Brittany Miller

### Special Thanks to...

Katie Tynes, Cynthia Snyder, Rosa Boone, Tamara Ortiz



Project Exchange is made possible with public funds from The New York State Council on the Arts, a state agency, and the New York City Department of Cultural Affairs. This project is supported in part by an award from the National Endowment for the Arts. The 52nd Street Project is a member of Art/NY and Theatre Communications Group (TCG), the national organization for the American theatre.

# THE 52ND STREET PROJECT EXCHANGE: WIN PLAYMAKING SUMMER 2017

## The Missing Tadpole

by D'Asia  
 Dramaturge: Kym Boyce, Director: Natalie Hirsch

Liam..... Genesis Oliver  
 Mason..... Omar Metwally  
 Arianna ..... Natalie Hirsch  
 Brittany ..... Sofiya Akilova

☆☆☆

## The Warrior's Death

by Xavier  
 Dramaturge/Director: Julia Rae Maldonado

Bolt ..... Bjorn DuPaty  
 Kayden the Panther..... Kyle Cameron  
 Evil Lion / Jake ..... Kyle Cameron  
 Elder Lion ..... Julia Rae Maldonado

☆☆☆

## Marquis Meets Polo at the Airport

by Laniya  
 Dramaturge/Director: Morgan McGuire

Marquis..... Helen Cespedes  
 Polo ..... Eliza Huberth  
 Lisa the Flight Attendant..... Sofiya Akilova

☆☆☆

## Conquistando Il Trono (Conquering the Throne)

by Brandon  
 Dramaturge: Beth Petrenko, Director: Jose Gamo

Leo..... Jennifer Ikeda  
 Queen Rosa ..... Flor De Liz Perez  
 Skully ..... Stephen O'Reilly

☆☆☆

## Turtle and the Fish

by Analiz  
 Dramaturge/Director: Ben Gurin

Fwishy ..... Arielle Goldman  
 Jawad ..... Korey Jackson

The 52nd Street Project gratefully acknowledges the support of the following foundations & corporations: The Altman Foundation; BC Partners; BGC; Benihana/HARU; Bloomberg Philanthropies; The Brenner Family Foundation; Bull's Head Foundation, Inc.; Cantor Fitzgerald; Carnegie Corporation of New York; Maxine and Irving Castle Foundation; CBS Foundation, Inc.; The CLAWS Foundation; Comedy Central; Consolidated Edison; Dawkins Family Foundation; Dramatists Play Service, Inc.; Eleanor, Adam & Mel Dubin Foundation; Eileen Fisher, Inc.; Flexis Capital, LLC; Pamela and Wayne Garrison Family Foundation; The Horace W. Goldsmith Foundation; The Stephen P. Hanson Foundation; Heisman Trophy Trust; Hudson Scenic Studio; Lambert Family Foundation; Lemle Pictures, Inc.; Frederick Loewe Foundation; LRS Designs, Inc.; MTI; Newman's Own; The Stavros Niarchos Foundation; Ninth Avenue Association; Par Plumbing Co., Inc.; Sawyer | Berson Architecture & Landscape Architecture; The Morris and Alma Schapiro Fund; Schuss Realty Associates, LLC; The Shubert Organization; The Harold & Mimi Steinberg Charitable Trust; Sterling Foundation; Susquehanna Foundation; Tax Pro Financial Network, Inc.; Tiger Baron Foundation; TZP Group LLC; John A. Vassilaros & Sons, Inc.; Yorke Construction Corp.; Zubatkin Owner Representation, LLC. We also acknowledge the following individual donors to The 52nd Street Project:

Beth & Ray Abbott	Carolyn DeSena	Alan Howard	Courtney & Lowell Pettit
Robert Abrams & Cynthia Vance	Jordan Dickenstein	Linda LeRoy Janklow	Alice Phillips Swistel
George & Pam Ackert	Alan & Marion Dienstag	Andrea Johnson	& Daniel G. Swistel
Allison & Michael Anderson	Adam & Rebecca Dixon	Melissa Jones Briggs	Michael Popper
Richard Anthony & Avi Taussig	Aurora & Daniel Donofrio	Laura Jones	Elizabeth & Ryan Porter
Becky & Dylan Baker	Billy & Ellen Dreskin	Robert Joy & Henry Krieger	Sue Poulin
Eliza Baldi & David Costabile	Rebecca & Rick Dresser	Douglas M. Kaden	Ivy & Michael Rachlin
Beth Barry & Daniel Sussman	Peter Dufault	& Merritt Tilney	Helen & Peter Randolph
Jessica Bauman & Ben Posel	Laurel Durst	Eric Karpeles & Mike Sell	Willie Reale
Lisa Benavides	Chrysti & David Eigenberg	Elliot & Kim Katz	Armando Riesco
& Tim Blake Nelson	Jeremy Erdreich	Anita Keal & Morton Wolkowitz	& Shirley Rumierk
Judy & Sam Berger	Wendy Ettinger	Beth & Clarke Keough	Annasophia Robb
Stephanie Berger & Paul King	Edie Falco	Alicia Kershaw	Anita Rogerson
Gavin Berger & Craig Berggren	Anton Fig & Laura Sametz	Mary Kong	Daniel Rosen
Elizabeth & Eric Berman	Mark Fisher	Susannah Koteen	Lynne Rosenberg
Adam Bernstein	Katherine Fleming	& Mark Sweeney	Debra & Russell Rosenthal
& Jessica Hecht	Lindsay Fram & Mason Pettit	Joyce Krawiecki	Patricia Rosenthal
Stephen Bernstein	William Frank	Jan Kroeze & Jacki Ochs	David & Laura Ross
Francine Bizar	Karen & Paul Freitas	Ellen Kroll	Meg Rushton
Lewis Black	Gene Friedman	Richard Langan	Jim & Kim Russen
Allison Blinken	Louis & Patrice Friedman	Frances & Fred Langbecker	Lyle Saunders
Jane Bolster & Steve Wertimer	David Froelich & Cynthia Kaplan	Ruth & Sid Lapidus	Karin & Tom Schall
Byron Boston	Sally Froelich	Jené LeBlanc	David Seidman & Laura Valeroso
Buzz Bovshow	Janice Gabriolove	Cindy & Richard Leibovitch	Robert Shwartz
Richard & Samantha Brand	Jeannie & Jim Gaffigan	Adrienne Lobel	Jacqueline Simon
Becky Browder & Ted Neustadt	Pamela & Wayne Garrison	Edie Lutnick	Jeremy Smith
Leah Carr	Freddie & Myrna Gershon	John C. Lynch & Brenda Wehle	Stephen Sondheim
Gil Cass	Cathe Giffuni	Marsue & Peter MacNicol	Tim Stephenson
Chris Ceraso & Carla Meadows	Glen Gillen & Michael Lawrence	Greg MacPherson	& Adriana Trigiani
Lisa Chanel	Emily Giske & Annie Washburn	& Jane Perlmutter	Bob Stockel
Lisa & Matt Chanoff	Robert Goldberg	Bruce MacVittie & Carol Ochs	Abbie Strassler
Rachel Chanoff	Shari Goodstein	Dennis Manalo	David & Patty Straus
Navin & Preeti Choksi	Bruce Graham & Valerie Kay	Frank & Linda Mavronicolas	Jenni Swan
Ellen Chopay	Jill Graham and Jon Klein	Marjorie Mayrock	Richard Sweren
Katie & Kelly Clark	Stephen Graham	Pierce McCormack	Erica & Warren Thaler
Joel Coen	Susannah Gray & John Lyons	& Bruce Whitacre	Judy & Ron Tierney
& Frances McDormand	Melinda Griffith	Josie Merck	Lisa Tilney
Lisa Cohen & David Hillman	Kimberly Grigsby	Joe & Noël Mihalow	Suzanne Tobak
Robert Cohen	Emily Grishman	Drew Milstein	Craig & Madonna Turner
& Danielle Mindess	& Susan Sampliner	Carla & Yohan Minaya	Fred & Sarah Turpin
Ruth Cohen & Bob Usdin	Jan Gura & Alan Pickman	Donald Monti	Jan-Willem van den Dorpel
Sherry Cohen	Warren E. Hannas	Daryl & Michael Moss	Alexandra Vassilaros
Brad Coley	Susan Hanson	Amanda & Neal Moszkowski	Maria Vassilaros
& Wendy vanden Heuvel	Barnaby Harris & Suzie Kondi	Suzen Murakoshi	& William Zucearia
Penny Collins	Karen Hauser & Warren Leight	Randy & Rona Nelson	Mary Pat Walsh
Dan Colussy	Ann & David Hausmann	Ruth Nelson	Sharon Washington
Megan Cramer	Amy Herzig	Evan Newmark & Ellen West	Norbert Weissberg
Billy Crudup	Barbara & Eric Hippeau	Larry & Rachel Norton	David Weller
Michaela Culver	Josie Holtzman	Debra Occhino	Mark & Vicki Whatley
William Curran	& Isaac Kestenbaum	Lori O'Connor	Susan Whitehead
& Patrice Delcasino	Willy Holtzman & Sylvia Shepard	Beth & Bob Ollwerther	Carole Yass
Cathy Dantchik	Katy Homans & Patterson Sims	Kevin O'Rourke & Edith Thurber	Janine & Jeffrey Yass
Leslie Dantchik & Mitch Horowitz	Gary Horowitz & Alan Krevis	F. Richard Pappas	Brett Young-Fountain
Robert Denenberg	Sarah Horowitz & David Venarde	George Petrides	Abby Zeichner

THE 52ND STREET PROJECT  
PRESENTS

REVISITING  
HOURS (AGAIN)  
DEJA VU PLAYS

The 2017  
Playback Production

Friday, Oct. 27, 7:30 PM  
Saturday, Oct. 28, 7:30 PM  
Sunday, Oct. 29, 3:00 PM

THE FIVE ANGELS THEATER  
789 10th Ave. between 52nd & 53rd St.

Artwork by Creative Hoffmann



# Revisiting Hours: The Deja Vu Plays (Again!)

Playback 2017 - Oct. 27-29, Five Angels Theater

## The 52nd Street Project Staff

Kat Almirañez, Associate Artistic Director  
Ahmed Attia, Development Associate\*  
George Babiak, Director of Design and Production  
Liz Bell, Director of Education  
Kali Crandall, Development Director  
Caylyn Creager, Education Assistant  
Brian Freeland, Production Manager  
Natalie Hirsch, Artistic Director  
Garrett Kim, Program Director  
Carol Ochs, Executive Director  
Gus Rogerson, Producing Director  
John Sheehy, Director of Institutional Advancement  
Johanna Vidal, Community Coordinator\*  
Yazzy Wilder, Office Manager\*  
Iris A. Brown, Graphic Design Consultant

\*Project Alumni

### Interns:

Jimmy Kenna, Carrigan O'Brien, Ciana Proto, Angie Toledo,

### Teen Employees:

Receptionists: Jasmine Correa, Jade Cuevas, Daniel Martinez, Tiniyah Powell  
Ushers: Stephanie Macias, Maria Martinez, Bamba Thiam, Karen Tineo

## "REVISITING HOURS" Production Staff

### Composer/Music Director

Rachel Dean

### Set Designer

Kevin Joseph Roach

### Lighting Designer

Yuki Nakase

### Sound Designer/Operator

Ciana Proto

### Stage Manager

Carrigan O'Brien

### Projection Designs

George Babiak and The  
52nd Street Project Projection Archive

### Prop Designs

George Babiak

### Backstage Crew

Jade Cuevas, Rosneyri Rosario,  
Angie Toledo, Jayleen Velez

### House Management

Carol Ochs, John Sheehy

### Flyer/Program Art

Caroline Hadilaksono

### Weekend-Away Chefs

John Sheehy and Anne Troup

## COOL STUFF ON SALE IN THE LOBBY!

Fabulous Flyer Bars..... \$2.50  
*and featuring Shel Silverstein's "Fivey and Twoey" logo:*  
Project Hoodies..... \$30.00  
Project Caps ..... \$20.00  
Project T-shirts.....\$12.00/\$20.00  
Project Mugs..... \$5.00  
Project Notebook ..... \$5.00  
Project Pencil 3-pack.....\$1.00

Thank you for coming to **REVISITING HOURS: THE DEJA VU PLAYS**. If you are not on our mailing list, you can join on-line at [www.52project.org](http://www.52project.org). If you're interested in being a volunteer, fill out the form below and hand it to one of our staffers in the lobby.

### PLEASE PUT ME ON YOUR LIST:

10/17

NAME \_\_\_\_\_

ADDRESS \_\_\_\_\_

CITY \_\_\_\_\_

STATE \_\_\_\_\_

ZIP \_\_\_\_\_

HOME PHONE \_\_\_\_\_

DAYTIME OR MOBILE PHONE \_\_\_\_\_

E-MAIL ADDRESS \_\_\_\_\_

MY OCCUPATION \_\_\_\_\_

MY HOBBIES \_\_\_\_\_

WANT TO BE GREEN AND SAVE THE PROJECT MONEY ON POSTAGE?  
CHECK THIS BOX TO RECEIVE OUR NOTICES EXCLUSIVELY VIA E-MAIL.

### YES, I WOULD LIKE TO BE OF HELP. I CAN:

- |   |   |  |
|---|---|--|
| <input type="checkbox"/> Help load in and out for shows | <input type="checkbox"/> Draw and/or paint  | <input type="checkbox"/> Help kids with homework |
| <input type="checkbox"/> Hang lights                    | <input type="checkbox"/> Help with mailings | <input type="checkbox"/> Teach kids a skill      |
| <input type="checkbox"/> Work on a backstage crew       | <input type="checkbox"/> Do office work     | <input type="checkbox"/> Be a chef at an event   |
| <input type="checkbox"/> Do graphic design              | <input type="checkbox"/> Design sound       | <input type="checkbox"/> Design and sew costumes |
| <input type="checkbox"/> Other (please specify) _____   |   |  |

### MY SCHEDULE IS:

- Very flexible. I'm often available during weekdays.  
 Somewhat flexible. I can help on the occasional morning or afternoon during the week.  
 Not very flexible at all, but I've got some free time on evenings and weekends.

If you would like to mail this (and you're always welcome to enclose a tax-deductible contribution), you can send it to: The 52nd Street Project, 789 10th Avenue, New York, NY 10019. Or fax it to (212) 333-5598.



The Playback Program is made possible with public funds from The New York State Council on the Arts, a state agency, and the New York City Department of Cultural Affairs. This project is supported in part by an award from the National Endowment for the Arts. The 52nd Street Project is a member of Art/NY and Theatre Communications Group (TCG), the national organization for the American theatre.

## COMING UP SOON AT THE PROJECT!

### THE 52ND STREET PROJECT

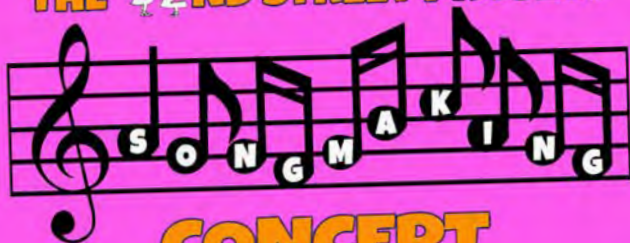

## CONCERT

Come see original tunes created by kids of the 52nd Street Project with adult composers and performed by pro singers!

Friday, Nov. 3  
at 7:30 p.m.

# BIG KIDS BASH CARNIVAL

THRILLING GAMES OF CHANCE & SKILL  
SCINTILLATING CONVERSATION  
INVIGORATING BEVERAGES  
EDIBLE AND SATISFYING TREATS  
GLITTERING PRIZES  
CONVIVIAL GOOD FEELINGS  
THE SATISFACTION OF  
HELPING THE 52ND STREET PROJECT

TUESDAY, NOVEMBER 7 FROM  
7:00 P.M. UNTIL 10:00 P.M.  
THE TOWN TENNIS CLUB  
430 East 56th St.  
Ticket Prices:  
\$125 between Oct. 24 and Oct. 31  
\$150 after Oct. 31  
Contact Kali Crandall at (212) 333-5252  
or at [crandall@52project.org](mailto:crandall@52project.org)

## THE FALL 2017 PLAYMAKING SHOW

10 all-new  
ten-year old kids  
write plays for adult  
professional actors  
to perform.

December 8-10 right here  
at the Five Angels Theater.



## The 52nd Street Project Board of Directors

Lisa Benavides	Frances McDormand, chair emeritus
Rachel Chanoff	Noël Mihalow
Cathy Dantchik, co-chair	Carol Ochs
Carolyn DeSena	Willie Reale, founder
Wendy Ettinger, chair emeritus	Gus Rogerson
Louis P. Friedman, co-chair	Shirley Rumierk, alumni member
Alex Gersten-Vassilaros	José Soto, Jr., alumni member
Robert Goldberg	Merritt Tilney
Stephen Graham, chair emeritus	Wendy vanden Heuvel
Natalie Hirsch	Mark Whatley
Valerie Kay	

### What's Going On Here?

The 52nd Street Project is a non-profit organization that brings children from the Hell's Kitchen neighborhood together with professional theater artists to create original theater. REVISITING HOURS is a production of our Playback program, in which kid actor/playwrights write plays for themselves and adult actor/director partners. Everyone ventured to the Hamptons for a rehearsal retreat over the Columbus Day weekend. All of the kids involved are veterans of the Playmaking classes which were adapted for the Project by Daniel Judah Sklar from his book *Playmaking: Children Writing and Performing Their Own Plays*.

### In-Kind Contributions

Abbeville Press; Best Barber; Lewis Black; Brooklyn Brewery; Iris A. Brown Design; Navin Choksi; City Winery; William Curran & A Curran Affair; The Daily Show's Trevor Noah; Jenny Gersten; Haru Restaurant of Hell's Kitchen; ICI; Karen Kowgios of Fried & Kowgios; The Late Show with Stephen Colbert; Make My Cake; Charlie Marshal; Noël Mihalow & Prime Films; Natasha, Pierre, and the Great Comet of 1812; Lauren Friedman, Pharma/Omni Printing; Winston Rodney Photography; Stephen Sondheim; Jenny Steingart; Merritt Tilney & Doug Kaden; Tito's Vodka; Robin Treadway; John A. Vassilaros & Sons; The Vassilaros Family; Watkins Inc.; Steve Olsen and the WestBank Cafe; and Paul, Rifkind, Wharton, & Garrison LLP.

### Special Thanks

We're extremely grateful to board member Alex Gersten-Vassilaros for allowing us to use her home as our headquarters on our rehearsal trip to the Hamptons. Huge thanks also go to Board Co-Chair Louis Friedman and his wife Patrice Friedman for hosting some adults in their exquisite Water Mill cottage, and to our other Co-Chair, Cathy Dantchik, who hosted our girls and even more adults at her beautiful house in Bridgehampton.

# REVISITING HOURS - ACT 1

All original music composed by Rachel Dean

## BEAR-LY FRIENDS

Written by Lakshmi DeJesus, age 13

Director/Dramaturge: Rachel Claire

Skyla, a bear.....Lakshmi DeJesus

Cindy-Bill ..... Rachel Claire

*Society Rules* lyrics by Lakshmi DeJesus

## BANK ROBBING

Written by Ethan Perez, age 13

Director/Dramaturge: Justin Walker White

Mistake ..... Ethan Perez

Bob ..... Justin Walker White

Gust ..... George Babiak

Lawrence ..... Rosneyri Rosario

Doug ..... Angie Toledo

*It's Easy to Rob a Bank* lyrics by Ethan Perez

## DON'T TRUST ANYONE

Written by Stevens Velasquez, age 13

Director/Dramaturge: Jose Gamo

Gangsta ..... Stevens Velasquez

Dirty Dan ..... Jose Gamo

*Tell the Truth* lyrics by Stevens Velasquez

## THE RACE TO HOME

Written by Lauren Amador-Cruz, age 13

Director/Dramaturge: Jody Flader

Beastalicia, a dog ..... Lauren Amador-Cruz

Dash, a bird ..... Jody Flader

Dogs and Parrots ..... Rosneyri Rosario, Angie Toledo, Jayleen Velez

Blue Bird Scout ..... Jade Cuevas

Pet Shop Customer ..... George Babiak

*Salt and Pepper* lyrics by Lauren Amador-Cruz

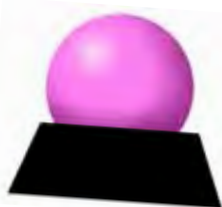

# REVISITING HOURS - ACT 2

## THE MISUNDERSTANDING

Written by Rodery Rosario, age 13

Director/Dramaturge: Kyle Cameron

Dan the Green Leaf ..... Rodery Rosario

Dante the Rapper ..... Kyle Cameron

*A Bird with No Wings* lyrics by Rodery Rosario

## ANA AND THE PAN

Written by Ginaija Hires, age 13

Director/Dramaturge: Tina Chilip

Anastasia ..... Ginaija Hires

Carol the Frying Pan ..... Tina Chilip

*Used and Confused* lyrics by Ginaija Hires

## WHERE'D HE GO?

Written by Coleman Williams, age 13

Director/Dramaturge: Marchant Davis

Wallace Douglas Johnson, Sr. .... Coleman Williams

Woodrow Wilson ..... Marchant Davis

Robber ..... Angie Toledo

Manager ..... Jade Cuevas

*Which Way?* lyrics by Coleman Williams

## WHAT REALLY MATTERS

Written by Natasha Davis, age 13

Director/Dramaturge: Daiva Deupree

Rebecca ..... Natasha Davis

Karla ..... Daiva Deupree

Teacher's voice ..... Ciana Proto

Frodo the Tree ..... George Babiak

*What You Gotta Focus On and Real Life World Things* lyrics by Natasha Davis



The 52nd Street Project is a non-profit community-based arts organization that brings children from the Hell's Kitchen neighborhood together with professional artists to create original art. The Songmaking program partners five 52nd Street Project kids with adult composers to create original songs. Over the six weeks of Songmaking, led by Avi Amon and Program Director Garrett Kim, these young lyricists explore how their own words and ideas fit together with their composer's music to create songs. Near the end of the program, we bring in a company of singers to perform the completed songs, and share them with an audience.

### The 52nd Street Project Staff

Kat Almirañez, Associate Artistic Director  
 Ahmed Attia, Development Associate\*  
 George Babiak, Director of Design and Production  
 Liz Bell, Director of Education  
 Kali Crandall, Development Director  
 Caylyn Creager, Education Assistant  
 Brian Freeland, Production Manager  
 Natalie Hirsch, Artistic Director  
 Garrett Kim, Program Director  
 Carol Ochs, Executive Director  
 Gus Rogerson, Producing Director  
 John Sheehy, Director of Institutional Advancement  
 Johanna Vidal, Community Coordinator\*  
 Yazzy Wilder, Office Manager\*  
 Iris A. Brown, Graphic Design Consultant  
*\*Project Alumni*

#### Interns:

Jimmy Kenna, Carrigan O'Brien, Ciana Proto, Angie Toledo

#### Teen Employees:

Receptionists: Jasmine Correa, Jade Cuevas, Daniel Martinez, Tiniyah Powell  
 Ushers: Jasmine Correa, Daniel Martinez, Wilhelmina Ohene Kari Kari

### The 52nd Street Project Board of Directors

Lisa Benavides	Frances McDormand,
Rachel Chanoff	chair emeritus
Cathy Dantchik, co-chair	Noël Mihalow
Carolyn DeSena	Carol Ochs
Wendy Ettinger, chair emeritus	Willie Reale, founder
Louis P. Friedman, co-chair	Gus Rogerson
Alex Gersten-Vassilaros	Shirley Rumierk, alumni member
Robert Goldberg	José Soto, Jr., alumni member
Stephen Graham, chair emeritus	Merritt Tilney
Natalie Hirsch	Wendy vanden Heuvel
Valerie Kay	Mark Whatley



PRESENTS



Featuring 12 original songs written by kids and composed and performed by adult musicians and singers.

Songmaking Directors:  
 Avi Amon and Garrett Kim

Friday, Nov. 3, 2017  
 7:30 p.m.

The Five Angels Theater  
 The 52nd Street Project  
 789 10th Avenue

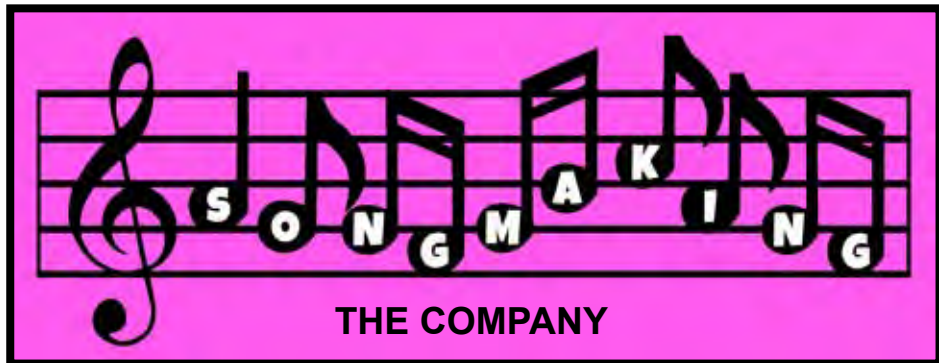

**The Lyricists**

Ryan Billah  
Edelys Guerrero  
Hannah Leon  
Andres Mendoza  
Angel Mendoza

**The Composers/Musicians**

Bryan Blaskie  
Benedict Braxton-Smith  
Alanya Bridge  
Emily Chiu  
Patrick Thompson

**Arrangements/Orchestrations/Music Director**

Avi A. Amon

**Lights**

Jimmy Kenna

**The Singers**

Ato Blankson-Wood  
Zoe Chao  
Andy Danh  
Marchánt Davis  
Erin Felgar  
Edelys Guerrero  
Kendal Hartse  
Greg Hildreth  
Korey Jackson  
Tommy McDowell  
Doron JePaul Mitchell  
Rob Morrison  
Nadia Quinn  
Emily Skeggs

**Sound**

Laura Brauner

**Special Thanks**

The Songmaking Program has been established in collaboration with Sarah Schlesinger, Fred Carl, and Julianne Wick Davis and the NYU Tisch School of the Arts Music Theater Writing Program.



The Songmaking Program is made possible with public funds from The New York State Council on the Arts, a state agency, and the New York City Department of Cultural Affairs. This project is supported in part by an award from the National Endowment for the Arts. The 52nd Street Project is a member of Art/NY and Theatre Communications Group (TCG), the national organization for the American theatre.

**THE CONCERT**

**“Jump Off”**

Lyrics by Ryan Billah  
Music by Bryan Blaskie  
Sung by Greg Hildreth

**“Life”**

Lyrics by Andres Mendoza  
Music by Benedict Braxton-Smith  
Sung by Andy Danh

**“Kicked Soccer Ball”**

Lyrics by Ryan Billah  
Music by Bryan Blaskie  
Sung by Ato Blankson-Wood

**“My Future”**

Lyrics by Andres Mendoza  
Music by Benedict Braxton-Smith  
Sung by Doron JePaul Mitchell



**“Space”**

Lyrics by Hannah Leon  
Music by Alanya Bridge  
Sung by Rob Morrison and  
Nadia Quinn

**“Learning to Love Again”**

Lyrics by Edelys Guerrero  
Music by Emily Chiu  
Sung by Erin Felgar

**“That Year of Memory”**

Lyrics by Edelys Guerrero  
Music by Emily Chiu  
Sung by Edelys Guerrero



**“Sports”**

Lyrics by Hannah Leon  
Music by Alanya Bridge  
Sung by Korey Jackson

**“3 AM”**

Lyrics by Hannah Leon  
Music by Alanya Bridge  
Sung by Zoe Chao and  
Tommy McDowell

**“Broken Objects Song”**

Lyrics by Angel Mendoza  
Music by Patrick Thompson  
Sung by Kendal Hartse



**“Pumped Up”**

Lyrics by Andres Mendoza  
Music by Benedict Braxton-Smith  
Sung by Marchánt Davis

**“Bananas Forever”**

Lyrics by Angel Mendoza  
Music by Patrick Thompson  
Sung by Emily Skeggs

*Please see an usher if you'd like a copy of the lyrics.*

The 52nd Street Project gratefully acknowledges the support of the following foundations & corporations: The Altman Foundation; BC Partners; BGC; Benihana/HARU; Bloomberg Philanthropies; The Brenner Family Foundation; Bull's Head Foundation, Inc.; Cantor Fitzgerald; Carnegie Corporation of New York; Maxine and Irving Castle Foundation; CBS Foundation, Inc.; The CLAWS Foundation; Comedy Central; Consolidated Edison; Dawkins Family Foundation; Dramatists Play Service, Inc.; Eleanor, Adam & Mel Dubin Foundation; Eileen Fisher, Inc.; Flexis Capital, LLC; Pamela and Wayne Garrison Family Foundation; The Horace W. Goldsmith Foundation; The Stephen P. Hanson Foundation; Heisman Trophy Trust; Hudson Scenic Studio; Lambert Family Foundation; Lemle Pictures, Inc.; Frederick Loewe Foundation; LRS Designs, Inc.; MTI; Newman's Own; The Stavros Niarchos Foundation; Ninth Avenue Association; Par Plumbing Co., Inc.; Sawyer | Berson Architecture & Landscape Architecture; The Morris and Alma Schapiro Fund; Schuss Realty Associates, LLC; The Shubert Organization; The Harold & Mimi Steinberg Charitable Trust; Sterling Foundation; Susquehanna Foundation; Tax Pro Financial Network, Inc.; Tiger Baron Foundation; TZP Group LLC; John A. Vassilaros & Sons, Inc.; Yorke Construction Corp.; Zubatkin Owner Representation, LLC. We also acknowledge the following individual donors to The 52nd Street Project:

Beth & Ray Abbott	Carolyn DeSena	Alan Howard	Courtney & Lowell Pettit
Robert Abrams & Cynthia Vance	Jordan Dickenstein	Linda LeRoy Janklow	Alice Phillips Swistel & Daniel G. Swistel
George & Pam Ackert	Alan & Marion Dienstag	Andrea Johnson	Michael Popper
Allison & Michael Anderson	Adam & Rebecca Dixon	Melissa Jones Briggs	Elizabeth & Ryan Porter
Richard Anthony & Avi Taussig	Aurora & Daniel Donofrio	Laura Jones	Sue Poulin
Becky & Dylan Baker	Billy & Ellen Dreskin	Robert Joy & Henry Krieger	Ivy & Michael Rachlin
Eliza Baldi & David Costabile	Rebecca & Rick Dresser	Douglas M. Kaden & Merritt Tilney	Helen & Peter Randolph
Beth Barry & Daniel Sussman	Peter Dufault	Eric Karpeles & Mike Sell	Willie Reale
Jessica Bauman & Ben Posel	Laurel Durst	Elliot & Kim Katz	Armando Riesco & Shirley Rumierk
Lisa Benavides & Tim Blake Nelson	Chrysti & David Eigenberg	Anita Keal & Morton Wolkowitz	Beth & Clarke Keough
Judy & Sam Berger	Jeremy Erdreich	Alicia Kershaw	Anita Rogerson
Stephanie Berger & Paul King	Wendy Ettinger	Mary Kong	Daniel Rosen
Gavin Berger & Craig Berggren	Edie Falco	Susannah Koteen & Mark Sweeney	Lynne Rosenberg
Elizabeth & Eric Berman	Anton Fig & Laura Sametz	Joyce Krawiecki	Debra & Russell Rosenthal
Adam Bernstein & Jessica Hecht	Mark Fisher	Jan Kroeze & Jacki Ochs	Patricia Rosenthal
Stephen Bernstein	Katherine Fleming	Ellen Kroll	David & Laura Ross
Francoise Bizar	Lindsay Fram & Mason Pettit	Richard Langan	Meg Rushton
Lewis Black	William Frank	Frances & Fred Langbecker	Jim & Kim Russen
Allison Blinks	Karen & Paul Freitas	Ruth & Sid Lapidus	Lyle Saunders
Jane Bolster & Steve Wertimer	Gene Friedman	Jené LeBlanc	Karin & Tom Schall
Byron Boston	Louis & Patrice Friedman	Cindy & Richard Leibovitch	David Seidman & Laura Valeroso
Buzz Bovshow	David Froelich & Cynthia Kaplan	Adrienne Lobel	Robert Shwartz
Richard & Samantha Brand	Sally Froelich	Edie Lutnick	Jacqueline Simon
Becky Browder & Ted Neustadt	Janice Gabrielove	John C. Lynch & Brenda Wehle	Jeremy Smith
Leah Carr	Jeannie & Jim Gaffigan	Marsue & Peter MacNicol	Stephen Sondheim
Leah Carr	Pamela & Wayne Garrison	Greg MacPherson & Jane Perlmutter	Tim Stephenson & Adriana Trigiani
Gil Cass	Freddie & Myrna Gershon	Bruce MacVittie & Carol Ochs	Bob Stockel
Chris Ceraso & Carla Meadows	Cathe Giffuni	Dennis Manalo	Abbie Strassler
Lisa Chanel	Glen Gillen & Michael Lawrence	Frank & Linda Mavronicolas	David & Patty Straus
Lisa & Matt Chanoff	Emily Giske & Annie Washburn	Marjorie Mayrock	Jenni Swan
Rachel Chanoff	Robert Goldberg	Pierce McCormack & Bruce Whitacre	Richard Sweren
Navin & Preeti Chokis	Shari Goodstein	Josie Merck	Erica & Warren Thaler
Ellen Chopay	Bruce Graham & Valerie Kay	Joe & Noël Mihalow	Judy & Ron Tierney
Katie & Kelly Clark	Jill Graham and Jon Klein	Drew Milstein	Lisa Tilney
Joel Coen & Frances McDormand	Stephen Graham	Carla & Yohan Minaya	Suzanne Tobak
Lisa Cohen & David Hillman	Susannah Gray & John Lyons	Donald Monti	Craig & Madonna Turner
Robert Cohen & Danielle Mindess	Melinda Griffith	Daryl & Michael Moss	Fred & Sarah Turpin
Ruth Cohen & Bob Usdin	Kimberly Grigsby & Susan Sampliner	Amanda & Neal Moszkowski & William Zucearia	Jan-Willem van den Dorpel
Sherry Cohen	Emily Grishman & Susan Hanson	Suzen Murakoshi	Alexandra Vassilaros
Brad Coley & Wendy vanden Heuvel	Barnaby Harris & Suzie Kondi	Randy & Rona Nelson	Maria Vassilaros
Penny Collins	Karen Hauser & Warren Leight	Ruth Nelson	& William Zucearia
Dan Colussy	Ann & David Hausmann	Evan Newmark & Ellen West	Mary Pat Walsh
Megan Cramer	Amy Herzig	Larry & Rachel Norton	Sharon Washington
Billy Crudup	Barbara & Eric Hippeau	Debra Occhino	Norbert Weissberg
Michaela Culver	Josie Holtzman	Lori O'Connor	David Weller
William Curran & Patrice Delcasino	& Isaac Kestenbaum	Beth & Bob Ollwerther	Mark & Vicki Whatley
Cathy Dantchik	Willy Holtzman & Sylvia Shepard	Kevin O'Rourke & Edith Thurber	Susan Whitehead
Leslie Dantchik & Mitch Horowitz	Katy Homans & Patterson Sims	F. Richard Pappas	Carole Yass
Robert Denenberg	Gary Horowitz & Alan Krevis	George Petrides	Janine & Jeffrey Yass
	Sarah Horowitz & David Venarde		Brett Young-Fountain
			Abby Zeichner

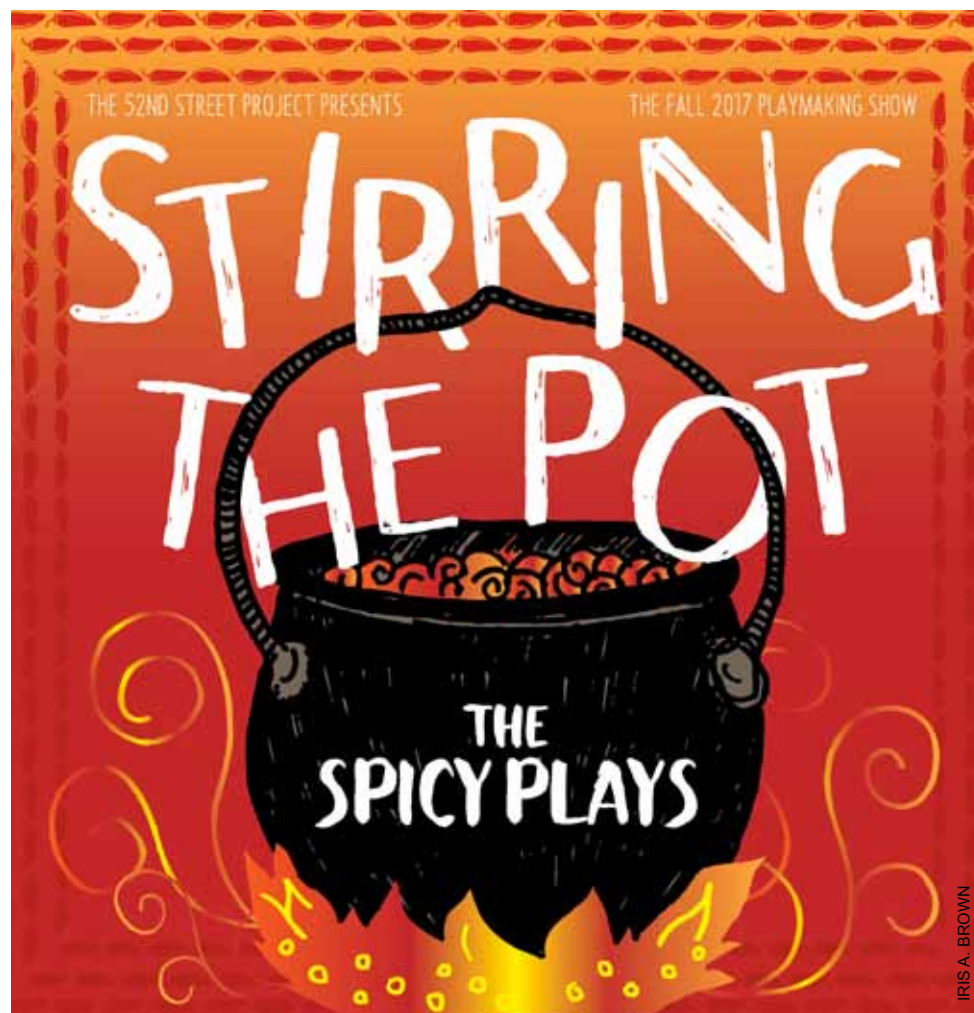

**10 NEW PLAYS WRITTEN BY KIDS  
AND PERFORMED BY ADULT ACTORS**

**Friday, Dec. 8 at 7:30 p.m.  
Saturday, Dec. 9 at 3:00 & 7:30 p.m.  
Sunday, Dec. 10 at 3:00 p.m.**

**THE FIVE ANGELS THEATER**

# STIRRING THE POT: THE SPICY PLAYS

Fall Playmaking 2017 - Dec. 8-10, Five Angels Theater

## The 52nd Street Project Staff

Kat Almirañez, Associate Artistic Director  
 Ahmed Attia, Development Associate\*  
 George Babiak, Director of Design and Production  
 Liz Bell, Director of Education  
 Kali Crandall, Development Director  
 Caylyn Creager, Education Assistant  
 Brian Freeland, Production Manager  
 Natalie Hirsch, Artistic Director  
 Garrett Kim, Program Director  
 Carol Ochs, Executive Director  
 Gus Rogerson, Producing Director  
 John Sheehy, Director of Institutional Advancement  
 Johanna Vidal, Community Coordinator\*  
 Yazzy Wilder, Office Manager\*  
 Iris A. Brown, Graphic Design Consultant  
*\*Project Alumni*

### Interns:

Jimmy Kenna, Carrigan O'Brian, Ciana Proto, Angie Toledo,

### Teen Employees:

Receptionists: Jasmine Correa, Jade Cuevas, Daniel Martinez,  
 Chayse Peña, Tiniyah Powell  
 Ushers: Jasmine Correa, Chayse Peña, Tiniyah Powell, Sasha Davis

## “STIRRING THE POT” Production Staff

### Composer/Music Director

Avi A. Amon

### Costume Designer

Slena Zoë Allen

### Set Designer

Kevin Joseph Roach

### Lighting Designer

Zack Weeks

### Sound Designer/Operator

Ciana Proto

### Stage Manager

Jenny Peek

### Projection Designs

George Babiak and the Project Archive

### Prop Designs

George Babiak, Angie Toledo,  
 Carrigan O'Brian, Jimmy Kenna

### Backstage Crew

Wilhelmina Ohene Kari Kari,  
 Jimmy Kenna, Carrigan O'Brian,  
 Darby O'Donnell, Angie Toledo

### House Management

Carol Ochs, John Sheehy

### Flyer/Program Art

Iris A. Brown

### Weekend-Away Chefs

Iris A. Brown and Joe White

## COOL STUFF ON SALE IN THE LOBBY!

Fabulous Flyer Bars..... \$2.50  
*and featuring Shel Silverstein's "Fivey and Twoey" logo:*  
 Two-tone Project Hoodie..... \$40.00  
 Monotone Project Hoodie ..... \$30.00  
 Project Caps ..... \$20.00  
 Project T-shirts.....\$12.00/\$20.00  
 Project Mugs..... \$5.00  
 Project Notebook ..... \$5.00  
 Project Pencil 3-pack.....\$1.00

Thank you for coming to **STIRRING THE POT**. If you are not on our mailing list, you can join on-line at [www.52project.org](http://www.52project.org). If you're interested in being a volunteer, fill out the form below and hand it to one of our staffers in the lobby.

### PLEASE PUT ME ON YOUR LIST:

12/17

NAME \_\_\_\_\_

ADDRESS \_\_\_\_\_

CITY \_\_\_\_\_

STATE \_\_\_\_\_

ZIP \_\_\_\_\_

HOME PHONE \_\_\_\_\_

DAYTIME OR MOBILE PHONE \_\_\_\_\_

E-MAIL ADDRESS \_\_\_\_\_

MY OCCUPATION \_\_\_\_\_

MY HOBBIES \_\_\_\_\_

WANT TO BE GREEN AND SAVE THE PROJECT MONEY ON POSTAGE?  
 CHECK THIS BOX TO RECEIVE OUR NOTICES EXCLUSIVELY VIA E-MAIL.

### YES, I WOULD LIKE TO BE OF HELP. I CAN:

- |   |   |  |
|---|---|--|
| <input type="checkbox"/> Help load in and out for shows | <input type="checkbox"/> Draw and/or paint  | <input type="checkbox"/> Help kids with homework |
| <input type="checkbox"/> Hang lights                    | <input type="checkbox"/> Help with mailings | <input type="checkbox"/> Teach kids a skill      |
| <input type="checkbox"/> Work on a backstage crew       | <input type="checkbox"/> Do office work     | <input type="checkbox"/> Be a chef at an event   |
| <input type="checkbox"/> Do graphic design              | <input type="checkbox"/> Design sound       | <input type="checkbox"/> Design and sew costumes |
| <input type="checkbox"/> Other (please specify) _____   |   |  |

### MY SCHEDULE IS:

- Very flexible. I'm often available during weekdays.  
 Somewhat flexible. I can help on the occasional morning or afternoon during the week.  
 Not very flexible at all, but I've got some free time on evenings and weekends.

If you would like to mail this (and you're always welcome to enclose a tax-deductible contribution), you can send it to: The 52nd Street Project, 789 10th Avenue, New York, NY 10019. Or fax it to (212) 333-5598.



The Playmaking Program is made possible with public funds from The New York State Council on the Arts, a state agency, and the New York City Department of Cultural Affairs. This project is supported in part by an award from the National Endowment for the Arts. The 52nd Street Project is a member of Art/NY and Theatre Communications Group (TCG), the national organization for the American theatre.

## WHAT ELSE IS HAPPENING HERE?

THE 52ND STREET PROJECT'S

# WORDPLAY

A NEW PLATFORMS PROGRAM

Spoken word performances by kids, musical performances by adults.

**ONE NIGHT ONLY**

Wednesday, December 13 @ 7:30 p.m.

All tickets are FREE, reservations strongly suggested.

Visit [www.52project.org](http://www.52project.org) for reservations.



FOR ONE NIGHT ONLY, THE FIVE ANGELS THEATER  
WILL TURN INTO A WILD DANCE CLUB!

LIVE DJ!

FOOD AND DRINK!

COOL PEEPS!

HOLIDAY CHEER!

**CLUB 52**

MONDAY, DECEMBER 18, 2017 - 8:00 PM TO 11:00 PM  
IT'S A BARGAIN BENEFIT! ONLY \$35 A POP!

### SUBSCRIBE TO OUR PODCAST!

A monthly online event created by Garrett Kim and your favorite kid/adult team-ups.

Go to the podcast section of the iTunes Store and search for "The 52nd Street Project" or "PROJcast."



### The 52nd Street Project Board of Directors

Lisa Benavides  
Rachel Chanoff  
Cathy Dantchik, co-chair  
Carolyn DeSena  
Wendy Ettinger, chair emeritus  
Louis P. Friedman, co-chair  
Alex Gersten-Vassilaros  
Robert Goldberg  
Stephen Graham, chair emeritus  
Natalie Hirsch  
Valerie Kay

Frances McDormand,  
chair emeritus  
Noël Mihalow  
Carol Ochs  
Willie Reale, founder  
Gus Rogerson  
Shirley Rumierk, alumni member  
José Soto, Jr., alumni member  
Merritt Tilney  
Wendy vanden Heuvel  
Mark Whatley

### What's Going On Here?

The 52nd Street Project is a non-profit organization that brings children from the Hell's Kitchen neighborhood together with professional theater artists to create original theater. **STIRRING THE POT** is a production of our Playmaking program. Young people participate in a nine-week playwriting course taught by Kat Almirañez and adapted for the Project by Daniel Judah Sklar from his book *Playmaking: Children Writing and Performing Their Own Plays*. At the end of the course, each child is matched with two actors and a dramaturg/director who guides him or her through the writing of a play during a weekend retreat in the country (Stone Ridge, New York, for this show). This performance is the end result.

### In-Kind Contributions

Abbeville Press; Best Barber; Lewis Black; Brooklyn Brewery; Iris A. Brown Design; Navin Choksi; City Winery; William Curran & A Curran Affair; The Daily Show's Trevor Noah; Jenny Gersten; Haru Restaurant of Hell's Kitchen; ICI; Karen Kowgios of Withum, Smith, & Brown; The Late Show with Stephen Colbert; Make My Cake; Charlie Marshal; Noël Mihalow & Prime Films; Natasha, Pierre, and the Great Comet of 1812; Lauren Friedman, Pharma/Omni Printing; Winston Rodney Photography; Stephen Sondheim; Jenny Steingart; Merritt Tilney & Doug Kaden; Tito's Vodka; Robin Treadway; John A. Vassilaros & Sons; The Vassilaros Family; Watkins Inc.; Steve Olsen and the WestBank Cafe; and Paul, Rifkind, Wharton, & Garrison LLP.

### Special Thanks

We're extremely thankful to Steve Gorn & Barbara Bash for the use of their beautiful home in Stone Ridge, NY as our base of operations for the writer's retreat weekend. We must also express thanks to Sean Cullen & Tess Hartman, Laura Shaine Cunningham, Tracey Dewart & Michael Eckersley, Deborah Freedman, Sylvia Greiser & Andrew Tingle, Jeff Madalena & Jason Gnewikow, Charlie & Naomi Miles, and Elaine Musselman for housing our adults and kids. Last, but not least, thanks to Iris Brown and Joe White for being our Stone Ridge liaisons and chefs!

### BE ON THE LOOKOUT FOR INTERNS!



If you know of any college or graduate students who might enjoy working with us, playing with us, and going on trips with us for a semester, please have them contact Yazy Wilder ([ywilder@52project.org](mailto:ywilder@52project.org)). We are currently looking for interns for the Spring and Summer of 2018. Thanks!



# STIRRING THE POT: THE SPICY PLAYS - ACT 1

All original music composed by Avi A. Amon

## THE BAD UNCLE

Written by Xavier Espinal, age 10  
Director/Dramaturg: Michael Propster

Uncle Steve ..... Reynaldo Piniella  
Abigail/Abigail's Twin ..... Arielle Goldman  
Mr. Anthony ..... George Babiak  
*I Love My Chairs and We're Different* lyrics by Xavier Espinal.

## HEAVEN ON EARTH

Written by Alexander Breton, age 10  
Director/Dramaturge: Jeremy Stoller

Halo, an Angel ..... Carl Hendrick Louis  
D, a Devil ..... José Durán  
AG ..... Angie Toledo  
Peeps ..... The Crew  
*Westward Homeward* lyrics by Alexander Breton.

## STAY

Written by Kylee Chester, age 9  
Dramaturge: Monica Trausch

Miley ..... Kristen Adele  
Riley ..... Mallory Portnoy  
*Anything* lyrics by Kylee Chester.

## HOLLYWOOD IS HARSH

Written by Sarah Lopez, age 10  
Dramaturge: Carrigan O'Brian, Director: Sarah Krohn

Charlotte ..... Chalia La Tour  
Regina ..... Lynne Rosenberg  
Auditioners ..... Darby O'Donnell, Wilhelmina Ohene Kari Kari  
Stage Manager ..... Jimmy Kenna  
Paramedic ..... Carrigan O'Brian  
*Secrets* lyrics by Sarah Lopez.

## SEWER BREAK-UP

Written by Liam Petard, age 10  
Director/Dramaturge: Nick Mills

Mike ..... Stephen O'Reilly  
Bob ..... Bill Camp  
*Not What I Wanted* lyrics by Liam Petard.



# STIRRING THE POT: THE SPICY PLAYS - ACT 2

## SOCCER

Written by Alex Torres, age 10  
Dramaturge: John Manolis, Director: James Yaegashi

Hiro ..... Grant Harrison  
Zack, a soccer ball ..... Mitchell Winter  
Mom ..... Angie Toledo  
Big Kid ..... Jimmy Kenna  
*Human* lyrics by Alex Torres.

## THE DOLL AND THE PENDANT

Written by Amirah Hancock, age 11  
Director/Dramaturge: Krystal Lucas

Maddie ..... Mozhan Marnò  
Surray, a Princess ..... Jennifer Kim  
Malli ..... John Sheehy  
Queen Starheart ..... Carrigan O'Brian  
*Anything* lyrics by Amirah Hancock.

## HAPPY MOTHER'S DAY

Written by Melanie Correa, age 9  
Dramaturge/Director: Chelsea Hackett

Nikki West ..... MaYaa Boateng  
Chloe Capintone ..... Charlotte Graham  
*I'm Sorry* lyrics by Melanie Correa.

## A WISH

Written by Ivan Garcia, age 10  
Director/Dramaturge: John Sheehy

Snowy Snowman ..... Greg Hildreth  
Ginormous ..... Neil D'Astolfo  
*A Wish / Regret* lyrics by Ivan Garcia.

## JABBA THE HUTT

Written by Evaluna Santoni, age 10  
Director/Dramaturge: Alexandra O'Daly

Jayden ..... Stephen Wallem  
Sofia ..... Edie Falco  
*I Got a Friend in Me* lyrics by Evaluna Santoni.



The 52nd Street Project is a non-profit community-based arts organization that brings children from the Hell's Kitchen neighborhood together with professional artists to create original art. Over the month of the WordPlay program, led by Program Director Garrett Kim with support from Carrigan O'Brien, these young poets and wordsmiths explored their place in the world and arranged their perceptions and ideas into the pieces you are seeing tonight. We were also lucky enough to have a quartet of interns that are very musical, and they added their own talents to the proceedings. We hope you will enjoy the results!

### The 52nd Street Project Staff

Kat Almirañez, Associate Artistic Director  
 Ahmed Attia, Development Associate\*  
 George Babiak, Director of Design and Production  
 Liz Bell, Director of Education  
 Kali Crandall, Development Director  
 Caylyn Creager, Education Assistant  
 Brian Freeland, Production Manager  
 Natalie Hirsch, Artistic Director  
 Garrett Kim, Program Director  
 Carol Ochs, Executive Director  
 Gus Rogerson, Producing Director  
 John Sheehy, Director of Institutional Advancement  
 Johanna Vidal, Community Coordinator\*  
 Yazzy Wilder, Office Manager\*  
 Iris A. Brown, Graphic Design Consultant  
*\*Project Alumni*

#### Interns:

Jimmy Kenna, Carrigan O'Brien, Ciana Proto, Angie Toledo

#### Teen Employees:

Receptionists: Jasmine Correa, Jade Cuevas, Daniel Martinez,  
 Tinish Powell, and Chayse Peña  
 Ushers: Bamba Thiam and Stephanie Macias

### The 52nd Street Project Board of Directors

Lisa Benavides	Frances McDormand,
Rachel Chanoff	chair emeritus
Cathy Dantchik, co-chair	Noël Mihalow
Carolyn DeSena	Carol Ochs
Wendy Ettinger, chair emeritus	Willie Reale, founder
Louis P. Friedman, co-chair	Gus Rogerson
Alex Gersten-Vassilaros	Shirley Rumierk, alumni member
Robert Goldberg	José Soto, Jr., alumni member
Stephen Graham, chair emeritus	Merritt Tilney
Natalie Hirsch	Wendy vanden Heuvel
Valerie Kay	Mark Whatley



PRESENTS



Featuring original spoken-word pieces  
 by eight kids of The 52nd Street Project.

Wordplay Director:  
 Garrett Kim

Wednesday, Dec. 13, 2017  
 7:30 p.m.

The Five Angels Theater  
 The 52nd Street Project  
 789 10th Avenue



## **THE SHOW**

### **Group Piece**

Written & performed by The Wordplay Company

### **“Home”**

### **“Slim-Nugget”**

Written & performed by Emmanuel Goicuria  
Coached by Grant Harrison

### **“Do Not Walk In”**

### **“Don’t Eat Slime! or Tide”**

Written & performed by Gianna Hires  
Coached by Lynnette R. Freeman

### **“Home”**

### **“Life Changer”**

Written & performed by Messiah Green  
Coached by Samuel Pearce

### **“Fly”**

### **“Friday Feeling”**

Written & performed by Jade Johnson  
Coached by Carrigan O’Brian

### **“The Jacket That Can Never Smell Good”**

### **“The Life of Henry James”**

Written & performed by Yousef Altareb  
Coached by Tony Macht

### **“Queen Rose”**

### **“Squishy Poem”**

Written & performed by Nyla Blake-Soden  
Coached by Rachel Schmeling

### **“Eleven”**

### **“Flavour Tour”**

Written & performed by Aengus O’Donnell  
Coached by Richard Perez

### **“Anti-Love Poem”**

### **“My Home Poem”**

Written & performed by Nicole Quiles  
Coached by Jasmine Correa & Angie Toledo

Musical performances by

Tony Macht, and Jimmy Kenna,  
Carrigan O’Brian, Ciana Proto,  
& Angie Toledo



Wordplay has been made possible with public funds from The New York State Council on the Arts, a state agency, and the New York City Department of Cultural Affairs. This project is supported in part by an award from the National Endowment for the Arts. The 52nd Street Project is a member of Art/NY and Theatre Communications Group (TCG), the national organization for the American theatre.



THE 52ND STREET PROJECT

# SHOW PROGRAMS 2018

The 52nd Street Project gratefully acknowledges the support of the following foundations & corporations: The Altman Foundation; BC Partners; BGC; Benihana/HARU; Bloomberg Philanthropies; The Brenner Family Foundation; Bull's Head Foundation, Inc.; Cantor Fitzgerald; Carnegie Corporation of New York; Maxine and Irving Castle Foundation; CBS Foundation, Inc.; The CLAWS Foundation; Comedy Central; Consolidated Edison; Dawkins Family Foundation; Dramatists Play Service, Inc.; Eleanor, Adam & Mel Dubin Foundation; Eileen Fisher, Inc.; Flexis Capital, LLC; Pamela and Wayne Garrison Family Foundation; The Horace W. Goldsmith Foundation; The Stephen P. Hanson Foundation; Heisman Trophy Trust; Hudson Scenic Studio; Lambert Family Foundation; Lemle Pictures, Inc.; Frederick Loewe Foundation; LRS Designs, Inc.; MTI; Newman's Own; The Stavros Niarchos Foundation; Ninth Avenue Association; Par Plumbing Co., Inc.; Sawyer | Berson Architecture & Landscape Architecture; The Morris and Alma Schapiro Fund; Schuss Realty Associates, LLC; The Shubert Organization; The Harold & Mimi Steinberg Charitable Trust; Sterling Foundation; Susquehanna Foundation; Tax Pro Financial Network, Inc.; Tiger Baron Foundation; TZP Group LLC; John A. Vassilaros & Sons, Inc.; Yorke Construction Corp.; Zubatkin Owner Representation, LLC. We also acknowledge the following individual donors to The 52nd Street Project:

Beth & Ray Abbott	Carolyn DeSena	Alan Howard	Courtney & Lowell Pettit
Robert Abrams & Cynthia Vance	Jordan Dickstein	Linda LeRoy Janklow	Alice Phillips Swistel
George & Pam Ackert	Alan & Marion Dienstag	Andrea Johnson	& Daniel G. Swistel
Allison & Michael Anderson	Adam & Rebecca Dixon	Melissa Jones Briggs	Michael Popper
Richard Anthony & Avi Taussig	Aurora & Daniel Donofrio	Laura Jones	Elizabeth & Ryan Porter
Becky & Dylan Baker	Billy & Ellen Dreskin	Robert Joy & Henry Krieger	Sue Poulin
Eliza Baldi & David Costabile	Rebecca & Rick Dresser	Douglas M. Kaden	Ivy & Michael Rachlin
Beth Barry & Daniel Sussman	Peter Dufault	& Merritt Tilney	Helen & Peter Randolph
Jessica Bauman & Ben Posel	Laurel Durst	Eric Karpeles & Mike Sell	Willie Reale
Lisa Benavides	Chrysti & David Eigenberg	Elliot & Kim Katz	Armando Riesco
& Tim Blake Nelson	Jeremy Erdreich	Anita Keal & Morton Wolkowitz	& Shirley Rumierk
Judy & Sam Berger	Wendy Ettinger	Beth & Clarke Keough	Annasophia Robb
Stephanie Berger & Paul King	Edie Falco	Alicia Kershaw	Anita Rogerson
Gavin Berger & Craig Berggren	Anton Fig & Laura Sametz	Mary Kong	Daniel Rosen
Elizabeth & Eric Berman	Mark Fisher	Susannah Koteen	Lynne Rosenberg
Adam Bernstein	Katherine Fleming	& Mark Sweeney	Debra & Russell Rosenthal
& Jessica Hecht	Lindsay Fram & Mason Pettit	Joyce Krawiecki	Patricia Rosenthal
Stephen Bernstein	William Frank	Jan Kroeze & Jacki Ochs	David & Laura Ross
Francine Bizar	Karen & Paul Freitas	Ellen Kroll	Meg Rushton
Lewis Black	Gene Friedman	Richard Langan	Jim & Kim Russen
Allison Blinken	Louis & Patrice Friedman	Frances & Fred Langbecker	Lyle Saunders
Jane Bolster & Steve Wertimer	David Froelich & Cynthia Kaplan	Ruth & Sid Lapidus	Karin & Tom Schall
Byron Boston	Sally Froelich	Jené LeBlanc	David Seidman & Laura Valeroso
Buzz Bovshow	Janice Gabriolove	Cindy & Richard Leibovitch	Robert Shwartz
Richard & Samantha Brand	Jeannie & Jim Gaffigan	Adrienne Lobel	Jacqueline Simon
Becky Browder & Ted Neustadt	Pamela & Wayne Garrison	Edie Lutnick	Jeremy Smith
Leah Carr	Freddie & Myrna Gershon	John C. Lynch & Brenda Wehle	Stephen Sondheim
Gil Cass	Cathe Giffuni	Marsue & Peter MacNicol	Tim Stephenson
Chris Ceraso & Carla Meadows	Glen Gillen & Michael Lawrence	Greg MacPherson	& Adria Trigiani
Lisa Chanel	Emily Giske & Annie Washburn	& Jane Perlmutter	Bob Stockel
Lisa & Matt Chanoff	Robert Goldberg	Bruce MacVittie & Carol Ochs	Abbie Strassler
Rachel Chanoff	Shari Goodstein	Dennis Manalo	David & Patty Straus
Navin & Preeti Choksi	Bruce Graham & Valerie Kay	Frank & Linda Mavronicolas	Jenni Swan
Ellen Chopay	Jill Graham and Jon Klein	Marjorie Mayrock	Richard Sweren
Katie & Kelly Clark	Stephen Graham	Pierce McCormack	Erica & Warren Thaler
Joel Coen	Susannah Gray & John Lyons	& Bruce Whitacre	Judy & Ron Tierney
& Frances McDormand	Melinda Griffith	Josie Merck	Lisa Tilney
Lisa Cohen & David Hillman	Kimberly Grigsby	Joe & Noël Mihalow	Suzanne Tobak
Robert Cohen	Emily Grishman	Drew Milstein	Craig & Madonna Turner
& Danielle Mindess	& Susan Sampliner	Carla & Yohan Minaya	Fred & Sarah Turpin
Ruth Cohen & Bob Usdin	Jan Gura & Alan Pickman	Donald Monti	Jan-Willem van den Dorpel
Sherry Cohen	Warren E. Hannas	Daryl & Michael Moss	Alexandra Vassilaros
Brad Coley	Susan Hanson	Amanda & Neal Moszkowski	Maria Vassilaros
& Wendy vanden Heuvel	Barnaby Harris & Suzie Kondi	& William Zucearia	& William Zucearia
Penny Collins	Karen Hauser & Warren Leight	Mary Pat Walsh	Mary Pat Walsh
Dan Colussy	Ann & David Hausmann	Sharon Washington	Sharon Washington
Megan Cramer	Amy Herzig	Norbert Weissberg	Norbert Weissberg
Billy Crudup	Barbara & Eric Hippeau	David Weller	David Weller
Michaela Culver	Josie Holtzman	Mark & Vicki Whatley	Mark & Vicki Whatley
William Curran	& Isaac Kestenbaum	Susan Whitehead	Susan Whitehead
& Patrice Delcasino	Willy Holtzman & Sylvia Shepard	Carole Yass	Carole Yass
Cathy Dantchik	Katy Homans & Patterson Sims	Janine & Jeffrey Yass	Janine & Jeffrey Yass
Leslie Dantchik & Mitch Horowitz	Gary Horowitz & Alan Krevis	Brett Young-Fountain	Brett Young-Fountain
Robert Denenberg	Sarah Horowitz & David Venarde	Abby Zeichner	Abby Zeichner
		George Petrides	



The Relatable Plays



## The 2018 Two-on-Two Shows

Friday, Jan. 26 @ 7:30 p.m.  
 Saturday, Jan. 27 @ 7:30 p.m.  
 Sunday, Jan. 28 @ 3:00 p.m.

**THE FIVE ANGELS THEATER**

# CURRENT MOOD: THE RELATABLE PLAYS

The 2018 2-on-2 Shows - Jan. 26-28, The Five Angels Theater

## The 52nd Street Project Staff

Kat Almirañez, Associate Artistic Director  
 Ahmed Attia, Development Associate\*  
 George Babiak, Director of Design and Production  
 Liz Bell, Director of Education  
 Kali Crandall, Development Director  
 Caylyn Creager, Education Assistant  
 Brian Freeland, Production Manager  
 Natalie Hirsch, Artistic Director  
 Garrett Kim, Program Director  
 Carol Ochs, Executive Director  
 Gus Rogerson, Producing Director  
 John Sheehy, Director of Institutional Advancement  
 Johanna Vidal, Community Coordinator\*  
 Yazzy Wilder, Office Manager\*  
 Iris A. Brown, Graphic Design Consultant

\*Project Alumni

### Interns:

Jason Bowen, Elena Woughter

### Teen Employees:

Receptionists: Jasmine Correa, Jade Cuevas, Daniel Martinez,  
 Chayse Peña, Tiniyah Powell  
 Ushers: Stephanie Macias, Jade Cuevas, Kayla Matos, Matthew Orozco

## “CURRENT MOOD” Production Staff

### Composer/Music Director

Danny Ursetti

### Costume Designers

Kia Smalls and Garrett Kim

### Set Designer

Kevin Joseph Roach

### Lighting Designer

Jenn Fok

### Sound Designer/Operator

Chayse Peña

### Stage Manager

Jenni Swan

### Projection Designs

George Babiak

### Prop Designs

George Babiak

### Backstage Crew

Elena Woughter, Jason Bowen

### House Management

Carol Ochs, John Sheehy

### Flyer/Program Art

Patrick Jones

### Weekend-Away Chefs

John Sheehy and Carol Ochs

## COOL STUFF ON SALE IN THE LOBBY!

Fabulous Flyer Bars..... \$2.50  
*and featuring Shel Silverstein's "Fivey and Twoey" logo:*  
 Two-tone Project Hoodie..... \$40.00  
 Monotone Project Hoodie ..... \$30.00  
 Project Caps ..... \$20.00  
 Project T-shirts.....\$12.00/\$20.00  
 Project Mugs..... \$5.00  
 Project Notebook ..... \$5.00  
 Project Pencil 3-pack.....\$1.00

Thank you for coming to **CURRENT MOOD**. If you are not on our mailing list, you can join on-line at [www.52project.org](http://www.52project.org). If you're interested in being a volunteer, fill out the form below and hand it to one of our staffers in the lobby.

### PLEASE PUT ME ON YOUR LIST:

1/18

NAME \_\_\_\_\_

ADDRESS \_\_\_\_\_

CITY \_\_\_\_\_

STATE \_\_\_\_\_

ZIP \_\_\_\_\_

HOME PHONE \_\_\_\_\_

DAYTIME OR MOBILE PHONE \_\_\_\_\_

E-MAIL ADDRESS \_\_\_\_\_

MY OCCUPATION \_\_\_\_\_

MY HOBBIES \_\_\_\_\_

WANT TO BE GREEN AND SAVE THE PROJECT MONEY ON POSTAGE?  
 CHECK THIS BOX TO RECEIVE OUR NOTICES EXCLUSIVELY VIA E-MAIL.

### YES, I WOULD LIKE TO BE OF HELP. I CAN:

- |   |   |  |
|---|---|--|
| <input type="checkbox"/> Help load in and out for shows | <input type="checkbox"/> Draw and/or paint  | <input type="checkbox"/> Help kids with homework |
| <input type="checkbox"/> Hang lights                    | <input type="checkbox"/> Help with mailings | <input type="checkbox"/> Teach kids a skill      |
| <input type="checkbox"/> Work on a backstage crew       | <input type="checkbox"/> Do office work     | <input type="checkbox"/> Be a chef at an event   |
| <input type="checkbox"/> Do graphic design              | <input type="checkbox"/> Design sound       | <input type="checkbox"/> Design and sew costumes |
| <input type="checkbox"/> Other (please specify) _____   |   |  |

### MY SCHEDULE IS:

- Very flexible. I'm often available during weekdays.  
 Somewhat flexible. I can help on the occasional morning or afternoon during the week.  
 Not very flexible at all, but I've got some free time on evenings and weekends.

If you would like to mail this (and you're always welcome to enclose a tax-deductible contribution), you can send it to: The 52nd Street Project, 789 10th Avenue, New York, NY 10019. Or fax it to (212) 333-5598.



The Two-on-Two Program is made possible with public funds from The New York State Council on the Arts, a state agency, and the New York City Department of Cultural Affairs. The 52nd Street Project is a member of Art/NY and Theatre Communications Group (TCG), the national organization for the American theatre.

COMING UP SOON...



**10 KID PLAYWRIGHTS!** **20 ADULT ACTORS!**

**THE POSSIBILITY PLAYS**

THE SPRING 2018 PLAYMAKING PLAYS  
Fri, Mar. 30 - Sun, Apr. 1

THE BOARD OF DIRECTORS OF  
THE 52ND STREET PROJECT  
INVITE YOU TO SAVE THE DATE FOR

**A BUNCH OF BANANAS**



**AN EVENING WITH A PEEL**

THE ANNUAL GALA OF  
THE 52ND STREET PROJECT,  
HONORING

*Edie Falco*

MONDAY  
MAY 7, 2018  
AT  
CAPITALE

### The 52nd Street Project Board of Directors

Lisa Benavides	Frances McDormand, chair emeritus
Rachel Chanoff	Noël Mihalow
Cathy Dantchik, co-chair	Carol Ochs
Carolyn DeSena	Willie Reale, founder
Wendy Ettinger, chair emeritus	Gus Rogerson
Louis P. Friedman, co-chair	Shirley Rumierk, alumni member
Alex Gersten-Vassilaros	José Soto, Jr., alumni member
Robert Goldberg	Merritt Tilney
Stephen Graham, chair emeritus	Wendy vanden Heuvel
Natalie Hirsch	Mark Whatley
Valerie Kay	

### What's Going On Here?

The 52nd Street Project is a non-profit organization that brings children from the Hell's Kitchen neighborhood together with professional theater artists to create original theater. **CURRENT MOOD** is a production of our Two-on-Two's program, in which an adult playwright crafts a piece for a pair of 52nd Street Project kids to perform. Another adult directs the kids for a month that includes an intensive three-day weekend in Rockland County. Tonight's performance is the final result.

### In-Kind Contributions

Abbeville Press; Best Barber; Lewis Black; Brooklyn Brewery; Iris A. Brown Design; Navin Choksi; City Winery; William Curran & A Curran Affair; The Daily Show's Trevor Noah; Jenny Gersten; Haru Restaurant of Hell's Kitchen; ICI; Karen Kowgios of Withum, Smith, & Brown; The Late Show with Stephen Colbert; Make My Cake; Charlie Marshal; Noël Mihalow & Prime Films; Natasha, Pierre, and the Great Comet of 1812; Lauren Friedman, Pharma/Omni Printing; Winston Rodney Photography; Stephen Sondheim; Jenny Steingart; Merritt Tilney & Doug Kaden; Tito's Vodka; Robin Treadway; John A. Vassilaros & Sons; The Vassilaros Family; Watkins Inc.; Steve Olsen and the WestBank Cafe; and Paul, Rifkind, Wharton, & Garrison LLP.

### Special Thanks

We owe many thanks to Wendy vanden Heuvel & Brian Mertes & Melissa Kiveman; Susanna Styron; Polly King & John Paul Newport; and Patricia Kahn, all of whom graciously allowed us to use their homes in the Nyack area for three exhilarating and fun-filled days. Thanks also to Bear Mountain Skating Rink and New City Lanes for extra dollops of fun.



### BE ON THE LOOKOUT FOR INTERNS!

If you know of any college or graduate students who might enjoy working with us, playing with us, and going on trips with us for a semester, please have them contact . We are currently looking for interns for the Summer of 2018. Thanks!

## CURRENT MOOD: THE RELATABLE PLAYS - ACT 1

All original music composed by Danny Ursetti

### THE POWER PLAY

Written by James Christy

Directed by Kat Almirañez

Matteo..... Ethan Zenteno

Maya..... Kaylee Zambrano

*Playing the Fool* lyrics by James Christy

### THE LAST RANGERS

Written by Sean Kenealy

Directed by Danaya Esperanza

Herby..... Derek Rey

Deloris..... Beyonce Thomas

*Heroes of the Park* lyrics by Sean Kenealy

### BUG OFF

Written by Rachel Bonds

Directed by Roma Maffia

Fran D. .... Nicole Quiles

Fran P. .... Jayleen Velez

Max..... George Babiak

*Can I Help It?* lyrics by Rachel Bonds

## CURRENT MOOD: THE RELATABLE PLAYS - ACT 2

### THIS LAND IS MY LAND!

Written by Tim J. Lord

Directed by Jose-Maria Aguila

Jim..... Emmanuel Goicuria

Hades..... Sevan Asencio

Oilbot..... Jason Bowen

Markbot..... George Babiak

*Not for Sale* lyrics by Tim J. Lord

### FIGHTING FEARS

Written by Charly Evon Simpson

Directed by Ruffin Prentiss III

Gabby..... Rebecca Gomez

Dizzy..... Sabastian Lopez

*Fighting Fears* lyrics by Charly Evon Simpson

### #SHELFIES

Written by Naomi Lorrain

Directed by Stephanie Jean Lane

Red..... Kiara Figueroa

Mathilde..... Jayla Alvarez

*Check Me Out* and *Anew* lyrics by Naomi Lorrain





The 52nd Street Project gratefully acknowledges the support of the following foundations & corporations: The Altman Foundation; BC Partners; BGC; Benihana/HARU; Bloomberg Philanthropies; The Brenner Family Foundation; Bull's Head Foundation, Inc.; Cantor Fitzgerald; Carnegie Corporation of New York; Maxine and Irving Castle Foundation; CBS Foundation, Inc.; The CLAWS Foundation; Comedy Central; Consolidated Edison; Dawkins Family Foundation; Dramatists Play Service, Inc.; Eleanor, Adam & Mel Dubin Foundation; Eileen Fisher, Inc.; Flexis Capital, LLC; Pamela and Wayne Garrison Family Foundation; The Horace W. Goldsmith Foundation; The Stephen P. Hanson Foundation; Heisman Trophy Trust; Hudson Scenic Studio; Lambert Family Foundation; Lemle Pictures, Inc.; Frederick Loewe Foundation; LRS Designs, Inc.; MTI; Newman's Own; The Stavros Niarchos Foundation; Ninth Avenue Association; Par Plumbing Co., Inc.; Sawyer | Berson Architecture & Landscape Architecture; The Morris and Alma Schapiro Fund; Schuss Realty Associates, LLC; The Shubert Organization; The Harold & Mimi Steinberg Charitable Trust; Sterling Foundation; Susquehanna Foundation; Tax Pro Financial Network, Inc.; Tiger Baron Foundation; TZP Group LLC; John A. Vassilaros & Sons, Inc.; Yorke Construction Corp.; Zubatkin Owner Representation, LLC. We also acknowledge the following individual donors to The 52nd Street Project:

Beth & Ray Abbott	Carolyn DeSena	Alan Howard	Courtney & Lowell Pettit
Robert Abrams & Cynthia Vance	Jordan Dickenstein	Linda LeRoy Janklow	Alice Phillips Swistel
George & Pam Ackert	Alan & Marion Dienstag	Andrea Johnson	& Daniel G. Swistel
Allison & Michael Anderson	Adam & Rebecca Dixon	Melissa Jones Briggs	Michael Popper
Richard Anthony & Avi Taussig	Aurora & Daniel Donofrio	Laura Jones	Elizabeth & Ryan Porter
Becky & Dylan Baker	Billy & Ellen Dreskin	Robert Joy & Henry Krieger	Sue Poulin
Eliza Baldi & David Costabile	Rebecca & Rick Dresser	Douglas M. Kaden	Ivy & Michael Rachlin
Beth Barry & Daniel Sussman	Peter Dufault	& Merritt Tilney	Helen & Peter Randolph
Jessica Bauman & Ben Posel	Laurel Durst	Eric Karpeles & Mike Sell	Willie Reale
Lisa Benavides	Chrysti & David Eigenberg	Elliot & Kim Katz	Armando Riesco
& Tim Blake Nelson	Jeremy Erdreich	Anita Keal & Morton Wolkowitz	& Shirley Rumierk
Judy & Sam Berger	Wendy Ettinger	Beth & Clarke Keough	Annasophia Robb
Stephanie Berger & Paul King	Edie Falco	Alicia Kershaw	Anita Rogerson
Gavin Berger & Craig Berggren	Anton Fig & Laura Sametz	Mary Kong	Daniel Rosen
Elizabeth & Eric Berman	Mark Fisher	Susannah Koteen	Lynne Rosenberg
Adam Bernstein	Katherine Fleming	& Mark Sweeney	Debra & Russell Rosenthal
& Jessica Hecht	Lindsay Fram & Mason Pettit	Joyce Krawiecki	Patricia Rosenthal
Stephen Bernstein	William Frank	Jan Kroeze & Jacki Ochs	David & Laura Ross
Francine Bizar	Karen & Paul Freitas	Ellen Kroll	Meg Rushton
Lewis Black	Gene Friedman	Richard Langan	Jim & Kim Russen
Allison Blinken	Louis & Patrice Friedman	Frances & Fred Langbecker	Lyle Saunders
Jane Bolster & Steve Wertimer	David Froelich & Cynthia Kaplan	Ruth & Sid Lapidus	Karin & Tom Schall
Byron Boston	Sally Froelich	Jené LeBlanc	David Seidman & Laura Valeroso
Buzz Bovshow	Janice Gabrilove	Cindy & Richard Leibovitch	Robert Schwartz
Richard & Samantha Brand	Jeannie & Jim Gaffigan	Adrienne Lobel	Jacqueline Simon
Becky Browder & Ted Neustadt	Pamela & Wayne Garrison	Edie Lutnick	Jeremy Smith
Leah Carr	Freddie & Myrna Gershon	John C. Lynch & Brenda Wehle	Stephen Sondheim
Gil Cass	Cathe Giffuni	Marsue & Peter MacNicol	Tim Stephenson
Chris Ceraso & Carla Meadows	Glen Gillen & Michael Lawrence	Greg MacPherson	& Adriana Trigiani
Lisa Chanel	Emily Giske & Annie Washburn	& Jane Perlmutter	Bob Stockel
Lisa & Matt Chanoff	Robert Goldberg	Bruce MacVittie & Carol Ochs	Abbie Strassler
Rachel Chanoff	Shari Goodstein	Dennis Manalo	David & Patty Straus
Navin & Preeti Choksi	Bruce Graham & Valerie Kay	Frank & Linda Mavronicolas	Jenni Swan
Ellen Chopay	Jill Graham and Jon Klein	Marjorie Mayrock	Richard Sweren
Katie & Kelly Clark	Stephen Graham	Pierce McCormack	Erica & Warren Thaler
Joel Coen	Susannah Gray & John Lyons	& Bruce Whitacre	Judy & Ron Tierney
& Frances McDormand	Melinda Griffith	Josie Merck	Lisa Tilney
Lisa Cohen & David Hillman	Kimberly Grigsby	Joe & Noël Mihalow	Suzanne Tobak
Robert Cohen	Emily Grishman	Drew Milstein	Craig & Madonna Turner
& Danielle Mindess	& Susan Sampliner	Carla & Yohan Minaya	Fred & Sarah Turpin
Ruth Cohen & Bob Usdin	Jan Gura & Alan Pickman	Donald Monti	Jan-Willem van den Dorpel
Sherry Cohen	Warren E. Hannas	Daryl & Michael Moss	Alexandra Vassilaros
Brad Coley	Susan Hanson	Amanda & Neal Moszkowski	Maria Vassilaros
& Wendy vanden Heuvel	Barnaby Harris & Suzie Kondi	Suzen Murakoshi	& William Zucearia
Penny Collins	Karen Hauser & Warren Leight	Randy & Rona Nelson	Mary Pat Walsh
Dan Colussy	Ann & David Hausmann	Ruth Nelson	Sharon Washington
Megan Cramer	Amy Herzig	Evan Newmark & Ellen West	Norbert Weissberg
Billy Crudup	Barbara & Eric Hippeau	Larry & Rachel Norton	David Weller
Michaela Culver	Josie Holtzman	Debra Oochino	Mark & Vicki Whatley
William Curran	& Isaac Kestenbaum	Lori O'Connor	Susan Whitehead
& Patrice Delcasino	Willy Holtzman & Sylvia Shepard	Beth & Bob Ollwerther	Carole Yass
Cathy Dantchik	Katy Homans & Patterson Sims	Kevin O'Rourke & Edith Thurber	Janine & Jeffrey Yass
Leslie Dantchik & Mitch Horowitz	Gary Horowitz & Alan Krevis	F. Richard Pappas	Brett Young-Fountain
Robert Denenberg	Sarah Horowitz & David Venarde	George Petrides	Abby Zeichner

THE 52ND STREET PROJECT PRESENTS



THE  
SPRING 2018  
PLAYMAKING  
SHOWS

10 new plays written by kids  
and performed by adult actors

FRIDAY, MARCH 23

@ 7:30 P.M.

SATURDAY, MARCH 24

@ 3:00 & 7:30 P.M.

SUNDAY, MARCH 25

@ 3:00 P.M.



ARTWORK BY JO PERL-STRAHAN

THE FIVE ANGELS THEATER

# DREAM BIG: THE POSSIBILITY PLAYS

The Spring 2018 Playmaking Shows - March 23-25, The Five Angels Theater

## The 52nd Street Project Staff

Kat Almirañez, Associate Artistic Director  
Ahmed Attia, Development Associate\*  
George Babiak, Director of Design and Production  
Liz Bell, Clinical Consultant  
Kali Crandall, Development Director  
Caylyn Creager, Education Assistant  
Brian Freeland, Production Manager  
Natalie Hirsch, Artistic Director  
Garrett Kim, Program Director  
Carol Ochs, Executive Director  
Gus Rogerson, Producing Director  
John Sheehy, Director of Institutional Advancement  
Johanna Vidal, Director of Education\*  
Yazzy Wilder, Office Manager\*  
Iris A. Brown, Graphic Design Consultant  
*\*Project Alumni*

### Interns:

Jason Bowen, Elena Woughter

### Teen Employees:

Receptionists: Jasmine Correa, Jade Cuevas, Daniel Martinez, Chayse Peña, Tiniyah Powell  
Ushers: Jasmine Correa, Daniel Martinez, Kayla Matos, Tiniyah Powell, Karen Tineo  
Teen Playmaking Assistant: Wilhelmina Ohene Kari Kari

## “DREAM BIG” Production Staff

### Composer/Music Director

Kim D. Sherman

### Costume Designers

Sarah Beck, Paula Cohen, and  
Hannah Dowdy

### Set Designer

Kevin Joseph Roach

### Lighting Designer

Emmanuel Delgado

### Sound Designer/Operator

Brian Freeland

### Stage Manager

Jenni Swan

### Projection Designs

George Babiak and Caylyn Creager

### Prop Creation Team

George Babiak, Caylyn Creager, and  
Elena Woughter

### Backstage Crew

Jason Bowen, Kyle David Fitzgerald,  
Temitope Oladeji, Jayleen Velez,  
Elena Woughter

### House Management

Carol Ochs, John Sheehy

### Flyer/Program Art

Io Perl-Strahan

### Weekend-Away Chefs

John Sheehy and Carol Ochs

### Class Volunteers

Erin Felgar, Kyle David Fitzpatrick,  
Robin Galloway, Lora Lee Gayer,  
Alex Gould, Tyler Hollinger,  
Christina Nieves, Samuel Pearce,  
Samuel Stonefield, Kea Trevett,  
Marielle Young

## COOL STUFF ON SALE IN THE LOBBY!

Fabulous Flyer Bars ..... \$2.50  
*and featuring Shel Silverstein's "Fivey and Twoey" logo:*  
Two-tone Project Hoodie ..... \$40.00  
Monotone Project Hoodie ..... \$30.00  
Crew-neck sweatshirts ..... \$20.00  
Project Caps ..... \$20.00  
Project T-shirts ..... \$12.00/\$20.00  
Project Mugs ..... \$5.00  
Project Notebook ..... \$5.00  
Project Pencil 3-pack ..... \$1.00

Thank you for coming to **DREAM BIG**. If you are not on our mailing list, you can join on-line at [www.52project.org](http://www.52project.org). If you're interested in being a volunteer, fill out the form below and hand it to one of our staffers in the lobby.

### PLEASE PUT ME ON YOUR LIST:

03/18

NAME \_\_\_\_\_

ADDRESS \_\_\_\_\_

CITY \_\_\_\_\_

STATE \_\_\_\_\_

ZIP \_\_\_\_\_

HOME PHONE \_\_\_\_\_

DAYTIME OR MOBILE PHONE \_\_\_\_\_

E-MAIL ADDRESS \_\_\_\_\_

MY OCCUPATION \_\_\_\_\_

MY HOBBIES \_\_\_\_\_

WANT TO BE GREEN AND SAVE THE PROJECT MONEY ON POSTAGE?  
CHECK THIS BOX TO RECEIVE OUR NOTICES EXCLUSIVELY VIA E-MAIL.

### YES, I WOULD LIKE TO BE OF HELP. I CAN:

- |   |   |  |
|---|---|--|
| <input type="checkbox"/> Help load in and out for shows | <input type="checkbox"/> Draw and/or paint  | <input type="checkbox"/> Help kids with homework |
| <input type="checkbox"/> Hang lights                    | <input type="checkbox"/> Help with mailings | <input type="checkbox"/> Teach kids a skill      |
| <input type="checkbox"/> Work on a backstage crew       | <input type="checkbox"/> Do office work     | <input type="checkbox"/> Be a chef at an event   |
| <input type="checkbox"/> Do graphic design              | <input type="checkbox"/> Design sound       | <input type="checkbox"/> Design and sew costumes |
| <input type="checkbox"/> Other (please specify) _____   |   |  |

### MY SCHEDULE IS:

- Very flexible. I'm often available during weekdays.  
 Somewhat flexible. I can help on the occasional morning or afternoon during the week.  
 Not very flexible at all, but I've got some free time on evenings and weekends.

If you would like to mail this (and you're always welcome to enclose a tax-deductible contribution), you can send it to: The 52nd Street Project, 789 10th Avenue, New York, NY 10019. Or fax it to (212) 333-5598.



The Playmaking Program is made possible with public funds from The New York State Council on the Arts, a state agency, and the New York City Department of Cultural Affairs. The 52nd Street Project is a member of Art/NY and Theatre Communications Group (TCG), the national organization for the American theatre.

The Board of Directors of  
The 52nd Street Project  
invite you to save the date for

# A BUNCH OF BANANAS

**AN EVENING WITH A PEEL**

The Project's Annual Gala,  
this year honoring our friend

**Edie Falco**



**Monday, May 7, 2018 at  
CAPITALE  
on Grand St. & Bowery**

For information contact Kali Crandall  
at [crandall@52project.org](mailto:crandall@52project.org)

## The 52nd Street Project Board of Directors

Lisa Benavides	Frances McDormand
Rachel Chanoff	Noël Mihalow
Cathy Dantchik, co-chair	Carol Ochs
Carolyn DeSena	Willie Reale, founder
Wendy Ettinger, chair emeritus	Gus Rogerson
Louis P. Friedman, co-chair	Shirley Rumierk, alumni member
Alex Gersten-Vassilaros	José Soto, Jr., alumni member
Robert Goldberg	Merritt Tilney
Stephen Graham, chair emeritus	Wendy vanden Heuvel
Valerie Kay	Mark Whatley

## What's Going On Here?

The 52nd Street Project is a non-profit organization that brings children from the Hell's Kitchen neighborhood together with professional theater artists to create original theater. **DREAM BIG** is a production of our Playmaking program. Young people participate in a nine-week playwriting course taught by Kat Almirañez and adapted for the Project by Daniel Judah Sklar from his book *Playmaking: Children Writing and Performing Their Own Plays*. At the end of the course, each child is matched with two actors and a dramaturg/director who guides him or her through the writing of a play during a weekend retreat in the country (Bridgehampton, Long Island, for this show). This performance is the end result.

## In-Kind Contributions

Abbeville Press; Ardesia; Lewis Black; Brooklyn Brewery; Iris A. Brown Design; Cellar 53; Navin Choksi; City Winery; William Curran & A Curran Affair; The Daily Show's Trevor Noah; Jenny Gersten; Haru Restaurant of Hell's Kitchen; ICI; Karen Kowgios of Withum, Smith, & Brown; The Late Show with Stephen Colbert; Charlie Marshal; Noël Mihalow & Prime Films; Lauren Friedman, Pharma/Omni Printing; Winston Rodney Photography; Stephen Sondheim; Jenny Steingart; Merritt Tilney & Doug Kaden; John A. Vassilaros & Sons; The Vassilaros Family; Watkins Inc.; and Paul, Rifkind, Wharton, & Garrison LLP.

## Special Thanks

We'd like to thank the incredibly talented costume designer Helen Toth for her help and advice on this production. Extra-special thanks go to Theatrical Wardrobe Union Local 764, IATSE for generously footing the bill for this production's costumes.

We're extremely grateful to Alexandra Gersten-Vassilaros for the use of her beautiful home in Bridgehampton, NY as our base of operations for the writer's retreat. We're also grateful to Cathy Dantchik for being the host for the girl playwrights, and to Laurie Becker for housing some of the adult volunteers in Sag Harbor. And, finally, a big dollop of thanks to Scott Bolman and Wingspace!



## BE ON THE LOOKOUT FOR INTERNS!

If you know of any college or graduate students who might enjoy working with us, playing with us, and going on trips with us for a semester, please have them contact Yazy Wilder ([ywilder@52project.org](mailto:ywilder@52project.org)). We are currently looking for interns for the Summer of 2018. Thanks!

# DREAM BIG: THE POSSIBILITY PLAYS. ACT 1

All original music composed by Kim D. Sherman

## FANTASY FOREST

Written by Cassandra Sinchi, age 9  
Dramaturge: Michelle Taliento, Director: Kel Haney  
Edgar ..... Ronald Peet  
Teddy ..... Amber Gray  
Mom ..... Elena Woughter  
Gnome/Troll ..... Kyle Fitzgerald  
*There's Always a Light* lyrics by Cassandra Sinchi

## DREAMS

Written by Hala Eldeeb, age 9  
Dramaturge: Arielle Goldman, Director: Rachel Dart  
Elie, an elephant ..... Rosa Gilmore  
Hissy, a hippo ..... Jessica Savage  
*Livin' in Peace* and *Both Our Dreams* lyrics by Hala Eldeeb

## THE FIGHT BETWEEN BROTHER AND SISTER

Written by Walter Olivares, age 11  
Dramaturge: Kat Almirañez, Director: George Babiak  
Emmally Carton ..... Shirley Rumierk  
Milk Carton ..... Joe Tippett  
Animals and salespeople ..... The Crew  
*I Hate Hamsters* and *The Past* lyrics by Walter Olivares.

## KRISPY KREME DREAMS

Written by Nyaliz Aviles, age 11  
Dramaturge/Director: Anne Troup  
Gabe ..... Bhavesh Patel  
Gabby ..... Flor De Liz Perez  
*Krispy Kreme Jingle*, *Should Have Told Me*, and *Friends Forever* lyrics by Nyaliz Aviles

## BLUE LEOPARD (AKA ZACK) VS. RED WHALE (AKA JEFF BOB, JR.)

Written by Christian Santoni, age 11  
Dramaturge/Director: Vichet Chum  
Blue Leopard, aka Zack ..... Justin Walker White  
Red Whale, aka Jeff Bob, Jr. .... Alex J. Gould  
*End This Madness* lyrics by Christian Santoni



# DREAM BIG: THE POSSIBILITY PLAYS. ACT 2

## GOOD AT BASKETBALL...NOT!

Written by Daniel Henk, age 11  
Dramaturge/Director: Corey Jackson  
Jay ..... Sullivan Jones  
Jayden ..... Stephen Stocking  
Coach ..... George Babiak  
Other players ..... Jayleen Velez and Temitope Oladeji  
*Jaden's Song* lyrics by Daniel Henk

## NERD TO THE WORD

Written by Payton Rodriguez, age 9  
Dramaturge/ Director: Emma Ramos  
Jase ..... Jose Gamo  
Lala ..... Sheila Vand  
*Madame President* lyrics by Payton Rodriguez

## THE UNKNOWN BROTHER AND SISTER

Written by Quilvis Medina, age 10  
Dramaturge: Garrett Kim, Director: Brisa Muñoz  
Otto, a sea otter ..... Diego A. González  
Octy, an octopus ..... Ka-Ling Cheung  
Voices of Mom and Dad ..... Kat Almirañez and George Babiak  
*To The Surface* lyrics by Quilvis Medina

## SMELLS LIKE FEBREEZE

Written by Nikolai Alvarez, age 10  
Dramaturge/Director: Michael Walkup  
Jessie Alvarado ..... Lucy DeVito  
Bob (Big Man) Jones ..... Alex J. Moreno  
*A Wish* lyrics by Nikolai Alvarez

## GRAMMAR GIRL

Written by Lanai Blake-Soden, age 10  
Director/Dramaturge: Grace Rex  
Zexolaquel ..... Jennifer Ikeda  
Firestar ..... Leta Renée-Alan  
Students ..... The Crew  
Principal ..... John Sheehy  
*I Wanted A Friend* lyrics by Lanai Blake-Soden



## The 52nd Street Project Staff

Kat Almirañez, Associate Artistic Director  
Ahmed Attia, Development Associate\*  
George Babiak, Director of Design and Production  
Liz Bell, Clinical Consultant  
Kali Crandall, Development Director  
Caylyn Creager, Education Assistant  
Brian Freeland, Production Manager  
Natalie Hirsch, Artistic Director  
Garrett Kim, Program Director  
Carol Ochs, Executive Director  
Gus Rogerson, Producing Director  
John Sheehy, Director of Institutional Advancement  
Johanna Vidal, Director of Education\*  
Yazzy Wilder, Office Manager\*  
Iris A. Brown, Graphic Design Consultant  
*\*Project Alumni*

### Interns:

Jason Bowen, Elena Woughter

### Teen Employees:

Receptionists: Jasmine Correa, Jade Cuevas, Daniel Martinez, Chayse Peña,  
Tinah Powell

Ushers: Jasmine Correa, Daniel Martinez, Kayla Matos, Tinah Powell, Karen Tineo

Teen Playmaking Assistant: Wilhelmina Ohene Kari Kari

## The 52nd Street Project Board of Directors

Lisa Benavides	Frances McDormand
Rachel Chanoff	Noël Mihalow
Cathy Dantchik, co-chair	Carol Ochs
Carolyn DeSena	Willie Reale, founder
Wendy Ettinger, chair emeritus	Gus Rogerson
Louis P. Friedman, co-chair	Shirley Rumierk, alumni member
Alex Gersten-Vassilaros	José Soto, Jr., alumni member
Robert Goldberg	Merritt Tilney
Stephen Graham, chair emeritus	Wendy vanden Heuvel
Valerie Kay	Mark Whatley

The 52nd Street Project Presents



## The 52nd Street Project's Annual Dance Concert

Featuring 6 original dances choreographed by  
kids and performed by kids and adults.

Dancemaking Director: HannaH Allen

Friday, April 27, 2018 – 7:30 p.m.

The Five Angels Theater  
The 52nd Street Project  
789 10th Avenue



The Dancemaking Program is made possible with public funds from The New York State Council on the Arts, a state agency, and the New York City Department of Cultural Affairs. The 52nd Street Project is a member of Art/NY and Theatre Communications Group (TCG), the national organization for the American theatre.

The 52nd Street Project is a non-profit arts organization that brings children from the Hell's Kitchen neighborhood together with professional artists to create original art. The Dancemaking program gives 7 Project kids a chance to express themselves creatively through movement. Over the nine weeks of Dancemaking class, led by Hannah Allen with support from Program Director Garrett Kim, these young choreographers and performers developed their own movement vocabulary. With their adult "Choreoturges," they explored shapes, pathways, actions, and choreographic elements to create their own original piece. The resulting dances are featured in tonight's performance.



## Particles

Choreographed by Hannah Allen

MUSIC: "Waveland" by Noam Pikelny & "Lovely You" by Monster Rally

THEME: Individual & group identity

## Friends

Choreographed by Magalis Fabian

Adult partner: Margaret Odette

MUSIC: "Turtle Spa" by Hans Zimmer, Jacob Shea, and David Fleming for Blue Planet II

THEME: Flowing/Water

*CHOREOGRAPHER'S NOTE: "It was hard for me and my partner to embody water in a dance. I liked that I was able to work with an amazing person."*

## My Jazz Party

Choreographed by Morgan Smalls

Adult partner: Stephanie Linas

MUSIC: "Santiago" by Preservation Hall Jazz Band

THEME: Celebration/Party

*CHOREOGRAPHER'S NOTE: "I had fun working with Stephanie and I hope you enjoy the show. At the end, I really got to know her."*

## Ninja Art

Choreographed by Ryan Billah

Adult partner: John Manolis

MUSIC: "Concerto No. 2 in G Minor, Op. 8, RV 315, "L'estate"  
(Summer): III. Presto (arr. O Duo)"

composed by Antonio Vivaldi, performed by O Duo

THEME: Ninja Kinetic Energy

*CHOREOGRAPHER'S NOTE: "It's a very fast-paced piece. This is based off my favorite TV show "Naruto." I really enjoyed making unique movements."*

## The Wild Ones

Choreographed by Kiara Figueroa

Adult Partner: Elli Brown

MUSIC: "Passepied (Debussy)" performed by Punch Brothers

THEME: Trying to be yourself when others are trying to control you

*CHOREOGRAPHER'S NOTE: "This is about someone trying to be controlled but wanting to be free. But I really had so much fun making this dance. The solos were the hardest part. But my amazing partner helped me so much, that it made it ten times easier. I'm glad I got to know her."*

## Fame

Choreographed by Kimora Moore

Adult partner: Hayley Sherwood

MUSIC: "Time's All Gone, Pt. 2" by Nick Waterhouse

THEME: Fame

*CHOREOGRAPHER'S NOTE: "The move that I like is when we do the cart-wheel!!!! Because I'm good at it!"*

## The Animals Dance

Choreographed by Amari Dubose

Adult partner: Mitchell Winter

MUSIC: "Something worth Protecting" by Hans Zimmer, Jacob Shea, Jasha Klebe from Planet Earth II

THEME: Fighting and striving for what you want

*CHOREOGRAPHER'S NOTE: "Me and my partner Mitchell had a lot of fun doing the dance and making new moves. I loved the music and also in the beginning when we didn't know where to start."*

## Eye of the Storm

Choreographed by Aaron Ordinola

Adult partner: Ian Edlund

MUSIC: "Jubilee" by The Juju Exchange

THEME: A normal day and then a tornado comes through it.

*CHOREOGRAPHER'S NOTE: "Our piece was hard to make because it is very energy-consuming and we sweat a lot. I know it will be worth it to see."*

## The 52nd Street Project Board of Directors

Lisa Benavides	Noël Mihalow
Rachel Chanoff	Carol Ochs
Cathy Dantchik, co-chair	Willie Reale, founder
Carolyn DeSena	Gus Rogerson
Wendy Ettinger, chair emeritus	Shirley Rumierk, alumni member
Louis P. Friedman, co-chair	José Soto, Jr., alumni member
Robert Goldberg	Merritt Tilney
Stephen Graham, chair emeritus	Wendy vanden Heuvel
Natalie Hirsch	Alexandra Vassilaros
Valerie Kay	Mark Whatley
Frances McDormand	

## The 52nd Street Project Staff

Kat Almirañez, Associate Artistic Director  
Ahmed Attia, Development Associate\*  
George Babiak, Director of Design and Production  
Liz Bell, Clinical Consultant  
Kali Crandall, Development Director  
Caylyn Creager, Education Assistant  
Brian Freeland, Production Manager  
Natalie Hirsch, Artistic Director  
Garrett Kim, Program Director  
Carol Ochs, Executive Director  
Gus Rogerson, Producing Director  
John Sheehy, Director of Institutional Advancement  
Johanna Vidal, Director of Education\*  
Yazzy Wilder, Office Manager\*

### \*Project Alumni

### Interns

Jason Bowen, Elena Woughter

### Benefit Volunteers

Gillian Curry, Ashley Marie Ortiz,  
Kim D. Sherman, Vanessa Valdes

Bloomberg  
Philanthropies



The programs of The 52nd Street Project are made possible with public funds from The New York State Council on the Arts, a state agency, and the New York City Department of Cultural Affairs. The 52nd Street Project is a member of Art/NY and Theatre Communications Group (TCG), the national organization for the American theatre.

CO-CHAIRS LIZ FLAHIVE & WARREN LEIGHT,  
THE BOARD OF DIRECTORS OF THE 52ND STREET PROJECT,  
& THE CLAWS FOUNDATION PRESENT:

A BUNCH OF  
**BANANAS**  
An Evening with a Peel

Honoring our pal  
**EDIE FALCO**

Monday, May 7, 2018  
Capitale

## "A Bunch of Bananas" Benefit Co-Chairs

Lisa Benavides	Louis & Patrice Friedman
Becky Browder	Karin Schall
Rachel Chanoff	Merritt Tilney
Cathy Dantchik	Laura Valeroso
Carolyn DeSena	Mary Pat Walsh

## The 52nd Street Project gratefully acknowledges...

Abbeville Press  
Sara Bareilles, Waitress LLC  
Iris A. Brown Design  
William Curran, A Curran Affair  
Edie Falco  
Lauren Friedman, Pharma Print, Inc.  
Haru Restaurants & Sushi Bar  
Jarritos  
Charlie Marshal  
Michelle McKenna, NFL  
Noël Mihalow, Prime Films  
Nickelodeon  
The Parnes Office  
Willie Reale  
Winston Rodney  
Shirley Rumierk  
Katie Savage  
Jenny Steingart  
Merritt Tilney & Doug Kaden  
Vassilaros & Sons  
The Vassilaros Family  
The Watkins Company



## Bananas in Pajamas Seats

Beth & Ray Abbott	Frances & Fred Langbecker
Becky & Dylan Baker	Jené LeBlanc
Beth Barry & Daniel Sussman	Melissa Liebling-Goldberg & John Barrett
Stephanie Berger & Paul King	Adrienne Lobel
Elizabeth & Eric Berman	Jane & Greg MacPherson
Stephen Bernstein	Carla & Yohan Minaya
Jane Bolster & Steve Wertimer	Suzen Murakoshi
Becky Browder & Ted Neustadt	Lori O'Connor
Stephanie Browner & Richard C. Hamlin	Carol Ochs & Bruce MacVittie
Denise Burse & Peter Jay Fernandez	Jacki Ochs & Jan Kroeze
Leah Carr	Beth & Bob Ollwerther
Rachel Chanoff	Courtney & Lowell Pettit
Ellen Chopay	Sue Poulin
Katie & Kelly Clark	Michael Pressman
Lisa Cohen & David Hillman	Ivy & Michael Rachlin
Sherry Cohen	Christopher Randolph
Penny Collins	Willie Reale
Marion & Alan Dienstag	Peter Robbins
Rebecca & Rick Dresser	Anita Rogerson
Michaelene Durst	Lynne Rosenberg
Tara Elwin & Andre Meade	Shirley Rumierk & Armando Riesco
Katie Flahive	Olivia Sabine
Liz Flahive & Jeff Cox	Lyle Saunders
Sally Froelich	Karin & Tom Schall
Tina Galley	Liza Steinberg-Demby & Eric Demby
Samantha & Alex Kaczmarek	Jenni Swan
Anita Keal & Morton Wolkowitz	Richard Sweren
Alan Krevis & Gary Horowitz	Laura Valeroso & David Seidman
Henry Krieger & Robert Joy	Mary Pat Walsh
Ellen Kroll	Tracy Wan
Judy Kuhn & David Schwab	





### **Top Banana Table**

The CLAWS Foundation

### **Orange You Glad We Didn't Say Banana Tables**

Bloomberg Philanthropies  
CBS & Showtime  
Patrice & Louis Friedman  
HBO



### **Yes, We Have No Bananas Tables**

Avi & Richard Anthony  
Dawkins Family Foundation  
Carolyn DeSena  
Beverly Gasner

Bob Goldberg, Yorke Construction Corporation  
Karen Hauser & Warren Leight  
Merritt Tilney & Douglas Kaden

Wendy vanden Heuvel  
Vassilaros & Sons  
Vicki & Mark Whatley  
Wolf Entertainment



### **Bananarama Seats**

Lisa Benavides  
& Tim Blake Nelson  
Gavin Berger & Craig Berggren  
Lewis Black  
Allison Blinken  
Jeremy Erdreich  
Lindsay Fram & Mason Pettit  
Janice Gabrilove  
& Michael Dirzulaitis  
Ann & David Hausmann  
Katy Homans & Patterson Sims  
Sarah Horowitz & David Venarde  
Cynthia Kaplan & David Froelich

Mickey Lemle  
Steve Olsen  
Randi Puccio  
Laura & David Ross  
Steve Sabba, Tax Pro Financial  
Network, Inc.  
Laura Sametz & Anton Fig  
Brian Sawyer,  
Sawyer | Berson  
Sylvia Shepard & Willy Holtzman  
Jeremy Smith  
Edith Thurber & Kevin O'Rourke  
Carole Yass

Carol Ochs,  
Executive Director

Cathy Dantchik & Louis P. Friedman,  
Board Co-Chairs

Natalie Hirsch,  
Artistic Director

# **A BUNCH OF BANANAS**

The 52nd Street Project's Annual Benefit Gala

Monday, May 7, 2018 at Capitale

Co-chairs Liz Flahive and Warren Leight

### **Our Host**

David Costabile



### **The Lyricists**

Ryan Billah  
Edelys Guerrero  
Hannah Leon  
Andres Mendoza  
Angel Mendoza



### **The Composers and Performers**

Bryan Blaskie  
Benedict Braxton-Smith  
Alanya Bridge  
Emily Chiu  
Auli'i Cravalho  
Ellie Desaults  
Jin Ha  
Korey Jackson  
Gizel Jimenez  
Patrick Thompson



### **Music Director/Piano**

Avi Amon

### **Guitarist**

Doug Derryberry

### **Music Arrangement**

Avi Amon

### **Lighting Designer**

Greg MacPherson

### **Sound Designer**

Nate Putnam

### **Set and Prop Designer**

George Babiak

### **Stage Manager**

Jenny Peek

### **Invitation/Program Designs**

Katie Savage

### **Director**

Gus Rogerson



# Jump Off

Lyrics by Ryan Billah, age 12

Music by Bryan Blaskie

Performed by Jin Ha

It was my best friend Dean's 11th birthday,  
Going ziplining and jumping on obstacles.  
Felt anxious about ziplining.  
Scared that I would fall even though I had a safety harness.  
Afraid it might break. Afraid the line snaps.  
Afraid that I would hurt myself.  
It wasn't a good feeling.

So I still wanted to experience ziplining.  
I had to do parkour to reach the zipline.  
I have a fear of heights,  
But I won't have a chance to zipline again for a long time  
And I can't go back.  
So I felt a burst of confidence  
When I knew that the zipline wasn't long.  
Then I attached my harness to the line,  
Held it tightly and then jumped off.

It felt fast. I was gliding like Batman using his grappling hook.  
I saw the top of the trees, little kids, and a campfire.  
The ground was very far from me.  
Like the distance from the moon and earth.  
It was a crazy new experience that I never felt before.

The zipline slowed down, it was near over.  
I bounced off a wooden platform.  
Even though the zipline was only 15 seconds  
It felt really quick like if I was the Flash.  
I felt relaxed and it was fantastic.  
I felt happy and brave like a lion.  
You don't have to be scared.  
You can accomplish anything if you don't give up.  
Do what I do and jump off. 🎸

# The Edie Chronology

Edie's done a lot at the Project over the years, specializing in the quirky characters created by our kid writers. Here's the list.

## May, 2000

"Aargh!" The Pirate Benefit, Co-host

## March, 2001 - Playmaking

Single Beauties by Suzette Santana, age 10.  
"Nayomi," an ambitious singer/dancer.

## April, 2004 - Playmaking

Comet and Bud's Adventure  
by Pablo Maldonado, age 10.  
"Comet," a deer that happens  
to be a mechanic.

## May, 2004

"The Project Show" Benefit, Co-host

## December, 2005 - Playmaking

Lost in the Woods by Andy Reyes, age 9.  
"Deery," another deer,  
this time lost in the forest.

## March, 2007 - Playmaking

The Love of a Thief and a Lady  
by Tino Paduani, age 11.  
"Hanna Jane," a jewelry store owner  
who falls in love with a thief.

## May, 2008

"The Mezzo-Sopranos" Benefit  
"Carmela," in the only Sopranos  
sequel done to date.

## April, 2014 - Playmaking

The Crisis by Daniel Tineo, age 10.  
"Daisy," an African thorn tree  
threatened by a hungry zebra.

## May, 2015

"Fancy That" Benefit, host.

## December, 2015 - Playmaking

Genny and Mark  
by Bryanna Ohene Kari Kari, age 11  
"Genny," a teen-age princess  
with a workaholic father.

## December, 2017 - Playmaking

Jabba the Hutt  
by Evaluna Santoni, age 10.  
"Sofia," a Star Wars-obsessed chef.





## Bananas Forever

Lyrics by Angel Mendoza, age 12

Music by Patrick Thompson

Performed by Auli'i Cravalho

I am yellow  
I am healthy  
I am a bread topping  
I can be used for many foods  
I want to have friends (banana)

I have someone to talk to  
I can explore the whole country  
We can go to outer space in a toy rocketship  
    which is powered by bread  
We can go right now!

We'll see planets, houses, parks and shops  
(delis, supermarkets, malls, convenience store)

We'll land in a mansion which was abandoned by  
    George Washington

We'll have a party for surviving the test which sees if  
    you are allowed inside outer space.  
We'll stay in outer space  
As bananas forever  
Bananas forever  
Bananas forever  
Be'll stay in outer space  
Until we become green (old) ♪

## Life

Lyrics by Andres Mendoza, age 12

Music by Benedict Braxton-Smith

I get in trouble a lot for little things  
And then I get stressed  
I get annoyed very easily  
And then I get depressed

Chorus  
But you've gotta  
Have Fun  
And be positive

I broke my favorite toy when I stepped on it  
And then I broke my phone  
I spent all my money and I went broke  
And then I broke my bone

That's just downs of life.  
But there are ups!  
And you've gotta have fun

Chorus  
But you've gotta  
Have Fun  
and be positive  
But you've gotta  
Have Fun  
And be positive

Tag "and be positive" ♪





# Learning to Love Again

Lyrics by Edelys Guerrero, age 17

Music by Emily Chiu

Performed by Ellie Desautels

Abandoned at the age of 15  
Alone with no water  
No food  
And no home.  
She stays waiting and waiting  
With no phone.

She walks the entire  
bus terminal  
Hoping and wishing  
Someone will come.  
But weeks go by  
And no one comes.  
She loses the hope to love,  
Scared if she loves again  
She'll be abandoned once more.

As she's walking through  
the terminal  
She sees something.  
She's never seen before.  
A small box that begins to move,  
She walks up to the box  
A small puppy jumps out.

She begins to feel  
something inside,  
Something warm  
That's never been felt before  
In a long long time  
She learned how to love again.

As weeks go by with her  
and her new puppy.  
The security guard notices  
She's all alone  
He wants to help her  
Find a family  
Then offers to start taking  
care of her  
They become a small family  
And she learned how  
to love again

And she learned how  
to love again ♪

# Space

Lyrics by Hannah Leon, age 11

Music by Alanya Bridge

Performed by Korey Jackson  
and Gisel Jimenez



DAD  
(Talks to himself) Being an astronaut is hard,  
even harder with my kid...

KID  
Space, space, space  
Swarming through the planets  
Space, space, space  
I see Pluto and Jupiter

KID/DAD  
Space, space, space  
All of this is amazing  
I can't take this  
It's all my favorite

KID  
I see the bamboo planet  
(music stops, spoken:)  
BTW it's made up of bamboo  
and of course the cutest  
animal in the world, pandas!  
(music continues, sung:)  
Space, space, space  
Daddy can I take them  
So I can play with them

DAD  
NO NO NO  
I'm so sorry baby

KID/DAD  
Space, space, space  
I see Saturn, Mars  
And all those other planets  
They are all so amazing

KID  
Space, space, space  
I wanna jump on them  
Space, space, space  
Please I really want them  
So I can collect them

DAD  
NO NO NO  
I'm so sorry sunny...  
I just want to protect you

KID/DAD  
Space, space, space  
I see Saturn, Mars  
And all those other planets  
It's so amazing  
Space, space, space  
Space ♪

The 52nd Street Project (The Project) is dedicated to the creation and production of new plays for and by kids between the ages of ten and eighteen who reside in the Hell's Kitchen neighborhood in New York City. The Project does this through unique mentoring programs that match kids with professional (and volunteer) theater artists.

TBH (short for "To be honest") is a production of our Teen Ensemble Program. The Teen Ensemble is a two year acting conservatory program, which includes several public performances of original material and culminates in a full-length dramatic production. This show is the last stage of their first year.

After a year that included classes in movement, improvisation, scene study, poetry and singing, the teens met with six adult playwrights. After their meetings, the adult playwrights scurried off to their garrets to write the plays we are now presenting.

Special thanks to all of our wonderful volunteer guest artists who have worked with the Teen Ensemble in their classes throughout this year: **Therese Barba-to, Sarah Bishop, Sam Dash, Jose Duran, Jose Gamo, Nico Grelli, Jimmy Kenna, Kareem M. Lucas, Christopher Moncayo-Torres, Carrigan O'Brien, Rachel Pickup, Ciana Proto, Sarah Quigley, Lynne Rosenberg, Krysten Schmelzer, Charlie Evon Simpson, Angie Toledo, Natasha Warner, Kerry Warren, Courtney Williams, and Marielle Young.**

Thanks also to the Public Theater Mobile Unit for comps that allowed Ensemble members to see *Henry V* and *A Winter's Tale*.

We also want to express our gratitude to **Drew University** for the use of their terrific campus for the Teen Weekend trip, where the teens rehearsed these plays and got a sneak peek at college life.

The following foundations and government agencies have generously supported the Teen Program through their contributions:

City of New York Department of Cultural Affairs  
Horace W. Goldsmith Foundation  
New York State Council on the Arts  
Harold & Mimi Steinberg Charitable Trust



The 52nd Street Project Presents

# TBH

## THE TRUTH PLAYS

The Bi-Annual  
Teen Ensemble  
One-Act Play Festival

Friday, June 1, 2018 at 7:30  
Saturday, June 2nd, 2018 at 3:00

The Five Angels Theater

### **The 52nd Street Project Staff**

Kat Almirañez, Associate Artistic Director  
 Ahmed Attia, Development Associate\*  
 George Babiak, Director of Design and Production  
 Liz Bell, Clinical Consultant  
 Kali Crandall, Development Director  
 Caylyn Creager, Education Assistant  
 Brian Freeland, Production Manager  
 Natalie Hirsch, Artistic Director  
 Garrett Kim, Program Director  
 Carol Ochs, Executive Director  
 Gus Rogerson, Producing Director  
 John Sheehy, Director of Institutional Advancement  
 Johanna Vidal, Director of Education\*  
 Yazzy Wilder, Office Manager\*  
 Iris A. Brown, Graphic Design Consultant  
 \*Project Alumni

#### **Interns:**

Gus Reale, Vanessa Porras

#### **Teen Employees:**

Receptionists: Jasmine Correa, Daniel Martinez, Kayla Matos,  
 Tinish Powell, Jayleen Velez,  
 Ushers: Jayleen Velez, Kiara Figueroa, Jasmine Correa  
 Videographer: Enrique Caballero

#### **The “TBH” Team**

Jennifer Fok..... Lighting Designer  
 Lara De Bruijn..... Costume Designer  
 Chayse Peña..... Sound Designer  
 Gus Reale..... Crew  
 Vanessa Porras..... Crew

### **The 52nd Street Project Board of Directors**

Lisa Benavides	Frances McDormand
Rachel Chanoff	Noël Mihalow
Cathy Dantchik, co-chair	Carol Ochs
Carolyn DeSena	Willie Reale, founder
Wendy Ettinger, chair emeritus	Gus Rogerson
Louis P. Friedman, co-chair	Shirley Rumierk,
Alex Gersten-Vassilaros	alumni member
Robert Goldberg	José Soto, Jr., alumni member
Stephen Graham, chair emeritus	Merritt Tilney
Natalie Hirsch	Wendy vanden Heuvel
Valerie Kay	Mark Whatley

### **TBH THEME SONG**

Written by the Teen Ensemble and composed by Tony Macht

### **GIRLS FIGHT MORE (BOYS FIGHT HARDER)**

Written by Beto O’Byrne and directed by Lynne Rosenberg  
with assistance from Angie Toledo

Veronica..... Genesis Hires  
 Tamara..... Tiffany Miller  
 Kris ..... Kai Ceniza

### **THE UNDERCOVERS**

Written by Jiehae Park and directed by Sam Dash

Allie..... Kayla Ortiz  
 Jordan..... Karen Tineo  
 Scoop ..... Damian Tineo  
 Orlando..... Jose Duran\*

### **THE YOUTH**

Written by Sathya Sridharan and directed by Marchánt Davis

Sara ..... Jayda Camacho  
 Gabe..... Justin Bannister  
 Daryl ..... Bamba Thiam

## **INTERMISSION**

### **THE DISRUPTION**

Written by Chisa Hutchinson and directed by Mikhaela Mahony

Julia ..... Jade Cuevas  
 Leaf..... Lambert Havard-Whitney  
 Gabby..... Tinish Powell  
 Mr. Garcia ..... Bryan Lopez  
 Students ..... Gus Reale, Vanessa Porras

### **DEAR DAVID**

Written by Christopher Moncayo-Torres and directed by Rachel Pickup

Jay ..... Sofia Santoni  
 Freddy ..... Chyanne Peña  
 Michael ..... Joshua Gomez

### **GRADUATION DAY**

Written by Melisa Tien (with a little help from the actors)  
and directed by Ciana Proto

Kendra ..... Kayla Matos  
 Wynne ..... Wilhelmina Ohenekarikari  
 Serena ..... Sabrina Caldon  
 Principal’s voice..... George Babiak\*

*\*Adult volunteer actor*

The 52nd Street Project is a non-profit arts organization that brings children from the Hell's Kitchen neighborhood together with professional artists to create original art.

In Stage Combat, a ruff-n-rowdy group of Project kids and their scrappy adult partners have learned the art of safe, choreographed fighting. Led by Project volunteer Kerry Warren, they've learned to tell stories of high-stakes conflicts through punches, kicks, slaps, and so much more! Each play is centered around a staged fight that they have created with the guidance of their adult partners.

### **The 52nd Street Project Staff**

Kat Almirañez, Associate Artistic Director

Ahmed Attia, Development Associate\*

George Babiak, Director of Design and Production

Liz Bell, Clinical Consultant

Kali Crandall, Development Director

Caylyn Creager, Education Assistant

Brian Freeland, Production Manager

Natalie Hirsch, Artistic Director

Garrett Kim, Program Director

Carol Ochs, Executive Director

Gus Rogerson, Producing Director

John Sheehy, Director of Institutional Advancement

Johanna Vidal, Director of Education\*

Yazzy Wilder, Office Manager\*

Iris A. Brown, Graphic Design Consultant

*\*Project Alumni*

### **Interns:**

Lella Michelson, Vanessa Porras, Gus Reale, Katie Wee

### **Teen Employees:**

Receptionists: Jasmine Correa, Daniel Martinez, Kayla Matos,

Tinah Powell, Jayleen Velez,

Ushers: Jayleen Velez, Kiara Figueroa, Jasmine Correa

Videographer: Enrique Caballero

### **The 52nd Street Project Board of Directors**

Lisa Benavides

Rachel Chanoff

Cathy Dantchik, co-chair

Carolyn DeSena

Wendy Ettinger, chair emeritus

Louis P. Friedman, co-chair

Alex Gersten-Vassilaros

Robert Goldberg

Stephen Graham, chair emeritus

Natalie Hirsch

Valerie Kay

Frances McDormand

Noël Mihalow

Carol Ochs

Willie Reale, founder

Gus Rogerson

Shirley Rumierk,

alumni member

José Soto, Jr., alumni member

Merritt Tilney

Wendy vanden Heuvel

Mark Whatley

## **THE 52ND STREET PROJECT PRESENTS**



**Friday  
June 15, 2018  
7:30 p.m.**

**The Five Angels Theater  
at  
The 52nd Street Project**

# READY TO RUMBLE

## THE 2018 LORRAINE COHEN STAGE COMBAT SHOW

### LUNCH MASSACRE

Fight choreography by Hannah Leon, with Kendall Cafaro

Starchesha, a unicorn at Fantasy High ..... Hannah Leon

*Fighting Quirk: giggly slapper*

Necessity the Great, a pirate at Fantasy High..... Kendall Cafaro

*Fighting Quirk: when hits with tray, talks nonsense*

### BONUS FEATURES

Fight choreography by Carlos Jimenez, with Cody Wilson

Mr. Money, a businessman and pro fighter..... Carlos Jimenez

*Fighting Quirk: hook punch*

Young C.O.D., a rapper .....Cody Wilson

*Fighting Quirk: spin kick; clumsy*

### A DILAPIDATED RIVAL

Fight choreography by Sevan Asencio, with Alex J. Gould

Jay "Black Heart" Rougeland, a hitman..... Sevan Asencio

*Fighting Quirk: unique fighting style (defenseless, quick reflexes)*

Travis "Headhunter" Gargano, another hitman..... Alex J. Gould

*Fighting Quirk: really great defense, slow reflexes*

### PIZZA OVEN LOVE

Fight choreography by Faith Villanueva, with Annabelle Cousins

Toxicita, a girl who saves people..... Faith Villanueva

*Fighting Quirk: always gets distracted*

Frankie, her sister who steals.....Annabelle Cousins

*Fighting Quirk: uses food to fight*

### A GAME OF GUARDIANS

Fight choreography by Jayla Alvarez, with Sarah Quigley

Rose, a babysitter.....Jayla Alvarez

*Fighting Quirk: knows how to use swords well*

Melanie (a girl has no name), a child..... Sarah Quigley

*Fighting Quirk: has a mean backhand slap*

### THE TWIN BATTLE

Fight choreography by Kailey Caton, with Alicia Moeller

Nicky Rich, a woman who runs a clothing company ..... Kailey Caton

*Fighting Quirk: laughing/grinning while fighting*

Rihana Poor, a fast food restaurant employee ..... Alicia Moeller

*Fighting Quirk: always feeling bad after a move*

### CHEESY TOASTED CAKE

Fight choreography by Jayden Alvarado, with Carlo Albán

Swiss, a piece of cheese ..... Jayden Alvarado

*Fighting Quirk: throws melted cheese*

Toaster, a toaster ..... Carlo Albán

*Fighting Quirk: throws toast*

### MAKE-UP MASSACRE

Fight choreography by Love Jones, with Molly Carden

Lord, a model..... Love Jones

*Fighting Quirk: quick with the hands*

Lu, her sister.....Molly Carden

*Fighting Quirk: uses some "gadget"*

### THE PRODUCTION TEAM

Fight Director and Instructor ..... Kerry Warren

Stage Manager ..... Jenni Swan

Lighting Designer..... Ry Burke

Sound Design ..... Garrett Kim and Vanessa Porras

Props ..... George Babiak

Stage Crew..... Lella Michelson, Jayla Alvarez, Sevan Asencio



The Stage Combat Program is made possible with public funds from The New York State Council on the Arts, a state agency, and the New York City Department of Cultural Affairs. This project is supported in part by an award from the National Endowment for the Arts. The 52nd Street Project is a member of Art/NY and Theatre Communications Group (TCG), the national organization for the American theatre.



The 52nd Street Project gratefully acknowledges the support of the following foundations & corporations: The Altman Foundation; BC Partners; BGC; Benihana/HARU; Bloomberg Philanthropies; The Brenner Family Foundation; Bull's Head Foundation, Inc.; Cantor Fitzgerald; Carnegie Corporation of New York; Maxine and Irving Castle Foundation; CBS Foundation, Inc.; The CLAWS Foundation; Comedy Central; Consolidated Edison; Dawkins Family Foundation; Dramatists Play Service, Inc.; Eleanor, Adam & Mel Dubin Foundation; Eileen Fisher, Inc.; Flexis Capital, LLC; Pamela and Wayne Garrison Family Foundation; The Horace W. Goldsmith Foundation; The Stephen P. Hanson Foundation; Heisman Trophy Trust; Hudson Scenic Studio; Lambert Family Foundation; Lemle Pictures, Inc.; Frederick Loewe Foundation; LRS Designs, Inc.; MTI; Newman's Own; The Stavros Niarchos Foundation; Ninth Avenue Association; Par Plumbing Co., Inc.; Sawyer | Berson Architecture & Landscape Architecture; The Morris and Alma Schapiro Fund; Schuss Realty Associates, LLC; The Shubert Organization; The Harold & Mimi Steinberg Charitable Trust; Sterling Foundation; Susquehanna Foundation; Tax Pro Financial Network, Inc.; Tiger Baron Foundation; TZP Group LLC; John A. Vassilaros & Sons, Inc.; Yorke Construction Corp.; Zubatkin Owner Representation, LLC. We also acknowledge the following individual donors to The 52nd Street Project:

Beth & Ray Abbott	Carolyn DeSena	Alan Howard	Courtney & Lowell Pettit
Robert Abrams & Cynthia Vance	Jordan Dickenstein	Linda LeRoy Janklow	Alice Phillips Swistel
George & Pam Ackert	Alan & Marion Dienstag	Andrea Johnson	& Daniel G. Swistel
Allison & Michael Anderson	Adam & Rebecca Dixon	Melissa Jones Briggs	Michael Popper
Richard Anthony & Avi Taussig	Aurora & Daniel Donofrio	Laura Jones	Elizabeth & Ryan Porter
Becky & Dylan Baker	Billy & Ellen Dreskin	Robert Joy & Henry Krieger	Sue Poulin
Eliza Baldi & David Costabile	Rebecca & Rick Dresser	Douglas M. Kaden	Ivy & Michael Rachlin
Beth Barry & Daniel Sussman	Peter Dufault	& Merritt Tilney	Helen & Peter Randolph
Jessica Bauman & Ben Posel	Laurel Durst	Eric Karpeles & Mike Sell	Willie Reale
Lisa Benavides	Chrysti & David Eigenberg	Elliot & Kim Katz	Armando Riesco
& Tim Blake Nelson	Jeremy Erdreich	Anita Keal & Morton Wolkowitz	& Shirley Rumierk
Judy & Sam Berger	Wendy Ettinger	Beth & Clarke Keough	Annasophia Robb
Stephanie Berger & Paul King	Edie Falco	Alicia Kershaw	Anita Rogerson
Gavin Berger & Craig Berggren	Anton Fig & Laura Sametz	Mary Kong	Daniel Rosen
Elizabeth & Eric Berman	Mark Fisher	Susannah Koteen	Lynne Rosenberg
Adam Bernstein	Katherine Fleming	& Mark Sweeney	Debra & Russell Rosenthal
& Jessica Hecht	Lindsay Fram & Mason Pettit	Joyce Krawiecki	Patricia Rosenthal
Stephen Bernstein	William Frank	Jan Kroeze & Jacki Ochs	David & Laura Ross
Francine Bizar	Karen & Paul Freitas	Ellen Kroll	Meg Rushton
Lewis Black	Gene Friedman	Richard Langan	Jim & Kim Russen
Allison Blinken	Louis & Patrice Friedman	Frances & Fred Langbecker	Lyle Saunders
Jane Bolster & Steve Wertimer	David Froelich & Cynthia Kaplan	Ruth & Sid Lapidus	Karin & Tom Schall
Byron Boston	Sally Froelich	Jené LeBlanc	David Seidman & Laura Valeroso
Buzz Bovshow	Janice Gabrilove	Cindy & Richard Leibovitch	Robert Shwartz
Richard & Samantha Brand	Jeannie & Jim Gaffigan	Adrienne Lobel	Jacqueline Simon
Becky Browder & Ted Neustadt	Pamela & Wayne Garrison	Edie Lutnick	Jeremy Smith
Leah Carr	Freddie & Myrna Gershon	John C. Lynch & Brenda Wehle	Stephen Sondheim
Gil Cass	Cathe Giffuni	Marsue & Peter MacNicol	Tim Stephenson
Chris Ceraso & Carla Meadows	Glen Gillen & Michael Lawrence	Greg MacPherson	& Adriana Trigiani
Lisa Chanel	Emily Giske & Annie Washburn	& Jane Perlmutter	Bob Stockel
Lisa & Matt Chanoff	Robert Goldberg	Bruce MacVittie & Carol Ochs	Abbie Strassler
Rachel Chanoff	Shari Goodstein	Dennis Manalo	David & Patty Straus
Navin & Preeti Choksi	Bruce Graham & Valerie Kay	Frank & Linda Mavronicolas	Jenni Swan
Ellen Chopay	Jill Graham and Jon Klein	Marjorie Mayrock	Richard Sweren
Katie & Kelly Clark	Stephen Graham	Pierce McCormack	Erica & Warren Thaler
Joel Coen	Susannah Gray & John Lyons	& Bruce Whitacre	Judy & Ron Tierney
& Frances McDormand	Melinda Griffith	Josie Merck	Lisa Tilney
Lisa Cohen & David Hillman	Kimberly Grigsby	Joe & Noël Mihalow	Suzanne Tobak
Robert Cohen	Emily Grishman	Drew Milstein	Craig & Madonna Turner
& Danielle Mindess	& Susan Sampliner	Carla & Yohan Minaya	Fred & Sarah Turpin
Ruth Cohen & Bob Usdin	Jan Gura & Alan Pickman	Donald Monti	Jan-Willem van den Dorpel
Sherry Cohen	Warren E. Hannas	Daryl & Michael Moss	Alexandra Vassilaros
Brad Coley	Susan Hanson	Amanda & Neal Moszkowski	Maria Vassilaros
& Wendy vanden Heuvel	Barnaby Harris & Suzie Kondi	Suzen Murakoshi	& William Zucearia
Penny Collins	Karen Hauser & Warren Leight	Randy & Rona Nelson	Mary Pat Walsh
Dan Colussy	Ann & David Hausmann	Ruth Nelson	Sharon Washington
Megan Cramer	Amy Herzig	Evan Newmark & Ellen West	Norbert Weissberg
Billy Crudup	Barbara & Eric Hippeau	Larry & Rachel Norton	David Weller
Michaela Culver	Josie Holtzman	Debra Occhino	Mark & Vicki Whatley
William Curran	& Isaac Kestenbaum	Lori O'Connor	Susan Whitehead
& Patrice Delcasino	Willy Holtzman & Sylvia Shepard	Beth & Bob Ollwerther	Carole Yass
Cathy Dantchik	Katy Homans & Patterson Sims	Kevin O'Rourke & Edith Thurber	Janine & Jeffrey Yass
Leslie Dantchik & Mitch Horowitz	Gary Horowitz & Alan Krevis	F. Richard Pappas	Brett Young-Fountain
Robert Denenberg	Sarah Horowitz & David Venarde	George Petrides	Abby Zeichner

Donor List current as of March, 2018

THE 52ND STREET PROJECT PRESENTS

# GOOD VIBRATIONS

PLAYS WITH SOUND FOUNDATIONS



Fri. July 20 @ 7:30 p.m. \* Sat. July 21 @ 7:30 p.m. \* Sun. July 22 @ 3:00 p.m.

THE FIVE ANGELS THEATER

# GOOD VIBRATIONS: PLAYS WITH SOUND FOUNDATIONS

The Annual Block Island One-on-Ones - July 20-22, 2018 at the Five Angels Theater

## The 52nd Street Project Staff

Kat Almirañez, Associate Artistic Director  
 Ahmed Attia, Development Associate\*  
 George Babiak, Director of Design and Production  
 Liz Bell, Clinical Consultant  
 Kali Crandall, Development Director  
 Caylyn Creager, Education Assistant  
 Brian Freeland, Production Manager  
 Natalie Hirsch, Artistic Director  
 Garrett Kim, Program Director  
 Carol Ochs, Executive Director  
 Gus Rogerson, Producing Director  
 John Sheehy, Director of Institutional Advancement  
 Johanna Vidal, Director of Education\*  
 Yazzy Wilder, Office Manager\*  
 Iris A. Brown, Graphic Design Consultant  
*\*Project Alumni*

### Interns:

Lella Michelson, Vanessa Porras, Gus Reale, Katie Wee

### Teen Employees:

Receptionists: Jasmine Correa, Tiniyah Powell, Jayleen Velez  
 Ushers: Jayla Alvarez, Kiara Figueroa, Matthew Orozco, Wilhelmina Ohene-karikari

## “GOOD VIBRATIONS” Production Staff

### Composer/Music Director

Wes Braver

### Set Designer

Kevin Joseph Roach

### Lighting Designer

Miriam Crowe

### Costume Designer

Paula Cohen

### Sound Designer

Lella Michelson

### Stage Manager

Caylyn Creager

### Projection Designs

George Babiak and The  
 52nd Street Project Projection Archive

### Prop Design and Construction

George Babiak, Gus Reale, and  
 Vanessa Porras

### Backstage Crew

Sevan Asencio, Vanessa Porras,  
 Gus Reale, and Jayleen Velez

### House Management

Carol Ochs, John Sheehy

### Flyer/Program Art

Patrick Jones

### Chefs

Martha Velie-Gass  
 and Pat Ritter

### Teen Counselor

Jayleen Velez

## COOL STUFF ON SALE IN THE LOBBY!

Fabulous Flyer Bars ..... \$2.50  
*and featuring Shel Silverstein’s “Fivey and Twoey” logo:*  
 Two-tone Project Hoodie ..... \$40.00  
 Monotone Project Hoodie ..... \$30.00  
 Crew-neck sweatshirts ..... \$20.00  
 Project Caps ..... \$20.00  
 Project T-shirts ..... \$12.00/\$20.00  
 Project Mugs ..... \$5.00  
 Project Notebook ..... \$5.00  
 Project Pencil 3-pack ..... \$1.00

Thank you for coming to **GOOD VIBRATIONS**. If you are not on our mailing list, you can join on-line at [www.52project.org](http://www.52project.org). If you're interested in being a volunteer, fill out the form below and hand it to one of our staffers in the lobby.

### YES, I AM INTERESTED IN BEING INVOLVED! HERE IS MY CONTACT INFORMATION:

07/18

NAME \_\_\_\_\_

ADDRESS \_\_\_\_\_

CITY \_\_\_\_\_

STATE \_\_\_\_\_

ZIP \_\_\_\_\_

HOME PHONE \_\_\_\_\_

DAYTIME OR MOBILE PHONE \_\_\_\_\_

E-MAIL ADDRESS \_\_\_\_\_

MY OCCUPATION \_\_\_\_\_

MY HOBBIES \_\_\_\_\_

WANT TO BE GREEN AND SAVE THE PROJECT MONEY ON POSTAGE?  
 CHECK THIS BOX TO RECEIVE OUR NOTICES EXCLUSIVELY VIA E-MAIL.

If you would like to mail this (and you're always welcome to enclose a tax-deductible contribution), you can send it to:

**The 52nd Street Project**  
 789 10th Avenue  
 New York, NY 10019.

Or you can fax it to (212) 333-5598.



The One-on-One Program is made possible with public funds from The New York State Council on the Arts, a state agency, and the New York City Department of Cultural Affairs. The 52nd Street Project is a member of Art/NY and Theatre Communications Group (TCG), the national organization for the American theatre.

COME BACK NEXT MONTH FOR...

NATALIE HIRSCH, ARTISTIC DIRECTOR    CAROL OCHS, EXECUTIVE DIRECTOR    GUS ROGERSON, PRODUCING DIRECTOR

THE 52ND STREET PROJECT PRESENTS

# GOOD VIBRATIONS

PLAYS WITH SOUND FOUNDATIONS

THE FLIP SIDE  
THE 2018 GOLD SPRING, PA  
ONE-ON-ONES



10 adult-written plays featuring kids and adults on stage together! Each team play must incorporate a SOUND or MUSIC CUE randomly drawn from the Projects collection

Fri. Aug. 17 @ 7:30 p.m. • Sat. Aug. 18 @ 7:30 p.m. • Sun. Aug. 19 @ 3:00 p.m.

**THE FIVE ANGELS THEATER**  
789 10th Avenue, between 52nd & 53rd Street  
Admission free! Reserve your seats at [www.52project.org](http://www.52project.org)

ARTWORK BY JENNIFER ZONES

## The 52nd Street Project Board of Directors

Lisa Benavides	Valerie Kay
Rachel Chanoff	Noël Mihalow
Cathy Dantchik, co-chair	Carol Ochs
Carolyn DeSena	Willie Reale, founder
Wendy Ettinger, chair emeritus	Gus Rogerson
Louis P. Friedman, co-chair	Shirley Rumierk, alumni member
Alexandra Gersten-Vassilaros	José Soto, Jr., alumni member
Robert Goldberg	Merritt Tilney
Stephen Graham, chair emeritus	Wendy vanden Heuvel
Natalie Hirsch	Mark Whatley

### What's Going On Here?

The 52nd Street Project is a non-profit organization that brings children from the Hell's Kitchen neighborhood together with professional theater artists to create original theater. **GOOD VIBRATIONS** is a production of our One-on-One program, which is designed to give children the opportunity to go away for one-week stays in the country and enjoy the undivided attention of a professional theater artist who serves as friend, mentor, and collaborator.

### In-Kind Contributions

Abbeville Press; Ardesia; Lewis Black; Brooklyn Brewery; Iris A. Brown Design; Cellar 53; Navin Choksi; City Winery; William Curran & A Curran Affair; The Daily Show's Trevor Noah; Jenny Gersten; Haru Restaurant of Hell's Kitchen; ICI; Karen Kowgios of Withum, Smith, & Brown; The Late Show with Stephen Colbert; Charlie Marshal; Noël Mihalow & Prime Films; Lauren Friedman, Pharma/Omni Printing; Winston Rodney Photography; Stephen Sondheim; Jenny Steingart; Merritt Tilney & Doug Kaden; John A. Vassilaros & Sons; The Vassilaros Family; Watkins Inc.; and Paul, Rifkind, Wharton, & Garrison LLP.

### Special Thanks

Our Host Families - Socha Cohen; Cathy Joyce and Nigel Grindley, Katy Homans and Patterson Sims; Susan & Ray Torrey; Gladys and Bill Phillips; Sam & Kate Bird; Josie Merck; Virginia Dare; Susan Hagedorn; and our magnanimous headquarters host Carl Kaufmann. Sincere thanks to our chefs Martha Velie-Gass & Pat Ritter; McQuade's Marketplace; Jené LeBlanc; Susan Paulsen MacGill.



### KEEP AN EYE OUT FOR INTERNS!

If you know of any college or graduate students who might enjoy working with us, playing with us, and going on trips with us for a semester, please have them contact Caylyn Creager at [creager@52project.org](mailto:creager@52project.org).

## GOOD VIBRATIONS: PLAYS WITH SOUND FOUNDATIONS - ACT 1

All original music composed by Wes Braver  
*Good Vibrations Theme Song* lyrics by John Sheehy

### HOW TO SURVIVE

By Michael Walek, Directed by Jenelle Chu for Melanie Correa, age 10  
*From the Sound Collection: "Khachaturian Sabre Dance" by Rimsky-Korsakov*  
Naomi ..... Melanie Correa  
Karen ..... Jenelle Chu  
Lifeguard ..... Jayleen Velez  
*Shark in the Water* lyrics by Michael Walek.

### THE RED BAT

Written and Directed by Kerry Warren for Nikolai Alvarez, age 11  
*From the Sound Collection: "Girls Just Want To Have Fun" by Cindy Lauper*  
Trent ..... Nikolai Alvarez  
Phoebe ..... Kerry Warren  
*Cookie Batter Dough* lyrics by Kerry Warren.

### OUT ON THE NEVERLAND SEA

Written and Directed by John Sheehy for Alex Torres, age 11  
*From the Sound Collection: Creepy creaking*  
Peter Pan ..... Alex Torres  
Captain Hook ..... John Sheehy  
*That's What A Foe Is For* lyrics by John Sheehy.

### HOW OSCAR GAVE CELIA WINGS

By Elizabeth Irwin, Directed by Margaret Odette for Quilvis Medina, age 10  
*From the Sound Collection: "Ride of The Valkyries" by Richard Wagner*  
Oscar ..... Quilvis Medina  
Celia ..... Margaret Odette  
*Something About You* lyrics by Elizabeth Irwin.

### A HARE TOO FAR

Written and Directed by Jose-Maria Aguila for Amari DuBose, age 11  
*From the Sound Collection: Heartbeats*  
Pablo ..... Amari DuBose  
Diego/Dad ..... Jose-Maria Aguila  
Biggest Bunny on the Block ..... KeiLyn Durrel Jones  
Guard ..... George Babiak  
*Keep Your Head Down* lyrics by Jose-Maria Aguila.

## GOOD VIBRATIONS: PLAYS WITH SOUND FOUNDATIONS - ACT 2

### LITTLE KNOWN FACTS

By Willie Reale, Directed by Molly Carden for Nyaliz Aviles, age 11  
*From the Sound Collection: Large gong being struck*  
Unicorn 5 ..... Nyaliz Aviles  
Sky 132 ..... Molly Carden  
*Beautiful Facts* lyrics by Willie Reale.

### ANOTHER SHOT

By Kyle Cameron, Directed by Cody Wilson for Carlos Jiménez, age 12  
*From the Sound Collection: Howling wind*  
Rafael ..... Carlos Jimenez  
Gordon ..... Cody Wilson  
Emmy Announcer ..... Gus Reale  
*Look Closer* lyrics by Kyle Cameron.

### MAGIC SPIES

Written and Directed by Neil D'Astolfo for Ivan Garcia, age 10  
*From the Sound Collection: Bell-tower chimes striking midnight*  
Agent 49 ..... Ivan Garcia  
Agent 67 ..... Neil D'Astolfo  
Moldy Bread ..... Gus Reale  
Giant Cat ..... Vanessa Porras  
Waiter/Dr. Shadowman ..... George Babiak  
*I Got Your Back* lyrics by Neil D'Astolfo.

### WARRIOR SISTERS

By Arielle Goldman, Directed by Leta Renée-Alan for Kassandra Sinchi, age 10  
*From the Sound Collection: One-day old baby crying*  
Athena ..... Kassandra Sinchi  
Maya ..... Leta Reneé-Alan  
Mountain Queen ..... Margaret Odette  
*We Are Sisters* lyrics by Arielle Goldman.

### THE MIS-EDUCATION OF LARRY THE SPARROW

Written and Directed by KeiLyn Durrel Jones for Christian Santoni, age 10  
*From the Sound Collection: Magical electronic flourish*  
Larry the Sparrow ..... Christian Santoni  
Harry the Cat ..... KeiLyn Durrel Jones  
*A Friend In-Deed* lyrics by KeiLyn Durrel Jones.

The 52nd Street Project gratefully acknowledges the support of the following foundations & corporations: The Altman Foundation; BC Partners; BGC; Benihana/HARU; Bloomberg Philanthropies; The Brenner Family Foundation; BTIG; Bull's Head Foundation, Inc.; Canter Family Foundation; Cantor Fitzgerald; Carnegie Corporation of New York; Maxine and Irving Castle Foundation; CBS Foundation, Inc.; The CLAWS Foundation; Consolidated Edison; Dawkins Family Foundation; Dramatists Play Service, Inc.; The Dubin Family Foundation; Flexis Capital, LLC; Pamela and Wayne Garrison Family Foundation; The Horace W. Goldsmith Foundation; The Stephen P. Hanson Foundation; Heisman Trophy Trust; Lambert Family Foundation; Lemle Pictures, Inc.; Frederick Loewe Foundation; MTI; Newman's Own; The Stavros Niarchos Foundation; Ninth Avenue Association; Par Plumbing Co., Inc.; Sawyer | Berson Architecture & Landscape Architecture; The Morris and Alma Schapiro Fund; The Shubert Foundation; The Harold & Mimi Steinberg Charitable Trust; Sterling Foundation; Susquehanna Foundation; Tax Pro Financial Network, Inc.; Tiger Baron Foundation; TZP Group LLC; John A. Vassilaros & Sons, Inc.; Yorke Construction Corp.; Zubatkin Owner Representation, LLC. We also acknowledge the following individual donors to The 52nd Street Project:

Beth & Ray Abbott	Carolyn DeSena	Alan Howard	Courtney & Lowell Pettit
Robert Abrams & Cynthia Vance	Jordan Dickenstein	Linda LeRoy Janklow	Alice Phillips Swistel
George & Pam Ackert	Alan & Marion Dienstag	Andrea Johnson	& Daniel G. Swistel
Allison & Michael Anderson	Adam & Rebecca Dixon	Melissa Jones Briggs	Michael Popper
Richard Anthony & Avi Taussig	Aurora & Daniel Donofrio	Laura Jones	Elizabeth & Ryan Porter
Becky & Dylan Baker	Billy & Ellen Dreskin	Robert Joy & Henry Krieger	Sue Poulin
Eliza Baldi & David Costabile	Rebecca & Rick Dresser	Douglas M. Kaden	Ivy & Michael Rachlin
Beth Barry & Daniel Sussman	Peter Dufault	& Merritt Tilney	Helen & Peter Randolph
Jessica Bauman & Ben Posel	Laurel Durst	Eric Karpeles & Mike Sell	Willie Reale
Lisa Benavides	Chrysti & David Eigenberg	Elliot & Kim Katz	Armando Riesco
& Tim Blake Nelson	Jeremy Erdreich	Anita Keal & Morton Wolkowitz	& Shirley Rumieck
Judy & Sam Berger	Wendy Ettinger	Beth & Clarke Keough	Annasophia Robb
Stephanie Berger & Paul King	Edie Falco	Alicia Kershaw	Anita Rogerson
Gavin Berger & Craig Berggren	Anton Fig & Laura Sametz	Mary Kong	Daniel Rosen
Elizabeth & Eric Berman	Mark Fisher	Susannah Koteen	Lynne Rosenberg
Adam Bernstein	Katherine Fleming	& Mark Sweeney	Debra & Russell Rosenthal
& Jessica Hecht	Lindsay Fram & Mason Pettit	Joyce Krawiecki	Patricia Rosenthal
Stephen Bernstein	William Frank	Jan Kroeze & Jacki Ochs	David & Laura Ross
Francine Bizar	Karen & Paul Freitas	Ellen Kroll	Meg Rushton
Lewis Black	Gene Friedman	Richard Langan	Jim & Kim Russen
Allison Blinken	Louis & Patrice Friedman	Frances & Fred Langbecker	Lyle Saunders
Jane Bolster & Steve Wertimer	David Froelich & Cynthia Kaplan	Ruth & Sid Lapidus	Karin & Tom Schall
Byron Boston	Sally Froelich	Jené LeBlanc	David Seidman & Laura Valeroso
Buzz Bovshow	Janice Gabrilove	Cindy & Richard Leibovitch	Robert Shwartz
Richard & Samantha Brand	Jeannie & Jim Gaffigan	Adrienne Lobel	Jacqueline Simon
Becky Browder & Ted Neustadt	Pamela & Wayne Garrison	Edie Lutnick	Jeremy Smith
Leah Carr	Freddie & Myrna Gershon	John C. Lynch & Brenda Wehle	Stephen Sondheim
Gil Cass	Cathe Giffuni	Marsue & Peter MacNicol	Tim Stephenson
Chris Ceraso & Carla Meadows	Glen Gillen & Michael Lawrence	Greg MacPherson	& Adriana Trigiani
Lisa Chanel	Emily Giske & Annie Washburn	& Jane Perlmutter	Bob Stockel
Lisa & Matt Chanoff	Robert Goldberg	Bruce MacVittie & Carol Ochs	Abbie Strassler
Rachel Chanoff	Shari Goodstein	Dennis Manalo	David & Patty Straus
Navin & Preeti Choksi	Bruce Graham & Valerie Kay	Frank & Linda Mavronicolas	Jenni Swan
Ellen Chopay	Jill Graham and Jon Klein	Marjorie Mayrock	Richard Sweren
Katie & Kelly Clark	Stephen Graham	Pierce McCormack	Erica & Warren Thaler
Joel Coen	Susannah Gray & John Lyons	& Bruce Whitacre	Judy & Ron Tierney
& Frances McDormand	Melinda Griffith	Josie Merck	Lisa Tilney
Lisa Cohen & David Hillman	Kimberly Grigsby	Joe & Noël Mihalow	Suzanne Tobak
Robert Cohen	Emily Grishman	Drew Milstein	Craig & Madonna Turner
& Danielle Mindess	& Susan Sampliner	Carla & Yohan Minaya	Fred & Sarah Turpin
Ruth Cohen & Bob Usdin	Jan Gura & Alan Pickman	Donald Monti	Jan-Willem van den Dorpel
Sherry Cohen	Warren E. Hannas	Daryl & Michael Moss	Alexandra Vassilaros
Brad Coley	Susan Hanson	Amanda & Neal Moszkowski	Maria Vassilaros
& Wendy vanden Heuvel	Barnaby Harris & Suzie Kondi	Suzen Murakoshi	& William Zucearia
Penny Collins	Karen Hauser & Warren Leight	Ruth Nelson	Mary Pat Walsh
Dan Colussy	Ann & David Hausmann	Evan Newmark & Ellen West	Sharon Washington
Megan Cramer	Amy Herzig	Larry & Rachel Norton	Norbert Weissberg
Billy Crudup	Barbara & Eric Hippeau	Debra Occhino	David Weller
Michaela Culver	Josie Holtzman	Lori O'Connor	Mark & Vicki Whatley
William Curran	& Isaac Kestenbaum	Beth & Bob Ollwerther	Susan Whitehead
& Patrice Delcasino	Willy Holtzman & Sylvia Shepard	Kevin O'Rourke & Edith Thurber	Carole Yass
Cathy Dantchik	Katy Homans & Patterson Sims	F. Richard Pappas	Janine & Jeffrey Yass
Leslie Dantchik & Mitch Horowitz	Gary Horowitz & Alan Krevis	George Petrides	Brett Young-Fountain
Robert Denenberg	Sarah Horowitz & David Venarde		Abby Zeichner

Donor List current as of March, 2018

THE 52ND STREET PROJECT PRESENTS

# GOOD VIBRATIONS

PLAYS WITH SOUND FOUNDATIONS

THE 2018  
COLD SPRING, PA.  
ONE-ON-ONES



ARTWORK BY NESTOR JONES

Fri. Aug. 17 @ 7:30 p.m. \* Sat. Aug. 18 @ 7:30 p.m. \* Sun. Aug. 19 @ 3:00 p.m.

FIVE ANGELS THEATER

# GOOD VIBRATIONS: PLAYS WITH SOUND FOUNDATIONS

The Cold Spring One-on-Ones - Aug. 17-19, 2018 at the Five Angels Theater

## The 52nd Street Project Staff

Kat Almirañez, Associate Artistic Director  
Ahmed Attia, Development Associate\*  
George Babiak, Director of Design and Production  
Liz Bell, Clinical Consultant  
Kali Crandall, Development Director  
Caylyn Creager, Education Assistant  
Brian Freeland, outgoing Production Manager  
Natalie Hirsch, Artistic Director  
Garrett Kim, Program Director  
Carol Ochs, Executive Director  
Gus Rogerson, Producing Director  
Sayantee Sahoo, incoming Production Manager  
John Sheehy, Director of Institutional Advancement  
Johanna Vidal, Director of Education\*  
Yazzy Wilder, Office Manager\*  
Iris A. Brown, Graphic Design Consultant  
*\*Project Alumni*

### Interns:

Lella Michelson, Vanessa Porras, Gus Reale, Katie Wee

### Teen Employees:

Receptionists: Jasmine Correa\*, Tiniyah Powell, Jayleen Velez  
Ushers: Sevan Asencio, Stephanie Macias, Matthew Orozco, Karen Tineo

## “GOOD VIBRATIONS” Production Staff

### Composer/Music Director

Avi A. Amon

### Set Designer

Kevin Joseph Roach

### Lighting Designer

Greg MacPherson

### Costume Designer

Siena Zoë Allen

### Sound Designer

Alicia Moeller

### Stage Manager

Caylyn Creager

### Projection Designs

George Babiak, Caylyn Creager, and The  
52nd Street Project Projection Archive

### Prop Design and Construction

George Babiak, Margaret Gleberman,  
Vanessa Porras, Katie Wee

### Backstage Crew

Daniel Martinez\*, Lella Michelson,  
Gus Reale, Katie Wee

### House Management

Carol Ochs, John Sheehy

### Flyer/Program Art

Patrick Jones

### Chefs

John Sheehy, Johanna Vidal,  
Carol Ochs

### Teen Counselor

Daniel Martinez\*

## COOL STUFF ON SALE IN THE LOBBY!

Fabulous Flyer Bars ..... \$2.50  
*and featuring Shel Silverstein's "Fivey and Twoey" logo:*  
Two-tone Project Hoodie ..... \$40.00  
Monotone Project Hoodie ..... \$30.00  
Crew-neck sweatshirts ..... \$20.00  
Project Caps ..... \$20.00  
Project T-shirts ..... \$12.00/\$20.00  
Project Mugs ..... \$5.00  
Project Notebook ..... \$5.00  
Project Pencil 3-pack ..... \$1.00

Thank you for coming to **GOOD VIBRATIONS**. If you are not on our mailing list, you can join on-line at [www.52project.org](http://www.52project.org). If you're interested in being a volunteer, fill out the form below and hand it to one of our staffers in the lobby.

### YES, I AM INTERESTED IN BEING INVOLVED! HERE IS MY CONTACT INFORMATION:

08/18

NAME

ADDRESS

CITY

STATE

ZIP

HOME PHONE

DAYTIME OR MOBILE PHONE

E-MAIL ADDRESS

MY OCCUPATION

MY HOBBIES

WANT TO BE GREEN AND SAVE THE PROJECT MONEY ON POSTAGE?  
CHECK THIS BOX TO RECEIVE OUR NOTICES EXCLUSIVELY VIA E-MAIL.

If you would like to mail this (and you're always welcome to enclose a tax-deductible contribution), you can send it to:

**The 52nd Street Project**  
789 10th Avenue  
New York, NY 10019.

Or you can fax it to (212) 333-5598.



The One-on-One Program is made possible with public funds from The New York State Council on the Arts, a state agency, and the New York City Department of Cultural Affairs. The 52nd Street Project is a member of Art/NY and Theatre Communications Group (TCG), the national organization for the American theatre.

## COMING UP AT THE PROJECT...



### PROJECT EXCHANGE: WIN PLAYMAKING

**A Special Show  
at a Special Time**

**TUESDAY,  
AUGUST 21, 6PM**

A staged reading of our latest program. Over the past month, The 52nd Street Project has been running its third Playmaking program with Win, bringing Playmaking to the children in their organization. Come see the results of the kids' work presented in semi-staged readings on Tuesday, August 21, 6 p.m., here at our Five Angels Theater. Admission is free, as always. Reservations can be made at [www.52project.org](http://www.52project.org)



The reverse of the One-on-Ones! Kids write plays for themselves and an adult partner to perform together.

October 19-21 right here at  
**THE FIVE ANGELS THEATER**



### KEEP AN EYE OUT FOR INTERNS!

If you know of any college or graduate students who might enjoy working with us, playing with us, and going on trips with us for a semester, please have them contact Caylyn Creager. We are especially looking for interns for Spring 2019.

### The 52nd Street Project Board of Directors

Lisa Benavides	Valerie Kay
Rachel Chanoff	Noël Mihalow
Cathy Dantchik, co-chair	Carol Ochs
Carolyn DeSena	Willie Reale, founder
Wendy Ettinger, chair emeritus	Gus Rogerson
Louis P. Friedman, co-chair	Shirley Rumierk, alumni member
Alexandra Gersten-Vassilaros	José Soto, Jr., alumni member
Robert Goldberg	Merritt Tilney
Stephen Graham, chair emeritus	Wendy vanden Heuvel
Natalie Hirsch	Mark Whatley

---

### What's Going On Here?

The 52nd Street Project is a non-profit organization that brings children from the Hell's Kitchen neighborhood together with professional theater artists to create original theater. **GOOD VIBRATIONS** is a production of our One-on-One program, which is designed to give children the opportunity to go away for one-week stays in the country and enjoy the undivided attention of a professional theater artist who serves as friend, mentor, and collaborator.

---

### In-Kind Contributions

Abbeville Press; Ardesia; Lewis Black; Brooklyn Brewery; Iris A. Brown Design; Cellar 53; Navin Choksi; City Winery; William Curran & A Curran Affair; The Daily Show's Trevor Noah; Jenny Gersten; Haru Restaurant of Hell's Kitchen; ICI; Karen Kowgios of Withum, Smith, & Brown; The Late Show with Stephen Colbert; Charlie Marshal; Noël Mihalow & Prime Films; Lauren Friedman, Pharma/Omni Printing; Winston Rodney Photography; Stephen Sondheim; Jenny Steingart; Merritt Tilney & Doug Kaden; John A. Vassilaros & Sons; The Vassilaros Family; Watkins Inc.; and Paul, Rifkind, Wharton, & Garrison LLP.

---

### Special Thanks

Our Host Families - Katy Homans and Patterson Sims; Roberta & Vincent Conroy; RYANNE & Jim Jennings; Jim & Pat Sanders; Bob & Peggy Simons; Dylan & Becky Baker; Andrea & Chuck Heyn; Tina Ruyter; Andrea & Tom Webber and our magnanimous headquarters host Deborah and David Pursch. Sincere thanks to Martha Sader; Linda & Bill Halvorsen, Linda & Bill Cobb and Marcia Dunsmore.

## GOOD VIBRATIONS: PLAYS WITH SOUND FOUNDATIONS - ACT 1

All original music composed by Avi A. Amon  
*Good Vibrations Theme Song II* lyrics by John Sheehy

### COCK-A-DOODLE-DON'T

Written by Dylan Dawson, Directed by Daiva Deupree for Sarah Lopez, age 11  
*From the Sound Collection: Rooster crowing*

Bobby Jo..... Sarah Lopez  
Henrietta..... Daiva Deupree  
Brock Darvish..... Gus Reale  
Rooster..... John Sheehy

*Morning Person, Morning Person (Night Person Remix)* lyrics by Dylan Dawson.

### I HATE TOM BRADY

Written and Directed by Grant Harrison for Aengus O'Donnell, age 12  
*From the Sound Collection: Car skidding and crashing*

Chef..... Aengus O'Donnell  
Matt Ryan..... Grant Harrison  
Tom Brady..... George Babiak

*Where Did Our Hatred Go?* lyrics by Grant Harrison.

### THE WILD, WILD SEA

Written by Tim J. Lord, Directed by Emma Ramos for Kylee Chester, age 10  
*From the Sound Collection: "Born to Be Wild" by Steppenwolf*

Celia..... Kylee Chester  
Rebecca Droomcast..... Emma Ramos  
Fishes..... Daniel Martinez & Lella Michelson

*Conflict Song* lyrics by Tim J. Lord.

### THE KIDDLEY DIVEY TWO (WOULDN'T YOU?)

Written and Directed by Michael Propster for Walter Olivares, Jr., age 11  
*From the Sound Collection: "Macho Man" by The Village People*

Detective Tavares..... Walter Olivares, Jr.  
Detective Gibbs..... Michael Propster  
Chief Chicken..... John Sheehy  
Mayor Mare..... Katie Wee

*The Bogus Funky Boogie Woogie Blues, A Disco Sensation* lyrics by Michael Propster.

### THE RETURN OF AGENT MARKS VS. TURKEY VULTURE

Written by Jed Clarke, Directed by Annabelle Cousins for Amirah Hancock, age 11  
*From the Sound Collection: "Berlin Foot Chase" (from The Bourne Supremacy)*

Agent Lydia "Stingray" Marks..... Amirah Hancock  
Turkey Vulture..... Annabelle Cousins  
The Governor..... Annabelle Cousins

*See Me Chopper* lyrics by Jed Clarke.

## GOOD VIBRATIONS: PLAYS WITH SOUND FOUNDATIONS - ACT 2

### IT'S A LIVING

Written and Directed by George Babiak for Yousef Altareb, age 11  
*From the Sound Collection: Splash*

Everett Mackenzie..... Yousef Altareb  
Baxter Rutherford..... George Babiak  
J. Wellington Piccadilly..... John Sheehy  
O'Shaughnessy / Petrocelli..... Kat Almirañez

*Shuddup* lyrics by George Babiak.

### LAST PLANE TO CLEVELAND

Written by Cynthia Kaplan, Directed by Marinda Anderson for Gianna Hires, age 10  
*From the Sound Collection: Dog barking*

Barb..... Gianna Hires  
Midge..... Marinda Anderson  
Passenger/Announcer..... Katie Wee  
Elderly Lady..... Lella Michelson  
Steward/Dog..... Daniel Martinez

*If We Want To Be In Cleveland by Tomorrow* lyrics by Cynthia Kaplan.

### THREE LITTLE PIGS

Written and Directed by Marchánt Davis for Xavier Espinal, age 11  
*From the Sound Collection: "On The Road Again" by Willie Nelson*

Elo..... Xavier Espinal  
Jiggamabob..... Marchánt Davis  
Mark the Pig..... John Sheehy  
Tony and Jane, Pigs..... Daniel Martinez & Lella Michelson

*Miss You* lyrics by Marchánt Davis.

### THE TURTLE [BUNNY] AND THE [BALL OF] HAIR

Written by Gracie Gardner, Directed by Ashley Marie Ortiz for Lanai Blake-Soden, age 9  
*From the Sound Collection: Seagulls and waves*

The Turtle Bunny..... Lanai Blake-Soden  
The Ball of Hair..... Ashley Marie Ortiz

*Disagreement on the Beach* lyrics by Gracie Gardner.

### TWINDEPENDENCE

Written and Directed by Garrett David Kim for Daniel Henk, age 11  
*From the Sound Collection: "Gonna Make You Sweat (Everybody Dance Now)" by C+C Music Factory*

Wilson..... Daniel Henk  
Wallace..... Garrett David Kim  
Wexley..... Daniel Martinez  
Factory Person..... Lella Michelson  
Yolanda/Mayor Mumbles/Announcer..... Katie Wee

*The Twinpiration Song* lyrics by Garrett David Kim.



### **The 52nd Street Project Staff**

Kat Almirañez, Associate Artistic Director  
Ahmed Attia, Development Associate\*  
George Babiak, Director of Design and Production  
Liz Bell, Clinical Consultant  
Kali Crandall, Development Director  
Caylyn Creager, Education Assistant  
Brian Freeland, outgoing Production Manager  
Natalie Hirsch, Artistic Director  
Garrett Kim, Program Director  
Carol Ochs, Executive Director  
Gus Rogerson, Producing Director  
Sayantee Sahoo, incoming Production Manager  
John Sheehy, Director of Institutional Advancement  
Johanna Vidal, Director of Education\*  
Yazzy Wilder, Office Manager\*  
Iris A. Brown, Graphic Design Consultant  
*\*Project Alumni*

### **Interns:**

Lella Michelson, Vanessa Porras, Gus Reale, Katie Wee

### **Teen Employees:**

Receptionists: Jasmine Correa\*, Tinish Powell, Jayleen Velez  
Ushers: Stephanie Macias, Kayla Matos, Karen Tineo

### **The 52nd Street Project Board of Directors**

Lisa Benavides	Valerie Kay
Rachel Chanoff	Noël Mihalow
Cathy Dantchik, co-chair	Carol Ochs
Carolyn DeSena	Willie Reale, founder
Wendy Ettinger, chair emeritus	Gus Rogerson
Louis P. Friedman, co-chair	Shirley Rumierk, alumni member
Alexandra Gersten-Vassilaros	José Soto, Jr., alumni member
Robert Goldberg	Merritt Tilney
Stephen Graham, chair emeritus	Wendy vanden Heuvel
Natalie Hirsch	Mark Whatley

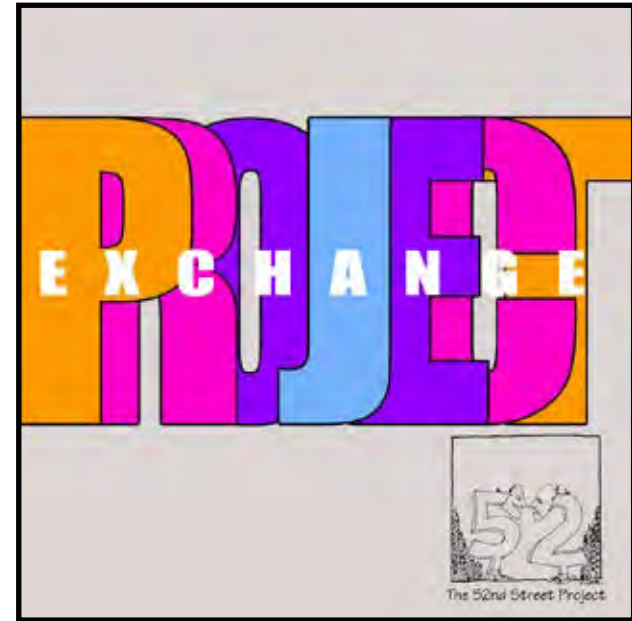

# **THE 52ND STREET PROJECT EXCHANGE: WIN PLAYMAKING SHOW SUMMER 2018**

**TUESDAY, AUGUST 21**

**6:00 PM**

**THE FIVE ANGELS THEATER  
789 10th Avenue**



The 52nd Street Project (aka, The Project) is a non-profit arts organization that brings children from the Hell's Kitchen neighborhood together with professional artists to create original art.

Project Exchange is a recent initiative of The 52nd Street Project. With the help of artists and partner service organizations, Project Exchange reaches out beyond Hell's Kitchen to communities across New York. As it grows, we aim to bring Playmaking and other Project programs to kids living in different pockets of the city. The plays you will see tonight are the fruit of this summer's Playmaking Class with Win. We hope you enjoy our presentation.

### THE PROJECT EXCHANGE TEAM

Playmaking Director ..... Joanna Gurin
Playmaking Associate ..... Jimmy Kenna
Teen Associate ..... Tintah Powell
Lighting Designer..... Sayantee Sahoo
Sound Designer..... Alicia Moeller
Costumes ..... Katie Wee
Stage Manager..... Lella Michelson
Prop Master..... George Babiak

### Special Thanks to...

Rosa Boone, Jesse Gamoran, Eliza Huberth,
Tamara Ortiz, Cynthia Snyder, Katie Tynes



Project Exchange is made possible with public funds from The New York State Council on the Arts, a state agency, and the New York City Department of Cultural Affairs. The 52nd Street Project is a member of Art/NY and Theatre Communications Group (TCG), the national organization for the American theatre.

# THE 52ND STREET PROJECT EXCHANGE: WIN PLAYMAKING SUMMER 2018

## Willy and Jessie

by Genesis, age 12. Directed by John Sheehy

Willy..... Motell Foster
Jessie ..... MaYaa Boateng
Max..... Ato Blankson-Wood

★★★

## The Adventures of Mr. Brain and Miss Rubber Pencil

by Daniel, age 12. Directed by Jessica O'Hara-Baker

Mr. Brain ..... Sathya Sridharan
Miss Rubber Pencil..... Arielle Goldman

★★★

## The Problem

by Giftyd, age 8. Directed by Kerry Warren

Clampy the Cloud ..... Micah Stock
Pizza Steve..... Ben Mehl
Bob and Blob ..... Jimmy Kenna
Human ..... Cody Wilson

★★★

## Rock in Rolling

by Ismael, age 8. Directed by Omar Metwally

Alan ..... Billy Crudup
Brian ..... Raúl Castillo

★★★

## A Very Happy Birthday

by Charlee, age 10. Directed by Michael Propster

Cloe ..... Rosa Gilmore
Madilynn ..... Molly Carden
Dad/Victor/Oldest Cousin ..... Cody Wilson

★★★

## What Goes Around Comes Around

by Intel, age 12. Directed by Morgan McGuire

Cory the Umbrella..... Ronald Peet
Panther the Dog ..... Ashley Marie Ortiz
Rich Random Umbrella ..... Ato Blankson-Wood
Newscaster/Computer ..... Morgan McGuire

The 52nd Street Project gratefully acknowledges the support of the following foundations & corporations: The Altman Foundation; BC Partners; BGC; Benihana/HARU; Bloomberg Philanthropies; The Brenner Family Foundation; BTIG; Bull's Head Foundation, Inc.; Canter Family Foundation; Cantor Fitzgerald; Carnegie Corporation of New York; Maxine and Irving Castle Foundation; CBS Foundation, Inc.; The CLAWS Foundation; Consolidated Edison; Dawkins Family Foundation; Dramatists Play Service, Inc.; The Dubin Family Foundation; Flexis Capital, LLC; Pamela and Wayne Garrison Family Foundation; The Horace W. Goldsmith Foundation; The Stephen P. Hanson Foundation; Heisman Trophy Trust; Lambert Family Foundation; Lemle Pictures, Inc.; Frederick Loewe Foundation; MTI; Newman's Own; The Stavros Niarchos Foundation; Ninth Avenue Association; Par Plumbing Co., Inc.; Sawyer | Berson Architecture & Landscape Architecture; The Morris and Alma Schapiro Fund; The Shubert Foundation; The Harold & Mimi Steinberg Charitable Trust; Sterling Foundation; Susquehanna Foundation; Tax Pro Financial Network, Inc.; Tiger Baron Foundation; TZP Group LLC; John A. Vassilaros & Sons, Inc.; Yorke Construction Corp.; Zubatkin Owner Representation, LLC. We also acknowledge the following individual donors to The 52nd Street Project:

Beth & Ray Abbott	Carolyn DeSena	Alan Howard	Courtney & Lowell Pettit
Robert Abrams & Cynthia Vance	Jordan Dickenstein	Linda LeRoy Janklow	Alice Phillips Swistel
George & Pam Ackert	Alan & Marion Dienstag	Andrea Johnson	& Daniel G. Swistel
Allison & Michael Anderson	Adam & Rebecca Dixon	Melissa Jones Briggs	Michael Popper
Richard Anthony & Avi Taussig	Aurora & Daniel Donofrio	Laura Jones	Elizabeth & Ryan Porter
Becky & Dylan Baker	Billy & Ellen Dreskin	Robert Joy & Henry Krieger	Sue Poulin
Eliza Baldi & David Costabile	Rebecca & Rick Dresser	Douglas M. Kaden	Ivy & Michael Rachlin
Beth Barry & Daniel Sussman	Peter Dufault	& Merritt Tilney	Helen & Peter Randolph
Jessica Bauman & Ben Posel	Laurel Durst	Eric Karpeles & Mike Sell	Willie Reale
Lisa Benavides	Chrysti & David Eigenberg	Elliot & Kim Katz	Armando Riesco
& Tim Blake Nelson	Jeremy Erdreich	Anita Keal & Morton Wolkowitz	& Shirley Rumiark
Judy & Sam Berger	Wendy Ettinger	Beth & Clarke Keough	Annasophia Robb
Stephanie Berger & Paul King	Edie Falco	Alicia Kershaw	Anita Rogerson
Gavin Berger & Craig Berggren	Anton Fig & Laura Sametz	Mary Kong	Daniel Rosen
Elizabeth & Eric Berman	Mark Fisher	Susannah Koteen	Lynne Rosenberg
Adam Bernstein	Katherine Fleming	& Mark Sweeney	Debra & Russell Rosenthal
& Jessica Hecht	Lindsay Fram & Mason Pettit	Joyce Krawiecki	Patricia Rosenthal
Stephen Bernstein	William Frank	Jan Kroeze & Jacki Ochs	David & Laura Ross
Francine Bizar	Karen & Paul Freitas	Ellen Kroll	Meg Rushton
Lewis Black	Gene Friedman	Richard Langan	Jim & Kim Russen
Allison Blinken	Louis & Patrice Friedman	Frances & Fred Langbecker	Lyle Saunders
Jane Bolster & Steve Wertimer	David Froelich & Cynthia Kaplan	Ruth & Sid Lapidus	Karin & Tom Schall
Byron Boston	Sally Froelich	Jené LeBlanc	David Seidman & Laura Valeroso
Buzz Bovshow	Janice Gabrielove	Cindy & Richard Leibovitch	Robert Shwartz
Richard & Samantha Brand	Jeannie & Jim Gaffigan	Adrienne Lobel	Jacqueline Simon
Becky Browder & Ted Neustadt	Pamela & Wayne Garrison	Edie Lutnick	Jeremy Smith
Leah Carr	Freddie & Myrna Gershon	John C. Lynch & Brenda Wehle	Stephen Sondheim
Gil Cass	Cathe Giffuni	Marsue & Peter MacNicol	Tim Stephenson
Chris Ceraso & Carla Meadows	Glen Gillen & Michael Lawrence	Greg MacPherson	& Adriana Trigiani
Lisa Chanel	Emily Giske & Annie Washburn	& Jane Perlmutter	Bob Stockel
Lisa & Matt Chanoff	Robert Goldberg	Bruce MacVittie & Carol Ochs	Abbie Strassler
Rachel Chanoff	Shari Goodstein	Dennis Manalo	David & Patty Straus
Navin & Preeti Choksi	Bruce Graham & Valerie Kay	Frank & Linda Mavronicolas	Jenni Swan
Ellen Chopay	Jill Graham and Jon Klein	Marjorie Mayrock	Richard Sweren
Katie & Kelly Clark	Stephen Graham	Pierce McCormack	Erica & Warren Thaler
Joel Coen	Susannah Gray & John Lyons	& Bruce Whitacre	Judy & Ron Tierney
& Frances McDormand	Melinda Griffith	Josie Merck	Lisa Tilney
Lisa Cohen & David Hillman	Kimberly Grigsby	Joe & Noël Mihalow	Suzanne Tobak
Robert Cohen	Emily Grishman	Drew Milstein	Craig & Madonna Turner
& Danielle Mindess	& Susan Sampliner	Carla & Yohan Minaya	Fred & Sarah Turpin
Ruth Cohen & Bob Usdin	Jan Gura & Alan Pickman	Donald Monti	Jan-Willem van den Dorpel
Sherry Cohen	Warren E. Hannas	Daryl & Michael Moss	Alexandra Vassilaros
Brad Coley	Susan Hanson	Amanda & Neal Moszkowski	Maria Vassilaros
& Wendy vanden Heuvel	Barnaby Harris & Suzie Kondi	Suzen Murakoshi	& William Zucearia
Penny Collins	Karen Hauser & Warren Leight	Randy & Rona Nelson	Mary Pat Walsh
Dan Colussy	Ann & David Hausmann	Ruth Nelson	Sharon Washington
Megan Cramer	Amy Herzig	Evan Newmark & Ellen West	Norbert Weissberg
Billy Crudup	Barbara & Eric Hippeau	Larry & Rachel Norton	David Weller
Michaela Culver	Josie Holtzman	Debra Occhino	Mark & Vicki Whatley
William Curran	& Isaac Kestenbaum	Lori O'Connor	Susan Whitehead
& Patrice Delcasino	Willy Holtzman & Sylvia Shepard	Beth & Bob Ollwerther	Carole Yass
Cathy Dantchik	Katy Homans & Patterson Sims	Kevin O'Rourke & Edith Thurber	Janine & Jeffrey Yass
Leslie Dantchik & Mitch Horowitz	Gary Horowitz & Alan Krevis	F. Richard Pappas	Brett Young-Fountain
Robert Denenberg	Sarah Horowitz & David Venarde	George Petrides	Abby Zeichner

THE 2018  
**PLAYBACK**  
PLAYS

The 52nd Street Project Presents

# STRANGER FLINGS:

Plays about New Holidays

FRIDAY, OCT. 19 AT 7:30 P.M.  
SAT., OCT. 20 AT 7:30 P.M.  
SUN., OCT. 21 AT 3.00 P.M.

**THE FIVE ANGELS THEATER**

ARTWORK BY HEATHER GOSSETT

## STRANGER FLINGS: PLAYS ABOUT NEW HOLIDAYS

The Annual Playback Shows - Oct. 19-21, 2018 at the Five Angels Theater

### The 52nd Street Project Staff

Kat Almirañez, Associate Artistic Director  
Ahmed Attia, Development Associate\*  
George Babiak, Director of Design and Production  
Liz Bell, Clinical Consultant  
Jasmine Correa, Office Manager\*  
Kali Crandall, Development Director  
Caylyn Creager, Education Associate  
Natalie Hirsch, Artistic Director  
Garrett Kim, Program Director  
Carol Ochs, Executive Director  
Gus Rogerson, Producing Director  
Sayantee Sahoo, Production Manager  
John Sheehy, Director of Institutional Advancement  
Johanna Vidal, Director of Education\*  
Yazzy Wilder, Community Coordinator\*  
Iris A. Brown, Graphic Design Consultant  
*\*Project Alumni*

#### Intern:

Isabella Malfi

#### Teen Employees:

Receptionists: Kayla Matos, Tiniyah Powell, Jayleen Velez  
Ushers: Jayla Alvarez, Kai Ceniza, Sasha Davis, Matthew Orozco, Bamba Thiam

### “STRANGER FLINGS” Production Staff

#### Composer/Music Director

Stephen Stocking

#### Set Designer

Kevin Joseph Roach

#### Lighting Designer

Greg MacPherson

#### Costume Designer

Lara de Bruijn

#### Sound Designer

Sayantee Sahoo

#### Stage Manager

Margaret Gleberman

#### Projection Designs

George Babiak, Caylyn Creager, and The  
52nd Street Project Projection Archive

#### Prop Design and Construction

George Babiak, Caylyn Creager

#### Backstage Crew

Sevan Asencio, Isabella Malfi,  
Chyanne Peña,

#### House Management

Carol Ochs, John Sheehy

#### Flyer/Program Art

Heather Gobbée

#### Chefs

John Sheehy and Anne Troup

#### Teen Counselors

Chyanne Peña and Karen Tineo

## COOL STUFF ON SALE IN THE LOBBY!

Fabulous Flyer Bars ..... \$2.50  
*and featuring Shel Silverstein's "Fivey and Twoey" logo:*  
Two-tone Project Hoodie ..... \$40.00  
Monotone Project Hoodie ..... \$30.00  
Crew-neck sweatshirts ..... \$20.00  
Project Caps ..... \$20.00  
Project T-shirts ..... \$12.00/\$20.00  
Project Mugs ..... \$5.00  
Project Notebook ..... \$5.00  
Project Pencil 3-pack ..... \$1.00

Thank you for coming to **STRANGER FLINGS**. If you are not on our mailing list, you can join on-line at [www.52project.org](http://www.52project.org). If you're interested in being a volunteer, fill out the form below and hand it to one of our staffers in the lobby.

### YES, I AM INTERESTED IN BEING INVOLVED! HERE IS MY CONTACT INFORMATION:

10/18

NAME

ADDRESS

CITY

STATE

ZIP

HOME PHONE

DAYTIME OR MOBILE PHONE

E-MAIL ADDRESS

MY OCCUPATION

MY HOBBIES

WANT TO BE GREEN AND SAVE THE PROJECT MONEY ON POSTAGE?  
CHECK THIS BOX TO RECEIVE OUR NOTICES EXCLUSIVELY VIA E-MAIL.

If you would like to mail this (and you're always welcome to enclose a tax-deductible contribution), you can send it to:

The 52nd Street Project  
789 10th Avenue  
New York, NY 10019.

Or you can fax it to (212) 333-5598.



The Playback Program is made possible with public funds from The New York State Council on the Arts, a state agency, and the New York City Department of Cultural Affairs. The 52nd Street Project is a member of Art/NY and Theatre Communications Group (TCG), the national organization for the American theatre.

## COMING UP SOON AT THE PROJECT!



## The 52nd Street Project Board of Directors

Lisa Benavides	Noël Mihalow
Rachel Chanoff	Roseline Michael Neveling
Cathy Dantchik, co-chair	Carol Ochs
Carolyn DeSena	Willie Reale, founder
Wendy Ettinger, chair emeritus	Gus Rogerson
Louis P. Friedman, co-chair	Shirley Rumierk, alumni member
Alexandra Gersten-Vassilaros	José Soto, Jr., alumni member
Robert Goldberg	Merritt Tilney
Stephen Graham, chair emeritus	Wendy vanden Heuvel
Natalie Hirsch	Mark Whatley
Valerie Kay	

## What's Going On Here?

The 52nd Street Project is a non-profit organization that brings children from the Hell's Kitchen neighborhood together with professional theater artists to create original theater. *STRANGER FLINGS* is a production of our Playback program, in which kid actor/playwrights write plays for themselves and adult actor/director partners. Everyone ventured to the Hamptons for a rehearsal retreat over the Columbus Day weekend. All of the kids involved are veterans of the Playmaking classes which were adapted for the Project by Daniel Judah Sklar from his book *Playmaking: Children Writing and Performing Their Own Plays*.

## In-Kind Contributions

Abbeville Press; Ardesia; Lewis Black; Brooklyn Brewery; Iris A. Brown Design; Cellar 53; Navin Choksi; City Winery; William Curran & A Curran Affair; The Daily Show's Trevor Noah; Jenny Gersten; Haru Restaurant of Hell's Kitchen; ICI; Karen Kowgios of Withum, Smith, & Brown; The Late Show with Stephen Colbert; Charlie Marshal; Noël Mihalow & Prime Films; Lauren Friedman, Pharma/Omni Printing; Winston Rodney Photography; Stephen Sondheim; Jenny Steingart; Merritt Tilney & Doug Kaden; John A. Vassilaros & Sons; The Vassilaros Family; Watkins Inc.; and Paul, Rifkind, Wharton, & Garrison LLP.

## Special Thanks

We're extremely grateful to board member Alex Gersten-Vassilaros for allowing us to use her home as our headquarters on our rehearsal trip to the Hamptons. Huge thanks also go to Board Co-Chair Louis Friedman and his wife Patrice Friedman for hosting some adults in their exquisite Water Mill cottage, and to Laurie Becker, who hosted our boys and even more adults at her beautiful house in Sag Harbor.

# STRANGER FLINGS - ACT 1

All original music composed by Stephen Stocking.

## THE MICROWAVE BURRITOS TRAGEDY

Written by Thiana Goode, age 13  
Director/Dramaturge: Jody Flader

Emily..... Thiana Goode  
Hannah..... Jody Flader  
*What If I Made a Mistake* lyrics by Thiana Goode

## HARD LIFE OF A TEEN-AGE GAMER

Written by Derek Rey, age 14  
Director/Dramaturge: Kyle Cameron

Jimmy..... Derek Rey  
Billy..... Kyle Cameron  
Laura..... Kat Almirañez  
*Video Game Was Our Life* lyrics by Derek Rey

## MEJOR AMIGA

Written by Yovely Ramirez, age 12  
Director/Dramaturge: Dalia Davi

Taylor..... Dalia Davi  
Jennie..... Yovely Ramirez  
Teacher's Voice..... John Sheehy  
Students..... The Crew  
*Te Extraño Hermana* lyrics by Yovely Ramirez

## NOT IN MY BODY!

Written by Morgan Smalls, age 12  
Director/Dramaturge: Angie Toledo

Giselle, secretly a Tooth Fairy..... Morgan Smalls  
Nikki, Giselle's twin sister..... Angie Toledo  
Head Tooth Fairy/Mom..... Isabella Malfi  
Other Fairy..... Chyanne Peña  
Basketball player..... Sevan Asencio  
*My Body* lyrics by Morgan Smalls



# STRANGER FLINGS - ACT 2

## EVERYTHING ISN'T ALL ABOUT SUNSHINE AND RAINBOWS

Written by Jayden Alvarado, age 12  
Director/Dramaturge: Alex J. Gould

Gingerbread Man..... Jayden Alvarado  
Unicorn..... Alex J. Gould  
Gingerbread Army..... The Crew  
*You're So Selfish* lyrics by Jayden Alvarado

## ONE OF THEM DIES IN THE END

Written by Bryanna Ohene-Karikari, age 14  
Director/Dramaturge: Marielle Young

Minerva..... Bryanna Ohene-Karikari  
Angelique..... Marielle Young  
Announcer..... Chyanne Peña  
Guard..... Sevan Asencio  
*You Won, But Not Really* lyrics by Bryanna Ohene-Karikari

## PARENTS

Written by Gage Simmons, age 13  
Director/Dramaturge: Jeremy Rische

Ares, an 8-legged dog that can fly..... Jeremy Rische  
Adam, a construction worker..... Gage Simmons  
The Emperor..... John Sheehy  
Mom..... Isabella Malfi  
*Nature* lyrics by Gage Simmons



The 52nd Street Project gratefully acknowledges the support of the following foundations & corporations: The Altman Foundation; BC Partners; BGC; Benihana/HARU; Bloomberg Philanthropies; The Brenner Family Foundation; BTIG; Bull's Head Foundation, Inc.; Canter Family Foundation; Cantor Fitzgerald; Carnegie Corporation of New York; Maxine and Irving Castle Foundation; CBS Foundation, Inc.; The CLAWS Foundation; Consolidated Edison; Dawkins Family Foundation; Dramatists Play Service, Inc.; The Dubin Family Foundation; Flexis Capital, LLC; Pamela and Wayne Garrison Family Foundation; The Horace W. Goldsmith Foundation; The Stephen P. Hanson Foundation; Heisman Trophy Trust; Lambert Family Foundation; Lemle Pictures, Inc.; Frederick Loewe Foundation; MTI; Newman's Own; The Stavros Niarchos Foundation; Ninth Avenue Association; Par Plumbing Co., Inc.; Sawyer | Berson Architecture & Landscape Architecture; The Morris and Alma Schapiro Fund; The Shubert Foundation; The Harold & Mimi Steinberg Charitable Trust; Sterling Foundation; Susquehanna Foundation; Tax Pro Financial Network, Inc.; Tiger Baron Foundation; TZP Group LLC; John A. Vassilaros & Sons, Inc.; Yorke Construction Corp.; Zubatkin Owner Representation, LLC. We also acknowledge the following individual donors to The 52nd Street Project:

Beth & Ray Abbott	Edie Falco	Kim & Elliot Katz	Bradley Poster
Brooke Adams	Scott Falzone	Valerie Kay & Bruce Graham	Michael Pressman
Joe Albano	Barbara & Richard Fontaine	Anita Keal	Deborah & David Pursch
Avi & Richard Anthony	Tom Fontana & Sagan Lewis	& Morton Wolkowitz	Ivy & Michael Rachlin
Becky & Dylan Baker	Andrew Fox	William & Stacy Kestin	Willie Reale
Eliza Baldi	Lindsay Fram & Mason Pettit	Toni Kilkeary	Anita Rogerson
& David Costabile	Patrice & Louis Friedman	Mary Kong	Lynne Rosenberg
Jessica Bauman & Ben Posel	Anthony Fritz	Henry Krieger & Robert Joy	Laura & David Ross
Lisa & Steve Becker	Janice Gabrielove	Ellen Kroll	Shirley Rumiork
Lisa Benavides	& Michael Dirzulaitis	Richard Langan	& Armando Riesco
& Tim Blake Nelson	Jeannie & Jim Gaffigan	Anna & Thomas Lawson	Olivia Sabine
Gavin Berger	Lorraine Gardner	Henry Lee	Laura Sametz & Anton Fig
& Craig Berggren	& Daniel Dolgin	Debbie & Stephen Lewin	Lyle Saunders
Judy & Sam Berger	Gary Garelick	Derek Long	Karin & Tom Schall
Tish & Rich Bernstein	Alexandra Garrison	Jane & Greg MacPherson	Tony Shalhoub
Lewis Black	Pamela & Wayne Garrison	Roma Maffia	Joan & John Sheehy
Ana & Richard Blank	Steven Gerber	Peter Manning	Sylvia Shepard
Jane Ira Bloom & Joe Grifasi	Laura Gewirtz & Scott Aaron	& André Bishop	& Willy Holtzman
Buzz Bovshow	Daniel Gingert	Mel Marvin	Jeremy Smith
Samantha & Richard Brand	Michael Girondo	Michael Mastro	Joan & Gavin Solotar
Tom Broecker	Margaret	& Richard Hester	Marilyn & Barry Steiner
Nicole Brown	& Carson Gleberman	Frances McDormand	Bob Stockel
Cathleen & Geoffrey Cantor	Nancy Glickenhau	& Joel Coen	Cydney & Keith Strand
Carl Capotorto	Nicolette Goldfarb	Tara Elwin & Andre Meade	Richard Sweren
Gil Cass	Sara Goodman	Josie Merck	Michael Tarnow
Kathy Chazen & Larry Miller	Stephen Graham	Danielle Mindess	Erica & Warren Thaler
Ellen Chopay	Susannah Gray	& Robert Cohen	Judy & Ron Tierney
Gail Samuel	& John Lyons	Angel & Cassey Morales	Merritt Tilney
& William Christian	Adam Gross	Suzen Murakoshi	& Douglas M. Kaden
Katie & Kelly Clark	Sean Haggerty	Elaine Musselman	Aida Turturro
Marya Cohn	Karen Hauser	Rishi Nangalia	Gregory Tusar
& Tjebbo Penning	& Warren Leight	Randy & Rona Nelson	Roseline & Dennis Neveling
Penny Collins	Annie & David Hausmann	Ruth Nelson	Laura Valeroso
Celia Keenan-Bolger	Amy Herzig	Joseph Nigro	& David Seidman
& John Conlee	Laura Holleman	Rachel & Larry Norton	Cynthia Vance
Megan Cramer	Katy Homans	Margaret & Peter O'Brien	& Robert Abrams
Cathy Dantchik	& Patterson Sims	Lori O'Connor	Wendy vanden Heuvel
Leslie Dantchik	Linda LeRoy Janklow	Carol Ochs	& Brad Coley
& Mitch Horowitz	Paul Johansen	& Bruce MacVittie	Anna & Adam Vella
Carolyn DeSena	Andrea Johnson	Jacki Ochs & Jan Kroeze	Tracy Wan & Carl Creager
Andrew Douglass	Erich Jungwirth	Beth & Bob Ollwerther	Brenda Wehle & John C.
Rebecca & Rick Dresser	Samantha & Alex Kaczmarek	Sarah Palley	Lynch
Peter Dufault	Thomas Kail	& Joseph Robert Kerrey	Ellen West & Evan Newmark
Laurel Durst	Cynthia Kaplan & David	F. Richard Pappas	Vicki & Mark Whately
Chrysti & David Eigenberg	Froelich	Courtney & Lowell Pettit	David Williams
Jeremy Erdreich	Sandra & Jack Kaplan	Elizabeth & Ryan Porter	Carole Yass

List current as of November 29, 2018

THE 52ND STREET PROJECT PRESENTS

# HEAD IN THE CLOUDS

## THE AMBITIOUS PLAYS

THE FALL 2018 PLAYMAKING SHOW

10 PLAYS WRITTEN BY KIDS AND PERFORMED BY ADULT ACTORS

FRIDAY, NOV. 30 AT 7:30 P.M.  
SATURDAY, DEC. 1 AT 3:00 & 7:30 P.M.  
SUNDAY, DEC. 2 AT 3:00 P.M.

### THE FIVE ANGELS THEATER

POSTER DESIGN BY IRIS A. BROWN

# HEAD IN THE CLOUDS: THE AMBITIOUS PLAYS

Fall Playmaking 2018 - Nov. 30-Dec. 2, Five Angels Theater

## The 52nd Street Project Staff

Kat Almirañez, Associate Artistic Director  
 Ahmed Attia, Development Associate\*  
 George Babiak, Director of Design and Production  
 Liz Bell, Clinical Consultant  
 Jasmine Correa, Office Manager\*  
 Kali Crandall, Development Director  
 Caylyn Creager, Education Associate  
 Natalie Hirsch, Artistic Director  
 Garrett Kim, Program Director  
 Carol Ochs, Executive Director  
 Gus Rogerson, Producing Director  
 Sayantee Sahoo, Production Manager  
 John Sheehy, Director of Institutional Advancement  
 Johanna Vidal, Director of Education\*  
 Yazzy Wilder, Business Associate\*  
 Iris A. Brown, Graphic Design Consultant

\*Project Alumni

### Interns:

Isabella Malfi, Rava Raab

### Teen Employees:

Receptionists: Kayla Matos, Tiniyah Powell, Jayleen Velez  
 Ushers: Karen Tineo, Wilhelmina Ohene Kari Kari, Tiniyah Powell, Kai Ceniza & Bamba Thiam

## “HEAD IN THE CLOUDS” Production Staff

### Composer/Music Director

Avi A. Amon

### Costume Designers

Michael Piatkowski  
 & M.E. Guadalupe Rubi

### Set Designer

Kevin Joseph Roach

### Lighting Designer

Scott Bolman

### Sound Designer/Operator

Stephen Galvan/Sayantee Sahoo

### Stage Manager

Caylyn Creager

### Projection Designs

George Babiak and the Project Archive

### Prop Designs

George Babiak

### Backstage Crew

Isabella Malfi, Kayla Matos,  
 Rava Raab, Jayleen Velez

### House Management

Carol Ochs, John Sheehy

### Flyer/Program Art

Iris A. Brown

### Weekend-Away Chefs

Iris A. Brown and Joe White

### Playmaking Assistant

Kayla Matos

### Fight Director

Alex J. Gould

## COOL STUFF ON SALE IN THE LOBBY!

Fabulous Flyer Bars ..... \$2.50  
*and featuring Shel Silverstein's "Fivey and Twoey" logo:*  
 Two-tone Project Hoodie ..... \$40.00  
 Monotone Project Hoodie ..... \$30.00  
 Crew-neck sweatshirts ..... \$20.00  
 Project Caps ..... \$20.00  
 Project T-shirts ..... \$12.00/\$20.00  
 Project Mugs ..... \$5.00  
 Project Notebook ..... \$5.00  
 Project Pencil 3-pack ..... \$1.00

Thank you for coming to **HEAD IN THE CLOUDS** If you are not on our mailing list, you can join on-line at [www.52project.org](http://www.52project.org). If you're interested in being a volunteer, fill out the form below and hand it to one of our staffers in the lobby.

### PLEASE PUT ME ON YOUR LIST:

12/18

NAME \_\_\_\_\_

ADDRESS \_\_\_\_\_

CITY \_\_\_\_\_

STATE \_\_\_\_\_

ZIP \_\_\_\_\_

HOME PHONE \_\_\_\_\_

DAYTIME OR MOBILE PHONE \_\_\_\_\_

E-MAIL ADDRESS \_\_\_\_\_

MY OCCUPATION \_\_\_\_\_

MY HOBBIES \_\_\_\_\_

WANT TO BE GREEN AND SAVE THE PROJECT MONEY ON POSTAGE?  
 CHECK THIS BOX TO RECEIVE OUR NOTICES EXCLUSIVELY VIA E-MAIL.

### YES, I WOULD LIKE TO BE OF HELP. I CAN:

- |   |   |  |
|---|---|--|
| <input type="checkbox"/> Help load in and out for shows | <input type="checkbox"/> Draw and/or paint  | <input type="checkbox"/> Help kids with homework |
| <input type="checkbox"/> Hang lights                    | <input type="checkbox"/> Help with mailings | <input type="checkbox"/> Teach kids a skill      |
| <input type="checkbox"/> Work on a backstage crew       | <input type="checkbox"/> Do office work     | <input type="checkbox"/> Be a chef at an event   |
| <input type="checkbox"/> Do graphic design              | <input type="checkbox"/> Design sound       | <input type="checkbox"/> Design and sew costumes |
| <input type="checkbox"/> Other (please specify) _____   |   |  |

### MY SCHEDULE IS:

- Very flexible. I'm often available during weekdays.  
 Somewhat flexible. I can help on the occasional morning or afternoon during the week.  
 Not very flexible at all, but I've got some free time on evenings and weekends.

If you would like to mail this (and you're always welcome to enclose a tax-deductible contribution), you can send it to: The 52nd Street Project, 789 10th Avenue, New York, NY 10019. Or fax it to (212) 333-5598.



Council on the Arts



The Playmaking Program is made possible with public funds from The New York State Council on the Arts, a state agency, and the New York City Department of Cultural Affairs. The 52nd Street Project is a member of Art/NY and Theatre Communications Group (TCG), the national organization for the American theatre.



## WHAT'S COMING UP?

**52**  
THE 52ND STREET PROJECT PRESENTS  
**AGAINST THE GRAIN!**

**PLAYS THAT FIGHT BACK!**  
**THE 2019 TWO-ON-TWOS**

5 NEW PLAYS  
10 KID ACTORS  
5 ADULT WRITERS  
5 ADULT DIRECTORS

FRI., JAN 25 AT 7:30 P.M.  
SAT., JAN. 26 AT 3:00 AND 7:30 P.M.  
THE FIVE ANGELS THEATER  
789 10TH AVE.

ART BY PATRICK JONES  
ADMISSION FREE! MAKE RESERVATIONS AT [WWW.52PROJECT.ORG](http://WWW.52PROJECT.ORG)

### The 52nd Street Project Board of Directors

Lisa Benavides	Noël Mihalow
Rachel Chanoff	Roseline Michael Neveling
Cathy Dantchik, co-chair	Carol Ochs
Carolyn DeSena	Willie Reale, founder
Wendy Ettinger, chair emeritus	Gus Rogerson
Louis P. Friedman, co-chair	Shirley Rumierk, alumni member
Alexandra Gersten-Vassilaros	José Soto, Jr., alumni member
Robert Goldberg	Merritt Tilney
Stephen Graham, chair emeritus	Wendy vanden Heuvel
Natalie Hirsch	Mark Whatley
Valerie Kay	

### What's Going On Here?

The 52nd Street Project is a non-profit organization that brings children from the Hell's Kitchen neighborhood together with professional theater artists to create original theater. **HEAD IN THE CLOUDS** is a production of our Playmaking program. Young people participate in a nine-week playwriting course taught by Kat Almirañez and adapted for the Project by Daniel Judah Sklar from his book *Playmaking: Children Writing and Performing Their Own Plays*. At the end of the course, each child is matched with two actors and a dramaturg/director who guides him or her through the writing of a play during a weekend retreat in the country (Stone Ridge, New York, for this show). This performance is the end result.

### In-Kind Contributions

Abbeville Press; Ardesia; Lewis Black; Brooklyn Brewery; Iris A. Brown Design; Cellar 53; Navin Choksi; City Winery; William Curran & A Curran Affair; The Daily Show's Trevor Noah; Jenny Gersten; Haru Restaurant of Hell's Kitchen; ICI; Karen Kowgios of Withum, Smith, & Brown; The Late Show with Stephen Colbert; Charlie Marshal; Noël Mihalow & Prime Films; Lauren Friedman, Pharma/Omni Printing; Winston Rodney Photography; Stephen Sondheim; Jenny Steingart; Merritt Tilney & Doug Kaden; John A. Vassilaros & Sons; The Vassilaros Family; Watkins Inc.; and Paul, Rifkind, Wharton, & Garrison LLP.

### Special Thanks

We're extremely thankful to Steve Gorn & Barbara Bash for the use of their beautiful home in Stone Ridge, NY as our base of operations for the writer's retreat weekend. We must also express thanks to Sean Cullen & Tess Hartman, Laura Shaine Cunningham, Deborah Freedman, Charlie & Naomi Miles, Nicole & Paul Quinn, Lisa Decker, Ciana Proto, Andrew Tingle & Sylvia Greiser for housing our adults and kids. Last, but not least, thanks to Iris Brown and Joe White for being our Stone Ridge liaisons and chefs as well as kid hosts!

Gratitude must also be paid to the volunteers who helped out in Playmaking class: Ross Cowan, Sol Crespo, Christy Escobar, Talia Heller, Adaire Kamen, Christopher Moncayo-Torres, Emma Steiger, Kea Trevett, and Nimene Sierra Wureh.

### SUBSCRIBE TO OUR PODCAST!

A monthly online event created by Garrett Kim and your favorite kid/adult team-ups. Go to the podcast section of the iTunes Store and search for "The 52nd Street Project" or "PROJcast."



### BE ON THE LOOKOUT FOR INTERNS!

If you know of any college or graduate students who might enjoy working with us, playing with us, and going on trips with us for a semester, please have them contact Caylyn Creager ([creager@52project.org](mailto:creager@52project.org)). We are currently looking for interns for the Spring and Summer of 2019. Thanks!

# HEAD IN THE CLOUDS - ACT 1

All original music composed by Avi A. Amon

## HACKER'S DEAL

Written by Naseem Abdul-Majeed, age 10

Director/Dramaturge: Marchant Davis. Costume Designer: Michael Piatkowski

Hacker ..... Reynaldo Piniella

Internet, aka Netty ..... Jasmine Batchelor

*New York Love* lyrics by Naseem Abdul-Majeed

## THE CAT THERAPIST AND THE ARTIST

Written by Tiffany Yam, age 10

Director/Dramaturge: Helen Cespedes. Costume Designer: Michael Piatkowski

Clara, an artist ..... Anna Crivelli

Del, her cat ..... Ariel Shafir

Bob and Rob ..... John Sheehy and George Babiak

*Stress* lyrics by Tiffany Yam

## THE WITCH & ONE FELLOW

Written by Marcelle Orozco, age 10

Director/Dramaturge: Kaaron Briscoe. Costume Designer: M.E. Guadalupe Rubi

Witchy ..... Clea Alsip

Jeff ..... Armando Riesco

Catherine ..... Rava Raab

Twins ..... Kayla Matos and Jayleen Velez

Photographer ..... Isabella Malfi

*I'm So Happy* lyrics by Marcelle Orozco

## WOODS

Written by Andrew Moore, age 9

Dramaturge: Christopher Moncayo-Torres. Director: Michael Propster.

Costume Designer: Michael Piatkowski

Oreen, a salamander ..... Gardiner Comfort

Shatow, another salamander ..... Michael Braun

Kids ..... Rava Raab and Kayla Matos

Girl ..... Kat Almirañez

*Madness* lyrics by Andrew Moore

## WILL I GET MY SISTER BACK OR WILL I GET MY REVENGE?

Written by Hanna Brea, age 9

Director/Dramaturge: Eliza Huberth. Costume Designer: Michael Piatkowski

Shiplee ..... Rachel Dratch

Amy Best ..... Mallory Portnoy

Science Teacher ..... John Sheehy

Science student ..... Kayla Matos

Sister ..... Isabella Malfi

*I Wish This Never Happened* lyrics by Hanna Brea



# HEAD IN THE CLOUDS - ACT 2

## NEVER GIVE UP

Written by Frankie Suero Loyola, age 11

Director/Dramaturge: Nolan Doran. Costume Designer: M.E. Guadalupe Rubi

Wonkong ..... Geoffrey Cantor

Naruto ..... Joshua David Robinson

Alien Tsum ..... Alex J. Gould

Siblings and Parents ..... John Sheehy

*Always Trust in One* lyrics by Frankie Suero Loyola

## THE 2 BEST FRIENDS

Written by Kaytie Gil, age 10

Director/Dramaturge: Danaya Esperanza. Costume Designer: Michael Piatkowski

Ronald Justin, a dog-wolf ..... RJ Brown

Lillypad, a cat-wolf ..... Sol Crespo

Dog Catchers ..... George Babiak and Jayleen Velez

R.J.'s Mom ..... Isabella Malfi

*Mermaid's Wish* lyrics by Kaytie Gil

## DARKNESS MEETS KINDNESS

Written by Laila Suero Loyola, age 11

Dramaturge/Director: Kimiye Corwin. Costume Designer: M.E. Guadalupe Rubi

Dept, assistant to Hades ..... Marisa Kennedy

Hades ..... John Sheehy

Poor Soul ..... Rava Raab

Spirit, Guardian of Souls ..... Angelica Toledo

*Kindness is Better Than Darkness* lyrics by Laila Suero Loyola

## MUSIC'S CONTROL

Written by Ethan Cruz, age 10

Director/Dramaturge: John Sheehy. Costume Designer: M.E. Guadalupe Rubi

Jackson/Sythstar ..... Ben Mehl

Jenny/Melody ..... Carolyn Kettig

Cops ..... Jayleen Velez and Kayla Matos

*Sweet and Music's Love* lyrics by Ethan Cruz

## THE MAGICAL NECKLACE

Written by Maria Alcides, age 10

Director/Dramaturge: Monica Trausch. Costume Designer: M.E. Guadalupe Rubi

Peanut, a cat ..... Kate Abbruzzese

Kylie ..... Shay Vawn

Stacey ..... Rava Raab

*My Wish and Learnings* lyrics by Maria Alcides





# SHOW PROGRAMS 2019

The 52nd Street Project gratefully acknowledges the support of the following foundations & corporations: The Altman Foundation; BC Partners; BGC; Benihana/HARU; Bloomberg Philanthropies; The Brenner Family Foundation; BTIG; Bull's Head Foundation, Inc.; Canter Family Foundation; Cantor Fitzgerald; Carnegie Corporation of New York; Maxine and Irving Castle Foundation; CBS Foundation, Inc.; The CLAWS Foundation; Consolidated Edison; Dawkins Family Foundation; Dramatists Play Service, Inc.; The Dubin Family Foundation; Flexis Capital, LLC; Pamela and Wayne Garrison Family Foundation; The Horace W. Goldsmith Foundation; The Stephen P. Hanson Foundation; Heisman Trophy Trust; Lambert Family Foundation; Lemle Pictures, Inc.; Frederick Loewe Foundation; MTI; Newman's Own; The Stavros Niarchos Foundation; Ninth Avenue Association; Par Plumbing Co., Inc.; Sawyer | Berson Architecture & Landscape Architecture; The Morris and Alma Schapiro Fund; The Shubert Foundation; The Harold & Mimi Steinberg Charitable Trust; Sterling Foundation; Susquehanna Foundation; Tax Pro Financial Network, Inc.; Tiger Baron Foundation; T2P Group LLC; John A. Vassilaros & Sons, Inc.; Yorke Construction Corp.; Zubatkin Owner Representation, LLC. We also acknowledge the following individual donors to The 52nd Street Project:

Beth & Ray Abbott	Edie Falco	Kim & Elliot Katz	Bradley Poster
Brooke Adams	Scott Falzone	Valerie Kay & Bruce Graham	Michael Pressman
Joe Albano	Barbara & Richard Fontaine	Anita Keal	Deborah & David Pursch
Avi & Richard Anthony	Tom Fontana & Sagan Lewis	& Morton Wolkowitz	Ivy & Michael Rachlin
Becky & Dylan Baker	Andrew Fox	William & Stacy Kestin	Willie Reale
Eliza Baldi	Lindsay Fram & Mason Pettit	Toni Kilkeary	Anita Rogerson
& David Costabile	Patrice & Louis Friedman	Mary Kong	Lynne Rosenberg
Jessica Bauman & Ben Posel	Anthony Fritz	Henry Krieger & Robert Joy	Laura & David Ross
Lisa & Steve Becker	Janice Gabrilove	Ellen Kroll	Shirley Rumierk
Lisa Benavides	& Michael Dirzulaitis	Richard Langan	& Armando Riesco
& Tim Blake Nelson	Jeannie & Jim Gaffigan	Anna & Thomas Lawson	Olivia Sabine
Gavin Berger	Loraine Gardner	Henry Lee	Laura Sametz & Anton Fig
& Craig Berggren	& Daniel Dolgin	Debbie & Stephen Lewin	Lyle Saunders
Judy & Sam Berger	Gary Garelick	Derek Long	Karin & Tom Schall
Tish & Rich Bernstein	Alexandra Garrison	Jane & Greg MacPherson	Tony Shalhoub
Lewis Black	Pamela & Wayne Garrison	Roma Maffia	Joan & John Sheehy
Ana & Richard Blank	Steven Gerber	Peter Manning	Sylvia Shepard
Jane Ira Bloom & Joe Grifasi	Laura Gewirtz & Scott Aaron	& André Bishop	& Willy Holtzman
Buzz Bovshow	Daniel Gingert	Mel Marvin	Jeremy Smith
Samantha & Richard Brand	Michael Girondo	Michael Mastro	Joan & Gavin Solotar
Tom Broecker	Margaret	& Richard Hester	Marilyn & Barry Steiner
Nicole Brown	& Carson Gleberman	Frances McDormand	Bob Stockel
Cathleen & Geoffrey Cantor	Nancy Glickenhau	& Joel Coen	Cydney & Keith Strand
Carl Capotorto	Nicolette Goldfarb	Tara Elwin & Andre Meade	Richard Sweren
Gil Cass	Sara Goodman	Josie Merck	Michael Tamow
Kathy Chazen & Larry Miller	Stephen Graham	Danielle Mindess	Erica & Warren Thaler
Ellen Chopay	Susannah Gray	& Robert Cohen	Judy & Ron Tierney
Gail Samuel	& John Lyons	Angel & Cassey Morales	Merritt Tilney
& William Christian	Adam Gross	Suzen Murakoshi	& Douglas M. Kaden
Katie & Kelly Clark	Sean Haggerty	Elaine Musselman	Aida Turturro
Marya Cohn	Karen Hauser	Rishi Nangalia	Gregory Tusar
& Tjebbo Penning	& Warren Leight	Randy & Rona Nelson	Roseline & Dennis Neveling
Penny Collins	Annie & David Hausmann	Ruth Nelson	Laura Valeroso
Celia Keenan-Bolger	Amy Herzig	Joseph Nigro	& David Seidman
& John Conlee	Laura Holleman	Rachel & Larry Norton	Cynthia Vance
Megan Cramer	Katy Homans	Margaret & Peter O'Brien	& Robert Abrams
Cathy Dantchik	& Patterson Sims	Lori O'Connor	Wendy vanden Heuvel
Leslie Dantchik	Linda LeRoy Janklow	Carol Ochs	& Brad Coley
& Mitch Horowitz	Paul Johansen	& Bruce MacVittie	Anna & Adam Vella
Carolyn DeSena	Andrea Johnson	Jacki Ochs & Jan Kroeze	Tracy Wan & Carl Creager
Andrew Douglass	Erich Jungwirth	Beth & Bob Ollwerther	Brenda Wehle & John C.
Rebecca & Rick Dresser	Samantha & Alex Kaczmarek	Sarah Palley	Lynch
Peter Dufault	Thomas Kail	& Joseph Robert Kerrey	Ellen West & Evan Newmark
Laurel Durst	Cynthia Kaplan & David	F. Richard Pappas	Vicki & Mark Whatley
Chrysti & David Eigenberg	Froelich	Courtney & Lowell Pettit	David Williams
Jeremy Erdreich	Sandra & Jack Kaplan	Elizabeth & Ryan Porter	Carole Yass

List current as of November 29, 2018

**52**

**THE 52ND STREET PROJECT PRESENTS**

**AGAINST THE GRAIN!**

**PLAYS THAT FIGHT BACK!**

**THE 2019 TWO-ON-TWOS**

**5 NEW PLAYS**

**10 KID ACTORS**

**5 ADULT WRITERS**

**5 ADULT DIRECTORS**

**FRI., JAN 25 AT 7:30 P.M.**

**SAT., JAN. 26 AT 3:00 AND 7:30 P.M.**

**THE FIVE ANGELS THEATER**

# AGAINST THE GRAIN: PLAYS THAT FIGHT BACK

The 2019 2-on-2 Shows - Jan. 25-26, The Five Angels Theater

## The 52nd Street Project Staff

Kat Almirañez, Associate Artistic Director  
 Ahmed Attia, Development Associate\*  
 George Babiak, Director of Design and Production  
 Liz Bell, Clinical Consultant  
 Jasmine Correa, Office Manager\*  
 Kali Crandall, Development Director  
 Caylyn Creager, Education Associate  
 Natalie Hirsch, Artistic Director  
 Garrett Kim, Program Director  
 Carol Ochs, Executive Director  
 Gus Rogerson, Producing Director  
 Sayantee Sahoo, Production Manager  
 John Sheehy, Director of Institutional Advancement  
 Johanna Vidal, Director of Education\*  
 Yazyzy Wilder, Business Associate\*  
 Iris A. Brown, Graphic Design Consultant  
 \*Project Alumni

### Interns:

Marley-Rose Liburd, Jenelle Strong

### Teen Employees:

Receptionists: Kayla Matos, Tiniyah Powell, Jayleen Velez  
 Ushers: Karen Tineo, Wilhelmina Ohene Kari Kari, Tiniyah Powell, Kai Ceniza & Bamba Thiam

## “AGAINST THE GRAIN” Production Staff

### Composer/Music Director

Eric March

### Costume Designers

Carisa Kelly

### Set Designer

Kevin Joseph Roach

### Lighting Designer

Greg MacPherson

### Sound Designer/Operator

Rafe Terrizzi

### Stage Manager

Jenni Swan

### Projection Designs

George Babiak

### Prop Designs

George Babiak

### Backstage Crew

Lydian Blossom, Marley-Rose Liburd,  
 Chyanne Peña, Karen Tineo,

### House Management

Carol Ochs, John Sheehy

### Flyer/Program Art

Patrick Jones

### Weekend-Away Chefs

John Sheehy and Carol Ochs

## COOL STUFF ON SALE IN THE LOBBY!

Fabulous Flyer Bars ..... \$2.50  
*and featuring Shel Silverstein's "Fivey and Twoey" logo:*  
 Two-tone Project Hoodie ..... \$40.00  
 Monotone Project Hoodie ..... \$30.00  
 Crew-neck sweatshirts ..... \$20.00  
 Project Caps ..... \$20.00  
 Project T-shirts ..... \$12.00/\$20.00  
 Project Mugs ..... \$5.00  
 Project Notebook ..... \$5.00  
 Project Pencil 3-pack ..... \$1.00

Thank you for coming to **AGAINST THE GRAIN**. If you are not on our mailing list, you can join on-line at [www.52project.org](http://www.52project.org). If you're interested in being a volunteer, fill out the form below and hand it to one of our staffers in the lobby.

### PLEASE PUT ME ON YOUR LIST:

1/19

NAME \_\_\_\_\_

ADDRESS \_\_\_\_\_

CITY \_\_\_\_\_

STATE \_\_\_\_\_

ZIP \_\_\_\_\_

HOME PHONE \_\_\_\_\_

DAYTIME OR MOBILE PHONE \_\_\_\_\_

E-MAIL ADDRESS \_\_\_\_\_

MY OCCUPATION \_\_\_\_\_

MY HOBBIES \_\_\_\_\_

WANT TO BE GREEN AND SAVE THE PROJECT MONEY ON POSTAGE?  
 CHECK THIS BOX TO RECEIVE OUR NOTICES EXCLUSIVELY VIA E-MAIL.

### YES, I WOULD LIKE TO BE OF HELP. I CAN:

- |   |   |  |
|---|---|--|
| <input type="checkbox"/> Help load in and out for shows | <input type="checkbox"/> Draw and/or paint  | <input type="checkbox"/> Help kids with homework |
| <input type="checkbox"/> Hang lights                    | <input type="checkbox"/> Help with mailings | <input type="checkbox"/> Teach kids a skill      |
| <input type="checkbox"/> Work on a backstage crew       | <input type="checkbox"/> Do office work     | <input type="checkbox"/> Be a chef at an event   |
| <input type="checkbox"/> Do graphic design              | <input type="checkbox"/> Design sound       | <input type="checkbox"/> Design and sew costumes |
| <input type="checkbox"/> Other (please specify) _____   |   |  |

### MY SCHEDULE IS:

- Very flexible. I'm often available during weekdays.  
 Somewhat flexible. I can help on the occasional morning or afternoon during the week.  
 Not very flexible at all, but I've got some free time on evenings and weekends.

If you would like to mail this (and you're always welcome to enclose a tax-deductible contribution), you can send it to: The 52nd Street Project, 789 10th Avenue, New York, NY 10019. Or fax it to (212) 333-5598.



**Council on the Arts**



The Two-on-Two Program is made possible with public funds from The New York State Council on the Arts, a state agency, and the New York City Department of Cultural Affairs. The 52nd Street Project is a member of Art/NY and Theatre Communications Group (TCG), the national organization for the American theatre.

## COMING UP NEXT...

Natalie Hirsch, Artistic Director    Kat Almirañez, Playmaking Director    Carol Ochs, Executive Director  
THE 52ND STREET PROJECT PRESENTS

# OUT OF THE BLUE!

THE  
UNPREDICTABLE  
PLAYS

THE  
SPRING, 2019  
PLAYMAKING  
SHOW



10  
new plays  
written  
by kids and  
performed by  
adult actors

ARTWORK BY IO PEBEL-STAPHAN

ALL PERFORMANCES AT  
THE 52ND STREET PROJECT'S  
**FIVE ANGELS THEATER**

789 10TH AVE.,  
BETWEEN 52ND & 53RD ST

FRIDAY, MAR. 22 @ 7:30 P.M.  
SATURDAY, MAR. 23 @ 3:00 & 7:30 P.M.  
SUNDAY, MAR. 24 @ 3:00 P.M.

ADMISSION FREE, BUT  
RESERVATIONS ARE RECOMMENDED.  
VISIT [WWW.52PROJECT.ORG](http://WWW.52PROJECT.ORG) TO RESERVE.

### The 52nd Street Project Board of Directors

Lisa Benavides	Noël Mihalow
Rachel Chanoff	Roseline Michael Neveling
Cathy Dantchik, co-chair	Carol Ochs
Carolyn DeSena	Willie Reale, founder
Wendy Ettinger, chair emeritus	Gus Rogerson
Louis P. Friedman, co-chair	Shirley Rumierk, alumni member
Alexandra Gersten-Vassilaros	José Soto, Jr., alumni member
Robert Goldberg	Merritt Tilney
Stephen Graham, chair emeritus	Wendy vanden Heuvel
Natalie Hirsch	Mark Whatley
Valerie Kay	

### What's Going On Here?

The 52nd Street Project is a non-profit organization that brings children from the Hell's Kitchen neighborhood together with professional theater artists to create original theater. **AGAINST THE GRAIN** is a production of our Two-on-Two's program, in which an adult playwright crafts a piece for a pair of 52nd Street Project kids to perform. Another adult directs the kids for a month that includes an intensive weekend in Rockland County. Tonight's performance is the final result.

### In-Kind Contributions

Abbeville Press; Ardesia; Lewis Black; Brooklyn Brewery; Iris A. Brown Design; Cellar 53; Navin Choksi; City Winery; William Curran & A Curran Affair; The Daily Show's Trevor Noah; Jenny Gersten; Haru Restaurant of Hell's Kitchen; ICI; Karen Kowgios of Withum, Smith, & Brown; The Late Show with Stephen Colbert; Charlie Marshal; Noël Mihalow & Prime Films; Lauren Friedman, Pharma/Omni Printing; Winston Rodney Photography; Stephen Sondheim; Jenny Steingart; Merritt Tilney & Doug Kaden; John A. Vassilaros & Sons; The Vassilaros Family; Watkins Inc.; and Paul, Rifkind, Wharton, & Garrison LLP.

### Special Thanks

We owe many thanks to Wendy vanden Heuvel & Brian Mertes & Melissa Kievman; Susanna Styron; Polly King & John Paul Newport; and Patricia Kahn, all of whom graciously allowed us to use their homes in the Nyack area for an exhilarating and fun-filled weekend. Thanks also to New City Bowling Lanes for providing a place to knock down lots of pins.



### BE ON THE LOOKOUT FOR INTERNS!

If you know of any college or graduate students who might enjoy working with us, playing with us, and going on trips with us for a semester, please have them contact . We are currently looking for interns for the Summer of 2018. Thanks!

## AGAINST THE GRAIN: PLAYS THAT FIGHT BACK

All original music composed by Eric March.

*Tonight's show will be performed without an intermission.*

### LOCKED OUT

Written by Garrett David Kim  
Directed by Ashley Marie Ortiz

Boy ..... Stevens Velasquez  
Girl ..... Lakshmi DeJesus

*Walkin' in My Shoes* lyrics by Garrett David Kim.

### THE GOAT BAAAA-EAUTY PAGEANT OF 209

Written by Adaire Kamen  
Directed by Arielle Goldman

Coach Annaliese ..... Darby O'Donnell  
Geraldine the Goat ..... Magalis Fabian

*Need to Win* lyrics by Adaire Kamen.

### DARK SIDE

Written by Rachel Bonds  
Directed by Krystel Lucas

Rosalie Nuñez ..... Rosneyri Rosario  
R2 ..... Ginaija Hires

*Trainwreck* lyrics by Rachel Bonds.



## AGAINST THE GRAIN: PLAYS THAT FIGHT BACK

### SURVIVAL OF THE FITTEST

Written by Colleen Werthmann  
Directed by Sathya Sridharan

Dr. Penelope Kitty litter-Blatheron ..... Lauren Amador-Cruz  
Travis Jolt ..... Rodery Rosario

*You're a Jerk* lyrics by Colleen Werthmann

### WHERE IT BELONGS

Written by Charly Evon Simpson  
Directed by Nico Grelli

Indiana Joan ..... Natasha Davis  
Red ..... Ethan Perez

*The Whole Story* lyrics by Charly Evon Simpson

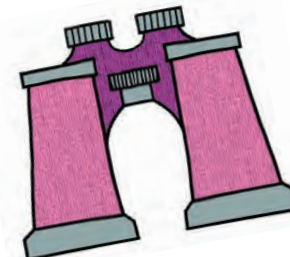

The 52nd Street Project gratefully acknowledges the support of the following foundations & corporations: The Altman Foundation; BC Partners; BGC; Benihana/HARU; Bloomberg Philanthropies; The Brenner Family Foundation; BTIG; Bull's Head Foundation, Inc.; Canter Family Foundation; Cantor Fitzgerald; Carnegie Corporation of New York; Maxine and Irving Castle Foundation; CBS Foundation, Inc.; The CLAWS Foundation; Consolidated Edison; Dawkins Family Foundation; Dramatists Play Service, Inc.; The Dubin Family Foundation; Flexis Capital, LLC; Pamela and Wayne Garrison Family Foundation; The Horace W. Goldsmith Foundation; The Stephen P. Hanson Foundation; Heisman Trophy Trust; Lambert Family Foundation; Lemle Pictures, Inc.; Frederick Loewe Foundation; MTI; Newman's Own; The Stavros Niarchos Foundation; Ninth Avenue Association; Par Plumbing Co., Inc.; Sawyer | Berson Architecture & Landscape Architecture; The Morris and Alma Schapiro Fund; The Shubert Foundation; The Harold & Mimi Steinberg Charitable Trust; Sterling Foundation; Susquehanna Foundation; Tax Pro Financial Network, Inc.; Tiger Baron Foundation; TZP Group LLC; John A. Vassilaros & Sons, Inc.; Yorke Construction Corp.; Zubatkin Owner Representation, LLC. We also acknowledge the following individual donors (over \$250) to The 52nd Street Project:

Beth & Ray Abbott	Andrew Douglass	Paul Johansen	Jacki Ochs & Jan Kroeze
Brooke Adams	Rebecca & Richard Dresser	Andrea Johnson	Beth & Bob Ollwerther
Joe Albano	Laurel Durst	Robert Joy & Henry Krieger	Sarah Palle
Avi Taussig Anthony & Richard Anthony	Michaelene Durst	Erich Jungwirth	& Joseph Robert Kerrey
Lynn Bailey & Zach Grenier	Chrysti & David Eigenberg	Christa Justus & Mark Linn-Baker	F. Richard Pappas
Dylan & Becky Baker	Tara Elwin & Andre Meade	Samantha & Alex Kaczmarek	Courtney & Lowell Pettit
Eliza Baldi & David Costabile	Jeremy Erdreich	Thomas Kail	Elizabeth & Ryan Porter
Beth Barry & Daniel Sussman	Edie Falco	Cynthia Kaplan & David Froelich	Bradley Poster
Jessica Bauman & Ben Posel	Scott Falzone	Kim & Elliot Katz	Sue Poulin
Lisa & Steven Becker	Barbara & Richard Fontaine	Valerie Kay & Bruce Graham	Michael Pressman
Lisa Benavides	Tom Fontana & Sagan Lewis	Anita Keal & Morton Wolkowitz	Randi Puccio
& Tim Blake Nelson	Andrew Fox	Celia Keenan-Bolger	Ivy & Michael Rachlin
Gavin Berger & Craig Berggren	Lindsay Fram & Mason Pettit	& John Conlee	Christopher Randolph
Judy & Sam Berger	Patrice & Louis Friedman	Stacy & William Kestin	Helen & Peter Randolph
Stephanie Berger & Paul King	Anthony Fritz	Toni Kilkeary	Peter Robbins
Elizabeth & Eric Berman	Sally Froelich	Mary Kong	Anita Rogerson
Fredric R. Berner	Janice Gabrielove	Ellen Kroll	Lynne Rosenberg
Tish & Rich Bernstein	& Michael Dirzulaitis	Judy Kuhn & David Schwab	Debra & Russell Rosenthal
Stephen Bernstein	Jim & Jeannie Gaffigan	Richard Langan	Laura & David Ross
André Bishop & Peter Manning	Anne & George Gagen	Frances & Fred Langbecker	Shirley Rumierk & Armando Riesco
Francine Bizar	Beth Gains	Rosina Lardieri & Scott Spector	Olivia Sabine
Lewis Black	Tina Galley	Anna & Thomas Lawson	Laura Sametz & Anton Fig
Ana & Richard Blank	Loraine Gardner & Daniel Dolgin	Jené LeBlanc & Willie Reale	Gail Samuel & William Christian
Allison Blinken	Gary Garelick	Henry Lee	Lyle Saunders
Jane Bolster & Steve Wertimer	Alexandra Garrison	Mickey Lemle	Karin & Tom Schall
Caitlin Bonsiewicz	Pamela & Wayne Garrison	Linda LeRoy Janklow	Tony Shalhoub
Buzz Bovshow	Craig Gartner	Debbie and Stephen Lewin	Sylvia Shepard & Willy Holtzman
Richard & Samantha Brand	Beverly Gasner	Melissa Liebling-Goldberg	Robert Shwartz
Tom Broecker	Steven Gerber	& John Barrett	Jeremy Smith
Becky Browder & Ted Neustadt	Laura Gewirtz & Scott Aaron	Sean Liebowitz	Joan & Gavin Solotar
Nicole Brown	Graeme Gillis	Adrienne Lobel	Marilyn & Barry Steiner
Stephanie Browner	Daniel Gingert	Derek Long	Bob Stockel
& Richard C. Hamlin	Michael Girondo	Betsy MacIsaac & Robert Goldberg	Cydney & Keith Strand
Denise Burse	Nancy Glickenhau	Jane & Greg MacPherson	Jenni Swan
& Peter Jay Fernandez	Marcia Goldberg & Paul Garrity	Roma Maffia	Richard Sweren
Geoffrey & Cathleen Cantor	Nicolette Goldfarb	Pierce McCormack	Michael Tarnow
Carl Capotorto	Sara Goodman	& Bruce Whitacre	Erica & Warren Thaler
Leah Carr	Stephen Graham	Frances McDormand & Joel Coen	Edith Thurber & Kevin O'Rourke
Thomas Carr	Susannah Gray & John Lyons	Josie Merck	Judy & Ron Tierney
Gil Cass	Kimberly Grigsby	Carla & Yohan Minaya	Merritt Tinley & Douglas M. Kaden
Rachel Chanoff	Emily Grishman	Danielle Mindess & Robert Cohen	Aida Turturo
Kathy Chazen & Larry Miller	& Susan Sampliner	Cassey & Angel Morales	Gregory Tusar
Ellen Chopay	Sean Haggerty	Amanda & Neal Moszkowski	Laura Valeroso & David Seidman
Katie & Kelly Clark	Karen Hauser & Warren Leight	Suzen Murakoshi	Cynthia Vance & Robert Abrams
Lisa Cohen & David Hillman	Annie & David Hausmann	Jane Musky & Tony Goldwyn	Wendy vanden Heuvel
Sherry Cohen	Helen Hausmann	Elaine Musselman	& Brad Coley
Penny Collins	Jessica Hecht & Adam Bernstein	Rishi Nangalia	Alexandra Vassilaros
Megan Cramer	Amy Herzig	Rona & Randy Nelson	Anna and Adam Vella
Billy Crudup	Richard Hester & Michael Mastro	Ruth Nelson	Mary Pat Walsh
Cathy Dantchik	Laura Holleman	Roseline Michael Neveling	Tracy Wan & Carl Creager
Leslie Dantchik & Mitch Horowitz	Katy Homans & Patterson Sims	& Dennis Neveling	Sharon Washington
Patrice Delcasino & William Curran	Gary Horowitz & Alan Krevis	Joseph Nigro	Brenda Wehle & John C. Lynch
Carolyn DeSena	Sarah Horowitz & David Venarde	Rachel & Larry Norton	Amanda Weil
Kim & Jordan Dickstein	Charlotte Howard	Margaret & Peter O'Brien	Ellen West & Evan Newmark
Marion Dienstag	Felicity Huffman & William H. Macy	Lori O'Connor	Mark & Vicki Whatley
	Jane Ira Bloom & Joe Grifasi	Carol Ochs & Bruce MacVittie	Carole Yass

# OUT OF THE BLUE!

THE UNPREDICTABLE PLAYS

THE 2019 SPRING PLAYMAKING SHOW



10

NEW PLAYS WRITTEN BY KIDS  
AND PERFORMED BY ADULT ACTORS

FRIDAY, MAR. 22 @ 7:30 P.M.  
SATURDAY, MAR. 23 @ 3:00 & 7:30 P.M.  
SUNDAY, MAR. 24 @ 3:00 P.M.



# OUT OF THE BLUE: THE UNPREDICTABLE PLAYS

The Spring 2019 Playmaking Shows - March 22-24, The Five Angels Theater

## The 52nd Street Project Staff

Kat Almirañez, Associate Artistic Director  
 Ahmed Attia, Development Associate\*  
 George Babiak, Director of Design and Production  
 Liz Bell, Clinical Consultant  
 Jasmine Correa, Office Manager\*  
 Kali Crandall, Development Director  
 Caylyn Creager, Education Associate  
 Natalie Hirsch, Artistic Director  
 Garrett Kim, Program Director  
 Carol Ochs, Executive Director  
 Gus Rogerson, Producing Director  
 Sayantee Sahoo, Production Manager  
 John Sheehy, Director of Institutional Advancement  
 Johanna Vidal, Director of Education\*  
 Iris A. Brown, Graphic Design Consultant

\*Project Alumni

### Interns:

Sylvia Czubarow, Carina Goebelbacker, Rava Raab, Jennell Strong

### Teen Employees:

Receptionists: Kayla Matos, Wilhelmina Ohene Karikari, Tiniyah Powell, Jayleen Velez  
 Playmaking Class Assistant: Jayleen Velez. Playmaking Trip Counselor: Bamba Thiam  
 Concessions: Natasha Davis and Karen Tineo; Ushers: Tiniyah Powell,  
 Sevan Asencio, Rosneyri Rosario

## “OUT OF THE BLUE” Production Staff

### Composer/Music Director

Zonia Tsang

### Costume Designers

John Beltre, M.E. Guadalupe Rubi,  
 Crystal Thompson

### Set Designer

Kevin Joseph Roach

### Lighting Designer

Greg MacPherson

### Sound Designer/Operator

Kaylie Groff

### Stage Manager

Margaret Gleberman

### Projection Designs

George Babiak, Ursula Babiak,  
 Caylyn Creager,  
 Wilhelmina Ohene-Karikari,  
 and the Project Image Archives.

### Prop Creation Team

George Babiak, Caylyn Creager,  
 Carina Goebelbacker, Jennell Strong.

### Backstage Crew

Justin Bannister, Ellen Gallos,  
 Wilhelmina Ohene-Karikari, Rava Raab,  
 Jennell Strong

### House Management

Carol Ochs, John Sheehy

### Flyer/Program Art

Io Perl-Strahan

### Weekend-Away Chefs

John Sheehy and Carol Ochs

### Class Volunteers

Kyle David, Dan Gray, Betsy Hogg,  
 Patrick Jones, Jene LeBlanc,  
 Alexandra Lemus, Rachel Lin,  
 Francisco Mendoza, Alex J. Moreno,  
 James Wade

## COOL STUFF ON SALE IN THE LOBBY!

Fabulous Flyer Bars ..... \$2.50  
*and featuring Shel Silverstein's "Fivey and Twoey" logo:*  
 Two-tone Project Hoodie ..... \$40.00  
 Monotone Project Hoodie ..... \$30.00  
 Crew-neck sweatshirts ..... \$20.00  
 Project Caps ..... \$20.00  
 Project T-shirts ..... \$12.00/\$20.00  
 Project Mugs ..... \$5.00  
 Project Notebook ..... \$5.00  
 Project Pencil 3-pack ..... \$1.00

Thank you for coming to **OUT OF THE BLUE**. If you are not on our mailing list, you can join on-line at [www.52project.org](http://www.52project.org). If you're interested in being a volunteer, fill out the form below and hand it to one of our staffers in the lobby.

### PLEASE PUT ME ON YOUR LIST:

03/19

NAME \_\_\_\_\_

ADDRESS \_\_\_\_\_

CITY \_\_\_\_\_

STATE \_\_\_\_\_

ZIP \_\_\_\_\_

HOME PHONE \_\_\_\_\_

DAYTIME OR MOBILE PHONE \_\_\_\_\_

E-MAIL ADDRESS \_\_\_\_\_

MY OCCUPATION \_\_\_\_\_

MY HOBBIES \_\_\_\_\_

WANT TO BE GREEN AND SAVE THE PROJECT MONEY ON POSTAGE?  
 CHECK THIS BOX TO RECEIVE OUR NOTICES EXCLUSIVELY VIA E-MAIL.

### YES, I WOULD LIKE TO BE OF HELP. I CAN:

- |   |   |  |
|---|---|--|
| <input type="checkbox"/> Help load in and out for shows | <input type="checkbox"/> Draw and/or paint  | <input type="checkbox"/> Help kids with homework |
| <input type="checkbox"/> Hang lights                    | <input type="checkbox"/> Help with mailings | <input type="checkbox"/> Teach kids a skill      |
| <input type="checkbox"/> Work on a backstage crew       | <input type="checkbox"/> Do office work     | <input type="checkbox"/> Be a chef at an event   |
| <input type="checkbox"/> Do graphic design              | <input type="checkbox"/> Design sound       | <input type="checkbox"/> Design and sew costumes |
| <input type="checkbox"/> Other (please specify) _____   |   |  |

### MY SCHEDULE IS:

- Very flexible. I'm often available during weekdays.  
 Somewhat flexible. I can help on the occasional morning or afternoon during the week.  
 Not very flexible at all, but I've got some free time on evenings and weekends.

If you would like to mail this (and you're always welcome to enclose a tax-deductible contribution), you can send it to: The 52nd Street Project, 789 10th Avenue, New York, NY 10019. Or fax it to (212) 333-5598.



The Playmaking Program is made possible with public funds from The New York State Council on the Arts, a state agency, and the New York City Department of Cultural Affairs. The 52nd Street Project is a member of Art/NY and Theatre Communications Group (TCG), the national organization for the American theatre.

## COMING UP AT THE PROJECT...



**SEEING STARS:**  
**THE STAGE COMBAT**  
**PERFORMANCE**

ARTWORK BY JAYDEN ALVARADO

**FRIDAY, MARCH 29 - 7:30 P.M. - ADMISSION FREE!**  
**RIGHT HERE AT THE FIVE ANGELS THEATER**

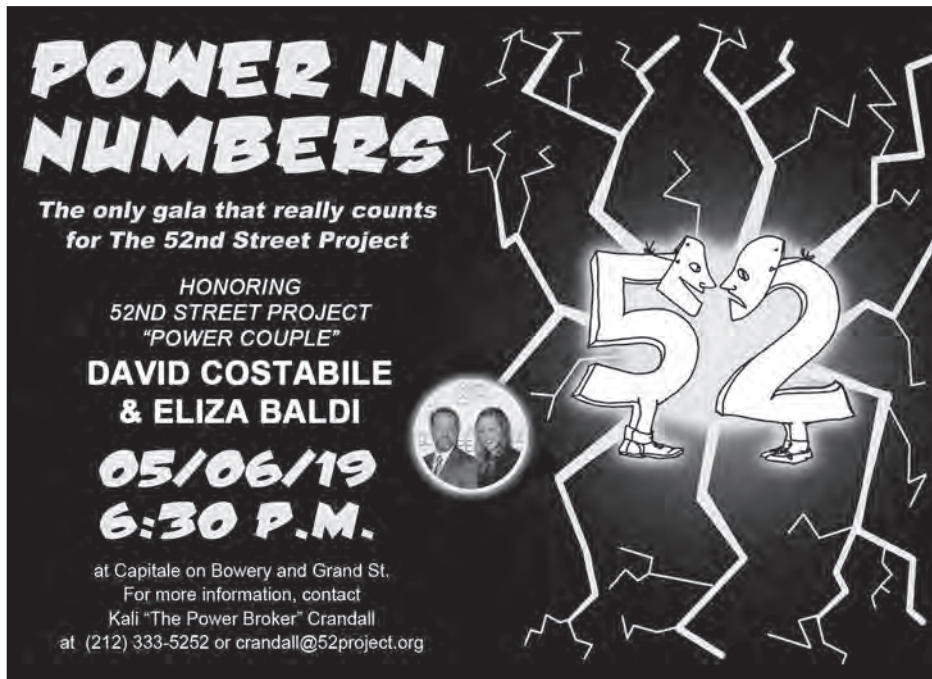

**POWER IN NUMBERS**

*The only gala that really counts  
for The 52nd Street Project*

HONORING  
52ND STREET PROJECT  
"POWER COUPLE"

**DAVID COSTABILE  
& ELIZA BALDI**

**05/06/19  
6:30 P.M.**



at Capitale on Bowery and Grand St.  
For more information, contact  
Kali "The Power Broker" Crandall  
at (212) 333-5252 or crandall@52project.org

### The 52nd Street Project Board of Directors

Lisa Benavides	Valerie Kay
Rachel Chanoff	Noël Mihalow
Cathy Dantchik, co-chair	Roseline Michael Neveling
Carolyn DeSena	Carol Ochs
Wendy Ettinger, chair emeritus	Willie Reale, founder
Louis P. Friedman, co-chair	Gus Rogerson
Alexandra Gersten-Vassilaros	Shirley Rumierk, alumni member
Robert Goldberg	José Soto, Jr., alumni member
Stephen Graham, chair emeritus	Merritt Tilney
Annie Hausmann	Wendy vanden Heuvel
Natalie Hirsch	Mark Whatley

### What's Going On Here?

The 52nd Street Project is a non-profit organization that brings children from the Hell's Kitchen neighborhood together with professional theater artists to create original theater. **OUT OF THE BLUE** is a production of our Playmaking program. Young people participate in a nine-week playwriting course taught by Kat Almirañez and adapted for the Project by Daniel Judah Sklar from his book *Playmaking: Children Writing and Performing Their Own Plays*. At the end of the course, each child is matched with two actors and a dramaturg/director who guides him or her through the writing of a play during a weekend retreat in the country (Bridgehampton, Long Island, for this show). This performance is the end result.

### In-Kind Contributions

Abbeville Press; Ardesia; Lewis Black; Brooklyn Brewery; Iris A. Brown Design; Cellar 53; Navin Choksi; City Winery; William Curran & A Curran Affair; The Daily Show's Trevor Noah; Jenny Gersten; Haru Restaurant of Hell's Kitchen; ICI; Karen Kowgios of Withum, Smith, & Brown; The Late Show with Stephen Colbert; Charlie Marshal; Noël Mihalow & Prime Films; Lauren Friedman, Pharma/Omni Printing; Winston Rodney Photography; Stephen Sondheim; Jenny Steingart; Merritt Tilney & Doug Kaden; John A. Vassilaros & Sons; The Vassilaros Family; Watkins Inc.; and Paul, Rifkind, Wharton, & Garrison LLP.

### Special Thanks

We're extremely grateful to Alexandra Gersten-Vassilaros for the use of her beautiful home in Bridgehampton, NY as our base of operations for the writer's retreat. We're also grateful to Cathy and Leslie Dantchik for being the hosts for the girl playwrights.



### BE ON THE LOOKOUT FOR INTERNS!

If you know of any college or graduate students who might enjoy working with us, playing with us, and going on trips with us for a semester, please have them email Caylyn at [creager@52project.org](mailto:creager@52project.org). We are currently looking for interns for the Summer of 2019. Thanks!

## OUT OF THE BLUE: THE UNPREDICTABLE PLAYS: ACT 1

All original music composed by Zonia Tsang

### THE LIES

Written by Denisse Xolocotzi, age 11

Dramaturge/Director: Leta-Renée Alan. Costumes: M. E. Guadalupe Rubi.

Lexy, a chicken ..... Olivia Gilliatt  
Jumpy, a kangaroo ..... Arlo Hill  
Driver ..... Jennell Strong

*Why Did I Lie?* lyrics by Denisse Xolocotzi.

### THE GAMBLING CAT AND THE CRAZY LION

Written by Alex De La Rosa, age 9

Dramaturge: Kat Almirañez, Director: Lynnette Freeman. Costumes: John Beltre.

Romell, a cat ..... Jose Duran  
Rachel, a lion ..... Leslie Fray  
Ralph the Tiger ..... Ellen Gallos  
Voice of Yarn Ball ..... Lynnette Freeman  
Other animals ..... The Crew

*My House Now* lyrics by Alex De La Rosa.

### THE ABUSED CHILD TURNS TO PRINCESS

Written by Antonella Suero Loyola, age 10

Dramaturges: Caylyn Creager and Rachel Lin, Director: Rachel Lin.

Costumes: M.E. Guadalupe Rubi.

Nicky, a 13-year old girl ..... Nick Mills  
Angel, Nicky's mother/Banana, a banana ..... Roma Maffia  
Cops ..... The Crew  
The Queen ..... Kat Almirañez

*Got To Clean* lyrics by Antonella Suero Loyola.

### THE TWO SISTERS OR LAS DOS HERMANAS

Written by Crismell Concepción, age 11

Dramaturge/Director: Colette Robert. Costumes: M.E. Guadalupe Rubi.

Supertitle translations by Alexandra Lemus.

Lavender ..... Shirley Rumierk  
Lindsay ..... Flor De Liz Perez  
Señor ..... George Babiak

*I Love Dancing* lyrics by Crismell Concepción.

### MY FRIEND/ENEMY

Written by Adolfo Sinchi, age 9

Dramaturge/Director: Austin Regan. Costumes: M.E. Guadalupe Rubi.

Joey aka Superboy ..... Jose-Maria Aguila  
Justin, aka Dr. Horror ..... Ross Cowan  
Teacher, aka Dead Killer ..... Cody Wilson  
Students ..... The Crew

*Joey Please Forgive Me and I'm Sorry Jusin* lyrics by Adolfo Sinchi.

## OUT OF THE BLUE: THE UNPREDICTABLE PLAYS: ACT 2

### WACKY TIMES

Written by John Muca, age 10

Dramaturge/Director: Kyle David. Costumes: Crystal Thompson

Gingy, a gingerbread woman ..... Nadia Quinn  
Max A. Million, a skeleton ..... Greg Hildreth  
Caller's voice ..... Justin Bannister  
O.K., Max's brother ..... Cody Wilson

*Blues Bones* lyrics by John Muca.

### WHY WOULD YOU DO WHAT THE DOG DOES?

Written by Jojo Perez, age 9

Dramaturge/ Director: Korey Jackson. Costumes: M.E. Guadalupe Rubi

Doge ..... Biko Eisen-Martin  
Jeffrey ..... Jorge Chacón  
Policeman ..... Wilhelmina Ohene-Karikari  
Mr. Cat ..... Justin Bannister  
Mom ..... Wilhelmina Ohene-Karikari

*Coolness* lyrics by Jojo Perez.

### THE SECRET

Written by Jai-Lyzz Rodriguez, age 10

Dramaturge/Director: George Babiak. Costumes: John Beltre

Zero/Zero-X ..... Sam Dash  
Zaria ..... Angel Desai  
Dr. Bockinshock ..... John Sheehy  
Citizens ..... Justin Bannister/Wilhelmina Ohene-Karikari

*I Am Really Really Sorry* lyrics by Jai-Lyzz Rodriguez

### BULLY TO NERDY

Written by Loyal Jones, age 10

Dramaturge/Director: Cody Wilson. Costumes: John Beltre

Nerdy Boy ..... Sullivan Jones or Cody Wilson  
Bully ..... Margaret Odette

*Keep On Going* lyrics by Loyal Jones.

### ACCEPTION

Written by Ayah Musa, age 10

Director/Dramaturge: Alexandra O'Daly. Costumes: John Beltre

Claria ..... Meredith Garretson  
Mari-Ann, a hero of justice ..... Jennifer Ikeda  
Queen ..... Kat Almirañez  
Palace Guards ..... George Babiak and Wilhelmina Ohene-Karikari

*Rainbows in the Dark* lyrics by Ayah Musa.

The 52nd Street Project is a non-profit arts organization that brings children from the Hell's Kitchen neighborhood together with professional artists to create original art.

In Stage Combat, a ruff-n-rowdy group of Project kids and their scrappy adult partners have learned the art of safe, choreographed fake-fighting. Led by Project volunteer Kerry Warren, they've learned to tell stories of high-stakes conflicts through punches, kicks, slaps, and so much more! Each play is centered around a staged fight that they have created with the guidance of their adult partners.

#### **The 52nd Street Project Staff**

Kat Almirañez, Associate Artistic Director  
Ahmed Attia, Development Associate\*  
George Babiak, Director of Design and Production  
Liz Bell, Clinical Consultant  
Jasmine Correa, Office Manager\*  
Kali Crandall, Development Director  
Caylyn Creager, Education Associate  
Natalie Hirsch, Artistic Director  
Garrett Kim, Program Director  
Carol Ochs, Executive Director  
Gus Rogerson, Producing Director  
Sayantee Sahoo, Production Manager  
John Sheehy, Director of Institutional Advancement  
Johanna Vidal, Director of Education\*  
Iris A. Brown, Graphic Design Consultant  
*\*Project Alumni*

#### **Interns:**

Sylvia Czubarow, Carina Goebelbecker, Rava Raab, Jennell Strong

#### **Teen Employees:**

Receptionists: Kayla Matos, Wilhelmina Ohene Karikari,  
Tinia Powell, Jayleen Velez

Concessions: Kiara Figueroa

Ushers: Sasha Davis and Nicole Quiles

Stage Combat Teen Counselor: Darby O'Donnell

#### **The 52nd Street Project Board of Directors**

Lisa Benavides	Valerie Kay
Rachel Chanoff	Noël Mihalow
Cathy Dantchik, co-chair	Roseline Michael Neveling
Carolyn DeSena	Carol Ochs
Wendy Ettinger, chair emeritus	Willie Reale, founder
Louis P. Friedman, co-chair	Gus Rogerson
Alexandra Gersten-Vassilaros	Shirley Rumierk, alumni member
Robert Goldberg	José Soto, Jr., alumni member
Stephen Graham, chair emeritus	Merritt Tilney
Annie Hausmann	Wendy vanden Heuvel
Natalie Hirsch	Mark Whatley

THE 52ND STREET PROJECT PRESENTS



**FRIDAY, MARCH 29, 2019**

**7:30 P.M.**

**FIVE ANGELS THEATER**

# SEEING STARS

## THE 2019 STAGE COMBAT SHOW

### SOMEBODY'S WATCHING ME

Fight choreography by Kerry Warren.  
Performed by the Stage Combat 2019 Company

### FOREST BRAWL

Fight choreography by Aaron Ordinola, with Michael Propster (Smart Partner team)  
Phoenix Fletcher..... Aaron Ordinola  
*Fighting Quirk: one punch kills and destructs everything in one powerful punch with a blast of wind*  
Denton, CEO of Orange ..... Michael Propster  
*Fighting Quirk: berserk: pain level -9*

### FRIENDS

Fight choreography by Melanie Correa, with Lydian Blossom  
Raquel, a 15-year-old ..... Melanie Correa  
*Fighting Quirk: She gets nervous, she gets scared*  
Clare, a 15-year-old ..... Lydian Blossom  
*Fighting Quirk: Looking in the eye very serious*

### THE FIGHT

Fight choreography by Walter Olivares, with Grant Harrison (Smart Partner team)  
James, a 22-year-old pro fighter..... Walter Olivares  
*Fighting Quirk: his fear is to lose at fighting*  
John, a 22-year-old pro fighter ..... Grant Harrison  
*Fighting Quirk: his fear is to not get the prize*

### THE "CAFE"

Fight choreography by Darby O'Donnell, with Sarah Quigley  
Scarlett, a "cafe" owner ..... Darby O'Donnell  
*Fighting Quirk: thinks street fighting is the only thing she's good at*  
Detective Sally Smith, a detective ..... Sarah Quigley  
*Fighting Quirk: stronger than she thinks*

### AL'S CANNED SOUP

Fight choreography by Nikolai Alvarez, with Mat Hostetler  
Big Al, a 25-year-old boxer ..... Nikolai Alvarez  
*Fighting Quirk: goes crazy after hitting you*  
Zen Al, a 41-year-old therapist ..... Mat Hostetler  
*Fighting Quirk: sings Adele while fighting*  
Park-goer & Grocery Shopper ..... Sylvia Czubarow

### THE FINAL BATTLE

Fight choreography by Kassandra Sinchi, with Rachel Skalka  
Alene, a 10-year-old student & Athena's sister..... Kassandra Sinchi  
*Fighting Quirk: backs away*  
Athena, a 10-year-old student & Alene's sister..... Rachel Skalka  
*Fighting Quirk: over-confident, give you the look like you will lose*

### CRYBABY

Fight choreography by Amirah Hancock, with Molly Carden  
Ashley Blake, an American chemistry student at Harvard..... Amirah Hancock  
*Fighting Quirk: whenever she gets punched, she cries*  
Lulu Jenkins, an Australian chemistry student at Harvard..... Molly Carden  
*Fighting Quirk: hates being called "outback girl"*

### THE TROUBLE

Fight choreography by Yousef Altareb, with Marco Formosa  
Yousef, a 21-year-old ..... Yousef Altareb  
*Fighting Quirk: the punch*  
Marco, a 21-year-old ..... Marco Formosa  
*Fighting Quirk: a push*

### THE ARGENT LIFE

Fight choreography by Kylee Chester, with Aishling Pembroke  
Victoria Argent (Agent Sea Turtle), a superhero secret agent..... Kylee Chester  
*Fighting Quirk: does a lot of punching and hair pulling*  
Sara Argent (Miss Evi L'Villan), a supervillain secret agent..... Aishling Pembroke  
*Fighting Quirk: includes pet in fight*

### THE PRODUCTION TEAM

Fight Director and Instructor ..... Kerry Warren  
Stage Manager ..... Jenni Swan  
Lighting Designer..... Sayantee Sahoo  
Sound Design ..... Sevan Asencio  
Props ..... George Babiak  
Stage Crew ..... Sylvia Czubarow



The Stage Combat Program is made possible with public funds from The New York State Council on the Arts, a state agency, and the New York City Department of Cultural Affairs. This project is supported in part by an award from the National Endowment for the Arts. The 52nd Street Project is a member of Art/NY and Theatre Communications Group (TCG), the national organization for the American theatre.

### The 52nd Street Project Staff

Kat Almirañez, Associate Artistic Director  
 Ahmed Attia, Development Associate\*  
 George Babiak, Director of Design and Production  
 Liz Bell, Clinical Consultant  
 Jasmine Correa, Office Manager\*  
 Kali Crandall, Development Director  
 Caylyn Creager, Education Associate  
 Natalie Hirsch, Artistic Director  
 Garrett Kim, Program Director  
 Carol Ochs, Executive Director  
 Gus Rogerson, Producing Director  
 Sayantee Sahoo, Production Manager  
 John Sheehy, Director of Institutional Advancement  
 Johanna Vidal, Director of Education\*  
 Iris A. Brown, Graphic Design Consultant  
 \*Project Alumni

#### Intern:

Carina Goebelbecker

#### Teen Employees:

Receptionists: Jayleen Velez  
 Concessions: Bamba Thiam, Natasha Davis, Nicole Quiles  
 Ushers: Tiniyah Powell, Sevan Asencio

### The 52nd Street Project Board of Directors

Lisa Benavides	Valerie Kay
Rachel Chanoff	Noël Mihalow
Cathy Dantchik, co-chair	Roseline Michael Neveling
Carolyn DeSena	Carol Ochs
Wendy Ettinger, chair emeritus	Willie Reale, founder
Louis P. Friedman, co-chair	Gus Rogerson
Alexandra Gersten-Vassilaros	Shirley Rumierk, alumni member
Robert Goldberg	José Soto, Jr., alumni member
Stephen Graham, chair emeritus	Merritt Tilney
Annie Hausmann	Wendy vanden Heuvel
Natalie Hirsch	Mark Whatley



The 52nd Street Project (aka, The Project) is a non-profit arts organization that brings children from the Hell's Kitchen neighborhood together with professional artists to create original art.

Project Exchange is a recent initiative of The 52nd Street Project. With the help of artists and partner service organizations, Project Exchange reaches out beyond Hell's Kitchen to communities across New York. As it grows, we aim to bring Playmaking and other Project programs to kids living in different pockets of the city. The plays you will see tonight are the fruit of this Spring's Playmaking Class with Win. We hope you enjoy our presentation.

### THE PROJECT EXCHANGE TEAM

Playmaking Director ..... Joanna Gurin  
 Playmaking Associate ..... Annabelle Cousins  
 Teen Associate ..... Kai Ceniza  
 Lighting Designer.....Liz Schweitzer  
 Sound Designer.....Alicia Moeller  
 Costumes and Props.....Kat Almirañez  
 Stage Manager.....Caylyn Creager  
 Playmaking Mentors ..... Kerry Warren, Eliza Huberth,  
 Angelica Toledo



Project Exchange is made possible with public funds from The New York State Council on the Arts, a state agency, and the New York City Department of Cultural Affairs. The 52nd Street Project is a member of Art/NY and Theatre Communications Group (TCG), the national organization for the American theatre.

# THE 52ND STREET PROJECT EXCHANGE: WIN PLAYMAKING SPRING 2019

## Act 1

### Friends

by Quinejah. Directed by Natalie Hirsch.

Kendall..... Ceci Fernandez  
Andrea..... Marinda Anderson  
Waiter..... Angelico Toledo

★★★

### Jay The Lost Boy

by Ezeckiel. Directed by Gus Rogerson.

Lee Violet..... Jose-Maria Aguila  
Unknown Boy (Jay Violet)..... Motell Foshier  
Father..... Gus Rogerson

★★★

### One Important Gift

by Bryanna. Directed by Monica Trausch.

Princess Rainbow..... Aishling Pembroke  
Queen Grace / Alexis..... Arielle Goldman  
Moon..... Molly Carden

★★★

### Murder Mystery

by Angelina. Directed by Eliza Huberth.

Rosetta..... Kara Young  
Policeman/Henry (Dad)/J..... Armando Riesco  
Ms. Lovely..... Angelico Toldedo

★★★

### Basketball

by Nehemiah. Directed by Gus Rogerson.

Asher..... Motell Foster  
Joseph..... Jose-Maria Aguila  
Alex..... Gus Rogerson

## Act 2

### Imagination

by Brandon. Directed by Kerry Warren.

Hannah..... Grace Rex  
Chris..... Matthew Saldivar  
Margaret (Mom)..... Angelica Toledo  
John (Dad)..... Garrett Kim  
TV Robot..... Annabelle Cousins

★★★

### Sister Danger

by Mia. Directed by Monica Trausch.

Brianna..... Molly Carden  
Bella..... Aishling Pembroke  
Jessica..... Arielle Goldman

★★★

### The Day of Embarrassment

by Francisco. Directed by Kerry Warren.

Wolfey..... Matthew Saldivar  
Madeline..... Grace Rex  
Waitress/Little Sister..... Angelica Toledo  
Dad..... Garrett Kim  
Mom..... Kerry Warren

★★★

### The Dance

by Brithani. Directed by Natalie Hirsch.

Cutie..... Maria Pembroke  
Uniy..... Ceciy Fernandez

★★★

## SPECIAL THANKS

Jesse Gamoran, Aliciza Malcousu, Antina Myers,  
Sasha Njoku, Tamara Ortiz, Brittany Pavon Suriel,  
Edwina Pierre, Elizabeth Reid, Nyasha Salmon,  
Diana Santos, Jahmela Smith, and Cynthia Snyder

## The 52nd Street Project Board of Directors

Lisa Benavides  
 Rachel Chanoff  
 Cathy Dantchik, co-chair  
 Carolyn DeSena  
 Wendy Ettinger, chair emeritus  
 Louis P. Friedman, co-chair  
 Alexandra Gersten-Vassilaros  
 Robert Goldberg  
 Stephen Graham, chair emeritus  
 Annie Hausmann  
 Natalie Hirsch

Valerie Kay  
 Noël Mihalow  
 Roseline Michael Neveling  
 Carol Ochs  
 Willie Reale, founder  
 Gus Rogerson  
 Shirley Rumierk, alumni member  
 José Soto, Jr., alumni member  
 Merritt Tilney  
 Wendy vanden Heuvel  
 Mark Whatley

## The 52nd Street Project Staff

Kat Almirañez, Associate Artistic Director  
 Ahmed Attia, Development Associate\*  
 George Babiak, Director of Design and Production  
 Liz Bell, Clinical Consultant  
 Jasmine Correa, Office Manager\*  
 Kali Crandall, Development Director  
 Caylyn Creager, Education Associate  
 Natalie Hirsch, Artistic Director  
 Garrett Kim, Program Director  
 Carol Ochs, Executive Director  
 Gus Rogerson, Producing Director  
 Sayantee Sahoo, Production Manager  
 John Sheehy, Director of Institutional Advancement  
 Johanna Vidal, Director of Education\*  
 Iris A. Brown, Graphic Design Consultant

*\*Project Alumni*

### Interns

Sylvia Czubarow, Carina Goebelbecker

### Benefit Volunteers

KeiLyn Durrell Jones, Kayla Matos,  
 Wilhelmina Ohene Kari-Kari, Ashley Marie Ortiz, Tintah Powell,  
 Kim D. Sherman, Vanessa Valdes, Kerry Warren, Yazyzy Wilder

dormiFy



The programs of The 52nd Street Project are made possible with public funds from The New York State Council on the Arts, a state agency, and the New York City Department of Cultural Affairs. The 52nd Street Project is a member of Art/NY and Theatre Communications Group (TCG), the national organization for the American theatre.



# Power In Numbers

*The Only Gala That Really Counts  
 For The 52nd Street Project*

**Capitale**

**Monday, May 6, 2019**

**Honoring Project Power Couple Eliza Baldi & David Costabile**



**Program and Auction Catalogue**



## **“Power in Numbers” Benefit Co-Chairs**

Becky Browder  
Cathy Dantchik  
Carolyn DeSena  
Mary Pat Walsh  
Louis & Patrice Friedman  
Karin Schall  
Merritt Tilney

### **The 52nd Street Project gratefully acknowledges...**

Abbeville Press  
Ambassador Theatre Group  
Avi & Richard Anthony  
Kate & Andy Bellin  
Iris A. Brown Design  
William Curran, A Curran Affair  
The Daily Show with Trevor Noah  
Michael Dorf, City Winery  
Dormify.com  
Sean Feeny, MISI  
Lauren Friedman, Pharma Print, Inc.  
Celia Keenan-Bolger  
Pamela Liebman, The Corcoran Group  
Charlie Marshall  
Stella McCartney  
Michter’s Distillery  
Noël Mihalow, Prime Films  
The Neveling Family  
Winston Rodney  
Signature Bank  
SHOWTIME  
The Surrey Hotel  
Merritt Tilney & Doug Kaden  
Vassilaros & Sons Coffee Company  
Alexandra Vassilaros & the Vassilaros Family  
The Watkins Company  
Healthier Living Since 1868  
Vicki & Mark Whatley



## **NTH DEGREE SEATS**

Avi & Richard Anthony  
Gavin Berger & Craig Berggren  
Denise Burse & Peter Jay Fernandez  
Tara Elwin  
Janice Gabrilove & Michael Drizulaitis  
Jeannie & Jim Gaffigan  
Jane & Greg MacPherson  
Steve Olsen  
Laura Sametz  
Brian Sawyer  
Cynthia Vance & Robert Abrams  
Zia & Victor Williams

## **THE ONES PLACE SEATS**

Beth & Ray Abbott	Mary Kong
Becky & Dylan Baker	Ellen Kroll
Beth Barry	Frances & Fred Langbecker
Beth & Eric Berman	Jené LeBlanc & Willie Reale
Susan Beshel	Sean Liebowitz
Jane Bolster & Steve Wertimer	Jean McKeever
Becky Browder & Ted Neustadt	Suzen Murakoshi
Ellen Chopay	Carol Ochs & Bruce MacVittie
Katie & Kelly Clark	Sabrina Palladino
Dana Cohen	Courtney & Lowell Pettit
Sherry Cohen	Sue Poulin
William Crudup	Randi Puccio
Rebecca & Richard Dresser	Ivy & Michael Rachlin
Andrew Farach-Colton	Christopher Randolph
Katie Finneran & Darren Goldstein	Lynne Marie Rosenberg
Lindsay Fram & Mason Pettit	Laura & David Ross
Anne & George Gagen	Karin & Tom Schall
Tina Galley	Sylvia Shepard & Willy Holtzman
Robin Galloway	Maggie Siff & Paul Ratliff
Craig Gartner	Jenni Swan
Christen Gleason & Erik Larson	Richard Sweren
Pierce Han & Richard Langan	Edith Thurber & Kevin O'Rourke
Jessica Hecht & Adam Bernstein	Melissa Toth
Sarah Horowitz	Laura Valeroso
Robert Joy & Henry Krieger	Mary Pat Walsh
Christa Justus & Mark Linn-Baker	Tracy Wan
Cynthia Kaplan & David Froelich	Jeffrey Wise
Kim & Elliot Katz	Carole Yass

# OUR DONORS

## FIRST AMONG EQUALS TABLE

The CLAWS Foundation



### TIMES TABLES

Eliza Baldi & David Costabile

Patrice & Louis Friedman

Annie & David Hausmann

Merritt Tilney & Douglas Kaden

Wendy vanden Heuvel & Brad Coley

### BASE TEN TABLES

Altman, Greenfield & Selvaggi

Lawrence W. & Deborah A. Catena

Carolyn DeSena

Bob Goldberg, Yorke Construction Corporation

Kimberly Grigsby

Valerie Kay & Bruce Graham

Noël & Joe Mihalow,

The Dawkins Family Foundation

Roseline Michael Neveling & Dennis Neveling

### SHOWTIME

Alexandra Vassilaros,  
Vassilaros & Sons Coffee Company

Vicki & Mark Whatley

Jeffrey Yass & Janine Yass,  
Susquehanna Foundation



Carol Ochs,  
Executive Director

Cathy Dantchik & Louis P. Friedman,  
Board Co-Chairs

Natalie Hirsch,  
Artistic Director

Honorary Co-Chairs Paul Giamatti, Damian Lewis,  
and Maggie Siff proudly present

## POWER IN NUMBERS

The 52nd Street Project's Annual Benefit Gala  
Monday, May 6, 2019 at Capitale



### Our Honorees

Eliza Baldi and David Costabile

### Our Hosts

John Ellison Conlee and Joel de la Fuente

### The Lyricists

Nyla Blake-Soden

Amari Dubose

Kiara Figueroa

Christian Santoni

Jayleen Velez



### The Composers and Performers

Lilli Cooper, Brian d'Arcy James, Kim Jinyoung,  
Jarrett Murray, Sean P. Pallatroni, Ronald Peet,  
Sharone Sayegh, David Andrés Trujillo-Tapias,  
Natalie Walker, Richard C. Walter

### Music Director/Piano

Avi A. Amon

### Bass

Sam Weber

### Guitarist

Doug Derryberry

### Drums

Chris Schultz

### Lighting Designer

Greg MacPherson

### Sound Designer

Matthew Soares

### Set and Prop Designer

George Babiak

### Stage Manager

Jenny Peek

### Invitation/Program Designs

Iris A. Brown

### Director

Gus Rogerson

Thanks to Patrick Thompson

# FREEDOM

Lyrics by Amari DuBose, age 12

Music by Sean P. Pallatroni

Performed by Ronald Peet



Freedom is Power  
I want to be free  
I wanna express and feel  
I wanna go on with my life  
I have to break the seal  
And I'm almost there

There's weight on my back  
It's responsibility  
We can't stay kids forever  
Saying to my past present and future  
We can do it together  
And I'm almost there

Free from the Chaos  
Free from being trapped by rules, and told to stay  
The power isn't there to do the things you want to do  
But you will one day.

Freedom is confidence  
Learn to love yourself  
Live to learn  
Learn to live trust me  
You'll see  
We're almost there. ♪

# 7. THE BILLIONS FOR CIVILIANS PACKAGE

Our favorite fake billionaire, **David Costabile**, will escort you and a guest on a tour of the set of **Showtime's** hit show **Billions** during Season 5 (subject to production schedule, of course). Hang out with David (known on the show as "Wags"), watch a taping, and maybe catch a glimpse of Bobby Axelrod (**Damian Lewis**) or Wendy Rhoades (**Maggie Siff**). The minimum age is 16 years old (Have you seen the show? It's NOT for kids), the prize is non-transferable, and the expiration date is 8/31/2020.



This package includes a bottle of **Wags' Private Stash Michter's Bourbon**. David himself traveled to Michter's, the Louisville distiller whose bourbon was proclaimed "Best American Whiskey" by Food & Wine magazine, to taste through barrels and personally select two for a rare blend of extraordinary quality. Wag's Stash was blended only for the cast and crew of *Billions*... and, just maybe, YOU!

**VALUE:** Billions! (Honestly, what else would we say?)

## THERE'S MORE AUCTION ACTION ONLINE!

We could sell stuff all night, but we've got a show for you to watch! If you missed out on the bidding or just want to help us boost tonight's proceeds for the Project, we've got some nifty items posted online. Just visit [www.charitybuzz.com](http://www.charitybuzz.com), do a search for "The 52nd Street Project," and get more details about the following:

- ⊙ A **World of Stella McCartney** Designer Package
- ⊙ Tickets to **Trevor Noah on The Daily Show**
- ⊙ **New York Yankees** tickets (with Ford Field MVP Club Access)



## 5. "THIS IS WHAT I CALL A DEAL" PACKAGE

This is a unique offer, the first of its kind at a Project Benefit, to join **The Entertainers' Game** for a high-stakes evening of poker with show biz tycoons, agents, writers, producers, actors and more! The winner's bid will include the \$1,000 initial buy-in. Possible regulars that MAY show up at the table include: **Richard Anthony, Hank Azaria, Andy Bellin, Eric Bogosian, Billy Crudup, and David Schwimmer.**

**VALUE:** You tell us after you win, hotshot!



## 6. COSTY CONNOISSEUR/BALDI BON VIVANT PACKAGE

By now you're probably thinking "Gee, **David** and **Eliza** are really cool and nice. I'd sure like to spend some time blending and tasting wine with those two." Well, you can do just that! **City Winery**, that excellent music and dining venue on Varick Street, is going to let you, five of your pals, and our two guests of honor spend an evening having dinner and blending wine in the exclusive barrel room. No, it's not IN a barrel! There are barrels in the room! You'll also get a case of the wine you blend, once it has been bottled.

**VALUE:** We've gotta say this is kinda priceless!



## HOLLYWOOD

Lyrics by Nyla Blake-Soden, age 12

Music by Kim Jinhyoung

Performed by Natalie Walker

RYAN NAVA



Hi, my name is Holly, I'm the Hollywood sign  
I have been here for a whopping hundred years  
I am in my midlife crisis right now. Right now!  
You need to stop invading my ground. It's my ground!  
(speaking) I have an idea...  
Singing - I will change my letters to be scrambled.  
(whisper) Scrambled.  
D-O-L-L-Y-W-H-O-O. Two "o"s!  
Now my name is Dolly, I am different. Go away now!  
Everybody give me peace and quiet. (whisper) No sound!  
This is the life I wish I'd been living forever  
Now I am sitting here alone  
Now I can see the sun without me being bothered  
I feel better calling this place home  
Now that I think about it I am kind of lonely  
I think that I need to be viewed  
I want to go back to my original shape and name  
I'm going back to Hollywood  
(speaking) That feels much better  
Now I want more people to come see me (riff)  
I already see a little boy  
Wow that news got out pretty fast, I am feeling better  
Everybody, Make. Some. Noise! 🎵



RYAN NAVA

## CITY LIFE

Lyrics by Kiara Figueroa, age 16

Music by Jarrett Murray

Performed by Sharone Sayegh

City life is too fast  
Afraid I'm missing out on life  
Wishing for a moment so everything  
can slow down  
Just to breathe

Fast light, fake people  
Trying to find the good  
Fighting to stay gleeful  
But nothing stays the  
same in my hood

Wishing to drown out all the noise  
Wishing to not see fake smiles  
And masks between them  
Would come off

Kids are growing up too fast,  
One blink and you'll miss them.  
We should try to make things last  
Before we miss everything we want  
and more.

Stopping time to observe  
Trying to take the time to learn  
Trying to find a place  
Where it is not so fake.

Bright light, fun people  
Always finding the good  
Forever gleeful.  
But every day's  
the same in my hood

Fast light, fake people  
Trying to find the good  
Fighting to stay gleeful  
But nothing stays the same in my  
hood

Bright light, fun people  
Always finding the good  
Forever gleeful.  
But every day's  
the same in my hood. 🎵

Everyone is the same.  
Lying to benefit themselves  
Everyone is living their own special lie  
Why can't we be ourselves

## 3. FROM HOGWARTS TO CENTRAL PARK PACKAGE

Got a kid? Know a kid? Are a kid at heart? You'll want this: a pair of tickets to *Harry Potter and the Cursed Child, Part I & Part II* at the Lyric Theater. That's really **two** pairs of tickets!

This deal also gets you dinner for two at **The Marshal** restaurant in Hell's Kitchen. It's a great place with terrific food that's been one of our favorites for years. It's close enough to the Lyric to eat there between shows.

And, since you and your guest will be pretty pooped after all that spell-casting, this package includes two nights at the magical **Surrey Hotel** on East 76th St., just off Central Park.

**VALUE:** \$3,000+



## 4. GREECE IS THE WORD PACKAGE

**Ikaria**, a beautiful island in the Aegean Sea, is said to be the land that time forgot. You'll spend **7 nights** in a tiny village on the sea known as **Faros** in the new three bedroom home of the **Vassilaros Family**, just 20 feet from the ocean.

The proceeds from this package will benefit **The Johnny Fund**, a special fund that honors the memory of John Vassilaros and supports the Teen Leadership Program at the Project.

Choose your days between either June 15 - June 30, 2020 or August 25 - Sept. 8, 2020. NEXT summer, not this one. Lots of time to plan!

**VALUE:** Olympian! Well, \$6,000.



## 1. THE MISI/MOCKINGBIRD PACKAGE

Here's a bundle of fine experiences: First, you get two tickets to Harper Lee's *To Kill a Mockingbird*. You watch it, then get treated to a backstage tour with Tony nominee **Celia Keenan-Bolger**, who plays Scout Finch! (Valid June 18-Aug. 2, 2019. Two weeks notice required.)

Also part of the bundle is a dinner for 4 at **MISI**, the Williamsburg restaurant with founding chef **Missy Robbins**. The New York Times calls her "*the most exciting interpreter of Italian food in the city.*" You'll enjoy Missy's tasting menu and a wine pairing and get a copy of her cookbook "*Breakfast, Lunch, Dinner ... Life*". This offer is good until May 7, 2020.

**VALUE:** Mockingbird tickets: \$400+  
Dinner at Misi: \$600  
Scout's Tour and Missy's signed book: Priceless

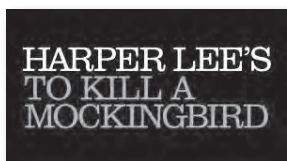

## 2. A SONG OF GRIDIRON AND ICE PACKAGE

We're not talking fantasy, we're talking fantastic seats for you and three buddies at two great home team events. Start by treating your cronies to a **New York Giants** home game at MetLife Stadium, mezzanine, Club A, section 237, row 7, seats 21-24. This includes **parking** and use of a **private entrance**. Date to be agreed upon with the owner of the tickets.

If your pals still aren't impressed, you can follow up with the second part of the package: four **New York Rangers** tickets at **Madison Square Garden** in section 111, row 21, seats 7, 8, 9, & 10. Date/game to be agreed on by owner of the tickets.

**VALUE:** \$2,800



## I AM A POOPER HERO

Lyrics by Christian Santoni, age 10

Music by David Andrés Trujillo-Tapias

Performed by Brian d'Arcy James

RYAN NAVA



My name is Chris  
Ah I am so bored  
Oh wait  
I could talk about the new pooper heroes  
I hate superheroes because they have powers to do whatever  
I am just a normal person who does nothing

I love to get one dollar a day  
Because I like when I call them pooper heroes on the newspaper  
Cause I do nothing anyway  
I hate getting one hundred dollars a day  
Cause I wrote it too good  
And then I get an extra 99 dollars  
Instead of the best part  
One dollar a day  
And I hate it!!!!!!!!!!!!!!

I hate superheroes cause they can do anything  
I am a normal person like nothing

Oh look guys  
There is a pooper hero outside  
Now I can now write about a pooper hero  
Cause he has brown but also gold

But his powers look pretty cool  
He can spawn anything  
Oh wait I have a good name for this pooper hero Spawn  
Maybe I should stop calling them pooper heroes  
Because ever since I have seen this superhero changed my life  
And start to call them super heroes

I am now a superhero fan  
Because they save people  
And I didn't care  
But now I do  
Cause this one is the best superhero I have ever saw (gets his power)  
OMG I am a superhero  
For all of these years that's all I had to do  
Well the good thing is that I have super powers  
Now my name is Cristal

I used to hate super heroes cause they can do whatever  
I am just a normal person who does nothing  
But now I am a superhero. ♪



GRB

## TIME TO SHINE

Lyrics by Jayleen Velez, age 15

Music by Richard C. Walter

Performed by Lilli Cooper

3, 2, 1  
 This is my time  
 My time to shine...literally  
 My moment has come  
 My bright light on this winter night

Brighter than all the stars  
 I'll be seen from miles away  
 This will be my moment  
 The night has come  
 There's no way the day will get in  
 my way

This is my time  
 This is my time  
 My time to shine  
 I will lead us to this light  
 I will be the knight just wait

The sun has nothing on my  
 radiance  
 I will be noticed from light years  
 away  
 This will be the date  
 The date that this room gets lit  
 And it'll all be because of me

The day always is in my way  
 It's just a big pain  
 But there's nothing to lose  
 I will reign over the light  
 The stars are no match for me this  
 time  
 Cause

This is my time  
 My time to shine  
 My moment is done  
 My bright light on this winter night  
 On this winter night

This is my time  
 My time to shine  
 My moment is done  
 My bright light on this winter night  
 On this winter night. ♪



## Power In Numbers Auction Catalogue



Greetings, digit fans! Thanks for coming to Capitale to eat some posh grub and hear some clever tunes. Don't get too comfy though, because any second now, the Project's witty and urbane Founder, **Willie Reale**, will nimbly bound onto the stage and, with the help of our affable host **John Ellison Conlee**, auction off the one-of-a-kind packages described on the following pages. Be bold on your bids! Don't fear high numbers! It all goes to a good cause.

The 52nd Street Project is a non-profit arts organization that brings children from the Hell's Kitchen neighborhood together with professional artists to create original art. The Dancemaking program gives 9 Project kids a chance to express themselves creatively through movement. Over the nine weeks of Dancemaking class, led by Elli Stovall Brown with support from Program Director Garrett Kim, these young choreographers and performers developed their own movement vocabulary. With their adult partners, they explored shapes, pathways, actions, and choreographic elements to create their own original piece. The resulting dances are featured in tonight's performance.

### The 52nd Street Project Staff

Kat Almirañez, Associate Artistic Director  
 Ahmed Attia, Development Associate\*  
 George Babiak, Director of Design and Production  
 Liz Bell, Clinical Consultant  
 Jasmine Correa, Office Manager\*  
 Kali Crandall, Development Director  
 Caylyn Creager, Education Associate  
 Natalie Hirsch, Artistic Director  
 Garrett Kim, Program Director  
 Carol Ochs, Executive Director  
 Gus Rogerson, Producing Director  
 Sayantee Sahoo, Production Manager  
 John Sheehy, Director of Institutional Advancement  
 Johanna Vidal, Director of Education\*  
 Iris A. Brown, Graphic Design Consultant  
 \*Project Alumni

### Interns:

Carina Goebelbecker, Gabby Rente

### Teen Employees:

Receptionists: Jayleen Velez, Wilhelmina Ohene-Karikari, Tiniyah Powell  
 Concessions: Chyanne Peña, Beyonce Thomas, Sasha Davis  
 Ushers: Tiniyah Powell, Sevan Asencio

### The 52nd Street Project Board of Directors

Lisa Benavides	Valerie Kay
Rachel Chanoff	Noël Mihalow
Cathy Dantchik, co-chair	Roseline Michael Neveling
Carolyn DeSena	Carol Ochs
Wendy Ettinger, chair emeritus	Willie Reale, founder
Louis P. Friedman, co-chair	Gus Rogerson
Alexandra Gersten-Vassilaros	Shirley Rumierk, alumni member
Robert Goldberg	José Soto, Jr., alumni member
Stephen Graham, chair emeritus	Merritt Tilney
Annie Hausmann	Wendy vanden Heuvel
Natalie Hirsch	Mark Whatley

The 52nd Street Project Presents

# The 2019 Dancemaking Concert

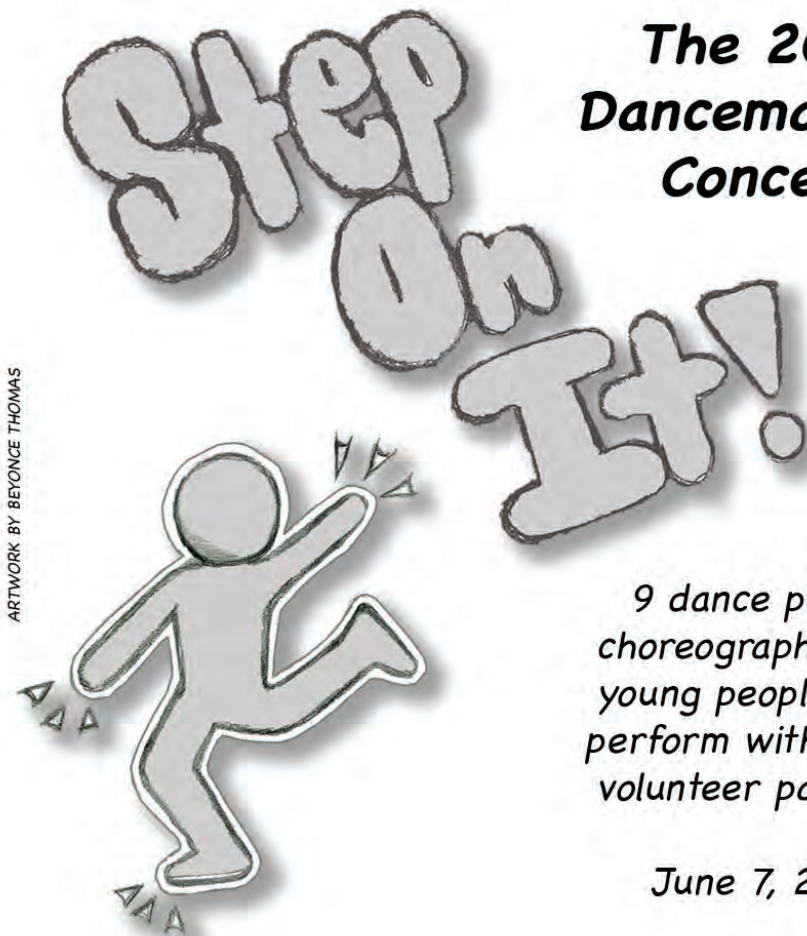

*9 dance pieces  
choreographed by  
young people who  
perform with adult  
volunteer partners*

June 7, 2019

Dancemaking Director

**Elli Stovall Brown**

Lighting Designer

**Sayantee Sahoo**

Sound Designer

**Sevan Asencio**

Stage Manager

**Jenni Swan**

Dancemaking Intern

**Carina Goebelbecker**



Dancemaking is made possible with public funds from The New York State Council on the Arts, a state agency, and the New York City Department of Cultural Affairs. The 52nd Street Project is a member of Art/NY and Theatre Communications Group (TCG), the national organization for the American theatre.



## Friendzy

Choreographed by Elli Stovall Brown  
MUSIC: "Fete by the River" by Binker and Moses  
THEME: A frenzy of freedom and happiness in the body,  
searching for an audience.

## Space Adventure Odyssey

Choreographed by Xavier Espinal with Gardiner Comfort  
MUSIC: "Sweet Apocalypse" by Lambert  
THEME: Curious Space Adventure

*CHOREOGRAPHER'S NOTE: It was fun! And I enjoyed the experience. That's it. It was fun.*

## Cleaning It Out

Quilvis Medina with Carrigan O'Brian  
MUSIC: "Gene Take a Drink" composed by Michael Gordon,  
performed by Bang on a Can All-Stars  
THEME: Relationships Are Not Clean

*CHOREOGRAPHER'S NOTE: I like when we put the pieces of our dance together, because it was fun to see our dance start to form.*

## Worship

Alex Torres with Mitchell Winter  
MUSIC: "Needed You" by ILLENIUM & "Before Or Since" by RJD2  
THEME: Powerful

*CHOREOGRAPHER'S NOTE: Walk it to feel intense but start to feel better going through. Think of something you like and feel calm at the end.*

## One Longing Moment

Daniel Henk with Ashley Marie Ortiz  
MUSIC: "Year of the Tiger (arr. Rob Moose)" by Sufjan Stevens,  
performed by Osso  
THEME: Inspirational

*CHOREOGRAPHER'S NOTE: Challenges are hard to overcome but there is always a way.*

## New Dimensions

Ivan Garcia with Leta Renée-Alan  
MUSIC: "Super Funk" by Vern Blair Debate  
THEME: Laughter

*CHOREOGRAPHER'S NOTE: New dimensions are different stories so when we did hand gestures that means we're going to a new dimension.*

## Dancing + Fighting = Fencing

Sarah Lopez with Madalyn Baker  
MUSIC: "Becoming One of "The People", Becoming One with Neytiri" composed  
by James Horner for Avatar  
THEME: Dancing and Fighting Through the Ages

*CHOREOGRAPHER'S NOTE: Think about the Nutcracker and jousting. Swan Lake and Horseback Riding. Grace and Mortal Combat.*

## Best Friends

Love Jones with Maryn Pearl Shaw  
MUSIC: "Murder Ballades: Omie Wise" composed by  
Bryce Desner, performed by eighth blackbird  
THEME: Emotional Rollercoaster of Friendship

*CHOREOGRAPHER'S NOTE: It took a long time but it was worth it every second. We came up with the theme easily because the ideas were full of emotion. It starts out mad turns happy and then competitive. It's a ROLLER COASTER OF EMOTION!*

## New York, New York

Lanai Blake-Soden with Betsy Hogg  
MUSIC: "El Toro" by Bonobo  
THEME: New York City

*CHOREOGRAPHER'S NOTE: My theme is NYC and I chose it because I looked out the window for inspiration and NYC is what I saw. The easiest part of making a dance from scratch is doing the dance after you make it. The hardest part is coming up with ideas. I am nervous to perform in front of a huge crowd but excited to show the dance. Hope you like it!*

## La Vie - Life

Rosneyri Rosario with Cassidy Wingate  
MUSIC: "La Vie" by RIOPY  
THEME: Rescue

*CHOREOGRAPHER'S NOTE: The process of making this dance was really fun. This was my 1st time choreographing & the dance classes helped me have ideas & be creative. This class is inspiring & definitely worth it. Sometimes it's hard to come up with ideas, but fun because I was never alone. I think people in real life have ups and downs. People get sad, but never alone, so I wanted to perform something that showed how people with different moods could still support each other. I feel great about the dance and how it turned out, and we hope you enjoy it!*



The 52nd Street Project (The Project) is dedicated to the creation and production of new plays for and by young people between the ages of ten and eighteen who reside in the Hell's Kitchen neighborhood in New York City. The Project does this through unique mentoring programs that match the young people with professional (and volunteer!) theater artists.

The Project is about making young people proud of themselves. The Project is not about teaching them to act, although they will learn to. It is not about teaching them to write plays, although they will learn that as well. What it is about is giving each young person an experience of success and an opportunity to prove that he or she has something of value to offer, something that comes from within that he or she alone possesses, something that cannot be taken away.

The Project's Teen Ensemble is the final step in our members' training: a two-year acting class that culminates in the production of a full-length play. This year's show has been devised by the Teen Ensemble and is being done in New York, NY; Bolinas, CA, and San Francisco, CA. We are very grateful to all our friends on both coasts for enabling this tour.

The following foundations and government agencies have generously supported the Teen Program through their contributions:

- City of New York Department of Cultural Affairs
- Harold and Mimi Steinberg Charitable Trust
- The Horace Goldsmith Foundation
- The Johnny Fund
- New York State Council on the Arts
- The Pinkerton Foundation

The 52nd Street Project is a member of Art New York



The 52nd Street Project presents an all-new, full-length performance devised by and starring The 52nd Street Project Teen Ensemble

Directed by  
Kat Almirañez  
Garrett David Kim  
Ciana Proto

# WHERE THE KNOT ENDS

The Trans-Continental Tour

Artwork by Wilhelmina Ohene-Karikari



- Featuring
- Justin Bannister
  - Sabrina Caldon
  - Jayda Isabel Camacho
  - Jade Diamond Cuevas
  - Josh Gomez
  - Lambert Havard-Whitney
  - Genesis Hires
  - Bryan Lopez
  - Kayla Matos
  - Tiffany Miller
  - Wilhelmina Ohene-Karikari
  - Chyanne Peña
  - Tinah Renee Powell
  - Sofia Santoni
  - Karen Tineo

**THE FIVE ANGELS THEATER**  
New York City, NY  
789 10th Ave.  
Friday, June 21 @ 7:30 p.m.  
& Saturday, June 22 @ 3:00 p.m.

**Z BELOW @ Z SPACE**  
470 Florida St.  
San Francisco, California  
Friday, June 28 @ 7:00 p.m.

**THE STAGE**  
@ 45 Nymph Road  
Bolinas, California  
Tuesday, July 2 @ 5:00 p.m.

## THE 52ND STREET PROJECT STAFF

Kat Almirañez, Associate Artistic Director  
Ahmed Attia, Development Associate\*  
George Babiak, Director of Design and Production  
Liz Bell, Clinical Consultant  
Jasmine Correa, Office Manager\*  
Kali Crandall, Development Director  
Caylyn Creager, Education Associate  
Natalie Hirsch, Artistic Director  
Garrett Kim, Program Director  
Carol Ochs, Executive Director  
Gus Rogerson, Producing Director  
Sayantee Sahoo, Production Manager  
John Sheehy, Director of Institutional Advancement  
Johanna Vidal, Director of Education\*  
Iris A. Brown, Graphic Design Consultant  
*\*Project Alumni*

## THE 52ND STREET PROJECT BOARD OF DIRECTORS

Lisa Benavides	Valerie Kay
Rachel Chanoff	Noël Mihalow
Cathy Dantchik, co-chair	Roseline Michael Neveling
Carolyn DeSena	Carol Ochs
Wendy Ettinger, chair emeritus	Willie Reale, founder
Louis P. Friedman, co-chair	Gus Rogerson
Alexandra Gersten-Vassilaros	Shirley Rumierk, alumni member
Robert Goldberg	José Soto, Jr., alumni member
Stephen Graham, chair emeritus	Merritt Tilney
Annie Hausmann	Wendy vanden Heuvel
Natalie Hirsch	Mark Whatley

**Thanks to our California friends and hosts:** Commonweal, Jenepher Stowell, Paull Hejinian, Eric Karpeles & Mike Sell, Valerie Kay, Shauna Marshall & Bob Hirsch, Frances McDormand, Aenor Sawyer & Melinda Griffith, Wendy vanden Heuvel & Brad Coley, Tracy Wan & Carl Creager, Zspace.

## EXTRA-SPECIAL THANKS

The California Academy of Sciences, Stephen Graham, Willie Reale

*\*Alumnus of The 52nd Street Project Teen Ensemble*

## THE SHOW

Opening  
Life is Like a Rope  
A Big Knot  
First Knots  
Childhood  
Jump Rope Friendships  
Break Through The Storm  
I Know Who I Am In The Dark  
#KnotMe  
I Don't Want to Talk ...  
Knot Your Hair, Knot Your Business  
A Knot in My Throat  
Summer Metamorphosis  
Love's Knot Easy  
Loose Knots with Tight Connections  
American Warrior: The Path to a Dream  
Ties of Time  
Knot on my Block  
Lifeline  
Monsters & the Darkness

## THE ENSEMBLE MEMBERS

Justin Bannister, Sabrina Caldon, Jayda Isabel Camacho,  
Jade Diamond Cuevas, Josh Gomez, Lambert Havard-Whitney,  
Genesis Hires, Bryan Lopez, Kayla Matos, Tiffany Miller,  
Wilhelmina Ohene-Karikari, Chyanne Peña,  
Tiniah Renee Powell, Sofia Santoni, Karen Tineo.

## THE DIRECTORS

Kat Almirañez, Garrett Kim, Ciana Proto

## THE MENTORS

Sam Dash, Jimmy Kenna, John Manolis,  
Rachel Pickup, Lynne Marie Rosenberg

## THE PRODUCTION TEAM

Caylyn Wan-Creager, stage manager and soundboard operator  
A.R. Smiley, lights (Zspace)

The 52nd Street Project gratefully acknowledges the support of the following foundations & corporations: Carol M. & Stephen E. Canter Family Foundation; Cantor Fitzgerald Relief Fund; Carnegie Corporation of New York; The CLAWS Foundation; Consolidated Edison; Dawkins Family Foundation; Dramatists Play Service, Inc.; The Jean & Louis Dreyfus Foundation; The Education Foundation of America; Flexis Capital, LLC; Goldman Sachs The Horace W. Goldsmith Foundation; The Stephen P. Hanson Foundation; Heisman Trophy Trust; The William and Flora Hewlett Foundation; Howard Ashman Trust for Theater Arts Lemle Pictures, Inc.; The Lotos Foundation; Frederick Loewe Foundation; The Rona & Randolph M. Nelson Foundation; Newman's Own; Seller-Lehrer Family Foundation; The Stavros Niarchos Foundation; Par Plumbing Co., Inc.; The Pinkerton Foundation; Sawyer | Berson Architecture & Landscape Architecture; The Morris and Alma Schapiro Fund; Showtime Networks; The Shubert Foundation; The Harold & Mimi Steinberg Charitable Trust; Susquehanna Foundation; Tiger Baron Foundation; John A. Vassilaros & Sons, Inc.; Yorke Construction Corp.; Zubatkin Owner Representation, LLC. We also acknowledge the following individual donors (over \$250) to The 52nd Street Project:

Beth & Ray Abbott	Lilly Dobreva	Madelyn & Ronald Ignasiak	Randi Puccio
Avi & Richard Anthony	Rebecca & Richard Dresser	Jane Ira Bloom & Joe Grifasi	Ivy and Michael Rachlin
Amy Aquino & Drew McCoy	Laurel Durst	Kristen & Kevin Isola	Christopher Randolph
Sarah & Paul Ardire	Michaelene & Jonathan Durst	Andrea Johnson	Helen & Peter Randolph
Lynn Bailey & Zach Grenier	Chrysti & David Eigenberg	Robert Joy & Henry Krieger	Peter Robbins
Becky & Dylan Baker	Tara Elwin & Andre Meade	Christa Justus & Mark Linn-Baker	Anita Rogerson
Eliza Baldi & David Costabile	Robin & Steven Epstein	Samantha & Alex Kaczmarek	Lynne Rosenberg
Beth Barry and Daniel Sussman	Scott Falzone	Cynthia Kaplan & David Froelich	Debra & Russell Rosenthal
Jessica Bauman & Ben Posel	Andrew & Martin Farach-Colton	Kim & Elliot Katz	Laura & David Ross
Jane Beard & Jeffrey Davis	Wendy Federman	Valerie Kay & Bruce Graham	Olivia Sabine
Laurie Becker	Raul Fernandez	Celia Keenan-Bolger	Laura Sametz & Anton Fig
Lisa Benavides	Katie Finneran	& John Conlee	Gail Samuel & William Christian
& Tim Blake Nelson	& Darren Goldstein	Jacqueline Knobbe	Lenora & Steven Satin
Emily Benton-Morgan	Barbara & Richard Fontaine	Mary Kong & Sol Reischer	Deb Savo
& John Morgan	Andrew Fox	Ellen Kroll	Brian Sawyer
Gavin Berger & Craig Berggren	Lindsay Fram & Mason Pettit	Doug Lambert	Karin & Tom Schall
Judy & Sam Berger	Alison Fraser & Steven Pavlakis	Richard Langan	Priya Sehgal
Elizabeth & Eric Berman	Patrice & Louis Friedman	Frances & Fred Langbecker	Nikki & John Sette
Susan Beshel	Sally Froelich	Geraldine & Ray Larson	Sylvia Shepard & Willy Holtzman
Francine Bizar	Janice Gabrielove	Jené LeBlanc & Willie Reale	Maggie Siff & Paul Ratliff
Lewis Black	& Michael Dirzulaitis	Cindy & Richard Leibovitch	Valerie Simmons-Miller
Matthew Blank	Jeanne & Jim Gaffigan	Mickey Lemle	Jeremy Smith
Jane Bolster & Steve Wertimer	Anne & George Gagen	Mark Levine	Joan Solotar
Caitlin Bonsiewicz	Tina Galley	Sean Liebowitz	Marilyn and Barry Steiner
Buzz Bovshow	Robin Galloway	Karen Lipkind & Stuart Gelwarg	Bob Stockel
Samantha & Richard Brand	Alexandra Garrison	Fran Lora	Kim Swain
Becky Browder & Ted Neustadt	Craig Gartner	Kevin Lundquist	Jenni Swan
Iris Brown & Joe White	Rose Gasner & Larry Chertoff	Jane & Greg MacPherson	Richard Sweren
Rhett Brown	Christine Gleason & Erik Larson	Laura & Scott Malkin	Judy Taub Gold
Joel Brukner	Glen Gillen	Jonathan Marvel	April Taylor
Denise Burse	Marcia Goldberg & Paul Garrity	Frances McDormand & Joel Coen	Warren & Erica Thaler
& Peter Jay Fernandez	Robert Goldberg	Jean McKeever	Edith Thurber & Kevin O'Rourke
Kate Burton & Michael Ritchie	& Betsy MacIsaac	Josie Merck	Ron & Judy Tierney
Cathleen & Geoffrey Cantor	Nicolette Goldfarb	Noël & Joe Mihalow	Merritt Tilney & Douglas M. Kaden
Carl Capotorto	Gary Goldring	Carla & Yohan Minaya	Gail and Sam Tobias
Thomas Carr	Stephen Graham	Danielle Mindess & Robert Cohen	Melissa Toth
Gil Cass	Roberta & Butch Graves	Casey Moore	Laura Valeroso & David Seidman
Debbie & Lawrence Catena	Kimberly Grigsby	Amanda & Neal Moszkowski	Cynthia Vance-Abrams
Rachel Chanoff	Emily Grishman	Suzen Murakoshi	& Robert Abrams
Ellen Chopay	& Susan Sampliner	Jane Musky & Tony Goldwyn	Wendy vanden Heuvel
Julie Claire & Glenn Kessler	Sean Haggerty	Rona & Randy Nelson	& Brad Coley
Katie & Kelly Clark	Micheal C. Hall	Ruth Nelson	Alexandra Vassilaros
Dana & Neil Cohen	Deana & Stephen Hanson	Roseline Michael Neveling	Tracy & Chris Venezia
Judy & Larry Cohen	Susan Hasman	& Dennis Neveling	P & J Villani
Sherry Cohen	Karen Hauser & Warren Leight	Rachel & Larry Norton	Gaya Vinay
Penny Collins	Annie & David Hausmann	Margaret & Peter O'Brien	Mary Pat Walsh
Kevin Confoy	Helen Hausmann	Lori O'Connor	Tracy Wan & Carl Creager
Kamille Cooper	Jessica Hecht & Adam Bernstein	Carol Ochs & Bruce MacVittie	Sharon Washington
Veanne Cox	Helen & Patrick Herssens	Jacki Ochs & Jan Kroeze	Ellen West & Evan Newmark
Liz & Patrick Crotty	Amy Herzig	Beth & Bob Ollwerther	Vicki & Mark Whatley
Billy Crudup	Josie Holtzman	Steve Olsen	Eric Wiedelman
Gillian Curry	& Isaac Kestenbaum	F. Richard Pappas	Alex Wiener
Cathy Dantchik	Katy Homans & Patterson Sims	Arthur Pearsall	Zia & Victor Williams
Patrice Delcasino	Rainn Huffman	Felicity Huffman	Rainn Wilson
& William Curran	& William H. Macy	Kerry Pfingst & Russell Dodson	Lilah & Jeffrey Wise
Carolyn DeSena	Lynda Hughes	Elizabeth & Ryan Porter	Carole Yass
Kim & Jordan Dickstein	Scott Hunter	Sue Poulin	Janine & Jeffrey Yass

**THE 52ND STREET PROJECT PRESENTS**

# WATCH THIS!

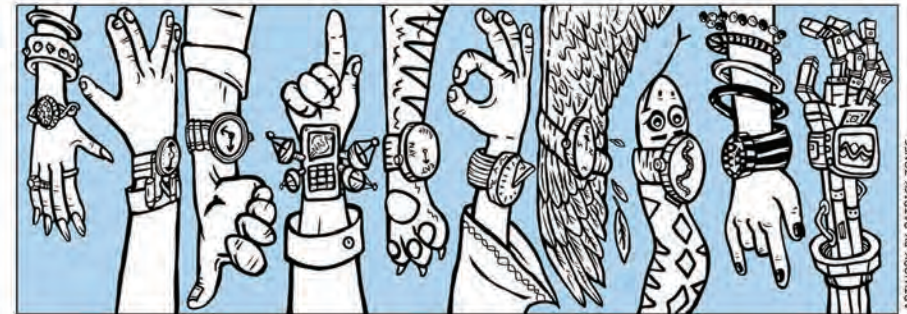

ARTWORK BY PATRICK JONES

## 10 TIME PIECES

**THE 2019 BLOCK ISLAND ONE-ON-ONES**

**FRIDAY,  
AUGUST 2  
7:30 P.M.**



**SATURDAY,  
AUGUST 3  
7:30 P.M.**



**SUNDAY,  
AUGUST 4  
3:00 P.M.**

**THE FIVE ANGELS THEATER**

# WATCH THIS! 10 TIME PIECES

The Annual Block Island One-on-Ones - Aug. 2-4 at the Five Angels Theater

## THE 52ND STREET PROJECT STAFF

- Kat Almirañez, Associate Artistic Director
- Ahmed Attia, Development Associate\*
- George Babiak, Director of Design and Production
- Liz Bell, Clinical Consultant
- Jasmine Correa, Office Manager\*
- Kali Crandall, Development Director
- Natalie Hirsch, Artistic Director
- Garrett Kim, Program Director
- Carol Ochs, Executive Director
- Gus Rogerson, Producing Director
- Sayantee Sahoo, Production Manager
- John Sheehy, Director of Institutional Advancement
- Johanna Vidal, Director of Education\*
- Caylyn Wan-Creager, Education Associate
- Iris A. Brown, Graphic Design Consultant

*\*Project Alumni*

### Interns:

Ruby Berlin, Gabby Rente, Isabella Waldron

### Teen Employees:

Receptionists: Rodery Rosario, Rosneyri Rosario  
Ushers: Darby O'Donnell, Matthew Orozco, Tiniyah Powell

## “WATCH THIS” Production Staff

### Composer/Music Director

Kim Sherman

### Set Designer

Burke Brown

### Lighting Designer

Greg MacPherson

### Costume Designer

Carisa Kelly

### Sound Designer

Alicia Moeller

### Stage Manager

Caylyn Wan-Creager

### Projection Designs

George Babiak and The  
52nd Street Project Projection Archive

### Prop Design and Construction

George Babiak, Ruby Berlin, Gabby Rente,  
and Isabella Waldron

### Backstage Crew

Justin Bannister, Maria Martinez,  
Gabby Rente, Isabella Waldron

### House Management

Carol Ochs, John Sheehy

### Flyer/Program Art

Patrick Jones

### Chefs

Martha Velie-Gass  
and Pat Ritter

### Teen Counselor

Justin Bannister



The One-on-One Program is made possible with public funds from The New York State Council on the Arts, a state agency, and the New York City Department of Cultural Affairs. The 52nd Street Project is a member of Art/NY and Theatre Communications Group (TCG), the national organization for the American theatre.

## COOL STUFF ON SALE IN THE LOBBY!

- Fabulous Flyer Bars ..... \$2.50  
*and featuring Shel Silverstein's "Fivey and Twoey" logo:*
- Two-tone Project Hoodie ..... \$40.00
- Monotone Project Hoodie ..... \$30.00
- Crew-neck sweatshirts ..... \$20.00
- Project Caps ..... \$20.00
- Project T-shirts ..... \$12.00/\$20.00
- Project Mugs ..... \$5.00
- Project Notebook ..... \$5.00
- Project Pencil 3-pack ..... \$1.00

Thank you for coming to **WATCH THIS!** If you are not on our mailing list, you can join on-line at [www.52project.org](http://www.52project.org). If you're interested in being a volunteer, fill out the form below and hand it to one of our staffers in the lobby.

### YES, I AM INTERESTED IN BEING INVOLVED! HERE IS MY CONTACT INFORMATION:

08/19

NAME \_\_\_\_\_

ADDRESS \_\_\_\_\_

CITY \_\_\_\_\_

STATE \_\_\_\_\_

ZIP \_\_\_\_\_

HOME PHONE \_\_\_\_\_

DAYTIME OR MOBILE PHONE \_\_\_\_\_

E-MAIL ADDRESS \_\_\_\_\_

MY OCCUPATION \_\_\_\_\_

MY HOBBIES \_\_\_\_\_

WANT TO BE GREEN AND SAVE THE PROJECT MONEY ON POSTAGE?  
CHECK THIS BOX TO RECEIVE OUR NOTICES EXCLUSIVELY VIA E-MAIL.

If you would like to mail this (and you're always welcome to enclose a tax-deductible contribution), you can send it to:

**The 52nd Street Project**  
789 10th Avenue  
New York, NY 10019.

Or you can fax it to (212) 333-5598.

## COMING UP ON THE FIVE ANGELS STAGE:



### PROJECT EXCHANGE: WIN PLAYMAKING

**A Special Show  
at a Special Time**

**MONDAY,  
AUGUST 19, 6PM**

A staged reading of our latest program. Over the past month, The 52nd Street Project has been running its intensive Playmaking program with Win, bringing Playmaking to the children in their organization. Come see the results of the kids' work presented in semi-staged readings on Monday, August 19 at 6 p.m., here at our Five Angels Theater. Admission is free, as always. Reservations can be made at [www.52project.org](http://www.52project.org)



The reverse of the One-on-Ones!  
Project members write plays for themselves  
and an adult partner to perform together.

October 18-20 right here at  
**THE FIVE ANGELS THEATER**



#### KEEP AN EYE OF ZEPHYR OUT FOR INTERNS!

If you know of any college or graduate students who might enjoy working with us, playing with us, and going on trips with us for a semester, please have them contact Caylyn Wan-Creager at [creager@52project.org](mailto:creager@52project.org).

### The 52nd Street Project Board of Directors

Lisa Benavides	Valerie Kay
Rachel Chanoff	Noël Mihalow
Cathy Dantchik, co-chair	Roseline Michael Neveling
Carolyn DeSena	Carol Ochs
Wendy Ettinger, chair emeritus	Willie Reale, founder
Louis P. Friedman, co-chair	Gus Rogerson
Alexandra Gersten-Vassilaros	Shirley Rumierk, alumni member
Robert Goldberg	José Soto, Jr., alumni member
Stephen Graham, chair emeritus	Merritt Tilney
Annie Hausmann	Wendy vanden Heuvel
Natalie Hirsch	Mark Whatley

---

#### What's Going On Here?

The 52nd Street Project is a non-profit organization that brings children from the Hell's Kitchen neighborhood together with professional theater artists to create original theater. **WATCH THIS!** is a production of our One-on-One program, which is designed to give children the opportunity to go away for one-week stays in the country and enjoy the undivided attention of a professional theater artist who serves as friend, mentor, and collaborator.

---

#### In-Kind Contributions

Abbeville Press; Ambassador Theatre Group; Avi & Richard Anthony; Ardesia; Kate & Andy Bellin; Lewis Black; Iris A. Brown Design; Cellar 53; William Curran, A Curran Affair; The Daily Show's Trevor Noah; Michael Dorf & City Winery; Dormify.com; Sean Feeney, MISI; Haru Restaurant of Hell's Kitchen; Celia Keenan-Bolger; Karen Kowgios of Withum, Smith, & Brown; Pamela Liebman, The Corcoran Group; Charlie Marshall; Stella McCartney; Michter's Distillery, LLC Noël Mihalow & Prime Films; The Neveling Family; Lauren Friedman, Pharma/Omni Printing; Winston Rodney Photography; Signature Bank; SHOWTIME; The Surrey; Merritt Tilney & Doug Kaden; Vassilaros & Sons Coffee Company; Alex Vassilaros & The Vassilaros Family; The Watkins Company; Vicki & Mark Whatley and Paul, Rifkind, Wharton, & Garrison LLP.

---

#### Special Thanks

Our Host Families - Socha Cohen; Cathy Joyce and Nigel Grindley, Katy Homans and Patterson Sims; Sam & Kate Bird; Josie Merck; Virginia Dare; Susan Hagedorn; Susan & Keith Stover, and our magnanimous headquarters host Carl Kaufmann. Sincere thanks to our chefs Martha Velie-Gass & Pat Ritter; and McQuade's Marketplace. Robbie Brown; Rita and Steve Draper; Glenn and Annie Hall; The Yellow Kittens; Mark Heterline & Mary Jane Balsler and the Block Island Grocery; The Block Island Times, and Kevin Roach.

## WATCH THIS! 10 TIME PIECES - ACT 1

All original music composed by Kim D. Sherman  
*Watch This! Theme Song* lyrics by John Sheehy

### SIRI, LISTEN UP

By Nina Braddock, Directed by Sarah Quigley for Tiffany Yam, age 11  
*Time suggestion: "Winter"*

Wanda ..... Tiffany Yam  
Siri ..... Sarah Quigley  
Bear ..... Cody LeRoy Wilson

*Fire Frenzy* lyrics by Nina Braddock.

### HOW ODD

Written and Directed by John Sheehy for Frankie Suero Loyola, age 12  
*Time suggestion: "Spring"*

Dr. Howard Odd ..... Frankie Suero Loyola  
Rick ..... John Sheehy

*No One is Ever Ready* lyrics by John Sheehy.

### QUITTING TIME

Written and Directed by Anne Troup for Jai-Lyzz Rodriguez, age 10  
*Time suggestion: "Quitting Time"*

Detective Fox ..... Jai-Lyzz Rodriguez  
Detective Lipsnee ..... Anne Troup  
Pigeon Man ..... Justin Bannister  
The Chef ..... Gabby Rente  
Squirrel Man ..... George Babiak  
The Mayor ..... Isabella Waldron

*So Much More* lyrics by Anne Troup.

### RITA AND STARBOT

By Alicia Moeller, Directed by Paton Ashbrook for Kaytie Gil, age 10  
*Time suggestion: "6:00 a.m."*

StarBot Simmons ..... Kaytie Gil  
Rita ..... Paton Ashbrook  
Alien Art Thief Voice/Art Olympics Announcer ..... Isabella Waldron  
Painting Competition Competitors ..... Gabby Rente, Justin Bannister

*Jetpack Time Machine* lyrics by Alicia Moeller.

### FREE AND WILDE

Written and Directed by Sam Dash for Naseem Abdul-Majeed, age 11  
*Time suggestion: "20 years from now"*

Free ..... Naseem Abdul-Majeed  
Wilde ..... Sam Dash  
Dad ..... George Babiak

*Get Up And Find Your Way* lyrics by Sam Dash

## WATCH THIS! 10 TIME PIECES - ACT 2

### THE CARTOONIST AND THE ZOO-CREEP'S DAUGHTER

Written and Directed by Molly Carden for Laila Suero Loyola, age 12  
*Time suggestion: "Midnight"*

Alma ..... Laila Suero Loyola  
Ted ..... Molly Carden  
Announcer ..... John Sheehy

*My Ice Cream on a Silver Spoon* lyrics by Molly Carden.

### BLUE MARBLE

Written and Directed by Oscar A.L. Cabrera, for John Muca, age 10  
*Time suggestion: "Lunchtime"*

Dave ..... John Muca  
Robot ..... Oscar A.L. Cabrera  
Ground Control ..... George Babiak

*Blue* lyrics by Oscar A.L. Cabrera.

### SAMMY THE SUMATRAN TIGER

By Caylyn Wan-Creager, Directed by Angelica Toledo for Denisse Xolocotzi, age 12  
*Time suggestion: "Yesterday"*

Sammy ..... Denisse Xolocotzi  
Ricky, a hunter ..... Angelica Toledo  
Tessa the Cow ..... Justin Bannister  
Mayor Kuhio ..... Gabby Rente  
Poachers ..... Oscar A.L. Cabrera, George Babiak  
World Wildlife Team Employee ..... Isabella Waldron  
Tiger Family ..... Gabby Rente, Justin Bannister

*Two Fish in the Sea* lyrics by Caylyn Wan-Creager.

### TRASH DAY

Written and Directed by Cody Leroy Wilson for Ivan Garcia, age 11  
*Time suggestion: "1885"*

Steven ..... Ivan Garcia  
Scruff ..... Cody LeRoy Wilson  
Garbage Dragon ..... Justin Bannister

*You're not a Piece of Trash* lyrics by Cody Leroy Wilson.

### REIGN OF ERROR

By George Babiak, Directed by Marielle Young for Maria Alcides, age 11  
*Time suggestion: "The distant future"*

Queen Millicent ..... Maria Alcides  
Bella, Chancellor to Millicent ..... Marielle Young  
Empress Isadora ..... Marielle Young  
Morgan, Isadora's Viceroy ..... Maria Alcides  
The Rabble ..... The Crew

*I've Got Your Back* lyrics by George Babiak.

### The 52nd Street Project Staff

Kat Almirañez, Associate Artistic Director  
 Ahmed Attia, Development Associate\*  
 George Babiak, Director of Design and Production  
 Liz Bell, Clinical Consultant  
 Jasmine Correa, Office Manager\*  
 Kali Crandall, Development Director  
 Caylyn Creager, Education Associate  
 Natalie Hirsch, Artistic Director  
 Garrett Kim, Program Director  
 Carol Ochs, Executive Director  
 Gus Rogerson, Producing Director  
 Sayantee Sahoo, Production Manager  
 John Sheehy, Director of Institutional Advancement  
 Johanna Vidal, Director of Education\*  
 Iris A. Brown, Graphic Design Consultant  
 \*Project Alumni

### Ushers

Kai Ceniza, Nicole Quiles

### The 52nd Street Project Board of Directors

Lisa Benavides	Valerie Kay
Rachel Chanoff	Noël Mihalow
Cathy Dantchik, co-chair	Roseline Michael Neveling
Carolyn DeSena	Carol Ochs
Wendy Ettinger, chair emeritus	Willie Reale, founder
Louis P. Friedman, co-chair	Gus Rogerson
Alexandra Gersten-Vassilaros	Shirley Rumierk, alumni member
Robert Goldberg	José Soto, Jr., alumni member
Stephen Graham, chair emeritus	Merritt Tilney
Annie Hausmann	Wendy vanden Heuvel
Natalie Hirsch	Mark Whatley



**THE 52ND STREET  
PROJECT EXCHANGE:**

**WIN  
PLAYMAKING SHOW**

MONDAY,  
AUGUST 19, 2020, 6:00 PM  
THE FIVE ANGELS THEATER  
789 10th Avenue

The 52nd Street Project (aka, The Project) is a non-profit arts organization that brings children from the Hell’s Kitchen neighborhood together with professional artists to create original art.

Project Exchange is a recent initiative of The 52nd Street Project. With the help of artists and partner service organizations, Project Exchange reaches out beyond Hell’s Kitchen to communities across New York. As it grows, we aim to bring Playmaking and other Project programs to kids living in different pockets of the city. The plays you will see tonight are the fruit of this Summer’s Playmaking Class with Win. We hope you enjoy our presentation.

### THE PROJECT EXCHANGE TEAM

Playmaking Director ..... Joanna Gurin  
 Playmaking Associate ..... Kerry Warren  
 Teen Associate ..... Sevan Asencio  
 Lighting Designer..... Sayantee Sahoo  
 Costumes ..... Kat Almirañez  
 Stage Manager ..... Margaret Gleberman  
 Backstage Crew ..... Sevan Ascencio, Chyanne Peña

### PLAYMAKING MENTORS

Annabelle Cousins, Eliza Huberth,  
 Morgan McGuire, Paola Soto,  
 and Angelica Toledo



Project Exchange is made possible with public funds from The New York State Council on the Arts, a state agency, and the New York City Department of Cultural Affairs. The 52nd Street Project is a member of Art/NY and Theatre Communications Group (TCG), the national organization for the American theatre.



# THE 52ND STREET PROJECT EXCHANGE: WIN PLAYMAKING SUMMER 2019

## The Bella and Daisey Story

by Violet. Directed by Morgan McGuire

Bella.....Naomi Lorrain  
Daisey.....Arielle Goldman  
Cashier .....Biko Eisen-Martin  
Mom/Waiter .....Morgan McGuire  
Waiter

★★★

## A.J.A

by Kaiden. Directed by Paola Soto

Jacob.....Jose Joaquin Perez  
Ariana .....Margaret Odette  
Allison.....Meredith Garretson

★★★

## Best Friends

by Linnaysh. Directed by Marchánt Davis

Tom.....Bjorn DuPaty  
Sam.....Bill Camp  
Sub-Teacher/Kid.....Marchánt Davis

★★★

## The Elements

by Jaiden. Directed by Kerry Warren

Ice.....Biko Eisen-Martin  
Shadow.....Naomi Lorrain  
Emma .....Arielle Goldman

★★★

## Take The L

by Jaydha. Directed by Eliza Huberth

Stink.....Kyle Cameron  
Isabella .....Eliza Huberth  
Elizabeth.....Simone Recasner

## I Was Born in Queens

by Isaiah. Directed by Marchánt Davis

Mr. Big .....Bjorn DuPaty  
Mr. Little.....Bill Camp

★★★

## Lego World and Power World

by Jojo. Directed by Morgan McGuire

Ashley.....Naomi Lorrain  
Natalie .....Arielle Goldman  
Professor Agent.....Biko Eisen-Martin

★★★

## Hungry Hunter

by Taliyah. Directed by John Sheehy

Father .....Kyle Cameron  
Baby Hunter.....Simone Recasner  
Police/Mother.....Eliza Huberth

★★★

## Layla and Her Not So Good Day at School

by Neyshaliz. Directed by Paola Soto

Layla .....Margaret Odette  
Jazzy .....Meredith Garretson  
Bully.....Jose Joaquin Perez  
Principal.....Kerry Warren  
Mom.....Paola Soto

★★★

## SPECIAL THANKS

Beetlejuice the Musical, Bespoke Theatricals,  
Rosa Boone, Danielle Bridges, Jesse Gamoran,  
Jenny Gersten, Mark Kaufman, Kevin McCormick,  
Sasha Njoku, Diana Santos, Danielle Smith,  
and Carmen Paez.

The 52nd Street Project gratefully acknowledges the support of the following foundations & corporations: Carol M. & Stephen E. Canter Family Foundation; Cantor Fitzgerald Relief Fund; Carnegie Corporation of New York; The CLAWS Foundation; Consolidated Edison; Dawkins Family Foundation; Dramatists Play Service, Inc.; The Jean & Louis Dreyfus Foundation; The Education Foundation of America; Flexis Capital, LLC; Goldman Sachs The Horace W. Goldsmith Foundation; The Stephen P. Hanson Foundation; Heisman Trophy Trust; The William and Flora Hewlett Foundation; Howard Ashman Trust for Theater Arts Lemle Pictures, Inc.; The Lotos Foundation; Frederick Loewe Foundation; The Rona & Randolph M. Nelson Foundation; Newman's Own; Seller-Lehrer Family Foundation; The Stavros Niarchos Foundation; Par Plumbing Co., Inc.; The Pinkerton Foundation; Sawyer | Berson Architecture & Landscape Architecture; The Morris and Alma Schapiro Fund; Showtime Networks; The Shubert Foundation; The Harold & Mimi Steinberg Charitable Trust; Susquehanna Foundation; Tiger Baron Foundation; John A. Vassilaros & Sons, Inc.; Yorke Construction Corp.; Zubatkin Owner Representation, LLC. We also acknowledge the following individual donors (over \$250) to The 52nd Street Project:

- |                               |                                 |                                  |                                   |
|-------------------------------|---------------------------------|----------------------------------|-----------------------------------|
| Beth & Ray Abbott             | Lilly Dobreva                   | Madelyn & Ronald Ignasiak        | Randi Puccio                      |
| Avi & Richard Anthony         | Rebecca & Richard Dresser       | Jane Ira Bloom & Joe Grifasi     | Ivy and Michael Rachlin           |
| Amy Aquino & Drew McCoy       | Laurel Durst                    | Kristen & Kevin Isola            | Christopher Randolph              |
| Sarah & Paul Ardire           | Michaelene & Jonathan Durst     | Andrea Johnson                   | Helen & Peter Randolph            |
| Lynn Bailey & Zach Grenier    | Chrysti & David Eigenberg       | Robert Joy & Henry Krieger       | Peter Robbins                     |
| Becky & Dylan Baker           | Tara Elwin & Andre Meade        | Christa Justus & Mark Linn-Baker | Anita Rogerson                    |
| Eliza Baldi & David Costabile | Robin & Steven Epstein          | Samantha & Alex Kaczmarek        | Lynne Rosenberg                   |
| Beth Barry and Daniel Sussman | Scott Falzone                   | Cynthia Kaplan & David Froelich  | Debra & Russell Rosenthal         |
| Jessica Bauman & Ben Posel    | Andrew & Martin Farach-Colton   | Kim & Elliot Katz                | Laura & David Ross                |
| Jane Beard & Jeffrey Davis    | Wendy Federman                  | Valerie Kay & Bruce Graham       | Olivia Sabine                     |
| Laurie Becker                 | Raul Fernandez                  | Celia Keenan-Bolger              | Laura Sametz & Anton Fig          |
| Lisa Benavides                | Katie Finneran                  | & John Conlee                    | Gail Samuel & William Christian   |
| & Tim Blake Nelson            | & Darren Goldstein              | Jacqueline Knobbe                | Lenora & Steven Satin             |
| Emily Benton-Morgan           | Barbara & Richard Fontaine      | Mary Kong & Sol Reischer         | Deb Savo                          |
| & John Morgan                 | Andrew Fox                      | Ellen Kroll                      | Brian Sawyer                      |
| Gavin Berger & Craig Berggren | Lindsay Fram & Mason Pettit     | Doug Lambert                     | Karin & Tom Schall                |
| Judy & Sam Berger             | Alison Fraser & Steven Pavlakis | Richard Langan                   | Priya Sehgal                      |
| Elizabeth & Eric Berman       | Patrice & Louis Friedman        | Frances & Fred Langbecker        | Nikki & John Sette                |
| Susan Beshel                  | Sally Froelich                  | Geraldine & Ray Larson           | Sylvia Shepard & Willy Holtzman   |
| Francine Bizar                | Janice Gabrielove               | Jené LeBlanc & Willie Reale      | Maggie Siff & Paul Ratliff        |
| Lewis Black                   | & Michael Dirzulaitis           | Cindy & Richard Leibovitch       | Valerie Simmons-Miller            |
| Matthew Blank                 | Jeannie & Jim Gaffigan          | Mickey Lemle                     | Jeremy Smith                      |
| Jane Bolster & Steve Wertimer | Anne & George Gagen             | Mark Levine                      | Joan Solotar                      |
| Caitlin Bonsiewicz            | Tina Galley                     | Sean Liebowitz                   | Marilyn and Barry Steiner         |
| Buzz Boyshow                  | Robin Galloway                  | Karen Lipkind & Stuart Gelwarg   | Bob Stockel                       |
| Samantha & Richard Brand      | Alexandra Garrison              | Fran Lora                        | Kim Swain                         |
| Becky Browder & Ted Neustadt  | Craig Gartner                   | Kevin Lundquist                  | Jenni Swan                        |
| Iris Brown & Joe White        | Rose Gasner & Larry Chertoff    | Jane & Greg MacPherson           | Richard Sweren                    |
| Rhett Brown                   | Christine Gleason & Erik Larson | Laura & Scott Malkin             | Judy Taub Gold                    |
| Joel Brukner                  | Glen Gillen                     | Jonathan Marvel                  | April Taylor                      |
| Denise Burse                  | Marcia Goldberg & Paul Garrity  | Frances McDormand & Joel Coen    | Warren & Erica Thaler             |
| & Peter Jay Fernandez         | Robert Goldberg                 | Jean McKeever                    | Edith Thurber & Kevin O'Rourke    |
| Kate Burton & Michael Ritchie | & Betsy MacIsaac                | Josie Merck                      | Ron & Judy Tierney                |
| Cathleen & Geoffrey Cantor    | Nicolette Goldfarb              | Noël & Joe Mihalow               | Merritt Tilney & Douglas M. Kaden |
| Carl Capotorto                | Gary Goldring                   | Carla & Yohan Minaya             | Gail and Sam Tobias               |
| Thomas Carr                   | Stephen Graham                  | Danielle Mindess & Robert Cohen  | Melissa Toth                      |
| Gil Cass                      | Roberta & Butch Graves          | Casey Moore                      | Laura Valeroso & David Seidman    |
| Debbie & Lawrence Catena      | Kimberly Grigsby                | Amanda & Neal Moszkowski         | Cynthia Vance-Abrams              |
| Rachel Chanoff                | Emily Grishman                  | Suzen Murakoshi                  | & Robert Abrams                   |
| Ellen Chopay                  | & Susan Sampliner               | Jane Musky & Tony Goldwyn        | Wendy vanden Heuvel               |
| Julie Claire & Glenn Kessler  | Sean Haggerty                   | Rona & Randy Nelson              | & Brad Coley                      |
| Katie & Kelly Clark           | Micheal C. Hall                 | Ruth Nelson                      | Alexandra Vassilaros              |
| Dana & Neil Cohen             | Deana & Stephen Hanson          | Roseline Michael Neveling        | Tracy & Chris Venezia             |
| Judy & Larry Cohen            | Susan Hasman                    | & Dennis Neveling                | P & J Villani                     |
| Sherry Cohen                  | Karen Hauser & Warren Leight    | Rachel & Larry Norton            | Gaya Vinay                        |
| Penny Collins                 | Annie & David Hausmann          | Margaret & Peter O'Brien         | Mary Pat Walsh                    |
| Kevin Confoy                  | Helen Hausmann                  | Lori O'Connor                    | Tracy Wan & Carl Creager          |
| Kamille Cooper                | Jessica Hecht & Adam Bernstein  | Carol Ochs & Bruce MacVittie     | Sharon Washington                 |
| Yeanne Cox                    | Helen & Patrick Herssens        | Jacki Ochs & Jan Kroeze          | Ellen West & Evan Newmark         |
| Liz & Patrick Crotty          | Amy Herzig                      | Beth & Bob Ollwerther            | Vicki & Mark Whatley              |
| Billy Crudup                  | Josie Holtzman                  | Steve Olsen                      | Eric Wiedelman                    |
| Gillian Curry                 | & Isaac Kestenbaum              | F. Richard Pappas                | Alex Wiener                       |
| Cathy Dantchik                | Katy Homans & Patterson Sims    | Arthur Pearsall                  | Zia & Victor Williams             |
| Patrice Delcasino             | Felicity Huffman                | Courtney & Lowell Pettit         | Rainn Wilson                      |
| & William Curran              | & William H. Macy               | Kerry Pfingst & Russell Dodson   | Lilah & Jeffrey Wise              |
| Carolyn DeSena                | Lynda Hughes                    | Elizabeth & Ryan Porter          | Carole Yass                       |
| Kim & Jordan Dickstein        | Scott Hunter                    | Sue Poulin                       | Janine & Jeffrey Yass             |

List current as of Aug. 2, 2019

The 52nd Street Project Presents

# Heard It Through The Grapevine!

8 plays written by young people and performed by the authors with adult partners.

## The Surprising Plays

The 2019 Playback Show

Friday, Oct. 18 at 7:30 p.m.

Saturday, Oct. 19 at 7:30 p.m.

Sunday, Oct. 20 at 3:00 p.m.

THE FIVE ANGELS THEATER

ARTWORK BY HEATHER GOBBÉE

## HEARD IT THROUGH THE GRAPEVINE: THE SURPRISING PLAYS

The Annual Playback Shows - Oct. 18-20, 2019 at the Five Angels Theater

### The 52nd Street Project Staff

Kat Almirañez, Associate Artistic Director  
Ahmed Attia, Development Associate\*  
George Babiak, Director of Design and Production  
Liz Bell, Clinical Consultant  
Jasmine Correa, Office Manager\*  
Kali Crandall, Development Director  
Natalie Hirsch, Artistic Director  
Garrett Kim, Program Director  
Carol Ochs, Executive Director  
Gus Rogerson, Producing Director  
Sayantee Sahoo, Production Manager  
John Sheehy, Director of Institutional Advancement  
Johanna Vidal, Director of Education\*  
Caylyn Wan-Creager, Education Associate  
Iris A. Brown, Graphic Design Consultant

*\*Project Alumni*

#### Interns:

Alex Fernandez, Evan Schultz, Ana Soto

#### Teen Employees:

Concessions: Karen Tineo and Chyanne Peña

Ushers: Sasha Davis, Beyonce Thomas, and Sevan Asencio

#### “GRAPEVINE” Production Staff

##### Composer/Music Director

Richard C. Walter

##### Set Designer

Burke Brown

##### Lighting Designer

Elizabeth Schweitzer

##### Costume Designer

Michael Piatkowski

##### Sound Designer

Kaylie Groff

##### Stage Manager

Margaret Gleberman

##### Projection Designs

George Babiak and  
The 52nd Street Project Projection Archive

##### Prop Design and Construction

George Babiak

##### Backstage Crew

Alex Fernandez, Ana Soto,  
Sofia Santoni

##### House Management

Carol Ochs,  
John Sheehy

##### Flyer/Program Art

Heather Gobbée

##### Chefs

John Sheehy  
and Liz Bell

##### Teen Counselors

Sofia Santoni

## COOL STUFF ON SALE IN THE LOBBY!

Fabulous Flyer Bars ..... \$2.50  
*and featuring Shel Silverstein's "Fivey and Twoey" logo:*  
Two-tone Project Hoodie ..... \$40.00  
Monotone Project Hoodie ..... \$30.00  
Crew-neck sweatshirts ..... \$20.00  
Project Caps ..... \$20.00  
Project T-shirts ..... \$12.00/\$20.00  
Project Mugs ..... \$5.00  
Project Notebook ..... \$5.00  
Project Pencil 3-pack ..... \$1.00

Thank you for coming to **HEARD IT THROUGH THE GRAPEVINE**. If you are not on our mailing list, you can join on-line at [www.52project.org](http://www.52project.org). If you're interested in being a volunteer, fill out the form below and hand it to one of our staffers in the lobby.

### YES, I AM INTERESTED IN BEING INVOLVED! HERE IS MY CONTACT INFORMATION:

10/19

NAME

ADDRESS

CITY

STATE

ZIP

HOME PHONE

DAYTIME OR MOBILE PHONE

E-MAIL ADDRESS

MY OCCUPATION

MY HOBBIES

WANT TO BE GREEN AND SAVE THE PROJECT MONEY ON POSTAGE?  
CHECK THIS BOX TO RECEIVE OUR NOTICES EXCLUSIVELY VIA E-MAIL.

If you would like to mail this (and you're always welcome to enclose a tax-deductible contribution), you can send it to:

**The 52nd Street Project**  
789 10th Avenue  
New York, NY 10019.

Or you can fax it to (212) 333-5598.



The Playback Program is made possible with public funds from The New York State Council on the Arts, a state agency, and the New York City Department of Cultural Affairs. The 52nd Street Project is a member of Art/NY and Theatre Communications Group (TCG), the national organization for the American theatre.

## COMING UP SOON AT THE PROJECT!

### ONE NIGHT, TWO EVENTS!



THE SHOW!



THE BENEFIT PARTY!



## The 52nd Street Project Board of Directors

Lisa Benavides	Noël Mihalow
Rachel Chanoff	Roseline Michael Neveling
Cathy Dantchik, co-chair	Carol Ochs
Carolyn DeSena	Willie Reale, founder
Wendy Ettinger, chair emeritus	Gus Rogerson
Louis P. Friedman, co-chair	Shirley Rumierk, alumni member
Alexandra Gersten-Vassilaros	José Soto, Jr., alumni member
Robert Goldberg	Merritt Tilney
Stephen Graham, chair emeritus	Wendy vanden Heuvel
Natalie Hirsch	Mark Whatley
Valerie Kay	

### What's Going On Here?

The 52nd Street Project is a non-profit organization that brings children from the Hell's Kitchen neighborhood together with professional theater artists to create original theater. HEARD IT THROUGH THE GRAPEVINE is a production of our Playback program, in which kid actor/playwrights write plays for themselves and adult actor/director partners. Everyone ventured to the Hamptons for a rehearsal retreat over the Columbus Day weekend. All of the kids involved are veterans of the Playmaking classes which were adapted for the Project by Daniel Judah Sklar from his book *Playmaking: Children Writing and Performing Their Own Plays*.

### In-Kind Contributions

Abbeville Press; Ambassador Theatre Group; Avi & Richard Anthony; Ardesia; Kate & Andy Bellin; Lewis Black; Iris A. Brown Design; Cellar 53; William Curran, A Curran Affair; The Daily Show's Trevor Noah; Michael Dorf & City Winery; Dormify.com; Sean Feeney, MISI; Haru Restaurant of Hell's Kitchen; Celia Keenan-Bolger; Karen Kowgios of Withum, Smith, & Brown; Pamela Liebman, The Corcoran Group; Charlie Marshall; Stella McCartney; Michter's Distillery, LLC Noël Mihalow & Prime Films; The Neveling Family; Lauren Friedman, Pharma/Omni Printing; Winston Rodney Photography; Signature Bank; SHOWTIME; The Surrey; Merritt Tilney & Doug Kaden; Vassilaros & Sons Coffee Company; Alex Vassilaros & The Vassilaros Family; The Watkins Company; Vicki & Mark Whatley and Paul, Rifkind, Wharton, & Garrison LLP.

### Special Thanks

We're extremely grateful to board member Alex Gersten-Vassilaros for allowing us to use her home as our headquarters on our rehearsal trip to the Hamptons. Huge thanks also go to Board Co-Chair Louis Friedman and his wife Patrice Friedman for hosting some adults in their exquisite Water Mill cottage, and to Cathy Dantchik, who hosted our girls and even some adults at her beautiful house in Bridgehampton.

## HEARD IT THROUGH THE GRAPEVINE - ACT 1

All original music composed by Richard C. Walter

### ONLY TWO WEEKS?

Written by Nyla Blake Soden, age 12  
Director/Dramaturge: Alexandra Lemus

Jasmine, aka J.J. .... Nyla Blake Soden  
Paula ..... Alexandra Lemus  
Voice of Aria ..... Ana Soto  
Guy Records ..... Garrett David Kim

*My Life* lyrics by Nyla Blake Soden

### THE LIGHTNING NINJA'S QUARREL: THE ULTIMATE BATTLE

Written by Aengus O'Donnell, age 13  
Director/Dramaturge: Jimmy Kenna

Luck ..... Aengus O'Donnell  
Ash ..... Jimmy Kenna

*Memory* lyrics by Aengus O'Donnell

### NEW BESTIES

Written by Jade Johnson, age 12  
Director/Dramaturge: Daiva Deupree

Kajmah ..... Jade Johnson  
Pricilla ..... Daiva Deupree  
Orphanage Lady ..... Ana Soto  
Alvina, Pricilla's mom ..... Sofia Santoni

*Besties* lyrics by Jade Johnson

### BOUNTY BROS

Written by Gilbert Rosario, age 13  
Director/Dramaturge: Jose-Maria Aguila

Pubert, a bounty hunter ..... Gilbert Rosario  
Wilbert, another bounty hunter ..... Jose-Maria Aguila  
Bartender ..... Sofia Santoni  
The Bayonne Bandit ..... George Babiak

*Together Forever* lyrics by Gilbert Rosario



## HEARD IT THROUGH THE GRAPEVINE - ACT 2

### RAPPERS AND POLICE OFFICERS ALWAYS GO TOGETHER

Written by Carlos Jimenez, age 13  
Director/Dramaturge: KeiLyn Durren Jones

Lil Dead ..... Carlos Jimenez  
Officer Spicy ..... KeiLyn Durrel Jones  
Driver ..... Alex Fernandez

*Officer Spicy's Rap and Enemies to Friends* lyrics by Carlos Jimenez

### A MOON BETWEEN OPINIONS

Written by Amari Dubose, age 13  
Director/Dramaturge: Korey Jackson

Albatross, a yoga instructor ..... Amari Dubose  
Tim, a businessman ..... Korey Jackson  
Yoga Students/Film Crew ..... The Crew

*All Night* lyrics by Amari Dubose

### CUCARACHA

Written by Nikolai Alvarez, age 12  
Director/Dramaturge: Jose Duran

Spicy Stuff ..... Nikolai Alvarez  
Coo J ..... Jose Duran  
Adam, a construction worker ..... Gage Simmons  
Detective ..... George Babiak  
Inmates ..... The Crew

*We Gonna Run* lyrics by Nikolai Alvarez

### COLLEGE ADVENTURES

Written by Amirah Hancock, age 13  
Director/Dramaturge: Arielle Goldman

Paige Wheeler ..... Amirah Hancock  
Fall Jordan ..... Arielle Goldman  
Pilot's Voice ..... KeiLyn Durrel Jones  
Passengers ..... Sofia Santoni, Ana Soto, George Babiak

*I See* lyrics by Amirah Hancock

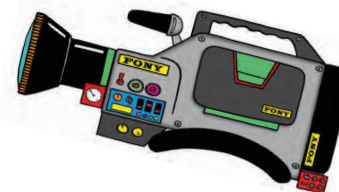

The 52nd Street Project is a non-profit community-based arts organization that brings children from the Hell's Kitchen neighborhood together with professional artists to create original art. The Songmaking program partners five 52nd Street Project kids with adult composers to create original songs. Over the seven weeks of Songmaking, led by Avi Amon and Program Director Garrett David Kim, these young lyricists explore how their own words and ideas fit together with their composer's music to create songs. Near the end of the program, we bring in a company of singers to perform the completed songs, and share them with an audience.

### 52nd Street Project Staff

Kat Almirañez, Associate Artistic Director  
 Ahmed Attia, Development Associate\*  
 George Babiak, Director of Design and Production  
 Liz Bell, Clinical Consultant  
 Jasmine Correa, Office Manager\*  
 Kali Crandall, Development Director  
 Natalie Hirsch, Artistic Director  
 Garrett Kim, Program Director  
 Carol Ochs, Executive Director  
 Gus Rogerson, Producing Director  
 Sayantee Sahoo, Production Manager  
 John Sheehy, Director of Institutional Advancement  
 Johanna Vidal, Director of Education\*  
 Caylyn Wan-Creager, Education Associate  
 Iris A. Brown, Graphic Design Consultant  
*\*Project Alumni*

### Interns:

Alex Fernandez, Evan Schultz, Ana Soto

### Teen Employees:

Concessions: Jayleen Velez and Rosneyri Rosario  
 Ushers: Rodery Rosario and Lakshmi DeJesus

### The 52nd Street Project Board of Directors

Lisa Benavides	Noël Mihalow
Rachel Chanoff	Roseline Michael Neveling
Cathy Dantchik, co-chair	Carol Ochs
Carolyn DeSena	Willie Reale, founder
Wendy Ettinger, chair emeritus	Gus Rogerson
Louis P. Friedman, co-chair	Shirley Rumierk, alumni member
Alexandra Gersten-Vassilaros	José Soto, Jr., alumni member
Robert Goldberg	Merritt Tilney
Stephen Graham, chair emeritus	Wendy vanden Heuvel
Natalie Hirsch	Mark Whatley
Valerie Kay	

### 2019 Big Kids Committee Members

Avi Taussig Anthony, Ashley Baer, Michaela Culver, Alexandra Garrison, Ashley Henry, Samantha Kaczmarek, Ashley Marie Ortiz, Michael Propster, Jenni Swan, and Kerry Warren.

## THE 52ND STREET PROJECT PRESENTS



ART BY BRYANNA OHENE KARI-KARI

# TAKE IT FROM THE TOP

## THE 2019 SONGMAKING CONCERT

15 original songs written by young people and composed and performed by adult musicians and singers.

Songmaking Directors:

Avi A. Amon and Garrett David Kim

Friday, October 25, 2019 - 7:30 p.m.

The Five Angels Theater  
 The 52nd Street Project  
 789 10th Avenue

# TAKE IT FROM THE TOP

## THE COMPANY

### The Lyricists

Jayden Alvarado  
Crispell Concepción  
Antonella Suero Loyola  
Andrew Moore  
Ayah Musa

### The Composers/Musicians

Lydia Breckon  
Pablo Concha  
Sean Eads  
Nathan Riebli  
Enzo Veiga

### Music Director

Avi A. Amon

### Class Assistant

Clayton Grimm

### Lights

Kaylie Groff

### Sound

Matt Soares

### Photography/Videography

Ryan Nava

### The Singers

Andrea Abello  
Marinda Anderson  
Jenelle Chu  
Angel Desai  
Alex Fernandez  
Belén Moyano  
Chris Murphy  
Ronald Peet  
Vanessa Porras  
Neil Tyrone Pritchard  
Jon-Michael Reese  
Heath Saunders  
Laura Riveros-Sefair  
Michelle J. Rodriguez  
Stephen Stocking  
Stephen Wallem  
Natalie Walker  
Samy Nour Younes

### Stage Manager

Margaret Gleberman

### Stage Crew

Alex Fernandez

### Special Thanks

The Songmaking Program has been established in collaboration with Sarah Schlesinger, Fred Carl, and Julianne Wick Davis and the NYU Tisch School of the Arts Music Theater Writing Program. Thanks also to BerkleeNYC at Power Station, who are recording this performance. The Songmaking Program is made possible with public funds from The New York State Council on the Arts, a state agency, and the New York City Department of Cultural Affairs. The 52nd Street Project is a member of Art/NY and Theatre Communications Group (TCG), the national organization for the American theatre.



## THE CONCERT

### “Worst Water Ever”

Lyrics by Andrew Moore  
Music by Sean Eads  
Sung by Chris Murphy

### “Endgame”

Lyrics by Andrew Moore  
Music by Sean Eads  
Sung by Stephen Stocking

### “Pet Store Blues”

Lyrics by Andrew Moore  
Music by Sean Eads  
Sung by Stephen Wallem &  
Jon-Michael Reese



### “I Like Havana”

Lyrics by Crispell Concepción  
Music by Pablo Concha  
Sung by Andrea Abello &  
Michelle J. Rodriguez

### “Give Me Energy / AI Hospital”

Lyrics by Crispell Concepción  
Music by Pablo Concha  
Sung by Laura Riveros-Sefair

### “Lily and San Francisco”

Lyrics by Crispell Concepción  
Music by Pablo Concha  
Sung by Vanessa Porras &  
Alex Fernandez



### “Sugar and Spice”

Lyrics by Ayah Musa  
Music by Enzo Veiga  
Sung by Marinda Anderson

### “Playground Drama”

Lyrics by Ayah Musa  
Music by Enzo Veiga  
Sung by Angel Desai

### “Dreamland”

Lyrics by Ayah Musa  
Music by Enzo Veiga  
Sung by Natalie Walker



### “Cheez-It”

Lyrics by Jayden Alvarado  
Music by Nathan Riebli  
Sung by Ronald Peet

### “Tomato Town”

Lyrics by Jayden Alvarado  
Music by Nathan Riebli  
Sung by Jon-Michael Reese

### “Rockstar”

Lyrics by Jayden Alvarado  
Music by Nathan Riebli  
Sung by Heath Saunders



### “Goodbye”

Lyrics by Antonella Suero Loyola  
Music by Lydia Breckon  
Sung by Neil Tyrone Pritchard &  
Jenelle Chu

### “Spirit Skeleton”

Lyrics by Antonella Suero Loyola  
Music by Lydia Breckon  
Sung by Belén Moyano

### “Maya is Trans”

Lyrics by Antonella Suero Loyola  
Music by Lydia Breckon  
Sung by Samy Nour Younes

*If you'd like a copy of the lyrics  
to these songs, send an email  
to George at [babiak@52project.org](mailto:babiak@52project.org).*

The 52nd Street Project gratefully acknowledges the support of the following foundations & corporations: Carol M. & Stephen E. Canter Family Foundation; Cantor Fitzgerald Relief Fund; Carnegie Corporation of New York; The CLAWS Foundation; Consolidated Edison; Dawkins Family Foundation; Dramatists Play Service, Inc.; The Jean & Louis Dreyfus Foundation; The Education Foundation of America; Flexis Capital, LLC; Goldman Sachs; The Horace W. Goldsmith Foundation; The Stephen P. Hanson Foundation; Heisman Trophy Trust; The William and Flora Hewlett Foundation; Howard Ashman Trust for Theater Arts Lemle Pictures, Inc.; The Lotos Foundation; Frederick Loewe Foundation; The Rona & Randolph M. Nelson Foundation; Seller-Lehrer Family Foundation; The Stavros Niarchos Foundation; Par Plumbing Co., Inc.; The Pinkerton Foundation; Sawyer | Berson Architecture & Landscape Architecture; The Morris and Alma Schapiro Fund; Showtime Networks; The Shubert Foundation; The Harold & Mimi Steinberg Charitable Trust; Susquehanna Foundation; Tiger Baron Foundation; John A. Vassilaros & Sons, Inc.; Yorke Construction Corp.; Zubatkin Owner Representation, LLC. We also acknowledge the following individual donors (over \$250) to The 52nd Street Project:

Beth & Ray Abbott	Lilly Dobrevá	Madelyn & Ronald Ignasiak	Randi Puccio
Avi & Richard Anthony	Rebecca & Richard Dresser	Jane Ira Bloom & Joe Grifasi	Ivy and Michael Rachlin
Amy Aquino & Drew McCoy	Laurel Durst	Kristen & Kevin Isola	Christopher Randolph
Sarah & Paul Ardire	Michaelene & Jonathan Durst	Andrea Johnson	Helen & Peter Randolph
Lynn Bailey & Zach Grenier	Chrysti & David Eigenberg	Robert Joy & Henry Krieger	Peter Robbins
Becky & Dylan Baker	Tara Elwin & Andre Meade	Christa Justus & Mark Linn-Baker	Anita Rogerson
Eliza Baldi & David Costabile	Robin & Steven Epstein	Samantha & Alex Kaczmarek	Lynne Rosenberg
Beth Barry and Daniel Sussman	Scott Falzone	Cynthia Kaplan & David Froelich	Debra & Russell Rosenthal
Jessica Bauman & Ben Posel	Andrew & Martin Farach-Colton	Kim & Elliot Katz	Laura & David Ross
Jane Beard & Jeffrey Davis	Wendy Federman	Valerie Kay & Bruce Graham	Olivia Sabine
Laurie Becker	Raul Fernandez	Celia Keenan-Bolger	Laura Sametz & Anton Fig
Lisa Benavides	Katie Finneran	& John Conlee	Gail Samuel & William Christian
& Tim Blake Nelson	& Darren Goldstein	Jacqueline Knobbe	Lenora & Steven Satin
Emily Benton-Morgan	Barbara & Richard Fontaine	Mary Kong & Sol Reischer	Deb Savo
& John Morgan	Andrew Fox	Ellen Kroll	Brian Sawyer
Gavin Berger & Craig Berggren	Lindsay Fram & Mason Pettit	Doug Lambert	Karin & Tom Schall
Judy & Sam Berger	Alison Fraser & Steven Pavlakis	Richard Langan	Priya Sehgal
Elizabeth & Eric Berman	Patrice & Louis Friedman	Frances & Fred Langbecker	Nikki & John Sette
Susan Beshel	Sally Froelich	Geraldine & Ray Larson	Sylvia Shepard & Willy Holtzman
Francine Bizar	Janice Gabrielove	Jené LeBlanc & Willie Reale	Maggie Siff & Paul Ratliff
Lewis Black	& Michael Dirzulaitis	Cindy & Richard Leibovitch	Valerie Simmons-Miller
Matthew Blank	Jeanne & Jim Gaffigan	Mickey Lemle	Jeremy Smith
Jane Bolster & Steve Wertimer	Anne & George Gagen	Mark Levine	Joan Solotar
Caitlin Bonsiewicz	Tina Galley	Sean Liebowitz	Marilyn and Barry Steiner
Buzz Bovshow	Robin Galloway	Karen Lipkind & Stuart Gelwarg	Bob Stockel
Samantha & Richard Brand	Alexandra Garrison	Fran Lora	Kim Swain
Becky Browder & Ted Neustadt	Craig Gartner	Kevin Lundquist	Jenni Swan
Iris Brown & Joe White	Rose Gasner & Larry Chertoff	Jane & Greg MacPherson	Richard Sweren
Rhett Brown	Christine Gleason & Erik Larson	Laura & Scott Malkin	Judy Taub Gold
Joel Brukner	Glen Gillen	Jonathan Marvel	April Taylor
Denise Burse	Marcia Goldberg & Paul Garrity	Frances McDormand & Joel Coen	Warren & Erica Thaler
& Peter Jay Fernandez	Robert Goldberg	Jean McKeever	Edith Thurber & Kevin O'Rourke
Kate Burton & Michael Ritchie	& Betsy MacIsaac	Josie Merck	Ron & Judy Tierney
Cathleen & Geoffrey Cantor	Nicolette Goldfarb	Noël & Joe Mihalow	Merritt Tinley & Douglas M. Kaden
Carl Capotorto	Gary Goldring	Carla & Yohan Minaya	Gail and Sam Tobias
Thomas Carr	Stephen Graham	Danielle Mindess & Robert Cohen	Melissa Toth
Gil Cass	Roberta & Butch Graves	Casey Moore	Laura Valeroso & David Seidman
Debbie & Lawrence Catena	Kimberly Grigsby	Amanda & Neal Moszkowski	Cynthia Vance-Abrams
Rachel Chanoff	Emily Grishman	Suzen Murakoshi	& Robert Abrams
Ellen Chopay	& Susan Sampliner	Jane Musky & Tony Goldwyn	Wendy vanden Heuvel
Julie Claire & Glenn Kessler	Sean Haggerty	Rona & Randy Nelson	& Brad Coley
Katie & Kelly Clark	Michael C. Hall	Ruth Nelson	Alexandra Vassilaros
Dana & Neil Cohen	Deana & Stephen Hanson	Roseline Michael Neveling	Tracy & Chris Venezia
Judy & Larry Cohen	Susan Hasman	& Dennis Neveling	P & J Villani
Sherry Cohen	Karen Hauser & Warren Leight	Rachel & Larry Norton	Gaya Vinay
Penny Collins	Annie & David Hausmann	Margaret & Peter O'Brien	Mary Pat Walsh
Kevin Confoy	Helen Hausmann	Lori O'Connor	Tracy Wan & Carl Creager
Kamille Cooper	Jessica Hecht & Adam Bernstein	Carol Ochs & Bruce MacVittie	Sharon Washington
Veanne Cox	Helen & Patrick Hershens	Jacki Ochs & Jan Kroeze	Ellen West & Evan Newmark
Liz & Patrick Crotty	Amy Herzig	Beth & Bob Ollwerther	Vicki & Mark Whatley
Billy Crudup	Josie Holtzman	Steve Olsen	Eric Wiedelman
Gillian Curry	& Isaac Kestenbaum	F. Richard Pappas	Alex Wiener
Cathy Dantchik	Katy Homans & Patterson Sims	Arthur Pearsall	Zia & Victor Williams
Patrice Delcasino	Felicity Huffman	Courtney & Lowell Pettit	Rainn Wilson
& William Curran	& William H. Macy	Kerry Pfingst & Russell Dodson	Lilah & Jeffrey Wise
Carolyn DeSena	Lynda Hughes	Elizabeth & Ryan Porter	Carole Yass
Kim & Jordan Dickstein	Scott Hunter	Sue Poulin	Janine & Jeffrey Yass

List current as of Aug. 2, 2019

**THE 52ND STREET PROJECT PRESENTS**

**UPSIDE DOWN:**

**THE FALL 2019 PLAYMAKING SHOW**

**9 PLAYS WRITTEN BY YOUNG PEOPLE AND PERFORMED BY ADULT ACTORS**

**FRI., NOV. 22 AT 7:30 P.M.**

**SAT., NOV. 23 AT 3:00 & 7:30 P.M.**

**SUN., NOV. 24 AT 3:00 P.M.**

**THE FIVE ANGELS THEATER**

**OUR 10TH ANNIVERSARY OF PERFORMANCES HERE!**

ARTWORK BY CAYLYN WAN-CREAGER



# UPSIDE-DOWN: THE TOPSY-TURVY PLAYS

Fall Playmaking 2019 - Nov. 22-24, Five Angels Theater

## The 52nd Street Project Staff

Kat Almirañez, Associate Artistic Director  
 Avi A. Amon, Musical Director  
 Ahmed Attia, Development Associate\*  
 George Babiak, Director of Design and Production  
 Liz Bell, Clinical Consultant  
 Jasmine Correa, Office Manager\*  
 Kali Crandall, Development Director  
 Natalie Hirsch, Artistic Director  
 Garrett Kim, Program Director  
 Carol Ochs, Executive Director  
 Gus Rogerson, Producing Director  
 Sayantee Sahoo, Production Manager  
 John Sheehy, Director of Institutional Advancement  
 Johanna Vidal, Director of Education\*  
 Caylyn Wan-Creager, Education Associate  
 Iris A. Brown, Graphic Design Consultant

*\*Project Alumni*

### Interns:

Evan Schultz and Ana Soto

### Teen Concessionaires and Ushers:

Natasha Davis, Lakshmi De Jesus, Matthew Orozco, Chyanne Peña,  
 Rosneiry Rosario and Rodery Rosario

## “UPSIDE-DOWN” Production Staff

### Composer/Music Director

Avi A. Amon

### Set Designer

Burke Brown

### Lighting Designer

Greg MacPherson

### Costume Designer

Lily Prentice

### Sound Designer

Stephen Galvan

### Stage Manager

Jenni Swan

### Projection Designs

George Babiak and

The 52nd Street Project Projection Archive

### Prop Design and Construction

George Babiak, Evan Schultz, Ana Soto,  
 Caylyn Wan-Creager

### Backstage Crew

Sevan Asencio, Gus Reale,  
 Evan Schultz, Ana Soto

### House Management

Carol Ochs,  
 John Sheehy

### Flyer/Program Art

Caylyn Wan-Creager

### Chefs

Kim Sherman and John Sheehy

### Teen Counselor

Karen Tineo

## COOL STUFF ON SALE IN THE LOBBY!

Fabulous Flyer Bars ..... \$2.50

*and featuring Shel Silverstein's "Fivey and Twoey" logo:*

Two-tone Project Hoodie ..... \$40.00

Monotone Project Hoodie ..... \$30.00

Crew-neck sweatshirts ..... \$20.00

Project Caps ..... \$20.00

Project T-shirts ..... \$12.00/\$20.00

Project Mugs ..... \$5.00

Project Notebook ..... \$5.00

Project Pencil 3-pack ..... \$1.00

Thank you for coming to **UPSIDE-DOWN!** If you are not on our mailing list, you can join on-line at [www.52project.org](http://www.52project.org). If you're interested in being a volunteer, fill out the form below and hand it to one of our staffers in the lobby.

### PLEASE PUT ME ON YOUR LIST:

12/19

NAME \_\_\_\_\_

ADDRESS \_\_\_\_\_

CITY \_\_\_\_\_

STATE \_\_\_\_\_

ZIP \_\_\_\_\_

HOME PHONE \_\_\_\_\_

DAYTIME OR MOBILE PHONE \_\_\_\_\_

E-MAIL ADDRESS \_\_\_\_\_

MY OCCUPATION \_\_\_\_\_

MY HOBBIES \_\_\_\_\_

WANT TO BE GREEN AND SAVE THE PROJECT MONEY ON POSTAGE?  
 CHECK THIS BOX TO RECEIVE OUR NOTICES EXCLUSIVELY VIA E-MAIL.

### YES, I WOULD LIKE TO BE OF HELP. I CAN:

- |   |   |  |
|---|---|--|
| <input type="checkbox"/> Help load in and out for shows | <input type="checkbox"/> Draw and/or paint  | <input type="checkbox"/> Help kids with homework |
| <input type="checkbox"/> Hang lights                    | <input type="checkbox"/> Help with mailings | <input type="checkbox"/> Teach kids a skill      |
| <input type="checkbox"/> Work on a backstage crew       | <input type="checkbox"/> Do office work     | <input type="checkbox"/> Be a chef at an event   |
| <input type="checkbox"/> Do graphic design              | <input type="checkbox"/> Design sound       | <input type="checkbox"/> Design and sew costumes |
| <input type="checkbox"/> Other (please specify) _____   |   |  |

### MY SCHEDULE IS:

- Very flexible. I'm often available during weekdays.  
 Somewhat flexible. I can help on the occasional morning or afternoon during the week.  
 Not very flexible at all, but I've got some free time on evenings and weekends.

If you would like to mail this (and you're always welcome to enclose a tax-deductible contribution), you can send it to: The 52nd Street Project, 789 10th Avenue, New York, NY 10019. Or fax it to (212) 333-5598.



The Playmaking Program is made possible with public funds from The New York State Council on the Arts, a state agency, and the New York City Department of Cultural Affairs. The 52nd Street Project is a member of Art/NY and Theatre Communications Group (TCG), the national organization for the American theatre.

## WHAT'S COMING UP?

8 young people sharing their own words!

PUSH YOUR



THE 2019  
WORDPLAY  
SHOW

Friday,  
December 13<sup>th</sup>  
at 7:30

ARTWORK BY ALEX BRETON

### SUBSCRIBE TO OUR PODCAST!

A monthly online event created by Garrett Kim, John Sheehy, and your favorite kid/adult team-ups. Go to the podcast section of the iTunes Store and search for "The 52nd Street Project" or "PROJcast."



### BE ON THE LOOKOUT FOR INTERNS!

If you know of any college or graduate students who might enjoy working with us, playing with us, and going on trips with us for a semester, please have them contact Caylyn Creager (creager@52project.org). We are currently looking for interns for the Spring and Summer of 2020. Thanks!



### The 52nd Street Project Board of Directors

Lisa Benavides  
Rachel Chanoff  
Cathy Dantchik, co-chair  
Carolyn DeSena  
Wendy Ettinger, chair emeritus  
Louis P. Friedman, co-chair  
Alexandra Gersten-Vassilaros  
Robert Goldberg  
Stephen Graham, chair emeritus  
Annie Hausmann  
Natalie Hirsch

Valerie Kay  
Noël Mihalow  
Roseline Michael Neveling  
Carol Ochs  
Willie Reale, founder  
Gus Rogerson  
Shirley Rumierk, alumni member  
José Soto, Jr., alumni member  
Merritt Tilney  
Wendy vanden Heuvel  
Mark Whatley

### The 2019 Big Kids Committee

Avi Taussig Anthony, Ashley Baer, Michaela Culver, Alexandra Garrison, Ashley Henry, Samantha Kaczmarek, Ashley Marie Ortiz, Michael Propster, Jenni Swan & Kerry Warren

### What's Going On Here?

The 52nd Street Project is a non-profit organization that brings children from the Hell's Kitchen neighborhood together with professional theater artists to create original theater. **UPSIDE-DOWN** is a production of our Playmaking program. Young people participate in a nine-week playwriting course taught by Kat Almirañez and adapted for the Project by Daniel Judah Sklar from his book *Playmaking: Children Writing and Performing Their Own Plays*. At the end of the course, each child is matched with two actors and a dramaturg/director who guides him or her through the writing of a play during a weekend in the country (Cold Spring, Pennsylvania, this time). This performance is the end result.

### In-Kind Contributions

Abbeville Press; Ambassador Theatre Group; Avi & Richard Anthony; Ardesia; Kate & Andy Bellin; Lewis Black; Iris A. Brown Design; Cellar 53; William Curran, A Curran Affair; The Daily Show's Trevor Noah; Michael Dorf & City Winery; Dormify.com; Sean Feeney, MISI; Haru Restaurant of Hell's Kitchen; Celia Keenan-Bolger; Karen Kowgios of Withum, Smith, & Brown; Pamela Liebman, The Corcoran Group; Charlie Marshall; Stella McCartney; Michter's Distillery, LLC Noël Mihalow & Prime Films; The Neveling Family; Lauren Friedman, Pharma/Omni Printing; Winston Rodney Photography; Signature Bank; SHOWTIME; The Surrey; Merritt Tilney & Doug Kaden; Vassilaros & Sons Coffee Company; Alex Vassilaros & The Vassilaros Family; The Watkins Company; Vicki & Mark Whatley and Paul, Rifkind, Wharton, & Garrison LLP.

### Special Thanks

We're extremely thankful to David and Deborah Pursch for the use of their beautiful home in Cold Spring, PA as our base of operations for the writer's retreat weekend. We must also express thanks to the families that hosted our kids and adults: Bill and Linda Cobb, Roberta and Vince Conroy, Bill and Linda Halvorsen, James and Heather Hogan-Spencer, Katy Homans and Patterson Sims, Ryanne and Jim Jennings, Robin and Jim Sampson, and Jim and Pat Sanders.

Gratitude must also be paid to the volunteers who helped out in Playmaking class: Alana Fu, Carina Goebelbecker, Stephanie LaVardera, Sara Ornelas, Ryan Spahn, Ben Stockman, and Aurea Tomeski

## UPSIDE-DOWN: THE TOPSY PLAYS - ACT 1

All original music composed by Avi A. Amon

### THE FAKE FRIEND AND THE RICH GIRL

Written by Doris Cross, age 10

Dramaturge: Caylyn Wan-Creager. Director: Kat Almirañez

Janae Willow Smith ..... Morgan Everitt

Veronica Kingsley ..... Simone Recasner

*I Want a Friend* and *Differences* lyrics by Doris Cross

### THE LOST LAND OF GOLD

Written by Sophia LaCotera, age 10

Director/Dramaturge: Estefanía Fadul

Layla ..... Leta Renée-Alan

Boby Latrop, a pumpkin-headed donkey ..... KeiLyn Durrel Jones

*Don't Kill Me* lyrics by Sophia LaCotera

### THE BATTLE OF MINERALS

Written by Xavier Valentin, age 9

Dramaturges: Ana Soto & Karen Tineo. Director: Nick Mills

KPV, a potassium ..... Erin Felgar

Becky, a determined assassin bacteria ..... Chelsea Melone

Dion's silhouette ..... Gus Reale

Becky Clone ..... Ana Soto

*Frenemy Elements* lyrics by Xavier Valentin

### SHAME

Written by Kal-el Alexis, age 11

Dramaturge/Director: Ben Stockman

Carly, a dragon ballerina ..... Jasmin Johnson

Slider, a worm ..... Kyle Cameron

Bullies ..... The Crew

Lincoln ..... Sevan Asencio

Lincoln's Dad ..... George Babiak

Slider's Mom and Dad ..... Evan Schultz and Gus Reale

*Mad/Why* and *Friendship* lyrics by Kal-el Alexis

### THAT'S A GOOD BURGER

Written by Peter Muca, age 12

Director/Dramaturge: Michael Propster

Gorgon ..... Sara Ornelas

James B. Voorhees ..... Joe Tapper

Other Gorgons ..... The Crew

News reporter ..... Ana Soto

Queen Demo ..... Evan Schultz

Man of Candy ..... George Babiak

*Cheeseburgers* lyrics by Peter Muca

## UPSIDE-DOWN: THE TOPSY PLAYS - ACT 2

### BILL, JR. AND BARRY'S MISHAP-ADVENTURE

Written by Logan Goicuria, age 9

Director/Dramaturge: John Sheehy

Barry ..... Jon-Michael Reese

Bill, Jr. .... Jake Pino

*The Fighting Song* and *Dinosaurs* lyrics by Logan Goicuria

### KITTY AND STEVEY

Written by Hannah Santos, age 10

Director/Dramaturge: Sol Crespo

Stevey, a cat ..... RJ Foster

Kitty, a mouse ..... Lynne Rosenberg

Mouse family ..... Gus Reale and Ana Soto

*Similar Superpowers* lyrics by Hannah Santos

### THE ADVENTURE OF SHADOWCLAW AND NIBLEHOUND

Written by Aiden Vasquez, age 10

Dramaturge/Director: Jose Gamo

Shadowclaw, a Rat Dragon ..... Christian DeMarais

Niblehound, a Mouse Dog ..... Genesis Oliver

Crab General ..... George Babiak

Rat King ..... Ana Soto

Guards ..... Sevan Asencio and Jayleen Velez

*Power is Everything* lyrics by Aiden Vasquez

### THE SCIENCE PROJECT THAT WOULD CHANGE YOUR LIFE

Written by Arianna Casiano, age 9

Director/Dramaturge: Christina Roussos

May ..... Crystal Dickinson

Carle ..... Tina Chilip

Principal's voice ..... Kat Almirañez

Teacher's voice ..... George Babiak

Students ..... The Crew

*Friends, Friends, Friends* and *I Want Equal Rights* lyrics by Arianna Casiano

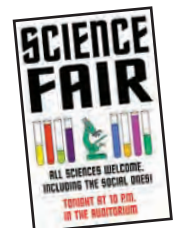

The 52nd Street Project is a non-profit community-based arts organization that brings children from the Hell's Kitchen neighborhood together with professional artists to create original art. Over the month of the WordPlay program, led by Program Director Garrett Kim with support from Corey Ruzicano, these young poets and wordsmiths explored their place in the world and arranged their perceptions and ideas into the pieces you are seeing tonight. We were also lucky enough to have a quartet of interns that are very musical, and they added their own talents to the proceedings. We hope you will enjoy the results!

### The 52nd Street Project Staff

Kat Almirañez, Associate Artistic Director  
 Avi A. Amon, Musical Director  
 Ahmed Attia, Development Associate\*  
 George Babiak, Director of Design and Production  
 Liz Bell, Clinical Consultant  
 Jasmine Correa, Office Manager\*  
 Kali Crandall, Development Director  
 Natalie Hirsch, Artistic Director  
 Garrett Kim, Program Director  
 Carol Ochs, Executive Director  
 Gus Rogerson, Producing Director  
 Sayantee Sahoo, Production Manager  
 John Sheehy, Director of Institutional Advancement  
 Johanna Vidal, Director of Education\*  
 Caylyn Wan-Creager, Education Associate  
 Iris A. Brown, Graphic Design Consultant

*\*Project Alumni*

#### Interns:

Evan Schultz and Ana Soto

#### Teen Concessionaires and Ushers:

Rodery Rosario, Nicole Quiles, Karen Tineo

#### Poster Art

Alex Breton

### The 52nd Street Project Board of Directors

Lisa Benavides	Valerie Kay
Rachel Chanoff	Noël Mihalow
Cathy Dantchik, co-chair	Roseline Michael Neveling
Carolyn DeSena	Carol Ochs
Wendy Ettinger, chair emeritus	Willie Reale, founder
Louis P. Friedman, co-chair	Gus Rogerson
Alexandra Gersten-Vassilaros	Shirley Rumierk, alumni member
Robert Goldberg	José Soto, Jr., alumni member
Stephen Graham, chair emeritus	Merritt Tilney
Annie Hausmann	Wendy vanden Heuvel
Natalie Hirsch	Mark Whatley

THE 52ND STREET PROJECT PRESENTS

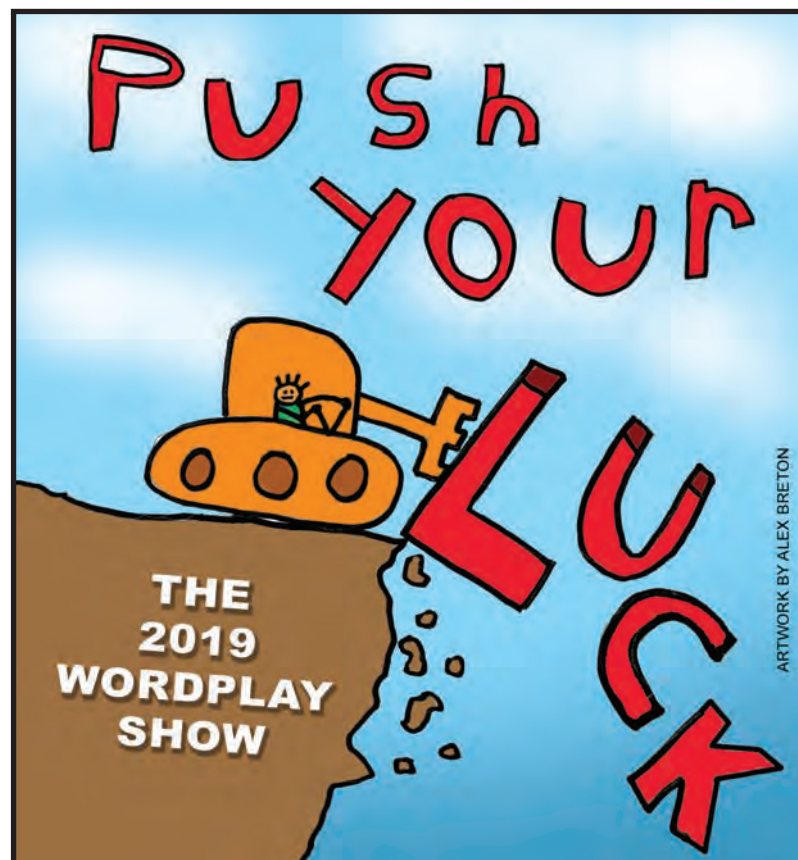

Featuring original spoken-word pieces  
 by eight young people of The 52nd Street Project.

Wordplay Directors:  
 Garrett Kim and Corey Ruzicano

Friday, Dec. 13, 2019  
 7:30 p.m.

The Five Angels Theater  
 The 52nd Street Project  
 789 10th Avenue

THE 52ND STREET PROJECT'S



A NEW PLATFORMS PROGRAM

## THE "PUSH YOUR LUCK" COMPANY

### Project Members

Alex De La Rosa  
Ethan Cruz  
Hanna Brea  
Jai-Lyzz Rodriguez  
Jojo Perez  
Kailey Caton  
Lanai Blake-Soden  
Marcelle Orozco

### Volunteer Partners

Charlie O'Rourke  
Mat Hostetler  
Chyanne Peña  
Jen Anaya  
Ian Edlund  
Nehassaiu deGannes  
Madeline DeFreece  
Talia Heller

## THE SHOW

**How To Be A Grown Up/How to Be A Kid**  
Wordplay 2019 Ensemble

**Firecracker**  
Lanai Blake-Soden

**My Love for New York**  
Kailey Caton

**Untitled My Name Is**  
Alex De La Rosa

**Home**  
Jai-Lyzz Rodriguez

**Hate + Love**  
Ethan Cruz

### Fortune Cookies

Alex De La Rosa, Ethan Cruz, Jojo Perez

### Untitled NYC Letter(s)

Hanna Brea

### Ode to my Diary/Ode to my Basketball Sweater

Jai-Lyzz Rodriguez

### Letter To: The City that never sleeps

Lanai Blake-Soden

### To my dearest breyanna

Kailey Caton

:)

Marcelle Orozco

### Untitled Ode

Hanna Brea

### Big Rotten Apple

Jojo Perez

### Letters to Older & Younger Selves

Wordplay 2019 Ensemble

### P.S.

Wordplay 2019 Ensemble



Wordplay has been made possible with public funds from The New York State Council on the Arts, a state agency, and the New York City Department of Cultural Affairs. The 52nd Street Project is a member of Art/NY and Theatre Communications Group (TCG), the national organization for the American theatre.



# SHOW PROGRAMS 2020 (Pandemic Year 1)

The 52nd Street Project gratefully acknowledges the support of the following foundations & corporations: Carol M. & Stephen E. Canter Family Foundation; Cantor Fitzgerald Relief Fund; Carnegie Corporation of New York; The CLAWS Foundation; Consolidated Edison; Dawkins Family Foundation; Dramatists Play Service, Inc.; The Jean & Louis Dreyfus Foundation; The Education Foundation of America; Flexis Capital, LLC; Goldman Sachs; The Horace W. Goldsmith Foundation; The Stephen P. Hanson Foundation; Heisman Trophy Trust; The William and Flora Hewlett Foundation; Howard Ashman Trust for Theater Arts Lemle Pictures, Inc.; The Lotos Foundation; Frederick Loewe Foundation; The Rona & Randolph M. Nelson Foundation; Seller-Lehrer Family Foundation; The Stavros Niarchos Foundation; Par Plumbing Co., Inc.; The Pinkerton Foundation; Sawyer | Berson Architecture & Landscape Architecture; The Morris and Alma Schapiro Fund; Showtime Networks; The Shubert Foundation; The Harold & Mimi Steinberg Charitable Trust; Susquehanna Foundation; Tiger Baron Foundation; John A. Vassilaros & Sons, Inc.; Yorke Construction Corp.; Zubatkin Owner Representation, LLC. We also acknowledge the following individual donors (over \$250) to The 52nd Street Project:

Beth & Ray Abbott	Lilly Dobreva	Madelyn & Ronald Ignasiak	Randi Puccio
Avi & Richard Anthony	Rebecca & Richard Dresser	Jane Ira Bloom & Joe Grifasi	Ivy and Michael Rachlin
Amy Aquino & Drew McCoy	Laurel Durst	Kristen & Kevin Isola	Christopher Randolph
Sarah & Paul Ardire	Michaelene & Jonathan Durst	Andrea Johnson	Helen & Peter Randolph
Lynn Bailey & Zach Grenier	Chrysti & David Eigenberg	Robert Joy & Henry Krieger	Peter Robbins
Becky & Dylan Baker	Tara Elwin & Andre Meade	Christa Justus & Mark Linn-Baker	Anita Rogerson
Eliza Baldi & David Costabile	Robin & Steven Epstein	Samantha & Alex Kaczmarek	Lynne Rosenberg
Beth Barry and Daniel Sussman	Scott Falzone	Cynthia Kaplan & David Froelich	Debra & Russell Rosenthal
Jessica Bauman & Ben Posel	Andrew & Martin Farach-Colton	Kim & Elliot Katz	Laura & David Ross
Jane Beard & Jeffrey Davis	Wendy Federman	Valerie Kay & Bruce Graham	Olivia Sabine
Laurie Becker	Raul Fernandez	Celia Keenan-Bolger	Laura Sametz & Anton Fig
Lisa Benavides	Katie Finneran	& John Conlee	Gail Samuel & William Christian
& Tim Blake Nelson	& Darren Goldstein	Jacqueline Knobbe	Lenora & Steven Satin
Emily Benton-Morgan	Barbara & Richard Fontaine	Mary Kong & Sol Reischer	Deb Savo
& John Morgan	Andrew Fox	Ellen Kroll	Brian Sawyer
Gavin Berger & Craig Berggren	Lindsay Fram & Mason Pettit	Doug Lambert	Karin & Tom Schall
Judy & Sam Berger	Alison Fraser & Steven Pavlakis	Richard Langan	Priya Sehgal
Elizabeth & Eric Berman	Patrice & Louis Friedman	Frances & Fred Langbecker	Nikki & John Sette
Susan Beshel	Sally Froelich	Geraldine & Ray Larson	Sylvia Shepard & Willy Holtzman
Francine Bizar	Janice Gabrielove	Jené LeBlanc & Willie Reale	Maggie Siff & Paul Ratliff
Lewis Black	& Michael Dirzulaitis	Cindy & Richard Leibovitch	Valerie Simmons-Miller
Matthew Blank	Jeanne & Jim Gaffigan	Mickey Lemle	Jeremy Smith
Jane Bolster & Steve Wertimer	Anne & George Gagen	Mark Levine	Joan Solotar
Caitlin Bonsiewicz	Tina Galley	Sean Liebowitz	Marilyn and Barry Steiner
Buzz Bovshow	Robin Galloway	Karen Lipkind & Stuart Gelwarg	Bob Stockel
Samantha & Richard Brand	Alexandra Garrison	Fran Lora	Kim Swain
Becky Browder & Ted Neustadt	Craig Gartner	Kevin Lundquist	Jenni Swan
Iris Brown & Joe White	Rose Gasner & Larry Chertoff	Jane & Greg MacPherson	Richard Sweren
Rhett Brown	Christine Gleason & Erik Larson	Laura & Scott Malkin	Judy Taub Gold
Joel Brukner	Glen Gillen	Jonathan Marvel	April Taylor
Denise Burse	Marcia Goldberg & Paul Garrity	Frances McDormand & Joel Coen	Warren & Erica Thaler
& Peter Jay Fernandez	Robert Goldberg	Jean McKeever	Edith Thurber & Kevin O'Rourke
Kate Burton & Michael Ritchie	& Betsy MacIsaac	Josie Merck	Ron & Judy Tierney
Cathleen & Geoffrey Cantor	Nicolette Goldfarb	Noël & Joe Mihalow	Merritt Tinley & Douglas M. Kaden
Carl Capotorto	Gary Goldring	Carla & Yohan Minaya	Gail and Sam Tobias
Thomas Carr	Stephen Graham	Danielle Mindess & Robert Cohen	Melissa Toth
Gil Cass	Roberta & Butch Graves	Casey Moore	Laura Valeroso & David Seidman
Debbie & Lawrence Catena	Kimberly Grigsby	Amanda & Neal Moszkowski	Cynthia Vance-Abrams
Rachel Chanoff	Emily Grishman	Suzen Murakoshi	& Robert Abrams
Ellen Chopay	& Susan Sampliner	Jane Musky & Tony Goldwyn	Wendy vanden Heuvel
Julie Claire & Glenn Kessler	Sean Haggerty	Rona & Randy Nelson	& Brad Coley
Katie & Kelly Clark	Michael C. Hall	Ruth Nelson	Alexandra Vassilaros
Dana & Neil Cohen	Deana & Stephen Hanson	Roseline Michael Neveling	Tracy & Chris Venezia
Judy & Larry Cohen	Susan Hasman	& Dennis Neveling	P & J Villani
Sherry Cohen	Karen Hauser & Warren Leight	Rachel & Larry Norton	Gaya Vinay
Penny Collins	Annie & David Hausmann	Margaret & Peter O'Brien	Mary Pat Walsh
Kevin Confoy	Helen Hausmann	Lori O'Connor	Tracy Wan & Carl Creager
Kamille Cooper	Jessica Hecht & Adam Bernstein	Carol Ochs & Bruce MacVittie	Sharon Washington
Veanne Cox	Helen & Patrick Herssens	Jacki Ochs & Jan Kroeze	Ellen West & Evan Newmark
Liz & Patrick Crotty	Amy Herzig	Beth & Bob Ollwerther	Vicki & Mark Whatley
Billy Crudup	Josie Holtzman	Steve Olsen	Eric Wiedelman
Gillian Curry	& Isaac Kestenbaum	F. Richard Pappas	Alex Wiener
Cathy Dantchik	Katy Homans & Patterson Sims	Arthur Pearsall	Zia & Victor Williams
Patrice Delcasino	Felicity Huffman	Courtney & Lowell Pettit	Rainn Wilson
& William Curran	& William H. Macy	Kerry Pfingst & Russell Dodson	Lilah & Jeffrey Wise
Carolyn DeSena	Lynda Hughes	Elizabeth & Ryan Porter	Carole Yass
Kim & Jordan Dickstein	Scott Hunter	Sue Poulin	Janine & Jeffrey Yass

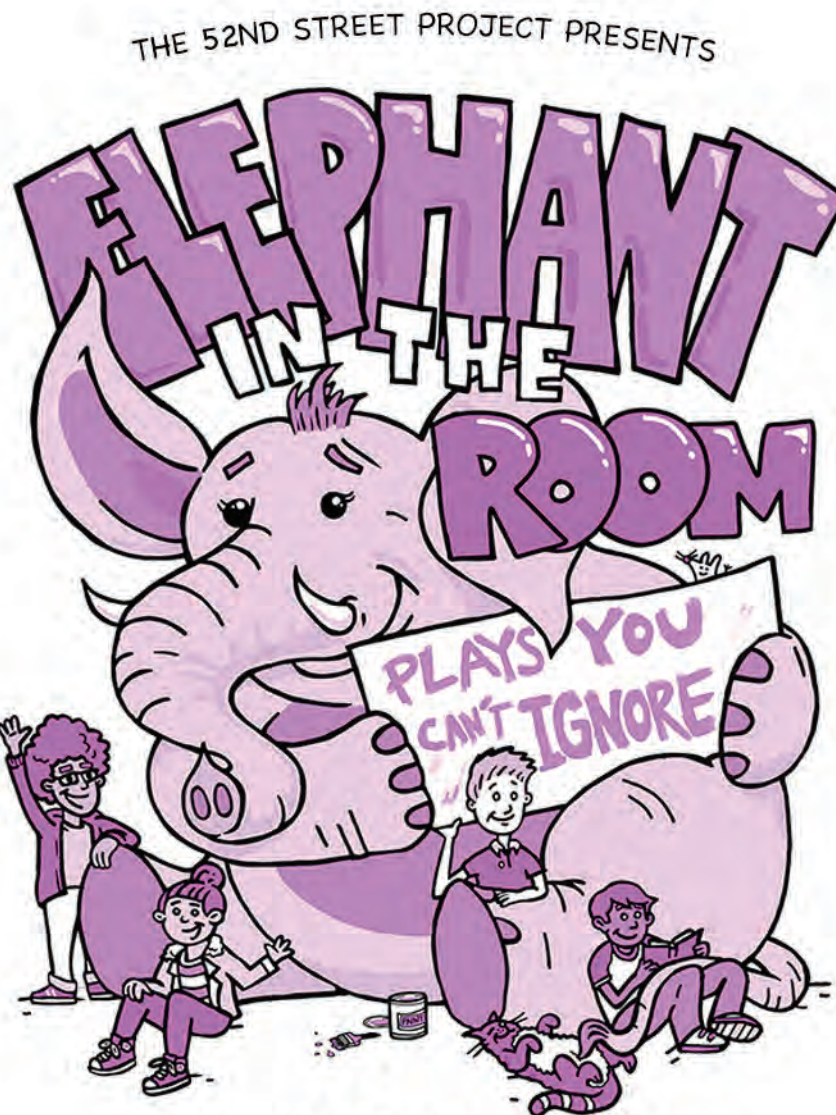

ARTWORK BY PATRICK JONES

## The 2020 2-on-2 plays

8 young people in 4 plays written and directed by adults

## THE FIVE ANGELS THEATER

Friday, Jan. 24 at 7:30 p.m.

Saturday, Jan. 25 at 7:30 p.m.

Sunday, Jan. 26 at 3:00 p.m.

# ELEPHANT IN THE ROOM: PLAYS YOU CAN'T IGNORE

The 2020 2-on-2 Shows - Jan. 24-26, The Five Angels Theater

## The 52nd Street Project Staff

Kat Almirañez, Associate Artistic Director

Avi A. Amon, Musical Director

Ahmed Attia, Development Associate\*

George Babiak, Director of Design and Production

Liz Bell, Clinical Consultant

Jasmine Correa, Office Manager\*

Kali Crandall, Development Director

Natalie Hirsch, Artistic Director

Garrett Kim, Program Director

Kristina Nungaray,

Development, Communications, and Management Associate

Carol Ochs, Executive Director

Gus Rogerson, Producing Director

Sayantee Sahoo, Production Manager

John Sheehy, Director of Institutional Advancement

Johanna Vidal, Director of Education\*

Caylyn Wan-Creager, Education Associate

Iris A. Brown, Graphic Design Consultant

\*Project Alumni

## Interns:

Cierra Cassano, Thomas Finegar, Alexis Buncich

## Teen Concessionaires and Ushers:

Natasha Davis, Lakshmi De Jesus, Chyanne Peña

## "ELEPHANT" Production Staff

### Composer/Music Director

Erato Kremmyda

### Set Designer

Burke Brown

### Lighting Designer

Greg MacPherson

### Costume Designer

Paula Cohen

### Costume Assistant

Tyler Carlton Williams

### Sound Designer

Stephen Galvan

### Stage Manager

Jenni Swan

### Projection Designs

George Babiak

### Prop Design and Construction

George Babiak, Cierra Cassano

### Backstage Crew

Cierra Cassano, Thomas Finegar,

Nicole Quiles

### House Management

Carol Ochs,

John Sheehy

### Flyer/Program Art

Patrick Jones

### Chef

John Sheehy

## COOL STUFF ON SALE IN THE LOBBY!

Fabulous Flyer Bars ..... \$2.50

and featuring Shel Silverstein's "Fivey and Twoey" logo:

Two-tone Project Hoodie ..... \$40.00

Monochrome Project Hoodie ..... \$30.00

Crew-neck sweatshirts ..... \$20.00

Project Caps ..... \$20.00

Project T-shirts ..... \$12.00/\$20.00

Project Mugs (now in Neon Orange) ..... \$5.00

Project Notebook ..... \$5.00

Project Pencil 3-pack ..... \$1.00

Thank you for coming to **ELEPHANT IN THE ROOM**. If you are not on our mailing list, you can join on-line at [www.52project.org](http://www.52project.org). If you're interested in being a volunteer, fill out the form below and hand it to one of our staffers in the lobby.

## PLEASE PUT ME ON YOUR LIST:

1/20

NAME \_\_\_\_\_

ADDRESS \_\_\_\_\_

CITY \_\_\_\_\_

STATE \_\_\_\_\_

ZIP \_\_\_\_\_

HOME PHONE \_\_\_\_\_

DAYTIME OR MOBILE PHONE \_\_\_\_\_

E-MAIL ADDRESS \_\_\_\_\_

MY OCCUPATION \_\_\_\_\_

MY HOBBIES \_\_\_\_\_

WANT TO BE GREEN AND SAVE THE PROJECT MONEY ON POSTAGE?  
CHECK THIS BOX TO RECEIVE OUR NOTICES EXCLUSIVELY VIA E-MAIL.

## YES, I WOULD LIKE TO BE OF HELP. I CAN:

- |   |   |  |
|---|---|--|
| <input type="checkbox"/> Help load in and out for shows | <input type="checkbox"/> Draw and/or paint  | <input type="checkbox"/> Help kids with homework |
| <input type="checkbox"/> Hang lights                    | <input type="checkbox"/> Help with mailings | <input type="checkbox"/> Teach kids a skill      |
| <input type="checkbox"/> Work on a backstage crew       | <input type="checkbox"/> Do office work     | <input type="checkbox"/> Be a chef at an event   |
| <input type="checkbox"/> Do graphic design              | <input type="checkbox"/> Design sound       | <input type="checkbox"/> Design and sew costumes |
| <input type="checkbox"/> Other (please specify) _____   |   |  |

## MY SCHEDULE IS:

- Very flexible. I'm often available during weekdays.
- Somewhat flexible. I can help on the occasional morning or afternoon during the week.
- Not very flexible at all, but I've got some free time on evenings and weekends.

If you would like to mail this (and you're always welcome to enclose a tax-deductible contribution), you can send it to: The 52nd Street Project, 789 10th Avenue, New York, NY 10019. Or fax it to (212) 333-5598.



The Playmaking Program is made possible with public funds from The New York State Council on the Arts, a state agency, and the New York City Department of Cultural Affairs. The 52nd Street Project is a member of Art/NY and Theatre Communications Group (TCG), the national organization for the American theatre.



## COMING UP NEXT...

THE 52ND STREET PROJECT PRESENTS

THE SPRING 2020  
PLAYMAKING SHOW

10 PLAYS WRITTEN  
BY YOUNG PEOPLE  
AND PERFORMED  
BY ADULT ACTORS

NATALIE HIRSCH,  
ARTISTIC DIRECTOR

KAT ALMIRÁÑEZ,  
PLAYMAKING DIRECTOR

CAROL OCHS,  
EXECUTIVE DIRECTOR



ADMISSION FREE, BUT BE SURE TO VISIT  
52PROJECT.ORG TO MAKE A RESERVATION.

# SMOKE & MIRRORS

## THE TRICKY PLAYS

FRIDAY, MARCH 20 AT 7:30 P.M.  
SATURDAY, MARCH 21 AT 3:00 & 7:30 P.M.  
SUNDAY, MARCH 22 AT 3:00 P.M.

**THE FIVE ANGELS THEATER**

789 10TH AVE., BETWEEN 52ND & 53RD ST.



## BE ON THE LOOKOUT FOR INTERNS!

If you know of any college or graduate students who might enjoy working with us, playing with us, and going on trips with us for a semester, please have them email Caylyn at [creager@52project.org](mailto:creager@52project.org). We are currently looking for interns for the Summer of 2020. Thanks!

## The 52nd Street Project Board of Directors

Lisa Benavides	Valerie Kay
Rachel Chanoff	Noël Mihalow
Cathy Dantchik, co-chair	Roseline Michael Neveling
Carolyn DeSena	Carol Ochs
Wendy Ettinger, chair emeritus	Willie Reale, founder
Louis P. Friedman, co-chair	Gus Rogerson
Alexandra Gersten-Vassilaros	Shirley Rumierk, alumni member
Robert Goldberg	José Soto, Jr., alumni member
Stephen Graham, chair emeritus	Merritt Tilney
Annie Hausmann	Wendy vanden Heuvel
Natalie Hirsch	Mark Whatley

## What's Going On Here?

The 52nd Street Project is a non-profit organization that brings young people from the Hell's Kitchen neighborhood together with professional theater artists to create original theater. **ELEPHANT IN THE ROOM** is a production of our Two-on-Two's program, in which an adult playwright writes a play for a pair of 52nd Street Project teen-agers to perform. Another adult directs the kids for a month that includes an intensive weekend in Rockland County. Tonight's performance is the final result.

## In-Kind Contributions

Abbeville Press; Ambassador Theatre Group; Avi & Richard Anthony; Ardesia; Kate & Andy Bellin; Lewis Black; Iris A. Brown Design; Cellar 53; William Curran, A Curran Affair; The Daily Show's Trevor Noah; Michael Dorf & City Winery; Dormify.com; Sean Feeney, MISI; Haru Restaurant of Hell's Kitchen; Celia Keenan-Bolger; Karen Kowgios of Withum, Smith, & Brown; Pamela Liebman, The Corcoran Group; Charlie Marshall; Stella McCartney; Michter's Distillery, LLC Noël Mihalow & Prime Films; The Neveling Family; Deneka Peniston Photography; Lauren Friedman, Pharma/Omni Printing; Winston Rodney Photography; Signature Bank; SHOWTIME; The Surrey; Merritt Tilney & Doug Kaden; Vassilaros & Sons Coffee Company; Alex Vassilaros & The Vassilaros Family; The Watkins Company; Vicki & Mark Whatley and Paul, Rifkind, Wharton, & Garrison LLP.

## Big Kids Committee

Avi Taussig Anthony, Ashley Baer, Michaela Culver, Alexandra Garrison, Ashley Henry, Samantha Kaczmarek, Ashley Marie Ortiz, Michael Propster, Jenni Swan & Kerry Warren.

## Special Thanks

We owe many thanks to Wendy vanden Heuvel & Brian Mertes & Melissa Kievman; Susanna Styron; and Polly King & John Paul Newport, all of whom graciously allowed us to use their homes in the Nyack area for an exhilarating and fun-filled weekend. Thanks also to New City Bowling Lanes for providing a place to knock down lots of pins.

## ELEPHANT IN THE ROOM: PLAYS YOU CAN'T IGNORE

All original music composed by Erato Kremmyda.

*Tonight's show will be performed without an intermission.*

### MADAME PRESIDENT AND THE GOLDEN GIRL

Written by Tahnee Freda

Directed by Paton Ashbrook

Madame President ..... Arden Wolfe

Susan ..... Amirah Hancock

*Friendship From a Rivalry* lyrics by Tahnee Freda.

### TRUFFLE RANSOM

Written by Willie Reale

Directed by Sathya Sridharan

Major Jack, an astronaut ..... Andres Mendoza

OU812, a robot ..... Jayden Alvarado

*Truffles* lyrics by Willie Reale.



## ELEPHANT IN THE ROOM: PLAYS YOU CAN'T IGNORE

### THE JOURNEY

Written by Sherisse Alvarez

Directed by Ciana Proto

Maya ..... Yovely Ramirez

Frankie ..... Morgan Smalls

Parents' voices ..... Thomas Finegar and Cierra Cassano

*Look At All This Beauty* lyrics by Sherisse Alvarez.

### THE HISTORY PROJECT

Written by Garrett David Kim

Directed by Alex J. Gould

Trav ..... Amari DuBose

Javi ..... Angel Mendoza

Teammates ..... The Crew

*People Change* lyrics by Garrett David Kim.



# PANDEMIC PLAYMAKING

## #1



# APRIL 15, 2020

After the lockdown began in March of 2020, The 52nd Street Project began using the Zoom platform to teach a series of Playmaking classes to young members who were now nearly housebound. The finished plays of each class were performed on Zoom to a very small online audience. Four such mini-productions were done between April and July. The first one, with no theme or title, was performed on April 15, 2020. The program you are reading was created in January, 2022.

## **Playmaking Teacher/Director: Kat Almirañez**

### **Class Volunteers**

Molly Carden, Carina Goebelbecker, Korey Jackson,  
Jimmy Kenna, Ryan Spahn, and Kea Trevett.

## **Parents & No Parents**

by JoJo Perez

Oscar Cabrera & Ashley Marie Ortiz

Dramaturge, Jimmy Kenna.

## **The Disconnect of the Cat & the Yarn**

by Arianna Cassiano

Natalie Marshall Hirsch & KeiLyn Durrell Jones.

Dramaturge: Molly Carden.

## **Apples & the Lost Apples**

by Tremaine Batson

Shirley Rumierk & Armando Riesco

Dramaturge: Korey Jackson.

## **Cats and Water Don't Mix**

by Logan Goicuria

Zabryna Guevara & Michael Frederic

Dramaturge: Ryan Spahn.

## **The House**

by Faith Villanueva

Maggie Odette & Chris Wight

Dramaturge: Carina Goebelbecker.

## **Pealy and Corn Boy's Adventure, Part 1**

by John Muca

Paton Ashbrook & Sathya Sridharan

Dramaturge: Kea Trevett.

# PANDEMIC PLAYMAKING #2



**MAY 13, 2020**

After the lockdown began in March of 2020, The 52nd Street Project began using the Zoom platform to teach a series of Playmaking classes to young members who were now nearly housebound. The finished plays of each class were performed on Zoom to a very small online audience. Four such mini-productions were done between April and July. The second one, with no theme or title, was performed on May 13, 2020. The program you are reading was created in January, 2022.

## **Playmaking Teacher/Director: Kat Almirañez**

### **THE MUSKETEERS**

By Doris Cross  
with Ana Soto & Veronika Chernitska  
Director/Dramaturge: Chelsea Hackett.

### **UNTITLED**

by Jai-Lyzz Rodriguez  
with Daiva Deupree & Matt Wilkas  
Director/Dramaturge: Kristina Nungaray.

### **PLEASE STOP POLLUTING, PEOPLE!**

by Kaytie Gil  
with David Starry & Kathy Staats  
Director/Dramaturge: Rachel Pickup  
Composer: Danny Ursetti.

### **SPY'S ARCHNEMESIS**

By Daniel Henk  
with Elli Brown & Jose Gamo  
Dramaturge/Director: James Yaegashi  
Composer: Wes Braver.

### **THE BATTLE OF THE TREATS**

by Sophia La Cotera  
with AJ Shively & Kate Abbruzzese  
Dramaturge/Director: Nolan Doran  
Composer: Kim Sherman.

### **THE SCIENTISTS VS. GREG**

By Christian Santoni  
with Jack Mikesell & Zoe Chao.  
Dramaturge/Director: Gus Reale.  
Composer: Zonia Tsang.

# **VIRTUAL** **PLAYBACK**

# **#1**

# **MAY 22, 2020**

After the lockdown began in March of 2020, The 52nd Street Project began using the Zoom platform to continue our regular programming online for our young members. Playback, in which young people write a play to perform with an adult partner, was done twice in 2020

The finished plays of each class were performed on Zoom to a very small online audience. The first one was performed on May 22, 2020. There was no written show program at that time. The program you are reading was created in January, 2022.

**Playback Teacher/Director:  
Natalie Marshall Hirsch**

**Mount Olaska**

by Alex Torres, age 13  
Co-starring Michael Propster

**Sitting on the Sidelines**

by Amari DuBose, age 14  
Co-starring Ronald Peet

**How I Won the Cook-Out**

by Gilbert Rosario, age 14  
Co-starring Jose-Maria Aguila

**We're All In This Together**

by Kassandra Sinchi, age 12  
Co-starring Eliza Huberth













**Water and Wind Are the Best Elements**

by Lanai Blake-Soden, age 12  
Co-starring Madeline DeFreece

**Two Friends, Two Sisters**

by Quilvis Medina, age 12  
Co-starring Angelica Toledo



EXPANSIVE PARKING 	12TH AVENUE	54TH STREET	SUBWAY  ↓	51ST STREET	HUDSON RIVER 	11TH AVENUE	GO TO COLUMBUS CIRCLE FOR FREE TREATS 
49TH STREET						COLUMBUS AVENUE	
50TH STREET						TAKE A CHANCE ON WINNING A GOOD TIME ? 	
SUPPORT OUR COMMUNITY CHEST 						AMSTERDAM AVENUE	
COLUMBUS CIRCLE						SUPPORT OUR COMMUNITY CHEST 	
TAKE A CHANCE ON WINNING A GOOD TIME ? 						TIMES SQUARE	
WEST SIDE HIGHWAY						BROADWAY	
COURTNEY PARK 	52ND STREET	SUPPORT OUR COMMUNITY CHEST 	10TH AVENUE	A SUBWAY 	9TH AVENUE	53RD STREET	THE 52ND STREET PROJECT 52 

# THE 52ND STREET PROJECT GAME CHANGERS

The 2020 Virtual Gala Celebrating  
Two Key Players:  
Crystal Dickinson & Brandon Dirden



The CLAWS Foundation, Morgan Stanley, Yorke Construction,  
 & our Honorary Co-Chairs  
 Jason Dirden & Shanola Hampton  
 invite you to:

## Game Changers Honoring Two Key Players Crystal Dickinson & Brandon Dirden

The 52nd Street Project's very first Virtual Gala!



Every year,  
 The 52nd Street Project  
 throws a big, splashy  
 musical fundraiser  
 that helps us help  
 the young people of  
 Hell's Kitchen.

**This year is  
 no exception.**



**Attend the Virtual Gala!**

A Special Welcome Message by **Lewis Black**  
Your Virtual Hosts **Rose Byrne & Bobby Cannavale**

**The 52nd Street Project Young Lyricists:**  
Andrew, Antonella, Ayah, Crismell, Doris, Evaluna, Hannah,  
Jayden, Kylee, Messiah, & Peter

**Composers:**

Avi Amon, Lydia Breckon, Pablo Concha,  
Sean Eads, Nathan Riebli, Kim Sherman & Enzo Viego

**Performances By:**

Marinda Anderson  
& Adrienne C. Moore

Mallory Portnoy

Michael Potts

Annaleigh Ashford  
& Joe Tapper

Anika Noni Rose

Edie Falco  
& Stephen Wallem

Shirley Rumierk  
& Robin de Jesús

Amber Gray

Natalie Walker

Performers' appearances subject to change.



**HOW DOES THE VIRTUAL GALA WORK?**

*Every 2-3 days we will release a new performance online on our  
Virtual Gala Page*

*Each new performance will feature songs with lyrics written  
by Project young people.*

*So check back often and follow us on social media  
for up to date song release information.*

**Attend the Virtual Gala!**

***Like what you see?  
Give a Little or Give a Lot  
Visit Once or Visit Often***

**With your help, we can reach our fundraising goal and continue to provide after-school arts education programming for the young people of Hell's Kitchen.  
(Even now as all of our programming has moved online.)**



Need more information? Or other questions?

Please contact Director of Development Kali Crandall at [crandall@52project.org](mailto:crandall@52project.org).



*Copyright © 2022 The 52nd Street Project, All rights reserved.  
You opted in!*

**Our mailing address is:**  
The 52nd Street Project  
789 10th Avenue  
New York, NY 10019

[Add us to your address book](#)

Want to change how you receive these emails?  
You can [update your preferences](#) or [unsubscribe from this list](#).





ART BY  
FAITH



ART BY  
SABRINA

# LIGHTING THE

THE  
ILLUMINATING  
PLAYS

# LAMP

ART BY  
EVALUNA



YOU ARE INVITED TO  
THE JUNE PLAYMAKING ZOOM SHOW!

Wednesday, June 24 at 4:00 p.m.  
See email for full details!

ART BY  
MARIA



# PANDEMIC PLAYMAKING #3

After the lockdown began in March of 2020, The 52nd Street Project began using the Zoom platform to teach a series of Playmaking classes to young members who were now nearly housebound. The finished plays of each class were performed on Zoom to a very small online audience. Four such mini-productions were done between April and July. This third one was performed June 24, 2020. The program you are reading was created in January, 2022.

## **Playmaking Teacher/Director: Kat Almirañez**

### **Class Volunteers**

Andrea Abello, Christian DeMarais, Ceci Fernandez, Rachel Lin,  
Brisa Muñoz, Charlie O'Rourke, Evan Schultz, John Sheehy

## **The Argue**

by Xavier Valentin, age 11  
with Ana Soto & Veronika Chernitska  
Dramaturge/Director: John Sheehy  
Composer: Kim Jinhyoung.

## **Gardens in 2050**

by Tiffany Yam, age 12  
with Joey Santia & Rose Meriam  
Dramaturge/Director: Andrea Abello  
Composer: Eric March.

## **The Dojo**

by Derek Rey, age 16  
with Cody Wilson & Greg Stone  
Dramaturge/Director: Rachel Lin  
Composer: Enzo Veiga.

## **It All Started with Coffee and Tea**

by Sarah Lopez, age 13  
with Jenelle Chu & Eston Fung  
Dramaturge/Director: Ceci Fernandez  
Composer: Katie Madison.

## **Enemies 2 Friends**

by Loyal Jones, age 12

with Annabelle Cousins & Conor Proft

Dramaturge/Director: Christian DeMarais

Composer: Stephen Stocking.

## **Porkchop Lettuce**

by Melanie Correa, age 12

with Marielle Young & Steven Lee Johnson

Dramaturge: Evan Schultz

Director: Charlie O'Rourke

Composer: Cody Owen Stine.

## **Title (That's The Name)**

by Xavier Espinal, age 12

with Biko-Eisen-Martin & Kara Young

Dramaturge/Director: Brisa Muñoz

Composer: Rachel Dean.



Ana



Tiffany



Kassandra



# IN SEARCH OF OUR ROOTS: BRANCHING OUT

The 52nd Street Project  
Teen Ensemble's  
Summer 2020 Production

Thursday, July 30th  
at 5:00 pm. on ZOOM.

Need more detail?  
See your Email!

"Small art" by Tiffany



Evaluna



Aishling



Caylyn

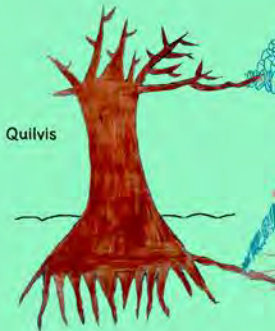

Quilvis

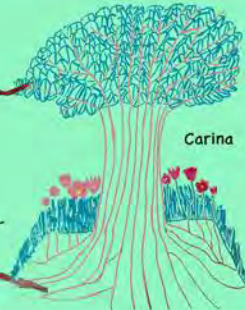

Carina



George



Elli

The trees on this flyer were created by young people and their adult mentors this summer in one of The 52nd Street Project's online Artmaking classes.



## Teen Ensemble Teacher/Director: Kat Almiranez

Throughout the pandemic summer of 2020, **Kat Almirañez** continued working remotely with the members of the **Teen Ensemble** and helped them to create an original play called *Branching Out: In Search of Our Roots*.

The piece grew from individually written monologues, which were then passed along to other teen members to expand and expound upon, resulting in individual storylines that were sewn together by the group. It was not expected that the monologues would bear fruit to a story that took place over several generations that were linked by the theme of “lessons we learn through our grandparents.”

The company presented *In Search of Our Roots: Branching Out* on Zoom at the end of July. The members involved in the show were **Darby O’Donnell, Lakshmi DeJesus, Magalis Fabian, and Nicole Quiles**.

Kat was assisted by volunteers **Ciana Proto, Ana Gonzalez Soto, and Sophia Zukoski**



The 52nd Street Project Presents

# SPINNING THE WEB

## THE TANGLED PLAYS

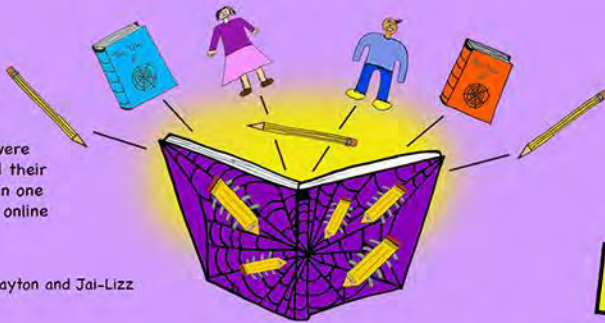

The images on this flyer were created by young people and their adult mentors this summer in one of The 52nd Street Project's online Artmaking classes.

Art by Clayton and Jai-Lizz

**DETAILS  
IN E-MAIL!**

## The July 2020 Virtual Playmaking Plays

Art by  
Ana



Art by Arianna



Art by  
Betsy



**Friday, July 31 • 4:00-5:30 p.m. on Zoom**

Art by  
Evan



Art by  
Evan



Art by  
Xavier



# PANDEMIC PLAYMAKING #4

After the lockdown began in March of 2020, The 52nd Street Project began using the Zoom platform to teach a series of Playmaking classes to young members who were now nearly housebound. The finished plays of each class were performed on Zoom to a very small online audience. Four such mini-productions were done between April and July. This fourth one was performed July 31, 2020. The program you are reading was created in January, 2022.

## **Playmaking Teacher/Director: Kat Almirañez**

### **Class Volunteers**

Angel Desai, Devin Haqq, Tim J. Lord,  
Colette Robert, Kerry Warren

### **The Fortnite God**

by Matthew Berrios, age 10  
with Bill Camp & Elizabeth Marvel  
Director: Colette Roberts  
Composer: Avi Amon.

### **The Digger**

by Andrew Moore, age 11  
with Tedra Millan & Saamer Usmani  
Dramaturge-Director: Tim J. Lord  
Composer: Rona Siddiqui.

### **In Out and Through**

by Olive Moayed, age 11  
with Ka-Ling Cheung & Joe Osheroff  
Dramaturge-Director: Kerry Warren  
Composer: Richie Walter.

### **Rabbits & Turtles**

by Gavin Kent, age 11  
with Korey Jackson & Toussaint Jeanlouis  
Dramaturge-Director: Devin Haqq  
Composer: Jacinth Greywoode.

# **Manure Doesn't Smell That Bad**

by Lanai Soden-Blake, age 12

with Luisa Sermol & Tom Gough

Dramaturge-Director: Angel Desai

Composer: Teresa Lotz



First Day at Dad's Store by Sophia



First Dive Parts 1 and 2 by Jai-Lyzz



First Game of 4-Square Part 1 by Betsy



First Time Cooking by Kaytie



First Date Part 1 by Evan



Small art by Sophia

The 52nd Street Project presents

# THIRST FOR A FIRST

FIRST-HAND TALES OF FIRST EXPERIENCES

The August 2020 StoryTelling Show  
Wed., August 12th  
at 4:15 on ZOOM.

Need more detail?  
See your email.



The images on this flyer were created by young people and their adult mentors this summer in one of The 52nd Street Project's online Artmaking classes.



First Day at Dad's Store by Ana



First Swimming Lesson by George



First Game of 4-Square Part 2 by Arianna



First Ride on a Go-Kart by Clayton



First Date Part 2 by Evan

# **VIRTUAL** **PLAYBACK**

## **#2**

## **AUGUST 13, 2020**

After the lockdown began in March of 2020, The 52nd Street Project began using the Zoom platform to continue our regular programming online for our young members. Playback, in which young people write a play to perform with an adult partner, was done twice in 2020

The finished plays of each class were performed on Zoom to a very small online audience. The second one was performed on August 13, 2020. There was no written show program at that time. The program you are reading was created in January, 2022.

**Playback Teacher/Director:  
Natalie Marshall Hirsch**

**Into the Labyrinth**

by Aaron Ordinola, age 13

Co-starring Keshav Moodliar

**Extraordinary Talents, Extraordinary Bonds**

by Hannah Leon, age 13

Co-starring Kendall Cafaro

**The Fisherman and the Gamer**

by Ivan Garcia, age 13

Co-starring Cody Wilson

**The Different Friendship**

by Jade Johnson, age 14

Co-starring Leta Renée-Alan

**Glizzy Gobbla**

by Joel Gokalp, age 13

Co-starring Alex J. Gould

**It's Just Business**

by Xavier Espinal, age 12

Co-starring Marchánt Davis



# SHOW PROGRAMS 2021

(Pandemic Year 2)



THE 52ND STREET PROJECT PRESENTS

A ZOOM  
PLAYMAKING SHOW

5 PLAYS WRITTEN  
BY YOUNG PEOPLE  
AND PERFORMED  
BY ADULT ACTORS

NATALIE HIRSCH,  
ARTISTIC DIRECTOR

KAT ALMIRÁÑEZ,  
PLAYMAKING DIRECTOR

CAROL OCHS,  
EXECUTIVE DIRECTOR



ARTWORK BY LEE ROSEN

**FREE!**  
BUT DONATIONS  
ARE WELCOME!

# SMOKE & MIRRORS

**PART 1**  
**THE TRICKY PLAYS**

**THURSDAY, JANUARY 28 AT 7:00 P.M.**

**ON YOUR PERSONAL COMPUTER OR DEVICE**

RESERVE AT [52PROJECT.ORG](https://52PROJECT.ORG) AND YOU'LL RECEIVE A ZOOM LINK VIA EMAIL.

The Playmaking Program is made possible by funds from Consolidated Edison, Inc., The New York City Department of Cultural Affairs in partnership with the City Council, and with public funds from The New York State Council on the Arts, a state agency. The Project is a member of ART/NY and Theatre Communications Group.

Due to COVID-19 pandemic, live performance  
was cancelled in March, 2020.

Part 1 was finally presented on Zoom  
in January of 2021.

# SMOKE & MIRRORS: THE TRICKY PLAYS – PART I

Virtual Playmaking 2021 - January 28 - 7:00 p.m.

## All original music composed by Avi A. Amon

### THE BULLY FRIEND

Written by Faith Mitchell, age 11

Dramaturge: Caylyn Wan-Creager. Director: Sarah Krohn

Madison ..... Madeline DeFreece

Marcus ..... John Manolis

*I'm Sorry and Differences* lyrics by Faith Mitchell

### COMEDY SHOW

Written by Mason Berrios, age 19

Director/Dramaturge: George Babiak

Josh, a comedian ..... Lee Aaron Rosen

Heckler/heckler ..... Ariel Estrada

Mom ..... Kat Almirañez

*Comedy Song* lyrics by Mason Berrios

### THE BASKETBALL BOY AND DANCING GIRL

Written by Tremaine Batson age 10

Dramaturge: Kareem M. Lucas, Director: John Sheehy

Basketball Boy ..... Motell Foster

Dancing Girl ..... Arielle Goldman

Judge ..... John Sheehy

*Dancing Girl's Song* lyrics by Tremaine Batson

### REVOLUTION

Written by Gavin Kent, age 10

Dramaturge/Directors: Kat Almirañez and Gus Rogerson

Joe, a snake and potato farmer ..... Carson Elrod

Sheen, a snake and tax collector ..... Evan Schultz and Gus Reale

*I'm Better Than You* lyrics by Gavin Kent

### MOKINA AND CUPY

Written by Jessica Elie-Pierre, age 9

Director/Dramaturge: Grace Rex

Mokina ..... Jenelle Chu

Cupy ..... Erin Neuffer-Salt

*Don't Lie* lyrics by Jessica Elie-Pierre



**THE VIRTUAL TEEN ENSEMBLE  
PERFORMANCE**

**FEBRUARY 25, 2021**

## Teen Ensemble Teacher/Director: Kat Almiranez

*Topic: Roomies!!* Fall 2k21 planning seshhh, written by **Garrett David Kim** and directed by **Ciana Proto**, starred **Darby O'Donnell**, **Lakshmi DeJesus**, & **Nicole Quiles** as freshmen wondering what their dorm assignments would be like.

*Uof* written by **Caylyn Wan-Creager** and directed by **Danaya Esperanza**, featured **Lauren Amador-Cruz** as a student shocked by a sock on her doorknob. **Magalis Fabian** was the worldly Resident Advisor who helped teach Lauren's randy roommate a lesson in personal boundaries.



Nicole, Lakshmi, and Darby in *Topic: Roomies...*

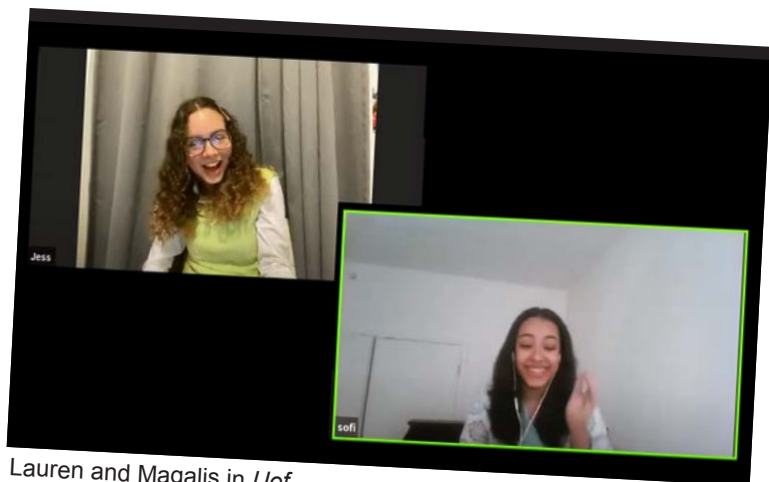

Lauren and Magalis in *Uof*.

THE 52ND STREET PROJECT PRESENTS

A ZOOM  
PLAYMAKING SHOW

5 MORE PLAYS WRITTEN  
BY YOUNG PEOPLE  
AND PERFORMED  
BY ADULT ACTORS

NATALIE HIRSCH,  
ARTISTIC DIRECTOR  
KAT ALMIRANEZ,  
PLAYMAKING DIRECTOR  
CAROL OCHS,  
EXECUTIVE DIRECTOR



ARTWORK BY LEE ROSEN

**FREE!**  
BUT DONATIONS  
ARE WELCOME!

# SMOKE & MIRRORS

**PART 2**

## THE TRICKY PLAYS

**THURSDAY, MARCH 25 AT 7:00 P.M.**

**ON YOUR PERSONAL COMPUTER OR DEVICE**

RESERVE AT [52PROJECT.ORG](http://52PROJECT.ORG) AND YOU'LL RECEIVE A ZOOM LINK VIA EMAIL.

The Playmaking Program is made possible by funds from Consolidated Edison, Inc., The New York City Department of Cultural Affairs in partnership with the City Council, and with public funds from The New York State Council on the Arts, a state agency. The Project is a member of ART/NY and Theatre Communications Group.

Due to COVID-19 pandemic, live performance  
was cancelled in March, 2020.

Part 2 was finally presented on Zoom  
in March of 2021.

# SMOKE & MIRRORS: THE TRICKY PLAYS - PART II

Virtual Playmaking 2021 - March 25 - 7:00 p.m.

## All original music composed by Avi A. Amon

### SWAP DAY

Written by Kylie Rose Rivera-Beato, age 9

Dramaturge: Ana Gonzalez-Soto. Director: Leta Renee-Alan

Crisabella..... Kendall Cafaro

Darlene..... Carolyn Holding

Validena..... Ana Gonzalez-Soto

*My Sorrys* lyrics by Kylie Rose Rivera-Beato

### HOW ZOMBIES MAKE US FEEL?

Written by Olive Moayed, age 11

Director/Dramaturge: Ashley Marie Ortiz

Zara, a gardener..... Lynne Rosenberg

Sunny, a lifeguard..... Keshav Moodliar

*Feelings* lyrics by Olive Moayed

### THE BATTLE BEGINS

Written by Matthew Berrios, age 9

Dramaturge: Julio Chavez, Director: Tim J. Lord

Mecenzy, a singer..... Marinda Anderson

Manny, a rapper..... Kyle Cameron

*Space* and *Back Up* lyrics by Matthew Berrios

### DREAM ANOTHER DREAM

Written by Edgar Sinchi, age 9

Dramaturge/Director: Kyle Fitzpatrick

Hana Stokes, a science student..... Cei Fernandez

Arnold Pit..... Micah Stock

*A Heartbreaking Tragedy* lyrics by Edgar Sinchi

### THE MYSTERY SIBLINGS

Written by Khailey Peña, age 9

Director/Dramaturge: Alex O'Daly

Hayden Carson Renil, a construction worker ..... Neil D'Astolfo

Amy Carson Renil, a Chipotle and Fro-Yo manager ..... Adrienne C. Moore

*Best Friends* lyrics by Khailey Peña



**CAROL OCHS,  
EXECUTIVE  
DIRECTOR**



**NANCY GILES,  
HOST**



**NATALIE HIRSCH,  
ARTISTIC  
DIRECTOR**

# HIDDEN GEMS



**AVI A. AMON,  
MUSICAL  
DIRECTOR**



**THE PERFORMERS:**  
ALLY BONINO  
JESSICA CARVO  
GREG HILDRETH  
BELEN MOYANO  
BONNIE MILLIGAN  
RONALD PEET  
JON-MICHAEL REESE  
HEATH SAUNDERS  
EMILY SKEGGS  
SKYLER VOLPE  
NATALIE WALKER  
and more

**THE COMPOSERS:**  
AVI A. AMON  
UTSAV BHARGAVA  
KAT CARTUSCIELLO  
ERIKA JI  
MASON MCDOWELL  
SEAN PALLATRONI  
BROOKE TRUMM  
JULIO VAQUERO RAMOS



**THE YOUNG SONGWRITERS:**  
NASEEM ABDUL-MAJEED  
AMARI DUBOSE  
JESSICA ELIE-PIERRE  
XAVIER ESPINAL  
GAVIN KENT  
SARAH LOPEZ  
KYLIE ROSE RIVERA-BEATO  
JAI-LYZZ RODRIGUEZ  
AIDEN VASQUEZ

## THE 52ND STREET PROJECT'S 2021 VIRTUAL GALA

A glittering array of songs written by Project kids, set to music, and then performed by the best performers we know.

**May 3-May 16**

Eight music videos released once every couple of days.

**Monday, May 17**

A special LIVE online performance livestreamed from the **Power Station at BerkleeNYC.**

### **HOW DO I ATTEND?**

Easy! On or after May 3, just go to [www.52projecthiddengemsgala.org](http://www.52projecthiddengemsgala.org)

and you'll be able to watch and stream all the recorded and live performances.

All we ask is that you make a donation of any size!

THE 52ND STREET  
PROJECT PRESENTS

LIVE!

LIVE!

ARTWORK BY PATRICK JONES



THE VERY FIRST SUMMER PLAYMAKING SHOWS!  
PLAYS WRITTEN BY KIDS AND PERFORMED **LIVE ONSTAGE** BY ADULT ACTORS

STEP ONE:  
FRIDAY, AUGUST 13  
AT 5:00 AND 7:30 P.M.  
FOUR ALL-NEW PLAYS BY ALL-NEW KIDS

IN-PERSON AND LIVESTREAMED FROM  
**THE FIVE ANGELS THEATER**  
789 10TH AVE., BETWEEN 52ND & 53RD ST.



# WALKING ON SUNSHINE: THE RADIANT PLAYS. STEP ONE!

Summer Playmaking, - Friday, August 13, Five Angels Theater

## The 52nd Street Project Staff

Kat Almirañez, Associate Artistic Director

Avi A. Amon, Musical Director

Ahmed Attia, Development Manager\*

George Babiak, Director of Design and Production

Liz Bell, Clinical Consultant

Natalie Hirsch, Artistic Director

Garrett Kim, Program Director

Kristina Nungaray, Marketing and Events Manager

Carol Ochs, Executive Director

John Sheehy, Director of Institutional Advancement

Johanna Vidal, Director of Education\*

Caylyn Wan-Creager, Education Associate

Iris A. Brown, Graphic Design Consultant

*\*Project Alumni*

## “WALKING ON SUNSHINE - STEP ONE” Production Staff

### Composer/Music Director

Avi A. Amon

### Set Designer

Burke Brown

### Lighting Designer

Greg MacPherson

### Costume Designer

Michael Piatkowski

### Sound Designer

Alicia Moeller

### Stage Manager

Margo Gleberman

### Projection Designs

George Babiak and  
The Project Projection Archive

### Prop Design and Construction

George Babiak,

Caylyn Wan-Creager

### Backstage Crew

Evan Schultz,

Ana Soto,

Alex Torres

### House Management

Carol Ochs,

John Sheehy

### Flyer/Program Art

Patrick Jones



The Playmaking Program is made possible with public funds from The New York State Council on the Arts, a state agency, and the New York City Department of Cultural Affairs. The 52nd Street Project is a member of Art/NY and Theatre Communications Group (TCG), the national organization for the American theatre.

# WALKING ON SUNSHINE: THE RADIANT PLAYS - STEP 1

All original music composed by Avi A. Amon

## THE FRIENDSHIP

Written by Evelyn Meyers, age 11  
Dramaturge/Director: Kaaron Briscoe

Hernandez, a college student..... Grace Fojtik  
Alex, another college student ..... Greg Hildreth  
Ms. K, the principal ..... Evan Schultz

*My Ruined Dreams* lyrics by Evelyn Meyers

## CARING

Written by Payton Jones, age 10  
Dramaturges: Sophia Zukoski and Caylyn Wan-Creager, Director: Alex O'Daly

Ava, a normal person, aged 11..... Vanessa Porras  
John, a person who has good vibes ..... Jose Duran  
Customers ..... The Crew

*Forgiving and Funny Crazy* lyrics by Payton Jones

## THE FOREST

Written by Elisa Ramos, age 11  
Dramaturge: Grace Fojtik. Director: Michael Propster

Nina, a French farmer..... Arielle Goldman  
Eric, an ice cream entrepreneur ..... Korey Jackson  
Animals..... The Crew  
The trees ..... Evan Schultz and Ana Soto

*What Do I Do to Save You?* lyrics by Elisa Ramos

## THE DANCING LIONS

Written by Gloria Sanchez, age 10  
Dramaturge/Director: Molly Carden

Linda Gonzee, a “dabbing” lion ..... Madeline DeFreece  
Leslie Gonzee, a “flossing” lion ..... Alex J. Gould  
Principal..... Ana Soto

*Remember the Treasure* lyrics by Gloria Sanchez



## The 52nd Street Project Board of Directors

Lisa Benavides	Noël Mihalow
Rachel Chanoff	Roseline Michael Neveling
Cathy Dantchik, co-chair	Carol Ochs
Carolyn DeSena	Margaret Odette
Louis P. Friedman, co-chair	Willie Reale, founder
Robert Goldberg	Shirley Rumierk, alumni member
Stephen Graham, chair emeritus	José Soto, Jr., alumni member
Annie Hausmann	Merritt Tilney
Natalie Hirsch	Wendy vanden Heuvel
Korey Jackson	Alexandra Vassilaros
Valerie Kay	Mark Whatley

---

### What's Going On Here?

The 52nd Street Project is a non-profit organization that brings children from the Hell's Kitchen neighborhood together with professional theater artists to create original theater. **WALKING ON SUNSHINE** is a production of our Playmaking program. Young people participated in a playwriting course taught by Kat Almirañez or Garrett Kim and adapted for the Project by Daniel Judah Sklar from his book *Playmaking: Children Writing and Performing Their Own Plays*. At the end of the course, each child was matched with two actors and a dramaturg/director who guided him or her through the writing of a play. This performance is the end result.

This edition marks the in-person return of children to The 52nd Street Project Clubhouse and The Five Angels Theater. We normally would have taken the students to the country, but this is not possible yet. However, we are delighted and grateful to be working with them in a live, present way.

---

### In-Kind Contributions

Abbeville Press; Ambassador Theatre Group; Avi & Richard Anthony; Ardesia; Kate & Andy Bellin; Lewis Black; Iris A. Brown Design; Cellar 53; William Curran, A Curran Affair; The Daily Show's Trevor Noah; Michael Dorf & City Winery; Dormify.com; Sean Feeney, MISI; Haru Restaurant of Hell's Kitchen; Celia Keenan-Bolger; Karen Kowgios of Withum, Smith, & Brown; Pamela Liebman, The Corcoran Group; Charlie Marshall; Stella McCartney; Michter's Distillery, LLC Noël Mihalow & Prime Films; The Neveling Family; Lauren Friedman, Pharma/Omni Printing; Winston Rodney Photography; Signature Bank; SHOWTIME; The Surrey; Merritt Tilney & Doug Kaden; Vassilaros & Sons Coffee Company; Alex Vassilaros & The Vassilaros Family; The Watkins Company; Vicki & Mark Whatley and Paul, Rifkind, Wharton, & Garrison LLP.

---

### Special Thanks

Gratitude must be paid to the Playmaking Class volunteers who helped out: Sophia Zukoski, Molly Carden, Kaaron Briscoe, and Gracie Fojtik

The 52nd Street Project gratefully acknowledges the support of the following foundations & corporations: Carol M. & Stephen E. Canter Family Foundation; Cantor Fitzgerald Relief Fund; Carnegie Corporation of New York; The CLAWS Foundation; Consolidated Edison; Dawkins Family Foundation; Dramatists Play Service, Inc.; The Jean & Louis Dreyfus Foundation; The Education Foundation of America; Flexis Capital, LLC; Goldman Sachs; The Horace W. Goldsmith Foundation; The Stephen P. Hanson Foundation; Heisman Trophy Trust; The William and Flora Hewlett Foundation; Howard Ashman Trust for Theater Arts Lemle Pictures, Inc.; The Lotos Foundation; Frederick Loewe Foundation; The Rona & Randolph M. Nelson Foundation; Seller-Lehrer Family Foundation; The Stavros Niarchos Foundation; Par Plumbing Co., Inc.; The Pinkerton Foundation; Sawyer | Berson Architecture & Landscape Architecture; The Morris and Alma Schapiro Fund; Showtime Networks; The Shubert Foundation; The Harold & Mimi Steinberg Charitable Trust; Susquehanna Foundation; Tiger Baron Foundation; John A. Vassilaros & Sons, Inc.; Yorke Construction Corp.; Zubatkin Owner Representation, LLC. We also acknowledge the following individual donors (over \$250) to The 52nd Street Project:

Alexandra Vassilaros	Francine Borgenicht	Mary Kong & Sol Reischer
Alphonsa Vadakethalake	Frank Wood & Kay Gayner	Mary Pat Walsh
Amy Herzig	Gavin Berger & Craig Berggren	Megan Cramer
Andrea Johnson	Glen Gillen	Melissa Lowry
Annie & David Hausmann	Helen & Peter Randolph	Merritt Tilney & Douglas M. Kaden
Becky & Dylan Baker	Henry Krieger & Robert Joy	Michael & Megan Crane
Beth & Bob Ollwerther	Jacki Ochs & Jan Kroeze	Patrice & Louis Friedman
Beth Barry and Daniel Sussman	Jane & Greg MacPherson	Peter Ackerman
Billy Crudup	Jeannie & Jim Gaffigan	Peter Francis James
Bob Stockel	Jeff Arnold	Randy Weisenberger
Carl Capotorto	Jené LeBlanc & Willie Reale	Richard Sweren
Carol Ochs & Bruce MacVittie	Jeremy Smith	Rita Silver
Carole and Alan Howard	Jerry McGill	Ron & Judy Tierney
Carole Yass	Jessica Hecht & Adam Bernstein	Rona & Randy Nelson
Carolyn DeSena	John Rossi	Rose Gasner & Larry Chertoff
Christina Morelli	Jonathan & Clara Cohen	Roseline Michael & Dennis Neveling
Chrysti & David Eigenberg	Josie Merck	Ruth Nelson
Cynthia Kaplan & David Froelich	Judy & Sam Berger	Sarah Horowitz & David Venarde
Cynthia Vance-Abrams & Robert Abrams	Judy Taub Gold	Seth Marx
Danielle Mindess & Robert Cohen	Karen & Paul Freitas	Shari Goodstein
David Williams	Karin & Tom Schall	Sherry Cohen
Deborah Kim	Katie & Kelly Clark	Shirley Rumierk & Armando Riesco
Denise Burse & Peter Jay Fernandez	Katrina vanden Heuvel	Stephen Bernstein
Don Nickel	Kevin Ryder	Stephen Graham
Douglas Kabel	Kim & Jordan Dickstein	Stephen Sadove
Edith Thurber & Kevin O'Rourke	Kimberly Grigsby	Steven & Lenora Satin
Ellen Chopay	Laura & David Ross	Susannah Keagle
Ellen Kroll	Laura Jones	Sylvia Shepard & Willy Holtzman
Ellen Oshinsky	Laura Valeroso & David Seidman	Tracy Wan & Carl Creager
Emily Grishman & Susan Sampliner	Laurel Durst	Valerie Kay & Bruce Graham
Eric Brooks	Lewis Black	Vicki & Craig Holleman
Eric Jungwirth	Lisa Benavides & Tim Blake Nelson	Vicki & Mark Whatley
F. Richard Pappas	Lori O'Connor	Wendy vanden Heuvel & Brad Coley
Frances McDormand & Joel Coen	Lynne Rosenberg	Yared Yawand Wossen
	Margaret & Peter O'Brien	

List current as of Aug. 13, 2021

THE 52ND STREET  
PROJECT PRESENTS

LIVE!

LIVE!

ARTWORK BY PATRICK JONES



THE VERY FIRST SUMMER PLAYMAKING SHOWS!  
PLAYS WRITTEN BY KIDS AND PERFORMED **LIVE ONSTAGE** BY ADULT ACTORS

**STEP TWO:**  
FRIDAY, AUGUST 20  
AT 5:00 AND 7:30 P.M.  
THREE ALL-NEW PLAYS BY ALL-NEW KIDS

IN-PERSON AND LIVESTREAMED FROM  
**THE FIVE ANGELS THEATER**  
789 10TH AVE., BETWEEN 52ND & 53RD ST.

# WALKING ON SUNSHINE: THE RADIANT PLAYS. STEP TWO!

Summer Playmaking, - Friday, August 20, Five Angels Theater

## The 52nd Street Project Staff

Kat Almirañez, Associate Artistic Director

Avi A. Amon, Musical Director

Ahmed Attia, Development Manager\*

George Babiak, Director of Design and Production

Liz Bell, Clinical Consultant

Natalie Hirsch, Artistic Director

Garrett Kim, Program Director

Kristina Nungaray, Marketing and Events Manager

Carol Ochs, Executive Director

John Sheehy, Director of Institutional Advancement

Johanna Vidal, Director of Education\*

Caylyn Wan-Creager, Education Associate

Iris A. Brown, Graphic Design Consultant

*\*Project Alumni*

## “WALKING ON SUNSHINE - STEP TWO” Production Staff

### Composer/Music Director

Emily Gardner Xu Hall

### Set Designer

Burke Brown

### Lighting Designer

Jade Barnett-Irons

### Costume Designer

Jennifer Jones

### Costume Assistant

Valentina Primrose

### Sound Designer

John Sheehy

### Stage Manager

Margo Gleberman

### Projection Designs

George Babiak and

The Project Projection Archive

### Prop Design and Construction

George Babiak

### Backstage Crew

Evan Schultz,

Ana Soto,

Alex Torres

### House Management

Carol Ochs, John Sheehy,

Kristina Nungaray

### Flyer/Program Art

Patrick Jones

### Livestream Team

Director: George Babiak

Camera Ops: Ahmed Attia,

Kristina Nungaray, Sofia Santoni



The Playmaking Program is made possible with public funds from The New York State Council on the Arts, a state agency, and the New York City Department of Cultural Affairs. The 52nd Street Project is a member of Art/NY and Theatre Communications Group (TCG), the national organization for the American theatre.

# WALKING ON SUNSHINE: THE RADIANT PLAYS - STEP 2

All original music composed by Emily Gardner Xu Hall

## PASS THE MIC

Written by Brooke Pendleton, age 9

Dramaturge: Kristina Nungaray. Director: Helen Cespedes.

Ally, works at Radio Place ..... Sarah Quigley

Allan, her brother, wants to work at Radio Place..... Jose-Maria Aquila

Radio Place Cameraman ..... Alex Torres

*Some Random Song* lyrics by Brooke Pendleton

## THE INCIDENT

Written by Rebeca Vanterpool, age 10

Dramaturge: Elli Stovall Brown. Director: Kerry Warren.

Dol, a green axolotl (a kind of cute salamander)..... Marchánt Davis

E, a living burrito..... Olivia Gilliatt

*The Burrito Dance Song* lyrics by Rebeca Vanterpool

## THE BEST DAY OF MY LIFE

Written by Valerie Lugo-Rodriguez, age 9

Dramaturge: Ana Gonzalez-Soto. Director: Monica LaBadia.

Max, a 17-year old tomboy ..... Kate Abbruzzese

Maxine, a 15-year old tomboy ..... Angelica Toledo

Riceerd (pronounced "Richard") ..... Ana Gonzalez-Soto

Person ..... Evan Schultz

*Everything is Gonna Be Alright* lyrics by Valerie Lugo-Rodriguez



## The 52nd Street Project Board of Directors

Lisa Benavides	Noël Mihalow
Rachel Chanoff	Roseline Michael Neveling
Cathy Dantchik, co-chair	Carol Ochs
Carolyn DeSena	Margaret Odette
Louis P. Friedman, co-chair	Willie Reale, founder
Robert Goldberg	Shirley Rumierk, alumni member
Stephen Graham, chair emeritus	José Soto, Jr., alumni member
Annie Hausmann	Merritt Tilney
Natalie Hirsch	Wendy vanden Heuvel
Korey Jackson	Alexandra Vassilaros
Valerie Kay	Mark Whatley

---

### What's Going On Here?

The 52nd Street Project is a non-profit organization that brings children from the Hell's Kitchen neighborhood together with professional theater artists to create original theater. **WALKING ON SUNSHINE** is a production of our Playmaking program. Young people participated in a playwriting course taught by Kat Almirañez or Garrett Kim and adapted for the Project by Daniel Judah Sklar from his book *Playmaking: Children Writing and Performing Their Own Plays*. At the end of the course, each child was matched with two actors and a dramaturg/director who guided him or her through the writing of a play. This performance is the end result.

This edition marks the in-person return of children to The 52nd Street Project Clubhouse and The Five Angels Theater. We normally would have taken the students to the country, but this is not possible yet. However, we are delighted and grateful to be working with them in a live, present way.

---

### In-Kind Contributions

Abbeville Press; Ambassador Theatre Group; Avi & Richard Anthony; Ardesia; Kate & Andy Bellin; Lewis Black; Iris A. Brown Design; Cellar 53; William Curran, A Curran Affair; The Daily Show's Trevor Noah; Michael Dorf & City Winery; Dormify.com; Sean Feeney, MISI; Haru Restaurant of Hell's Kitchen; Celia Keenan-Bolger; Karen Kowgios of Withum, Smith, & Brown; Pamela Liebman, The Corcoran Group; Charlie Marshall; Stella McCartney; Michter's Distillery, LLC Noël Mihalow & Prime Films; The Neveling Family; Lauren Friedman, Pharma/Omni Printing; Winston Rodney Photography; Signature Bank; SHOWTIME; The Surrey; Merritt Tilney & Doug Kaden; Vassilaros & Sons Coffee Company; Alex Vassilaros & The Vassilaros Family; The Watkins Company; Vicki & Mark Whatley and Paul, Rifkind, Wharton, & Garrison LLP.

---

### Special Thanks

Gratitude must be paid to the Playmaking Class volunteers who helped out: Elli Stovall Brown, Ana Gonzalez-Soto, and Kristina Nungaray.



The 52nd Street Project gratefully acknowledges the support of the following foundations & corporations: Carol M. & Stephen E. Canter Family Foundation; Cantor Fitzgerald Relief Fund; Carnegie Corporation of New York; The CLAWS Foundation; Consolidated Edison; Dawkins Family Foundation; Dramatists Play Service, Inc.; The Jean & Louis Dreyfus Foundation; The Education Foundation of America; Flexis Capital, LLC; Goldman Sachs; The Horace W. Goldsmith Foundation; The Stephen P. Hanson Foundation; Heisman Trophy Trust; The William and Flora Hewlett Foundation; Howard Ashman Trust for Theater Arts Lemle Pictures, Inc.; The Lotos Foundation; Frederick Loewe Foundation; The Rona & Randolph M. Nelson Foundation; Seller-Lehrer Family Foundation; The Stavros Niarchos Foundation; Par Plumbing Co., Inc.; The Pinkerton Foundation; Sawyer | Berson Architecture & Landscape Architecture; The Morris and Alma Schapiro Fund; Showtime Networks; The Shubert Foundation; The Harold & Mimi Steinberg Charitable Trust; Susquehanna Foundation; Tiger Baron Foundation; John A. Vassilaros & Sons, Inc.; Yorke Construction Corp.; Zubatkin Owner Representation, LLC. We also acknowledge the following individual donors (over \$250) to The 52nd Street Project:

Alexandra Vassilaros	Francine Borgenicht	Mary Kong & Sol Reischer
Alphonsa Vadakethalake	Frank Wood & Kay Gayner	Mary Pat Walsh
Amy Herzig	Gavin Berger & Craig Berggren	Megan Cramer
Andrea Johnson	Glen Gillen	Melissa Lowry
Annie & David Hausmann	Helen & Peter Randolph	Merritt Tilney & Douglas M. Kaden
Becky & Dylan Baker	Henry Krieger & Robert Joy	Michael & Megan Crane
Beth & Bob Ollwerther	Jacki Ochs & Jan Kroeze	Patrice & Louis Friedman
Beth Barry and Daniel Sussman	Jane & Greg MacPherson	Peter Ackerman
Billy Crudup	Jeannie & Jim Gaffigan	Peter Francis James
Bob Stockel	Jeff Arnold	Randy Weisenberger
Carl Capotorto	Jené LeBlanc & Willie Reale	Richard Sweren
Carol Ochs & Bruce MacVittie	Jeremy Smith	Rita Silver
Carole and Alan Howard	Jerry McGill	Ron & Judy Tierney
Carole Yass	Jessica Hecht & Adam Bernstein	Rona & Randy Nelson
Carolyn DeSena	John Rossi	Rose Gasner & Larry Chertoff
Christina Morelli	Jonathan & Clara Cohen	Roseline Michael & Dennis Neveling
Chrysti & David Eigenberg	Josie Merck	Ruth Nelson
Cynthia Kaplan & David Froelich	Judy & Sam Berger	Sarah Horowitz & David Venarde
Cynthia Vance-Abrams & Robert Abrams	Judy Taub Gold	Seth Marx
Danielle Mindess & Robert Cohen	Karen & Paul Freitas	Shari Goodstein
David Williams	Karin & Tom Schall	Sherry Cohen
Deborah Kim	Katie & Kelly Clark	Shirley Rumierk & Armando Riesco
Denise Burse & Peter Jay Fernandez	Katrina vanden Heuvel	Stephen Bernstein
Don Nickel	Kevin Ryder	Stephen Graham
Douglas Kabel	Kim & Jordan Dickstein	Stephen Sadove
Edith Thurber & Kevin O'Rourke	Kimberly Grigsby	Steven & Lenora Satin
Ellen Chopay	Laura & David Ross	Susannah Keagle
Ellen Kroll	Laura Jones	Sylvia Shepard & Willy Holtzman
Ellen Oshinsky	Laura Valeroso & David Seidman	Tracy Wan & Carl Creager
Emily Grishman & Susan Sampliner	Laurel Durst	Valerie Kay & Bruce Graham
Eric Brooks	Lewis Black	Vicki & Craig Holleman
Eric Jungwirth	Lisa Benavides & Tim Blake Nelson	Vicki & Mark Whatley
F. Richard Pappas	Lori O'Connor	Wendy vanden Heuvel & Brad Coley
Frances McDormand & Joel Coen	Lynne Rosenberg	Yared Yawand Wossen
	Margaret & Peter O'Brien	

List current as of Aug. 13, 2021

The 52nd Street Project Presents

# HEAR ME OUT!

PROGRAM ART BY LAILA SUERO LOYOLA



## THE 2021 SONGMAKING CONCERT

10 original songs written  
by young people and  
composed and performed  
by adult artists.

Directed by Avi A. Amon  
and Garrett David Kim

Thursday, Nov. 18  
7:30 p.m.  
LIVE AND ONLINE

The Five Angels Theater  
789 10th Avenue



ALEX



JAI-LYZZ



KASSANDRA



KYLEE



MORGAN

# HEAR ME OUT!

## THE COMPANY

### The Lyricists

Kylee Chester  
Jai-Lyzz Rodriguez  
Kassandra Sinchi  
Morgan Smalls  
Alex Torres

### The Composers/Musicians

Utsav Bhargava  
John Brautigam  
Julio Vaquero Ramos  
Raiah Rofsky  
Joely Zuker

### Music Director

Avi A. Amon

### Songmaking Director

Garrett Kim

### Lights

Jade Barnett-Irons

### Photography

Winston Rodney

### Fall 2021 Intern

Emma Giordano

### The Singers

Jen Anaya  
Allie Babich  
Kyle Cameron  
Marchánt Davis  
Angel Desai  
Ronald Peet  
Vanessa Porras  
Adrienne C. Moore  
Jon-Michael Reese  
Laura Riveros-Sefair  
Natalie Walker

### Sound and Video

BerkleeNYC at Power Station  
Madison Adams  
Fernando Firmino  
Patrick Greeley  
Linus Kairys  
Jasmine Marie  
Atticus Mulkey  
Jenna Rosebrough  
Yujie Xia

### Special Thanks

The Songmaking Program has been established in collaboration with Fred Carl and the NYU Tisch School of the Arts Music Theater Writing Program. Thanks also to BerkleeNYC at Power Station, who are providing sound and video for this performance. Loudon Stearns of BerkleeNYC also earns a passel of thanks from us.

The Songmaking Program is made possible with public funds from The New York State Council on the Arts, a state agency, and the New York City Department of Cultural Affairs. The 52nd Street Project is a member of Art/NY and Theatre Communications Group (TCG), the national organization for the American theatre.



The 52nd Street Project is a non-profit community-based arts organization that brings children from the Hell’s Kitchen neighborhood together with professional artists to create original art. The Songmaking program partners 52nd Street Project kids with adult composers to create original songs. Over the seven weeks of Songmaking, led by Avi Amon and Program Director Garrett David Kim, these young lyricists explore how their own words and ideas fit together with their composer’s music to create songs. Near the end of the program, we bring in a company of singers to perform the completed songs, and share them with an audience.

**The 52nd Street Project Staff**

- Kat Almirañez, Associate Artistic Director
- Avi A. Amon, Musical Director
- Ahmed Attia, Development Manager\*
- George Babiak, Director of Design and Production
- Liz Bell, Clinical Consultant
- Natalie Hirsch, Artistic Director
- Garrett Kim, Program Director
- Kristina Nungaray, Marketing and Events Manager
- Carol Ochs, Executive Director
- John Sheehy, Director of Institutional Advancement
- Ana Soto-Gonzalez, Receptionist
- Johanna Vidal, Director of Education\*
- Caylyn Wan-Creager, Education Associate
- Bri Weintraub, Production Manager
- Iris A. Brown, Graphic Design Consultant

*\*Project Alumni*

**The 52nd Street Project Board of Directors**

- |                                |                                |
|--------------------------------|--------------------------------|
| Lisa Benavides                 | Noël Mihalow                   |
| Rachel Chanoff                 | Roseline Michael Neveling      |
| Cathy Dantchik, co-chair       | Carol Ochs                     |
| Carolyn DeSena                 | Margaret Odette                |
| Louis P. Friedman, co-chair    | Willie Reale, founder          |
| Robert Goldberg                | Shirley Rumierk, alumni member |
| Stephen Graham, chair emeritus | José Soto, Jr., alumni member  |
| Annie Hausmann                 | Merritt Tilney                 |
| Natalie Hirsch                 | Wendy vanden Heuvel            |
| Korey Jackson                  | Alexandra Vassarlos            |
| Valerie Kay                    | Mark Whatley                   |

Want to make a donation to The 52nd Street Project?  
Just visit [www.52project.org](http://www.52project.org) and click “You Can Help.”

Or make a gift via



@Fifty-Two-Project

# 1. Para Mis Niños

Lyrics by Cassandra Sinchi  
Music by John Brautigam  
Sung by Laura Riveros-Sefair



Para mis niños [for my children]  
I never told you about my life  
The life I never want you to live  
The impossible dreams

I wanted to be a dancer  
I watched the girls twirl  
And noticed how their dresses swirled  
But I knew I could never be a dancer

You see my children  
Money's not something that's easy to get  
My parents worked hours  
But hard as they worked, they could never pay the rent  
The impossible dreams

So I watched the dancers from afar  
I accepted that I could never show my skills  
Or touch the dancers silky skirts  
It was a dream I could never fulfill

And here I stand  
I'm handing you the things I could only dream about  
Hoping you would all do something great  
Only to see you throw this opportunity away  
Que Pérdida!

Mira mis niños [look my children]  
Please be grateful for every class you take  
And that you live a life that I've never seen  
Oh, the impossible dreams.



## 2. What Do We Need? Hedgehogs!

Lyrics by Cassandra Sinchi

Music by John Brautigam

Sung by Natalie Walker



Attention everyone...

It seems we are missing something from our lives

We are missing

Spiky

Bouncy

Yet cuddly guys

We are missing hedgehogsss

Hedeghogssss

We don't need food

We only need

Hedgehogss

Give our world more hedgehogs

With their beady eyes

Expressive face

Spiky fur

And stubby legs

We need more hedgehogsss

These creatures

Are all so cuddly

They are bound

To make you smile

Oh hedgehogsss

Look at their faces!

Doesn't that make you smile?

Our hedgehogs are really worth the while

So give us

Hedgehogsss

Hedgehogss

They're what we truly need



### 3. The Big Stage

Lyrics by Morgan Smalls

Music by Joely Zuker

Sung by Kyle Cameron and Angel Desai

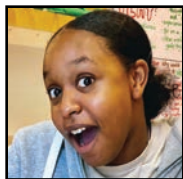

*Kid runs off stage sad to confide in the Dad because the kid gets scared.*

DAD

I knew you were going to embarrass yourself!

*Kid runs away.*

*Verse 1:*

CAT

I hope he's ok  
I hope that he sees another stage

DAD

I hope that he learned his lesson  
Cause singing's not for him

*Pre-chorus 1:*

DAD

I hate seeing my son like that  
Singing is for girls

CAT

Who told you that? Things have changed  
It's not the same world

*Chorus 1:*

CAT

He needs support so don't put him down  
He tried, he got scared, but he made it on the stage

DAD

You're right but I still don't support his singing  
Though I hope he's okay, I hope he doesn't see another stage  
*Verse 2:*

DAD

I don't want my son to think I'm cruel  
I don't want him to give up on his dream,  
but he needs to stay in school

*Pre-chorus 2:*

CAT

I know you hate seeing your son like that  
But singing is for him

DAD

Do you think I approached it wrong?  
Should I make it up to my kid?

*Chorus 2:*

CAT

He needs support so don't put him down  
He tried, he got scared, but he made it on the stage

DAD

You're right, I should support what makes him happy  
I learned my lesson that singing is for him



## 4. Change

Lyrics by Morgan Smalls  
Music by Joely Zuker  
Sung by Adrienne C. Moore



### *Verse 1*

We need more people who love not hate  
The color of my skin is what makes me great  
We all should stand, hand to hand,  
So people can start to understand

### *Pre-chorus 1*

The years will change again and again  
But the real problem is what we did back then

### *Chorus 1*

It doesn't matter if you're black or white  
We're all humans, so alike  
It doesn't matter if you're black or white  
We're all humans, we're so alike.

### *Pre-chorus 2*

The years will change again and again  
But the real problem is what we did back then

### *Chorus 2*

It doesn't matter if you're black or white  
We're all humans, so alike  
It doesn't matter if you're black or white  
We're all humans, we're so alike.





# 5. Safety Blanket

Lyrics by Kylee Chester

Music by Raiah Rofsky

Sung by Vanessa Porras



I feel your hand slip away  
And you disappear into the sea  
Of laughter and music and  
Eyes staring at me

But I have to keep calm  
Before they see just how  
Much I need you with me

But how dare you leave and  
Let me become small when  
There's people around me that  
loom so tall

*(chorus)*

Because you're my safety blanket  
The only familiar face in a space  
Where I have no place

I'm suffocating in the corner,  
With my world spinning fast,  
But the only thing people see is the mask hiding the truth

My eyes dart around the room, searching for something to save me  
I feel my heartbeat in my ears as my thoughts run screaming

I'm falling apart and I can't see you  
I'm on the verge of tears and I need you

*(chorus)*

Because you're my safety blanket  
The only familiar face in a space  
Where I have no place



## 6. Light

Lyrics by Kylee Chester

Music by Raiah Rofsky

Sung by Allie Babich



I watch you wake up in the morning  
With a grin on your loving face  
Ripping me out of my darkened place

I watch you make breakfast with a smile,  
Serving it to me along with your joy  
I could've slept a year longer but I haven't eaten in a while

You wrap me in a hug of earth and security  
And the bright glow inside me restores  
and I no longer feel broken any more

I'm walking on air and light on my feet  
Gleaming with a feeling that simply can't be beat  
I feel my heart growing with the warmth of your smile  
It fills me with an unknown energy and I could walk a mile

I think of you and my whole mood changes  
I didn't know how contagious you would be  
The whole world falls away living just enough space for you and me

For so long I've been alone, drowning in my thoughts  
Unable to come up for air as my mind began to rot

I just can't explain why  
I'm walking on air and light on my feet  
Gleaming with a feeling that simply can't be beat

My head is spinning with the thrill of it all  
The last time I wasn't happy, I can't quite recall  
You are my everything and my everything is you  
Our love story will never end because it's just us two



# 7. Kevin Hart

Lyrics by Alex Torres  
Music by Utsav Bhargava  
Sung by Marchánt Davis



Hello my name is Frank  
And I gotta say that I have some  
interesting tastes  
I like music and I work everyday  
It's a pretty normal life and I'm here  
to stay.  
I'm a studio producer  
Working 9 to 5  
Nothing is ever gonna break-a-my  
stride

Then one day a man came bursting  
through the door  
Looking pretty sweaty from his head  
to the floor.  
Then I wondered then I pondered  
what could the problem be  
He screamed, He shouted saying all  
this nonsense

Kevin Hart is at the front door  
He wants to make a song but why did  
it take him this gosh darn long  
He wants to sing about his height and  
how it doesn't matter  
He finally came out into the light but  
we all know he still needs a ladder

Bring him in I shouted  
Looking at him he looked so delighted  
With that big grin on his face  
He told me the plans  
Checking them, marking them  
Figuring out what to do

Kevin Hart is crazy  
Kevin Hart is funny  
Deep in me wants to believe in him  
But I just can't believe  
This opportunity  
Kevin Hart is pretty cool  
Kevin Hart is a chill dude  
When we got the call  
I'll make sure this song won't fall

I get started and get to planning  
Wondering how I could make this  
great  
Then it hits me  
This will take the cake  
Now I know what to do  
**BRING ME**  
Blue light wear jackets  
Ginger ale  
Small dish of fried chicken  
And finally 1 rare pair of the Air Yeezy  
2 Red Octobers.

Kevin hart is crazy  
Kevin hart is funny  
I made the best song for him  
And all that he likes  
There is no strifes  
Finally here

Kevin Hart!



# 8. Jack and Tammery: The Mightiest Hammer

Lyrics by Alex Torres

Music by Utsav Bhargava

Sung by Jon-Michael Reese



There once was a lad his name was  
Jack  
He is hardworking and that's a fact  
He's a construction Worker just like his  
father and his Mother  
He was working on the job until  
one day a warlock came flying  
Through the great Big Sky.  
The Warlock dropped magic on Jack's  
Hammer letting it come to life.

With the power of this mighty  
Hammer he now became a brand new  
Fighter. Now with this Hammer  
now named Tammery Jack became  
super  
Crazy filled with excitement now  
He can change his voice with this  
power

Oooo I just want to go out and sing and  
fill the world with so much glee.  
Prove to others that anything is  
possible.  
Going up on stage will empower those  
who just need a little push.  
I'll be the one to raise my fist in the air  
No more hiding  
We'll keep on fighting and keep moving  
forward  
Till we can't sing any more.

Now it's time to gooooo  
Get up on my feet  
It's time to go and finally sing  
This won't be a challenge now with this  
talent

On Americas got talent  
Standing on the stage sweating and  
afraid  
I sing my soul out trying to make  
change  
So people will finally know my name  
With Tammery's power I'll show them  
what I can do  
Style and talent is my only proof

The crowd silence as a mouse  
Thinking I was through  
Thought I bring down the whole dang  
house  
Slowly and quietly I start to hear  
applause  
What's this, what's that  
Am I being mocked?  
I turn, I see the crowd is filled with glee.  
I can't believe my eyes they love me  
They cheered my name  
Then took a bow  
I was finally not that lame  
With the judges final votes I was in!

There once was a lad his name was  
Jack  
He is hardworking and that's a fact  
He got to the top with his own talent  
better than all the others  
He now sings with a beautiful voice with  
Tammery by his side  
He made his dreams come true and  
has come out to light.



# 9. A Guide to Create Fun

Lyrics by Jai-Lyzz Rodriguez

Music by Julio Vaquero Ramos

Sung by Jen Anaya



We have so many ordinary objects.  
There are so boring, bland, plain.  
We need more unique and new things.  
Most of the things are lame.  
We need...

Aliens, yeah I mean aliens  
Not the good nor bad ones  
We all could be friends

And instead having people at work as  
your friends.  
We could have aliens to be our new  
friends.  
We could meet new people

The aliens could take us on a trip to  
their planet  
This could be a fun trip for us

Then we need frogs, not just ordinary  
frogs  
Frogs that can dance, can sing, and  
can talk  
This could be a fun nap for us  
These frogs could pop in your dreams  
And pop up in real life.

The frogs could bring comfort to  
Everyone who is stressing about  
School or work.

We need rocket ships! Not like the  
really big ones just rocket ships  
that can fit in a parking garage.  
We could ride them for everyone,  
These rocket ships could be a getaway  
from adults' work  
The adults get to have fun,  
maybe even the first fun they have had  
in a while.

So the reason we need these things is  
to have fun  
Be ourself  
Have no more stress  
Have fun, or even more than before  
there is many things  
There is many things  
Many things we need and could have  
Instead of the things we have right now  
We don't have many of these things  
but if you just think we could imagine  
anything with your imagination  
If we put our mind to it.



# 10. You Don't Have to Be Scared

Lyrics by Jai-Lyzz Rodriguez

Music by Julio Vaquero Ramos

Sung by Ronald Peet



A  
It's ok brother  
It doesn't matter if we're small or big  
They might be bigger  
But we are wiser and we're gonna stay  
We're special in our own way  
You don't have to be scared

A  
You don't have to be scared  
You don't have to be scared  
You don't have to be scared  
You don't have to be scared  
You don't have to be scared  
You don't have to be scared  
You don't have to be scared  
Just love yourself

A  
Think about it brother  
We saw the world change with our own  
eyes  
We saw the things in the world  
We saw people grow up and live their  
lives.  
We have cool things like a magical  
garden  
Leaves on us, no other building has that  
There are a lot of buildings out there.  
You don't have to be scared

B  
When I was little I wanted to be just like  
everyone else.  
I was amazed of how shiny their  
windows were.  
I wanted to be big and tall, the building  
looked so mighty, up so high.  
But then I noticed something , I was  
special inside,  
I didn't want to be like the others, like  
no one.  
I just wanted to be my own self  
I have wisdom, I have beauty



The 52nd Street Project gratefully acknowledges the support of the following foundations & corporations: Carol M. & Stephen E. Canter Family Foundation; Cantor Fitzgerald Relief Fund; Carnegie Corporation of New York; The CLAWS Foundation; Consolidated Edison; Dawkins Family Foundation; Dramatists Play Service, Inc.; The Jean & Louis Dreyfus Foundation; The Education Foundation of America; Flexis Capital, LLC; Goldman Sachs; The Horace W. Goldsmith Foundation; The Stephen P. Hanson Foundation; Heisman Trophy Trust; The William and Flora Hewlett Foundation; Howard Ashman Trust for Theater Arts Lemle Pictures, Inc.; The Lotos Foundation; Frederick Loewe Foundation; The Rona & Randolph M. Nelson Foundation; Seller-Lehrer Family Foundation; The Stavros Niarchos Foundation; Par Plumbing Co., Inc.; The Pinkerton Foundation; Sawyer | Berson Architecture & Landscape Architecture; The Morris and Alma Schapiro Fund; Showtime Networks; The Shubert Foundation; The Harold & Mimi Steinberg Charitable Trust; Susquehanna Foundation; Tiger Baron Foundation; John A. Vassilaros & Sons, Inc.; Yorke Construction Corp.; Zubatkin Owner Representation, LLC. We also acknowledge the following individual donors (over \$250) to The 52nd Street Project:

Alexandra Vassilaros	Francine Borgenicht	Mary Kong & Sol Reischer
Alphonsa Vadakethalake	Frank Wood & Kay Gayner	Mary Pat Walsh
Amy Herzig	Gavin Berger & Craig Berggren	Megan Cramer
Andrea Johnson	Glen Gillen	Melissa Lowry
Annie & David Hausmann	Helen & Peter Randolph	Merritt Tilney & Douglas M. Kaden
Becky & Dylan Baker	Henry Krieger & Robert Joy	Michael & Megan Crane
Beth & Bob Ollwerther	Jacki Ochs & Jan Kroeze	Patrice & Louis Friedman
Beth Barry and Daniel Sussman	Jane & Greg MacPherson	Peter Ackerman
Billy Crudup	Jeannie & Jim Gaffigan	Peter Francis James
Bob Stockel	Jeff Arnold	Randy Weisenberger
Carl Capotorto	Jené LeBlanc & Willie Reale	Richard Sweren
Carol Ochs & Bruce MacVittie	Jeremy Smith	Rita Silver
Carole and Alan Howard	Jerry McGill	Ron & Judy Tierney
Carole Yass	Jessica Hecht & Adam Bernstein	Rona & Randy Nelson
Carolyn DeSena	John Rossi	Rose Gasner & Larry Chertoff
Christina Morelli	Jonathan & Clara Cohen	Roseline Michael & Dennis Neveling
Chrysti & David Eigenberg	Josie Merck	Ruth Nelson
Cynthia Kaplan & David Froelich	Judy & Sam Berger	Sarah Horowitz & David Venarde
Cynthia Vance-Abrams & Robert Abrams	Judy Taub Gold	Seth Marx
Danielle Mindess & Robert Cohen	Karen & Paul Freitas	Shari Goodstein
David Williams	Karin & Tom Schall	Sherry Cohen
Deborah Kim	Katie & Kelly Clark	Shirley Rumierk & Armando Riesco
Denise Burse & Peter Jay Fernandez	Katrina vanden Heuvel	Stephen Bernstein
Don Nickel	Kevin Ryder	Stephen Graham
Douglas Kabel	Kim & Jordan Dickstein	Stephen Sadove
Edith Thurber & Kevin O'Rourke	Kimberly Grigsby	Steven & Lenora Satin
Ellen Chopay	Laura & David Ross	Susannah Keagle
Ellen Kroll	Laura Jones	Sylvia Shepard & Willy Holtzman
Ellen Oshinsky	Laura Valeroso & David Seidman	Tracy Wan & Carl Creager
Emily Grishman & Susan Sampliner	Laurel Durst	Valerie Kay & Bruce Graham
Eric Brooks	Lewis Black	Vicki & Craig Holleman
Eric Jungwirth	Lisa Benavides & Tim Blake Nelson	Vicki & Mark Whatley
F. Richard Pappas	Lori O'Connor	Wendy vanden Heuvel & Brad Coley
Frances McDormand & Joel Coen	Lynne Rosenberg	Yared Yawand Wossen
	Margaret & Peter O'Brien	

List current as of Aug. 13, 2021

THE 52ND STREET PROJECT PRESENTS

# PIECE OF CAKE

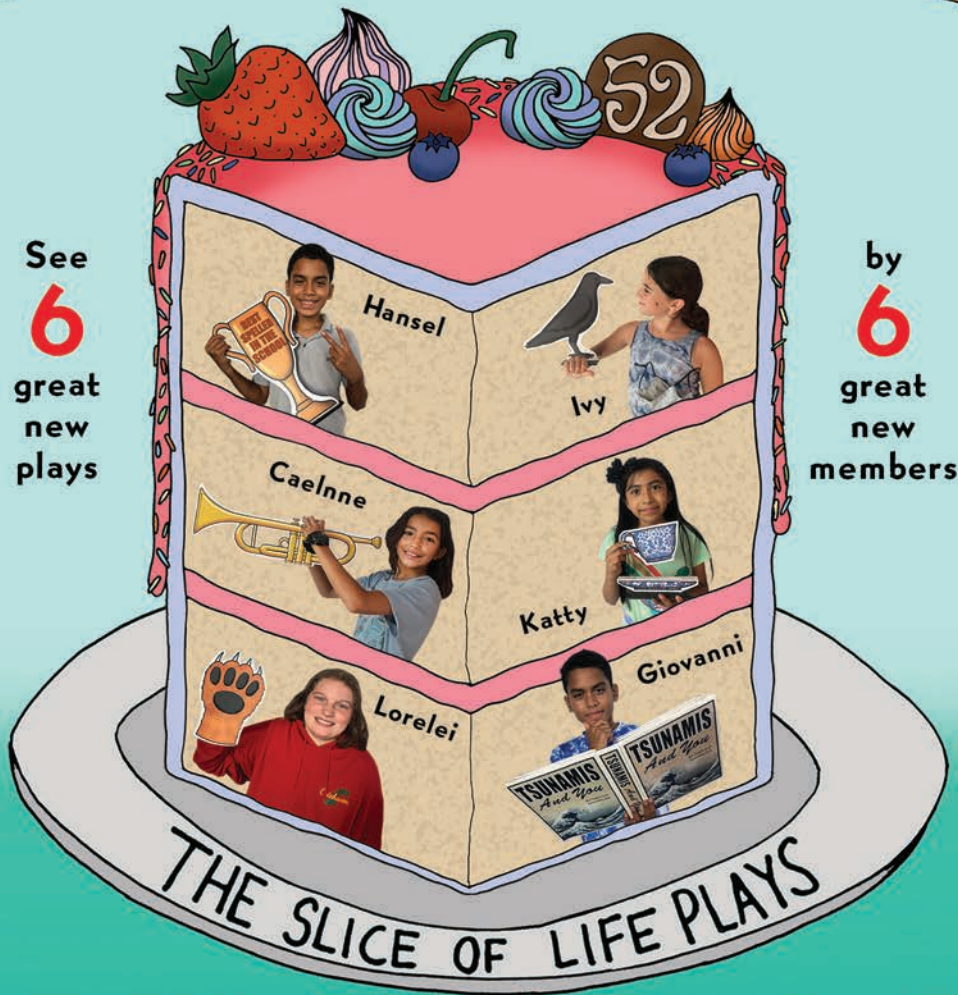

ARTWORK BY CAYLYN WAN-CREAGER, LAYOUT BY GEORGE BABIAK

See  
**6**  
great  
new  
plays

by  
**6**  
great  
new  
members

THE SLICE OF LIFE PLAYS

THE FALL 2021 PLAYMAKING SHOWS

Friday, Dec. 10th at 7:30 p.m.

Saturday, Dec. 11th at 4:00 p.m. and 7:30 p.m.

LIVE AND ONLINE



# PIECE OF CAKE: THE SLICE OF LIFE PLAYS

Fall 2021 Playmaking - December 10 & 11, Five Angels Theater

## The 52nd Street Project Staff

Kat Almirañez, Associate Artistic Director  
Avi A. Amon, Musical Director  
Ahmed Attia, Development Manager\*  
George Babiak, Director of Design and Production  
Liz Bell, Clinical Consultant  
Ana Gonzalez-Soto, Receptionist  
Natalie Hirsch, Artistic Director  
Garrett Kim, Program Director  
Kristina Nungaray, Marketing and Events Manager  
Carol Ochs, Executive Director  
John Sheehy, Director of Institutional Advancement  
Johanna Vidal, Director of Education\*  
Caylyn Wan-Creager, Education Associate  
Bri Weintraub, Production Manager  
Iris A. Brown, Graphic Design Consultant

*\*Project Alumni*

## “PIECE OF CAKE” Production Staff

### Composer/Music Director

Avi A. Amon

### Set Designer

Burke Brown

### Lighting Designer

Greg MacPherson

### Costume Designer

Lara De Bruijn

### Sound Designer

Evan Schultz

### Stage Manager

Jenny Peek

### Projection Designs

George Babiak and  
The Project Projection Archive

### Prop Design and Construction

George Babiak

### Backstage Crew

Xavier Espinal, Emma Giordano,  
Ana Gonzalez-Soto, Tina Hughes

### House Management

Carol Ochs, John Sheehy,  
Kristina Nungaray

### Flyer/Program Art & Photography

Caylyn Wan-Creager  
George Babiak

### Livestream Team

Director: Katie Bartz  
Camera Ops: Enrique Caballero,  
Emmanuel Goicuria

### Intern

Emma Giordano



The Playmaking Program is made possible with public funds from The New York State Council on the Arts, a state agency, and the New York City Department of Cultural Affairs. The 52nd Street Project is a member of Art/NY and Theatre Communications Group (TCG), the national organization for the American theatre.

# PIECE OF CAKE: THE SLICE OF LIFE PLAYS

All original music composed by Avi A. Amon

## FURNITURE AND TREES

Written by Katty Lopez, age 9

Dramaturge/Director: Lisa Benavides-Nelson

Lindy, an office chair ..... Krystel Lucas  
Adam, a tree ..... Christian DeMarais  
The Boss, a lamp ..... John Sheehy

*There For Me* lyrics by Katty Lopez

## SUN AND MOON

Written by Hansel Benedicto, age 10

Dramaturge/Director: Nolan Doran

Sunset, daughter of the Sun and the Moon ..... Ashley Marie Ortiz  
Blok O. Cheese, a block of cheese ..... Sullivan Jones  
The Sun ..... Xavier Espinal  
Cloud Princess ..... Ana Gonzalez-Soto

*What I Do* lyrics by Hansel Benedicto

## UNTITLED

Written by Caelnne Arango-Ramirez, age 10

Dramaturge/Director: Therese Barbato

Oliver ..... Nick Mills  
Carol ..... Annie Henk  
Oliver's Mom ..... Tina Hughes  
Brandy, a bully ..... Emma Giordano  
Kim, another bully ..... Ana Gonzalez-Soto  
Teacher ..... Tina Hughes

*No One To Someone* and *Beautiful* lyrics by Caelnne Arango-Ramirez

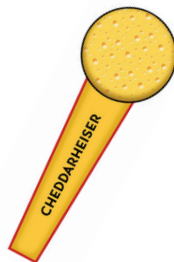

# OF FLIGHTS AND FIGHTS

Written by Lorelei de Campi, age 10

Dramaturge/Director: Marielle Young

Fenyx, an owl barista.....Betsy Hogg  
 Zephyr, a fisherman..... Keshav Moodliar  
 Squirrel ..... George Babiak  
 Evil Monsters ..... Emma Giordano, Tina Hughes  
 Nice Monsters..... Ana Gonzalez-Soto, Xavier Espinal  
 Skullmancer..... John Sheehy  
 Skullton..... Emma Giordano

*A Recollection* lyrics by Lorelei de Campi

# RANDOM FRIENDS

Written by Giovanni Benedicto, age 10

Dramaturge/Director: Sean Kenealy

Blum, a ten-year old girl..... Stephanie Jean Lane  
 Televor, an old-fashioned TV set ..... Mitchell Winter

*Forgive* lyrics by Giovanni Benedicto

# WE MAKE A GOOD TEAM

Written by Ivy Moayed, age 10

Dramaturge/Director: Lynne Rosenberg

Stella Shorehouse, a dolphin..... Daiva Deupree  
 Leo Pesto ..... Neil D’Astolfo  
 Taxi Driver.....Xavier Espinal  
 Stella’s Mom, also a dolphin.....Tina Hughes

*But Then I Met You* lyrics by Ivy Moayed

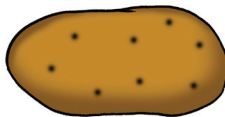

## The 52nd Street Project Board of Directors

Lisa Benavides-Nelson  
Rachel Chanoff  
Cathy Dantchik, co-chair  
Carolyn DeSena  
Louis P. Friedman, co-chair  
Robert Goldberg  
Stephen Graham, chair emeritus  
Annie Hausmann  
Natalie Hirsch  
Korey Jackson  
Valerie Kay

Noël Mihalow  
Roseline Michael Neveling  
Carol Ochs  
Margaret Odette  
Willie Reale, founder  
Shirley Rumierk, alumni member  
José Soto, Jr., alumni member  
Merritt Tilney  
Wendy vanden Heuvel  
Alexandra Vassilaros  
Mark Whatley

---

### What's Going On Here?

The 52nd Street Project is a non-profit organization that brings children from the Hell's Kitchen neighborhood together with professional theater artists to create original theater. **PIECE OF CAKE** is a production of our Playmaking program. Young people participated in a playwriting course taught by Kat Almirañez and adapted for the Project by Daniel Judah Sklar from his book *Playmaking: Children Writing and Performing Their Own Plays*. At the end of the course, each child was matched with two actors and a dramaturg/director who guided him or her through the writing of a play. This performance is the end result.

This edition continues our in-person return of children to The 52nd Street Project Clubhouse and The Five Angels Theater. We normally would have taken the students to the country, but this is not possible yet. However, we are delighted and grateful to be working with them in a live, present way.

---

### In-Kind Contributions

Abbeville Press; Ambassador Theatre Group; Avi & Richard Anthony; Ardesia; Kate & Andy Bellin; Lewis Black; Iris A. Brown Design; Cellar 53; William Curran, A Curran Affair; The Daily Show's Trevor Noah; Michael Dorf & City Winery; Dormify.com; Sean Feeney, MISI; Haru Restaurant of Hell's Kitchen; Celia Keenan-Bolger; Karen Kowgios of Withum, Smith, & Brown; Pamela Liebman, The Corcoran Group; Charlie Marshall; Stella McCartney; Michter's Distillery, LLC Noël Mihalow & Prime Films; The Neveling Family; Lauren Friedman, Pharma/Omni Printing; Winston Rodney Photography; Signature Bank; SHOWTIME; The Surrey; Merritt Tilney & Doug Kaden; Vassilaros & Sons Coffee Company; Alex Vassilaros & The Vassilaros Family; The Watkins Company; Vicki & Mark Whatley and Paul, Rifkind, Wharton, & Garrison LLP.

---

### Special Thanks

Gratitude must be paid in full to Tina Hughes for assisting with the Playmaking Class.

The 52nd Street Project gratefully acknowledges the support of the following foundations & corporations: Carol M. & Stephen E. Canter Family Foundation; Cantor Fitzgerald Relief Fund; Carnegie Corporation of New York; The CLAWS Foundation; Consolidated Edison; Dawkins Family Foundation; Dramatists Play Service, Inc.; The Jean & Louis Dreyfus Foundation; The Education Foundation of America; Flexis Capital, LLC; Goldman Sachs; The Horace W. Goldsmith Foundation; The Stephen P. Hanson Foundation; Heisman Trophy Trust; The William and Flora Hewlett Foundation; Howard Ashman Trust for Theater Arts Lemle Pictures, Inc.; The Lotos Foundation; Frederick Loewe Foundation; The Rona & Randolph M. Nelson Foundation; Seller-Lehrer Family Foundation; The Stavros Niarchos Foundation; Par Plumbing Co., Inc.; The Pinkerton Foundation; Sawyer | Berson Architecture & Landscape Architecture; The Morris and Alma Schapiro Fund; Showtime Networks; The Shubert Foundation; The Harold & Mimi Steinberg Charitable Trust; Susquehanna Foundation; Tiger Baron Foundation; John A. Vassilaros & Sons, Inc.; Yorke Construction Corp.; Zubatkin Owner Representation, LLC. We also acknowledge the following individual donors (over \$250) to The 52nd Street Project:

Alexandra Vassilaros	Francine Borgenicht	Mary Kong & Sol Reischer
Alphonsa Vadakethalake	Frank Wood & Kay Gayner	Mary Pat Walsh
Amy Herzig	Gavin Berger & Craig Berggren	Megan Cramer
Andrea Johnson	Glen Gillen	Melissa Lowry
Annie & David Hausmann	Helen & Peter Randolph	Merritt Tilney & Douglas M. Kaden
Becky & Dylan Baker	Henry Krieger & Robert Joy	Michael & Megan Crane
Beth & Bob Ollwerther	Jacki Ochs & Jan Kroeze	Patrice & Louis Friedman
Beth Barry and Daniel Sussman	Jane & Greg MacPherson	Peter Ackerman
Billy Crudup	Jeannie & Jim Gaffigan	Peter Francis James
Bob Stockel	Jeff Arnold	Randy Weisenberger
Carl Capotorto	Jené LeBlanc & Willie Reale	Richard Sweren
Carol Ochs & Bruce MacVittie	Jeremy Smith	Rita Silver
Carole and Alan Howard	Jerry McGill	Ron & Judy Tierney
Carole Yass	Jessica Hecht & Adam Bernstein	Rona & Randy Nelson
Carolyn DeSena	John Rossi	Rose Gasner & Larry Chertoff
Christina Morelli	Jonathan & Clara Cohen	Roseline Michael & Dennis Neveling
Chrysti & David Eigenberg	Josie Merck	Ruth Nelson
Cynthia Kaplan & David Froelich	Judy & Sam Berger	Sarah Horowitz & David Venarde
Cynthia Vance-Abrams & Robert Abrams	Judy Taub Gold	Seth Marx
Danielle Mindess & Robert Cohen	Karen & Paul Freitas	Shari Goodstein
David Williams	Karin & Tom Schall	Sherry Cohen
Deborah Kim	Katie & Kelly Clark	Shirley Rumierk & Armando Riesco
Denise Burse & Peter Jay Fernandez	Katrina vanden Heuvel	Stephen Bernstein
Don Nickel	Kevin Ryder	Stephen Graham
Douglas Kabel	Kim & Jordan Dickstein	Stephen Sadove
Edith Thurber & Kevin O'Rourke	Kimberly Grigsby	Steven & Lenora Satin
Ellen Chopay	Laura & David Ross	Susannah Keagle
Ellen Kroll	Laura Jones	Sylvia Shepard & Willy Holtzman
Ellen Oshinsky	Laura Valeroso & David Seidman	Tracy Wan & Carl Creager
Emily Grishman & Susan Sampliner	Laurel Durst	Valerie Kay & Bruce Graham
Eric Brooks	Lewis Black	Vicki & Craig Holleman
Eric Jungwirth	Lisa Benavides & Tim Blake Nelson	Vicki & Mark Whatley
F. Richard Pappas	Lori O'Connor	Wendy vanden Heuvel & Brad Coley
Frances McDormand & Joel Coen	Lynne Rosenberg	Yared Yawand Wossen
	Margaret & Peter O'Brien	

List current as of Aug. 13, 2021



# SHOW PROGRAMS 2022 (Pandemic Year 3)

**THE 52ND STREET PROJECT PRESENTS**

# **FLYING**

**Original Spoken  
Word Pieces**

**Written and Performed  
by Project Members**

# **SOLO**



**Friday, February 11, 2022 - 7:30 p.m.**

**Live at the Five Angels Theater and on  
The 52nd Street Project's YouTube Channel**

## **The 52nd Street Project Staff**

Kat Almirañez, Associate Artistic Director  
Avi A. Amon, Musical Director  
Ahmed Attia, Development Manager\*  
George Babiak, Director of Design and Production  
Liz Bell, Clinical Consultant  
Natalie Hirsch, Artistic Director  
Garrett Kim, Program Director  
Kristina Nungaray, Marketing and Events Manager  
Carol Ochs, Executive Director  
John Sheehy, Director of Institutional Advancement  
Johanna Vidal, Director of Education\*  
Caylyn Wan-Creager, Education Associate  
Bri Weintraub, Production Manager  
Iris A. Brown, Graphic Design Consultant  
Christian Corpening, Intern  
Layla Diaz, Intern  
*\*Project Alumni*

## **“FLYING SOLO” Production Staff**

### **Lighting and Sound Designer**

Bri Weintraub

### **Backstage Crew**

Christian Corpening, Layla Diaz

### **House Management**

Carol Ochs, John Sheehy,  
Kristina Nungaray

### **Flyer/Program Art**

Wilhelmina Ohene Kari-kari

### **Livestream Team**

Director: George Babiak  
Camera Operator: Christian Corpening



FLYING SOLO is made possible with public funds from the National Endowment for the Arts, The New York State Council on the Arts, a state agency, and the New York City Department of Cultural Affairs. The 52nd Street Project is a member of Art/NY and Theatre Communications Group (TCG), the national organization for the American theatre.



# **KIARA'S POTENTIAL**

Written and Performed by Melanie Correa  
Directed by Michael Propster



# **WHY ARE WE FRIENDS?**

Written and Performed by Kailey Caton  
Directed by Kendall Cafaro



# **AL AND THE LIBRARY**

Written and Performed by Amari DuBose  
Directed by José Gamo



# **CHARLIE'S NEW WORLD**

Written and Performed by Hannah Leon  
Directed by Adaire Kamen



# **I AM...**

Written and Performed by Xavier Espinal  
Directed by Ronald Peet

## The 52nd Street Project Board of Directors

Lisa Benavides	Noël Mihalow
Rachel Chanoff	Roseline Michael Neveling
Cathy Dantchik, co-chair	Carol Ochs
Carolyn DeSena	Margaret Odette
Louis P. Friedman, co-chair	Willie Reale, founder
Robert Goldberg	Shirley Rumierk, alumni member
Stephen Graham, chair emeritus	José Soto, Jr., alumni member
Annie Hausmann	Merritt Tilney
Natalie Hirsch	Wendy vanden Heuvel
Korey Jackson	Alexandra Vassilaros
Valerie Kay	Mark Whatley

---

### What's Going On Here?

The 52nd Street Project is a non-profit organization that brings children from the Hell's Kitchen neighborhood together with professional theater artists to create original theater. **FLYING SOLO** is part of our New Platforms series of programs that add additional creative outlets to our members.

---

### In-Kind Contributions

Abbeville Press; Ambassador Theatre Group; Avi & Richard Anthony; Ardesia; Kate & Andy Bellin; Lewis Black; Iris A. Brown Design; Cellar 53; William Curran, A Curran Affair; The Daily Show's Trevor Noah; Michael Dorf & City Winery; Dormify.com; Sean Feeney, MISI; Haru Restaurant of Hell's Kitchen; Celia Keenan-Bolger; Karen Kowgios of Withum, Smith, & Brown; Pamela Liebman, The Corcoran Group; Charlie Marshall; Stella McCartney; Michter's Distillery, LLC Noël Mihalow & Prime Films; The Neveling Family; Lauren Friedman, Pharma/Omni Printing; Winston Rodney Photography; Signature Bank; SHOWTIME; The Surrey; Merritt Tilney & Doug Kaden; Vassilaros & Sons Coffee Company; Alex Vassilaros & The Vassilaros Family; The Watkins Company; Vicki & Mark Whatley and Paul, Rifkind, Wharton, & Garrison LLP.

The 52nd Street Project gratefully acknowledges the support of the following foundations & corporations: Carol M. & Stephen E. Canter Family Foundation; Cantor Fitzgerald Relief Fund; Carnegie Corporation of New York; The CLAWS Foundation; Consolidated Edison; Dawkins Family Foundation; Dramatists Play Service, Inc.; The Jean & Louis Dreyfus Foundation; The Education Foundation of America; Flexis Capital, LLC; Goldman Sachs; The Horace W. Goldsmith Foundation; The Stephen P. Hanson Foundation; Heisman Trophy Trust; The William and Flora Hewlett Foundation; Howard Ashman Trust for Theater Arts Lemle Pictures, Inc.; The Lotos Foundation; Frederick Loewe Foundation; The Rona & Randolph M. Nelson Foundation; Seller-Lehrer Family Foundation; The Stavros Niarchos Foundation; Par Plumbing Co., Inc.; The Pinkerton Foundation; Sawyer | Berson Architecture & Landscape Architecture; The Morris and Alma Schapiro Fund; Showtime Networks; The Shubert Foundation; The Harold & Mimi Steinberg Charitable Trust; Susquehanna Foundation; Tiger Baron Foundation; John A. Vassilaros & Sons, Inc.; Yorke Construction Corp.; Zubatkin Owner Representation, LLC. We also acknowledge the following individual donors (over \$250) to The 52nd Street Project:

Alexandra Vassilaros	Francine Borgenicht	Mary Kong & Sol Reischer
Alphonsa Vadakethalake	Frank Wood & Kay Gayner	Mary Pat Walsh
Amy Herzig	Gavin Berger & Craig Berggren	Megan Cramer
Andrea Johnson	Glen Gillen	Melissa Lowry
Annie & David Hausmann	Helen & Peter Randolph	Merritt Tilney & Douglas M. Kaden
Becky & Dylan Baker	Henry Krieger & Robert Joy	Michael & Megan Crane
Beth & Bob Ollwerther	Jacki Ochs & Jan Kroeze	Patrice & Louis Friedman
Beth Barry and Daniel Sussman	Jane & Greg MacPherson	Peter Ackerman
Billy Crudup	Jeannie & Jim Gaffigan	Peter Francis James
Bob Stockel	Jeff Arnold	Randy Weisenberger
Carl Capotorto	Jené LeBlanc & Willie Reale	Richard Sweren
Carol Ochs & Bruce MacVittie	Jeremy Smith	Rita Silver
Carole and Alan Howard	Jerry McGill	Ron & Judy Tierney
Carole Yass	Jessica Hecht & Adam Bernstein	Rona & Randy Nelson
Carolyn DeSena	John Rossi	Rose Gasner & Larry Chertoff
Christina Morelli	Jonathan & Clara Cohen	Roseline Michael & Dennis Neveling
Chrysti & David Eigenberg	Josie Merck	Ruth Nelson
Cynthia Kaplan & David Froelich	Judy & Sam Berger	Sarah Horowitz & David Venarde
Cynthia Vance-Abrams & Robert Abrams	Judy Taub Gold	Seth Marx
Danielle Mindess & Robert Cohen	Karen & Paul Freitas	Shari Goodstein
David Williams	Karin & Tom Schall	Sherry Cohen
Deborah Kim	Katie & Kelly Clark	Shirley Rumierk & Armando Riesco
Denise Burse & Peter Jay Fernandez	Katrina vanden Heuvel	Stephen Bernstein
Don Nickel	Kevin Ryder	Stephen Graham
Douglas Kabel	Kim & Jordan Dickstein	Stephen Sadove
Edith Thurber & Kevin O'Rourke	Kimberly Grigsby	Steven & Lenora Satin
Ellen Chopay	Laura & David Ross	Susannah Keagle
Ellen Kroll	Laura Jones	Sylvia Shepard & Willy Holtzman
Ellen Oshinsky	Laura Valeroso & David Seidman	Tracy Wan & Carl Creager
Emily Grishman & Susan Sampliner	Laurel Durst	Valerie Kay & Bruce Graham
Eric Brooks	Lewis Black	Vicki & Craig Holleman
Eric Jungwirth	Lisa Benavides & Tim Blake Nelson	Vicki & Mark Whatley
F. Richard Pappas	Lori O'Connor	Wendy vanden Heuvel & Brad Coley
Frances McDormand & Joel Coen	Lynne Rosenberg	Yared Yawand Wossen
	Margaret & Peter O'Brien	

List current as of Aug. 13, 2021

The 52nd Street Project Presents

The 2022  
2-on-2  
Remix Plays

# In The Same Boat!

The Buoyant Plays

Adults and  
young people  
performing  
together!



One Night Only!  
Friday, Feb. 25  
7:30 p.m.

Live on our stage  
and on YouTube!

ARTWORK BY PATRICK JONES

# IN THE SAME BOAT: THE BUOYANT PLAYS

The Two-on-Two Remix Plays - February 25, 2022, Five Angels Theater

## **The 52nd Street Project Staff**

Kat Almirañez, Associate Artistic Director  
Avi A. Amon, Musical Director  
Ahmed Attia, Development Manager\*  
George Babiak, Director of Design and Production  
Liz Bell, Clinical Consultant  
Ana Gonzalez-Soto, Receptionist  
Natalie Hirsch, Artistic Director  
Garrett Kim, Program Director  
Kristina Nungaray, Marketing and Events Manager  
Carol Ochs, Executive Director  
John Sheehy, Director of Institutional Advancement  
Johanna Vidal, Director of Education\*  
Caylyn Wan-Creager, Education Associate  
Bri Weintraub, Production Manager  
Iris A. Brown, Graphic Design Consultant  
Christian Corpening and Layla Diaz, Interns

*\*Project Alumni*

## **“IN THE SAME BOAT” Production Staff**

### **Stage Manager**

Kate Gulden

### **Lighting and Sound Designer**

Bri Weintraub and the Project Sound Archive

### **Projection Designs**

George Babiak and The Project Projection Archive

### **Prop Design and Construction**

George Babiak

### **House Management**

Carol Ochs, John Sheehy, Kristina Nungaray

### **Flyer/Program Art**

Patrick Jones

### **Livestream Team**

Director: George Babiak

Camera Ops: Christian Corpening, George Kiely



The Project's programs are made possible with public funds from The New York State Council on the Arts, a state agency, and the New York City Department of Cultural Affairs. The 52nd Street Project is a member of Art/NY and Theatre Communications Group (TCG), the national organization for the American theatre.

# IN THE SAME BOAT Theme Song

Lyrics by John Sheehy, Music by Avi A. Amon

## THE SHOWDOWN

Written by Sung Rno

Directed by Kyle Cameron

The Kalifornia Kid ..... Aiden Vasquez

Lucky Seven ..... Kyle Cameron

First produced 2014 in *By Degrees: 6 Plays of Separation*

## FORMER WIVES OF REGGIE

Written by Max Posner

Directed by Alex J. Gould

Holley ..... Hannah Santos

Debbie ..... Alex J. Gould

First produced 2014 in *By Degrees: 6 Plays of Separation*

## BUNKER BROTHERS

Written by Jesse Liebman

Directed by Tina Hughes

Simon ..... Logan Goicuria

Tomas ..... Tina Hughes

First produced 2017 in *Shine a Light: The Hopeful Plays*

## FROZEN FISH

Written by Sarah Hammond

Directed by Carina Goebelbecker

Jessie ..... Hanna Brea

Marella ..... Carina Goebelbecker

First produced 2016 in *The Nick of Time: The Punctual Plays*

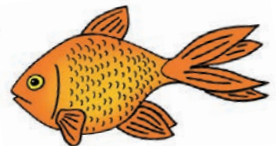
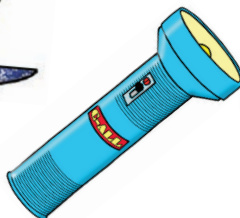

# PET PEEVE

Written by Sean Kenealy  
Directed by Jon-Michael Reese

Jess ..... John Muca  
Doctor ..... Jon-Michael Reese  
First produced 2013 in *Nobody's Perfect: Plays with Tragic Flaws*

# WHAT WE DO, WE DO FOR TRUE

Written by Beto O'Byrne  
Directed by Korey Jackson

Wade ..... Naseem Abdul-Majeed  
James ..... Korey Jackson  
First produced 2016 in *The Nick of Time: The Punctual Plays*

# FLOWER CHILDREN

Written by Melisa Tien  
Directed by Emily Gardner Xu Hall

Rlna ..... Kylie Rose Rivera-Beato  
Lamb ..... Emily Gardner Xu Hall  
Original music by Emily Gardner Xu Hall  
First produced 2016 in *The Nick of Time: The Punctual Plays*



## The 52nd Street Project Board of Directors

Lisa Benavides-Nelson	Noël Mihalow
Rachel Chanoff	Roseline Michael Neveling
Cathy Dantchik, co-chair	Carol Ochs
Carolyn DeSena	Margaret Odette
Louis P. Friedman, co-chair	Willie Reale, founder
Robert Goldberg	Shirley Rumierk, alumni member
Stephen Graham, chair emeritus	José Soto, Jr., alumni member
Annie Hausmann	Merritt Tilney
Natalie Hirsch	Wendy vanden Heuvel
Korey Jackson	Alexandra Vassilaros
Valerie Kay	Mark Whatley

---

### What's Going On Here?

The 52nd Street Project is a non-profit organization that brings children from the Hell's Kitchen neighborhood together with professional theater artists to create original theater. **IN THE SAME BOAT** employs a new format for our members tailored to their week off from school this month. We took past scripts from our Two-on-Two program, condensed them, and matched our young people up with adult volunteers. The teams began rehearsing these shows on Monday and are presenting them to you today (Friday).

This program continues the in-person return of children to **The 52nd Street Project Clubhouse** and **The Five Angels Theater**. We normally would have taken the students to the country to rehearse these shows, but this is not possible yet. However, we are delighted and grateful to be working with them in a live, present way.

---

### In-Kind Contributions

Abbeville Press; Ambassador Theatre Group; Avi & Richard Anthony; Ardesia; Kate & Andy Bellin; Lewis Black; Iris A. Brown Design; Cellar 53; William Curran, A Curran Affair; The Daily Show's Trevor Noah; Michael Dorf & City Winery; Dormify.com; Sean Feeney, MISI; Haru Restaurant of Hell's Kitchen; Celia Keenan-Bolger; Karen Kowgios of Withum, Smith, & Brown; Pamela Liebman, The Corcoran Group; Charlie Marshall; Stella McCartney; Michter's Distillery, LLC Noël Mihalow & Prime Films; The Neveling Family; Lauren Friedman, Pharma/Omni Printing; Winston Rodney Photography; Signature Bank; SHOWTIME; The Surrey; Merritt Tilney & Doug Kaden; Vassilaros & Sons Coffee Company; Alex Vassilaros & The Vassilaros Family; The Watkins Company; Vicki & Mark Whatley and Paul, Rifkind, Wharton, & Garrison LLP.



The 52nd Street Project gratefully acknowledges the support of the following foundations & corporations: Carol M. & Stephen E. Canter Family Foundation; Cantor Fitzgerald Relief Fund; Carnegie Corporation of New York; The CLAWS Foundation; Consolidated Edison; Dawkins Family Foundation; Dramatists Play Service, Inc.; The Jean & Louis Dreyfus Foundation; The Education Foundation of America; Flexis Capital, LLC; Goldman Sachs; The Horace W. Goldsmith Foundation; The Stephen P. Hanson Foundation; Heisman Trophy Trust; The William and Flora Hewlett Foundation; Howard Ashman Trust for Theater Arts Lemle Pictures, Inc.; The Lotos Foundation; Frederick Loewe Foundation; The Rona & Randolph M. Nelson Foundation; Seller-Lehrer Family Foundation; The Stavros Niarchos Foundation; Par Plumbing Co., Inc.; The Pinkerton Foundation; Sawyer | Berson Architecture & Landscape Architecture; The Morris and Alma Schapiro Fund; Showtime Networks; The Shubert Foundation; The Harold & Mimi Steinberg Charitable Trust; Susquehanna Foundation; Tiger Baron Foundation; John A. Vassilaros & Sons, Inc.; Yorke Construction Corp.; Zubatkin Owner Representation, LLC. We also acknowledge the following individual donors (over \$250) to The 52nd Street Project:

Alexandra Vassilaros	Francine Borgenicht	Mary Kong & Sol Reischer
Alphonsa Vadakethalake	Frank Wood & Kay Gayner	Mary Pat Walsh
Amy Herzig	Gavin Berger & Craig Berggren	Megan Cramer
Andrea Johnson	Glen Gillen	Melissa Lowry
Annie & David Hausmann	Helen & Peter Randolph	Merritt Tilney & Douglas M. Kaden
Becky & Dylan Baker	Henry Krieger & Robert Joy	Michael & Megan Crane
Beth & Bob Ollwerther	Jacki Ochs & Jan Kroeze	Patrice & Louis Friedman
Beth Barry and Daniel Sussman	Jane & Greg MacPherson	Peter Ackerman
Billy Crudup	Jeannie & Jim Gaffigan	Peter Francis James
Bob Stockel	Jeff Arnold	Randy Weisenberger
Carl Capotorto	Jené LeBlanc & Willie Reale	Richard Sweren
Carol Ochs & Bruce MacVittie	Jeremy Smith	Rita Silver
Carole and Alan Howard	Jerry McGill	Ron & Judy Tierney
Carole Yass	Jessica Hecht & Adam Bernstein	Rona & Randy Nelson
Carolyn DeSena	John Rossi	Rose Gasner & Larry Chertoff
Christina Morelli	Jonathan & Clara Cohen	Roseline Michael & Dennis Neveling
Chrysti & David Eigenberg	Josie Merck	Ruth Nelson
Cynthia Kaplan & David Froelich	Judy & Sam Berger	Sarah Horowitz & David Venarde
Cynthia Vance-Abrams & Robert Abrams	Judy Taub Gold	Seth Marx
Danielle Mindess & Robert Cohen	Karen & Paul Freitas	Shari Goodstein
David Williams	Karin & Tom Schall	Sherry Cohen
Deborah Kim	Katie & Kelly Clark	Shirley Rumierk & Armando Riesco
Denise Burse & Peter Jay Fernandez	Katrina vanden Heuvel	Stephen Bernstein
Don Nickel	Kevin Ryder	Stephen Graham
Douglas Kabel	Kim & Jordan Dickstein	Stephen Sadove
Edith Thurber & Kevin O'Rourke	Kimberly Grigsby	Steven & Lenora Satin
Ellen Chopay	Laura & David Ross	Susannah Keagle
Ellen Kroll	Laura Jones	Sylvia Shepard & Willy Holtzman
Ellen Oshinsky	Laura Valeroso & David Seidman	Tracy Wan & Carl Creager
Emily Grishman & Susan Sampliner	Laurel Durst	Valerie Kay & Bruce Graham
Eric Brooks	Lewis Black	Vicki & Craig Holleman
Eric Jungwirth	Lisa Benavides & Tim Blake Nelson	Vicki & Mark Whatley
F. Richard Pappas	Lori O'Connor	Wendy vanden Heuvel & Brad Coley
Frances McDormand & Joel Coen	Lynne Rosenberg	Yared Yawand Wossen
	Margaret & Peter O'Brien	

List current as of Aug. 13, 2021

# THE 52ND STREET PROJECT PRESENTS

NATALIE MARSHALL HIRSCH,  
ARTISTIC DIRECTOR

CAROL OCHS,  
EXECUTIVE DIRECTOR

KAT ALMIRAÑEZ,  
ASSOCIATE ARTISTIC DIRECTOR

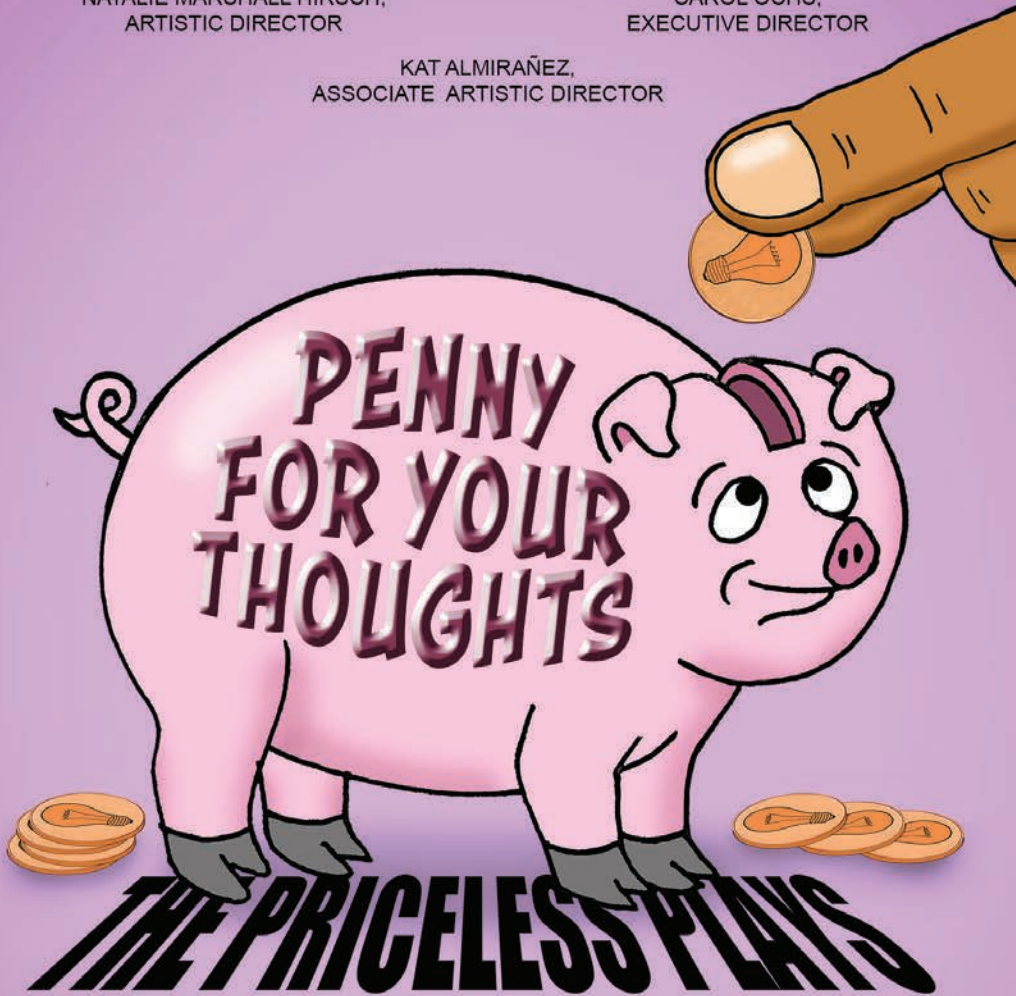

**THE PRICELESS PLAYS**

**THE SPRING 2022 PLAYMAKING SHOW**

**LIVE AT THE FIVE ANGELS THEATER AT 789 10TH AVE  
AND LIVE ON OUR YOUTUBE CHANNEL  
FRIDAY, APRIL 1 - 7:30 P.M.  
SATURDAY, APRIL 2 - 3:00 & 7:30 P.M.**

# PENNY FOR YOUR THOUGHTS: THE PRICELESS PLAYS

Spring 2022 Playmaking - April 1 & 2, Five Angels Theater

## The 52nd Street Project Staff

Kat Almirañez, Associate Artistic Director  
Avi A. Amon, Musical Director  
Ahmed Attia, Development Manager\*  
George Babiak, Director of Design and Production  
Liz Bell, Clinical Consultant  
Ana Gonzalez-Soto, Receptionist  
Natalie Hirsch, Artistic Director  
Garrett Kim, Program Director  
Kristina Nungaray, Marketing and Events Manager  
Carol Ochs, Executive Director  
John Sheehy, Director of Institutional Advancement  
Johanna Vidal, Director of Education\*  
Caylyn Wan-Creager, Education Associate  
Bri Weintraub, Production Manager  
Iris A. Brown, Graphic Design Consultant

*\*Project Alumni*

## “PENNY” Production Staff

### Composer/Music Director

Erica Ji

### Set Designer

Burke Brown

### Lighting Designers

Jade Barnett-Irons

Aaron Conover

### Costume Designer

Taylor Barnett

### Sound Designer

Evan Schultz

### Stage Manager

Jenni Swan

### Projection Designs

George Babiak and

The Project Projection Archive

### Prop Design and Construction

George Babiak

### Backstage Crew

Ana Gonzalez-Soto, Leo Layla Diaz,

Jayleen Velez, George Babiak

### House Management

Carol Ochs, John Sheehy

### Flyer/Program Art & Layout

George Babiak

### Livestream Team

Director: Katie Bartz

Camera Ops: Christian Corpening,

Tina Hughes

### Interns

Christian Corpening, Leo Layla Diaz



The Playmaking Program is made possible with public funds from the National Endowment for the Arts, The New York State Council on the Arts, a state agency, the New York City Department of Cultural Affairs, and funds from Con Edison. The 52nd Street Project is a member of Art/NY and Theatre Communications Group (TCG), the national organization for the American theatre.

# COOL STUFF ON SALE IN THE LOBBY!

Fabulous Flyer Bars ..... \$2.50

*and featuring Shel Silverstein's "Fivey and Twoey" logo:*

Two-tone Project Hoodie ..... \$40.00

Monotone Project Hoodie ..... \$30.00

Crew-neck sweatshirts ..... \$20.00

Project Caps ..... \$20.00

Project T-shirts ..... \$12.00/\$20.00

Project Mugs ..... \$5.00

Project Notebook ..... \$5.00

Project Pencil 3-pack ..... \$1.00

Thank you for coming to **PENNY FOR YOUR THOUGHTS!** If you are not on our mailing list, join on-line at [www.52project.org](http://www.52project.org). If you're interested in being a volunteer, fill out the form below and hand it to one of our staffers in the lobby.

## PLEASE PUT ME ON YOUR LIST:

12/19

NAME \_\_\_\_\_

ADDRESS \_\_\_\_\_

CITY \_\_\_\_\_

STATE \_\_\_\_\_

ZIP \_\_\_\_\_

HOME PHONE \_\_\_\_\_

DAYTIME OR MOBILE PHONE \_\_\_\_\_

E-MAIL ADDRESS \_\_\_\_\_

MY OCCUPATION \_\_\_\_\_

MY HOBBIES \_\_\_\_\_

WANT TO BE GREEN AND SAVE THE PROJECT MONEY ON POSTAGE?  
CHECK THIS BOX TO RECEIVE OUR NOTICES EXCLUSIVELY VIA E-MAIL.

## YES, I WOULD LIKE TO BE OF HELP. I CAN:

- |   |   |  |
|---|---|--|
| <input type="checkbox"/> Help load in and out for shows | <input type="checkbox"/> Draw and/or paint  | <input type="checkbox"/> Help kids with homework |
| <input type="checkbox"/> Hang lights                    | <input type="checkbox"/> Help with mailings | <input type="checkbox"/> Teach kids a skill      |
| <input type="checkbox"/> Work on a backstage crew       | <input type="checkbox"/> Do office work     | <input type="checkbox"/> Be a chef at an event   |
| <input type="checkbox"/> Do graphic design              | <input type="checkbox"/> Design sound       | <input type="checkbox"/> Design and sew costumes |
| <input type="checkbox"/> Other (please specify) _____   |   |  |

## MY SCHEDULE IS:

- Very flexible. I'm often available during weekdays.
- Somewhat flexible. I can help on the occasional morning or afternoon during the week.
- Not very flexible at all, but I've got some free time on evenings and weekends.

If you would like to mail this (and you're always welcome to enclose a tax-deductible contribution), you can send it to: The 52nd Street Project, 789 10th Avenue, New York, NY 10019. Or fax it to (212) 333-5598.

# WHAT'S COMING UP?

THE BOARD OF THE 52ND STREET PROJECT, ALONG WITH THE STERLING FOUNDATION AND EVENT HOSTS BILLY CRUDUP AND FRANCES McDORMAND, INVITE YOU TO MOISTURIZE, HYDRATE, AND **SAVE THE DATE** FOR:

# 52 IS THE NEW

THE 52ND STREET PROJECT'S 40TH ANNIVERSARY GALA  
MONDAY, MAY 9, 2022 - 7:00 P.M. AT  
**CAPITALE**  
BOWERY AND GRAND STREET

COCKTAILS, DINNER, AND AN ARRAY OF NEW SONGS WITH LYRICS BY YOUNG PEOPLE AND MUSIC AND PERFORMANCES BY ADULTS.

FOR INFORMATION CONTACT JOHN "FOUR-OH" SHEEHY AT [SHEEHY@52PROJECT.ORG](mailto:SHEEHY@52PROJECT.ORG)

## SUBSCRIBE TO OUR PODCAST!

A monthly online event created by Garrett Kim, John Sheehy, and your favorite kid/adult team-ups. Go to the podcast section of the iTunes Store and search for "The 52nd Street Project" or "PROJcast."



## BE ON THE LOOKOUT FOR INTERNS!



If you know of any college or graduate students who might enjoy working with us and playing with us with us for a semester, please have them contact Caylyn Creager ([creager@52project.org](mailto:creager@52project.org)). We are currently looking for interns for the Summer and Fall of 2022. Thanks!

## The 52nd Street Project Board of Directors

Lisa Benavides-Nelson  
Rachel Chanoff  
Cathy Dantchik, co-chair  
Carolyn DeSena  
Louis P. Friedman, co-chair  
Robert Goldberg  
Stephen Graham, chair emeritus  
Annie Hausmann  
Natalie Hirsch  
Korey Jackson  
Valerie Kay

Noël Mihalow  
Roseline Michael Neveling  
Carol Ochs  
Margaret Odette  
Willie Reale, founder  
Shirley Rumierk, alumni member  
José Soto, Jr., alumni member  
Merritt Tilney  
Wendy vanden Heuvel  
Alexandra Vassilaros  
Mark Whatley

---

### What's Going On Here?

The 52nd Street Project is a non-profit organization that brings children from the Hell's Kitchen neighborhood together with professional theater artists to create original theater. **PENNY FOR YOUR THOUGHTS** is a production of our Playmaking program. Young people participated in a playwriting course taught by Kat Almirañez and adapted for the Project by Daniel Judah Sklar from his book *Playmaking: Children Writing and Performing Their Own Plays*. At the end of the course, each child was matched with two actors and a dramaturg/director who guided him or her through the writing of a play. This performance is the end result.

This edition continues our in-person return of children to The 52nd Street Project Clubhouse and The Five Angels Theater. We normally would have taken the students to the country, but this is not possible yet. However, we are delighted and grateful to be working with them in a live, present way.

---

### In-Kind Contributions

Abbeville Press; Ambassador Theatre Group; Avi & Richard Anthony; Ardesia; Kate & Andy Bellin; Lewis Black; Iris A. Brown Design; Cellar 53; William Curran, A Curran Affair; The Daily Show's Trevor Noah; Michael Dorf & City Winery; Dormify.com; Sean Feeney, MISI; Haru Restaurant of Hell's Kitchen; Celia Keenan-Bolger; Karen Kowgios of Withum, Smith, & Brown; Pamela Liebman, The Corcoran Group; Charlie Marshall; Stella McCartney; Michter's Distillery, LLC Noël Mihalow & Prime Films; The Neveling Family; Lauren Friedman, Pharma/Omni Printing; Winston Rodney Photography; Signature Bank; SHOWTIME; The Surrey; Merritt Tilney & Doug Kaden; Vassilaros & Sons Coffee Company; Alex Vassilaros & The Vassilaros Family; The Watkins Company; Vicki & Mark Whatley and Paul, Rifkind, Wharton, & Garrison LLP.

# PENNY FOR YOUR THOUGHTS: ACT 1

All original music composed by Erica Ji

## MACK AND MACHINE

Written by Anthony Zappa, age 11  
Dramaturge/Director: Mat Hostetler

Mack, a Macbook laptop..... Shirley Rumierk  
B.O.B., an old arcade video game..... Carson Elrod  
Arcade operator..... Ana Gonzalez-Soto  
Customer..... Jayleen Velez

*Let's Be Friends Again* lyrics by Anthony Zappa

## LAMAR'S SHOCKING ADVENTURE

Written by Logan Centeno, age 9  
Dramaturge/Director: Sathya Sridharan

Lamar James..... Reggie White  
Jessie James..... Stephanie Linas  
Cloud Princess..... Ana Gonzalez-Soto

*Just Like Me and I'm Pretty Nervous* lyrics by Logan Centeno

## AN UNLIKELY PERFORMANCE

Written by Oliver Tanner, age 9  
Dramaturge/Director: Gaven Trinidad

Hairy Bobby, a mountain goat with a chameleon tail..... Jimmy Kenna  
Mozerella, an acrobatic monkey..... Helen Cespedes  
Terrible Ravenous Atrocious Beast (T.R.A.B.)..... Leo Layla Diaz  
Announcer..... Ana Gonzalez-Soto

*The T.R.A.B.* lyrics by Oliver Tanner

## DAISEY AND TONY

Written by Annabelle Yam, age 10  
Dramaturge/Director: Jen Anaya

Daisey, a girl snow leopard..... Arielle Goldman  
Tony, a boy seal..... Molly Carden

*Do You Want to Come With Me?* lyrics by Annabelle Yam

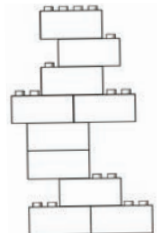
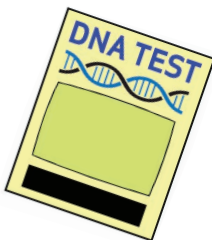

# PENNY FOR YOUR THOUGHTS: ACT 2

## HARD TO LIVE TO EASY TO LIVE

Written by Christiana Rose Keorajavongsay, age 10

Dramaturge/Director: Anne Troup

Jacob ..... Ali Sohaili  
Mark, Jacob's son ..... Mallory Portnoy  
Monkeys ..... The Crew  
Realtor ..... Ana Gonzalez-Soto

*Heartbroken* lyrics by Christiana Rose Keorajavongsay

## FRIENDSHIP STRUGGLE

Written by Ramsis Ramirez, age 10

Dramaturge/Director: Austin Regan

Thuraya ..... Grace Rex  
Dushaun ..... José Maria Aquila  
Customer ..... George Babiak  
Bullies ..... The Crew

*Friends For Ever* lyrics by Ramsis Ramirez

## THE HOLE

Written by Isabella Taveras, age 10

Dramaturge/Director: Annabelle Cousins

Learl, a shark ..... Ceci Fernandez  
LABS, Learl's Dad, a crab ..... Marchánt Davis  
Mermaids ..... The Crew

*Don't Give Up* lyrics by Isabella Taveras

## THE TURTLE AND THE TORTOISE

Written by Alyssa Garcia, age 11

Dramaturge/Director: Arielle Goldman

Lisa, a turtle, last of her kind ..... Sasha Diamond  
Leah, a tortoise, last of her kind ..... Ben Mehl  
Clownfish ..... Leo Layla Diaz  
Other fish ..... The crew

*Missing My Best Friend* lyrics by Alyssa Garcia





The 52nd Street Project gratefully acknowledges the support of the following foundations & corporations: Carol M. & Stephen E. Canter Family Foundation; Cantor Fitzgerald Relief Fund; Carnegie Corporation of New York; The CLAWS Foundation; Consolidated Edison; Dawkins Family Foundation; Dramatists Play Service, Inc.; The Jean & Louis Dreyfus Foundation; The Education Foundation of America; Flexis Capital, LLC; Goldman Sachs; The Horace W. Goldsmith Foundation; The Stephen P. Hanson Foundation; Heisman Trophy Trust; The William and Flora Hewlett Foundation; Howard Ashman Trust for Theater Arts Lemle Pictures, Inc.; The Lotos Foundation; Frederick Loewe Foundation; The Rona & Randolph M. Nelson Foundation; Seller-Lehrer Family Foundation; The Stavros Niarchos Foundation; Par Plumbing Co., Inc.; The Pinkerton Foundation; Sawyer | Berson Architecture & Landscape Architecture; The Morris and Alma Schapiro Fund; Showtime Networks; The Shubert Foundation; Susquehanna Foundation; Tiger Baron Foundation; John A. Vassilaros & Sons, Inc.; Yorke Construction Corp.; Zubatkin Owner Representation, LLC. We also acknowledge the following individual donors (over \$250) to The 52nd Street Project:

Alexandra Garrison	Gavin Berger & Craig Berggren	Mary Pat Walsh
Alexandra Vassilaros	Glen Gillen	Matthew Jones
Alphonsa Vadakethalake	Helen & Peter Randolph	Megan Cramer
Amy Herzig	Henry Krieger & Robert Joy	Melissa & Lee Briggs
Andrea Johnson	Jacki Ochs & Jan Kroeze	Melissa Lowry
Anna Li & Frank Sposato	Jane & Greg MacPherson	Merritt Tilney & Douglas M. Kaden
Anne M. Bacon	Jeannie & Jim Gaffigan	Michael & Megan Crane
Annie & David Hausmann	Jeff Arnold	Omar Metwally
Becky & Dylan Baker	Jené LeBlanc & Willie Reale	Patrice & Louis Friedman
Beth & Bob Ollwerther	Jeremy Smith	Peter Ackerman
Beth Barry and Daniel Sussman	Jerry McGill	Peter Francis James
Billy Crudup	Jessica Bauman & Ben Posel	Rachel & Larry Norton
Billy Dreskin	Jessica Hecht & Adam Bernstein	Randy Weisenberger
Bob Stockel	John Rossi	Richard Sweren
Buzz Bovshow	Jonathan & Clara Cohen	Rita Silver
Carl Capotorto	Josie Merck	Ron & Judy Tierney
Carol Ochs & Bruce MacVittie	Judy & Sam Berger	Rona & Randy Nelson
Carole and Alan Howard	Judy Kuhn & David Schwab	Rose Gasner & Larry Chertoff
Carole Yass	Judy Taub Gold	Roseline Michael
Carolyn DeSena	Karen & Paul Freitas	& Dennis Neveling
Cathy Dantchik	Karen Powell	Ruth Cohen & Bob Usdin
Cecilia Arana & Kevin Grant	Karin & Tom Schall	Ruth Nelson
Christina Morelli	Katie & Kelly Clark	Sarah & Paul Ardire
Chrysti & David Eigenberg	Katrina vanden Heuvel	Sarah Horowitz & David Venarde
Cynthia Kaplan & David Froelich	Katy Homans & Patterson Sims	Seth Marx
Cynthia Vance-Abrams & Robert Abrams	Kevin Ryder	Shari Goodstein
Danielle Mindess & Robert Cohen	Kim & Jordan Dickstein	Sherry Cohen
David Aldridge	Kimberly Grigsby	Shirley Rumierk
David Williams	Laura & David Ross	& Armando Riesco
Deborah Kim	Laura Ewing	Stephen Bernstein
Denise Burse & Peter Jay Fernandez	Laura Jones	Stephen Graham
Don Nickel	Laura Sametz & Anton Fig	Stephen Sadove
Douglas Kabel	Laura Valeroso & David Seidman	Steven & Lenora Satin
Drew McCoy & Amy Aquino	Laurel Durst	Sunil Arora
Eddie Falco	Laurie Becker	Susan Isaacson
Edith Thurber & Kevin O'Rourke	Lewis Black	Susannah Gray & John Lyons
Ellen Chopay	Lisa Benavides	Susannah Keagle
Ellen Kroll	& Tim Blake Nelson	Suzen Murakoshi
Ellen Oshinsky	Lori O'Connor	Sylvia Shepard & Willy Holtzman
Emily Grishman & Susan Sampliner	Lori Tan Chinn	Tina Galley
Eric Brooks	Lynne Rosenberg	Todd Herman
Eric Jungwirth	Margaret & Peter O'Brien	Tracy Wan & Carl Creager
F. Richard Pappas	Marion Koltun	Valerie Kay & Bruce Graham
Frances McDormand & Joel Coen	Mary & Lionel Allan	Vicki & Craig Holleman
Francine Borgenicht	Mary Kong & Sol Reischer	Vicki & Mark Whatley
Frank Wood & Kay Gayner	Mary Lin & James Yoshimura	Wendy vanden Heuvel & Brad Coley
	Mary Lou Teel	Yared Yawand Wossen

List current as of April 1, 2022

# Knuckle Sandwich!

ARTWORK BY ANTONELLA SUERO LOYOLA



**THE 2022  
STAGE COMBAT PLAYS**

**FRIDAY, JUNE 17  
7:30 P.M.**

**THE FIVE ANGELS THEATER  
789 10TH AVE.**

## **The 52nd Street Project Staff**

Kat Almirañez, Associate Artistic Director  
Avi A. Amon, Musical Director  
Ahmed Attia, Development Manager\*  
George Babiak, Director of Design and Production  
Liz Bell, Clinical Consultant  
Ana Gonzalez-Soto, Receptionist  
Natalie Hirsch, Artistic Director  
Garrett Kim, Program Director  
Kristina Nungaray, Marketing and Events Manager  
Carol Ochs, Executive Director  
John Sheehy, Director of Institutional Advancement  
Johanna Vidal, Director of Education\*  
Caylyn Wan-Creager, Education Associate  
Bri Weintraub, Production Manager  
Iris A. Brown, Graphic Design Consultant  
Christian Corpening and Layla Diaz, Interns  
*\*Project Alumni*

## **“Knuckle Sandwich” Production Staff**

### **Stage Manager**

Jenni Swan

### **Lighting and Sound Designer**

Bri Weintraub

### **Prop Design and Construction**

George Babiak and Leo Layla Diaz

### **House Management**

John Sheehy

### **Flyer/Program Art**

Antonella Suero Loyola

### **Livestream Team**

Director: Katie Bartz

Camera Ops: Ahmed Attia and Leo Layla Diaz



The Project's programs are made possible with public funds from The New York State Council on the Arts, a state agency, and the New York City Department of Cultural Affairs. The 52nd Street Project is a member of Art/NY and Theatre Communications Group (TCG), the national organization for the American theatre.

# **KNUCKLE SANDWICH**

## **THE 2022 LORRAINE COHEN STAGE COMBAT SHOW**

**Stage Combat Instructor**

Kerry Warren

**Program Instructor**

Garrett Kim

### **HANGRY**

Group fight choreography by Kerry Warren.  
Performed by the Stage Combat 2022 Company

### **2013 REMATCH**

Fight choreography by Lanai Blake-Soden, with Aishling Pembroke

Esparanza La Blaire, pro kickboxer and “bodyguard” (ninja) ..... Lanai Blake-Soden  
Emedaiya L’aclaire, mercenary ..... Aishling Pembroke

### **WHAT HAPPENS IN THE BATHROOM, STAYS IN THE BATHROOM**

Fight choreography by Denisse Xolocotzi, with Betsy Hogg

Jess, 15, chill but will throw hands ..... Denisse Xolocotzi  
Stephiney, 17, a bully ..... Betsy Hogg

### **BATTLE OF GODS**

Fight choreography by Peter Muca, with Zach Fike Hodges

Sam Jackson, professional boxer ..... Peter Muca  
Andrew, King of Spartans ..... Zach Fike Hodges

### **ANGER**

Fight choreography by Maria Alcides, with Andrea Abello

Lani, 15, high school student ..... Maria Alcides  
Anger, one of Lani’s emotions ..... Andrea Abello

### **NINJA WARRIORS**

Fight choreography by Aiden Vasquez, with Conor Proft

Shinzo Kyojiro, a pacifist Ninja ..... Aiden Vasquez  
Daikatsu, an Oni ..... Conor Proft

### **CRUMBS VS. RACHEL**

Fight choreography by Kaytie Gil, with Evan Schultz

Crumbs, 14, a high school student ..... Kaytie Gil  
Rachel, 17, a high school student ..... Evan Schultz

### **THE CURE FOR ANGER**

Fight choreography by Daniel Henk, with Jason Alexander Wilks

William, a yoga student ..... Daniel Henk  
Chad, a yoga teacher ..... Jason Alexander Wilks  
Yoga students ..... Aengus O’Donnell, Garrett Kim

## The 52nd Street Project Board of Directors

Lisa Benavides-Nelson	Noël Mihalow
Rachel Chanoff	Roseline Michael Neveling
Cathy Dantchik, co-chair	Carol Ochs
Carolyn DeSena	Margaret Odette
Louis P. Friedman, co-chair	Willie Reale, founder
Robert Goldberg	Shirley Rumierk, alumni member
Stephen Graham, chair emeritus	José Soto, Jr., alumni member
Annie Hausmann	Merritt Tilney
Natalie Hirsch	Wendy vanden Heuvel
Korey Jackson	Alexandra Vassilaros
Valerie Kay	Mark Whatley

---

### What's Going On Here?

The 52nd Street Project is a non-profit organization that brings children from the Hell's Kitchen neighborhood together with professional theater artists to create original theater. **KNUCKLE SANDWICH** is a Stage Combat show, one of our New Platforms series. In it, young members learned some of the basic moves of Fight Choreography and created short plays in which to frame them. Although the plays have the veneer of violence, the ironic twist is that the performers are trained to take care of each other and avoid harm of any kind. Tonight you are viewing the results of this training.

This program continues the in-person return of children to **The 52nd Street Project Clubhouse** and **The Five Angels Theater**. We are delighted and grateful to be working with them in a live, present way.

---

### In-Kind Contributions

Abbeville Press; Ambassador Theatre Group; Avi & Richard Anthony; Ardesia; Kate & Andy Bellin; Lewis Black; Iris A. Brown Design; Cellar 53; William Curran, A Curran Affair; The Daily Show's Trevor Noah; Michael Dorf & City Winery; Dormify.com; Sean Feeney, MISI; Haru Restaurant of Hell's Kitchen; Celia Keenan-Bolger; Karen Kowgios of Withum, Smith, & Brown; Pamela Liebman, The Corcoran Group; Charlie Marshall; Stella McCartney; Michter's Distillery, LLC Noël Mihalow & Prime Films; The Neveling Family; Lauren Friedman, Pharma/Omni Printing; Winston Rodney Photography; Signature Bank; SHOWTIME; The Surrey; Merritt Tilney & Doug Kaden; Vassilaros & Sons Coffee Company; Alex Vassilaros & The Vassilaros Family; The Watkins Company; Vicki & Mark Whatley and Paul, Rifkind, Wharton, & Garrison LLP.

The 52nd Street Project Presents

ARE WE THERE  
YET?

THE

QUESTION  
PLAYS

N.Y.C.



THE JULY 2022 ONE-ON-ONES



PART  
1

**6 NEW PLAYS FEATURING PROJECT KIDS  
PERFORMING WITH ADULT PARTNERS!**

**FRIDAY, JULY 22 AT 7:30 P.M.**

**SATURDAY, JULY 23 AT 3:00 AND 7:30 P.M**

**THE FIVE ANGELS THEATER**

**789 10TH AVE., BETWEEN 52ND & 53RD ST.**

# ARE WE THERE YET? THE LOCATION PLAYS

The July 2022 One-on-Ones - July 22 & 23, Five Angels Theater

## The 52nd Street Project Staff

Kat Almirañez, Associate Artistic Director  
Avi A. Amon, Musical Director  
Ahmed Attia, Development Director\*  
George Babiak, Director of Design and Production  
Liz Bell, Clinical Consultant  
Ana Gonzalez-Soto, Office Manager  
Natalie Hirsch, Artistic Director  
Garrett Kim, Program Director  
Kristina Nungaray, Marketing and Events Manager  
Carol Ochs, Executive Director  
John Sheehy, Director of Institutional Advancement  
Johanna Vidal, Director of Education\*  
Caylyn Wan-Creager, Education Associate  
Bri Weintraub, Production Manager  
Iris A. Brown, Graphic Design Consultant

*\*Project Alumni*

## “ARE WE THERE YET?” Production Staff

### Composer/Music Director

Avi A. Amon

### Set Designer

Burke Brown

### Lighting Designer

Greg MacPherson

### Costume Designer

Michael Piatkowski

### Sound Designer

Alicia Moeller

### Stage Manager

Margaret Gleberman

### Projection Designs

George Babiak, Caylyn Wan-Creager  
and The Project Projection Archive

### Prop Design and Construction

George Babiak and  
Caylyn Wan-Creager

### Backstage Crew

Evan Schultz, Leo Layla Diaz,  
Xavier Espinal

### House Management

Carol Ochs, John Sheehy

### Flyer/Program Art

Patrick Jones

### Color and Layout

George Babiak

### Livestream Team

Director: Katie Bartz

Camera Ops:

Sarah Lopez, Cassandra Sinchi

### Intern

Leo Layla Diaz



The One-on-One Program is made possible with public funds from the National Endowment for the Arts, The New York State Council on the Arts, a state agency, the New York City Department of Cultural Affairs, and funds from Con Edison. The 52nd Street Project is a member of Art/NY and Theatre Communications Group (TCG), the national organization for the American theatre.

# COOL STUFF ON SALE IN THE LOBBY!

Fabulous Flyer Bars ..... \$2.50

*and featuring Shel Silverstein's "Fivey and Twoey" logo:*

Two-tone Project Hoodie ..... \$40.00

Monotone Project Hoodie ..... \$30.00

Crew-neck sweatshirts ..... \$20.00

Project Caps ..... \$20.00

Project T-shirts ..... \$12.00/\$20.00

Project Mugs ..... \$5.00

Project Notebook ..... \$5.00

Project Pencil 3-pack ..... \$1.00

Thank you for coming to **ARE WE THERE YET?** If you are not on our mailing list, join on-line at [www.52project.org](http://www.52project.org). If you're interested in being a volunteer, fill out the form below and hand it to one of our staffers in the lobby.

## PLEASE PUT ME ON YOUR LIST:

07/22

NAME \_\_\_\_\_

ADDRESS \_\_\_\_\_

CITY \_\_\_\_\_

STATE \_\_\_\_\_

ZIP \_\_\_\_\_

HOME PHONE \_\_\_\_\_

DAYTIME OR MOBILE PHONE \_\_\_\_\_

E-MAIL ADDRESS \_\_\_\_\_

MY OCCUPATION \_\_\_\_\_

MY HOBBIES \_\_\_\_\_

WANT TO BE GREEN AND SAVE THE PROJECT MONEY ON POSTAGE?  
CHECK THIS BOX TO RECEIVE OUR NOTICES EXCLUSIVELY VIA E-MAIL.

## YES, I WOULD LIKE TO BE OF HELP. I CAN:

- |   |   |  |
|---|---|--|
| <input type="checkbox"/> Help load in and out for shows | <input type="checkbox"/> Draw and/or paint  | <input type="checkbox"/> Help kids with homework |
| <input type="checkbox"/> Hang lights                    | <input type="checkbox"/> Help with mailings | <input type="checkbox"/> Teach kids a skill      |
| <input type="checkbox"/> Work on a backstage crew       | <input type="checkbox"/> Do office work     | <input type="checkbox"/> Be a chef at an event   |
| <input type="checkbox"/> Do graphic design              | <input type="checkbox"/> Design sound       | <input type="checkbox"/> Design and sew costumes |
| <input type="checkbox"/> Other (please specify) _____   |   |  |

## MY SCHEDULE IS:

- Very flexible. I'm often available during weekdays.
- Somewhat flexible. I can help on the occasional morning or afternoon during the week.
- Not very flexible at all, but I've got some free time on evenings and weekends.

If you would like to mail this (and you're always welcome to enclose a tax-deductible contribution), you can send it to: The 52nd Street Project, 789 10th Avenue, New York, NY 10019. Or fax it to (212) 333-5598.



# WHAT'S COMING UP?

Natalie Hirsch, Artistic Director      The 52nd Street Project Presents      Carol Ochs, Executive Director

## ARE WE THERE YET?

# THE CREATION PLAYS

N.Y.C.

ARTWORK BY PATRICK JAMES. COLOR AND LAYOUT BY GSB

**THE AUGUST 2022 ONE-ON-ONES**

**8 NEW PLAYS FEATURING PROJECT KIDS PERFORMING WITH ADULT PARTNERS!**

**PART 2**

FRIDAY, AUGUST 19 AT 7:30 P.M.  
SATURDAY, AUGUST 20 AT 3:00 AND 7:30 P.M.

### THE FIVE ANGELS THEATER

789 10TH AVE., BETWEEN 52ND & 53RD ST.

ADMISSION FREE, BUT SEATING IS LIMITED.  
VISIT [52PROJECT.ORG](http://52PROJECT.ORG) TO MAKE A RESERVATION  
OR GET THE LINKS FOR THE  
LIVESTREAM ON OUR YOUTUBE CHANNEL.

**THE WAY IT WORKS:**  
Each of the 8 plays is custom-written for a team of one adult and one young Project member. Before writing the plays, each adult playwright must pick, from a hat, one of the Project's classic background projections and, in the writing, incorporate that scenic location at some point in the play.

## SUBSCRIBE TO OUR PODCAST!

A monthly online event created by Garrett Kim, John Sheehy, and your favorite kid/adult team-ups. Go to the podcast section of the iTunes Store and search for "The 52nd Street Project" or "PROJcast."



## BE ON THE LOOKOUT FOR INTERNS!



If you know of any college or graduate students who might enjoy working with us and playing with us with us for a semester, please have them contact Caylyn Creager ([creager@52project.org](mailto:creager@52project.org)). We are currently looking for interns for the Fall of 2022 and the Spring of 2023. Thanks!

## The 52nd Street Project Board of Directors

Lisa Benavides-Nelson  
Rachel Chanoff  
Cathy Dantchik, co-chair  
Carolyn DeSena  
Louis P. Friedman, co-chair  
Robert Goldberg  
Stephen Graham, chair emeritus  
Annie Hausmann  
Natalie Hirsch  
Korey Jackson  
Valerie Kay

Noël Mihalow  
Roseline Michael Neveling  
Carol Ochs  
Margaret Odette  
Willie Reale, founder  
Shirley Rumierk, alumni member  
José Soto, Jr., alumni member  
Merritt Tilney  
Wendy vanden Heuvel  
Alexandra Vassilaros  
Mark Whatley

---

### What's Going On Here?

The 52nd Street Project is a non-profit organization that brings children from the Hell's Kitchen neighborhood together with professional theater artists to create original theater. **ARE WE THERE YET?** is a production of our One-on-One program, which is designed to give children the opportunity to enjoy the undivided attention of a professional theater artist who serves as friend, mentor, and collaborator.

This edition continues our in-person return of children to The 52nd Street Project Clubhouse and The Five Angels Theater. We normally would have taken the students to the country, but this is not possible yet. However, we are delighted and grateful to be working with them in a live, present way.

---

### In-Kind Contributions

Abbeville Press; Ambassador Theatre Group; Avi & Richard Anthony; Ardesia; Kate & Andy Bellin; Lewis Black; Iris A. Brown Design; Cellar 53; William Curran, A Curran Affair; The Daily Show's Trevor Noah; Michael Dorf & City Winery; Dormify.com; Sean Feeney, MISI; Haru Restaurant of Hell's Kitchen; Celia Keenan-Bolger; Karen Kowgios of Withum, Smith, & Brown; Pamela Liebman, The Corcoran Group; Charlie Marshall; Stella McCartney; Michter's Distillery, LLC Noël Mihalow & Prime Films; The Neveling Family; Lauren Friedman, Pharma/Omni Printing; Winston Rodney Photography; Signature Bank; SHOWTIME; The Surrey; Merritt Tilney & Doug Kaden; Vassilaros & Sons Coffee Company; Alex Vassilaros & The Vassilaros Family; The Watkins Company; Vicki & Mark Whatley and Paul, Rifkind, Wharton, & Garrison LLP.

# ARE WE THERE YET?

All original music composed by Avi A. Amon

## PA-PA PARAZZI

Written by Nina Braddock  
for Kylie Rose Beato-Rivera and Gracie Fojtik

*Picked projection: A trendy bar*



Queen K, a famous actor.....Kylie Rose Beato-Rivera  
Ella, a paparazza.....Gracie Fojtik

*Mad Dash* lyrics by Nina Braddock

## THE HAMMER

Written by Ana Soto  
for Jessica Elie-Pierre and Ana Soto

*Picked projection: A private library in a mansion*



Ashley Lorraine..... Jessica Elie-Pierre  
Alice Elizabeth ..... Ana Soto  
Ferdinand the Butler ..... John Sheehy  
Passersby..... The Crew

*Me Gusta Ayudar* lyrics by Ana Soto

## THE HARROWING HISTORY HITCH

Written by Tim J. Lord  
for Xavier Valentin and Michael DeSouza

*Picked projection: A beach with cabanas*



Perseus Peregrine..... Xavier Valentin  
Anibal Andrada .....Michael DeSouza

*A History Mystery* lyrics by Tim J. Lord

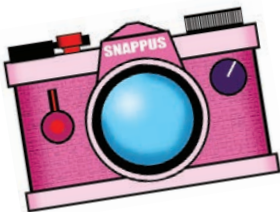

## BELIEVE

Written by Caylyn Wan-Creager  
for Evelyn Myers and Jasminn Johnson

*Picked projection: A cave interior*

Dora, a young painter ..... Evelyn Myers  
Linda, a zebra elephant ..... Jasminn Johnson  
Tiger Panda ..... Leo Layla Diaz  
The Lizard of Ev ..... John Sheehy

*Breathe, Believe* lyrics by Caylyn Wan-Creager

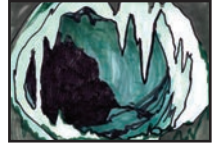

## DARTS AND COASTERS

Written by Michael Propster  
for Edgar Sinchi and Michael Propster

*Picked Projection: A roller coaster*

Arch ..... Edgar Sinchi  
Tag ..... Michael Propster  
Customers ..... Evan Schultz and Xavier Espinal  
Ghosts ..... The Crew

*Ups, Downs, All Arounds* lyrics by Michael Propster



## CHOICES

Written by Jed Clarke  
for Aiden Vasquez and Christian DeMarais

*Picked projection: A post office*

Young Spice ..... Aiden Vasquez  
Stamps ..... Christian DeMarais  
Corporate Steel ..... Xavier Espinal

*Battle to Battle* lyrics by Jed Clarke

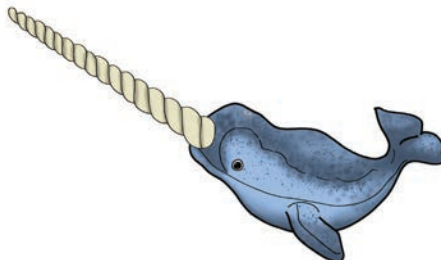

The 52nd Street Project gratefully acknowledges the support of the following foundations & corporations: Carol M. & Stephen E. Canter Family Foundation; Cantor Fitzgerald Relief Fund; Carnegie Corporation of New York; The CLAWS Foundation; Consolidated Edison; Dawkins Family Foundation; Dramatists Play Service, Inc.; The Jean & Louis Dreyfus Foundation; The Education Foundation of America; Flexis Capital, LLC; Goldman Sachs; The Horace W. Goldsmith Foundation; The Stephen P. Hanson Foundation; Heisman Trophy Trust; The William and Flora Hewlett Foundation; Howard Ashman Trust for Theater Arts Lemle Pictures, Inc.; The Lotos Foundation; Frederick Loewe Foundation; The Rona & Randolph M. Nelson Foundation; Seller-Lehrer Family Foundation; The Stavros Niarchos Foundation; Par Plumbing Co., Inc.; The Pinkerton Foundation; Sawyer | Berson Architecture & Landscape Architecture; The Morris and Alma Schapiro Fund; Showtime Networks; The Shubert Foundation; Susquehanna Foundation; Tiger Baron Foundation; John A. Vassilaros & Sons, Inc.; Yorke Construction Corp.; Zubatkin Owner Representation, LLC. We also acknowledge the following individual donors (over \$250) to The 52nd Street Project:

Alexandra Garrison	Gavin Berger & Craig Berggren	Mary Pat Walsh
Alexandra Vassilaros	Glen Gillen	Matthew Jones
Alphonsa Vadakethalake	Helen & Peter Randolph	Megan Cramer
Amy Herzig	Henry Krieger & Robert Joy	Melissa & Lee Briggs
Andrea Johnson	Jacki Ochs & Jan Kroeze	Melissa Lowry
Anna Li & Frank Sposato	Jane & Greg MacPherson	Merritt Tilney & Douglas M. Kaden
Anne M. Bacon	Jeannie & Jim Gaffigan	Michael & Megan Crane
Annie & David Hausmann	Jeff Arnold	Omar Metwally
Becky & Dylan Baker	Jené LeBlanc & Willie Reale	Patrice & Louis Friedman
Beth & Bob Ollwerther	Jeremy Smith	Peter Ackerman
Beth Barry and Daniel Sussman	Jerry McGill	Peter Francis James
Billy Crudup	Jessica Bauman & Ben Posel	Rachel & Larry Norton
Billy Dreskin	Jessica Hecht & Adam Bernstein	Randy Weisenberger
Bob Stockel	John Rossi	Richard Sweren
Buzz Bovshow	Jonathan & Clara Cohen	Rita Silver
Carl Capotorto	Josie Merck	Ron & Judy Tierney
Carol Ochs & Bruce MacVittie	Judy & Sam Berger	Rona & Randy Nelson
Carole and Alan Howard	Judy Kuhn & David Schwab	Rose Gasner & Larry Chertoff
Carole Yass	Judy Taub Gold	Roseline Michael
Carolyn DeSena	Karen & Paul Freitas	& Dennis Neveling
Cathy Dantchik	Karen Powell	Ruth Cohen & Bob Usdin
Cecilia Arana & Kevin Grant	Karin & Tom Schall	Ruth Nelson
Christina Morelli	Katie & Kelly Clark	Sarah & Paul Ardire
Chrysti & David Eigenberg	Katrina vanden Heuvel	Sarah Horowitz & David Venarde
Cynthia Kaplan & David Froelich	Katy Homans & Patterson Sims	Seth Marx
Cynthia Vance-Abrams & Robert Abrams	Kevin Ryder	Shari Goodstein
Danielle Mindess & Robert Cohen	Kim & Jordan Dickstein	Sherry Cohen
David Aldridge	Kimberly Grigsby	Shirley Rumiark
David Williams	Laura & David Ross	& Armando Riesco
Deborah Kim	Laura Ewing	Stephen Bernstein
Denise Burse & Peter Jay Fernandez	Laura Jones	Stephen Graham
Don Nickel	Laura Sametz & Anton Fig	Stephen Sadove
Douglas Kabel	Laura Valeroso & David Seidman	Steven & Lenora Satin
Drew McCoy & Amy Aquino	Laurel Durst	Sunil Arora
Eddie Falco	Laurie Becker	Susan Isaacson
Edith Thurber & Kevin O'Rourke	Lewis Black	Susannah Gray & John Lyons
Ellen Chopay	Lisa Benavides	Susannah Keagle
Ellen Kroll	& Tim Blake Nelson	Suzen Murakoshi
Ellen Oshinsky	Lori O'Connor	Sylvia Shepard & Willy Holtzman
Emily Grishman & Susan Sampliner	Lori Tan Chinn	Tina Galley
Eric Brooks	Lynne Rosenberg	Todd Herman
Eric Jungwirth	Margaret & Peter O'Brien	Tracy Wan & Carl Creager
F. Richard Pappas	Marion Koltun	Valerie Kay & Bruce Graham
Frances McDormand & Joel Coen	Mary & Lionel Allan	Vicki & Craig Holleman
Francine Borgenicht	Mary Kong & Sol Reischer	Vicki & Mark Whatley
Frank Wood & Kay Gayner	Mary Lin & James Yoshimura	Wendy vanden Heuvel & Brad Coley
	Mary Lou Teel	Yared Yawand Wossen

List current as of April 1, 2022

The 52nd Street Project Presents

ARE WE THERE  
YET?

THE

EXHIBITION

PLAYS

N.Y.C.



THE AUGUST 2022 ONE-ON-ONES

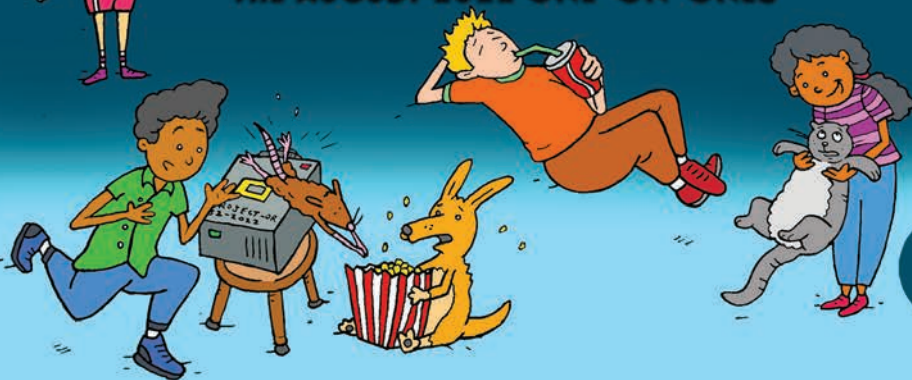

PART  
2

**9 NEW PLAYS FEATURING PROJECT KIDS  
PERFORMING WITH ADULT PARTNERS!**

**FRIDAY, AUGUST 19 AT 7:30 P.M.**

**SATURDAY, AUGUST 20 AT 3:00 AND 7:30 P.M**

**THE FIVE ANGELS THEATER**

**789 10TH AVE., BETWEEN 52ND & 53RD ST.**

# ARE WE THERE YET? THE LOCATION PLAYS, PART 2

The August 2022 One-on-Ones - August 19 and 20, Five Angels Theater

## The 52nd Street Project Staff

Kat Almirañez, Associate Artistic Director  
Avi A. Amon, Musical Director  
Ahmed Attia, Development Director\*  
George Babiak, Director of Design and Production  
Liz Bell, Clinical Consultant  
Ana Gonzalez-Soto, Office Manager  
Natalie Hirsch, Artistic Director  
Garrett Kim, Program Director  
Kristina Nungaray, Marketing and Events Manager  
Carol Ochs, Executive Director  
John Sheehy, Director of Institutional Advancement  
Johanna Vidal, Director of Education\*  
Caylyn Wan-Creager, Education Associate  
Bri Weintraub, Production Manager  
Iris A. Brown, Graphic Design Consultant

*\*Project Alumni*

## “ARE WE THERE YET? PART 2”

### Production Staff

#### Composer/Music Director

Raiah Rofsky

#### Set Designer

Burke Brown

#### Lighting Designer

Katie Bartz

#### Costume Designers

Taylor Barnett for all plays  
except *Wild Wild West BFF*,  
which was by Michael Piatkowski.

#### Sound Designer

Evan Schultz

#### Stage Manager

Betsy Hogg

#### Projection Designs

George Babiak, Caylyn Wan-Creager  
and The Project Projection Archive

#### Prop Design and Construction

George Babiak, Bri Weintraub, and  
Caylyn Wan-Creager

#### Backstage Crew

Daniel Henk, Kassandra Sinchi,  
Ally Thomas

#### House Management

Carol Ochs, John Sheehy

#### Flyer/Program Art

Patrick Jones

#### Color and Layout

George Babiak

#### Livestream Team

Director: Katie Bartz

Camera Ops:

Ella Lieberman, Gianna Sheppard



The One-on-One Program is made possible with public funds from the National Endowment for the Arts, The New York State Council on the Arts, a state agency, the New York City Department of Cultural Affairs, and funds from Con Edison. The 52nd Street Project is a member of Art/NY and Theatre Communications Group (TCG), the national organization for the American theatre.

# COOL STUFF ON SALE IN THE LOBBY!

Fabulous Flyer Bars ..... \$2.50

*and featuring Shel Silverstein's "Fivey and Twoey" logo:*

Two-tone Project Hoodie ..... \$40.00

Monotone Project Hoodie ..... \$30.00

Crew-neck sweatshirts ..... \$20.00

Project Caps ..... \$20.00

Project T-shirts ..... \$12.00/\$20.00

Project Mugs ..... \$5.00

Project Notebook ..... \$5.00

Project Pencil 3-pack ..... \$1.00

Thank you for coming to **ARE WE THERE YET?** If you are not on our mailing list, join on-line at [www.52project.org](http://www.52project.org). If you're interested in being a volunteer, fill out the form below and hand it to one of our staffers in the lobby.

## PLEASE PUT ME ON YOUR LIST:

08/22

NAME \_\_\_\_\_

ADDRESS \_\_\_\_\_

CITY \_\_\_\_\_

STATE \_\_\_\_\_

ZIP \_\_\_\_\_

HOME PHONE \_\_\_\_\_

DAYTIME OR MOBILE PHONE \_\_\_\_\_

E-MAIL ADDRESS \_\_\_\_\_

MY OCCUPATION \_\_\_\_\_

MY HOBBIES \_\_\_\_\_

WANT TO BE GREEN AND SAVE THE PROJECT MONEY ON POSTAGE?  
CHECK THIS BOX TO RECEIVE OUR NOTICES EXCLUSIVELY VIA E-MAIL.

## YES, I WOULD LIKE TO BE OF HELP. I CAN:

- |   |   |  |
|---|---|--|
| <input type="checkbox"/> Help load in and out for shows | <input type="checkbox"/> Draw and/or paint  | <input type="checkbox"/> Help kids with homework |
| <input type="checkbox"/> Hang lights                    | <input type="checkbox"/> Help with mailings | <input type="checkbox"/> Teach kids a skill      |
| <input type="checkbox"/> Work on a backstage crew       | <input type="checkbox"/> Do office work     | <input type="checkbox"/> Be a chef at an event   |
| <input type="checkbox"/> Do graphic design              | <input type="checkbox"/> Design sound       | <input type="checkbox"/> Design and sew costumes |
| <input type="checkbox"/> Other (please specify) _____   |   |  |

## MY SCHEDULE IS:

- Very flexible. I'm often available during weekdays.
- Somewhat flexible. I can help on the occasional morning or afternoon during the week.
- Not very flexible at all, but I've got some free time on evenings and weekends.

If you would like to mail this (and you're always welcome to enclose a tax-deductible contribution), you can send it to: The 52nd Street Project, 789 10th Avenue, New York, NY 10019. Or fax it to (212) 333-5598.



# ARE WE THERE YET? THE LOCATION PLAYS - ACT 1

All original music composed by Raiah Rofsky, except where noted.

*Are We There Yet? Theme Song* lyrics by John Sheehy

## GIMME SOME SPACE

Written and Directed by George Babiak for Hannah Santos (age 12)

*Picked Projection: An office at NASA Headquarters*

General DiSorda/Spork ..... Hannah Santos

Tuck Meager..... George Babiak

Voice of Mission Control..... John Sheehy

*Zoombangan Song of Friendship* lyrics by George Babiak

## CURE FOR HEADACHE

Written by Max Posner for Jojo Perez (age 12) and Emma Ramos.

Directed by Emma Ramos. *Picked Projection: A mansion on a cliff*

Peter-Michael ..... Jojo Perez

Victoria..... Emma Ramos

Dr. Hughes..... John Sheehy

*Hey, Sometimes* lyrics by Max Posner

## THE MOST AMAZINGEST SHOW ON EARTH

Written by Helen Cespedes for Giovanni Benedicto (age 11) and Alex J. Gould.

Directed by Alex J. Gould. *Picked Projection: A Circus Big Top*

P. T. Penguin, a penguin ringmaster ..... Giovanni Benedicto

Maurice the Mighty, a kangaroo strongman ..... Alex J. Gould

Kitty Kyoot, a cat..... Cassandra Sinchi

Thaddeus Barnacle, a Sea Lion ..... Ally Thomas

*Big Top Fever* lyrics by Helen Cespedes

## HAPPIER THAN EVER

By Molly Carden for Arianna Casiano (age 12) and Aishling Pembroke.

Directed by Aishling Pembroke. *Picked Projection: A village in Tibet*

Aila..... Arianna Casiano

Winnie ..... Aishling Pembroke

*Find Your Own Way* lyrics by Molly Carden

## THE CURSE OF HOO-RA-RA

Written by Garrett David Kim for Alyssa Garcia (age 11) and Jasminn Johnson.

Directed by Olivia AbiAssi. *Picked Projection: A school auditorium*

Holly Howlback, a werewolf..... Alyssa Garcia

Iris Lookalot, a cyclops ..... Jasminn Johnson

Aboogail, a poltergeist..... Cassandra Sinchi

Zombelia, a zombie ..... Ally Thomas

Horace, a demon ..... Daniel Henk

*The Countercurse Dance* lyrics by Garrett David Kim

# ARE WE THERE YET? THE LOCATION PLAYS - ACT 2

## BUTTERFLIES ARE FREE

Written by Cynthia Kaplan for Khailey Peña (age 11) and Marinda Anderson.  
Directed by Marinda Anderson. *Picked Projection: A hardware store.*

Pam, a caterpillar and later, a butterfly .....Khailey Peña  
Nancy, also a caterpillar and butterfly.....Marinda Anderson  
Harold.....John Sheehy  
*Harold, Get Me Out of Here* lyrics by Cynthia Kaplan

## THE CHEESE TYCOON

Written by Sean Kenealy for Hansel Benedicto (age 11) and Mat Hostetler.  
Directed by Mat Hostetler. *Picked Projection: A rundown old shack*

Jerry, a cheese tycoon..... Hansel Benedicto  
Maurice, an old man ..... Mat Hostetler  
*Cheese Capital of the World* lyrics by Sean Kenealy

## COQUITO LIBRE

Written and Directed by José Duran for Ethan Cruz (age 13).  
*Picked Projection: A messy living room*

Coquito, a would-be wrestler .....Ethan Cruz  
Don Pepe, a has-been trainer ..... Jose Duran  
Gym Bros..... Daniel Henk and Cassandra Sinchi  
Mama Goya ..... Emma Ramos  
El Chupacabra.....John Sheehy  
*Heart of a Champion* lyrics by José Duran

## WILD WILD WEST BFF

Written and directed by Arielle Goldman for Faith Mitchell (age 12).  
*Picked Projection: A main street in the Old West*

Cora.....Faith Mitchell  
Dora..... Arielle Goldman  
George the Boss..... George Babiak  
John..... John Sheehy  
Business Woman .....Marinda Anderson  
Police officer.....Kassandra Sinchi

*It Starts with a Rumble* lyrics by Arielle Goldman, music by Avi A. Amon.  
Costumes by Michael Piatkowski.

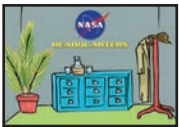

## The 52nd Street Project Board of Directors

Lisa Benavides-Nelson  
Rachel Chanoff  
Cathy Dantchik, co-chair  
Carolyn DeSena  
Louis P. Friedman, co-chair  
Robert Goldberg  
Stephen Graham, chair emeritus  
Annie Hausmann  
Natalie Hirsch  
Korey Jackson  
Valerie Kay

Noël Mihalow  
Roseline Michael Neveling  
Carol Ochs  
Margaret Odette  
Willie Reale, founder  
Shirley Rumierk, alumni member  
José Soto, Jr., alumni member  
Merritt Tilney  
Wendy vanden Heuvel  
Alexandra Vassilaros  
Mark Whatley

---

### What's Going On Here?

The 52nd Street Project is a non-profit organization that brings children from the Hell's Kitchen neighborhood together with professional theater artists to create original theater. **ARE WE THERE YET? - PART 2** is a production of our One-on-One program, which is designed to give children the opportunity to enjoy the undivided attention of a professional theater artist who serves as friend, mentor, and collaborator.

This edition continues our in-person return of children to The 52nd Street Project Clubhouse and The Five Angels Theater. We normally would have taken the students to the country, but this is not possible yet. However, we are delighted and grateful to be working with them in a live, present way.

---

### In-Kind Contributions

Abbeville Press; Ambassador Theatre Group; Avi & Richard Anthony; Ardesia; Kate & Andy Bellin; Lewis Black; Iris A. Brown Design; Cellar 53; William Curran, A Curran Affair; The Daily Show's Trevor Noah; Michael Dorf & City Winery; Dormify.com; Sean Feeney, MISI; Haru Restaurant of Hell's Kitchen; Celia Keenan-Bolger; Karen Kowgios of Withum, Smith, & Brown; Pamela Liebman, The Corcoran Group; Charlie Marshall; Stella McCartney; Michter's Distillery, LLC Noël Mihalow & Prime Films; The Neveling Family; Lauren Friedman, Pharma/Omni Printing; Winston Rodney Photography; Signature Bank; SHOWTIME; The Surrey; Merritt Tilney & Doug Kaden; Vassilaros & Sons Coffee Company; Alex Vassilaros & The Vassilaros Family; The Watkins Company; Vicki & Mark Whatley and Paul, Rifkind, Wharton, & Garrison LLP.

**WHAT'S COMING UP?**

**THE 2022  
PLAYBACK  
PLAYS**

The reverse of the One-on-Ones!  
Project members write plays for themselves  
and an adult partner to perform together.

October 14th and 15th right here at

**THE FIVE ANGELS THEATER**

**SUBSCRIBE TO OUR PODCAST!**

A monthly online event created by  
Garrett Kim, John Sheehy, and your  
favorite kid/adult team-ups. Go to the  
podcast section of the iTunes Store and  
search for "The 52nd Street Project"  
or "PROJcast."



**BE ON THE LOOKOUT FOR INTERNS!**



If you know of any college or graduate students  
who might enjoy working with us and playing  
with us for a semester, please have them contact  
Caylyn Creager ([creager@52project.org](mailto:creager@52project.org)). We are  
currently looking for interns for the Fall of 2022  
and the Spring of 2023. Thanks!

The 52nd Street Project gratefully acknowledges the support of the following foundations & corporations: Carol M. & Stephen E. Canter Family Foundation; Cantor Fitzgerald Relief Fund; Carnegie Corporation of New York; The CLAWS Foundation; Consolidated Edison; Dawkins Family Foundation; Dramatists Play Service, Inc.; The Jean & Louis Dreyfus Foundation; The Education Foundation of America; Flexis Capital, LLC; Goldman Sachs; The Horace W. Goldsmith Foundation; The Stephen P. Hanson Foundation; Heisman Trophy Trust; The William and Flora Hewlett Foundation; Howard Ashman Trust for Theater Arts Lemle Pictures, Inc.; The Lotos Foundation; Frederick Loewe Foundation; The Rona & Randolph M. Nelson Foundation; Seller-Lehrer Family Foundation; The Stavros Niarchos Foundation; Par Plumbing Co., Inc.; The Pinkerton Foundation; Sawyer | Berson Architecture & Landscape Architecture; The Morris and Alma Schapiro Fund; Showtime Networks; The Shubert Foundation; Susquehanna Foundation; Tiger Baron Foundation; John A. Vassilaros & Sons, Inc.; Yorke Construction Corp.; Zubatkin Owner Representation, LLC. We also acknowledge the following individual donors (over \$250) to The 52nd Street Project:

Alexandra Garrison	Gavin Berger & Craig Berggren	Mary Pat Walsh
Alexandra Vassilaros	Glen Gillen	Matthew Jones
Alphonsa Vadakethalake	Helen & Peter Randolph	Megan Cramer
Amy Herzig	Henry Krieger & Robert Joy	Melissa & Lee Briggs
Andrea Johnson	Jacki Ochs & Jan Kroeze	Melissa Lowry
Anna Li & Frank Sposato	Jane & Greg MacPherson	Merritt Tilney & Douglas M. Kaden
Anne M. Bacon	Jeannie & Jim Gaffigan	Michael & Megan Crane
Annie & David Hausmann	Jeff Arnold	Omar Metwally
Becky & Dylan Baker	Jené LeBlanc & Willie Reale	Patrice & Louis Friedman
Beth & Bob Ollwerther	Jeremy Smith	Peter Ackerman
Beth Barry and Daniel Sussman	Jerry McGill	Peter Francis James
Billy Crudup	Jessica Bauman & Ben Posel	Rachel & Larry Norton
Billy Dreskin	Jessica Hecht & Adam Bernstein	Randy Weisenberger
Bob Stockel	John Rossi	Richard Sweren
Buzz Bovshow	Jonathan & Clara Cohen	Rita Silver
Carl Capotorto	Josie Merck	Ron & Judy Tierney
Carol Ochs & Bruce MacVittie	Judy & Sam Berger	Rona & Randy Nelson
Carole and Alan Howard	Judy Kuhn & David Schwab	Rose Gasner & Larry Chertoff
Carole Yass	Judy Taub Gold	Roseline Michael
Carolyn DeSena	Karen & Paul Freitas	& Dennis Neveling
Cathy Dantchik	Karen Powell	Ruth Cohen & Bob Usdin
Cecilia Arana & Kevin Grant	Karin & Tom Schall	Ruth Nelson
Christina Morelli	Katie & Kelly Clark	Sarah & Paul Ardire
Chrysti & David Eigenberg	Katrina vanden Heuvel	Sarah Horowitz & David Venarde
Cynthia Kaplan & David Froelich	Katy Homans & Patterson Sims	Seth Marx
Cynthia Vance-Abrams & Robert Abrams	Kevin Ryder	Shari Goodstein
Danielle Mindess & Robert Cohen	Kim & Jordan Dickstein	Sherry Cohen
David Aldridge	Kimberly Grigsby	Shirley Rumiark
David Williams	Laura & David Ross	& Armando Riesco
Deborah Kim	Laura Ewing	Stephen Bernstein
Denise Burse & Peter Jay Fernandez	Laura Jones	Stephen Graham
Don Nickel	Laura Sametz & Anton Fig	Stephen Sadove
Douglas Kabel	Laura Valeroso & David Seidman	Steven & Lenora Satin
Drew McCoy & Amy Aquino	Laurel Durst	Sunil Arora
Eddie Falco	Laurie Becker	Susan Isaacson
Edith Thurber & Kevin O'Rourke	Lewis Black	Susannah Gray & John Lyons
Ellen Chopay	Lisa Benavides	Susannah Keagle
Ellen Kroll	& Tim Blake Nelson	Suzen Murakoshi
Ellen Oshinsky	Lori O'Connor	Sylvia Shepard & Willy Holtzman
Emily Grishman & Susan Sampliner	Lori Tan Chinn	Tina Galley
Eric Brooks	Lynne Rosenberg	Todd Herman
Eric Jungwirth	Margaret & Peter O'Brien	Tracy Wan & Carl Creager
F. Richard Pappas	Marion Koltun	Valerie Kay & Bruce Graham
Frances McDormand & Joel Coen	Mary & Lionel Allan	Vicki & Craig Holleman
Francine Borgenicht	Mary Kong & Sol Reischer	Vicki & Mark Whatley
Frank Wood & Kay Gayner	Mary Lin & James Yoshimura	Wendy vanden Heuvel & Brad Coley
	Mary Lou Teel	Yared Yawand Wossen

List current as of April 1, 2022

The  
52nd Street Project  
Presents

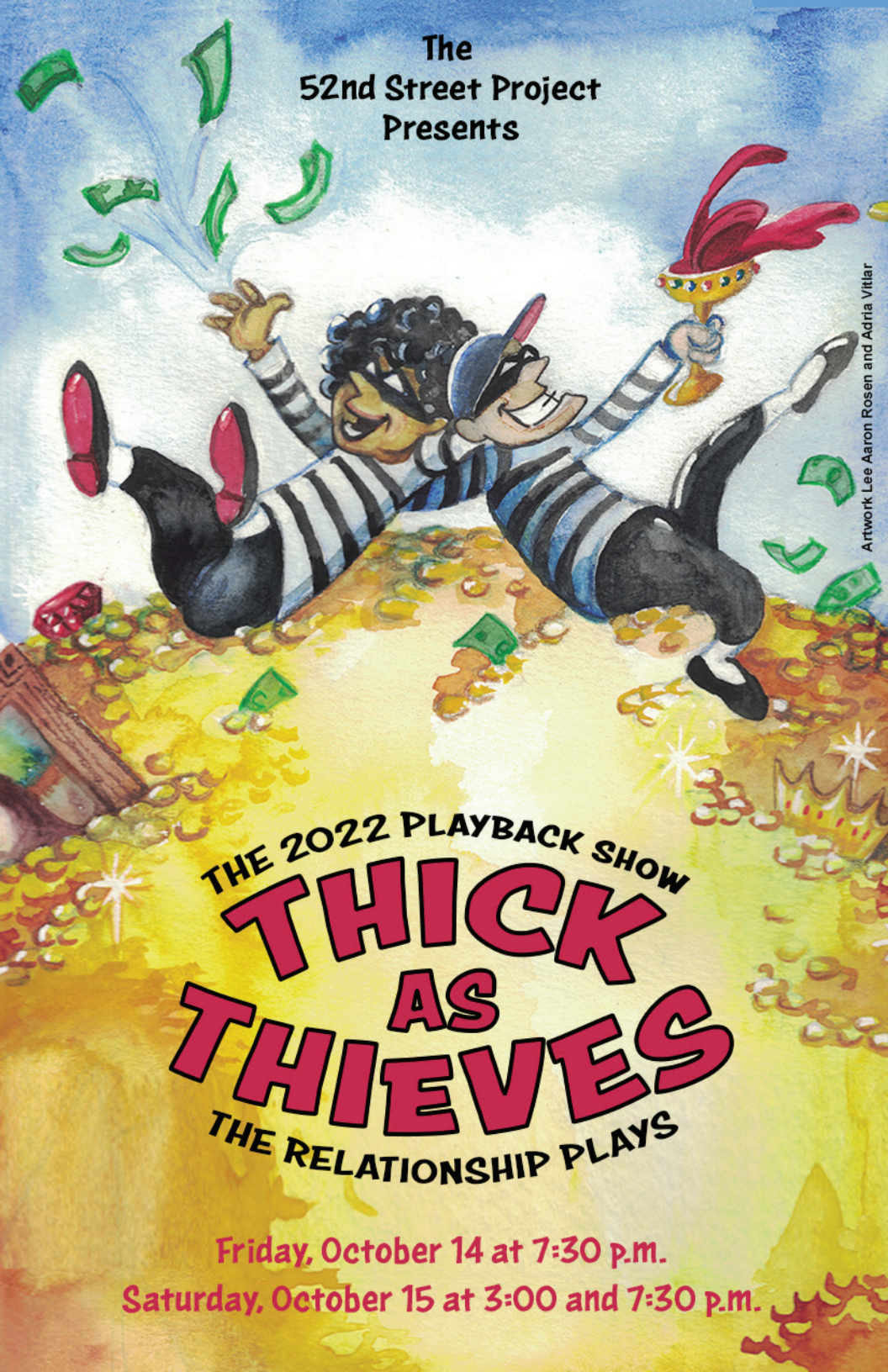

Artwork Lee Aaron Rosen and Adria Vitlar

THE 2022 PLAYBACK SHOW  
**THICK  
AS  
THIEVES**  
THE RELATIONSHIP PLAYS

Friday, October 14 at 7:30 p.m.  
Saturday, October 15 at 3:00 and 7:30 p.m.

# THICK AS THIEVES: THE RELATIONSHIP PLAYS

The 2022 Playback Show - October 14 and 15, Five Angels Theater

## The 52nd Street Project Staff

Kat Almirañez, Associate Artistic Director  
Avi A. Amon, Musical Director  
Ahmed Attia, Development Director\*  
George Babiak, Director of Design and Production  
Liz Bell, Clinical Consultant  
Ana Gonzalez-Soto, Office Manager  
Natalie Hirsch, Artistic Director  
Garrett Kim, Program Director  
Kristina Nungaray, Marketing and Events Manager  
Carol Ochs, Executive Director  
John Sheehy, Director of Institutional Advancement  
Johanna Vidal, Director of Education\*  
Caylyn Wan-Creager, Education Associate  
Bri Weintraub, Production Manager  
Iris A. Brown, Graphic Design Consultant  
Diego Caoili and Julia Feenstra, interns

*\*Project Alumni*

## “THICK AS THIEVES” Production Staff

### Composer/Music Director

Kim Jinhyoung

### Set Designer

Burke Brown

### Lighting Designer

Bri Weintraub

### Costume Designer

Ana Gonzalez-Soto

### Sound Designer

Ally Thomas

### Stage Manager

Gianna Sheppard

### Projection Designs

George Babiak and  
The Project Projection Archive

### Prop Design and Construction

George Babiak

### Backstage Crew

Katie Bartz, Diego Caoili,  
Magalis Fabian, Sarah Lopez

### House Management

Carol Ochs, John Sheehy

### Flyer/Program Art

Lee Rosen and Adria Vitlar

### Flyer/Program Layout

George Babiak

### Livestream Team

Director: Ella Lieberman  
Camera Ops:  
Eli Gutierrez, Sarah Brownstein



The Playback Program is made possible with public funds from the National Endowment for the Arts, The New York State Council on the Arts, a state agency, the New York City Department of Cultural Affairs, and funds from Con Edison. The 52nd Street Project is a member of Art/NY and Theatre Communications Group (TCG), the national organization for the American theatre.

# COOL STUFF ON SALE IN THE LOBBY!

Fabulous Flyer Bars ..... \$2.50

*and featuring Shel Silverstein's "Fivey and Twoey" logo:*

Two-tone Project Hoodie ..... \$40.00

Monotone Project Hoodie ..... \$30.00

Crew-neck sweatshirts ..... \$20.00

Project Caps ..... \$20.00

Project T-shirts ..... \$12.00/\$20.00

Project Mugs ..... \$5.00

Project Notebook ..... \$5.00

Project Pencil 3-pack ..... \$1.00

Thank you for coming to **THICK AS THIEVES** If you are not on our mailing list, join on-line at [www.52project.org](http://www.52project.org). If you're interested in being a volunteer, fill out the form below and hand it to one of our staffers in the lobby.

## PLEASE PUT ME ON YOUR LIST:

10/22

NAME \_\_\_\_\_

ADDRESS \_\_\_\_\_

CITY \_\_\_\_\_

STATE \_\_\_\_\_

ZIP \_\_\_\_\_

HOME PHONE \_\_\_\_\_

DAYTIME OR MOBILE PHONE \_\_\_\_\_

E-MAIL ADDRESS \_\_\_\_\_

MY OCCUPATION \_\_\_\_\_

MY HOBBIES \_\_\_\_\_

*WANT TO BE GREEN AND SAVE THE PROJECT MONEY ON POSTAGE?  
CHECK THIS BOX TO RECEIVE OUR NOTICES EXCLUSIVELY VIA E-MAIL.*

## YES, I WOULD LIKE TO BE OF HELP. I CAN:

- |   |   |  |
|---|---|--|
| <input type="checkbox"/> Help load in and out for shows | <input type="checkbox"/> Draw and/or paint  | <input type="checkbox"/> Help kids with homework |
| <input type="checkbox"/> Hang lights                    | <input type="checkbox"/> Help with mailings | <input type="checkbox"/> Teach kids a skill      |
| <input type="checkbox"/> Work on a backstage crew       | <input type="checkbox"/> Do office work     | <input type="checkbox"/> Be a chef at an event   |
| <input type="checkbox"/> Do graphic design              | <input type="checkbox"/> Design sound       | <input type="checkbox"/> Design and sew costumes |
| <input type="checkbox"/> Other (please specify) _____   |   |  |

## MY SCHEDULE IS:

- Very flexible. I'm often available during weekdays.
- Somewhat flexible. I can help on the occasional morning or afternoon during the week.
- Not very flexible at all, but I've got some free time on evenings and weekends.

If you would like to mail this (and you're always welcome to enclose a tax-deductible contribution), you can send it to: The 52nd Street Project, 789 10th Avenue, New York, NY 10019. Or fax it to (212) 333-5598.



# THICK AS THIEVES: THE RELATIONSHIP PLAYS

All original music composed by Kim Jinhyoung

## PEEPS AND PULITZERS

Written by Lanai Blake-Soden, age 14. Directed by Jenelle Chu.

*Relationship: Co-workers*

Liv ..... Lanai Blake-Soden  
Ginny ..... Jenelle Chu  
Voice of Boss ..... Katie Bartz

*We're Waiting* lyrics by Lanai Blake-Soden

## FUNKY 48

Written by Andrew Moore, age 13. Directed by Jonathan Dimas.

*Relationship: Neighbors*

Calvin ..... Andrew Moore  
Crazy John ..... Jonathan Dimas  
Boss ..... George Babiak  
MC ..... Katie Bartz  
Mark ..... Diego Caoili

*Mark's Rap and John and Calvin's Rap* lyrics by Andrew Moore

## BROKEN LEG

Written by Hanna Brea, age 13. Directed by Kendal Hartse.

*Relationship: Teammates*

Alyica ..... Hanna Brea  
Jonah, Alyica's boyfriend ..... Kendal Hartse  
Coach ..... Diego Caoiliz  
Teammates ..... The Crew

*Soccer Fights* lyrics by Hanna Brea

## A MORTAL MORAL DILEMMA

Written by Alex Breton, age 14. Directed by Gardiner Comfort.

*Relationship: Partners in crime*

Jeeves ..... Alex Breton  
Alucard ..... Gardiner Comfort

*More to Life* lyrics by Alex Breton



# THICK AS THIEVES: THE RELATIONSHIP PLAYS

## MONEY DEFINITELY POSITIVELY 100 PERCENT DOESN'T BUY HAPPINESS

Written by Olive Moayed, age 13. Directed by Angel Desai.

*Relationship: BFFs*

D-748315269.....Olive Moayed  
Ezra ..... Angel Desai  
A-647321 ..... Magalis Fabian

*Well, This Is Fun* lyrics by Olive Moayed

## THE TRUTH ABOUT DRAGONS AND POLAR BEARS

Written by Adolfo Sinchi, age 13. Directed by Kyle Cameron.

*Relationship: Family*

Tim, a would-be polar bear tamer.....Adolfo Sinchi  
George, a dragon tamer ..... Kyle Cameron  
Mrs. Flamesalot (Mom)..... Katie Bartz  
Mr. Flamesalot (Dad)..... George Babiak  
Billy, a 10 year-old dragon tamer..... Diego Caoili

*Earth or Polar Bears* lyrics by Adolfo Sinchi

## OLD FRIENDS

Written by Peter Muca, age 15. Directed by Charlie O'Rourke.

*Relationship: Old Friends*

Jack, a samurai ..... Peter Muca  
Sam, a mafia boss..... Charlie O'Rourke  
Henchman ..... Sarah Lopez

*Violence Always Finds a Way* lyrics by Peter Muca



## The 52nd Street Project Board of Directors

Lisa Benavides-Nelson	Noël Mihalow
Rachel Chanoff	Roseline Michael Neveling
Cathy Dantchik, co-chair	Carol Ochs
Carolyn DeSena	Margaret Odette
Louis P. Friedman, co-chair	Willie Reale, founder
Robert Goldberg	Shirley Rumierk, alumni member
Stephen Graham, chair emeritus	José Soto, Jr., alumni member
Annie Hausmann	Merritt Tilney
Natalie Hirsch	Wendy vanden Heuvel
Korey Jackson	Alexandra Vassilaros
Valerie Kay	Mark Whatley

---

### What's Going On Here?

The 52nd Street Project is a non-profit organization that brings children from the Hell's Kitchen neighborhood together with professional theater artists to create original theater. **THICK AS THIEVES** is a production of our Playback program, which is designed to give children the opportunity to enjoy the undivided attention of a professional theater artist who serves as friend, mentor, and collaborator.

This edition continues our in-person return of children to The 52nd Street Project Clubhouse and The Five Angels Theater. We normally would have taken the students to the country, but this is not possible yet. However, we are delighted and grateful to be working with them in a live, present way.

---

### In-Kind Contributions

Abbeville Press; Ambassador Theatre Group; Avi & Richard Anthony; Ardesia; Kate & Andy Bellin; Lewis Black; Iris A. Brown Design; Cellar 53; William Curran, A Curran Affair; The Daily Show's Trevor Noah; Michael Dorf & City Winery; Dormify.com; Sean Feeney, MISI; Haru Restaurant of Hell's Kitchen; Celia Keenan-Bolger; Karen Kowgios of Withum, Smith, & Brown; Pamela Liebman, The Corcoran Group; Charlie Marshall; Stella McCartney; Michter's Distillery, LLC Noël Mihalow & Prime Films; The Neveling Family; Lauren Friedman, Pharma/Omni Printing; Winston Rodney Photography; Signature Bank; SHOWTIME; The Surrey; Merritt Tilney & Doug Kaden; Vassilaros & Sons Coffee Company; Alex Vassilaros & The Vassilaros Family; The Watkins Company; Vicki & Mark Whatley and Paul, Rifkind, Wharton, & Garrison LLP.

# WHAT'S COMING UP?

## THE 52<sup>ND</sup> STREET PROJECT



Come see what kids can do when they team up with adult professional performers!

Friday, Nov. 18  
at 7:30 p.m.

## OFF THE WALL!

The Zany Plays

The Fall 2022 Playmaking Show

8 Plays written by kids and performed by adult actors!

Friday, December 9th & Saturday, Dec. 10th

Live at the Five Angels Theater or livestreamed on YouTube!

Visit [www.52project.org](http://www.52project.org) for more details!

## SUBSCRIBE TO OUR PODCAST!

A monthly online event created by Garrett Kim, John Sheehy, and your favorite kid/adult team-ups. Go to the podcast section of the iTunes Store and search for "The 52nd Street Project" or "PROJcast."



## BE ON THE LOOKOUT FOR INTERNS!



If you know of any college or graduate students who might enjoy working with us and playing with us for a semester, please have them contact Caylyn Creager ([creager@52project.org](mailto:creager@52project.org)). We are currently looking for interns for the Spring and Summer of 2023. Thanks!

The 52nd Street Project gratefully acknowledges the support of the following foundations & corporations: Bank of America, Bella Vida Productions Inc., Bulls Head Foundation, Inc., Cantor Fitzgerald, Carnegie Corporation of New York, Carol M. & Stephen E. Canter Family Foundation, Circle of Confusion, Community Foundation of Sarasota County, Consolidated Edison, Filomen M. D'Agostino Foundation Corp., Frederick Loewe Foundation, Greenwich Country Day School, Howard Ashman Trust for Theater Arts, Lazard, Ltd, Rose M. Badgeley Residuary Charitable Trust, Seller-Lehrer Family Foundation, Signature Bank, Susquehanna Foundation, Corp., The Educational Foundation Of America, The Henlopen Foundation, The Horace W. Goldsmith Foundation, The Scott Foundation, and the Tiger Baron Foundation. We also acknowledge the following individual donors (over \$250) to The 52nd Street Project:

Adriana Trigiani & Tim Stephenson	Gavin Berger & Craig Berggren	Mary Kong & Sol Reischer
Alan Kreis & Gary Horowitz	Glen Gillen	Mary Lin & James Yoshimura
Alexandra Garrison	James & Hannelore McDaniel	Mary Lou Teel
Alexandra Vassilaros	Jane & Greg MacPherson	Mary Pat Walsh
Amanda Green & Jeffrey Kaplan	Janey Feingold	Matthew Jones
Amy Herzig	Jeannie & Jim Gaffigan	Megan Cramer
Andrea Johnson	Jenni Swan	Megan Thompson
Anna Li & Frank Sposato	Jenny & Jon Steingart	Meg Simon
Anne M. Bacon	Jenny Gersten	Melissa & Lee Briggs
Annie & David Hausmann	Jeremy Smith	Melissa Lowry
Arin Chilcote	Jerry Levine & Nina Tassler	Merritt Tilney & Douglas M. Kaden
Barnaby Harris & Suzie Kondi	Jessica Bauman & Ben Posel	Mickey Lemle
Becky & Dylan Baker	Jessica Hecht & Adam Bernstein	Michael & Megan Crane
Beth & Bob Ollwerther	Joe White & Iris Brown	Michael Herzig
Beth & Ray Abbott	John Lee	Neena Beber
Beth Barry and Daniel Sussman	John Rossi	Noël & Joe Mihalow
Beth Crookham	John Turturro & Kathy Borowitz	Omar Metwally
Bettina S. Buschel	Jonathan & Clara Cohen	Patrice & Louis Friedman
Bill Camp & Elizabeth Marvel	Jonathan Marc Sherman	Peter & Marsue MacNicol
Billy Crudup	& Alexandra Shiva	Rachel & Larry Norton
Billy Dreskin	Jon Ecker	Randi Puccio
Betsy and Bob Goldberg	Joseph Nigro	Rebecca & Richard Dresser
Brenda Wehle & John C. Lynch	Josie Merck	Richard Langan
Buzz Bovshow	Judy & Sam Berger	Richard Sweren
Carl Capotorto	Judy Dennis	Robert Shore
Carol Bell	Judy Kuhn & David Schwab	Robert Shwartz
Carole Yass	Judy Taub Gold	Ron & Judy Tierney
Carolyn DeSena	Kali Crandall	Rose Gasner & Larry Chertoff
Cathy Dantchik	Karen Hauser & Warren Leight	Roseline Michael & Dennis Neveling
Cecilia Arana & Kevin Grant	Karen Powell	Ruth Cohen & Bob Usdin
Chris Ceraso	Karin & Tom Schall	Ruth Nelson
Christine Ziegler-Sullivan	Kate Burton & Michael Ritchie	Sarah & Paul Ardire
Christopher Randolph	Katie & Douglas Jordan	Sarah Horowitz
Chrysti & David Eigenberg	Katy Homans & Patterson Sims	& David Venarde
Courtney & Lowell Pettit	Kerry Pfigst & Russell Dodson	Shari Goodstein
Cynthia Kaplan & David Froelich	Laura & David Ross	Sherry Cohen
Cynthia Vance-Abrams & Robert Abrams	Laura Ewing	Shirley Rumierk & Armando Riesco
Danielle Mindess & Robert Cohen	Laura Jones	Stephen Bernstein
David Aldridge	Laura Sametz & Anton Fig	Stephen Graham
David Williams	Laura Valeroso & David Seidman	Sunil Arora
Debbie & Lawrence Catena	Lauren Weiner	Susan Isaacson
Denise Burse & Peter Jay Fernandez	Laurie Becker	Susannah Gray & John Lyons
Douglas Kabel	Lewis Black	Susan Wallace
Drew McCoy & Amy Aquino	Lili Taylor	Suzen Murakoshi
Drew Milstein	Lindsay Fram & Mason Pettit	Sylvia Shepard & Willy Holtzman
Edie Falco	Lisa Benavides & Tim Blake Nelson	Tara Elwin & Andre Meade
Edith Thurber & Kevin O'Rourke	Lisa Cohen & David Hillman	Terry Belanger & Ken Giese
Elaine Musselman	Liz Bell & J. Andrew Stein	Tina Galley
Elizabeth & Eric Berman	Lois Smith	Todd Herman
Ellen Chopay	Lori O'Connor	Tony Goldwyn & Jane Musky
Ellen Kroll	Lori Tan Chinn	Valerie Kay & Bruce Graham
Emily Grishman & Susan Sampliner	Lynda Hughes	Vicki & Craig Holleman
F. Richard Pappas	Lyn Hejiniian & Larry Ochs	Vicki & Mark Whatley
Frances & Fred Langbecker	Lynne Rosenberg	Vicki de Klerk-Rubin
Frances McDormand & Joel Coen	Margaret & Peter O'Brien	Wendy Ettinger
Frances Strauss	Marion Koltun	Wendy vanden Heuvel & Brad Coley
Francine Borgenicht	Marjorie & Michael Loeb	Will Keigler
Frank Wood & Kay Gayner	Mary & Lionel Allan	Yared Yawand Wossen

The 52nd Street Project Presents

# JELLY OF MY JAMS

**SONGS WRITTEN BY  
YOUNG PEOPLE AND PERFORMED BY  
ADULT MUSICIANS AND SINGERS!**



## **THE 2022 SONGMAKING CONCERT**

Friday, November 18 at 7:30 p.m.

Live onstage and live-streamed to your home.

**THE FIVE ANGELS THEATER**

789 10th Ave. (Between 52nd and 53rd St.)

Admission FREE! For information and reservations, visit [52project.org](https://52project.org)

# JELLY OF MY JAMS

## THE COMPANY

### The Lyricists

Caelnne Arango-Ramirez  
Logan Centeno  
Brooke Pendleton

### The Composers/Musicians

Rowan Blackwood  
Fouad Dakwar  
Lorenzo Pipino

### The Singers

Kendall Cafaro  
Lilli Cooper  
Tommy McDowell  
Sahar Milani  
Ronald Peet  
Neil Tyrone Pritchard  
Angie Toledo  
Natalie Walker

### Music Director

Avi A. Amon

### Songmaking Director

Garrett Kim

### Lighting Designer

Katie Bartz

### Stage Manager

Kate Gulden

### Photography

Winston Rodney

### Fall 2022 Interns

Diego Caoili  
Julia Feenstra

### Audio Engineer

Atticus Mulkey

### Livestream Camera

Julia Feenstra

### Special Thanks

The Songmaking program has been established in collaboration with the **Graduate Musical Theater Writing Program** at NYU's **Tisch School Of The Arts**, and **Writing and Design for Musical Theater** at **BerkleeNYC**. We'd also like to thank **Fred Carl** and **Danny Larsen** at NYU, and **Tiffany Chen**, **Loudon Sterns**, **Stephen Webber**, **Connor White**, and **Julianne Wick Davis**, of **Berklee NYC**.

The Songmaking Program is made possible with public funds from The New York State Council on the Arts, a state agency, and the New York City Department of Cultural Affairs. The 52nd Street Project is a member of Art/NY and Theatre Communications Group (TCG), the national organization for the American theatre.



The 52nd Street Project is a non-profit community-based arts organization that brings children from the Hell’s Kitchen neighborhood together with professional artists to create original art. The Songmaking program partners 52nd Street Project kids with adult composers to create original songs. Over the seven weeks of Songmaking, led by Avi Amon and Program Director Garrett David Kim, these young lyricists explore how their own words and ideas fit together with their composer’s music to create songs. Near the end of the program, we bring in a company of singers to perform the completed songs, and share them with an audience.

**The 52nd Street Project Staff**

- Kat Almirañez, Associate Artistic Director
- Avi A. Amon, Musical Director
- Ahmed Attia, Development Manager\*
- George Babiak, Director of Design and Production
- Liz Bell, Clinical Consultant
- Natalie Hirsch, Artistic Director
- Garrett Kim, Program Director
- Kristina Nungaray, Marketing and Events Manager
- Carol Ochs, Executive Director
- John Sheehy, Director of Institutional Advancement
- Ana Soto-Gonzalez, Receptionist
- Johanna Vidal, Director of Education\*
- Caylyn Wan-Creager, Education Associate
- Bri Weintraub, Production Manager
- Iris A. Brown, Graphic Design Consultant

*\*Project Alumni*

**The 52nd Street Project Board of Directors**

- Lisa Benavides-Nelson
- Rachel Chanoff
- Cathy Dantchik, co-chair
- Carolyn DeSena
- Louis P. Friedman, co-chair
- Robert Goldberg
- Stephen Graham, chair emeritus
- Annie Hausmann
- Natalie Hirsch
- Korey Jackson
- Valerie Kay
- Noël Mihalow
- Roseline Michael Neveling
- Carol Ochs
- Margaret Odette
- Willie Reale, founder
- Shirley Rumierk, alumni member
- José Soto, Jr., alumni member
- Merritt Tilney
- Wendy vanden Heuvel
- Alexandra Vassarlos
- Mark Whatley

Want to make a donation to The 52nd Street Project?  
Just visit [www.52project.org](http://www.52project.org) and click “You Can Help.”

Or make a gift via



@Fifty-Two-Project



# NEW FAVORITE PASTRY

Lyrics by Logan Centeno

Music by Fouad Dakwar

Sung by Natalie Walker

I wanna become a pastry  
I wanna become a pastry!  
Maybe a cute lil cupcake...  
They're so sweet and small...

I wanna become a pastry  
I wanna become a pastry  
So I won't be bullied  
For being way too savory  
I dream that I'll be sugary  
But back to reality  
Look to reality...

I sneak into the chef's bakery  
And steal some frosting silently  
(Don't do this at home!)  
I dump it on my head  
Even though it's a mess  
Suddenly I hear a bell  
The chef puts me out at front

I think I've become a pastry  
I think I've become a pastry  
'Cause the kids are pointing at me  
And their mouths are watering

I'm their new favorite pastry now  
Bells are ringing out  
I'm their new favorite pastry now  
Cupcakes, get out of town

Yeah ya bakery bullies!!!



# SUNDAY MORNIN', IN OUTER SPACE

Lyrics by Logan Centeno  
Music by Fouad Dakwar  
Sung by Tommy McDowell

(In grandma voice)  
Get back to dreamin'  
Get back to dreamin'

Sunday mornin' in outer space  
Inside my dream  
It's 8:22  
Outside my dream

Tingling stars  
From my bedroom  
Smelling the void  
Tastin' the moon!!!

Get back to dreamin'  
Get back to dreamin'  
Get back to dreamin'  
Don't let the dream end

Get back to dreamin'  
Get back to dreamin'

Sunday mornin', it's getting darker  
And I'm feeling weirder  
It's 10:22  
When will I wake up?

Tingling stars  
From my bedroom  
I smell the void  
Tastin' the moon!!!  
Feelin' like deja vu



Get back to dreamin'  
Get back to dreamin'  
Get back to dreamin'  
Don't let the dream end

Get back to dreamin'  
Get back to dreamin'

Uh oh...  
Stars crumblin'  
Solar system evaporatin'  
Until it all came to an...  
END...

I just woke...up



# 52

Lyrics by Logan Centeno

Music by Fouad Dakwar

Sung by Ronald Peet

The 52nd Street Project

The 52nd Street Project

Power o' love

Making songs,

Writing plays,

Creativity every day

The 52nd Street Project

There's a strength

From stepping into someone else's shoes...

Whether they be real o' fiction

Sad or joyful, yeh heh

There is a strength in that

Seeing people change the world

The 52nd Street Project

The 52nd Street Project

Power of us

Making friends,

Visiting places,

Inspiration's always at hand

There's a strength

From stepping into someone else's shoes...

Whether they be Fivey or Twoey

You or me, yeh he he he

We're the people who will change the world

Only at the expense of our time

The 52nd Street Project

That's us



# BIRTHDAY LETTER

Lyrics by Caelnne Arango-Ramirez

Music by Rowan Blackwood

Sung by Sahar Milani

Looking through my window in my room  
Reminds me of my birthday with you  
When we took photographs in my house...  
Spread them in my room...  
Those good times, they were true

All those sleepless nights  
While dreamin' with my eyes,  
Only reminds me how bad it hurts  
And while you party here  
My memories disappear  
Of all the times I was with you in my mind

Now I'm lying in my bed  
With all of the things that you said...  
In my mind, in my mind...  
Those days, weeks, hours & months of being alone  
Without you, without you

Sometimes in those days I can't live  
Without you, I think about you  
Whenever I dream or even think I lose sleep  
About you, about you  
I start to dance around in my head  
Pirouetting, dancing

All those sleepless nights  
While dreamin' with my eyes,  
Only reminds me how bad it hurts  
And while you party here  
My memories disappear  
Of all the times I was with you in my mind.



# THE RESCUE

Lyrics by Caelnne Arango-Ramirez

Music by Rowan Blackwood

Sung by Angie Toledo

Sometimes all you need is a little push to fall  
over the edge  
To blindly leap is not a leap but a jump...  
To somewhere unknown, is the savior or your  
doom...

Is there someone to help me  
Let me breathe...  
Let me breathe

Once you're there is there a turning back...  
Or can you even go back?  
When you're there can you even be there  
Or a trapped place by someone else's side

Oh can someone help me  
Let me breathe  
Can someone help me  
Let me breathe

The help is a rescue  
The way is dark  
The light will come  
Just wait, can you wait?

Grab my hand, hold me tight,  
Go away, please come back.  
When I'm sad, I think of you  
Can someone help me

Can someone help me  
Let me breathe  
Let me breathe

Maybe someday I can breathe  
And maybe take a break.  
Come stay with me...  
Please stay



# FOR GRANTED

Lyrics by Brooke Pendleton

Music by Lorenzo Pipino

Sung by Neil Tyrone Pritchard

I see kids having fun  
But they don't know how it feels  
Don't know when I might be torn down,  
Living in the shadows as if I'm unreal  
I don't get birthday cakes  
And wake up feeling loved  
Not even have a name just sit above  
They view my art without a second glance.  
See me just as a bench.  
They use me as a seat.  
Blocking my view of neighborhood  
If only I was more than a bench  
If only I was more than a bench  
I feel kids who are crying cause  
They can't get a happy meal..  
Sitting on me throwing a fit.  
I wish I could feel the same.  
Having someone to cry to  
Even if it's lame.  
What if I were more than a bench?  
Maybe I'm just a bench.  
I hear kids talking how I look really cool  
Makes me feel brighter than I am  
If only I could say thanks  
But I'll just be a bench  
I'll be their seat  
What if I'm seen more than a bench  
I am more than a bench  
Ooo  
I am more than a bench



# AVOCADO TOAST

Lyrics by Brooke Pendleton

Music by Lorenzo Pipino

Sung by Kendall Cafaro

Garnished wrong, all alone,  
What would you call worse?  
Thrown around by a baby,  
What could hurt more?  
I just wanna be with my friends on the same plate  
Yada, yada, yada  
“And I swear if this baby cries one more time!!”  
I HATE WATA’



Stuck alone, with a baby  
What could you call worse?  
Giggling, from all my friends  
What could be more annoying?  
If only I had legs to walk believe me I would  
“What are you doing over there guys?”  
Forgetting I’m ever here

Since I’m burnt, I will do  
what all burnt toast does  
That is roll cause I can  
What’s my other option?  
Hopefully I don’t get spotted  
That would be bad  
Probably would get thrown  
In the trash.  
“Yuck!”

Oh no I’m seen  
Just keep rolling, rolling, rolling  
Oh no  
I’m going to be thrown in the trash  
What are they doing?  
Please put me down  
I’ve whirled so hard

Huh?  
They put me down with my friends?  
Mission success!

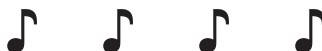

# PUMPKIN SPICE

Lyrics by Brooke Pendleton

Music by Lorenzo Pipino

Sung by Lilli Cooper



almost as the leaves regrew just to fall.  
the different shades of orange just in eyes' view.  
as if the previous green leaves left taking the  
warmth too.  
different shapes and sizes of jackets, scarves,  
and hats.  
in shades of brown, burgundy, and black.  
Pumpkin spice all around makes it feel like fall.

come surround the fireplace  
decorate cookies too  
watch movies made way before 2022  
enjoy the pumpkin spice  
makes everything so nice  
I think it feels like fall don't you?

almost as winter is approaching later than expected.  
sunny days ended with breezy nights feels quite right.  
Thanksgiving knocking at the door  
hello fall summer no more

come surround the fireplace  
decorate cookies too  
watch movies made for fall ooooo  
enjoy the pumpkin spice  
makes everything all nice  
I think it feels like fall don't you

All the leaves come to brown.  
More smiles turn into frowns.  
Freezing temperatures came with heavier coats.  
All black no more color shown  
No gold, no red, no yellow, no orange





The 52nd Street Project gratefully acknowledges the support of the following foundations & corporations: Bank of America, Bella Vida Productions Inc., Bulls Head Foundation, Inc., Cantor Fitzgerald, Carnegie Corporation of New York, Carol M. & Stephen E. Canter Family Foundation, Circle of Confusion, Community Foundation of Sarasota County, Consolidated Edison, Filomen M. D'Agostino Foundation Corp., Frederick Loewe Foundation, Greenwich Country Day School, Howard Ashman Trust for Theater Arts, Lazard, Ltd, Rose M. Badgeley Residuary Charitable Trust, Seller-Lehrer Family Foundation, Signature Bank, Susquehanna Foundation, Corp., The Educational Foundation Of America, The Henlopen Foundation, The Horace W. Goldsmith Foundation, The Scott Foundation, and the Tiger Baron Foundation. We also acknowledge the following individual donors (over \$250) to The 52nd Street Project:

Adriana Trigiani & Tim Stephenson	Gavin Berger & Craig Berggren	Mary Kong & Sol Reischer
Alan Krevis & Gary Horowitz	Glen Gillen	Mary Lin & James Yoshimura
Alexandra Garrison	James & Hannelore McDaniel	Mary Lou Teel
Alexandra Vassilaros	Jane & Greg MacPherson	Mary Pat Walsh
Amanda Green & Jeffrey Kaplan	Janey Feingold	Matthew Jones
Amy Herzig	Jeannie & Jim Gaffigan	Megan Cramer
Andrea Johnson	Jenni Swan	Megan Thompson
Anna Li & Frank Sposato	Jenny & Jon Steingart	Meg Simon
Anne M. Bacon	Jenny Gersten	Melissa & Lee Briggs
Annie & David Hausmann	Jeremy Smith	Melissa Lowry
Arin Chilcote	Jerry Levine & Nina Tassler	Merritt Tilney & Douglas M. Kaden
Barnaby Harris & Suzie Kondi	Jessica Bauman & Ben Posel	Mickey Lemle
Becky & Dylan Baker	Jessica Hecht & Adam Bernstein	Michael & Megan Crane
Beth & Bob Ollwerther	Joe White & Iris Brown	Michael Herzig
Beth & Ray Abbott	John Lee	Neena Beber
Beth Barry and Daniel Sussman	John Rossi	Noël & Joe Mihalow
Beth Crookham	John Turturro & Kathy Borowitz	Omar Metwally
Bettina S. Buschel	Jonathan & Clara Cohen	Patrice & Louis Friedman
Bill Camp & Elizabeth Marvel	Jonathan Marc Sherman	Peter & Marsue MacNicol
Billy Crudup	& Alexandra Shiva	Rachel & Larry Norton
Billy Dreskin	Jon Ecker	Randi Puccio
Betsy and Bob Goldberg	Joseph Nigro	Rebecca & Richard Dresser
Brenda Wehle & John C. Lynch	Josie Merck	Richard Langan
Buzz Bovshow	Judy & Sam Berger	Richard Sweren
Carl Capotorto	Judy Dennis	Robert Shore
Carol Bell	Judy Kuhn & David Schwab	Robert Schwartz
Carole Yass	Judy Taub Gold	Ron & Judy Tierney
Carolyn DeSena	Kali Crandall	Rose Gasner & Larry Chertoff
Cathy Dantchik	Karen Hauser & Warren Leight	Roseline Michael & Dennis Neveling
Cecilia Arana & Kevin Grant	Karen Powell	Ruth Cohen & Bob Usdin
Chris Ceraso	Karin & Tom Schall	Ruth Nelson
Christine Ziegler-Sullivan	Kate Burton & Michael Ritchie	Sarah & Paul Ardire
Christopher Randolph	Katie & Douglas Jordan	Sarah Horowitz
Chrysti & David Eigenberg	Katy Homans & Patterson Sims	& David Venarde
Courtney & Lowell Pettit	Kerry Pflugst & Russell Dodson	Shari Goodstein
Cynthia Kaplan & David Froelich	Laura & David Ross	Sherry Cohen
Cynthia Vance-Abrams & Robert Abrams	Laura Ewing	Shirley Rumierk & Armando Riesco
Danielle Mindess & Robert Cohen	Laura Jones	Stephen Bernstein
David Aldridge	Laura Sametz & Anton Fig	Stephen Graham
David Williams	Laura Valeroso & David Seidman	Sunil Arora
Debbie & Lawrence Catena	Lauren Weiner	Susan Isaacson
Denise Burse & Peter Jay Fernandez	Laurie Becker	Susannah Gray & John Lyons
Douglas Kabel	Lewis Black	Susan Wallace
Drew McCoy & Amy Aquino	Lili Taylor	Suzen Murakoshi
Drew Milstein	Lindsay Fram & Mason Pettit	Sylvia Shepard & Willy Holtzman
Edie Falco	Lisa Benavides & Tim Blake Nelson	Tara Elwin & Andre Meade
Edith Thurber & Kevin O'Rourke	Lisa Cohen & David Hillman	Terry Belanger & Ken Giese
Elaine Musselman	Liz Bell & J. Andrew Stein	Tina Galley
Elizabeth & Eric Berman	Lois Smith	Todd Herman
Ellen Chopay	Lori O'Connor	Tony Goldwyn & Jane Musky
Ellen Kroll	Lori Tan Chinn	Valerie Kay & Bruce Graham
Emily Grishman & Susan Sampliner	Lynda Hughes	Vicki & Craig Holleman
F. Richard Pappas	Lyn Hejiniian & Larry Ochs	Vicki & Mark Whatley
Frances & Fred Langbecker	Lynne Rosenberg	Vicki de Klerk-Rubin
Frances McDormand & Joel Coen	Margaret & Peter O'Brien	Wendy Ettinger
Frances Strauss	Marion Koltun	Wendy vanden Heuvel & Brad Coley
Francine Borgericht	Marjorie & Michael Loeb	Will Keigler
Frank Wood & Kay Gayner	Mary & Lionel Allan	Yared Yawand Wossen

The 52nd Street Project Presents



Natalie Hirsch, Artistic Director Carol Ochs, Executive Director Kat Almirañez, Playmaking Director

# OFF THE WALL!

The  
Zany  
Plays

The Fall 2022  
Playmaking Show

8 plays written by  
kids and performed  
by adults



Friday, Dec. 9  
at 7:30 p.m.  
Saturday, Dec. 10  
at 3:00 and 7:30 p.m.  
**THE FIVE ANGELS THEATER**  
789 10th Ave.  
Live and live-streamed  
**FREE!**  
Visit [52project.org](http://52project.org) to get  
information and reserve seats.



# OFF THE WALL: THE ZANY PLAYS

Fall 2022 Playmaking - December 9 & 10, Five Angels Theater

## The 52nd Street Project Staff

Kat Almirañez, Associate Artistic Director  
Avi A. Amon, Musical Director  
Ahmed Attia, Director of Development\*  
George Babiak, Director of Design and Production  
Liz Bell, Clinical Consultant  
Ana Gonzalez-Soto, Office Manager  
Natalie Hirsch, Artistic Director  
Garrett Kim, Program Director  
Kristina Nungaray, Marketing and Events Manager  
Carol Ochs, Executive Director  
John Sheehy, Director of Institutional Advancement  
Johanna Vidal, Director of Education\*  
Caylyn Wan-Creager, Education Associate  
Bri Weintraub, Production Manager  
Iris A. Brown, Graphic Design Consultant

*\*Project Alumni*

## “OFF THE WALL” Production Staff

### Composer/Music Director

Avi A. Amon

### Set Designer

Burke Brown

### Lighting Designer

Katie Bartz

### Costume Designers

Madelene DeLeon and  
Michael Piatkowski

### Sound Designer

Liz Stanton

### Stage Manager

Margo Gleberman

### Projection Designs

George Babiak, Dana Ruby, Ana Soto,  
and The Project Projection Archive

### Prop Design and Construction

George Babiak

### Backstage Crew

Alex Breton, Xavier Espinal,  
Julia Feenstra, Betsy Hogg

### House Management

Carol Ochs, John Sheehy

### Flyer/Program Art & Layout

George Babiak & Caylyn Wan-Creager

### Livestream Team

Director: Katie Bartz

Camera Ops:

Lauren Rae Vega, Amari DuBose

### Interns

Diego Caoili and Julia Feenstra



The Playmaking Program is made possible with public funds from the National Endowment for the Arts, The New York State Council on the Arts, a state agency, the New York City Department of Cultural Affairs, and funds from Con Edison. The 52nd Street Project is a member of Art/NY and Theatre Communications Group (TCG), the national organization for the American theatre.

# COOL STUFF ON SALE IN THE LOBBY!

Fabulous Flyer Bars ..... \$2.50

*and featuring Shel Silverstein's "Fivey and Twoey" logo:*

Two-tone Project Hoodie ..... \$40.00

Monotone Project Hoodie ..... \$30.00

Crew-neck sweatshirts ..... \$20.00

Project Caps ..... \$20.00

Project T-shirts ..... \$12.00/\$20.00

Project Mugs ..... \$5.00

Project Notebook ..... \$5.00

Project Pencil 3-pack ..... \$1.00

Thank you for coming to **OFF THE WALL!** If you are not on our mailing list, join on-line at [www.52project.org](http://www.52project.org). If you're interested in being a volunteer, fill out the form below and hand it to one of our staffers in the lobby.

## PLEASE PUT ME ON YOUR LIST:

12/22

NAME \_\_\_\_\_

ADDRESS \_\_\_\_\_

CITY \_\_\_\_\_

STATE \_\_\_\_\_

ZIP \_\_\_\_\_

HOME PHONE \_\_\_\_\_

DAYTIME OR MOBILE PHONE \_\_\_\_\_

E-MAIL ADDRESS \_\_\_\_\_

MY OCCUPATION \_\_\_\_\_

MY HOBBIES \_\_\_\_\_

WANT TO BE GREEN AND SAVE THE PROJECT MONEY ON POSTAGE?  
CHECK THIS BOX TO RECEIVE OUR NOTICES EXCLUSIVELY VIA E-MAIL.

## YES, I WOULD LIKE TO BE OF HELP. I CAN:

- |   |   |  |
|---|---|--|
| <input type="checkbox"/> Help load in and out for shows | <input type="checkbox"/> Draw and/or paint  | <input type="checkbox"/> Help kids with homework |
| <input type="checkbox"/> Hang lights                    | <input type="checkbox"/> Help with mailings | <input type="checkbox"/> Teach kids a skill      |
| <input type="checkbox"/> Work on a backstage crew       | <input type="checkbox"/> Do office work     | <input type="checkbox"/> Be a chef at an event   |
| <input type="checkbox"/> Do graphic design              | <input type="checkbox"/> Design sound       | <input type="checkbox"/> Design and sew costumes |
| <input type="checkbox"/> Other (please specify) _____   |   |  |

## MY SCHEDULE IS:

- Very flexible. I'm often available during weekdays.
- Somewhat flexible. I can help on the occasional morning or afternoon during the week.
- Not very flexible at all, but I've got some free time on evenings and weekends.

If you would like to mail this (and you're always welcome to enclose a tax-deductible contribution), you can send it to: The 52nd Street Project, 789 10th Avenue, New York, NY 10019. Or fax it to (212) 333-5598.

# WHAT'S COMING UP?

HOSTS ZOË CHAO AND BILLY CRUDUP

JOIN THE BOARD OF DIRECTORS OF THE 52ND STREET PROJECT TO INVITE YOU TO COME IN FROM THE COLD, GRAB A HOT DRINK, AND SIT BACK AND ENJOY THE SHOW!

# JUST CHILLIN'!

A Very Cool Benefit for  
The 52nd Street Project

Our first  
Winter Gala!



# SAVE THE DATE

MONDAY, FEB. 13, 2023 AT CAPITALE - BOWERY & GRAND ST.  
COCKTAILS AT 6:30 - DINNER AND SHOW AT 7:30 P.M.



HONORING OUR LONG-TIME PALS  
NANCY GILES & MICHAEL POTTS



For information and reservations, contact Ahmed "Frosty" Attia  
[attia@52project.org](mailto:attia@52project.org)



## BE ON THE LOOKOUT FOR INTERNS!

If you know of any college or graduate students who might enjoy working with us and playing with us with us for a semester, please have them contact Caylyn Creager ([creager@52project.org](mailto:creager@52project.org)). We are currently looking for interns for the Summer and Fall of 2022. Thanks!

## The 52nd Street Project Board of Directors

Lisa Benavides-Nelson  
Rachel Chanoff  
Cathy Dantchik, co-chair  
Carolyn DeSena  
Louis P. Friedman, co-chair  
Robert Goldberg  
Stephen Graham, chair emeritus  
Annie Hausmann  
Natalie Hirsch  
Korey Jackson  
Valerie Kay

Noël Mihalow  
Roseline Michael Neveling  
Carol Ochs  
Margaret Odette  
Willie Reale, founder  
Shirley Rumierk, alumni member  
José Soto, Jr., alumni member  
Merritt Tilney  
Wendy vanden Heuvel  
Alexandra Vassilaros  
Mark Whatley

---

### What's Going On Here?

**The 52nd Street Project** is a non-profit organization that brings children from the Hell's Kitchen neighborhood together with professional theater artists to create original theater. **OFF THE WALL** is a production of our Playmaking program. Young people participated in a playwriting course taught by **Kat Almirañez** and adapted for the Project by **Daniel Judah Sklar** from his book *Playmaking: Children Writing and Performing Their Own Plays*. At the end of the course, each child was matched with two actors and a dramaturg/director who guided him or her through the writing of a play. This performance is the end result.

This edition continues our in-person return of children to **The 52nd Street Project Clubhouse** and **The Five Angels Theater**. We normally would have taken the students to the country, but this is not possible yet. However, we are delighted and grateful to be working with them in a live, present way.

---

### In-Kind Contributions

Abbeville Press; Ambassador Theatre Group; Avi & Richard Anthony; Ardesia; Kate & Andy Bellin; Lewis Black; Iris A. Brown Design; Cellar 53; William Curran, A Curran Affair; The Daily Show's Trevor Noah; Michael Dorf & City Winery; Dormify.com; Sean Feeney, MISI; Haru Restaurant of Hell's Kitchen; Celia Keenan-Bolger; Karen Kowgios of Withum, Smith, & Brown; Pamela Liebman, The Corcoran Group; Charlie Marshall; Stella McCartney; Michter's Distillery, LLC Noël Mihalow & Prime Films; The Neveling Family; Lauren Friedman, Pharma/Omni Printing; Winston Rodney Photography; Signature Bank; SHOWTIME; The Surrey; Merritt Tilney & Doug Kaden; Vassilaros & Sons Coffee Company; Alex Vassilaros & The Vassilaros Family; The Watkins Company; Vicki & Mark Whatley and Paul, Rifkind, Wharton, & Garrison LLP.

---

### Extra Special Thanks

We are grateful to Kat Abbruzzese, Natalie Paul, and Jake Pino.

# OFF THE WALL! THE ZANY PLAYS, ACT 1

All original music composed by Avi A. Amon

## THE WITCH'S CAT

Written by Bella Galindo, age 11. Costumes by Madelene DeLeon.

Dramaturge/Director: Ciana Proto

Mary, a witch..... Morgan Everitt  
Jacob, a werewolf..... Noah Gaynor  
Mob member ..... Betsy Hogg  
The Mob ..... The Crew

*The Meet and Greet* lyrics by Bella Galindo

## SNOW DAY

Written by Angel Drew Welsh, age 9

Dramaturge/Director: Jeremy Stoller. Costumes by Madelene DeLeon.

Bob ..... Grant Harrison  
Olivia..... Elia Monte-Brown  
Ping Pong Player..... Betsy Hogg

*Argument and I Could Have Went There* lyrics by Angel Drew Welsh

## THE BIG ADVENTURE OF TIMMY THE T-REX

Written by Mateo Santoni, age 9

Dramaturge/Director: Kareem Lucas. Costumes by Madelene DeLeon.

Timmy, a 10-year old T-Rex..... Devin E. Haqq  
Ms. Cobra, a 20-foot snake .....Kaileela Hobby  
King Kong, Timmy's dad.....Michael Propster  
G.U.R.D.'s ..... The Crew  
Mommy Timmy ..... Julia Feenstra

*Fire* lyrics by Mateo Santoni

## THE CHANGE

Written by Emily Ponce, age 9

Dramaturge/Director: Kaaron Briscoe. Costumes by Madelene DeLeon.

Grace, a metal water bottle ..... Paton Ashbrook  
Max, a clear plastic water bottle ..... Omari Chancellor

*Soda Bottle* lyrics by Emily Ponce

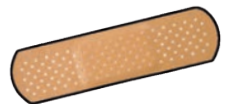

# OFF THE WALL! THE ZANY PLAYS, ACT 2

## DREAM COME TRUE

Written by Khloe Castillo, age 9.

Dramaturge/Director: Krystel Lucas. Costumes by Michael Piatkowski.

Eli (Foxy) ..... Krystel Lucas  
Alex (Tigah) ..... James Yaegashi  
Teacher ..... Julia Feenstra

*Does Not Recognize* lyrics by Khloe Castillo

## PINEAPPLE AND CUPCAKE

Written by José Luján, age 9

Dramaturge/Director: Kyle David. Costumes by Michael Piatkowski.

Pineapple, a rabbit D.J. .... Jose Gamo  
Cupcake, a human who is Pineapple's mom..... Precious Sipin  
The Map ..... Xavier Espinal

*Son and Mother* lyrics by José Luján

## BACK TO THE PAST

Written by Chloe Torres, age 11

Dramaturge/Director: Dara Silverman. Costumes by Madelene DeLeon.

Jenna Vive ..... Arielle Goldman  
Milo ..... KeiLyn Durrel Jones  
Milo's Mom ..... Betsy Hogg

*How It Feels to be Alone* lyrics by Chloe Torres.

## JOURNEY OF THE DEATH POTION

Written by Samaria Alkandi, age 9

Dramaturge/Director: Monica LaBadia. Costumes by Madelene DeLeon.

Queen Flowerina the Flower ..... Tina Chilip  
King Kubabi the Cheetah..... Neil D'Astolfo  
Amazon Guy..... Alex Breton  
Family voices ..... The Crew

*Time for Revenge* lyrics by Samaria Alkandi





The 52nd Street Project gratefully acknowledges the support of the following foundations & corporations: Bank of America, Bella Vida Productions Inc., Bulls Head Foundation, Inc., Cantor Fitzgerald, Carnegie Corporation of New York, Carol M. & Stephen E. Canter Family Foundation, Circle of Confusion, Community Foundation of Sarasota County, Consolidated Edison, Filomen M. D'Agostino Foundation Corp., Frederick Loewe Foundation, Greenwich Country Day School, Howard Ashman Trust for Theater Arts, Lazard, Ltd, Rose M. Badgley Residuary Charitable Trust, Seller-Lehrer Family Foundation, Signature Bank, Susquehanna Foundation, Corp., The Educational Foundation Of America, The Henlopen Foundation, The Horace W. Goldsmith Foundation, The Scott Foundation, and the Tiger Baron Foundation. We also acknowledge the following individual donors (over \$250) to The 52nd Street Project:

Adriana Trigiani & Tim Stephenson	Gavin Berger & Craig Berggren	Mary Kong & Sol Reischer
Alan Krevis & Gary Horowitz	Glen Gillen	Mary Lin & James Yoshimura
Alexandra Garrison	James & Hannelore McDaniel	Mary Lou Teel
Alexandra Vassilaros	Jane & Greg MacPherson	Mary Pat Walsh
Amanda Green & Jeffrey Kaplan	Janey Feingold	Matthew Jones
Amy Herzig	Jeannie & Jim Gaffigan	Megan Cramer
Andrea Johnson	Jenni Swan	Megan Thompson
Anna Li & Frank Sposato	Jenny & Jon Steingart	Meg Simon
Anne M. Bacon	Jenny Gersten	Melissa & Lee Briggs
Annie & David Hausmann	Jeremy Smith	Melissa Lowry
Arin Chilcote	Jerry Levine & Nina Tassler	Merritt Tilney & Douglas M. Kaden
Barnaby Harris & Suzie Kondi	Jessica Bauman & Ben Posel	Mickey Lemle
Becky & Dylan Baker	Jessica Hecht & Adam Bernstein	Michael & Megan Crane
Beth & Bob Ollwerther	Joe White & Iris Brown	Michael Herzig
Beth & Ray Abbott	John Lee	Neena Beber
Beth Barry and Daniel Sussman	John Rossi	Noël & Joe Mihalow
Beth Crookham	John Turturro & Kathy Borowitz	Omar Metwally
Bettina S. Buschel	Jonathan & Clara Cohen	Patrice & Louis Friedman
Bill Camp & Elizabeth Marvel	Jonathan Marc Sherman	Peter & Marsue MacNicol
Billy Crudup	& Alexandra Shiva	Rachel & Larry Norton
Billy Dreskin	Jon Ecker	Randi Puccio
Betsy and Bob Goldberg	Joseph Nigro	Rebecca & Richard Dresser
Brenda Wehle & John C. Lynch	Josie Merck	Richard Langan
Buzz Bovshow	Judy & Sam Berger	Richard Sweren
Carl Capotorto	Judy Dennis	Robert Shore
Carol Bell	Judy Kuhn & David Schwab	Robert Shwartz
Carole Yass	Judy Taub Gold	Ron & Judy Tierney
Carolyn DeSena	Kali Crandall	Rose Gasner & Larry Chertoff
Cathy Dantchik	Karen Hauser & Warren Leight	Roseline Michael & Dennis Neveling
Cecilia Arana & Kevin Grant	Karen Powell	Ruth Cohen & Bob Usdin
Chris Ceraso	Karin & Tom Schall	Ruth Nelson
Christine Ziegler-Sullivan	Kate Burton & Michael Ritchie	Sarah & Paul Ardire
Christopher Randolph	Katie & Douglas Jordan	Sarah Horowitz
Chrysti & David Eigenberg	Katy Homans & Patterson Sims	& David Venarde
Courtney & Lowell Pettit	Kerry Pflugst & Russell Dodson	Shari Goodstein
Cynthia Kaplan & David Froelich	Laura & David Ross	Sherry Cohen
Cynthia Vance-Abrams & Robert Abrams	Laura Ewing	Shirley Rumierk & Armando Riesco
Danielle Mindess & Robert Cohen	Laura Jones	Stephen Bernstein
David Aldridge	Laura Sametz & Anton Fig	Stephen Graham
David Williams	Laura Valeroso & David Seidman	Sunil Arora
Debbie & Lawrence Catena	Lauren Weiner	Susan Isaacson
Denise Burse & Peter Jay Fernandez	Laurie Becker	Susannah Gray & John Lyons
Douglas Kabel	Lewis Black	Susan Wallace
Drew McCoy & Amy Aquino	Lili Taylor	Suzen Murakoshi
Drew Milstein	Lindsay Fram & Mason Pettit	Sylvia Shepard & Willy Holtzman
Edie Falco	Lisa Benavides & Tim Blake Nelson	Tara Elwin & Andre Meade
Edith Thurber & Kevin O'Rourke	Lisa Cohen & David Hillman	Terry Belanger & Ken Giese
Elaine Musselman	Liz Bell & J. Andrew Stein	Tina Galley
Elizabeth & Eric Berman	Lois Smith	Todd Herman
Ellen Chopay	Lori O'Connor	Tony Goldwyn & Jane Musky
Ellen Kroll	Lori Tan Chinn	Valerie Kay & Bruce Graham
Emily Grishman & Susan Sampliner	Lynda Hughes	Vicki & Craig Holleman
F. Richard Pappas	Lyn Hejinian & Larry Ochs	Vicki & Mark Whatley
Frances & Fred Langbecker	Lynne Rosenberg	Vicki de Klerk-Rubin
Frances McDormand & Joel Coen	Margaret & Peter O'Brien	Wendy Ettinger
Frances Strauss	Marion Koltun	Wendy vanden Heuvel & Brad Coley
Francine Borgenicht	Marjorie & Michael Loeb	Will Keigler
Frank Wood & Kay Gayner	Mary & Lionel Allan	Yared Yawand Wossen